

NASA Technical Memorandum 106768

1N-23  
35006  
P-17  
356888

# Tribology and Microstructure of PS212 With a Cr<sub>2</sub>O<sub>3</sub> Seal Coat

Harold E. Sliney  
*Lewis Research Center  
Cleveland, Ohio*

Patricia A. Benoy  
*St. Louis University  
St. Louis, Missouri*

Andras Korenyi-Both  
*Calspan Corporation  
Fairview Park, Ohio*

and

Christopher DellaCorte  
*Lewis Research Center  
Cleveland, Ohio*

December 1994



National Aeronautics and  
Space Administration

(NASA-TM-106768) TRIBOLOGY AND  
MICROSTRUCTURE OF PS212 WITH A  
Cr2O3 SEAL COAT (NASA. Lewis  
Research Center) 17 p

N95-18448

Unclas

G3/23 0035006



# TRIBOLOGY AND MICROSTRUCTURE OF PS212 WITH A CR<sub>2</sub>O<sub>3</sub> SEAL COAT

Harold E. Sliney  
National Aeronautics and Space Administration  
Lewis Research Center  
Cleveland, Ohio 44135

Patricia A. Benoy  
Parks College  
St. Louis University

Andras Korenyi-Both  
Calspan Corporation  
Fairview Park, Ohio

and

Christopher DellaCorte  
National Aeronautics and Space Administration  
Lewis Research Center  
Cleveland, Ohio 44135

## SUMMARY

PS212 is a plasma sprayed metal bonded chrome carbide coating with solid lubricant additives which has lubricating properties at temperatures up to about 900 °C. The coating is diamond ground to achieve an acceptable tribological surface. But, as with many plasma spray coatings, PS212 is not fully-dense. In this study, a chromium oxide base seal coating is used in an attempt to seal any porosity that is open to the surface of the PS 212 coating, and to study the effect of the sealant on the tribological properties of PS212. The results indicate that the seal coating reduces friction and wear when it is applied and then diamond ground leaving a thin layer of seal coating which fills in the surface pits of the PS212 coating.

## INTRODUCTION

PS212 is a self-lubricating composite coating that is applied to metal surfaces by a plasma spray process. It has been shown to have lubricating properties up to about 900 °C (refs. 1 to 3). The objective of this work was to reduce surface porosity (pits) on PS212 by means of a seal coating with a high chromium oxide content. The expectation was to reduce coating wear rates and possibly reduce the friction coefficient of the coating. The seal coating was applied by a patented process at Adiabatics Inc. located in Columbus, Indiana (ref. 4).

Friction and wear tests were conducted in a high temperature pin on disk tribometer at constant temperatures of 25 and 800 °C in an air atmosphere. Baseline tests were performed on (1) diamond ground PS212 with no seal coat (2) PS212 with a top coat of sealant in as-applied condition and (3) PS212 with the top coat diamond ground to the interface of PS212 and the sealant leaving only a thin film of sealant concentrated in the surface pits and grinding marks.

Energy dispersive spectroscopy (EDS) and scanning electron microscopy (SEM) were used to characterize the topography and chemistry of the coated surfaces. Surface topography and wear track contours were characterized with a stylus surface profilometer.



## COATING MATERIALS

The baseline coating on the wear disks is the plasma-sprayed coating: PS212. The development and tribological properties of this coating are described in references 1 to 3. The nominal chemical composition of PS212 is given in table I. The coatings are plasma sprayed onto Inconel X-750 or Rene 41. Both of these metals are nickel-base turbine alloys that are precipitation-hardened to Rockwell C-40. The seal coating has a high chromium oxide content and is a commercial material applied by Adiabatics Inc.

Eight wear test disks were plasma spray coated with PS212, and subsequently, four of these were seal coated with the chromium oxide based coating. The PS212 coatings were diamond ground to a surface finish of 1.4  $\mu\text{m}$  CLA. The seal coatings in the as-applied condition had a surface finish of 0.14  $\mu\text{m}$  CLA, and were glassy in appearance. The thickness of the seal coatings was in excess of 25  $\mu\text{m}$ , and possibly as thick as 100  $\mu\text{m}$ . The tribological properties of these specimens are essentially those of the seal coat. The original objective of this study was to determine the tribological properties of PS212 with the surface porosity filled with the sealant. Therefore, some of the seal coatings were diamond ground to the interface of the sealant and the surface of PS212. This left a residual film of seal coat material mostly concentrated in the microdepressions between the grinding ridges and asperities of the plasma sprayed coating. The resulting surface finish was 1.0  $\mu\text{m}$  CLA. This finish was generated by the final grinding procedure and is not indicative of the degree to which the surface microdepressions of PS212 was filled by the sealant. This was determined by microscopic examinations of the coated surfaces.

A polished cross section was prepared from a block specimen of Inconel X-750 coated with PS101 and a top coating of sealant. PS101 is a self-lubricating high-temperature coating that was developed before PS212 in the ongoing solid lubricants research program at NASA LeRC, (ref. 5). The chemical composition is given in table I. Seal coated PS101 was used because of the very limited availability of seal coated PS212 at the time of this program, with the assumption that the wettability of PS101 and PS212 by the sealant during its application should be similar. This assumption is based upon the similar chemical composition of the two coatings: Comparison of their compositions, which are given in table I, shows that they both contain significant amounts of nickel, chromium, calcium fluoride, and silver.

## TRIBOTEST PROCEDURE

Pin on disk testing was done on the tribometer illustrated in figure 1. The pins were made of the nickel base turbine alloy Rene 41 hardened to Rockwell C-40 machined to a 4.76 mm hemispherical radius. Friction and wear testing was done on a total of eight wear disks. A series of three 30 min tests was run on each disk with pin and disk wear measurements taken after each 30 min test. Tests were performed at room temperature and at 800 °C under the following conditions: 9.8N load, 2.8 m/s sliding velocity at 1000 rpm, air atmosphere with 50 percent relative humidity.

Friction was recorded continuously during the tribotests. Pin volumetric wear was computed from the diameters of the circular wear scars worn on the hemispherical tips of the pins. Disk wear was computed by measuring the cross sectional areas of the circular wear tracks generated by the wear process. The cross sectional areas at several locations were averaged, then multiplied by the track circumference to obtain the wear volume.

## COATING CHARACTERIZATION

### Surface Analyses

Scanning electron microscopy (SEM) and energy dispersive spectroscopy (EDS) were used to examine the following:



1. The diamond ground surface of PS212.
2. The surface of the as-received seal coating.
3. The surface of seal coated PS212 after grinding to the interface of the two coatings.

PS212 coatings.—Photomicrographs and EDS spectra of PS212 were obtained as a baseline for comparison with the seal coat, and with the ground seal coat (item 3 above). A low magnification SEM and the corresponding area averaged EDS spectra are shown in figure 2. The typical surface appearance of PS212 consists of a darker matrix of bonded chromium carbide with lighter areas of silver and fluoride eutectic dispersed throughout.

The EDS spectrum contains the peaks characteristic of PS212: a strong chromium peak, considerable silver along with calcium and barium and the principal elements of the metallic nickel-based binder. Significant carbon due to the carbide and a small oxygen peak are also present.

Seal coating.—A low magnification photomicrograph and EDS spectra of the as-received, unground surface of the seal coating are shown in figure 3(a). The coating appears to be a glassy matrix containing a finely dispersed phase. The EDS spectrum has a strong chromium peak along with significant silicon and oxygen and a weak carbon peak. Weak peaks for aluminum, phosphorus, and silver are also present. A higher magnification SEM micrograph is presented in figure 3(b) along with the EDS spectrum of the dispersed particle labeled "d". The spectrum contains strong chromium, significant oxygen, and very weak silicon peaks. This contrasts with the area analysis of figure 3(b) which shows a high concentration of silicon in the coating matrix. This comparison suggests that the seal coating consists of chromium oxide particles dispersed throughout a silicon-rich, possibly glassy matrix.

Seal coating/PS212 Interface Region.—Photomicrographs and the EDS spectrum for this surface are presented in Figure 4. The oxygen peak is stronger and the silver peak is weaker than in PS212 indicating residual sealant material is still present; however, calcium, barium, and silver peaks characteristic of PS212 are also present. These EDS data are inconclusive. The visual appearance of the ground coating is at this time the only firm evidence for the presence of residual seal material.

### Cross Section Analyses

Figure 5(a) is an optical photomicrograph of a cross section through the duplex coating system consisting of a 380 micrometer thick layer of PS101 with a 100  $\mu\text{m}$  top coat of sealant. There is a very distinct interface of the two coatings.

Figures 5(b) and (c), and d are higher magnification images of the same area obtained by three different modes on a scanning electron microscope; secondary electron emission, back scatter compositional, and topographical. Figure 6 contains x-ray dot maps of the same area. All of these modes show that the seal coating very closely follows all of the interfacial topographical features of the PS101 coating indicating very good wettability of PS101 by the seal coat. This suggests that the sealant should penetrate any porosity that is continuous with the surface of the plasma-sprayed coating. However, there is no evidence that this occurred. The porosity in the PS101 coating is not continuous, but exist as isolated pockets. The pores appear as black areas as imaged by the SEM and back scatter modes. No continuity is seen between these micro voids. The isolated location of these voids is further confirmed by the topographic microstructure shown in figure 5(d).

The x-ray dot maps of figures 6(a) to (d) also show no evidence of interdiffusion beyond the interface. The seal coat is seen to be rich in chromium and silicon. There is a weak pattern of dots in PS101 on the silicon dot map. The source of these may be the 15 percent glass content in PS101 along with some background noise. However, there is no silicon concentration gradient at the interface to indicate penetration from the sealant into the PS101 layer. Chromium (a component of the nickel-chromium binder) is continuous in the seal coat, and stratified in PS101. Calcium is prominently distributed throughout PS101 and is not present in the seal coat. The fluorine dot map superimposes the calcium dot map, an indication that the calcium is present as calcium fluoride.



## TRIBOTESTS RESULTS

Friction and wear data are summarized in table II and presented graphically in figures 7 and 8(a) to (d).

### Friction

Friction coefficients during three 30 min consecutive tribotests are shown in figure 7. Within the scatter bands, friction coefficients did not vary significantly over 90 min of sliding with the exception of the 800 °C test of PS212 with a top coat of sealant that had been diamond ground to the seal coat/PS212 interface. In this case, friction coefficients decreased from about 0.3 early in the test to about 0.2 during the final 30 min.

Friction was slightly lower on both the ground and unground seal coated disks than on uncoated PS212 at room temperature: 0.41 versus 0.46. This may be due to data scatter since only one specimen of each type was tested. However, at 800 °C, friction was significantly lower on PS212 with a diamond ground seal coat than it was for PS212 without the sealant treatment: 0.23 versus 0.37.

### Wear

Pin and disk wear are plotted as functions of test duration in figures 8(a) and (b). These data were used to compute pin and disk wear factors. Wear factors in figures 8(c) and (d) are incremental; each data bar is the wear factor for the 30 min test duration indicated.

Wear factors,  $k$ , are expressed as volumetric wear per unit normal load and per unit sliding distance. The units of  $k$  used in the paper are cubic millimeters of wear per Newton load and per meter of sliding:

$$k = \text{mm}^3/\text{Nm}$$

Wear factors for the pins,  $k_p$ , are given in figure 8(c). At room temperature the average  $k_p$  is  $0.9 \times 10^{-6} \text{mm}^3/\text{N-m}$  against PS212,  $2.2 \times 10^{-6} \text{mm}^3/\text{N-m}$  for the as-received, unground seal coat, and  $2.0 \times 10^{-6} \text{mm}^3/\text{N-m}$  for ground seal coat on PS212. At 800 °C, the pin wear factor, was an order of magnitude lower for sliding against the PS212 disk with the ground seal coat than the PS212 alone:  $1.1 \times 10^{-7}$  versus  $1.1 \times 10^{-6}$ . The as-applied (unground) seal coating was not tribotested at 800 °C because it spalled from PS212 upon cooling from high temperature.

Disk wear factors,  $k_d$ , are given in figure 8(d). At room temperature, the wear factor for the as-applied seal coating was at least five times that of PS212:  $2.4 \times 10^{-4}$  versus  $4.9 \times 10^{-5}$ . The wear of the seal coating was only measured after the first two 30 min tests because the wear depth was beyond the 100  $\mu\text{m}$  range of the profilometer after the third test. The wear factor of PS212 with a ground sealant top coat was  $8.6 \times 10^{-5}$ . At 800 °C,  $k_d$  for PS212 with a ground seal coat was about 60 percent that of PS212 alone;  $3.8 \times 10^{-5}$  versus  $6.8 \times 10^{-5} \text{mm}^3/\text{N-m}$ .

## DISCUSSION

Microstructural studies show that the chromium oxide-based seal coating forms a continuous, adherent coating on PS212 plasma sprayed lubricant coatings. The porosity in PS212 is not continuous with the surface; therefore, no sealant was found in the isolated pores within the coating. However, the sealant fills in the micro-depressions in the surface of PS212. Subsequent careful grinding to the interface produces a surface on the plasma sprayed coating with the microdepressions filled with the sealant. This may provide the ability to polish the surface to a much finer surface finish than is achievable without the sealant treatment.



The as-applied, 10  $\mu\text{m}$  thick (unground) seal coating had poor friction and wear properties in our tests. However, when the sealant is ground back to the interface of the two coatings, the friction and wear at 800 °C are substantially reduced compared to PS212 alone.

### CONCLUSIONS

1. Sealing the surface of PS212 with a chromium oxide-based material enhances the friction and wear reducing properties of PS212 at high temperature.
2. Excess sealant must be removed (diamond ground in this program) from the surface of the plasma sprayed coating in order to achieve the beneficial effect of the sealant treatment.
3. These conclusions must be considered very preliminary because of the small number of tests performed in this exploratory study. However, these results, which show a reduction in both friction and wear at elevated temperature, indicate that this coating system should be investigated further.

### REFERENCES

1. Sliney, H.E., "The Use of Silver in Self-Lubricating Coatings for Extreme Temperatures," ASLE Transactions, 29, 3, 1986, pp. 370-379.
2. DellaCorte, C. and Sliney, H.E., "Composition Optimization of Self-Lubricating Chromium Carbide-Based Composite Coatings for Use to 760 °C," ASLE Transactions, 30, 1, 1987, pp. 77-83.
3. Sliney, H.E., "Coatings for High-Temperature Bearings and Seals," Technical Memorandum/DOE/NASA 50112-71, 1987.
4. U.S. Patent No. 5,360,634 "Composition and Methods for Densifying Refractory Oxide Coatings," Nov. 1, 1994, Loyd Kamo, Adiabatics Inc.
5. Sliney, H.E., "Wide Temperature Spectrum Self-Lubricating Coatings Prepared by Plasma Spraying," Thin Solid Films, 64, 1979, pp. 211-217.

TABLE I.—COMPOSITIONS OF PS212 AND PS101

PS212			
Component	Weight, percent	Density, gms/cm <sup>3</sup>	Volume, percent
Cr <sub>3</sub> C <sub>2</sub>	40.6	6.68	31.2
Ni alloy binder	29.4	8.9	34.8
CaF <sub>2</sub>	5.7	3.18	11.8
BaF <sub>2</sub>	9.3	4.80	12.7
Ag	15.0	10.50	9.5
PS101			
80-20 NiCr	30.0	8.32	18.2
CaF <sub>2</sub>	25.0	3.18	39.7
Ag	30.0	10.50	14.4
Glass	15.0	2.73	27.7



TABLE II.—SUMMARY OF TRIBOLOGICAL DATA FROM PIN ON DISK TESTS OF PS212 WITH AND WITHOUT A SEALANT TOP COAT. TEST CONDITIONS: 4.76 mm PIN RADIUS, 2.8 m/s SLIDING VELOCITY AT 1000 rpm 30 min DURATION, 9.8 N LOAD.

Test ID	Sealant	Temperature, °C	Friction, $\mu$	Pin scar radius, cm	Pin wear, $\text{cm}^3$ (a)	Pin K factor, $\text{mm}^3/\text{N}\cdot\text{m}$ (b)	Disk wear, $\text{cm}^3$ (a)	Disk K factor, $\text{mm}^3/\text{Nm}$ (b)
1	None	25	0.44±0.07	0.087	9.56×10 <sup>-5</sup>	1.95×10 <sup>-6</sup>	2.39×10 <sup>-3</sup>	4.88×10 <sup>-5</sup>
2	None		0.46±0.01	0.088	1.00×10 <sup>-4</sup>	9.19×10 <sup>-8</sup>	4.82×10 <sup>-3</sup>	4.96×10 <sup>-5</sup>
3	None		0.47±0.01	0.095	1.36×10 <sup>-4</sup>	7.38×10 <sup>-7</sup>	7.19×10 <sup>-3</sup>	4.85×10 <sup>-5</sup>
4	Cr <sub>2</sub> O <sub>3</sub> /AS RCVD		0.39±0.01	0.103	1.89×10 <sup>-4</sup>	3.85×10 <sup>-6</sup>	1.47×10 <sup>-2</sup>	3.00×10 <sup>-4</sup>
5	Cr <sub>2</sub> O <sub>3</sub> /AS RCVD		0.42±0.01	0.116	3.05×10 <sup>-4</sup>	2.37×10 <sup>-6</sup>	2.31×10 <sup>-2</sup>	1.72×10 <sup>-4</sup>
6	Cr <sub>2</sub> O <sub>3</sub> /AS RCVD		0.42±0.01	0.118	3.27×10 <sup>-4</sup>	4.45×10 <sup>-7</sup>	(c)	
7	Cr <sub>2</sub> O <sub>3</sub> /ground		0.41±0.01	0.103	1.89×10 <sup>-4</sup>	3.85×10 <sup>-6</sup>	6.14×10 <sup>-3</sup>	1.25×10 <sup>-4</sup>
8	Cr <sub>2</sub> O <sub>3</sub> /ground		0.41±0.05	0.109	2.37×10 <sup>-4</sup>	9.89×10 <sup>-7</sup>	9.48×10 <sup>-3</sup>	6.82×10 <sup>-5</sup>
9	Cr <sub>2</sub> O <sub>3</sub> /ground		0.41±0.04	0.115	2.94×10 <sup>-4</sup>	1.17×10 <sup>-6</sup>	1.27×10 <sup>-2</sup>	6.52×10 <sup>-5</sup>
10	None	800	0.33±0.03	0.063	2.61×10 <sup>-5</sup>	5.34×10 <sup>-7</sup>	3.10×10 <sup>-3</sup>	6.33×10 <sup>-5</sup>
11	None		0.37±0.03	0.068	3.55×10 <sup>-5</sup>	1.91×10 <sup>-7</sup>	7.73×10 <sup>-3</sup>	9.46×10 <sup>-5</sup>
12	None		0.40±0.03	0.099	1.61×10 <sup>-4</sup>	2.56×10 <sup>-6</sup>	9.94×10 <sup>-3</sup>	4.50×10 <sup>-5</sup>
13	Cr <sub>2</sub> O <sub>3</sub> /ground		0.27±0.20	0.054	1.41×10 <sup>-5</sup>	2.88×10 <sup>-7</sup>	2.98×10 <sup>-3</sup>	6.08×10 <sup>-5</sup>
14	Cr <sub>2</sub> O <sub>3</sub> /ground		0.22±0.01	0.055	1.52×10 <sup>-5</sup>	1.83×10 <sup>-8</sup>	4.58×10 <sup>-3</sup>	2.72×10 <sup>-5</sup>
15	Cr <sub>2</sub> O <sub>3</sub> /ground		0.21±0.01	0.056	1.63×10 <sup>-5</sup>	2.9×10 <sup>-8</sup>	5.59×10 <sup>-3</sup>	2.58×10 <sup>-5</sup>

<sup>a</sup>Wear volumes are cumulative over three 30 min tests.

<sup>b</sup>Wear factors are incremental for each of three 30 min tests.

<sup>c</sup>Exceeded the range of the profilometer used to measure wear.



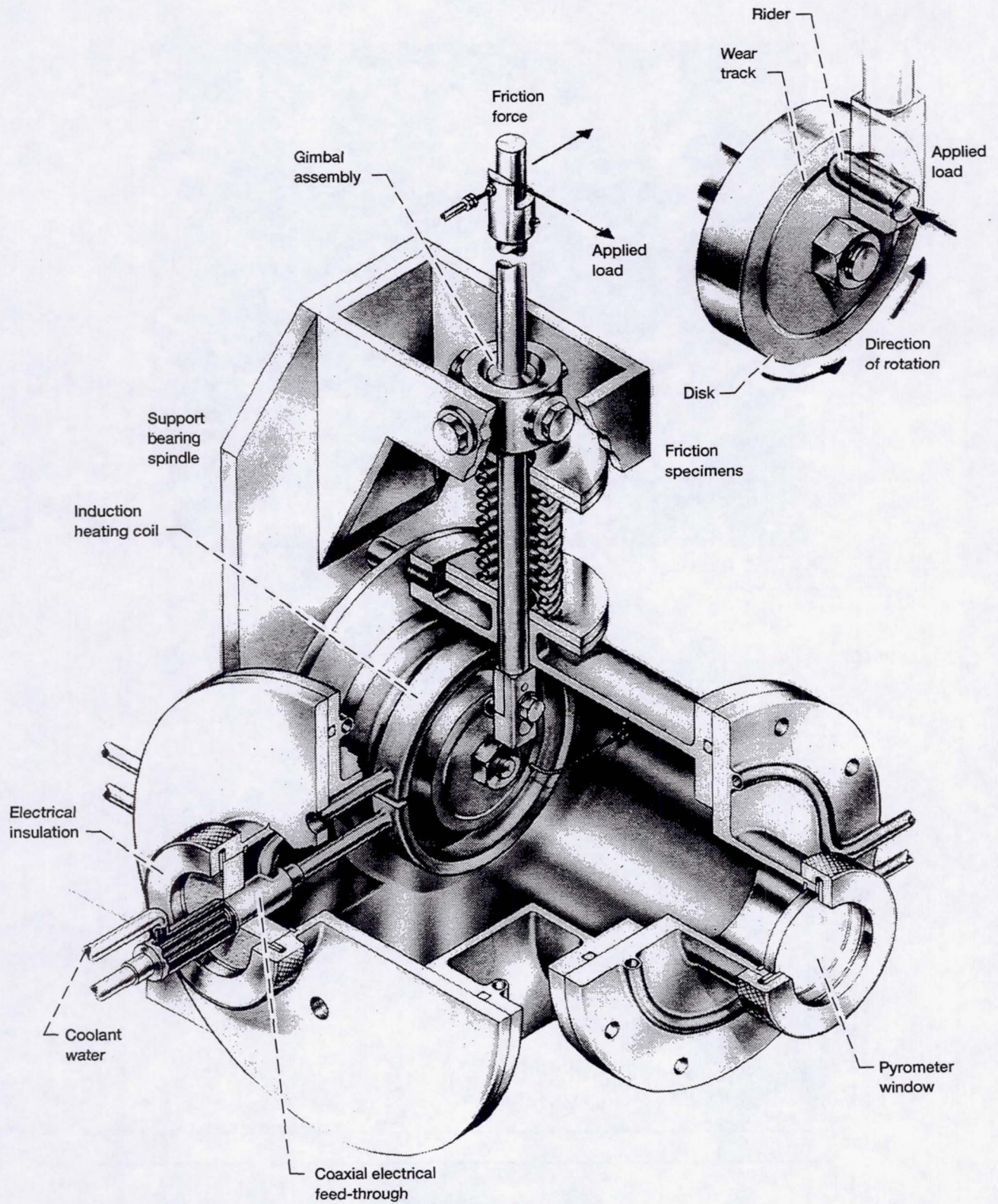

Figure 1.—High-temperature friction apparatus.



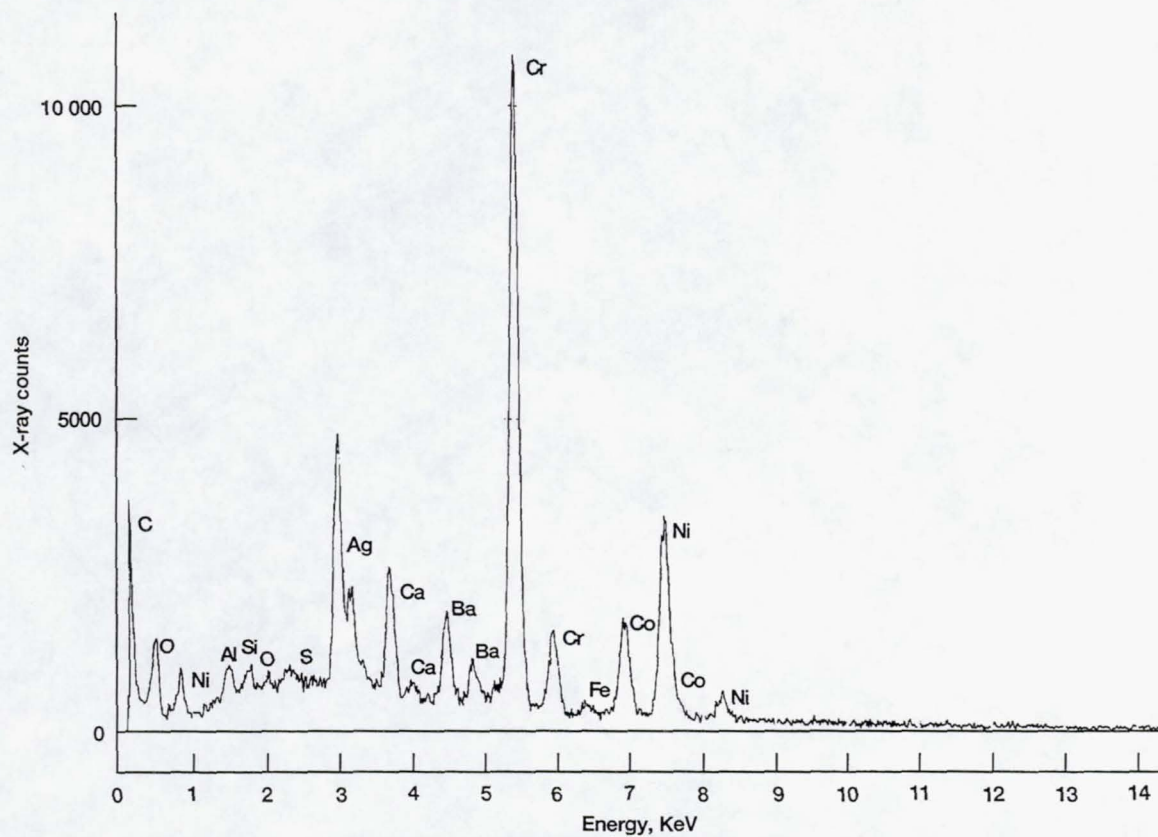
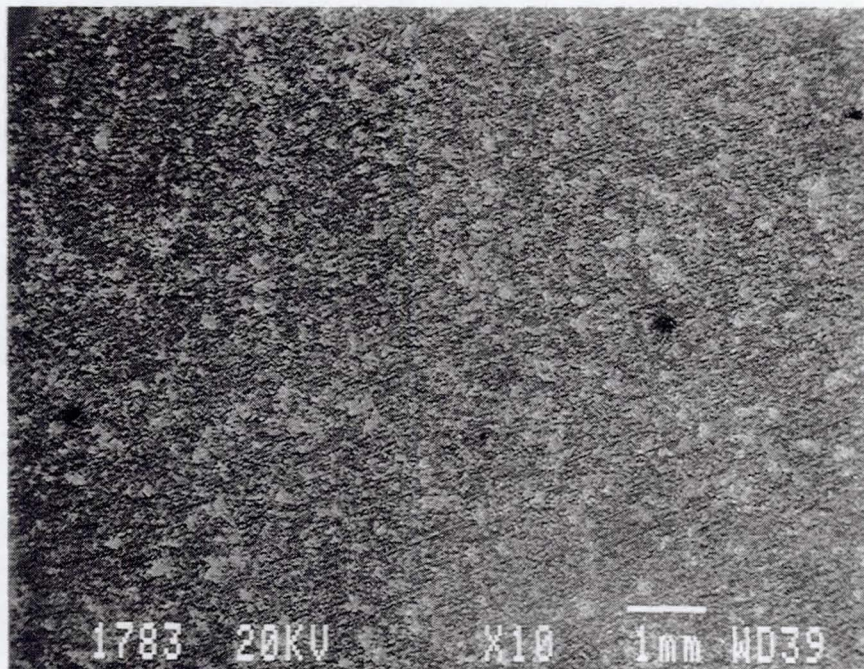

Figure 2.—SEM micrograph and EDS spectrum of baseline PS212 coating.



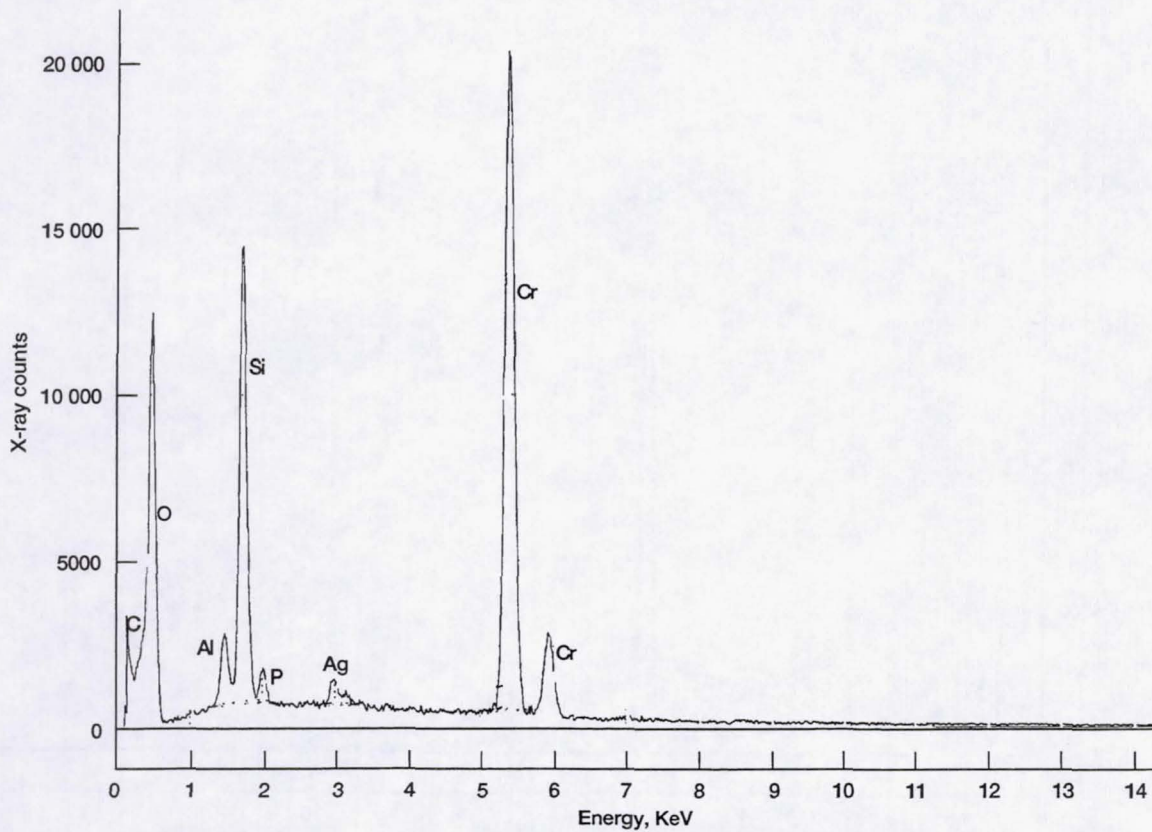
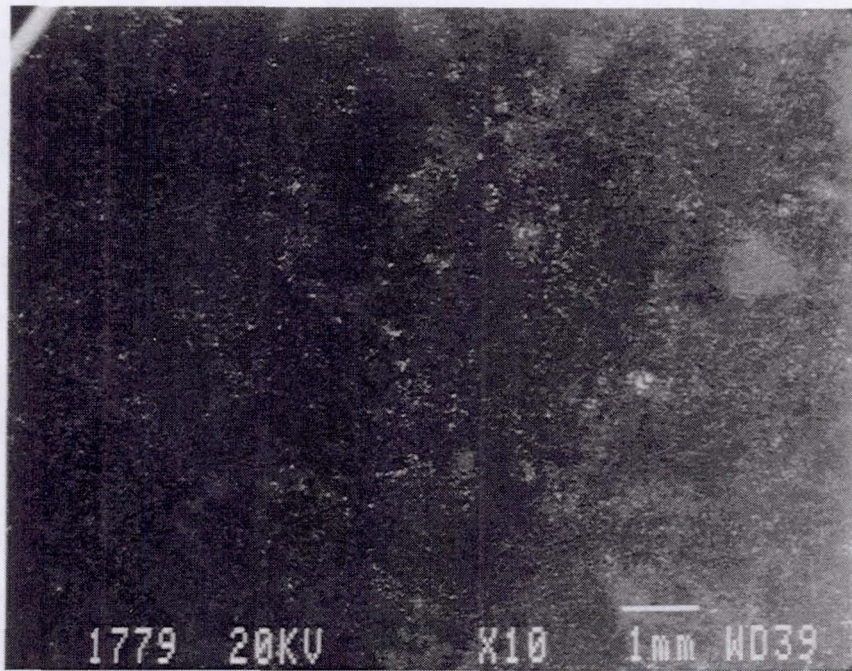

Figure 3.— (a) Low magnification SEM micrograph and EDS spectra of as received unground seal coated PS212 surface. (b) Higher magnification SEM micrograph of seal coating and EDS spectrum of displaced particle.



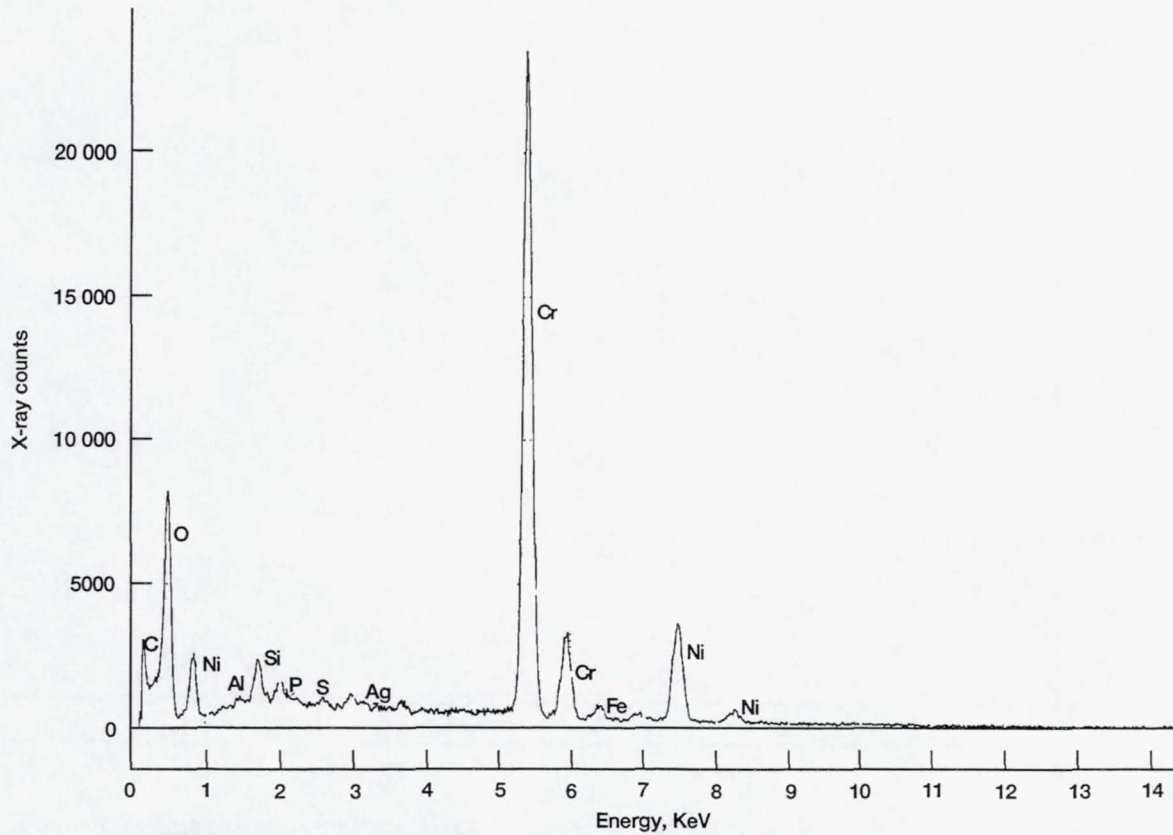
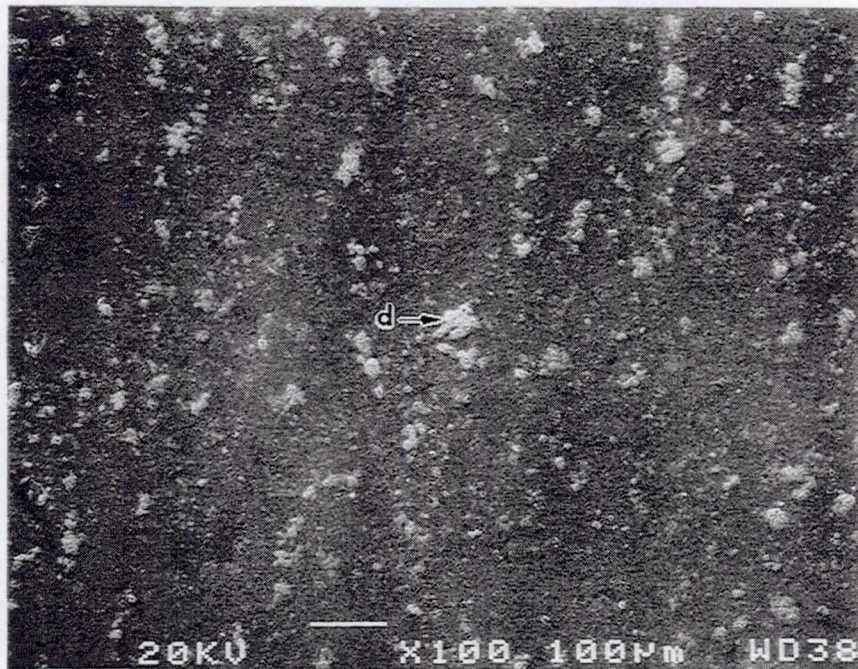

Figure 3.—Concluded. (b) Higher magnification SEM micrograph of seal coating and EDS spectrum of displaced particle.



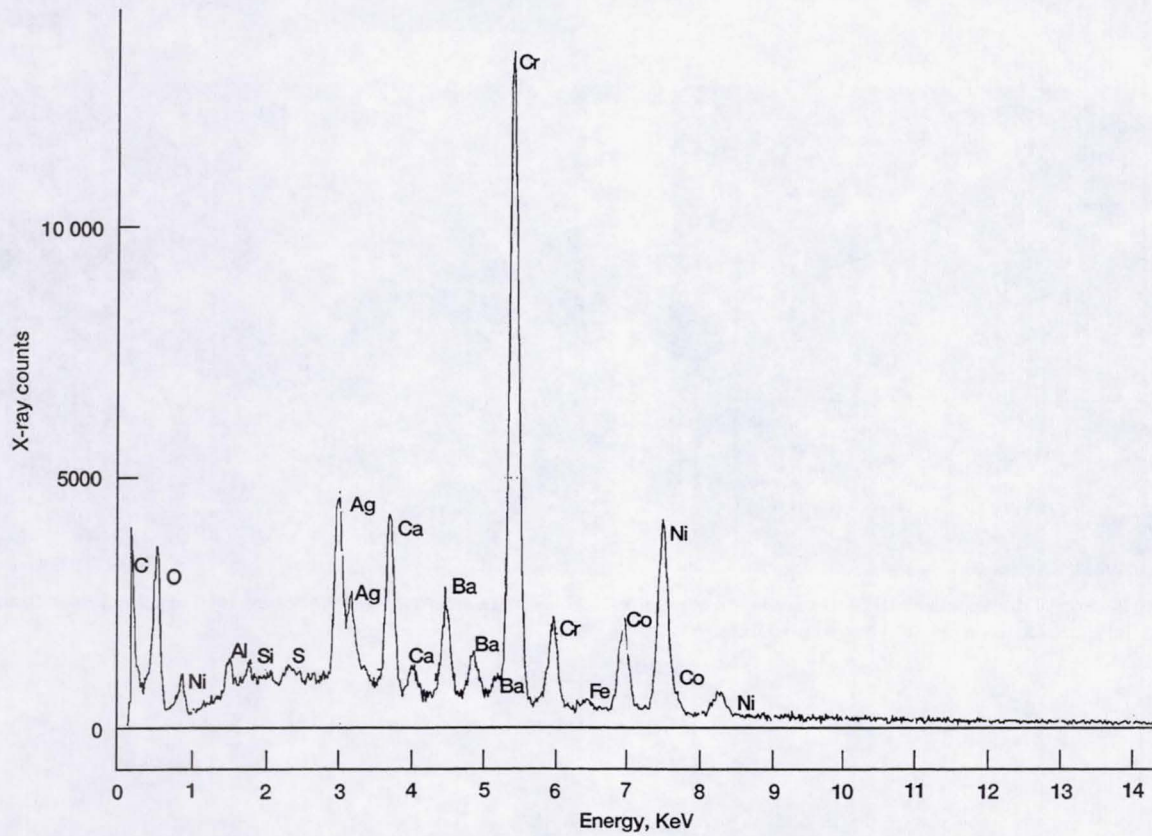
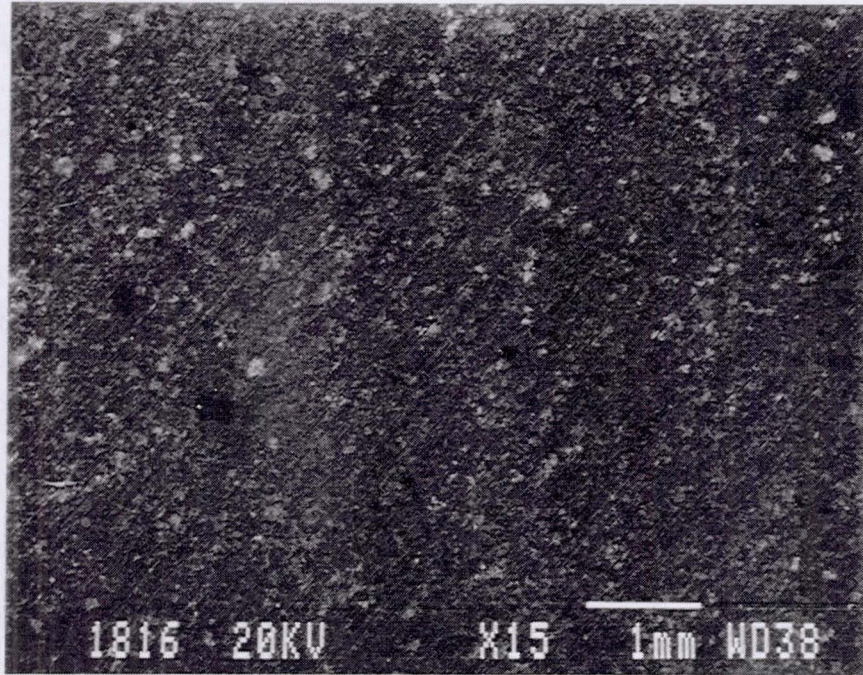

Figure 4.—SEM photomicrograph and EDS spectrum of Cr<sub>2</sub>O<sub>3</sub> seal coating/PS212 interfacial region.



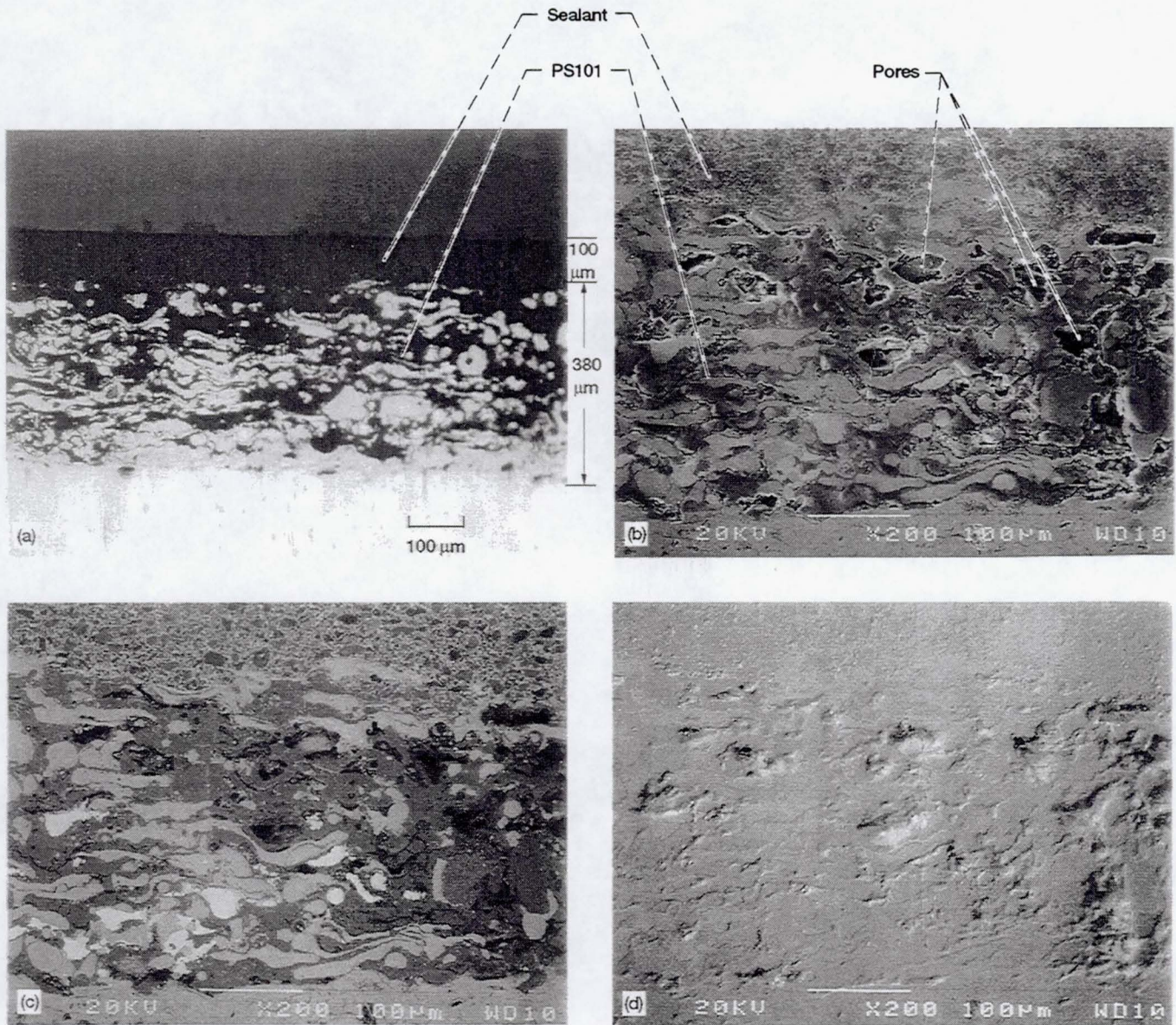

Figure 5.—Cross section of duplex sealant/PS101 coating on Inconel X-750 by various microscopy techniques. (a) Optical. (b) Secondary electron SEM. (c) Back scatter SEM. (d) Topographic SEM.



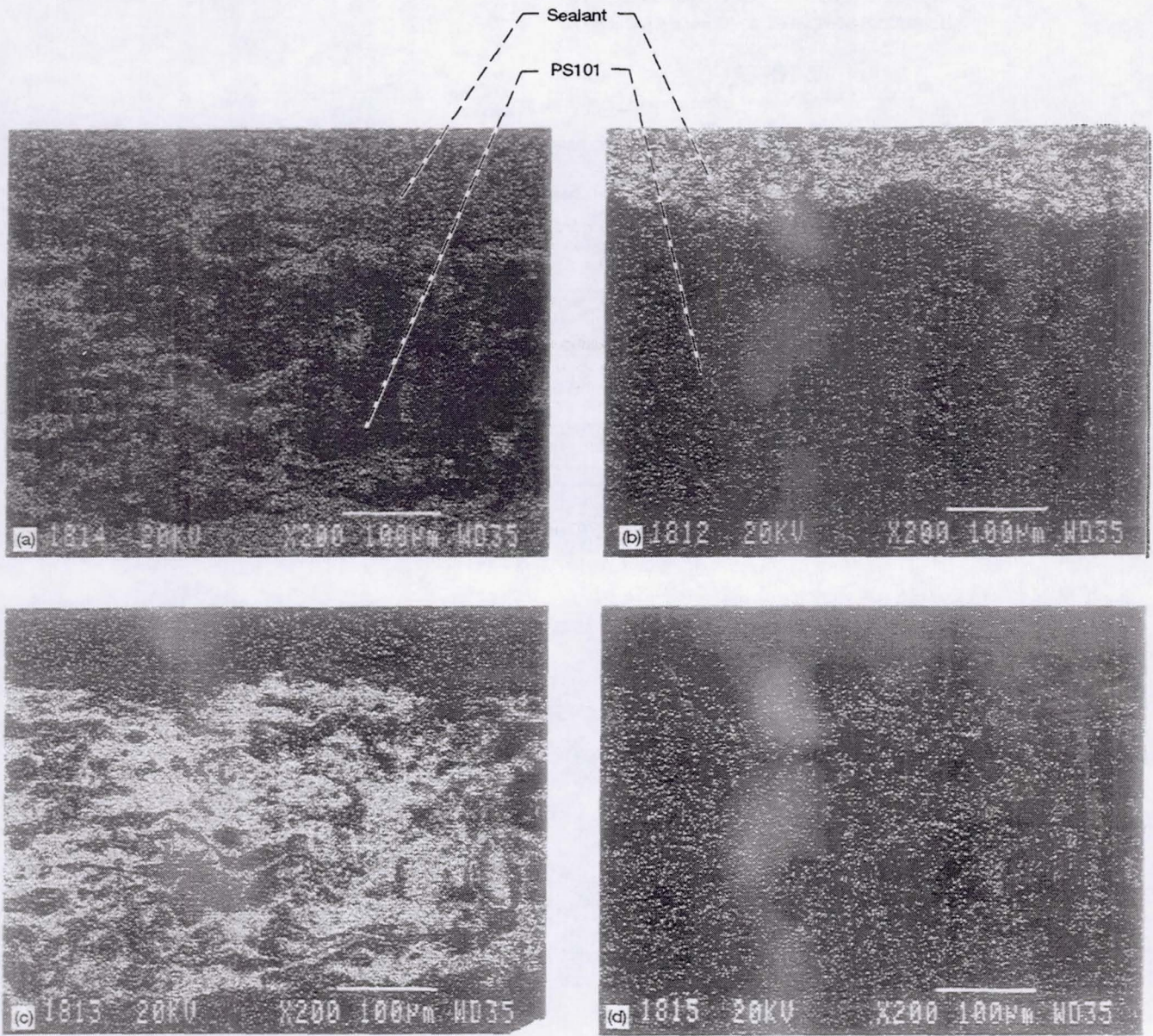

Figure 6.—Cross-section x-ray dot maps of duplex sealant/PS212 coatings. (a) Cr. (b) Si. (c) Ca. (d) F.



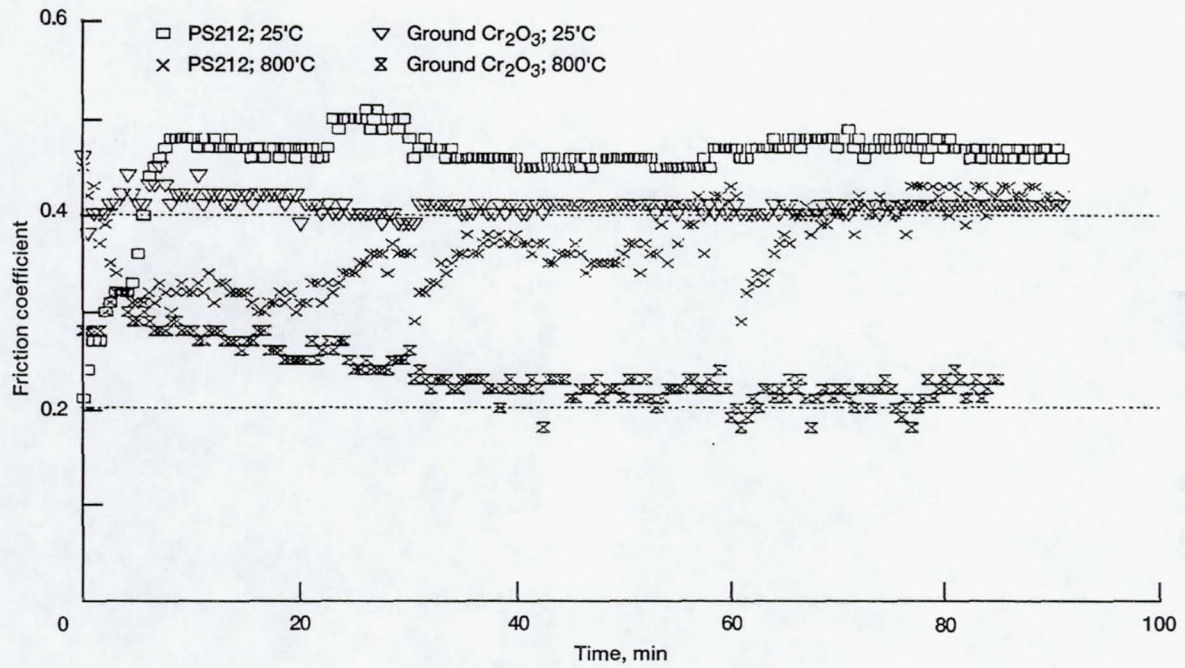

Figure 7.—Friction-time trends.

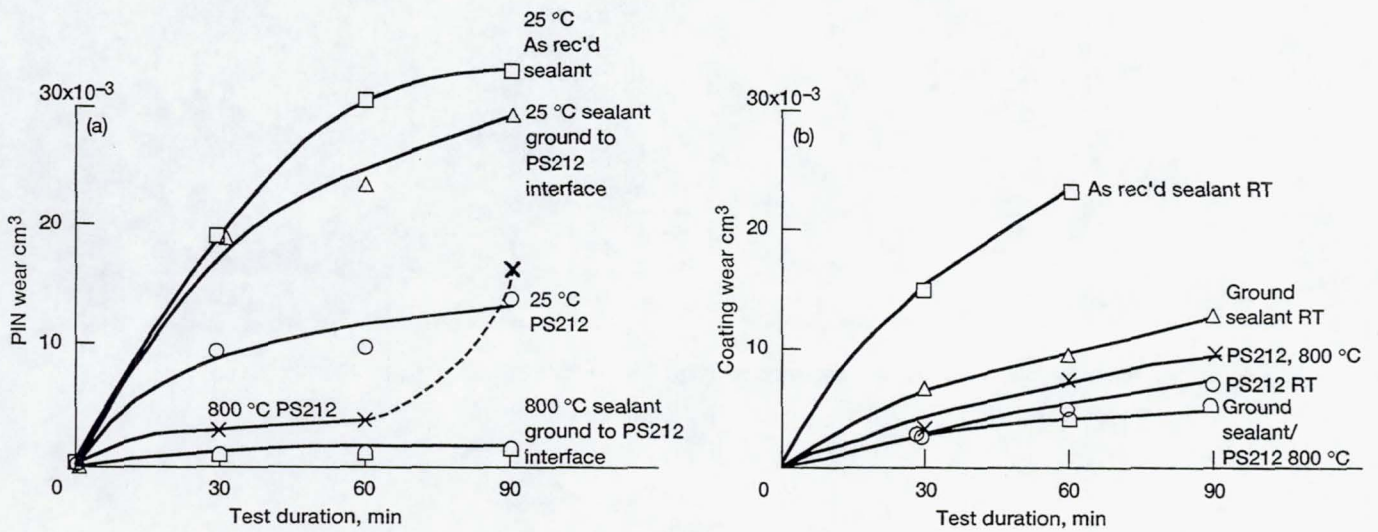

Figure 8.—(a) Comparisons of PIN wear. (b) Comparisons of disk wear.



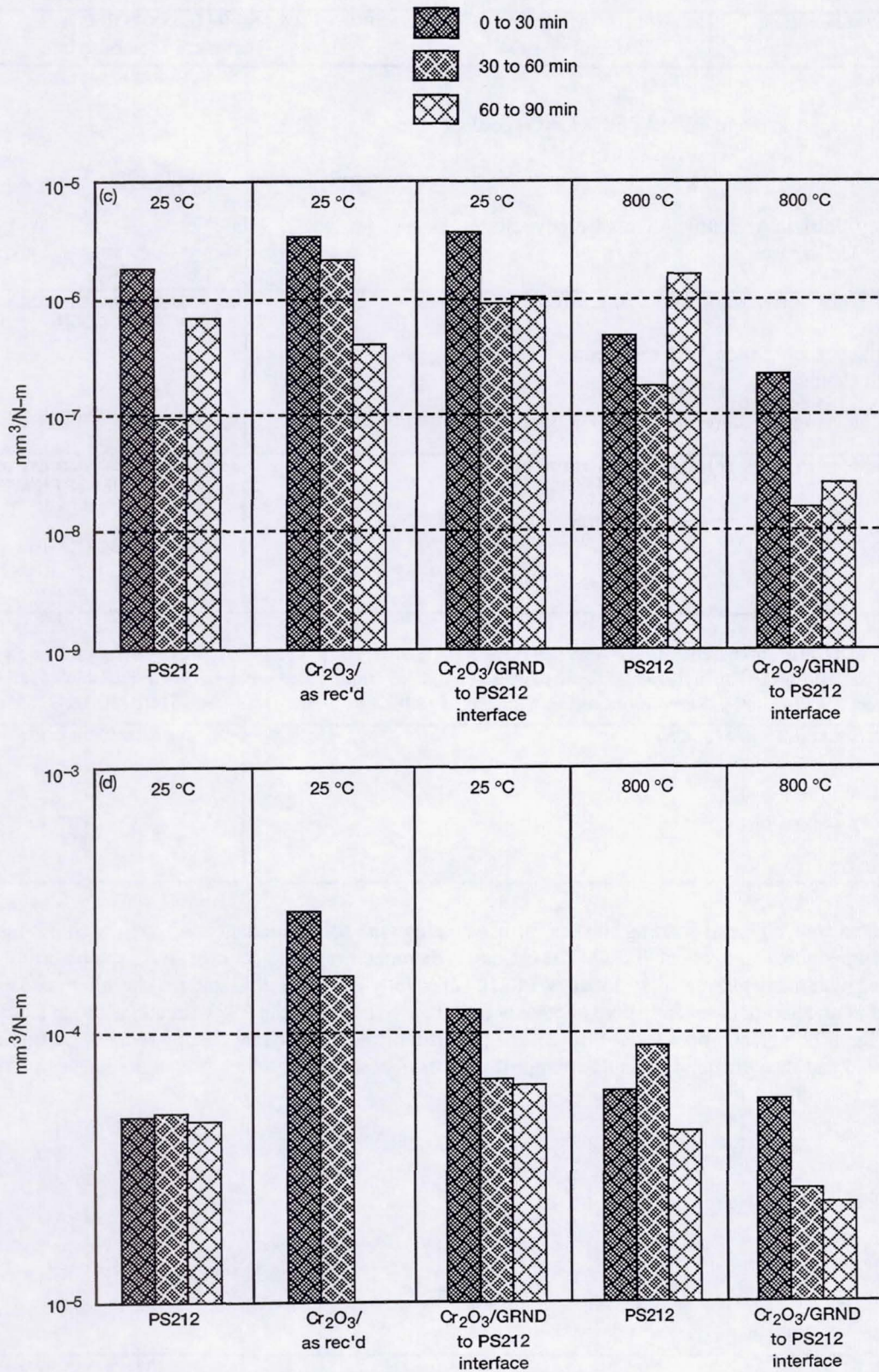

Figure 8.—(c) Pin wear factors for consecutive 30 minute tests. (d) Disk wear factors for consecutive 30 minute tests (mm<sup>3</sup>/N-m).



# REPORT DOCUMENTATION PAGE

*Form Approved*  
OMB No. 0704-0188

Public reporting burden for this collection of information is estimated to average 1 hour per response, including the time for reviewing instructions, searching existing data sources, gathering and maintaining the data needed, and completing and reviewing the collection of information. Send comments regarding this burden estimate or any other aspect of this collection of information, including suggestions for reducing this burden, to Washington Headquarters Services, Directorate for Information Operations and Reports, 1215 Jefferson Davis Highway, Suite 1204, Arlington, VA 22202-4302, and to the Office of Management and Budget, Paperwork Reduction Project (0704-0188), Washington, DC 20503.

1. AGENCY USE ONLY (Leave blank)	2. REPORT DATE December 1994	3. REPORT TYPE AND DATES COVERED Technical Memorandum	
4. TITLE AND SUBTITLE  Tribology and Microstructure of PS212 With a Cr <sub>2</sub> O <sub>3</sub> Seal Coat		5. FUNDING NUMBERS  WU-505-63-5A	
6. AUTHOR(S)  Harold E. Sliney, Patricia A. Benoy, Andras Korenyi-Both, and Christopher DellaCorte		8. PERFORMING ORGANIZATION REPORT NUMBER  E-9211	
7. PERFORMING ORGANIZATION NAME(S) AND ADDRESS(ES)  National Aeronautics and Space Administration Lewis Research Center Cleveland, Ohio 44135-3191		10. SPONSORING/MONITORING AGENCY REPORT NUMBER  NASA TM-106768	
9. SPONSORING/MONITORING AGENCY NAME(S) AND ADDRESS(ES)  National Aeronautics and Space Administration Washington, D.C. 20546-0001		11. SUPPLEMENTARY NOTES  Harold E. Sliney and Christopher DellaCorte, NASA Lewis Research Center; Patricia A. Benoy, Parks College, St. Louis University, St. Louis, Missouri 63103; Andras Korenyi-Both, Calspan Corporation, 21765 Brookpark Road, Fairview Park, Ohio 44126 (work funded by NASA Contract NAS3-25685). Responsible person, Christopher DellaCorte, organization code 5140, (216) 433-6056.	
12a. DISTRIBUTION/AVAILABILITY STATEMENT  Unclassified - Unlimited Subject Category 23		12b. DISTRIBUTION CODE	
13. ABSTRACT (Maximum 200 words)  PS212 is a plasma sprayed metal bonding chrome carbide coating with solid lubricant additives which has lubricating properties at temperatures up to about 900°C. The coating is diamond ground to achieve an acceptable tribological surface. But, as with many plasma spray coatings, PS212 is not fully-dense. In this study, a chromium oxide base seal coating is used in an attempt to seal any porosity that is open to the surface of the PS212 coating, and to study the effect of the sealant on the tribological properties of PS212. The results indicate that the seal coating reduces friction and wear when it is applied and then diamond ground leaving a thin layer of seal coating which fills in the surface pits of the PS212 coating.			
14. SUBJECT TERMS  Lubricant coatings; High temperature solid lubricant; Refractory seal coating			15. NUMBER OF PAGES 17
17. SECURITY CLASSIFICATION OF REPORT Unclassified			16. PRICE CODE A03
18. SECURITY CLASSIFICATION OF THIS PAGE Unclassified	19. SECURITY CLASSIFICATION OF ABSTRACT Unclassified	20. LIMITATION OF ABSTRACT	