



A
u
b
u
r
n

U
n
i
v
e
r
s
i
t
y

1002
10 27 19
6017

Experimental Analysis of Thread Movement in Bolted Connections Due to Vibrations

Research Project NAS8-39131

p. 176

Final Report

(NASA-CR-197705) EXPERIMENTAL
ANALYSIS OF THREAD MOVEMENT IN
BOLTED CONNECTIONS DUE TO
VIBRATIONS Final Report (Auburn
Univ.) 176 p

N95-24991

Unclas

G3/37 0044596

Prepared for

George C. Marshall Space Flight Center
MSFC, Alabama 35812

March 1995

Experimental Analysis of Thread Movement in Bolted Connections Due to Vibrations

Research Project NAS8-39131

Final Report, March 1995

Written by
Dr. G. Ed Ramey
Robert C. Jenkins

Prepared by
AUBURN UNIVERSITY
Civil Engineering Department
Harbert Engineering Center
Auburn University, Alabama 36849-5337

Principal Investigator
Dr. G. Ed Ramey

Prepared for
George C. Marshall Space Flight Center
MSFC Alabama 35812

MSFC Project Manager
Frank Thomas

Bolt Loosening Program
Special Projects Division

ABSTRACT

This is the final report of research project NAS8-39131 #22 sponsored by NASA's George C. Marshall Space Flight Center (MSFC) and carried out by the Civil Engineering Department of Auburn University (Auburn, Alabama) and personnel of MSFC. The objective of this study was to identify the main design parameters contributing to the loosening of bolts due to vibration and to identify their relative importance and degree of contribution to bolt loosening. Vibration testing was conducted on a shaketable with a controlled-random input in the dynamic testing laboratory of the Structural Test Division of MSFC. Test specimens which contained one test bolt were vibrated for a fixed amount of time and a percentage of pre-load loss was measured. Each specimen tested implemented some combination of eleven design parameters as dictated by the design of experiment methodology employed. The eleven design parameters were: bolt size (diameter), lubrication on bolt, hole tolerance, initial pre-load, nut locking device, grip length, thread pitch, lubrication between mating materials, class of fit, joint configuration, and mass of configuration. These parameters were chosen for this experiment because they are believed to be the design parameters having the greatest impact on bolt loosening. Two values of each design parameter were used and each combination of parameters tested was subjected to two different directions of vibration and two different g-levels of vibration. One replication was made for each test to gain some indication of experimental error and repeatability and to give some degree of statistical credibility to the data, resulting in a total of 96 tests being performed. The results of the investigation indicated that nut locking devices, joint configuration, fastener size, and mass of configuration were significant in bolt loosening due to vibration. The results of this test can be utilized to further research the complex problem of bolt loosening due to vibration.

MSFC PERSPECTIVE

PROJECT DESCRIPTION

Space Shuttle Payloads managed or developed at NASA's Marshall Space Flight Center (MSFC) are required to adhere to MSFC-STD-561, Threaded Fasteners, Securing of Safety Critical Flight Hardware Structure Used on Shuttle Payloads and Experiments. The requirements of MSFC-STD-561 are to lockwire or cotter pin safety critical flight hardware components or conduct vibration or acoustic tests to demonstrate that locking is not required. If lockwire or cotter pins are not used and testing is not performed then a waiver must be obtained from the responsible organization. However, applications arise where lockwiring or cotter pinning are not possible and resources and manpower are not available to conduct vibration tests. An analytical and experimental investigation was conducted to determine a method for predicting loosening in bolted joints so Space Shuttle payloads can use alternate locking devices without being subjected to vibration or acoustic testing.

PROJECT OBJECTIVES

Safety critical flight hardware, designed or managed by MSFC, requires positive locking devices such as cotter pins or lockwire or a vibration test to verify positive locking is not required. The objective of this research was to identify the main factors that cause bolt loosening due to vibrations, and then to experimentally test these factors in a vibration environment to assess their relative importance to bolt loosening.

PROJECT RESULTS

Analysis of the data from the program test matrix indicates that a locking device, the joint configuration, fastener size, and mass of the configuration are important factors in preventing fasteners from loosening for the parameters investigated in this study. This task was performed based on the fundamental concepts for the design of experiments and on an effective and efficient orthogonal array or fractional factorial methodology. One objective of the design of experiments approach is to have a good method of measuring the output characteristic. The output sought for this experiment was the amount of

preload, or tension, lost in the bolt after being vibrated. The measurement methods used - breakaway torque and change in bolt length measured with hand held micrometers - are suspect in obtaining accurate tension indication.

PROJECT OBSERVATION

The objective of this study was to investigate the effect of vibration on the loosening of fasteners. To achieve this goal, loosening must occur. However, only one test configuration loosened. Possible explanations for this was that the bolts were over-torqued and a relatively high coefficient of friction lubrication was used. The design of experiments and orthogonal array methodology used is sound and should be considered for the further loosening investigations.

MSFC APPLICATIONS

The information and experience gained from this experiment can be utilized in further fastener loosening investigations.

RECOMMENDATIONS

Means other than lockwiring or cotter pinning fasteners to prevent loosening remains an objective. Future endeavors to obtain an understanding of the loosening phenomena include the development of a test fixture that will cause loosening and a better method of detecting the preload in the bolt.

Frank Thomas, Project Manager
Special Projects Division
Marshall Space Flight Center, NASA

ACKNOWLEDGMENTS

The support of this work by the National Aeronautics and Space Administration under contract NAS8-39131 #22 is gratefully acknowledged.

The help and support of the following people in the execution of this project is acknowledged and very much appreciated:

Mr. Frank Thomas,	Project Manager Special Projects Division Marshall Space Flight Center, NASA
Mr. Richard Dotson,	Chief of Structural Design Division Marshall Space Flight Center, NASA
Mr. Gerald Waggoner, (Retired)	Chief of Structural Test Division Marshall Space Flight Center, NASA
Mr. Phillip Harrison,	Vibroacoustics and Data Analysis Branch Marshall Space Flight Center, NASA
Mr. Steve Brewster,	Chief of Dynamics Test Branch Marshall Space Flight Center, NASA
Mr. Rodney Phillips,	Vibration Test Engineer Dynamics Test Branch Marshall Space Flight Center, NASA
Mr. Steve Rodgers	Vibration Test Engineer Dynamics Test Branch Marshall Space Flight Center, NASA
Mr. James Foreman,	Consultant on Component Vibration Testing Assistant Professor Alabama A&M University

Ms. Diane Byrne,

Consultant on Taguchi Methods
Director, ITEQ, Livonia, MI

Mr. Jim Quinlan

Consultant on Taguchi Methods and Data Analysis
ITEQ, Livonia, MI

CONTENTS

<u>Section</u>		<u>Page</u>
1	INTRODUCTION	1
	General Statement of the Problem	1
	Objectives	1
	Scope	2
2	BACKGROUND AND LITERATURE REVIEW	3
	Background	3
	Literature Review	3
3	THEORETICAL CONSIDERATIONS	13
	General	13
	Threaded Fastener Nomenclature and Behavior	13
	Mechanics of Threaded Fastener Forces and Torques	16
	Effects of Vibratory Loadings on Bolt Loosening	35
	Primary Parameters Affecting Bolt Loosening	42
4	DESIGN OF EXPERIMENT AND EXPERIMENTAL TESTING PROGRAM	45
	General	45
	Experimental Test Parameters and Values	45
	Taguchi Methods	46
	Test Matrix	47
	Test Set-up	48
	Test Specimens	51
	Test Equipment and Instrumentation	54
	Testing Program	54
	Preliminary Testing	55
	Execution of Test Matrix	55

	Static On-Torque and Off-Torque Testing	57
	Confirmation Testing	58
	Additional Testing	60
5	EXPERIMENTAL RESULTS AND DATA ANALYSIS	65
	General	65
	Test Matrix Data	65
	Test Matrix Data Analysis	71
	General Analysis of Data	71
	ANOVA Analysis of Data	76
	Analysis Based on Adjusted Torque Data	77
	Analysis Based on Adjusted Length/Load Data	77
	Static On-Torque vs. Off-Torque Data	82
	Confirmation Testing Data	86
	Additional Testing Data	88
6	CONCLUSIONS AND RECOMMENDATIONS	92
	Conclusions Based on Theory	92
	Conclusions Based on Experimental Data	96
	Recommendations	100
	Recommendations for Future Research	101
	Phase II Work	102
	Phase III Work	102
	Phase IV Work	103
	REFERENCES	104
	APPENDICES	107
	APPENDIX A - Test Set-ups	108
	APPENDIX B - Fabrication and Procurement Drawings and Listings for Test Specimens, Bolts, and, Nuts	121
	APPENDIX C - Execution of Test Matrix Data	128
	APPENDIX D - Static On-Torque vs. Off-Torque Data	153
	APPENDIX E - Confirmation Test data	157
	APPENDIX F - Additional Test Data	160

LIST OF FIGURES

<u>Figure</u>	<u>Page</u>
2.1 Simplified Bolt/Nut Interaction	6
2.2 Bolt Tension and Nut Dilation	6
2.3 Loading Component to Cause Loosening	7
2.4 Inertial Loading (Shear Due to Bending)	7
3.1 Nomenclature of Bolt Threads	14
3.2 Contact Points in a Bolted Connections	14
3.3 Modeling of Square-Threaded Bolt	18
3.4 Square-Threaded Screw Jack	18
3.5 Modeling of Square-Threaded Screw as Block on Inclined Plane	19
3.6 V-Threaded Screw Jack	20
3.7 Variation in C_R and C_L with Bolt Thread Angle (α) and Coefficient of Friction (μ).	23
3.8 Approximate Forces on a V-Threaded Bolt at Impending Slipping	23
3.9 Thread Friction Force	25
3.10 Forces and Torque to Overcome Bolt Head Friction	28
3.11 Comparative Plot of C_L values vs. M for Various Thread Prediction Equations	30
3.12 Forces and Torque to Overcome Bolt Head Friction	31
3.13 Structural Steel Bolt	31
3.14 Modeling and Estimating Bolt Axial Fundamental Natural Frequency	36
3.15 Axial Stiffness of Connected Plates	36
3.16 Axial Impact loading Propagation	37
3.17 Transverse Bolt Loading Through Assemblage Bending	39
3.18 Bolt Rocking Motion	39
3.19 Cantilever Beam of Two Flat Bars Bolted Together	40

3.20	Modeling of Bolt/Nut as Inclined Plane and Transverse Sliding	40
3.21	Ratcheting Action of a Side Sliding Thread	41
3.22	Transverse Shock Loading	41
4.1	Test Matrix	48
4.2	Photographs of Typical Test Set-ups	49
4.2 (cont.)	Photographs of Typical Test Set-ups	50
4.3	Typical One Piece Cantilever	53
4.4	Typical Two Piece Cantilever	53
4.5	Ultrasonic Measurement of Bolt Length	61
4.6	Input Dimensions for BoltMike	61
5.1	Typical Input Signature Plot	68
5.2	Typical Response Plot From Accelerometer	68
5.3	Response Parameter vs. Design Parameters for Transverse/g ² Level Loading	75
5.4	Response Parameter vs. Design Parameters for E and J for Adjusted Torque Data	79
5.5	Response Parameter vs. Design Parameters for A, E, J, and L for Adjusted Torque Data	81
5.6	Plot of Δ Torque Vibration vs. Δ Torque Static	84
5.7	Plot of M_T / M_L Vibration Tests vs. M_T / M_L Static Tests	85
5.8	Comparison of p-Values for Vibration Direction	90
5.9	Comparison of p-Values for Bolt Preload	90
5.10	Comparison of p-Values for Lubricated Parts	91
5.11	Comparison of p-Values for Fastener Size	91
6.1	C_T and C_L vs. μ for Zero Friction Under Nut/Bolt Head	94
6.2	C_T and C_L vs. μ for Bolt Threads and Under Nut/Bolt Head	95

LIST OF TABLES

<u>Table</u>		<u>Page</u>
3.1	Comparative Equations and Values of C_L for Different Thread Types and Simplifying Assumptions	29
4.1	Test Parameters and Values	46
4.2	Test Set-ups	56
4.3	Confirmation Test 1 Set-up	59
4.4	Confirmation Test 2 Set-up	59
4.5	Test 1-4 Set-ups for Additional Testing	63
4.6	Test 5-8 Set-ups for Additional Testing	64
5.1	Summary of Raw Torque Data	66
5.2	Summary of Adjusted Torque Data	66
5.3	p-Values Based on Adjusted Torque Data	70
5.4	p-Values Based on Raw Length/Load Data	70
5.5	p-Values Based on Adjusted Length/Load Data	70
5.6	Test Matrix Response Parameters (p) for Design Load Parameters	74
5.7	ANOVA Table for Adjusted Torque p-Value Data	78
5.8	Pooled ANOVA Table for Adjusted Torque p-Value Data	79
5.9	ANOVA Table for Adjusted Length/Load p-Value Data	80
5.10	Pooled ANOVA Table for Adjusted Length/Load p-Value Data	81
5.11	Bolt Torque Reductions and Torque Tightening/Torque Loosening Ratios for Vibration Testing and Static Testing	83
5.12	Prediction and Confirmation Mean p-Values	88
5.13	p-Values for Additional Testing	89
6.1	Percent Increase in Design Cross-Section Area for Fine Threads	93

I. INTRODUCTION

1.1 General Statement of the Problem

The threaded fastener, or bolt, is one of the most common connecting devices. Used in a wide range of applications, one would expect that the knowledge of how a bolt performs under certain loading conditions would be well known. While the behavior of bolts under static tensile and shear forces is fairly well understood, their behavior under dynamic loads, such as vibration, is not. Many theories have been developed in an attempt to describe the way that a bolt and nut interact under vibratory loads. While these theories have proven helpful in understanding the bolt/nut interaction, none have proven adequate in predicting bolt loosening. In order to predict bolt loosening, it is important to first identify the parameters that contribute to bolt loosening so they can be quantified. The desire to identify the primary parameters that contribute to bolt loosening was the impetus for this study.

1.2 Objectives

The work presented in this report is directed toward a long range goal of prediction of bolt loosening. Once the main parameters that contribute to bolt loosening are identified, they can be quantified and, if successful, an empirical equation can be developed to predict bolt loosening. The major emphasis of the work presented herein

was the identification of the main parameters contributing to bolt loosening and to identify their relative importance and degree of contribution to bolt loosening.

1.3 Scope

The entire range of all parameters contributing to bolt loosening could not be explored in this experiment. Through literature review, discussions and meetings with select personnel of the Marshall Space Flight Center (MSFC), and engineering judgment the main parameters deemed suspect in bolt loosening were identified. These parameters were investigated in an experimental testing program employing a Taguchi Method design of experiment. The program was executed by the author and testing personnel of the Structural Testing Laboratory at MSFC.

The experimental work was limited to a preliminary testing phase to finalize vibratory loading modes and levels and testing procedures. The final experimental program/matrix consisted of testing 11 bolt design parameters in combinations dictated by the design of experiment methodology employed. This resulted in 48 different tests. One replication was made for each test to give some measure of repeatability and experimental error. This resulted in a total of 96 tests conducted.

The study includes a general background and literature review of the problems of bolt loosening. Theoretical considerations for bolt/nut interaction and vibrational loads on fasteners are presented in Chapter III. A discussion of design of experiment techniques and Taguchi methods, the derivation of the test matrix, and a description of the experiment are presented in Chapter IV. In Chapter V, data analysis and a presentation of the results of the experiment are presented. Conclusions and recommendations are presented in Chapter VI.

II. BACKGROUND AND LITERATURE REVIEW

2.1 Background

A bolted joint must maintain a minimum clamping force in order to resist loosening. The resulting frictional forces between the surfaces of the bolt, nut, and mating materials must be greater than any tangential surface forces that might act to oppose them. In order to do this, a complex set of design parameters involving the characteristics of the bolt, nut, and mating materials must be arranged such that the resistance to loosening is optimized.

At the present time, what is known about how a bolt and nut interact under vibrational load is based on theoretical models and some experimental data. The following literature review is directed toward what is currently known about bolt loosening as well as the mechanics of threaded fasteners.

2.2 Literature Review

Junker (18) indicates that aside from fatigue failure, self-loosening is the primary contributor to failure of bolted joints that are dynamically loaded. This loosening is the result of relative movement between the threads of the bolt and nut after the force of friction between these two surfaces has been overcome. In order to understand this concept, the threads of the bolt are viewed as an inclined plane and the bolt is viewed as a mass resting on the inclined plane, as shown in Fig. 2.1. The mass will remain at rest as

long as the force Q is greater than zero. If the inclined plane is vibrated, the mass will move as soon as the inertial force of the mass exceeds the frictional forces acting against the mass. While this is a simplified explanation of how the bolt and nut interact, it is sufficient in explaining the concept of self-loosening. Junker indicates that transverse vibration (vibration transverse to the axis of the bolt) is the most severe loading condition to induce bolt self-loosening. For axially loaded bolts, the primary contributor to self-loosening is the contraction of the bolt due to tensile forces while at the same time the dilation of the nut walls, as shown in Fig. 2.2. Junker mentions the following parameters as pertinent to bolt loosening: length of bolt, vibration endurance (point at which loss of pre-load is zero), hardness of mating materials, thread tolerance, thread pitch, and bolt reuse.

Goodier, et al. (12) indicates that the loosening of the threaded fastener/nut combination is the product of simple fluctuations of tension. When the load is increased, the threads of the bolt move radially inward and the threads of the nut move radially outward. The pull of the bolt acting in the direction of the threads causes the bolt to rotate. This theory/model of how loosening occurs during dynamic loading of threaded fasteners is helpful in understanding why some parameters, such as bolt diameter and thread pitch, contribute to loosening more than other parameters.

Finkelston (9) reiterates that the transverse direction is the most severe loading direction to cause bolt loosening. Some methods which he mentioned that would increase resistance to loosening are:

- 1) Increase friction in the joint by increasing the pre-load or the number of bolts in the joint.
- 2) Design mating materials with minimal or no clearance.
- 3) Use fasteners that will retard loosening.

Finkelston found several important variables affecting a fasteners ability to retain pre-load while under vibratory loads. These are listed below in his order of increasing importance:

1) Amplitude and frequency of dynamic motion: Amplitude and frequency of forces applied to a joint greatly effect the dynamic motion of the joint, which in turn causes relative motion within the joint.

2) Thread Pitch: The internal loosening torque in a bolted joint is directly proportional to the helix angle of the threads on the bolt. The larger the helix angle (coarse-pitch thread) the less vibration resistance is provided due to the larger internal torque that is generated. Internal torque is increased by a large helix angle because the thread angle is steeper. This causes the component of the force that would cause loosening, shown in Fig. 2.3, to be increased. Results from testing show that a fine-pitched locknut endures twice the cycles of vibration than does a corresponding coarse-pitched locknut, provided all other conditions are the same.

3) Initial pre-load: Vibration resistance is achieved by increasing the pre-load, thereby increasing the friction between mating materials.

4) Bearing surface conditions: Hardness and roughness of the mating materials as well as the thread surfaces and contact surfaces of the bolt can all influence the loosening of bolted joints. To minimize preload loss, the hardness of the mating materials and the bearing area of the fastener can be optimized. Some degree of embedding can take place statically and can be worsened by vibration which can cause plastic flow of the joint surface. This embedding causes loss of preload and is usually experienced within the first ten cycles of vibratory loading.

Crispell (8) indicates that the diameter of the fastener and method of manufacturing are important factors in fatigue strength of threaded fasteners. Fatigue endurance diminishes with increasing diameter and this is believed to be attributable to the method in which the

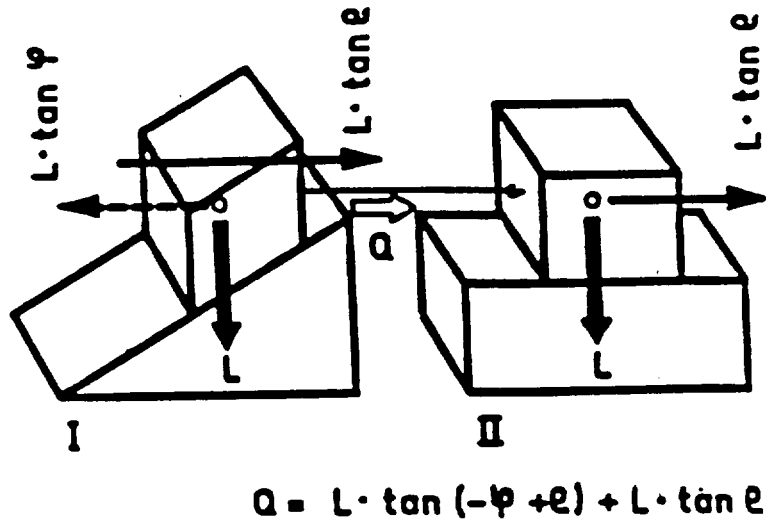

Figure 2.1 Simplified Bolt/Nut Interaction (18).

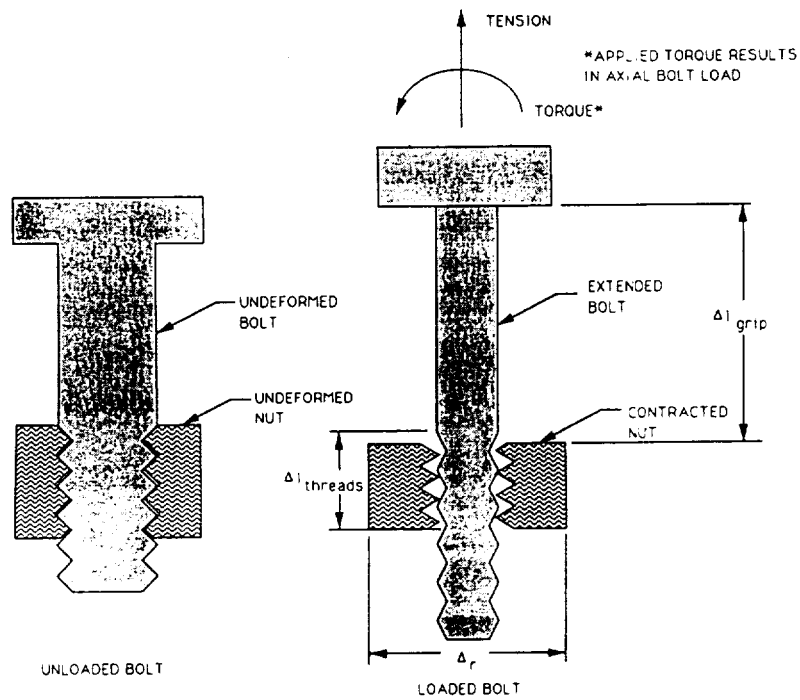

Figure 2.2 Bolt Tension and Nut Dilation.

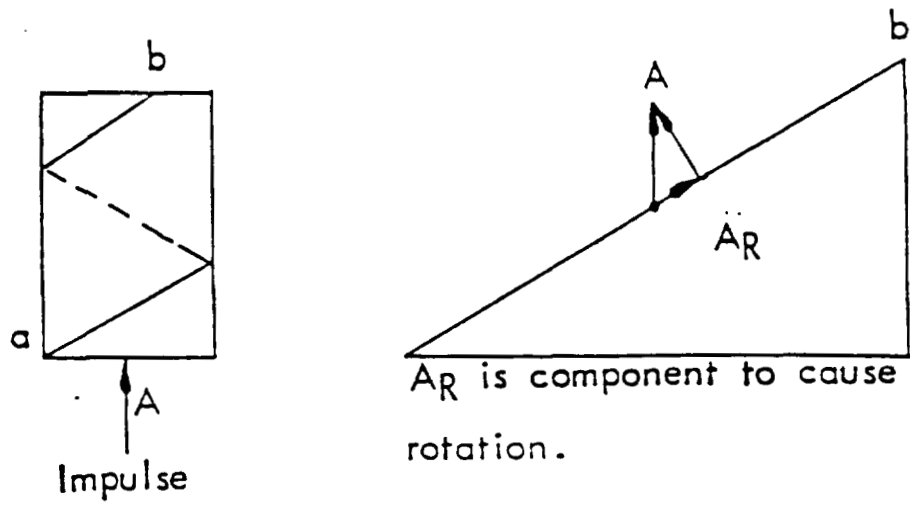

Figure 2.3 Loading Component to Cause Loosening (2).

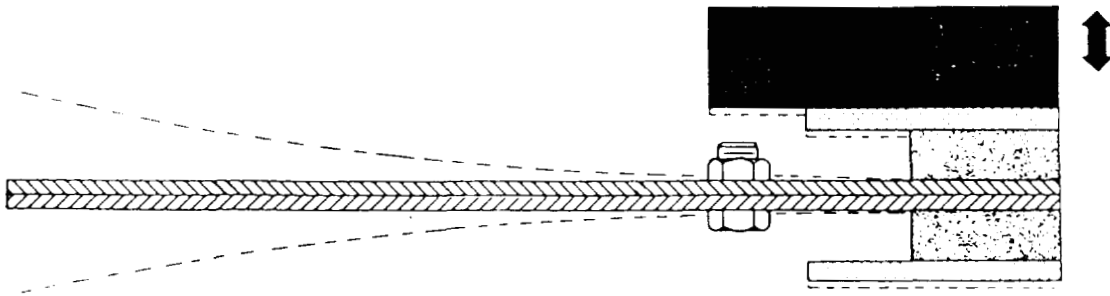

Figure 2.4 Inertial Loading (Shear Due to Bending) (19).

threads of the fastener are formed. Natural deformities in the material used can promote deformation by slip between the bolt and nut. Stress concentrations that reduce fatigue life are a result of these deformities. With a large diameter bolt, there is more surface area that could possibly have these stress concentration points. Residual compressive stresses are induced from rolling the threads in the manufacturing process. These stresses enhance fatigue resistance. However, if the bolt is heat treated, these stresses are relieved and any advantage in fatigue resistance that is gained by rolling the threads would be lost. Therefore, the most fatigue resistant fastener can be achieved by rolling the threads after heat treatment. Closer tolerances can also be achieved from rolling the threads.

Baubles, et al. (2) demonstrated that the nut has a preferred direction of rotation when it is subjected to vibration. Usually, this preferred direction of rotation is to loosen because this is the path of least resistance. Resonant frequencies may be excited by external forces which cause vibrations that could promote loosening. The frequency of the vibrating force is noted as an insignificant factor in bolt loosening. However, frequency does affect time of loosening which indicates that bolt loosening occurs as a result of induced oscillation of the parts in the joint at their natural frequencies. Also, amplitude of the vibration is indicated as an insignificant factor in bolt loosening. Baubles found that an increase in bolt length yielded an increase in vibration life. Other factors that were found to be important to bolt loosening when a non self-locking nut was used were bolt prestress and seating torque. Retaining torque can be held constant by the use of a castellated nut and cotter pin. A variety of locknuts can also be used to maintain a retaining torque in the event of prestress loss. Self locking nuts are categorized as nylon insert, aircraft quality all-metal, and commercial all-metal. Testing shows that the aircraft

quality nuts were more resilient in resisting loosening than were the commercial nuts. Threshold torque, which is the minimum torque required to loosen the nut, was low for the nylon insert nut compared to the other two nut types.

Saur, et al. (23) found that the loosening effect of vibratory loading is large initially, but diminishes rapidly as the number of load cycles increases. Saur also notes that the condition of contact surfaces is an important parameter in bolt loosening. Previously used nuts were shown to be beneficial in reducing loosening. When the contact surfaces were cleaned and smoothed, the rate of loosening changed more abruptly than when the surfaces were not treated. No loosening was experienced after 4000 cycles. Saur recommends the use of previously used mating surfaces to reduce loosening. Also recommended is cleaning and smoothing the mating surfaces prior to use as well as the use of bolts that have smoother and more regular surfaces due to the method of manufacturing. These methods allow more surface contact between mating surfaces and thus increases the coefficient of friction. Saur indicated that the alignment of the hole in which the bolt is inserted, is of little importance. Saur found that for a given load case, the amount of loosening decreased with an increase of preload. This indicates the importance of keeping the dynamic-static load ratio small. Saur also notes that if a small amount of loosening occurs in a bolted connection, this loosening could be compounded by load relaxation, i.e., the dynamic-static load ratio would increase further promoting loosening. Negligible amounts of load relaxation occurs for dynamic-static load ratios of 0.8 and below.

Brenner (3) indicates that the most severe vibration condition is experienced when the system goes into resonance. He recommends avoidance of resonant vibrations.

Haviland (13) indicates that the torque applied in order to tighten a bolt causes the distance between the bottom of the bolt head and the top of the nut to decrease. This will

continue until torsional equilibrium is reached between the torsional resistances caused by frictional forces under the bolt head and on the bolt threads. Both of these are functions of the bolt tension. One structure that Haviland tested was a simple cantilever composed of two steel blades bolted together. The structure was subjected to a 10-g load at 20 to 400 Hz which caused first mode bending and loosening within 100 to 200 cycles (5 to 10 seconds). Haviland recommends using liquid threadlock to fill the voids between threads to prevent thread movement, thus preventing loosening.

Chapman, et al. (5) found that the clamping force in a bolt (preload) is proportional to the wrenching torque applied to the head of the bolt. This relationship is highly dependent on the friction between the bolt and mating parts. Chapman also notes that when the wrenching torque is removed, the "windup" in the shank of the bolt will cause the head to twist back minutely until the friction under the bolt head is in equilibrium with the shank torque. This will cause an approximate 20 to 30 percent loss of shank torque, thus causing a reduction in preload. Chapman shows that a bolt that has been tightened to its yield point can carry higher work loads prior to the joint opening, thus increasing the fatigue strength of the joint because fatigue failure occurs mainly when the joint opens.

Holmes (16) indicates that when a nut is torqued, a portion of the energy required to tighten the assembly is stored as potential energy. The friction between the thread flanks prevent the nut from unscrewing and returning to a position of rest. Once movement occurs in the threads, the friction force between them becomes increasingly harder to maintain. To prevent loosening, Holmes recommends fine threaded bolts, especially when transverse forces are expected. An improved stress distribution along the length of the thread engagement is also favorable to prevent loosening.

Clark (6) found that the breakaway torque was a good measure of the self-locking characteristics of the bolted joint as well as the work done to remove the bolt.

Kerley (19) used a cantilever configuration similar to Haviland (13) to analyze and test the loosening of threaded fasteners under dynamic loading. This configuration introduced shear loadings on the bolt due to bending induced by the beam inertial forces as indicated in Fig. 2.4. He explored several parameters that are believed to influence bolt loosening. Vibration direction, lubrication on the threads, type of thread locking device used, embedding of the nut or bolt head into the mating materials, load distribution on threads, loading history of the bolt and nut, size of the bolt and nut, and geometry of the threads are parameters which were explored. Some of the primary results from Kerley's testing as reported in Ref.(19) and as reported in telephone conversations with Kerley are as follows:

1. Resonant sine and random vibration loadings were used and resonant sine loadings caused the bolts to loosen more rapidly.
2. All bolts tested were 1/4" diameter and high quality steel ($120\text{ksi} \leq \sigma_y \leq 160\text{ksi}$). At preload levels of $\frac{1}{2}P_y < P_p < P_y$, bolt loosening was rather insensitive to the bolt preload.
3. All bolts/threads/nuts were lubricated as were the washers and other mating surfaces ($0.08 < \mu_s < 0.15$). Under these conditions standard nuts loosened in a reasonable period of vibration loading, whereas no loosening of locknuts occurred.
4. When a bolt begins to loosen in a resonant sine loading test, it can be easily detected by monitoring the vibrator power input requirement.
5. When bolt loosening begins, it loosens completely in a short period of time, i.e., the loosening occurs quickly.

Additionally, Kerley indicated that researchers in Japan have done some vibration testing and found that if the thread angle 2θ (see Fig. 3.1) is lowered to around 50 - 55 degrees, then regular nuts will not loosen.

This chapter has reported on the literature pertaining to what is known about how threaded fasteners behave under vibratory loadings. Whereas a significant amount of work has been done on this topic, and has led to valuable contributions; there are still many questions about the loosening of bolts due to vibrations which remain unanswered.

III. THEORETICAL CONSIDERATIONS

3.1 General

The previous chapter presented a brief review of the state-of-the-art regarding the loosening of bolts. In this chapter, a more detailed explanation of the mechanics of threaded fasteners is provided, along with a discussion of the effects of vibrational loadings on threaded fasteners. Lastly, the primary design and loading parameters affecting bolt loosening are listed and briefly discussed from a theoretical perspective.

3.2 Threaded Fastener Nomenclature and Behavior

The nomenclature of bolt threads is illustrated in Fig. 3.1. In order to understand how a threaded fastener will behave in a given situation, it is important to understand the mechanics of the fastener. Each element of the bolt and nut will be analyzed in order to better understand how they interact when under different loading cases.

The clamping force in a bolted joint is a summation of tensile forces within the bolt and friction forces generated between all parts in contact within that particular joint. These contact points, illustrated in Fig. 3.2, are between the head of the bolt and mating material, the threads of the bolt and nut, and the nut and mating materials. When the bolt is tightened, the distance between the bolt and nut decreases. When the tightening torque meets resistance from the clamped mating materials, a friction force is created. As further

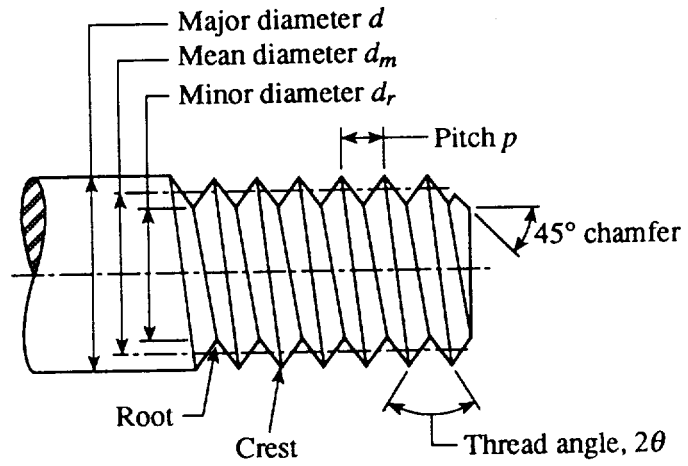

Figure 3.1 Nomenclature of Bolt Threads (24).

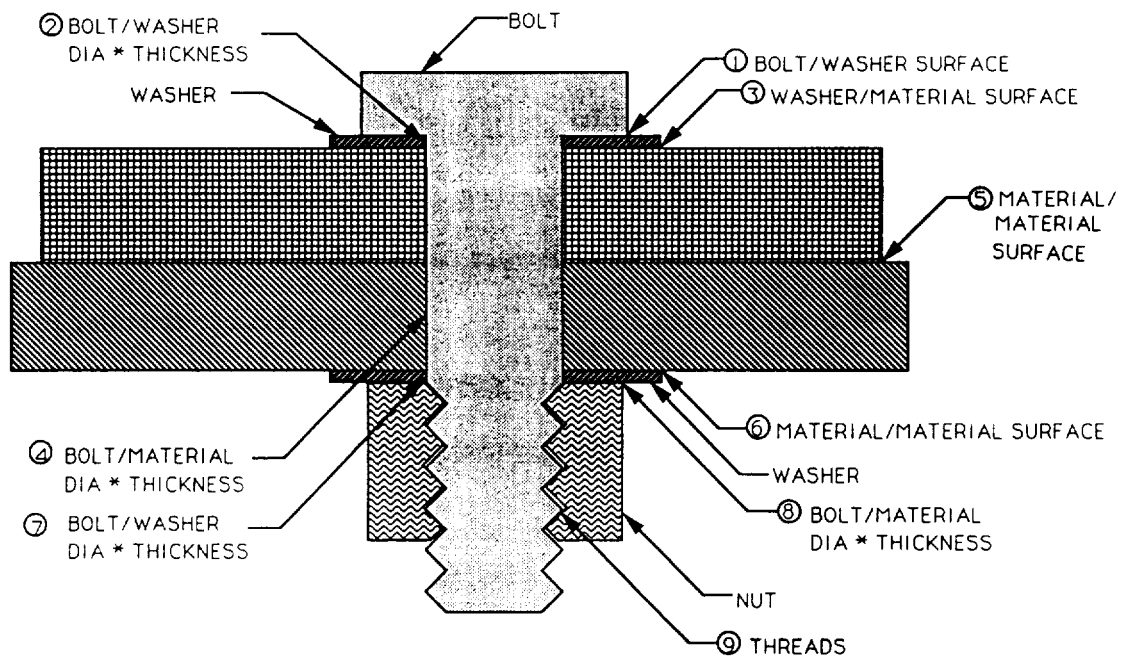

Figure 3.2 Contact Points in a Bolted Connection.

tightening occurs, the bolt begins to elongate and the nut begins to dilate (in the case of rigid mating materials), as shown in Fig. 2.2, creating a tensile force within the bolt that will in turn increase the friction forces between interfacing surfaces. The bolt can continue to be tightened until an equilibrium is reached between the tightening torque and the summation of resisting forces (clamping force). At this point, the connection will not loosen until a force (loosening force) is applied in the opposite direction from tightening to overcome the clamping force (13). A detailed discussion of bolt loosening forces and torques is given in the next section.

Bolt preload is commonly measured as axial tensile stress in the bolt that develops as a result of tightening. The tensile stresses can be considered to be uniformly distributed over the cross-section of the bolt (5). Bolt elongation, or strain, can be used as a measure of stress within the bolt. For example, a steel bolt will elongate 0.001 in. per inch of length for a 30,000 psi stress (14). Usually, a bolt is tightened to some percentage of its yield strength. Another stress within the bolt generated from tightening is a torsional stress. The distribution of this stress goes from zero at the bolt's center to its maximum value at its outer surface. As a bolt is tightened, both axial and torsional stresses develop. When the tightening torque is removed, the torsional stress in the shank of the bolt will cause the head of the bolt to twist back minutely until the friction under the bolt head is in equilibrium with the shank torque. This will cause a loss of shank torque and thus a reduction in preload (5).

The main area of concern in bolt loosening is the interface between the surfaces of the bolt and nut, or thread engagement. As the bolt is tightened stresses also develop along the length of the thread engagement. One important note is that each thread that is engaged does not carry the same load. Generally, the threads closer to the head of the bolt carry more of the load than do the threads toward the end. Also effecting this

relationship is the depth of penetration of the threads within one another. The greater the penetration among threads, the more load they can carry and the more friction that can be generated between them. This depth of penetration is a function of bolt/nut class of fit. Class of fit refers to the looseness or tightness between mating threads. There are three classes of fit for Unified inch screws; 1, 2, or 3 with 1 being the loosest fit and 3 being the tightest. Also the class of fit is designated with an A or B for external or internal threads respectively. So, a 3A would designate a class 3 bolt and 3B would designate a class 3 nut (17).

3.3 Mechanics of Threaded Fastener Forces and Torques

Threaded fasteners typically have V-shaped threads as shown in Figs. 3.1 and 3.2. However, to discuss and graphically illustrate the mechanics of their behavior, it is convenient to look at a simpler case, the square-threaded bolt or screw. The discussion below is a somewhat modified version of that presented in Ref (20).

A square-threaded screw can be viewed as a bar of rectangular cross-section wrapped around a cylinder in a helical fashion, as shown in Fig. 3.3. The helix angle α is called the thread lead angle, the distance p between the threads is known as the pitch, and the mean radius of the threads is denoted by r . These three parameters are related by

$$\tan \alpha = \frac{p}{2 \pi r}$$

or

$$p = 2 \pi r \cdot \tan \alpha \tag{3.1}$$

as evident by the one unwound thread indicated in Fig. 3.3.

Figure 3.4 depicts a screw being used as a jack. Assuming that the torque M is large enough, it will cause the screw to advance and thereby elevate the weight W . This case can be simplified if we recall that in Coulomb's friction theory, the friction force is independent of the contact area. Hence, we can assume the contact area to be very small, as illustrated in Fig. 3.4. Note that the entire weight W is carried by the contact area and that the horizontal force $Q = \frac{M}{r}$ models the applied torque M . Note that this case is identical to the one shown in Fig. 3.5, namely, a block of weight W being pushed up an incline of angle α by the horizontal force Q .

The smallest torque required to start the weight W moving upward can be obtained from the FBD in Fig. 3.5(b). Note that at impending sliding the angle between R and the normal n to the contact surface is $\phi = \phi_s$, and that the direction of ϕ_s relative to the normal n indicates that the impending motion is directed up the incline. For equilibrium of the block,

$$[\Sigma F_x = 0] \rightarrow + \quad \frac{M}{r} - R \sin(\phi_s + \alpha) = 0 \quad (3.2)$$

$$[\Sigma F_y = 0] \uparrow + \quad R \cos(\phi_s + \alpha) - W = 0 \quad (3.3)$$

Solving Eqns. 3.2 and 3.3, the smallest torque that will cause the weight W to move upward is

$$(M)_{\min} = M_x = Wr \tan(\phi_s + \alpha) \quad (3.4)$$

If the direction of M is reversed and assuming impending motion down the incline, the FBD in Fig. 3.5(c) must be used. In this case, the equilibrium of the block,

$$[\Sigma F_x = 0] \rightarrow + \quad R \sin(\phi_s - \alpha) - \frac{M}{r} = 0 \quad (3.5)$$

$$[\Sigma F_y = 0] \uparrow + \quad R \cos(\phi_s - \alpha) - W = 0 \quad (3.6)$$

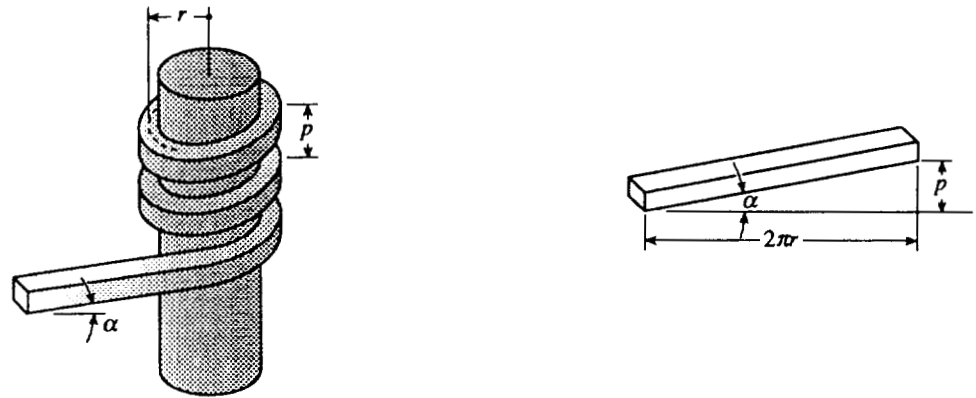

Figure 3.3 Modeling of Square-Threaded Bolt (20).

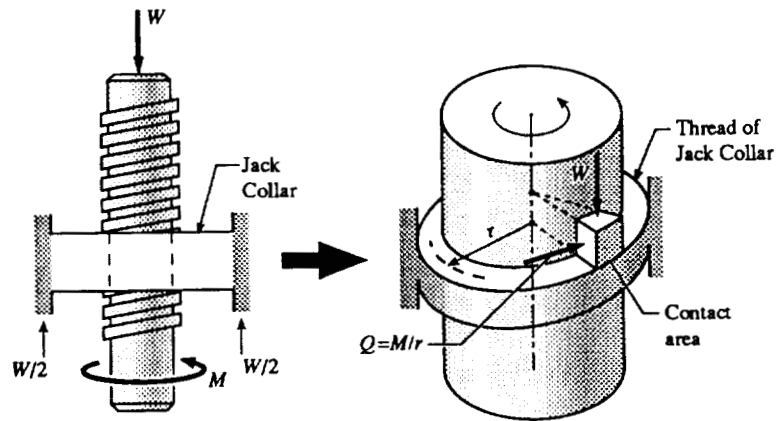
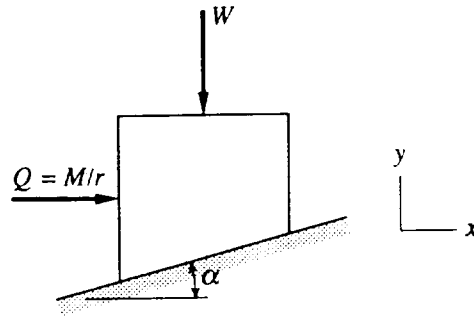

Figure 3.4 Square-Threaded Screw Jack (20).



(a) Modeling as Block on Inclined Plane.

(b) Impending Motion Up the Plane (lifting W).(c) Impending motion Down the Plane (lowering W).

Figure 3.5 Modeling of Square-Threaded Screw as Block on Inclined Plane (20).

Solving these equations as before, the smallest torque required to move the weight W downward is

$$(M)_{down} = M_t = Wr \tan(\phi_s - \alpha) \quad (3.7)$$

Note that if $\phi_s > \alpha$, the torque M in Eqn. 3.7 is positive, which means that the weight W remains at rest if M is removed. In this case, the screw is said to be self locking. On the other hand, if $\phi_s < \alpha$, the torque M in Eqn. 3.7 is negative, indicating that the weight W would come down by itself in the absence of M . If $\phi_s = \alpha$, the screw is on the verge of unwinding.

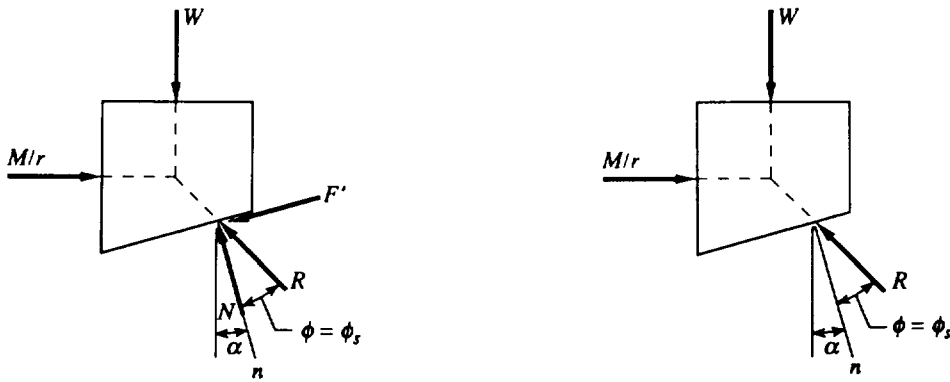
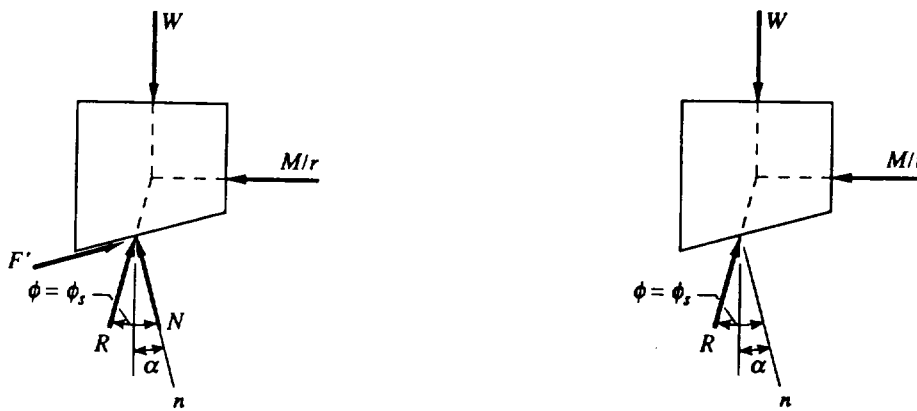
Assume that the square-threaded screw jack in Fig. 3.4 is replaced by a V-thread as indicated in Fig. 3.6 (the helix angle of the thread is exaggerated for clarity). The force R acting on a representative small section of the thread is shown in Fig. 3.6 with its relevant projections. The vector R_1 is the projection of R in the plane of the figure containing the axis of the screw.

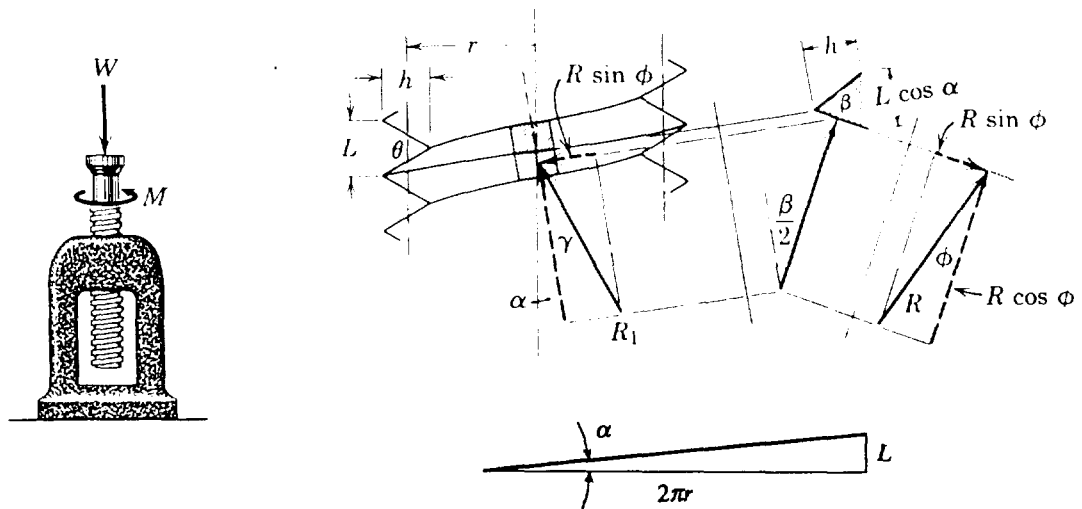

Figure 3.6 V-Threaded Screw Jack (20).

The moment on the screw required to raise the load W in this case is given in Ref (24) as

$$M_r = Wr \left[\frac{\tan \alpha + \mu \sqrt{1 + \tan^2 \frac{\theta}{2} \cos^2 \alpha}}{1 - \mu \tan \alpha \sqrt{1 + \tan^2 \frac{\theta}{2} \cos^2 \alpha}} \right] \quad (3.8)$$

$$\text{where } \alpha = \tan^{-1} \frac{L}{2\pi r}$$

$$\phi = \tan^{-1} \mu$$

The M required to lower the load W is

$$M_l = Wr \left[\frac{-\tan \alpha + \mu \sqrt{1 + \tan^2 \frac{\theta}{2} \cos^2 \alpha}}{1 + \mu \tan \alpha \sqrt{1 + \tan^2 \frac{\theta}{2} \cos^2 \alpha}} \right] \quad (3.9)$$

It should be noted that for the case where $\theta = 0$, i.e., a square thread, Eqns. (3.8) and (3.9) reduce to Eqns. (3.10) and (3.11) respectively.

$$M_r = Wr \frac{\tan \alpha + \mu}{1 - \mu \tan \alpha} \quad (3.10)$$

$$M_l = Wr \frac{\mu - \tan \alpha}{1 + \mu \tan \alpha} \quad (3.11)$$

Equations (3.4), (3.7), (3.8), (3.9), (3.10), and (3.11) can be written as

$$M_R = WrC_R \quad (3.12)$$

$$M_L = WrC_L \quad (3.13)$$

where C_R and C_L are the terms other than Wr in each equation.

The equations for lowering the weight W , i.e., Eqns. (3.9), (3.11), and (3.13) are the appropriate equations to use in the case of bolt loosening. It should be noted that the torques needed to overcome thread friction as well as to lift the weight W (or to develop the bolt preload P_p) are included in the equations for M_R and M_L above. For example, in the absence of friction, taking $\phi = 0$ in these equations will yield the torque needed to lift the weight W . Of course, in the absence of friction, this torque would have to remain in place to prevent the weight from lowering due to the screw unwinding.

Plots depicting the variation in C_R and C_L in Eqns. (3.10) and (3.11) with coefficient of friction (μ) and thread angle (α) are shown in Fig. 3.7. This figure indicates that the coefficient C (C_R and C_L), and thus the torque required to overcome thread friction and to lift or lower the weight is almost independent of α . Also, the figure indicates that C varies approximately linearly with μ . Note that a μ of approximately 0.025 - 0.040 is required to prevent a screw/nut from unwinding by itself. Also note that the C values for the coarser thread, i.e., 10 threads per inch are slightly larger than those for the finer thread in raising the weight, but are smaller for lowering the weight. This is as would be expected. Note also, that $C_R \approx C_L \approx \mu$ is a rather good approximation of C .

An alternate approximation equation for bolt torque to overcome thread friction is presented below. In deriving this equation, it is assumed that motion at the bolt/nut thread interface is impending in both the radial and circumferential directions as indicated in Fig. 3.8. Hence,

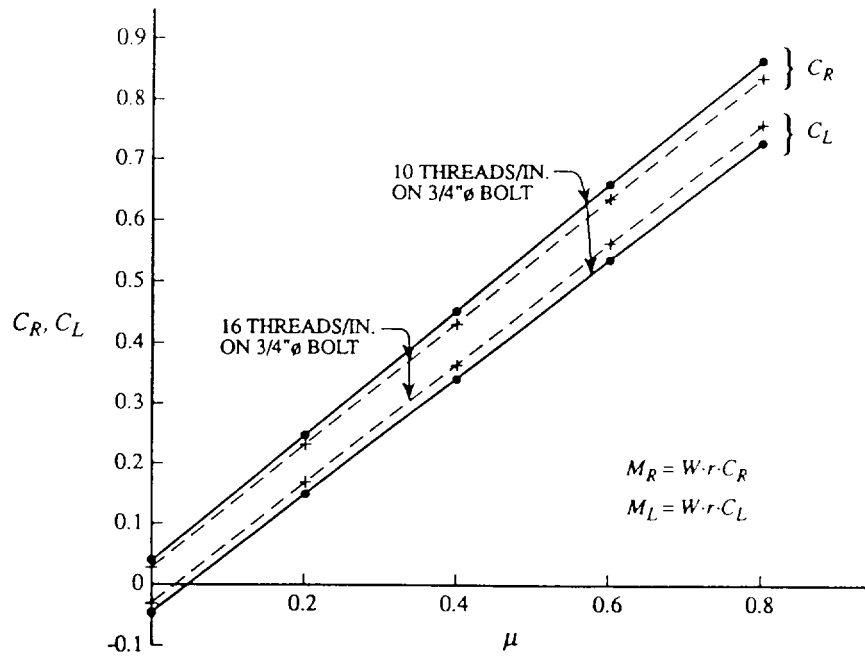

Figure 3.7 Variation in C_R and C_L with Bolt Thread Angle (α) and Coefficient of Friction (μ).

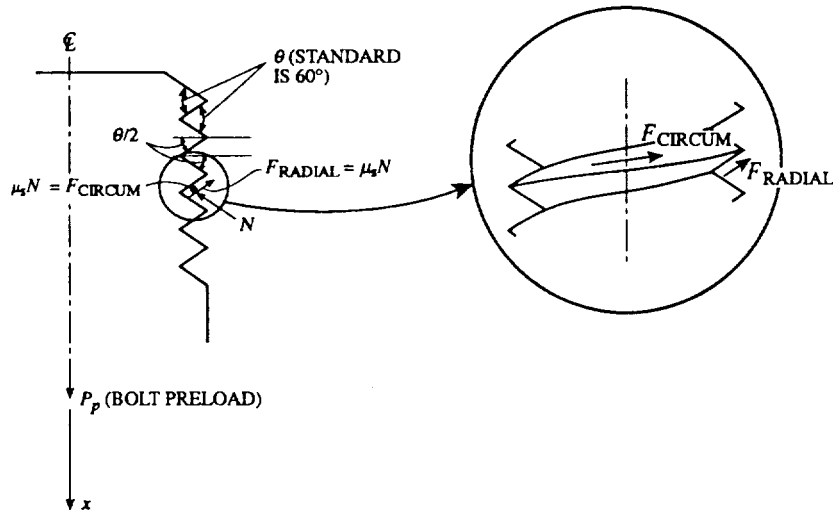

Figure 3.8 Approximate Forces on a V-Threaded Bolt at Impending Slipping.

$$[\Sigma F_x = 0] \uparrow +$$

$$N_x + F_{RADIAL_x} - F_{CIRCUM_x} - P_p = 0$$

$$N \cos \frac{\theta}{2} + \mu_s N \sin \frac{\theta}{2} - P_p = 0$$

$$N \left(\cos \frac{\theta}{2} + \mu_s \sin \frac{\theta}{2} \right) = P_p$$

$$N = \frac{P_p}{\cos \frac{\theta}{2} + \mu_s \sin \frac{\theta}{2}} \quad (3.14)$$

$$F_{CIRCUM} = \mu_s N = \mu_s \left[\frac{P_p}{\cos \frac{\theta}{2} + \mu_s \sin \frac{\theta}{2}} \right] \quad (3.15)$$

Hence, the torque, M , required to overcome thread friction is approximately

$$M = F_{CIRCUM} r = P_p r \left[\frac{\mu_s}{\cos \frac{\theta}{2} + \mu_s \sin \frac{\theta}{2}} \right] \quad (3.16)$$

It should be noted that the M required to develop the preload P_p is not included in Eqn. (3.16). For convenience of comparison with the earlier equations, the torque required to develop preload (see Eqn. (3.21)) should be added (or subtracted for loosening) to Eqn. (3.16). This results in

$$M_r = P_p r \left[\frac{\mu_s}{\cos \frac{\theta}{2} + \mu_s \sin \frac{\theta}{2}} + \tan \alpha \right] \quad (3.17)$$

$$M_t = P_p r \left[\frac{\mu_s}{\cos \frac{\theta}{2} + \mu_s \sin \frac{\theta}{2}} - \tan \alpha \right] \quad (3.18)$$

Ganguly (11) presented Fig. 3.9 and Eqns. (3.19) and (3.20) for torque to overcome thread friction. Referring to Fig. 3.9, the normal force component perpendicular to the thread flanks is P_c . Hence, the circumferential friction force is

$$F_{CIRCUM} = \mu_s P_c = \mu_s \frac{P_p}{\cos \frac{\theta}{2}} \quad (3.19)$$

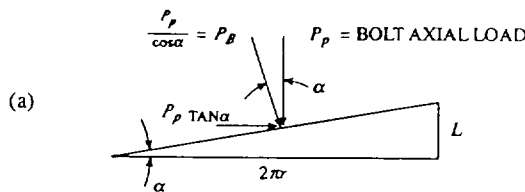

α = Thread lead angle

P_p = Axial load

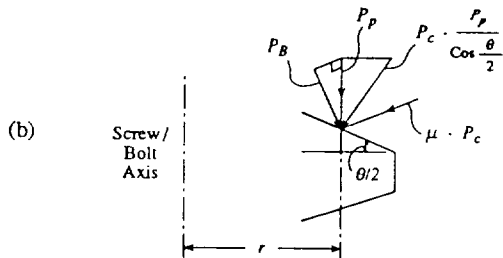

P_B = Normal force component of axial load perpendicular to thread helix

θ = Thread angle

P_c = Normal force component of axial load perpendicular to thread flanks

Figure 3.9 Thread Friction Force (11).

Therefore, the torque to overcome thread friction is approximately

$$M = F_{CIRCUM} r = P_p r \left[\frac{\mu_s}{\cos \frac{\theta}{2}} \right] \quad (3.20)$$

Again, for convenience of comparisons, the torque required to develop the preload should be added to the M of Eqn. (3.20). This yields,

$$M_R = P_p r \left[\frac{\mu_s}{\cos \frac{\theta}{2}} + \tan \alpha \right] \quad (3.21)$$

$$M_L = P_p r \left[\frac{\mu_s}{\cos \frac{\theta}{2}} - \tan \alpha \right] \quad (3.22)$$

Recall in Chapter II it was reported that researchers in Japan found experimentally that when the bevel angle of the threads was decreased from $\frac{\theta}{2} = 30^\circ$ to approximately $\frac{\theta}{2} = 25^\circ$, then the bolts did not loosen under vibratory loadings. In light of Eqns. (3.16) and (3.20) this does not make sense theoretically, as both of these equations yield smaller values of C , and thus smaller torque to overcome thread friction when θ is decreased.

In addition to the bolt/screw torque required to overcome thread friction, a torque is required to raise a load W or to develop a preload P_p in the absence of friction. As illustrated in Fig. 3.10, this torque (M_p) is given below in Eqn. (3.23).

$$M_p = (P_p \tan \alpha) r$$

$$M_p = P_p r \tan \alpha \quad (3.23)$$

or,

$$M_p = P_p r \frac{P}{2\pi r}$$

$$M_p = P_p \frac{P}{2\pi} \quad (3.24)$$

Of course, in the absence of friction, the torque in Eqns. (3.23) and (3.24) must be maintained or the bolt/screw will unwind itself.

A comparison of the torques required to overcome thread friction and to develop the preload for various thread types and simplifying assumptions are shown in Table 3.1. Each of the equations has been placed in the form,

$$M_L = C_L P_p r \quad (3.25)$$

and the expressions for C_L along with values for various values of μ are presented in Table 3.1 and are plotted in Fig. 3.11.

Figure 3.11 indicates that all of the equations for C_L require a μ of approximately 0.025 to prevent the screw or nut from unwinding by itself. This is as would be expected. Note that all of the equations for C_L are linear in μ with the exception of the one labeled C . Also note that

$$C_L \approx \mu \quad (3.26)$$

is not a bad approximation for C_L .

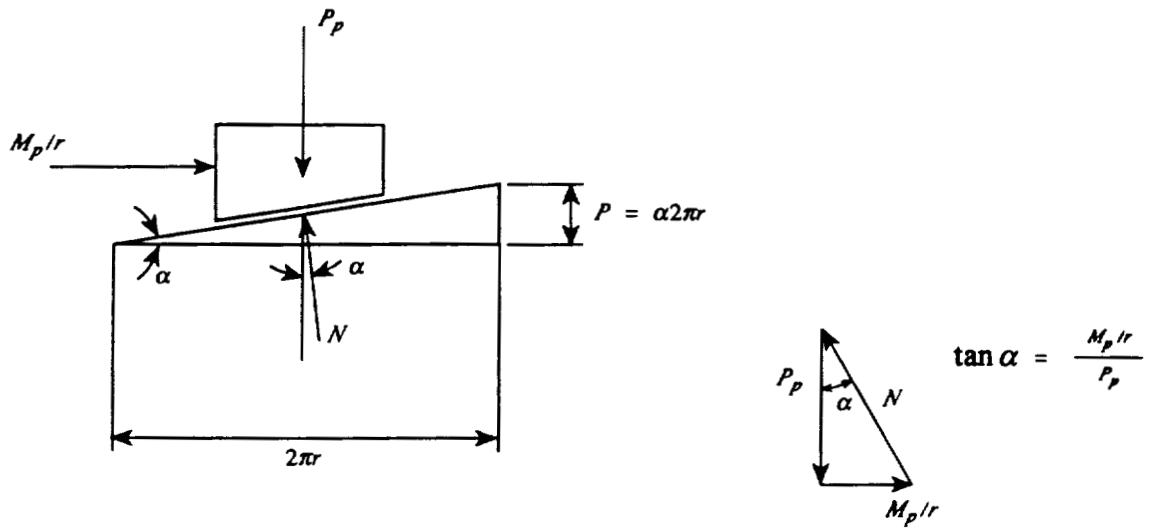

Figure 3.10 Forces and Torque Needed to Develop Preload, P_p .

Table 3.1 Comparative Equations and Values of C_L
for Different Thread Types and Simplifying Assumptions

Eqn No.	C_L Eqns [†]	Label in Fig. 3.11	Values of C_L ‡				
			$\mu=0$	$\mu=0.1$	$\mu=0.2$	$\mu=0.4$	$\mu=0.5$
3.9	$\frac{-\tan \alpha + \mu \sqrt{1 + \tan^2 \frac{\theta}{2} \cos^2 \alpha}}{1 + \mu \tan \alpha \sqrt{1 + \tan^2 \frac{\theta}{2} \cos^2 \alpha}}$	A	-0.027	0.089	0.203	0.430	0.542
3.11	$\frac{\mu - \tan \alpha}{1 + \mu \tan \alpha}$	B	-0.027	0.073	0.173	0.370	0.467
3.18	$\frac{\mu}{\cos \frac{\theta}{2} + \mu \sin \frac{\theta}{2}} - \tan \alpha$	C	-0.027	0.082	0.180	0.348	0.421
3.22	$\frac{\mu}{\cos \frac{\theta}{2}} - \tan \alpha$	D	-0.027	0.088	0.204	0.435	0.550

[†] $M_L = C_L P_p r$ (M_L = Moment required to lower a weight).

[‡] Values shown are for $\theta = 60^\circ$ and $\alpha = 1.52^\circ$ (16 threads per inch on a $\frac{3}{4}$ " ϕ bolt).

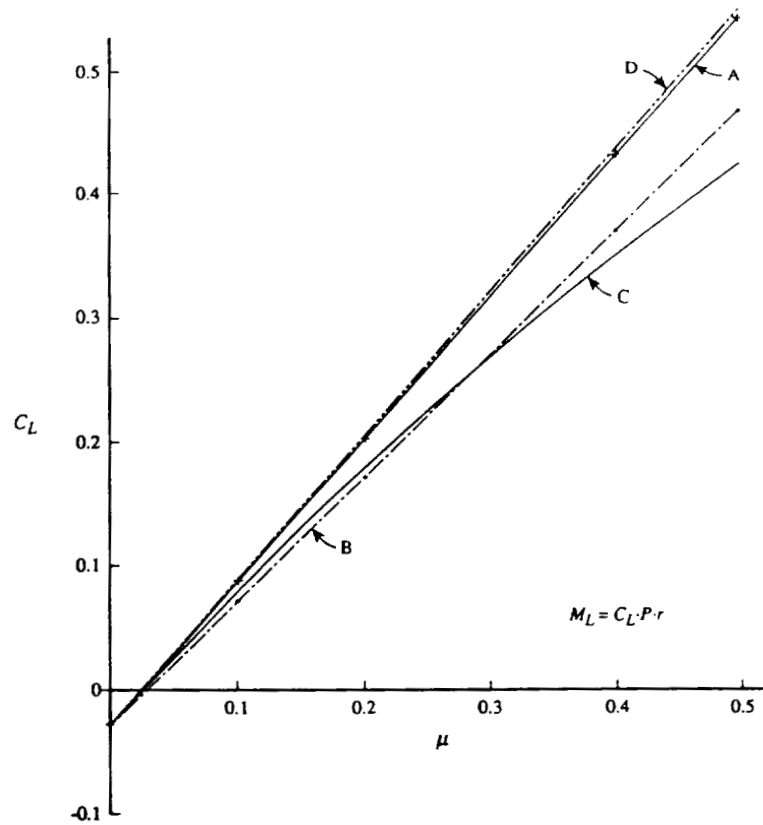

Figure 3.11 Comparative Plot of C_L Values vs. M for Various Thread Prediction Equations.

Also, an additional bolt/screw torque (M_H) is required to overcome friction forces developed under the bolt head or nut. These forces and resulting torque are as illustrated in Fig. 3.12.

$$F_H = \mu_H P_p$$

$$M_H \approx F_H \left(\frac{r_i + r_o}{2} \right) = F_H r_m \quad (3.27)$$

$$M_H \approx P_p r_m \mu_H \quad (3.28)$$

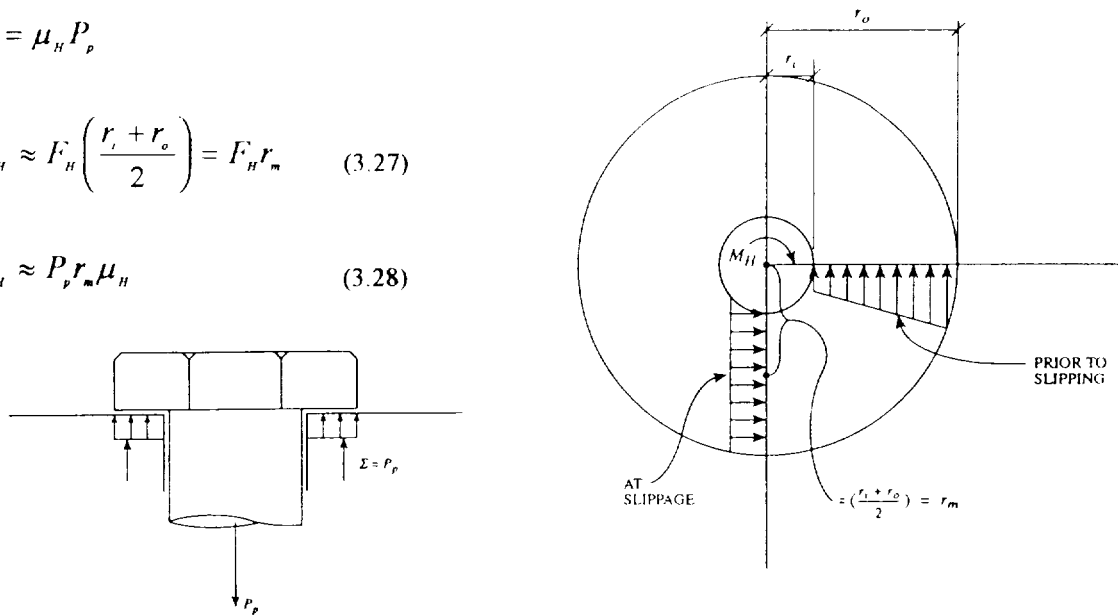

Figure 3.12 Forces and Torque to Overcome Bolt Head Friction.

For structural steel bolts as specified in Ref. (1), the ratios H/D and D/D_M are shown in Table 3.2. The variables H , D , and D_M are shown in Fig. 3.13.

Table 3.2 Dimensional Ratios for Structural Steel Bolts

D (in)	H (in)	H/D	D_M (in)	D/D_M
0.25	0.4375	1.75	0.220	1.14
0.50	0.75	1.50	0.453	1.10
0.75	1.125	1.50	0.689	1.09
1.00	1.50	1.50	0.924	1.08

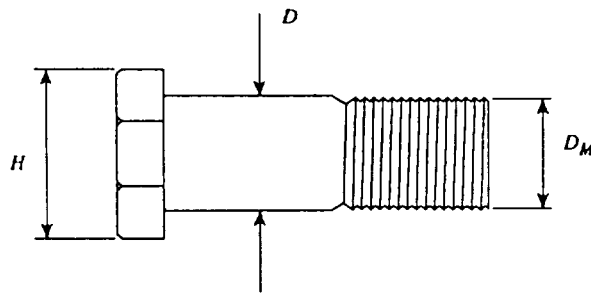

Figure 3.13 Structural Steel Bolt.

Based on Table 3.2, a H/D ratio of 1.5 and a D/D_M ratio of 1.10 are reasonable values to use to estimate the moment required to overcome friction forces under the bolt head/nut to loosen the bolt. These yield

$$r_o = 1.5r_i \quad (r_o \text{ and } r_i \text{ are defined in Fig. 3.12})$$

$$r_i = 1.10r_M$$

where r_M is the mean radius of the bolt threads and is the r used in the equations summarized in Table 3.1. Hence, from Fig. 3.12

$$r_{MH} \approx \frac{1.10r_M + 1.5(1.10r_M)}{2} = 1.375r_M \quad (3.29)$$

to allow for the facts that (1) r_{MH} in Fig. 3.12 is actually somewhat larger than $(r_o + r_i)/2$, and (2) there will be a clearance between the bolt edge and bolt hole, the value above should be increased by approximately 5%. This yields

$$r_{MH} \approx 1.45r_M \quad (3.30)$$

In turn, using Eqn. 3.28, this yields a moment required to overcome friction under the bolt head/nut of

$$M_H \approx 1.45\mu_H P_p r_M = 1.45\mu_H P_p r \quad (3.31)$$

where $1.45\mu_H = C = C_L = C_R$

Recall from Eqn. 3.24 that C_L used in determining the moment required to overcome bolt thread friction was approximately equal to μ . Hence,

$$M = C_l P_p r \approx \mu P_p r \quad (3.32)$$

If $\mu_H = \mu$ then

$$M_H = 1.45M \quad (3.33)$$

and is the dominant frictional moment to be overcome to loosen a bolt. Obviously,

$$M_{TOTAL} = M + M_H = (C_l + 1.45\mu_H) P_p r \quad (3.34)$$

$$M_{TOTAL} \approx (\mu + 1.45\mu_H) P_p r \quad (3.35)$$

Recalling that

$$P_p = \pi r^2 f \sigma_y \quad (3.36)$$

where f = fraction of σ_y employed.

one can see the primary parameters affecting bolt loosening under static loading based on the mechanics of threaded fasteners are

$$M_L^{static} \approx (\mu + 1.45\mu_H) (\pi r^2 f \sigma_y) r \quad (3.37)$$

or,

$$M_L^{static} \approx f_1 (r^3, \sigma_y, f, \mu, \mu_H) \quad (3.38)$$

where M_L varies in a linear manner with all parameters except for the bolt radius (or diameter), where it varies as the cube. Obviously, if a locknut of some type is used, M_L will be increased in direct proportion to the moment required to overcome the locking

device component of the locknut. Thus, the locknut device would be a major parameter in bolt loosening and,

$$M_L^{static} = f_2(r^3, \sigma_y, f, \mu, \mu_H, \text{locknut device}) \quad (3.39)$$

Additionally, looseness of the bolt/nut thread fit, i.e., the class of fit (CF), as well as bolt/bolt hole fit, i.e., the hole tolerance (HT), will affect bolt rocking, pinching, and micro impact loadings. These in turn will affect bolt loosening under vibrational loads.

Theoretical considerations indicate that thread angle α (see Fig. 3.7) is not an important parameter to static bolt loosening. However, it is related and similar to the class of fit, with fine threads corresponding to small clearances between the threads. Because vibrational loadings have the potential to bend bolts in the region of the threads and thus cause bolt rocking and pinching and inter thread movements, it is anticipated that fine threaded fasteners will perform in a superior manner under vibrational loadings. Additionally, fine threaded fasteners have root of thread areas approximately 15-25 percent larger than their course threaded counterparts. This allows 15-25 percent larger preloads and this would be quite significant in mitigating bolt loosening.

Lastly, the character, magnitude, and duration of vibrational loadings, along with the geometrical setting of the bolt sustaining these loadings should have major impacts on bolt loosening. Thus,

$$M_L^{vibration} = f_3(r^3, \sigma_y, f, \mu, \mu_H, \text{locknut device, CF, HT, } \alpha, \text{ vibrational load parameters, bolt setting/mode loading}) \quad (3.40)$$

3.4 Effects of Vibratory Loadings on Bolt Loosening

The primary effects of vibrational loadings on bolt loosening are probably the following:

- Possibly having the loading frequency coincide with a natural axial vibration frequency of the bolt.
- Possibly having the loading frequency coincide with a natural frequency of the structural assembly that the bolt is connecting.
- Possibly causing minute transverse thread sliding due (a) to load eccentricities and thus bolt rocking action, (b) bending in the connected parts, or (c) transverse impact loadings.

Each of these primary effects is discussed below.

1. Vibration at bolt natural frequency. A bolt's fundamental axis natural frequency can be estimated as indicated in Fig. 3.14. If the lower plate in that figure is positively connected to the nut, and the bolt is loose, i.e., without preload, then the mass of the plate should be lumped on the end of the bolt model in Fig. 3.14. This would cause the natural frequency to decrease drastically. However, if the connection is a typical one where the plates connected are not attached to the bolt, but the bolt is under a preload, then it would only be appropriate to lump the mass of the plate on the end of the bolt if in turn the axial stiffness (k) of the model in Fig. 3.14 is increased to the value indicated in Fig. 3.15. This would be the case since when the spring force cycles to "tension," the plate interfaces remain in contact and reduce the level of precompression, i.e., they act as a monolith. As indicated in Fig. 3.14, bolt axial

frequencies are very large, and it would be very rare that vibrational loadings on a bolted system would contain frequencies this high.

Axial impact loadings result in the propagation of a compression wave at very high velocity. Depending on the boundary conditions this wave could be reflected back and forth at frequencies of the same order as those of the bolt's natural frequencies. This is illustrated by the example in Fig. 3.16. Vibrations such as these could cause minute thread interface slippage or movements with each passage of the wave. This in turn would promote bolt loosening.

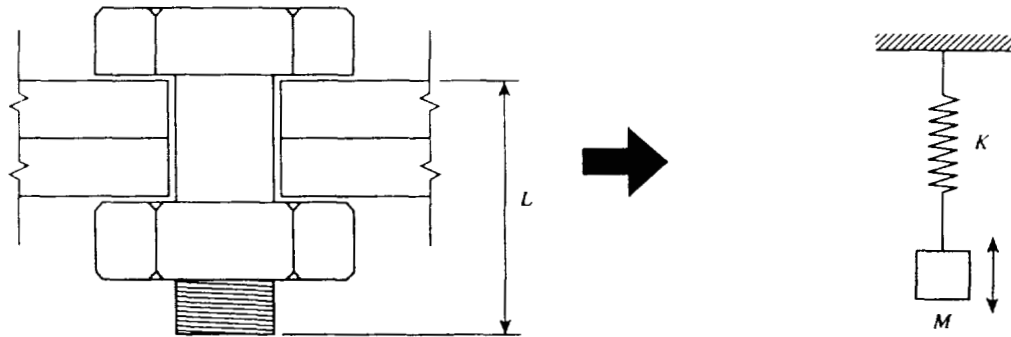

Figure 3.14 Modeling and Estimating Bolt Axial Fundamental Natural Frequency.

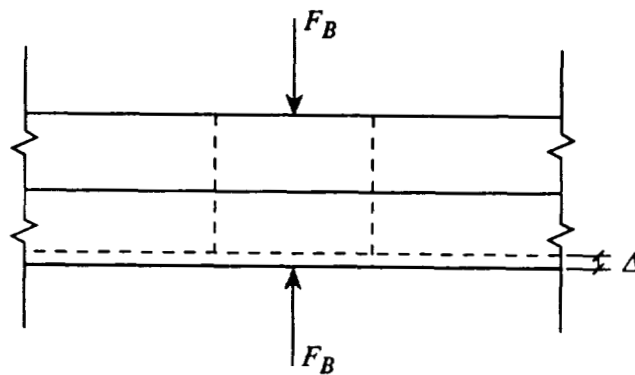

Figure 3.15 Axial Stiffness of Connected Plates.

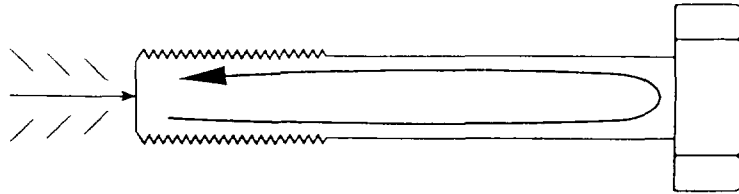

Figure 3.16 Axial Impact Loading Propagation.

2. Vibration at natural frequency of connected assembly. Vibrational loadings which coincide with a natural frequency on the bolted assembly cause resonant vibration of the assembly. These in turn result in large amplitude displacements and g-forces. It is expected that the build-up to large displacements and the ensuing bolt twisting or rocking action (discussed in the next section) in particular, create an environment which is conducive to bolt loosening. The direction or mode of vibration of the assemblage in conjunction with the bolt geometrical arrangement will dictate the type of loading actions on the bolts, i.e., axial, shear, twisting, bending/prying/rocking, as illustrated in Figs. 3.17 - 3.19. Obviously the type of loading will have a great impact on bolt loosening. The literature indicates that vibrations which induce forces transverse to the axis of the bolt are the most severe for inducing bolt loosening. Vibrations causing forces parallel to the axis of the bolt are not likely to induce loosening unless they induce bolt prying action and/or bolt rocking.

3. Transverse sliding. Haviland (13) presents an excellent discussion of the loosening tendency of bolted joints due to transverse sliding. The discussion and illustrations presented below are a shortened and modified version of that presented by Haviland.

All bolts and nuts are made with a clearance between them to assure easy assembly. This means that the bolt/nut can be moved sideways. Recall that the helical thread is an inclined plane with the nut sitting on it, held against sliding by friction. The effects of a sideways movement on an inclined plane can be illustrated by placing a small pad on the side of a slippery book as indicated in Fig. 3.20. Now, tip the book upwards until the pad almost slides and try to slide the pad sideways with your finger. The pad slides downhill every time it is pushed sideways. It is not necessary to push the pad downhill due to the fact that its weight moves the pad in that direction. This is what happens to a loaded thread made to slide sideways.

Additionally, a side-sliding thread has a ratcheting action. Consider a cross section through the centerline of a bolt and nut as illustrated in Fig. 3.21. As the nut is moved into the page, the right side is moving uphill and the left downhill. Obviously, the uphill side will move with greater difficulty and acts as an anchor around which the nut rotates on the left side. If pulled from the page, the left side becomes the anchor and the right side rotates downhill. The net effect is small unwinding motions each time the nut is cycled sideways.

Shear or side sliding is a common phenomena for bolted assemblies. It can be caused by bending of the assembly as illustrated in Figs. 3.17 - 3.19, by differential thermal expansions of the assembly, by shock or impact loadings such as indicated in Fig. 3.22, and by numerous other manners. It should be noted that the higher the clamping force, the less likely there is to be side movement; but if side down movement occurs, the bolt preload force will unwind the threads.

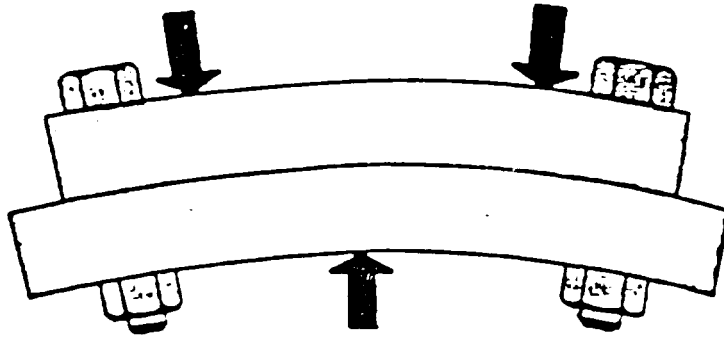

Figure 3.17 Transverse Bolt Loading Through Assemblage Bending (13).

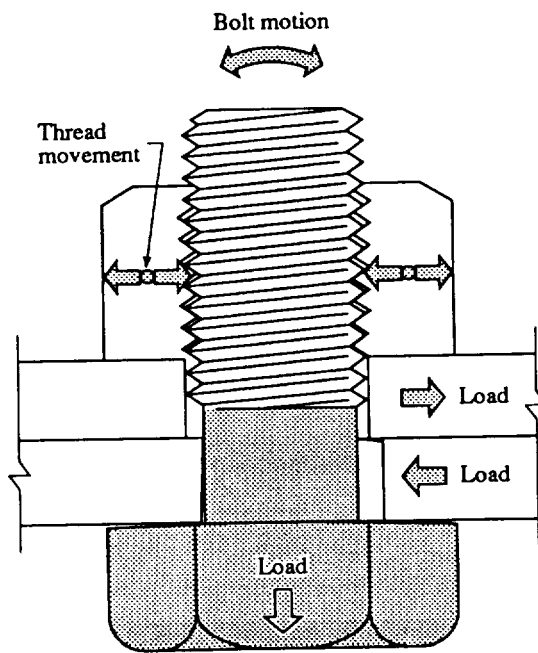

Figure 3.18 Bolt Rocking Motion (13).

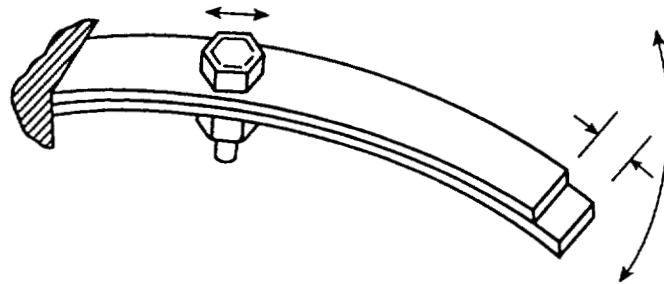
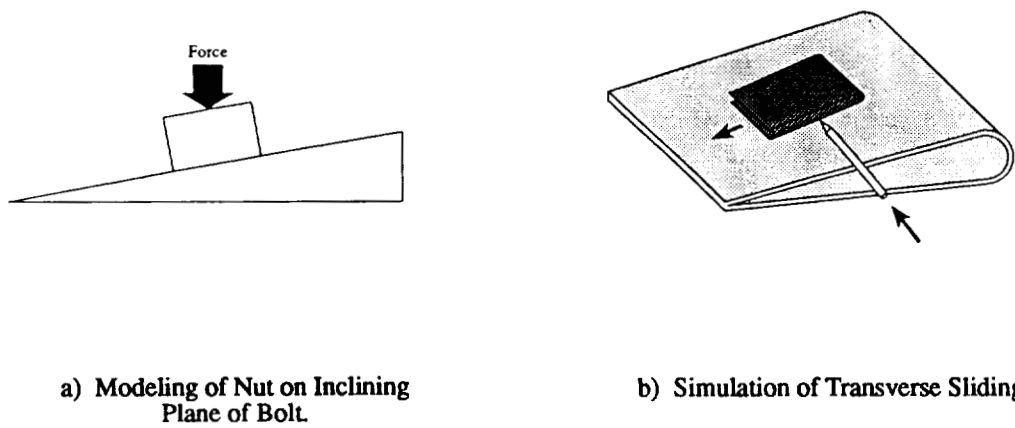

Figure 3.19 Cantilever Beam of Two Flat Bars Bolted Together (19).



a) Modeling of Nut on Inclining Plane of Bolt.

b) Simulation of Transverse Sliding.

Figure 3.20 Modeling of Bolt/Nut as Inclined Plane and Transverse Sliding (13).

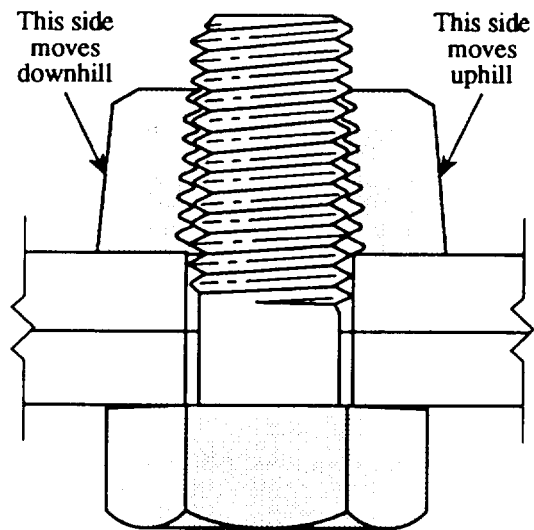

Figure 3.21 Ratcheting Action of a Side Sliding Thread (13).

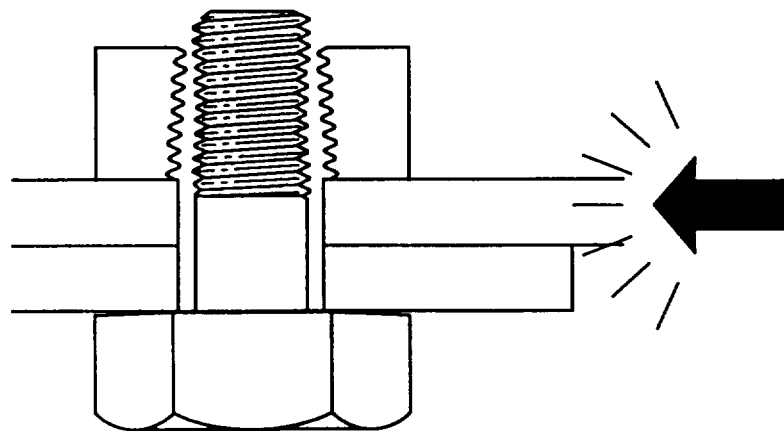

Figure 3.22 Transverse Shock Loading (13).

3.5 Primary Parameters Affecting Bolt Loosening

There are probably 80-100 parameters that have some impact on bolt loosening. The entire range of all these parameters could not be explored in this experiment. Through literature review, theoretical considerations, discussions and meetings with select personnel of MSFC, and engineering judgment the parameters that were felt to be dominant were identified. These parameters were investigated in this study in order to identify their degree of contribution to bolt loosening. Each parameter tested in this experiment is listed below along with a brief explanation for its selection.

1. Bolt size (diameter): Fatigue resistance decreases with increasing diameter (8). Vibration resistance may exhibit the same relationship. Theoretical considerations (see Eqns. (3.39) and (3.40)) indicate bolt loosening moments vary with the cube of the bolt radius.

2. Lubrication on bolt: Lubrication on the bolt threads causes the coefficient of friction between bolt and nut threads in contact to be reduced, thus causing the bolt's resistance to loosening to be decreased.

3. Hole tolerance: The tighter the tolerance on the hole in a bolted connection, the less likely loosening is to occur within that connection.

4. Initial pre-load: An increase in preload causes an increase in vibration resistance (9).

5. Locking device: A nut which has a locking device is less likely to loosen than a nut that does not have a locking device.

6. Grip length: The longer a bolt's grip length, the more likely the bolt will experience bending deformations, thus reducing the bolt's capability to maintain its

preload. There are conflicting reports in the literature on the effect of this parameter. For longer bolts, it appears that bending and possibly fatigue occurs rather than loosening.

7. Thread pitch: The steeper the angle of the bolt threads, the less likely the bolt will be able to maintain friction between contacting threads of the bolt and nut, thus the less likely the bolt will be able to resist vibration (18). Also, fine threads allow larger preload and this should mitigate bolt loosening.

8. Lubrication between mating materials: Lubrication between the mating materials causes the coefficient of friction between contacting surfaces to be reduced, thus causing the joint's resistance to loosening to be reduced.

9. Class of fit: There is always some clearance between the threads of the nut and bolt to assure easy assembly (13). Class of fit dictates how much clearance is between threads. The less clearance between threads, the greater the resistance to loosening the connection will have.

10. Joint configuration: Two different test configurations were used in order to employ as many different joint assemblies as possible.

11. Mass of configuration: As the mass that a bolt must clamp down increases, the inertia forces that the bolt must resist under dynamic loading increases as well, thus increasing the probability that the bolt will loosen.

In addition to the design parameters listed above, there will be several noise parameters (see Section 4.2) implemented in the experiment. Each noise parameter is listed along with an explanation for its selection.

1. Vibration direction: Both the axial and transverse (in relation to the axis of the bolt) directions of vibration were used in order to explore the effect of vibration direction on loosening.

2. Magnitude/Level of vibration amplitude: Two different g-levels were used in order to explore the effect of amplitude on loosening. As previously indicated, frequency of vibration affects bolt loosening, and both resonant and random vibrations were explored during preliminary testing. Because the preliminary testing indicated greater bolt loosening with random vibrations, and because these vibrations were considered to be more representative of actual flight conditions, this parameter was held constant, i.e., at random vibrations for all tests. Duration of vibrations also affect bolt loosening. Because of the short duration during flight in which significant vibration levels are experienced, this parameter was held constant at 2 minutes for all tests. This is approximately 3 or 4 times actual vibration durations experienced during flights.

As previously noted, these parameters do not cover every possible parameter that could contribute to bolt loosening. However, the parameters chosen for this experiment are those that are believed to contribute the most to bolt loosening.

IV. DESIGN OF EXPERIMENT AND EXPERIMENTAL TESTING PROGRAM

4.1 General

In this chapter, a description of the experimental design techniques used in the project is provided. Also provided is a discussion of the test parameters, a discussion of Taguchi methods, a presentation of the test matrix, a description of the equipment, test specimens, and testing program, and a discussion of additional testing conducted.

4.2 Experimental Test Parameters and Values

The design and loading/noise parameters listed in Section 3.5 were selected for experimental testing in this investigation. To keep the testing program within reasonable time and financial limitations, only two values of each test parameter were utilized. For each parameter, the 2 values selected should ideally be the upper and lower limits of values that could be expected in practice. However, because of availability of products or cost limitations, some parameter values used were not the limiting values. Design and load/noise parameters and values used in the experimental testing are summarized in Table 4.1. It should be noted that some of the experimental testing parameters and values were not finalized until after preliminary testing was performed. The vibration amplitude was the only final parameter that was varied in the testing program, which fell into this category. However, vibration signature, i.e., resonant or random vibration was finalized

after preliminary testing and it was decided to perform all testing under random vibration loadings. The vibration duration of 2 minutes was also finalized after preliminary testing.

Table 4.1 Test Parameters and Values

Test Parameters	Load/Noise Parameters	Parameter Values	
		#1(lower values)	#2(upper values)
Bolt Size		1/4" ϕ	3/4" ϕ
Lubrication on Threads		None	Tri-Flow
Hole Tolerance		Oversized Fit	Tight Fit
Bolt Preload		40% P_y	80% P_y
Locking Device		Plain Nut	Self-Locking Nut
Grip Length †		1/2" , 1"	1" , 2"
Thread Pitch ‡		20 , 10	28 , 16
Lubrication on Mating Parts		None	Tri-Flow
Class of Fit		2	3
Joint Configuration		Eccentric	Concentric
Mass of Configuration		Mass of Specimen	Mass of Specimen + Additional Mass
	Vibration Direction	Axial	Transverse
	Vibration Amplitude	27 grms	40 grms

† 1/2" - 1" for 1/4" ϕ bolts and 1" - 2" for 3/4" ϕ bolts.

‡ 20 - 28 for 1/4" ϕ bolts and 10 - 16 for 3/4" ϕ bolts.

4.3 Taguchi Methods

When conducting experiments, it is imperative that the procedures used to carry out the experiment and the results obtained from the experiment can be reproduced. Also, it is important to conduct a cost efficient experiment. Dr. Genichi Taguchi has developed a set of techniques that implement statistics and engineering knowledge to meet these criteria. The principle contribution of Taguchi methods to this investigation is the concept

of the orthogonal array. In an orthogonal array, the relationship of the factors under investigation is such that for each level of any one factor, all levels of the other factors occur an equal number of times. This allows the effects of one particular factor under investigation to be separable from the effects of the other factors. The orthogonal array also allows the experiment to render a maximum amount of data with a minimum amount of testing. All combinations of all factors are not required to be tested, making the experiment cost efficient.

According to Taguchi, there are two different types of parameters that can be explored; design parameters and noise parameters. Design parameters are those parameters which the designer has control over. Noise parameters are those parameters that the designer has no control over (22).

4.4 Test Matrix

In this experiment, there were eleven design parameters to be tested as well as two noise parameters (see Section 3.5 and/or Table 4.1). Using Taguchi's orthogonal arrays (25) an L_{12} array was determined as the most beneficial array to use for the experiment. The L_{12} is a specially designed array that is used to determine only the main effects of the parameters. No interactions between the parameters are explored. This allows the experimental data to reveal which parameters contribute to loosening and the relative extent of their contributions. Where feasible, each design parameter and noise parameter had an extreme high and low level as indicated earlier. This was done in order to bound any loosening that might occur within these extreme levels. Each combination of design parameters, as dictated by the L_{12} array, was tested using both levels of both load/noise

Test Set-Up	Fastener Size (Diameter)	Lubrication on Threads	Hole Tolerance (A)	Initial Pre-Load (% Yield)	Locking Device (B)	Grip Length (in.)	Pitch (threads/in.)	Lubrication on Mating Mils	Class of Fit	Joint Configuration (C)	Mass of Configuration (D)	Random Vibration			
												Axial Direction		Trans Direction	
												Low g-Level	High g-Level	Low g-Level	High g-Level
1	1/4"	None	OF	0.4	PN	0.5	20	None	2	A	X				
2	1/4"	None	OF	0.4	PN	1.0	28	Tri-Flow	3	B	Y				
3	1/4"	None	TF	0.8	SL	0.5	20	None	3	B	Y				
4	1/4"	Tri-Flow	OF	0.4	SL	0.5	28	Tri-Flow	2	A	X				
5	1/4"	Tri-Flow	TF	0.8	SL	1.0	20	Tri-Flow	2	B	Y				
6	1/4"	Tri-Flow	TF	0.8	PN	1.0	28	None	3	A	X				
7	3/4"	None	TF	0.8	PN	1.0	16	Tri-Flow	2	B	X				
8	3/4"	None	TF	0.8	SL	2.0	16	None	2	A	Y				
9	3/4"	None	OF	0.4	SL	2.0	10	Tri-Flow	3	A	X				
10	3/4"	Tri-Flow	TF	0.8	PN	1.0	10	Tri-Flow	3	A	Y				
11	3/4"	Tri-Flow	OF	0.4	PN	2.0	10	None	2	B	Y				
12	3/4"	Tri-Flow	OF	0.4	SL	1.0	16	None	3	B	X				

- A OF= Oversize Fit
TF= Tight Fit
- B PN= Plain Nut
SL= Self Locking Nut
- C A= Eccentric Joint Configuration
B= Concentric Joint Configuration
- D X= Small Mass
Y= Large Mass

Figure 4.1 Test Matrix.

parameters. Also, each test was repeated to give the data statistical credence and to gain some measure of repeatability and experimental error. The test matrix employed is shown in Fig. 4.1.

4.5 Test Set-up

Small aluminum test specimens were mounted on a generic 22" mounting cube. This cube in turn was mounted on one of the shake tables in the Structural Testing Laboratory at MSFC. The two directions of vibration used in testing are shown in Fig. 4.2. To achieve vibration in the axial direction of the bolt, the test specimen was mounted on the top of the 22" cube and the shaketable applied vibration in the vertical direction. To achieve transverse vibration, the test specimen was mounted to

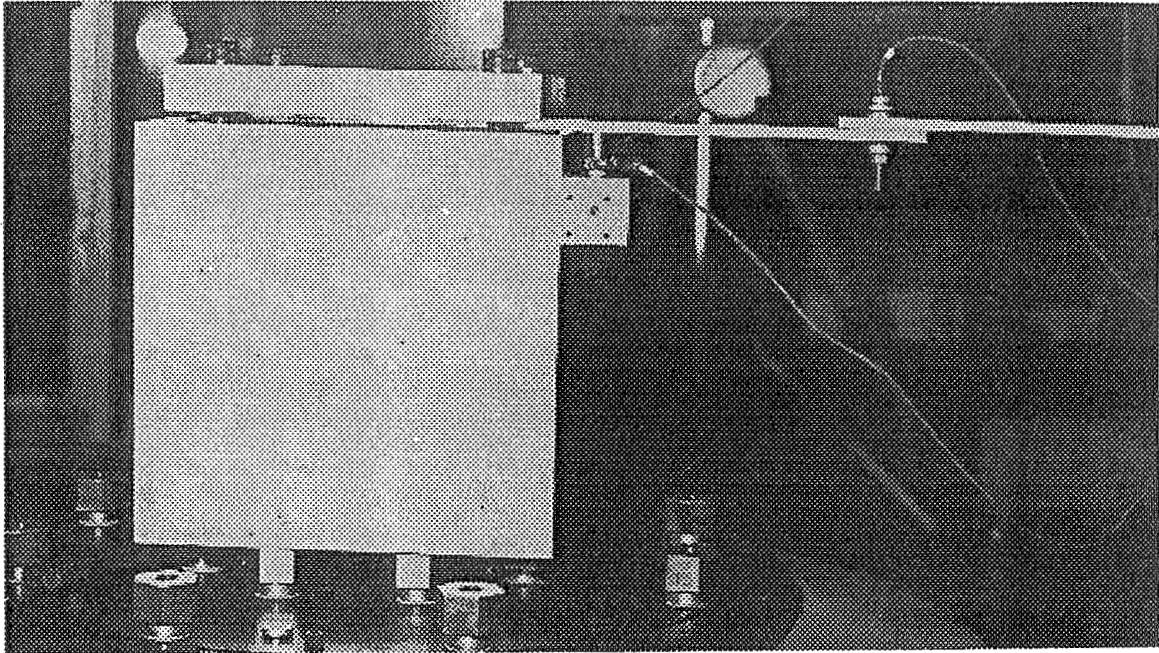

(a) 2-Piece Cantilever Vibrated in Axial Direction

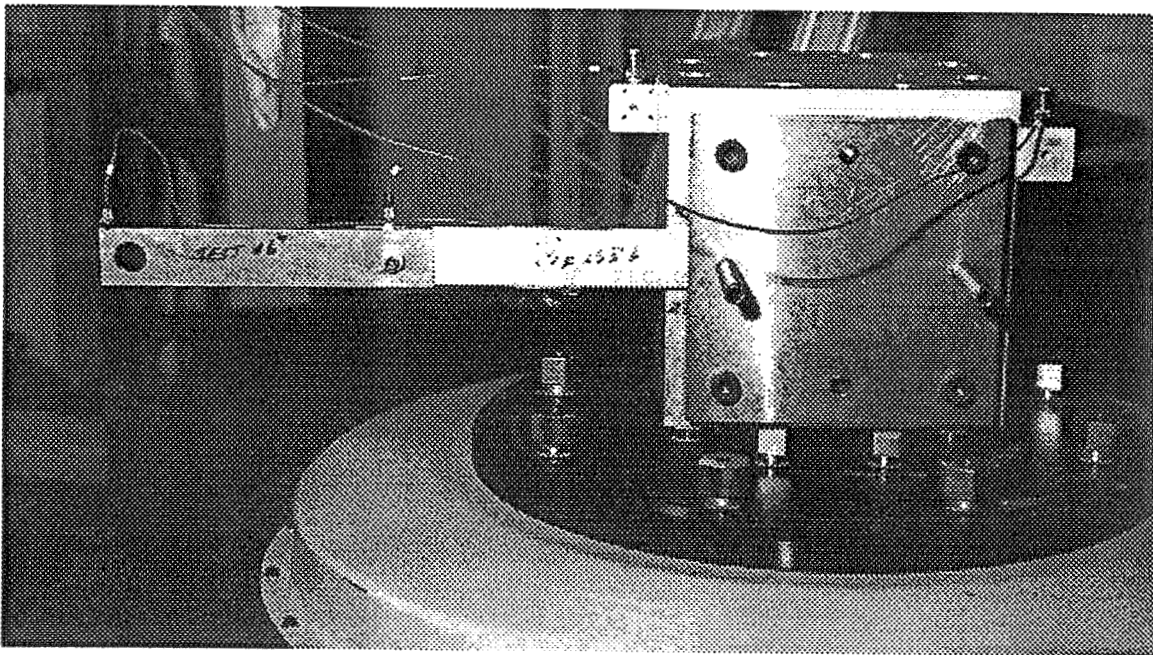

(b) 2-Piece Cantilever Vibrated in Transverse Direction

Figure 4.2 Photographs of Typical Test Set-ups¹.

¹Please note that both 1/4" and 3/4" bolts were used in testing, but only the 1/4" bolts are shown in Fig. 4.2.

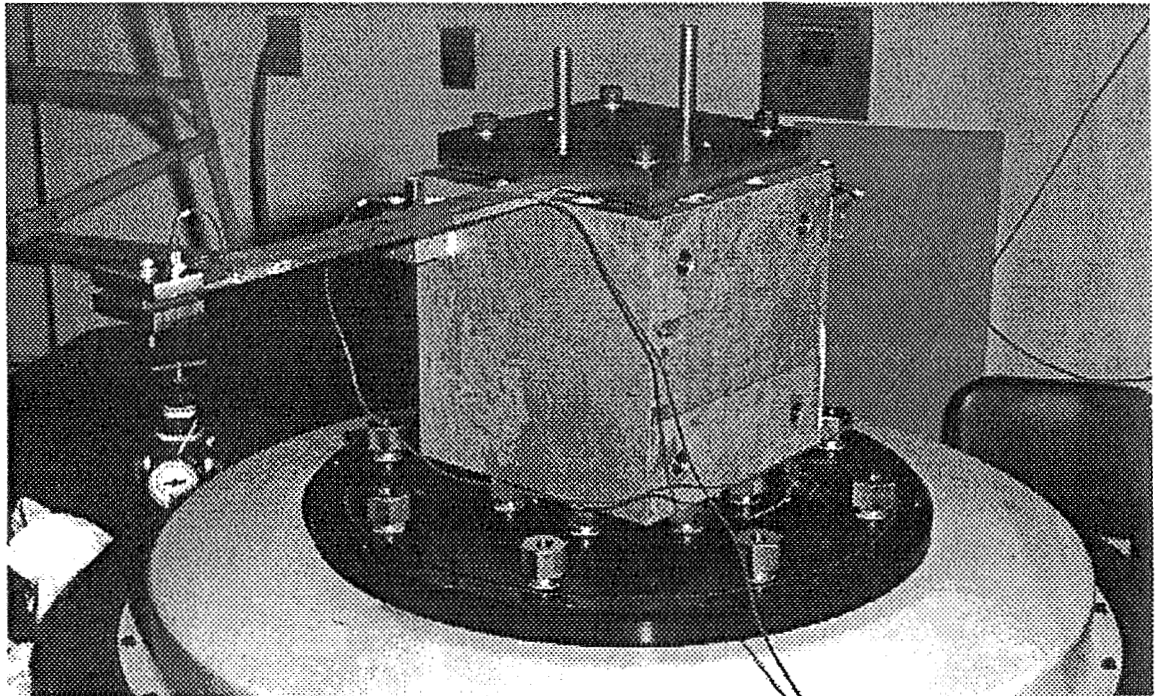

(c) 1-Piece Cantilever Vibrated in Axial Direction

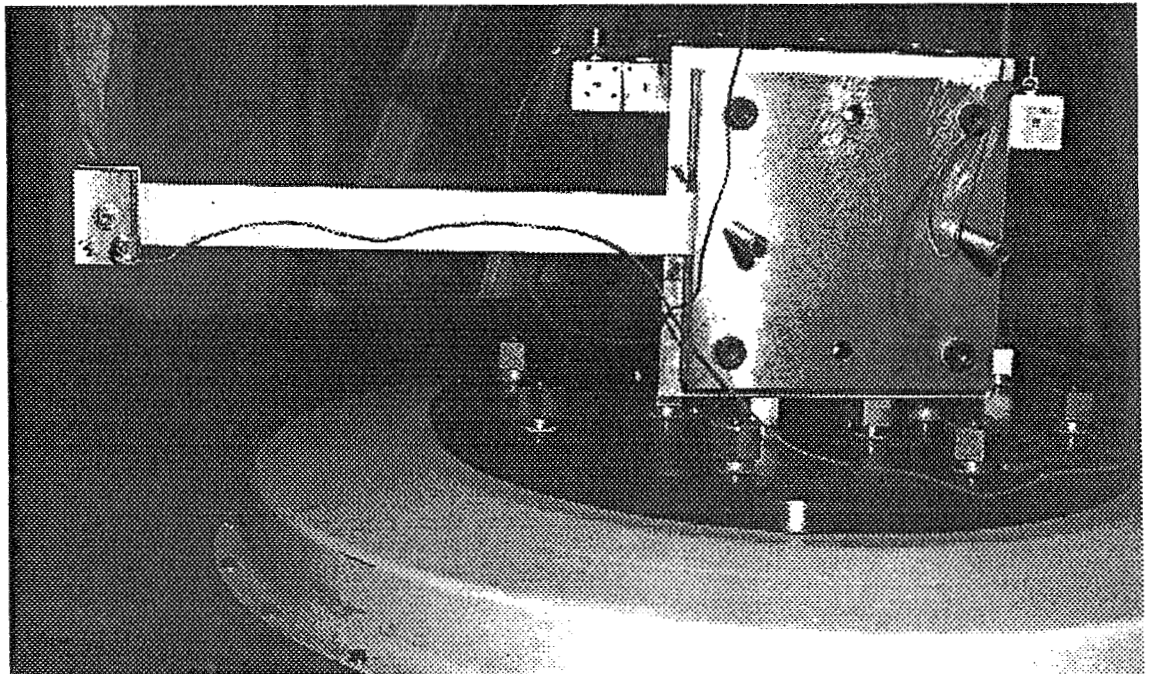

(d) 1-Piece Cantilever Vibrated in Transverse Direction

Figure 4.2 (cont.) Photographs of Typical Test Set-ups.

the side of the 22" cube while the shaketable vibrated in the same vertical direction. Photographs of typical test set-ups are shown in Fig. 4.2.

It should be noted that it was originally planned to use load cell washers to measure initial bolt load and bolt load after vibration testing. However, preliminary testing resulted in malfunctioning of the load cell washer after vibration and this set-up and means of monitoring loss of preload had to be aborted. In its place, it was decided to measure the test bolt length prior to preloading, after preloading but before vibration testing, and after testing as a means of monitoring bolt preload and loss of preload. Precision micrometers were used in making these measurements and this method was employed in executing the test matrix of Fig. 4.1. As an alternate or backup in determining bolt loads and loosening, nut on-torque and off-torque were measured in the test set-ups. These data were used to estimate bolt load and thus loss of preload or extent of bolt loosening.

A test set-up sheet for each of the 12 set-ups is provided in Appendix A. These sheets show the test specimen and joint configuration for each set-up and the values of the test parameters for the set-up.

4.6 Test Specimens

The test specimens used in this experiment were one piece and two piece cantilevers, as shown in Fig. 4.3 and 4.4. The dimensions of the cantilever specimens were different based on the diameter of the bolt to be tested by the specimen. This was done in order to keep the load on the 1/4"φ bolt proportional to the load on the 3/4"φ bolt based on the ratio of the two bolt areas, i.e.,

$$\text{Ratio of bolt areas: } \frac{\frac{\pi}{4} \left(\frac{1}{4} \right)^2}{\frac{\pi}{4} \left(\frac{3}{4} \right)^2} = \frac{1}{9}$$

$$\text{Ratio of bolt loads: } \frac{1/4" \text{ load}}{3/4" \text{ load}} = \frac{\% \sigma_y A_s}{\% \sigma_y A_l} = \frac{1}{9}$$

The smaller specimens (PS series) were used with the 1/4"φ bolts and the larger specimens (PL series) were used with the 3/4"φ test bolts. Likewise, different sets of lumped masses were used with different bolt sizes. Test set-ups 1-6 employed the 1/4"φ bolts and the smaller test specimens. Set-ups 7-12 employed the 3/4"φ bolts and larger specimens.

The two piece cantilever configuration is designed to introduce axial load and a prying action on the bolt when vibrated in the bolt's axial direction and shear and torsion is induced when vibrated in the bolt's transverse direction. The one piece cantilever configuration introduces axial load in the bolt when vibrated in the axial direction, and shear when vibrated in the transverse direction. Additional masses were used to achieve the desired mass of configuration and grip length desired when necessary.

All test specimens are made of 6061-T6 aluminum and all additional masses were made of A36 steel. They were fabricated by the machine shop at MSFC. Design/fabrication drawings were provided by the authors and a copy of these is provided in Appendix B. Also included in that appendix is a listing of the bolts and nuts used in the testing. All were commercial grade fasteners.

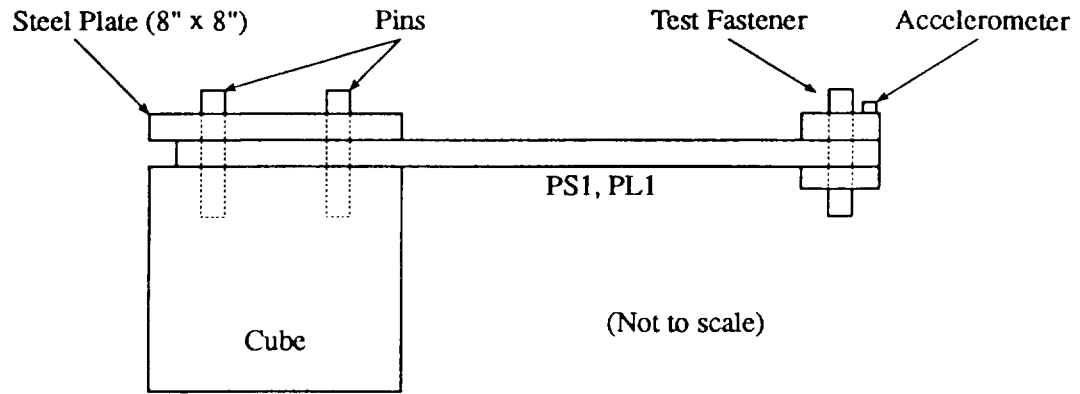

Figure 4.3 Typical One Piece Cantilever.

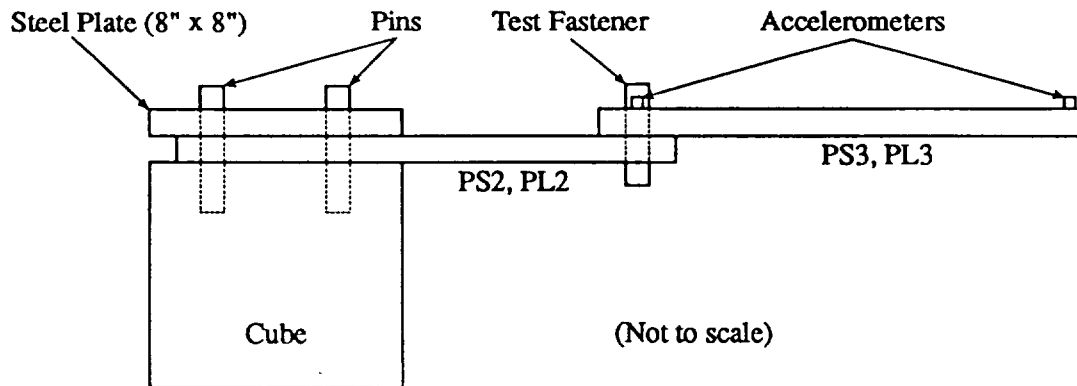

Figure 4.4 Typical Two Piece Cantilever.

4.7 Test Equipment and Instrumentation

The following is a description of the equipment used to carry out the testing as prescribed by the test matrix.

1. MT Ling Model B-335MS vibration machine
2. 382 Hewlett Packard computer
3. 35650 analog-to-DC and DC-to-analog converter and input modulus
4. LMS CADA-X version 2.8 software
5. UD amplifier 660
6. Endevco control accelerometer model 2213-E
7. Endevco response accelerometer model 2226
8. Endevco charge amplifier model 2735
9. Sony recorder PC116
10. Consolidated Services torque wrench model 2503DF (for 3/4" ϕ bolts)
11. Consolidated Services torque wrench model 6002DI (for 1/4" ϕ bolts)
12. Links Micrometer Models 90-2646 (1" - 2"), 90-0150 (2" - 3"),
90-0490 (3" - 4"), 90-0120 (4" - 5")
13. StressTel Version 1.3 BoltMike

4.8 Testing Program

The testing program consisted of conducting the following testing in the sequence indicated.

- Preliminary Testing
- Execution of Test Matrix (Fig. 4.1)
- Static On-Torque and Off-Torque Testing
- Confirmation Testing

- Additional Testing

Each of these are described in the subsections below.

4.8.1 Preliminary Testing

Preliminary testing consisted of several experiments that were intended to indicate the proper vibrational loads to use in the actual testing as well as to finalize values for several test parameters. Tests were run on 1/4" ϕ bolts. This was done because it was felt that the 1/4" ϕ bolt would loosen more readily.

Several different one piece and two piece cantilevers, with and without masses attached, were subjected to sinusoidal and random vibrations in order to determine the optimum vibrational load for bolt loosening. The only loosening that occurred during this testing was due to random vibration. Originally, a g-level of 60 grms was to be used for Level 2 in actual testing, but this proved to be too severe and fatigue problems in the test specimen arose. For this reason a g-level of 40 grms was chosen for Level 2.

As previously noted, time of duration for each test was based on the actual time a piece of hardware would experience vibration in flight with some factor of safety. Thus, time of duration for each test was set at 2 minutes. In preliminary testing, this time duration did not present fatigue problems for the test specimen, and thus was deemed acceptable.

4.8.2 Execution of Test Matrix

The test matrix shown in Fig. 4.1 required 12 different test set-ups, and for each set-up 8 different tests were performed (2 vibration directions, 2 vibration g-levels, and 1 replication test of each set of parameters). Each of the 12 different test set-ups is listed in

detail in Appendix A, and the 8 tests performed on each set-up are identified as tests a through h in Table 4.2.

Table 4.2 Test Set-ups

[†] Test	Vibration Direction	g-level
n a	Axial	1
n b	Axial	1
n c	Axial	2
n d	Axial	2
n e	Transverse	1
n f	Transverse	1
n g	Transverse	2
n h	Transverse	2

[†] n indicates set-up 1-12.

The following test procedure was used in each of the 96 tests conducted in executing the program test matrix.

1. Secure a new bolt and nut for the test.
2. Clean test specimen, bolt, and nut with an alcohol solution to insure that no grit was present between mating parts.
3. The test configuration was assembled as prescribed by the test matrix.
4. For Configuration 1, one accelerometer was mounted at the test bolt, as shown in Fig. 4.4. For Configuration 2, two accelerometers were mounted at the test bolt and at the end of cantilever respectively, as shown in Fig. 4.3.
5. The untorqued bolt length was measured and recorded.

6. The torque required to produce the desired bolt load was applied, measured, and recorded.
7. A sine sweep (10 - 1000 Hz 0.25 g_{pk} , 2 oct/min) was performed in order to determine the configuration's first mode of natural frequency.
8. The test configuration was vibrated for 20 seconds using Level-1 in order to burnish the pieces to insure that any settlement between mating materials will not contribute to any preload loss.
9. The configuration was subjected to the load parameters as prescribed by the test matrix.
10. The change in bolt length and the torque required to loosen the nut were measured and recorded.

4.8.3 Static On-Torque and Off-Torque Testing

On-torque is the torque required to achieve a desired bolt preload (tightening). Off-torque is the torque required to achieve first slippage between the bolt and nut (loosening). In the testing performed, on-torque was measured before vibration and off-torque was measured after vibration in order to measure any loosening that took place during vibration. These on-torque vs. off-torque values can be compared to values taken for bolts that have experienced no vibration. The difference in the two averages can be attributable to loosening. Static on-torque and off-torque tests were performed in order to make these comparisons.

Each set-up as prescribed in the test matrix was used in order to measure on-torque and off-torque on the bolt with no vibration. In each test, a bolt was torqued to the on-torque value used in the vibration testing and then immediately untorqued. The on-torque and off-torque values were recorded. This process was repeated twice more on a

particular bolt for a total of three on-torque and off-torque measurements per bolt. Three bolts were used for each set-up. It should be noted that the bolts and nuts used in this testing were the same ones used in the vibration testing, i.e., they were all "once used" bolts/nuts.

4.8.4 Confirmation Testing

The data from executing the program test matrix was analyzed in the manner described in Chapter V. Results of this comprehensive analysis revealed many things including whether each of the 11 design parameter's high and low values had a favorable or unfavorable effect on bolt loosening. Based on these results, two confirmation tests were derived. The first test grouped all parameter levels that would be unfavorable to bolt loosening, as shown in Table 4.3. The set-up was vibrated in the axial and transverse direction and at the low and high g-level in each direction, resulting in 4 runs for the test 1 set-up. The second test grouped all parameter levels that would be favorable to bolt loosening, as shown in Table 4.4. This set-up was also vibrated in the axial and transverse direction and at the low and high g-level in each direction, resulting in 4 runs for the test 2 set-up. It should be noted that no repetitions were run in this phase of testing and that all bolts used were also used in previous testing. The procedure that was used to carry out the confirmation testing was the same as described in Subsection 4.8.2 with one exception. At the end of the vibration testing for each run, the static on-torque and off-torque testing was conducted while the specimen was still mounted on the shaketable.

Table 4.3 Confirmation Test 1 Set-up

<u>Parameter</u>	<u>Value</u>
Diameter	3/4"
Lubrication on threads	Tri-Flow
Hole tolerance	Tight
Locking device	Nylon insert
Grip length	2"
Pitch	16 threads/in.
Lubrication on mating mtl.	Tri-Flow
Class of fit	3
Joint configuration	Concentric
Mass of configuration	Mass of specimen+M4 (small mass)

Table 4.4 Confirmation Test 2 Set-up

<u>Parameter</u>	<u>Value</u>
Diameter	1/4"
Lubrication on threads	None
Hole tolerance	Oversize
Locking device	None
Grip length	1"
Pitch	20 threads/in.
Lubrication on mating mtl.	None
Class of fit	2
Joint configuration	Eccentric
Mass of configuration	Mass of specimen+M1 (large mass)

4.8.5 Additional Testing

Based on the data obtained from carrying out the testing prescribed by the test matrix, it was determined that additional testing must be performed. The following factors contributed to the need for more testing:

1. A more accurate method for measuring bolt load was needed. Simply measuring the change in bolt length with a micrometer was difficult to measure on an accurate and consistent basis. Off-torque was inconsistent as well.
2. The lubrication used (Tri-flow) was not effective in providing adequate lubrication between the two plates of the test configuration. As a result, once slippage started between the two plates, microwelding occurred which prohibited any further slippage. Without slippage possible, the loosening characteristics of the bolt being tested could not be evaluated.
3. An error was made in estimating bolt load. Originally, 40% and 80% of the yield strength of the bolt was to be used as the initial bolt loads. The ultimate strength was erroneously used in calculating bolt loads, and as a result, the bolts tested were severely overloaded.
4. The vibrational loadings imposed on the test specimens did not result in significant bolt loosening.

In order to measure the load on the bolt more accurately, an ultrasonic measuring device was used (BoltMike). The BoltMike sends an ultrasonic wave through the bolt by placing a transducer on the head of the bolt as shown in Fig. 4.5. The time of travel of the sound wave is measured and based on the material properties of the bolt, the bolt length can be obtained. Also, by inputting the cross-sectional area and effective length of the bolt (shown in Fig. 4.6), the BoltMike was able to determine any load on the bolt based on change in length.

To minimize microwelding between the two plates of the test configuration, a mixture of molybdenum disulfide and axle grease (moly-lube) was used. Moly-lube is more viscous and cohesive than Tri-flow and thus can provide better lubrication,

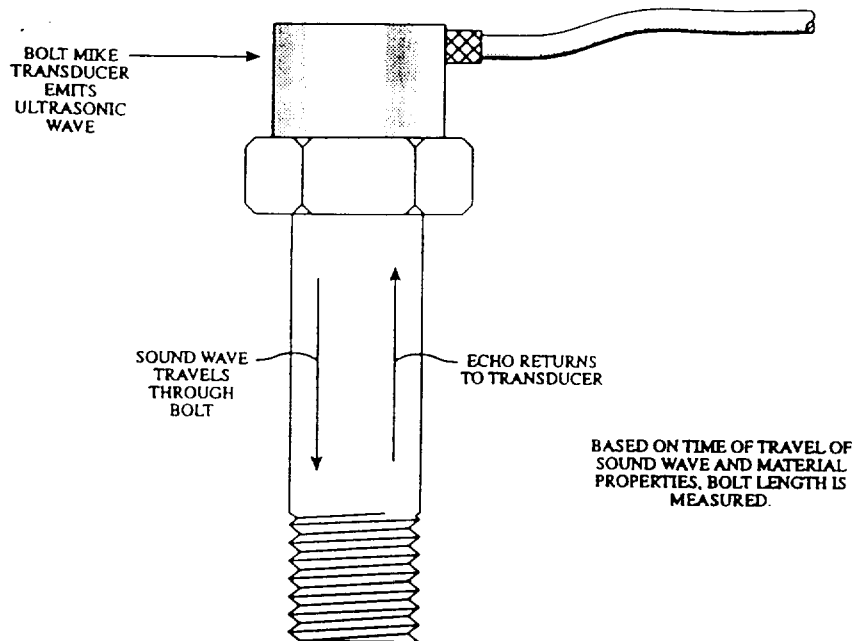

Figure 4.5 Ultrasonic Measurement of Bolt Length.

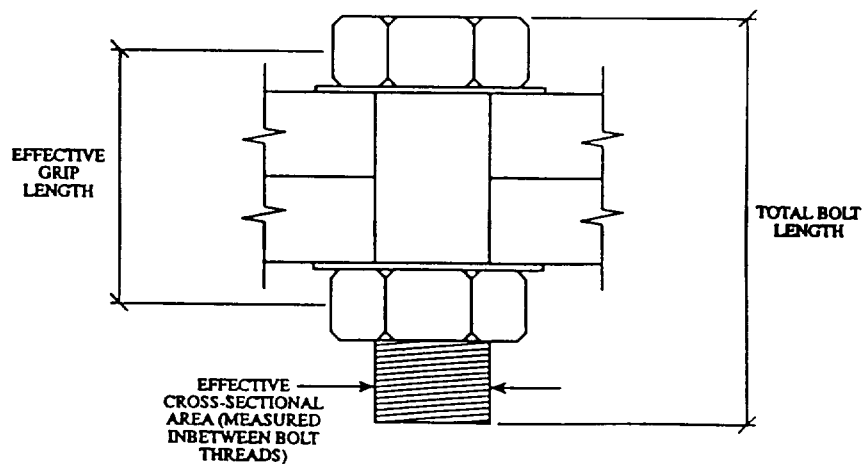

Figure 4.6 Input Dimensions for BoltMike.

especially at higher clamping forces. Also, the contact surfaces of the plates were planed and sanded as flat and smooth as possible to help reduce microwelding. A yield strength of 30 ksi was used for all bolts to calculate bolt preload.

In addition to adjusting the values of some of the design parameters, the vibration loading conditions were made more severe. The duration of the vibrational loadings were doubled (from 2 minutes to 4 minutes) in the additional testing.

The only parameters that were varied in the additional testing were bolt diameter, lubrication, and bolt preload. All other parameters were held constant resulting in 8 different test set-ups for a complete factorial testing (all combinations of the 3 parameters and 2 levels). The values for all parameters can be seen in Tables 4.5 and 4.6. It should be noted that lubrication in these tests indicates lubrication on both the threads and mating materials. Each set-up was vibrated in the axial and transverse direction for 4 minutes at the high g-level resulting in a total of 16 tests. The following steps were followed for each test.

1. Clean test specimen, bolt, and nut with an alcohol solution to insure that no grit was present between mating parts.
2. The test configuration was assembled as prescribed Table 4.5 or 4.6.
3. Accelerometers were mounted at the test bolt and at the end of the cantilever as shown in Fig. 4.4.
4. The untorqued bolt length was measured with the BoltMike and recorded.
5. Torque was applied to the bolt. While monitoring the bolt load with the BoltMike, the desired preload was applied.
6. A sine sweep (10 - 1000 Hz 0.25 g_{pk} , 2 oct/min) was performed in order to determine the configuration's first mode of natural frequency.

7. The test configuration was vibrated for 20 seconds using Level-1 in order to burnish the pieces to insure that any settlement between mating materials will not contribute to any preload loss.
8. The configuration was subjected to Level-2 for 4 minutes or until loosening occurred.
9. The final bolt load was measured with the BoltMike and recorded.
10. The torque required to loosen the nut was measured and recorded.

Table 4.5 Test 1-4 Set-ups for Additional Testing

Constant Values		Variable Values	
Parameter	Value	Parameter	Values
Diameter	1/4"	Lubrication:	All parts
Hole tolerance	Oversize		None
Locking device	None		
Grip length	1.5"	Preload:	40% P_y
Pitch	20 threads/in.		80% P_y
Class of fit	2		
Joint configuration	Eccentric		
g-level	Level 2 (4 mins)		
Mass of config.	Mass of specimen + M1		

Table 4.6 Test 5-8 Set-ups for Additional Testing

Constant Values		Variable Values	
Parameter	Value	Parameter	Values
Diameter	3/4"	Lubrication:	All parts
Hole tolerance	Oversize		None
Locking device	None		
Grip length	2.5"	Preload:	40% P_y
Pitch	10 threads/in.		80% P_y
Class of fit	2		
Joint configuration	Eccentric		
g-level	Level 2 (4 mins)		
Mass of config.	Mass of specimen + M7		

V. EXPERIMENTAL RESULTS AND DATA ANALYSIS

5.1 General

A total of 228 tests were performed in this study: 96 vibration tests in the execution of the test matrix, 108 static on-torque vs. off-torque tests, 8 vibration tests in confirmation testing, and 16 vibration tests in additional testing. The experimental data obtained from each of these tests series are presented in the sections below along with the associated data analysis.

5.2 Test Matrix Data

Raw data resulting from execution of the program test matrix (see Fig. 4.1) are shown in Appendix C. A summary of the raw torque data is given in Table 5.1.

Due to the fact that bolt on-torque and off-torque differ by a value of

$$2 \cdot P \cdot r \cdot \tan \alpha \quad (5.1)$$

an adjustment was necessary to get the two torques on a common basis to assess the effects of vibration on bolt loosening. Rather than use these theoretical values, static on-torque and off-torque tests were conducted to determine the adjustment value for each set of conditions. The results of these tests are presented in the next section. The dynamic testing on-torque values were adjusted down to provide an adjusted off-torque before

Table 5.1 Summary of Raw Torque Data.

	k1								k1							
	g1				g2				g1				g2			
	a		b		c		d		e		f		g		h	
	On	Off	On	Off	On	Off	On	Off	On	Off	On	Off	On	Off	On	Off
1	85	40	85	55	85	75	95	85	85	50	85	50	85	70	85	0
2	95	80	95	80	95	75	95	70	90	65	90	70	90	65	95	65
3	150	100	150	100	140	110	140	110	140	90	150	100	150	110	150	80
4	90	50	110	80	100	80	100	70	100	80	100	55	100	??	100	90
5	140	100	145	110	145	110	155	120	150	110	160	115	160	115	160	130
6	150	??	130	80	145	95	150	105	150	120	130	80	130	95	145	100
7	180	160	180	140	180	125	180	145	180	155	180	155	180	160	180	160
8	180	150	180	145	180	140	180	155	180	140	180	145	180	135	180	150
9	135	110	135	120	135	110	140	??	130	120	135	??	140	130	140	105
10	180	140	180	150	180	125	180	105	180	145	180	140	180	140	180	145
11	125	85	125	80	125	90	125	90	125	85	125	190	125	90	125	90
12	110	125	115	100	115	95	115	100	115	105	115	100	115	100	115	100

- Notes:
1. K1 = longitudinal vibration, K2 = axial vibration, g1 = low g-level vibration, g2 = high g-level vibration, a and b are replications of each other as are c and d, e and f, and g and h.
 2. The four ?? entries above are for tests where torque-off was not recorded. For these tests, we know that complete bolt loosening did not occur. Torque-off values for the replica test were used for these missing data.
 3. Test 1h lost all of its initial torque due to vibration.
 4. Test 12a indicated an increase in torque due to vibration.
 5. In test 4e the outer segment of the test specimen rotated approximately 10° early in the test and then microwelded to the inner segment of the specimen.

Table 5.2 Summary of Adjusted Torque Data.

	k1								k1							
	g1				g2				g1				g2			
	a		b		c		d		e		f		g		h	
	On	Off	On	Off	On	Off	On	Off	On	Off	On	Off	On	Off	On	Off
1	63	40	63	55	63	75	63	85	63	50	63	50	63	70	63	0
2	75	80	75	80	75	75	75	70	70	65	70	70	70	65	75	65
3	97	100	97	100	87	110	87	110	87	90	97	100	97	110	97	80
4	72	50	92	80	82	80	82	70	82	80	82	55	82	90	82	90
5	89	100	94	110	94	110	104	120	99	110	109	115	109	115	109	130
6	93	80	93	80	108	95	113	105	113	120	93	80	93	95	108	100
7	153	160	153	140	153	125	153	145	153	155	153	155	153	160	153	160
8	144	150	144	145	144	140	144	155	144	140	144	145	144	135	144	150
9	102	110	102	120	102	110	102	110	97	120	97	120	107	130	107	105
10	140	140	140	150	140	125	140	105	140	145	140	140	140	140	140	145
11	92	85	92	80	92	90	92	90	92	85	92	90	92	90	92	90
12	92	125	97	100	97	95	97	100	97	105	97	100	97	100	97	100

vibration testing. These values were then used to determine changes in loosening torque due to vibrations, i.e.,

$$\text{Adj. Torque} = (\text{Dynamic On-Torque}) - [(\text{Static On-Torque}) - (\text{Static Off-Torque})] \quad (5.2)$$

$$\Delta\text{Torque Loosening} = (\text{Adj. Torque}) - (\text{Off-Torque After Vibration}) \quad (5.3)$$

The adjusted torque data are shown in Table 5.2.

Also recorded in each test was an input signature plot and a response plot for each accelerometer used. An example of these plots can be seen in Figs. 5.1 and 5.2 respectively.

The loosening of a test bolt can be measured by $\Delta\text{Torque Loosening}$ as described in Eqn. (5.3) or by a change in bolt load as a result of vibration. Since torque was measured in ft·lb or in·lb and bolt load was evaluated in lb., the two values are not readily comparable and thus a non dimensional value is needed. A p-value was used for this reason. In the case of torque being used for the measure of bolt loosening, the p-value used was

$$P_{\text{torque}} = \frac{\text{Torque}_{\text{initial}} - \text{Torque}_{\text{residual}}}{\text{Torque}_{\text{initial}}} \quad (5.4)$$

where $\text{Torque}_{\text{initial}}$ is the adjusted torque as described in Eqn. (5.2) and $\text{Torque}_{\text{residual}}$ is the dynamic off-torque value. The p-values based on the adjusted torques in Table 5.2 are shown in Table 5.3. These are the test results used in all analysis which are based on torque data.

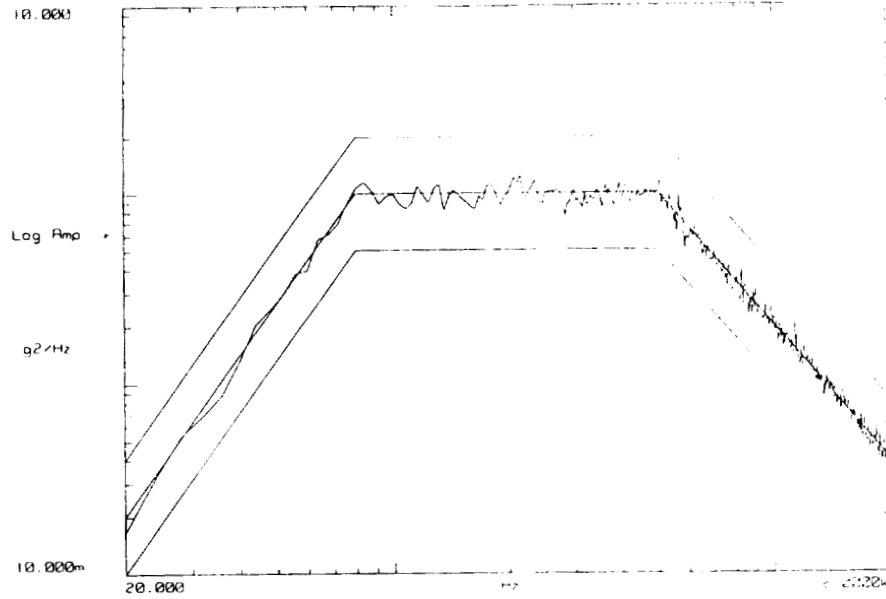

Figure 5.1 Typical Input Signature Plot.

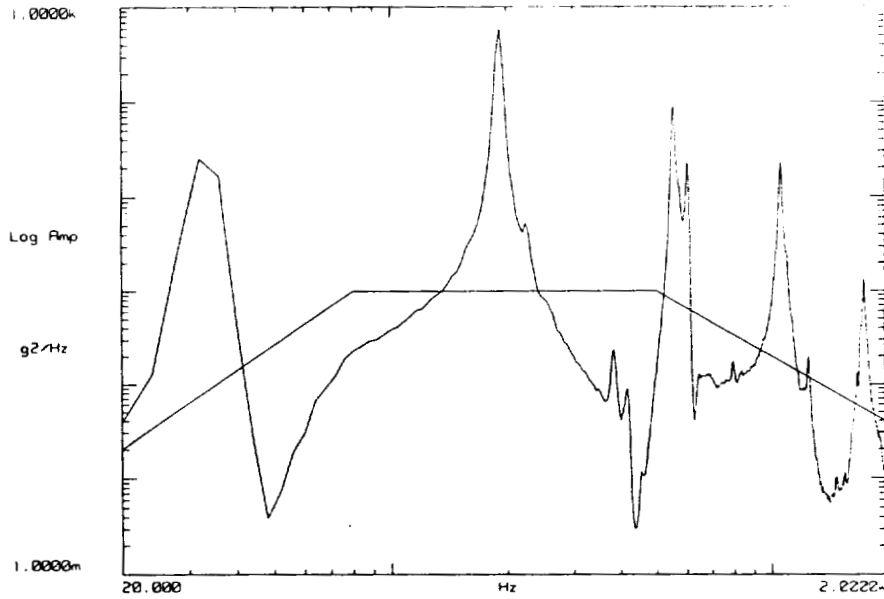

Figure 5.2 Typical Response Plot From Accelerometer.

In the case of bolt length/load being used as the measure of bolt loosening, the test response parameter or p-value used was

$$p_{load} = \frac{Load_{initial} - Load_{residual}}{Load_{initial}} \quad (5.5)$$

where $Load_{initial}$ is the bolt load due to initial torquing and $Load_{residual}$ is the bolt load after vibration. It should be noted that the change in bolt length was measured during testing in order to compute bolt loads. Change in bolt length and bolt load are related by the following equation:

$$P = \frac{\Delta AE}{L} \quad (5.6)$$

where P is load on the bolt, Δ is change in bolt length, A is cross sectional area, and E is Young's modulus of elasticity.

The higher the p-value, the more bolt loosening there is, thus a p-value of 1 would indicate total loosening and a p-value of 0 would indicate no loosening at all. The p-values based on the adjusted torque data and the raw bolt length/load data are shown in Tables 5.3 and 5.4 respectively. It can be noted in Table 5.4 that the raw bolt length/load data yielded 8 unrealistic values (negative values or values greater than 1.0). The negative values were adjusted to 0.000 and the values greater than one were adjusted to 1.000. The resulting Table is shown in Table 5.5.

Table 5.3 p-Values Based on Adjusted Torque Data.

Set-up	k1				k2			
	g1		g2		g1		g2	
	a	b	c	d	e	f	g	h
1	0.370	0.130	-0.190	-0.350	0.210	0.210	-0.110	1.000
2	-0.070	-0.070	0.000	0.070	0.070	0.000	0.070	0.130
3	-0.030	-0.030	-0.260	-0.260	-0.030	-0.030	-0.130	0.180
4	0.310	0.130	0.020	0.150	0.020	0.330	-0.100	-0.100
5	-0.120	-0.170	-0.170	-0.150	-0.110	-0.060	-0.060	-0.190
6	0.140	0.140	0.120	0.070	-0.060	0.140	-0.020	0.070
7	-0.050	0.080	0.180	0.050	-0.010	-0.010	-0.050	-0.050
8	-0.040	-0.010	0.030	-0.080	0.030	-0.010	0.060	-0.040
9	-0.080	-0.180	-0.080	-0.080	-0.240	-0.240	-0.210	0.020
10	0.000	-0.070	0.110	0.250	-0.040	0.000	0.000	-0.040
11	0.080	0.130	0.020	0.020	0.080	-0.020	0.020	0.020
12	-0.360	-0.030	0.020	-0.030	-0.080	-0.030	-0.030	-0.030

Table 5.4 p-Values Based on Raw Length/Load Data.

Set-up	k1				k2			
	g1		g2		g1		g2	
	a	b	c	d	e	f	g	h
1	0.550	0.540	0.370	0.460	0.710	0.440	1.000	1.000
2	0.080	0.590	0.670	0.000	0.710	1.040	0.040	0.480
3	0.350	0.390	0.140	0.150	0.600	0.110	0.590	0.200
4	0.670	0.600	0.000	0.630	0.000	0.430	0.560	0.670
5	0.060	0.040	0.110	0.070	0.070	0.060	0.000	0.020
6	0.000	0.350	0.850	0.570	0.350	0.000	0.000	0.320
7	0.190	0.280	0.290	0.000	0.040	0.750	-2.200	-2.200
8	0.280	1.530	-0.320	0.000	0.000	0.460	-0.480	1.000
9	0.000	0.000	0.090	0.060	0.040	0.690	0.000	0.050
10	0.190	0.360	0.000	0.330	0.530	1.340	0.000	2.310
11	0.620	0.260	0.260	0.520	0.070	0.000	0.250	0.150
12	0.000	0.000	0.000	0.000	0.000	0.000	0.060	0.030

Table 5.5 p-Values Based on Adjusted Length/Load Data.

Set-up	k1				k2			
	g1		g2		g1		g2	
	a	b	c	d	e	f	g	h
1	0.550	0.540	0.370	0.460	0.710	0.440	1.000	1.000
2	0.080	0.590	0.670	0.000	0.710	1.000	0.040	0.480
3	0.350	0.390	0.140	0.150	0.600	0.110	0.590	0.200
4	0.670	0.600	0.000	0.630	0.000	0.430	0.560	0.670
5	0.060	0.040	0.110	0.070	0.070	0.060	0.000	0.020
6	0.000	0.350	0.850	0.570	0.350	0.000	0.000	0.320
7	0.190	0.280	0.290	0.000	0.040	0.750	0.000	0.000
8	0.280	1.000	0.000	0.000	0.000	0.460	0.000	1.000
9	0.000	0.000	0.090	0.060	0.040	0.690	0.000	0.050
10	0.190	0.360	0.000	0.330	0.530	1.000	0.000	1.000
11	0.620	0.260	0.260	0.520	0.070	0.000	0.250	0.150
12	0.000	0.000	0.000	0.000	0.000	0.000	0.060	0.030

It should be noted that in executing the program test matrix, the 2-piece aluminum test specimens exhibited a considerable amount of microwelding. In one test (Test 4e), the outer cantilever segment rotated approximately 10° relative to the inner segment early in the testing and then stopped rotating. At the end of the test the two segments could only be separated by using a great amount of force due to microwelding. This difficulty in separation was quite common with the 2-piece specimens, particularly under the larger preloads regardless of lubrication. In the cases of large preload and lubricated interface, pressures were large and the lubrication probably allowed some initial movement at the interface but was not viscous enough to provide adequate lubrication thus microwelding occurred. When this occurred, the joint acted as a welded connection and actions to cause bolt loosening were greatly reduced. This occurrence probably added considerable "noise" to the data and caused problems in correlating the data with theoretical best performance predictions.

5.3 Test Matrix Data Analysis

The test data presented in the previous section was analyzed using the p-values shown in Tables 5.3 and 5.5 as the bolt loosening response parameters. A general analysis looking at average p-values and the variation in p-values with the design parameter values was performed first. This was followed by an ANOVA (Analysis of Variance) analysis. The results of these analyses are presented below.

5.3.1 General Analysis of Data

Static torque testing data was combined with the data from executing the program test matrix to evaluate the normalized p_{torque} response parameter in the manner indicated by Eqn. (5.4). This parameter was taken as the measure of bolt loosening in the adjusted

data shown in Table 5.3. In turn, this data was averaged for each design parameter and for each loading parameter and the results are shown in Table 5.6. For example, the value of 0.062 shown in Table 5.6 for A1 and Transverse/g2 Load is the average of 12 results, i.e., 12 tests where the A parameter was at its value of A1 and the load parameters were transverse/g2. The 12 consisted of 6 different tests with 1 replication of each test. The total average p-value of 0.025 shown for A1 in the next to last column is the average of 48 tests where the A parameter was at its A1 value. Thus, each entry in the 4 average response parameter value columns are the average of 12 tests, and each row and column of this 20 x 4 array (mid portion of the table) was averaged as indicated in the table. The last two columns of the table show values which are boxed-in to indicate parameter levels for each parameter which are best at mitigating bolt loosening due to vibrations. Recall, from the definition of p , the larger its value, the greater the bolt loosening. Also, as indicated earlier, one would expect p to fall in the range of $0 \leq p \leq 1$, where $p = 0$ indicates no loosening and $p = 1$ indicates complete loosening. It is theoretically possible to have negative values of p (indicates bolt tightening due to vibrations), however this is quite improbable. Table 5.6 indicates an average p-value of 0.003 for all tests. This represents an approximate average loosening of 0.3% per test and indicates very little loosening due to vibration.

The average p-values for the high and low levels for each design parameter are shown plotted in Fig. 5.3 for the transverse/g2 loading (column 4 in Table 5.6). This column was chosen because transverse loading at the high g-level should be the loading most likely to produce bolt loosening. The average p-value of 0.017 for this set of conditions is shown superimposed (dotted lines) on the plots of Fig. 5.3. This value represents an approximate average loosening of 1.7% per test.

A study of Table 5.6 and Fig. 5.3 indicates the following:

1. The low p-values and their fluctuation around zero, with negative values being common and almost as large as positive values, seems to indicate that very little bolt loosening occurred in the testing program.
2. The numerous negative p-values indicate that parameter variability, noise, and experimental error were probably the main source of Δ torque and not actual bolt loosening due to vibrations.
3. The best (boxed) parameter levels for the total average p-value in the next to last column compare favorably with the best parameter level one would expect from theory shown boxed in the last column. These two columns showed disagreement in the H parameter (mating part lubrication) and G parameter (thread pitch). A possible explanation of this disagreement is that the lubricated and course thread smaller contact surfaces resulted in larger bolt preloads for these cases (since they were torqued to the same value for each parameter level). This in turn caused larger T_{loosen} values and thus better bolt vibration performances, i.e., better nonloosening performances. Also, the occurrence of microwelding in the 2-piece cantilever specimens mentioned earlier was probably a major factor in the disagreement between theory and the test data.
4. A comparison of the first column best parameter levels with those from theory indicates good agreement except for the B, H, and L parameters. The B and H parameters both relate to lubricated surfaces (threads and other mating parts), and the cause of this discrepancy may be as discussed in (3) above. The improved performance in the presence of the additional mass may be due to the additional mass reducing the natural frequencies of the test specimens, and these reduced frequencies having a greater mitigating effect on bolt loosening than the detrimental effect caused by the increase mass/inertia of the test specimens.

Table 5.6 Test Matrix Response Parameters (p)
for Design Load Parameters.

PARAMETER DESCRIPTION	LETTER DESIGNATION	PARAMETER LEVEL	AVERAGE RESPONSE PARAMETER (p) VALUES				TOTAL AVG. p VALUES	BEST PARAMETER LEVEL BASED ON THEORY
			TRANSV. & g_2 LOAD	AXIAL & g_2 LOAD	TRANSV. & g_1 LOAD	AXIAL & g_1 LOAD		
FASTENER SIZE	A1	1/4" ϕ	0.062	-0.079	0.058	0.061	0.025	<input type="checkbox"/> X
	A2	3/4" ϕ	-0.028	-0.034	-0.044	-0.044	-0.021	
THREAD LUB	B1	NONE	0.073	-0.081	-0.004	0.002	-0.003	<input type="checkbox"/> X
	B2	TRIFLOW	-0.039	0.036	0.018	0.015	0.008	
HOLE TOLERANCE & PRELOAD	CD1	OVERSIZE & 0.4 PU	0.057	-0.036	0.029	0.030	0.020	<input type="checkbox"/> X
	CD2	TIGHT & 0.8 PU	-0.023	-0.010	-0.016	-0.014	-0.016	
LOCKING DEVICE	E1	PLAIN NUT	0.087	0.029	0.052	0.068	0.059	<input type="checkbox"/> X
	E2	SL NUT	-0.053	-0.074	-0.020	-0.051	-0.050	
GRIP STRENGTH	F1	0.94"/1.62"	0.045	-0.026	0.045	0.038	0.026	<input type="checkbox"/> X
	F2	1.57"/2.62"	-0.011	-0.019	-0.032	-0.021	-0.021	
PITCH	G1	COURSE 20/10	0.042	-0.092	-0.017	0.003	-0.016	<input type="checkbox"/> X
	G2	FINE 28/16	-0.008	0.050	0.033	0.014	0.023	
MATING PART LUB	H1	NONE	0.083	-0.074	0.038	0.041	0.022	<input type="checkbox"/> X
	H2	TRIFLOW	-0.049	0.029	-0.024	-0.024	-0.017	
CLASS OF FIT	I1	CLASS 2	0.034	-0.048	0.059	0.070	0.029	<input type="checkbox"/> X
	I2	CLASS 3	0.001	0.006	-0.045	-0.054	-0.026	
JT. CONFIGURATION	J1	2 PC CANTILEVER	0.044	-0.003	0.029	0.070	0.035	<input type="checkbox"/> X
	J2	1 PC CANTILEVER	-0.010	-0.043	-0.016	-0.054	-0.031	
MASS OF CONFIGURATION	L1	TEST SPECIMEN	0.029	-0.051	-0.024	0.011	-0.014	<input type="checkbox"/> X
	L2	TEST SP + MASS	0.006	0.006	0.037	-0.028	0.019	
AVG VALUES:			0.017	-0.023	0.008	0.008	0.003	
			AVG VALUES: g_2 VS g_1 :		-0.003	0.008		
			g_2 LOADING IS BETTER $\frac{0.017 + 0.008}{2}$ VS $\frac{-0.023 + 0.008}{2}$					
			TRANSVERSE VS AXIAL: 0.013 VS -0.008 (AXIAL LOADING IS BETTER)					

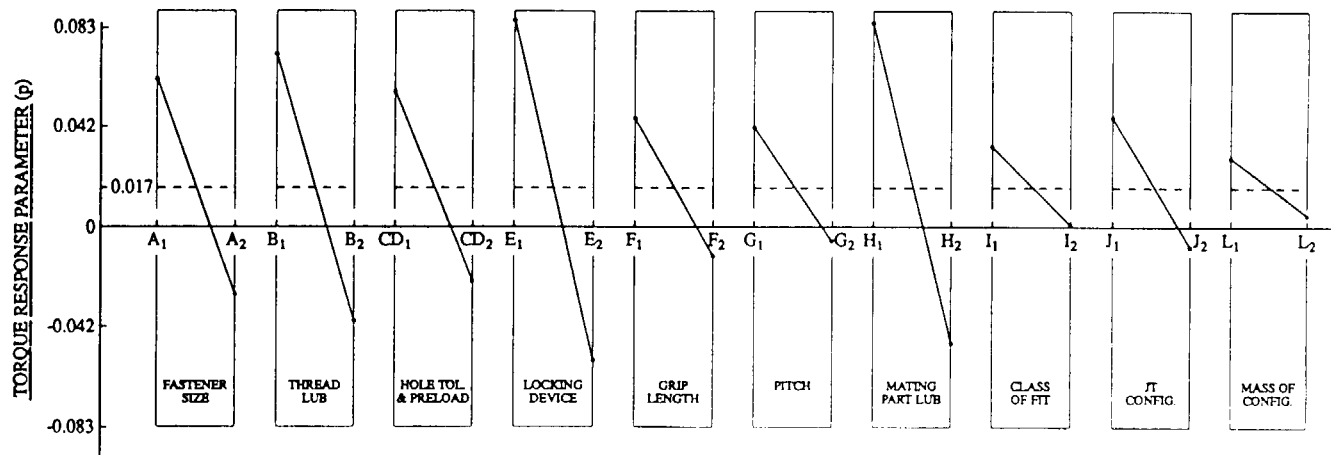

Figure 5.3 Response Parameter vs. Design Parameters for Transverse/g2 Level Loading.

5. Comparing average p-values for Transverse vs. Axial loadings at the bottom of the table indicates that axial loadings are better at mitigating bolt loosening.
6. Comparing average p-values for g1 vs. g2 loading levels at the bottom of the table indicates that the g2 loading (the higher load level) is better at mitigating bolt loosening. This could possibly make sense because of the microwelding occurring when testing many 2-piece cantilever specimens. The more intense g-level loading (g2) would cause greater microwelding and this would inhibit relative movement and thus inhibit bolt loosening. The fact that half the specimens tested were of the 2-piece construction could bias the results to indicate the g2 loading is better at mitigating bolt loosening. However, this is an abnormality of this particular set-up and should not be valid in most situations.
7. The larger variation in p-values and their low values indicates that additional preliminary testing is needed to attain test specimens, loading signatures, intensities, and durations which all achieve significant bolt loosening. This is needed in order that threshold loosening values of major parameters can be determined.
8. The inconsistencies and disagreements with theory, e.g., those cited in (3), (4), and (6) above indicate that additional preliminary testing is needed to better understand the vibrational loading - bolt/joint behavior and thus later predict and prevent bolt loosening.

5.3.2 ANOVA Analysis of Data

A comprehensive ANOVA (Analysis of Variance) analysis, which considers each dof in the experiment, was performed on the test matrix data by the project subcontractor ITEQ. The results of their analysis are presented below.

5.3.2.1 Analysis Based on Adjusted Torque Data

An ANOVA on the adjusted torque data shown in Table 5.3 was performed and the resulting ANOVA table is shown in Table 5.7. This table shows the decomposition of every possible source of variation in the test matrix. In this table, large p-values indicate parameters (or 2 parameter or 3 parameter interactions) that have a significant effect on bolt loosening. These values and parameters are marked with an asterisk (** or *) in the last column of Table 5.7. The first column of the table indicates the parameters and parameter interactions, and the letter designations shown are the same as those defined in Table 5.6 and Fig. 5.3. Table 5.8 shows the final ANOVA table once all the insignificant sources of variation are pooled into the error estimate. Figure 5.4 shows how the p-values vary with the two insignificant parameters identified in Table 5.8.

5.3.2.2 Analysis Based on Adjusted Length/Load Data

The complete ANOVA table showing the decomposition of every possible source of variation using the adjusted bolt length/load p-value data of Table 5.5 is shown in Table 5.9. These data indicate that the E and J parameters are significant to bolt loosening, and indicate that the A and L parameters are also significant as is the IxKxG interaction. The final ANOVA table once all of the insignificant factors of variation are pooled into the error estimate is shown in Table 5.10. Plots of these significant parameters are shown in Fig. 5.5.

Table 5.7 Anova Table for Adjusted Torque p-Value Data.

F(0.05,1,51)= 4.03*				
F(0.01,1,51)= 7.18**				
Source	df	S	V	F
A	1	0.0499	0.0499	2.39 p
B	1	0.0025	0.0025	0.12 p
CD	1	0.0297	0.0297	1.42 p
E	1	0.3026	0.3026	14.48 **
F	1	0.0508	0.0508	2.43 p
G	1	0.0380	0.0380	1.82 p
H	1	0.0356	0.0356	1.70 p
I	1	0.0765	0.0765	3.66 p
J	1	0.1033	0.1033	4.94 *
L	1	0.0263	0.0263	1.26 p
e	1	0.0007	0.0007	0.03 p
T1	11	0.7159		
K	1	0.0086	0.0086	0.41 p
g	1	0.0025	0.0025	0.12 p
Kxg	1	0.0102	0.0102	0.49 p
AxK	1	0.0595	0.0595	2.85 p
BxK	1	0.0720	0.0720	3.44 p
CDxK	1	0.0174	0.0174	0.83 p
ExK	1	0.0001	0.0001	0.00 p
FxK	1	0.0099	0.0099	0.47 p
GxK	1	0.0356	0.0356	1.70 p
HxK	1	0.0800	0.0800	3.83 p
IxK	1	0.0031	0.0031	0.15 p
JxK	1	0.0062	0.0062	0.30 p
LxK	1	0.0050	0.0050	0.24 p
Axg	1	0.0799	0.0799	3.82 p
Bxg	1	0.0012	0.0012	0.06 p
CDxg	1	0.0019	0.0019	0.09 p
Exg	1	0.0019	0.0019	0.09 p
Fxg	1	0.0111	0.0111	0.53 p
Gxg	1	0.0015	0.0015	0.07 p
Hxg	1	0.0148	0.0148	0.71 p
Ixg	1	0.0776	0.0776	3.71 p
Jxg	1	0.0083	0.0083	0.40 p
Lxg	1	0.0062	0.0062	0.30 p
AxKxg	1	0.0636	0.0636	0.40 p
BxKxg	1	0.0835	0.0835	0.30 p
CDxKxg	1	0.0163	0.0163	3.04 p
ExKxg	1	0.0065	0.0065	4.00 p
FxKxg	1	0.0028	0.0028	0.78 p
GxKxg	1	0.0824	0.0824	0.31 p
HxKxg	1	0.0845	0.0845	0.13 p
IxKxg	1	0.0111	0.0111	3.94 p
JxKxg	1	0.0128	0.0128	4.04 *p
LxKxg	1	0.0152	0.0152	0.53 p
e	51	1.0656	0.0209	0.61 p
T	95	2.6747		0.73 p

Table 5.8 Pooled ANOVA Table for Adjusted Torque p-Value Data.

Source	df	S	V	F	S'	p(%)
E	1	0.3206	0.3206	12.40**	0.2782	10.40
J	1	0.1033	0.1033	4.23*	0.0789	2.90
e(pool)	93	2.2688	0.2440		2.3176	86.60
T	95	2.6747			2.6747	99.90

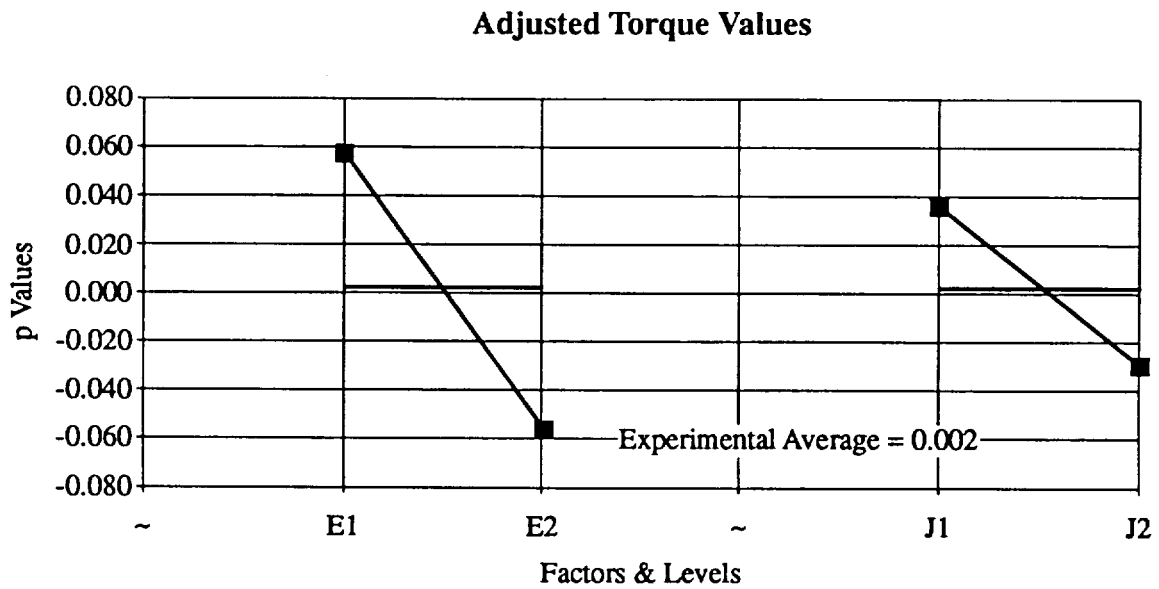

Figure 5.4 Response Parameter vs. Design Parameters E and J for Adjusted Torque Data.

Table 5.9 ANOVA Table for Adjusted Length/Load p-Value Data.

F(0.05,1,51)= 4.03*				
F(0.01,1,51)= 7.18**				
Source	df	S	V	F
A	1	0.4746	0.4746	6.46 **
B	1	0.1953	0.1953	2.66 p
CD	1	0.0527	0.0527	0.72 p
E	1	0.6484	0.6484	8.82 **
F	1	0.1642	0.1642	2.23 p
G	1	0.0031	0.0031	0.04 p
H	1	0.0250	0.0250	0.34 p
I	1	0.0656	0.0656	0.89 p
J	1	0.6419	0.6419	8.73 **
L	1	0.5750	0.5750	7.82 **
e	1	0.0493	0.0493	0.67 p
T1	11	2.8951		
K	1	0.0656	0.0656	0.89 p
g	1	0.0635	0.0635	0.86 p
Kxg	1	0.0148	0.0148	0.20 p
AxK	1	0.0008	0.0008	0.01 p
BxK	1	0.1971	0.1971	2.68 p
CDxK	1	0.0010	0.0010	0.01 p
ExK	1	0.0028	0.0028	0.04 p
FxK	1	0.1625	0.1625	2.21 p
GxK	1	0.0823	0.0823	1.12 p
HxK	1	0.1034	0.1034	1.41 p
IxK	1	0.0788	0.0788	1.07 p
JxK	1	0.0500	0.0500	0.68 p
LxK	1	0.0107	0.0107	0.15 p
Axg	1	0.0858	0.0858	1.17 p
Bxg	1	0.1626	0.1626	2.21 p
CDxg	1	0.0143	0.0143	0.19 p
Exg	1	0.0015	0.0015	0.02 p
Fxg	1	0.0000	0.0000	0.00 p
Gxg	1	0.0059	0.0059	0.08 p
Hxg	1	0.1795	0.1795	2.44 p
Ixg	1	0.0095	0.0095	0.13 p
Jxg	1	0.0421	0.0421	0.57 p
Lxg	1	0.0847	0.0847	1.15 p
AxKxg	1	0.0000	0.0000	0.00 p
BxKxg	1	0.0022	0.0022	0.03 p
CDxKxg	1	0.0086	0.0086	0.12 p
ExKxg	1	0.2137	0.2137	2.91 p
FxKxg	1	0.1141	0.1141	1.55 p
GxKxg	1	0.0008	0.0008	0.01 p
HxKxg	1	0.2174	0.2174	2.96 p
IxKxg	1	0.4830	0.4830	6.57 *
JxKxg	1	0.0981	0.0981	1.33 p
LxKxg	1	0.1880	0.1880	2.56 p
e	51	3.7488	3.7488	
T	95	9.3890		

Table 5.10 Pooled ANOVA Table for Adjusted Length/Load p-Value Data.

Source	df	S	V	F	S'	p(%)
A	1	0.4746	0.4746	6.50*	0.4016	4.28
E	1	0.6484	0.6484	8.88**	0.5754	6.13
J	1	0.6419	0.6419	8.79**	0.5689	6.06
L	1	0.5750	0.5750	7.88**	0.5020	5.35
IxKxg	1	0.4830	0.4830	6.62*	0.4100	4.37
e(pool)	90	6.5661	0.0730		6.9311	73.82
T	95	9.3890			9.3890	100.01

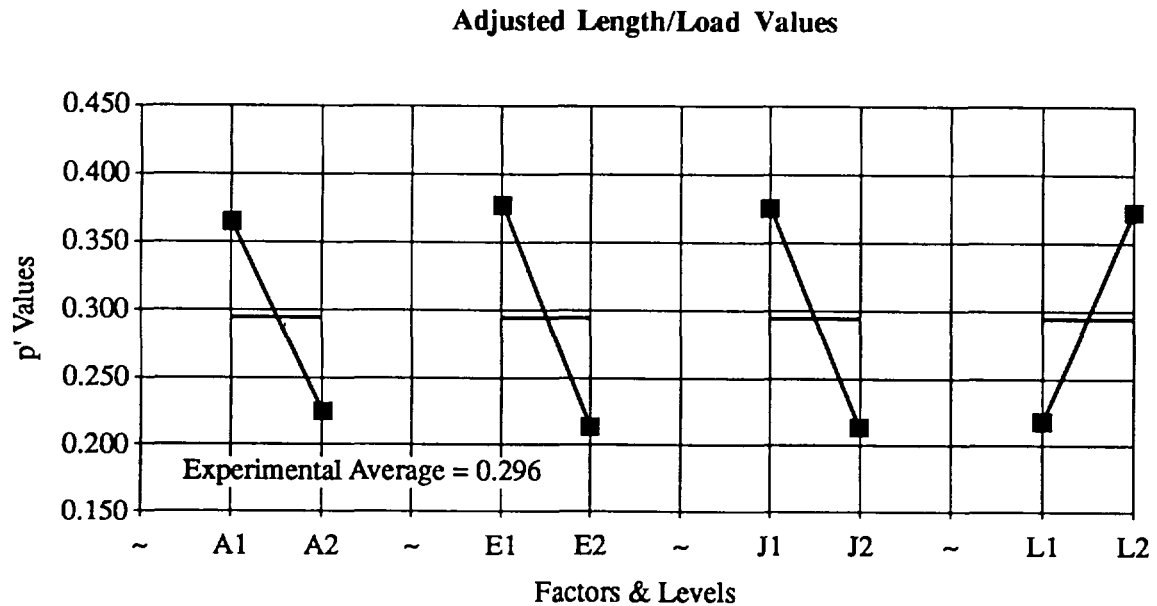

Figure 5.5 Response Parameter vs. Design Parameters A, E, J, and L for Adjusted Length/Load Data.

5.4 Static On-Torque vs. Off-Torque Data

The data collected for these tests was the result of each set-up prescribed by the test matrix (Fig. 4.1) being used to measure on-torque vs. off-torque on the bolt with no vibration. Each bolt was torqued to the on-torque value used in vibration testing and then immediately untorqued. Both torque values were recorded. This process was repeated twice more on a particular bolt for a total of three on-torque and off-torque measurements per bolt. Three bolts were used for each set-up. The data for this testing can be seen in Appendix D.

It should be noted that this data was intended solely for the use of modifying the on-torque and off-torque data as described in Section 5.2. The static on-torques and off-torques (Appendix D) and the dynamic on-torques and off-torques (Appendix C) are very similar as evident in Table 5.11 and in Figs. 5.6 and 5.7. These figures seem to indicate that there was little, if any, bolt loosening in the vibration testing.

Table 5.11 Bolt Torque Reductions and Torque Tightening/
Torque Loosening Ratios for Vibration Testing and Static Testing

TEST SET-UP	VIBRATION TEST RESULTS		STATIC TEST RESULTS	
	AVG Δ TORQUE*	AVG M_T/M_L	AVG Δ TORQUE*	AVG M_T/M_L
1	25.7"#	1.51	22.2"#	1.35
2	21.9"#	1.31	19.4"#	1.26
3	46.3"#	1.48	52.8"#	1.54
4	27.9"#	1.43	17.8"#	1.22
5	37.5"#	1.34	51.1"#	1.52
6	43.6"#	1.47	36.7"#	1.32
7	30.0"#	1.21	27.2"#	1.18
8	35.0"#	1.24	36.1"#	1.25
9	20.0"#	1.18	32.8"#	1.32
10	43.8"#	1.34	39.4"#	1.28
11	37.5"#	1.43	33.3"#	1.36
12	15.0"#	1.12	17.8"#	1.18

* Δ TORQUE = TORQUE TO TIGHTEN - TORQUE TO LOOSEN

* Δ TORQUE = $M_T - M_L$

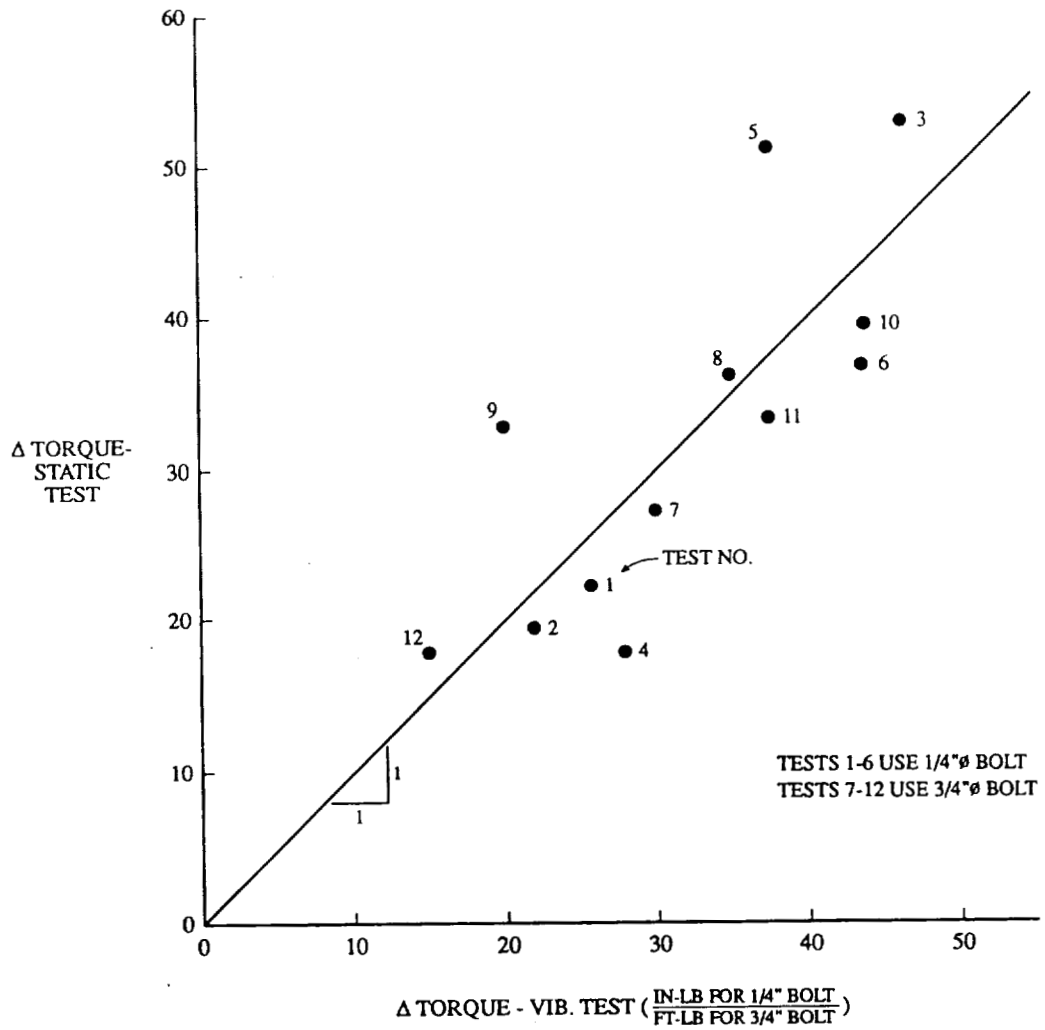

Figure 5.6 Plot of Δ Torque Vibration vs. Δ Torque Static.

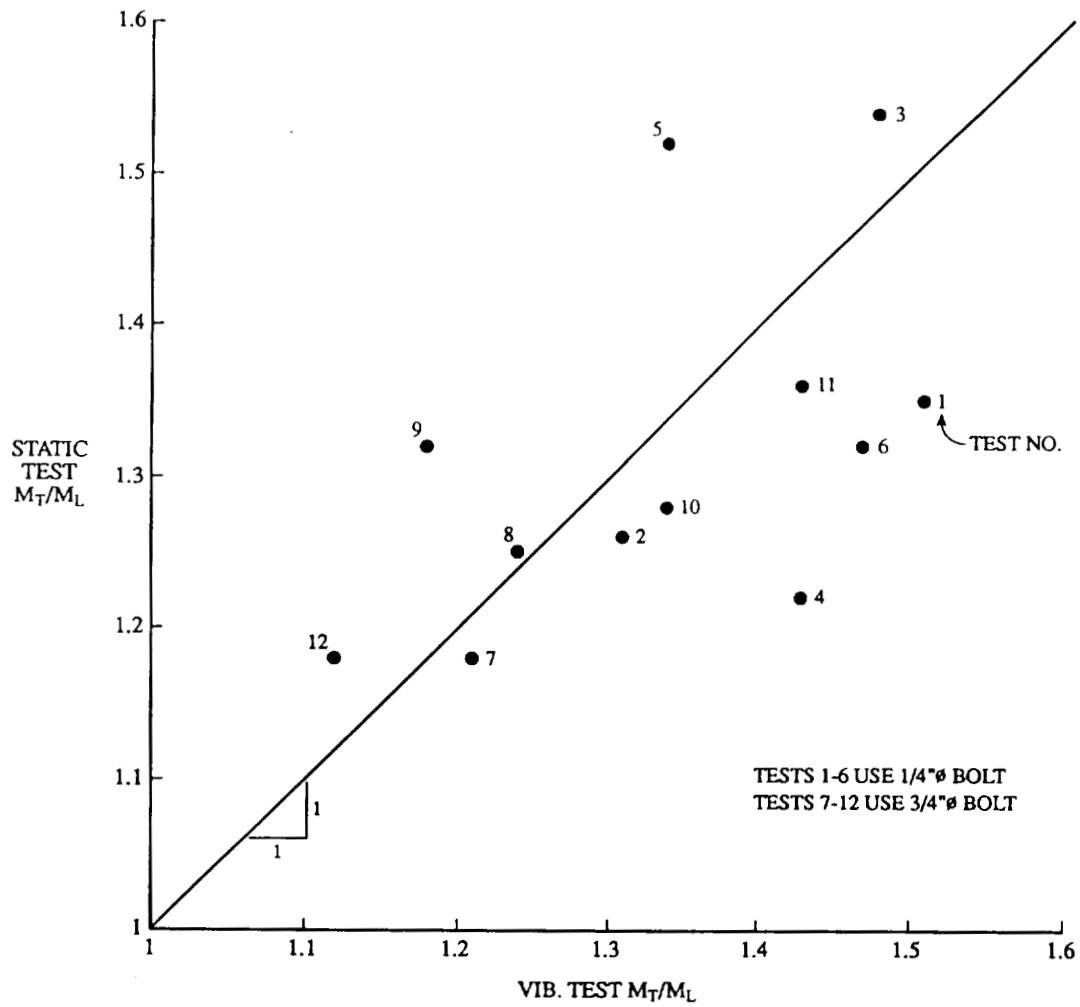

Figure 5.7 Plot of M_T / M_L Vibration Tests vs. M_T / M_L Static Tests.

5.5 Confirmation Testing Data

Based on statistical averaging of p-values from executing the program test matrix and engineering judgment two tests were designed to confirm the results of executing the program test matrix. Confirmation Test #1 consisted of parameter levels that would be unfavorable to bolt loosening and Confirmation Test #2 consisted of parameter levels that would be favorable to bolt loosening. A detailed listing for all parameter and input levels can be seen in Tables 4.3 and 4.4. The data for confirmation testing is shown in Appendix E.

A predicted mean p-value ($\hat{\mu}_p$) was calculated for each confirmation test. If the mean p-value calculated from testing falls within the range of $\hat{\mu}_p$ then the parameter levels selected for each test can be assumed to be correct with some degree of confidence. The following calculations were made using p-values based on adjusted torque data.

95% Confidence interval for the estimate:

$$C_{0.05} = \pm \sqrt{(F_{0.05,2,96})(V_e) \left(\frac{1}{n_e} + 1 \right)} \quad (5.7)$$

Where:

$$\frac{1}{n_e} = \frac{df_{estimate}}{df_{total}} \quad (5.8)$$

Therefore:

$$C_{0.05} = \pm \sqrt{(3.09)(0.0244) \left(\frac{2}{96} + 1 \right)} = \pm 0.277 \quad (5.9)$$

Prediction at $A_1B_1CD_1E_1F_1G_1H_1I_1J_1L_2$:

$$\hat{\mu}_p = \bar{E} + \bar{J}_1 - \bar{T} \quad (5.10)$$

Where:

\bar{E}_1 & \bar{J}_1 are average values of the E and J parameters at level 1

\bar{T} is the experimental average

Therefore:

$$\hat{\mu}_p = 0.059 + 0.035 - 0.002 = 0.092 \pm 0.277 \quad (5.11)$$

Confirmation at $A_1B_1CD_1E_1F_1G_1H_1I_1J_1L_2$:

$$\mu_{conf} = \frac{(0.21 + 0.00 + 0.07 + 0.07)}{4} = 0.088 \quad (5.12)$$

Please note that μ_{conf} falls within the 95% confidence interval of the prediction.

In a similar manner, the prediction and confirmation mean p-values were calculated for $A_2B_2CD_2E_2F_2G_2H_2I_2J_2L_1$ using p-values based on adjusted torque data. In addition, prediction and confirmation mean p-values were calculated for both confirmation tests using p-values based on bolt load data. These values can be seen in Table 5.12.

Please note that all confirmation mean p-values fall within the 95% confidence interval except the $A_1B_1CD_1E_1F_1G_1H_1I_1J_1L_2$ experiment based on bolt load.

Table 5.12 Prediction and Confirmation Mean p-Values.

$A_1B_1CD_1E_1F_1G_1H_1I_1J_1L_2$	$A_2B_2CD_2E_2F_2G_2H_2I_2J_2L_1$
Based on adjusted torque:	
$\hat{\mu}_p = 0.092 \pm 0.277$	$\hat{\mu}_p = -0.086 \pm 0.277$
$\mu_{conf} = 0.088$	$\mu_{conf} = 0.073$
Based on bolt load:	
$\hat{\mu}_p = 0.610 \pm 0.433$	$\hat{\mu}_p = -0.014 \pm 0.433$
$\mu_{conf} = 0.150$	$\mu_{conf} = 0.403$

5.6 Additional Testing Data

The additional tests were run in an attempt to address the problems that were encountered in executing the program test matrix. These problems are explained in detail in Section 4.9. Also, based on the lack of loosening that was encountered in executing the program test matrix, additional tests were run in an attempt to get more bolts to actually loosen so that the design parameters could be evaluated. The data for the additional tests can be seen in Appendix F. It should be noted that Test 8a could not be run because the test specimen fatigued prior to this test.

The p-values based on bolt load for the additional testing along with the average p-values for the axial, transverse, 40% P_y , and 80% P_y tests can be seen in Table 5.13. In this table, any negative p-values resulting from the raw data were replaced by zeroes.

Table 5.13 p-Values for Additional Testing

	40% P_y		80% P_y		40% P_y		80% P_y	
	1	3	2	4	5	7	6	8
a	0.000	1.000	0.000	0.126	0.115	0.000	0.318	***
b	1.000	1.000	1.000	1.000	1.000	0.000	0.299	0.000

Average p-Values:

Axial	0.223	Lub.	0.467
Trans	0.662	Non Lub.	0.286
40% P_y	0.514	1/4" Bolt	0.641
80% P_y	0.392	3/4" Bolt	0.248

- Notes: 1. a = axial direction of vibration, b = transverse direction of vibration.
 2. Tests 1, 2, 5, and 6 were lubricated tests and tests 3, 4, 7, and 8 were non lubricated tests.
 3. Tests 1, 2, 3, and 4 were 1/4" bolts and tests 5, 6, 7, and 8 were 3/4" bolts.

Figures 5.8, 5.9, 5.10, and 5.11 are plots of the average p-values for vibration direction, bolt preload, lubricated parts, and fastener size respectively. Figure 5.8 indicates that the transverse direction of vibration had a significant impact on bolt loosening compared to the axial direction. Figure 5.9 indicates that using a bolt preload of 40% P_y produced more loosening than when a bolt preload of 80% P_y was used; however, the difference was relatively small. It is anticipated that once the bolt preload drops to lower values, bolt loosening will readily occur. More testing to better quantify the effect of bolt preload (over a wide range of values) on bolt loosening. Figure 5.10 indicates that lubricated joints loosened more than non lubricated joints as a whole, but further inspection reveals that the small bolts that were unlubricated showed greater loosening than the lubricated and for the larger bolts the opposite was true. Additional testing with this parameter is needed to better determine the effects of lubrication on bolt loosening. Figure 5.11 indicates that 1/4" ϕ bolts loosened more than the 3/4" ϕ bolts.

Comparing the performances of the 1/4" ϕ and 3/4" ϕ bolts, indicates that severity of vibration loadings have a major impact on bolt loosening. The smaller bolt was under a more severe vibration loading relative to its size and in 5 of the 8 tests the 1/4" ϕ bolt completely loosened due to vibration, whereas only 1 of 7 of the 3/4" ϕ bolts completely loosened during testing.

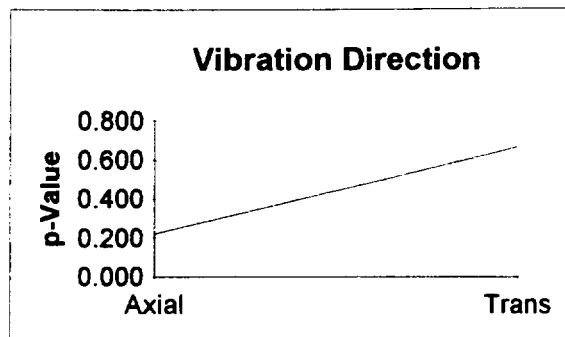

Figure 5.8 Comparison of p-Values for Vibration Direction.

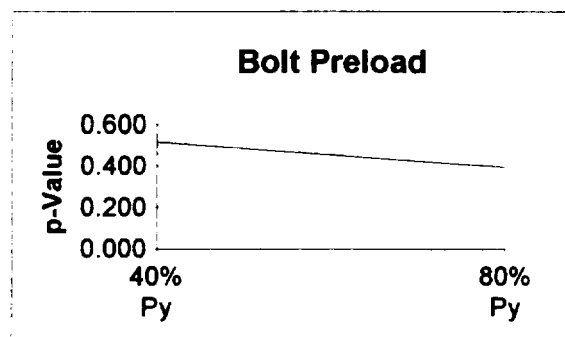

Figure 5.9 Comparison of p-Values for Bolt Preload.

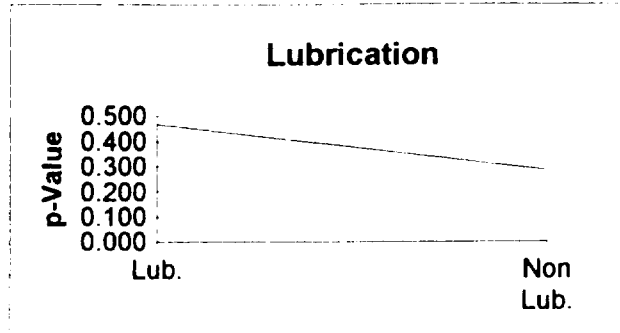

Figure 5.10 Comparison of p-Values for Lubricated Parts.

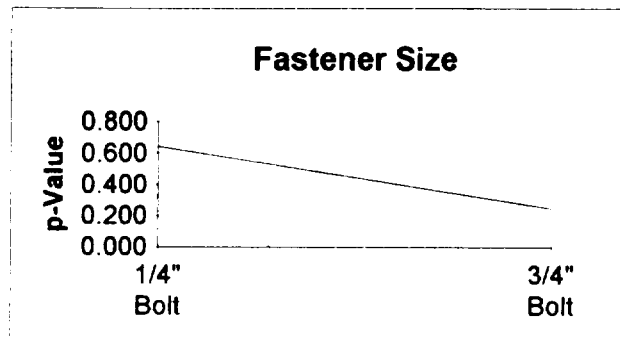

Figure 5.11 Comparison of p-Values for Fastener Size.

VI. CONCLUSIONS AND RECOMMENDATIONS

6.1 Conclusions Based on Theory

Theoretical considerations and the literature teach us that for static conditions, the torque required to loosen a bolt is approximated by

$$T_{loosen} = P \cdot r \cdot C_L + T_{LN} \quad (6.1)$$

where P is bolt preload = $f(r^2, \sigma_y, \% \text{ of } \sigma_y)$, r is bolt radius, $C_L = f(\mu_{threads}, \mu_{matingparts}, \text{thread pitch angle})$, and T_{LN} is the torque for the locknut. Thus, to maximize T_{loosen} , one would want to maximize P , r , C_L , and T_{LN} . To maximize these, one should maximize the bolt diameter, yield strength, and percent of yield strength that the bolt is preloaded to, and maximize all coefficients of friction as well.

Plots of C_T (coefficient associated with $T_{tighten}$) and C_L versus μ are shown in Figs. 6.1 and 6.2 for the bolts employed in this study. These figures provide graphical illustrations of the relative magnitudes and importance of C_T vs. C_L , thread vs. mating parts coefficient of friction, and use of coarse thread vs. fine thread bolts. The following observations can be made from these figures.

1. The difference between C_T and C_L is significant with the coarse thread bolts showing the greatest difference. However, at large μ values ($\mu \geq 0.4$) the difference between C_T and C_L is less than 10%.

2. Both C_T and C_L , and thus $T_{tighten}$ and T_{loosen} , are quite sensitive to μ and increase at a rapid rate with μ .
3. Both coefficients of friction ($\mu_{threads}$ and $\mu_{matingparts}$) are very important and contribute greatly to C_T and C_L and thus $T_{tighten}$ and T_{loosen} . Note that $C_L \approx \mu$ in Fig. 6.1 and $C_L \approx 2.5\mu$ in Fig. 6.2.
4. Thread pitch makes very little difference in the values of C_T and C_L except in cases where μ is very small, i.e., $0 \leq \mu \leq 0.05$. However, it should be noted that for the bolts in this study, the design cross-sectional areas (A) and percent increases in A for fine threads (relative to coarse threads) are as shown in Table 6.1. Allowable bolt preloads will vary directly with A and thus 21% and 16% larger preloads may be applied to 1/4" and 3/4" ϕ bolts respectively. These in turn should increase the T_{loosen} by the same percentages. Thus, fine threaded bolts should significantly mitigate bolt loosening due to vibrations.

Table 6.1 Percent Increase in Design Cross-Section
Area for Fine Threads.

Bolt Size	Course Thread A(in ²)	Fine Thread	%Increase in A for Fine Threads
1/4"	0.0269	0.0326	21%
3/4"	0.3020	0.3513	16%

Whereas Eqn. (6.1) and the above observations are based on static conditions, it is reasonable to assume that the design parameters which yield large values of $T_{loosen-static}$ will also yield large values of $T_{loosen-dynamic}$.

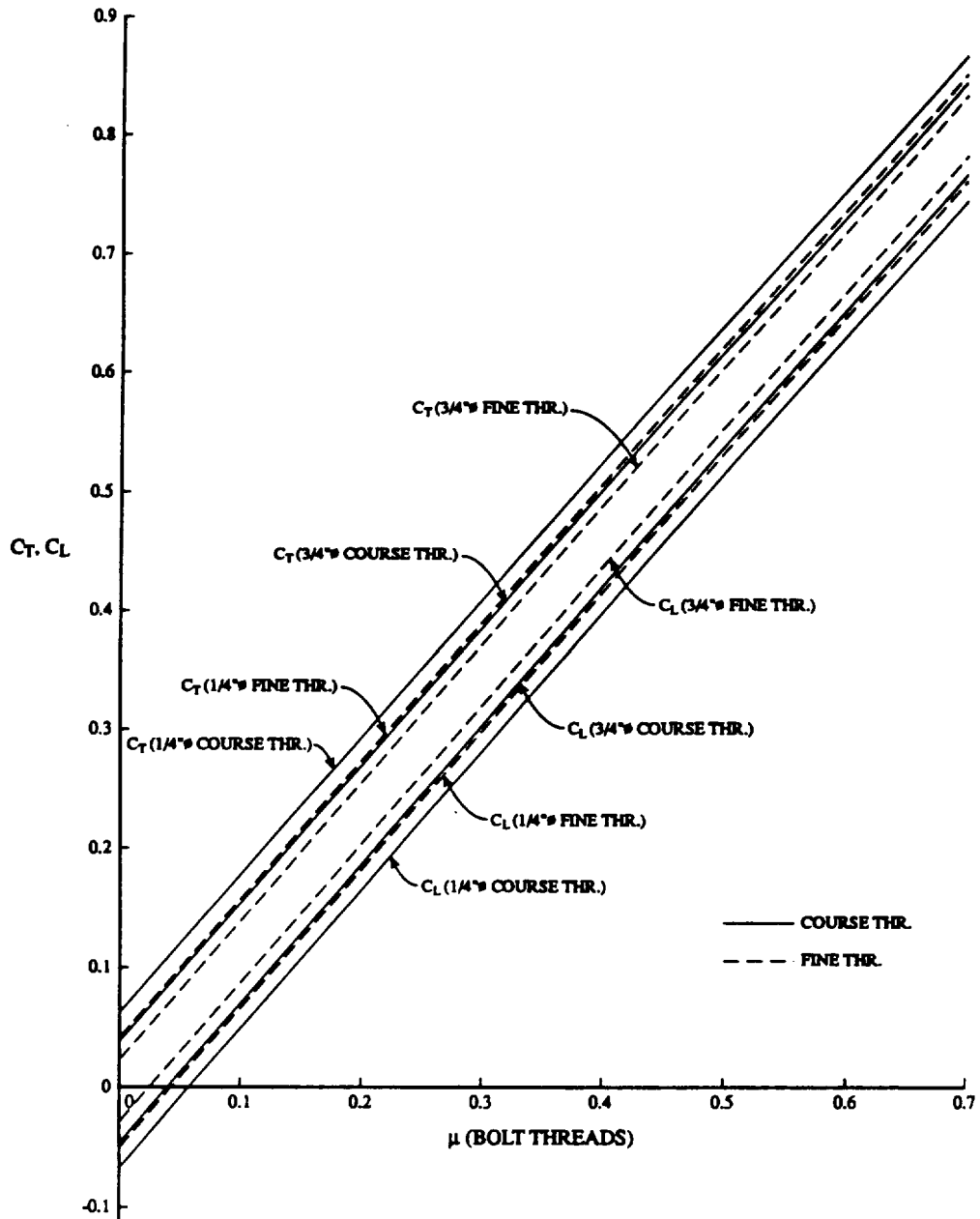

Figure 6.1 C_T and C_L vs. μ for Zero Friction Under Nut/Bolt Head.

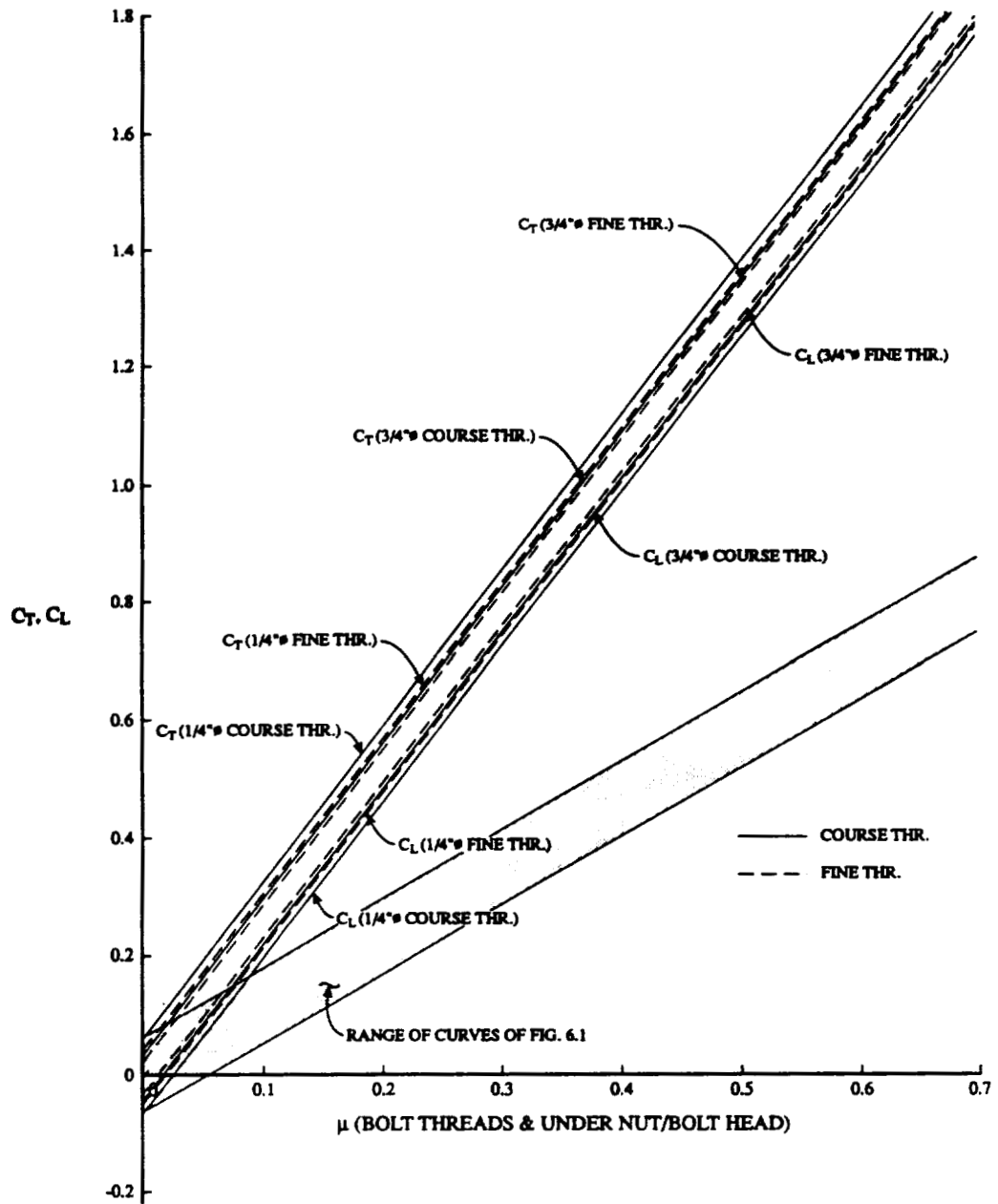

Figure 6.2 C_T and C_L vs. μ for Bolt Threads and Under Nut/Bolt Head.

6.2 Conclusions Based on Experimental Data

Conclusions drawn from analysis of the experimental data from execution of the program test matrix (96 tests), the static on-torque and off-torque testing, the confirmation testing, and the additional factorial test matrix are presented below.

1. The average value of p_{torque} for all tests in the test matrix was 0.003.
Recognizing that $0 \leq p \leq 1$, this represents an average bolt loosening of 0.3%.
Hence, very little loosening occurred in the vibration testing program.
2. The numerous negative values of p_{torque} indicate that parameter variability, noise, and experimental error were probably the main sources of Δ torque, and not bolt loosening due to vibrations.
3. Microwelding in the 2-piece test specimens mitigate relative movement of the test specimen pieces at the joint and thus mitigated bolt loosening.
4. The test data indicated that transverse loadings on the test bolts were more adverse to bolt loosening due to vibrations than axial loadings.
5. The test data indicated that the locknut ("prevailing torque device") was superior to the plain nut at mitigating bolt loosening. This is as one would expect.
6. The static torque testing results and vibration testing torque results are quite consistent and remarkably close to being the same in magnitude. This again indicated very little loss of torque or bolt loosening due to vibrations.
7. The ANOVA analysis of the adjusted torque data indicated only two parameters (E & J) were significant. Regarding factor E, the locking device, a self-locking device produced better retention of torque than did a plain nut. Regarding factor J, the joint configuration, the 1-piece test specimen/concentric loading configuration retained more torque than did the 2-piece test

specimen/eccentric loading configuration. These results statistically conformed to the predicted results in the confirmation testing. However, the actual difference between level 1 and level 2 from the confirmation runs was fairly small.

8. The ANOVA analysis of the bolt length/load data indicated four parameters (A, E, J, & L) and one three factor interaction (IxKxg) were significant. The 3/4" bolt (parameter A) retained a greater percentage of bolt load than did the 1/4" bolt. The self-locking nut (parameter E) retained a greater percentage of bolt load than did the plain nut. The 1-piece/concentric load joint configuration (parameter J) retained a greater percentage of bolt load than did the 2-piece/eccentric load configuration. The mass configuration of test specimen only (parameter L) retained a greater percentage of bolt load than did the mass configuration of test specimen plus additional mass. In regards to the IxKxg interaction, a class 2 fit (parameter I) seemed slightly more stable against noise than did a class 3 fit. Class 2 and 3 fits did behave differently against vibration, though both were sensitive to it. These results, however, did not confirm against prediction in one of the two confirmation tests, so conclusions based on the class of fit results should not be trusted.
9. As indicated in (7) and (8) above, only two sources of variation were significant at 95% confidence when compared to the variation between supposed identical samples when using the adjusted torque data and 5 sources of variation were significant when using the adjusted length/load data. Considering that there are 44 sources of variation, and that the factors in the experiment were selected for their impact on fastener loosening, this is a very small number of significant sources of variation. There are several reasons this might occur:

- The response measured (torque-on vs. torque-off or bolt load initial vs. bolt load final) might not be affected by the parameters contained within the experiment.
- The values of the parameters selected were too high (or low) to reflect the sensitivity of bolt loosening to the parameters.
- The variation between supposedly identical samples is very large.

The first reason stated above is not felt to be valid (however, more sensitive measuring instrumentation should be used in future testing). The second and third reason are felt to be primary causes of the very low bolt loosening activity and the detection of what loosening that did occur in executing the test matrix. These shortcomings must be addressed in future testing.

10. Much higher than normal bolt preloads, lighter than normal lubrication, and significant degrees of microwelding (in 2-piece test specimens) all contributed to reduce bolt loosening activity in executing the test matrix. An example of the effect of microwelding was visually observed in Test 4e when early in the vibration testing the outer cantilever rotated approximately 10° and then stopped. At the end of the test the two pieces were microwelded together and had to be separated by force.
11. The additional testing results indicate that (a) transverse loadings are much more detrimental to bolt loosening than axial loads; (b) severity of vibration loadings have a major impact on bolt loosening; (c) larger bolts in a given vibration environment are more resistant to loosening than smaller bolts; and (d) more testing is needed to determine the effects of bolt lubrication and bolt preload on bolt loosening.

12. Measuring nut on-torque and off-torque before and after vibrations exhibited considerable variability and bolt length measurements via micrometer were not sufficiently accurate. However, had considerable bolt loosening occurred in the testing, it would have been detected with the measurement system employed. The literature indicates that once relative joint micro-movement begins, bolt loosening begins and considerable to complete bolt loosening occurs in very short order. This simply did not happen in executing the test matrix with the exception of one test, Test 1h.
13. The experimental testing conducted answered many questions regarding bolt loosening, the design parameters and load parameters affecting loosening, and appropriate testing instrumentation, specimens and procedures to analyze the bolt loosening problem. However, it left many questions unanswered, and overall reflected a need for additional testing.
14. Additional small scale preliminary testing using standard off-the-shelf bolts and nuts should be conducted to more fully identify the parameters having significant impact on bolt loosening due to vibrations. The parameters observed should include both design and vibration loading parameters. Additionally, this preliminary testing should seek alternative test configurations and specimens, and a robust and sensitive bolt load monitoring/measuring device.
15. Future testing should probably use steel specimens to minimize specimen microwelding problems. This would reduce experimental "noise" and allow better assessment of the effects of the design and load parameters under investigation. Additionally, it should provide quantitative results which are conservative in predicting bolt loosening on aluminum specimens.

6.3 Recommendations

Theoretical considerations and the literature indicate the following actions to make bolted joints more resistant to vibration loosening.

1. Maintain large friction forces
 - Use a large initial bolt preload and stress bolts to a high percent of yield stress.
 - Take reasonable measures to reduce bolt relaxation and thus reduction in preload.
 - Have large coefficients of friction - do not lubricate threads and mating surfaces.
 - Use large diameter bolts.
2. Use "prevailing torque" fasteners (locknuts)
 - Consider using multiple locking devices, e.g., liquid threadlock and a locknut.
 - Consider using liquid threadlock as both an initial lubricant during bolt tightening and then having it serve as a locking device later in its life when vibrational loads are applied.
3. Use fine threaded bolts. The primary advantage of fine threaded bolts are their increased area and thus increased allowable preload. Thus, take advantage of this and preload the bolts to high levels (say 80 percent of yield stress).
4. Avoid transverse loadings on bolted joints where possible. These are the loadings that contribute most strongly to bolt loosening during vibration.
5. If the joint to be fastened requires long bolts, do not hesitate to use long bolts as they have greater elastic strain energy stored when preloaded and will require more

cycles of vibration to loosen in a successive delta loosening manner. Additionally, longer bolts tend to bend (thus they may fatigue) rather than loosen.

6. Consider using toothed shear washers to prevent slippage and thus bolt loosening.
7. Avoid impact loadings and resonant loadings where possible.
8. Introduce some form of vibration damping into the structural system and into the bolt/nut system. Nuts with nylon inserts are good for this.
9. Treat bolt design for loosening due to vibrations in a somewhat similar manner to design for fatigue loadings. That is, in fatigue design we used reduced allowable stresses and thus larger member sizes and number of bolts. Hence, in vibration loosening environments, used larger bolts and more of them than static or nonvibratory loads conditions would dictate.
10. Use a "belt and suspenders" design philosophy. That is, use as many of the above actions as practically feasible in design situations where bolt loosening due to vibrations may be a problem.

6.4 Recommendations for Future Research

Advancement of knowledge and development of user friendly design aids and procedures which make use of the advancements is in general a rather slow process. The case of bolt loosening under vibratory loads follows this general pattern.

Phase I work on this topic is reported in this publication, and has been successful in identifying the main parameters which affect bolt loosening under vibratory loadings. It was also successful in establishing effective and efficient design of experiment procedures and compatible data analysis methodologies and procedures. The Phase I work has also been successful in developing a good research team as a resource base on which to

continue the evolutionary advancement and development work needed on the topic of bolt loosening due to vibrational loads.

Future research work needed and recommended on this topic, and the sequence of that work are briefly outlined below. It is estimated that each of the additional phases recommended will need to be 1-year research efforts.

6.4.1 Phase II Work

- Develop simple bolt loosening test set-ups at Auburn University to allow evaluation of the relative importance of primary design and loading parameters on bolt loosening. The test set-ups planned are:
 - Static Torque-Tension Set-up (will utilize ultrasonic transducer to determine bolt tensions)
 - Modified Kerley Vibration Set-up
 - Bolt Vibration Testing Under Operational Loads Set-up
- Utilize test set-ups above to experimentally evaluate the effects of the primary design parameters on bolt loosening under vibrational loads.
- Refine and finalize listing of design and loading parameters to carry forward to Phase III.
- Develop Phase III Test Plan

6.4.2 Phase III Work

- Refine and finalize test specimens, test procedures, and parameters to monitor/measure in Phase III testing.

- Fabricate Phase III test specimens and procedure, test bolts, locking devices, and test/response parameter monitoring equipment.
- Execute Test Plan using MSFC shaketable and testing personnel. It is anticipated that an L_{18} orthogonal array test matrix will be conducted.
- Conduct any required retesting and confirmation tests.
- Conduct demonstrational experiments as appropriate.
- Conduct testing on simple test set-ups developed in Phase II to correlate results from those set-ups with those from the shaketable. It is anticipated that the Phase II test set-ups will produce accurate results which are compatible with those from the shaketable. If so, the Phase II set-up can be used more efficiently and effectively in further demonstrational and expansion of scope/applicability testing.

6.4.3 Phase IV Work

- Conduction of "missing gap" testing and expansion of scope testing as necessary to fill in unknowns and to expand the limits of applicability of the test results as appropriate.
- Conduct testing of additional bolt locking devices as appropriate.
- Develop "User Friendly" design aids and procedures as appropriate to assist MSFC engineers in assessing the vibrational loosening adequacy of bolted connections.

REFERENCES

1. American Institute of Steel Construction. Manual of Steel Construction, 8th Edition. AISC. 1980. pp.4.136 - 4.141.
2. Baubles, R.C., G.J. McCormick, C.C. Faroni. "Loosening of Fasteners by Vibration". Elastic Stop Nut Corporation of America. Union, NJ. December, 1966.
3. Brenner, Harry S.. "Fastener Evaluation". Machine Design. June 15, 1967. pp 28.
4. Byrne, Diane, Jim Quinlan. "Robust Function for Attaining High Reliability at Low Cost". ITEQ publication 93RM-156. Livonia, MI.
5. Chapman, Ian, John Newman, Paul Wallace. "The Tightening of Bolts to Yield and Their Performance Under Load". Journal of Vibration, Acoustics, Stress, and Reliability in Design. April 1986, Vol. 108. pp 213-221.
6. Clark, S.K.. "Static and Dynamic Testing of Self-locking Bolts". SAE Paper 824E presented March 1964 at SAE Automobile Week.
7. Clark, Samuel K., Jerald J. Cook. "Vibratory Loosening of Bolts". SAE paper No. 660432. 1966.
8. Crispell, Corey. "New Data on Fastener Fatigue". Machine Design. April 22, 1982.

9. Finkelston, Robert J.. "How Much Shake Can Bolted Joints Take?". Machine Design. October 5, 1972. pp 122-125.
10. Finkelston, R.J.. "Total Systems Approach to Mechanically Fastened Joints". SME Technical Paper AD76-652.
11. Ganguly, J.. "Fastener - Torque Model & Enhanced Reliability Under Cyclic Load". Proceedings of Annual Reliability and Maintainability Symposium. IEEE. 1992. pp. 196-201.
12. Goodier, J.N., R.J. Sweeney. "Loosening by Vibration of Threaded Fastenings". Mechanical Engineering. December 1945. pp 798-802.
13. Haviland, Girard S.. "Designing With Threaded Fasteners". Mechanical Engineering. October 1983. pp 17-31.
14. Haviland, Girard, S.. "Machinery Adhesives for Locking, Retaining, and Sealing". Marcel Dekker, Inc.. 270 Madison Avenue. New York, NY. 1986. pp 190-219.
15. Hicks, Charles R.. Fundamental Concepts in the Design of Experiments, 3rd Edition. Saunders College Publishing. Fort Worth, TX. 1982.
16. Holmes, Horace. "A Spiral Lock for Threaded Fasteners". Mechanical Engineering. May 1988. pp 36-39.
17. Industrial Fasteners Institute. Fastener Standards, 6th Edition. Industrial Fasteners Institute. Cleveland, OH. 1988.
18. Junker, Gerhard H.. "New Criteria for Self-Loosening of Fasteners Under Vibration". SAE paper No. 690055. 1969.

19. Kerley, James J.. "An Application of Retrodution to Analyzing and Testing the Backing Off of Nuts and Bolts During Dynamic Loading". NASA Technical Memorandum 4001. June 1987.
20. Meriam, J.L. and L.G. Kraige. Engineering Mechanics Volume I Statics, 3rd Edition. John Wiley and Sons. New York. June, 1992. pp. 370-379.
21. Montgomery, Douglas C.. Design and Analysis of Experiments, 3rd Edition. John Wiley and Sons. New York. 1986.
22. Peace, Glen Stuart. Taguchi Methods, a Hands-on Approach. Addison-Wesley Publishing Company, Inc.. Reading, Massachusetts. 1993.
23. Sauer, J.A., D.C. Lemmon, E.K. Lynn. "Bolts How to Prevent Their Loosening". Machine Design. August 1950. pp 133-139.
24. Shigley, Joseph Edward. Mechanical Engineering Design, 2nd Edition. McGraw-Hill Book Company. New York, NY. 1972. pp 292-311.
25. Taguchi, G., S. Konishi. Taguchi Methods, Orthogonal Arrays and Linear Graphs, Tools for Quality Engineering. American Supplier Institute, Inc.. Dearborn, MI. 1987.

APPENDICES

APPENDIX A
TEST SET-UPS

Setup 1

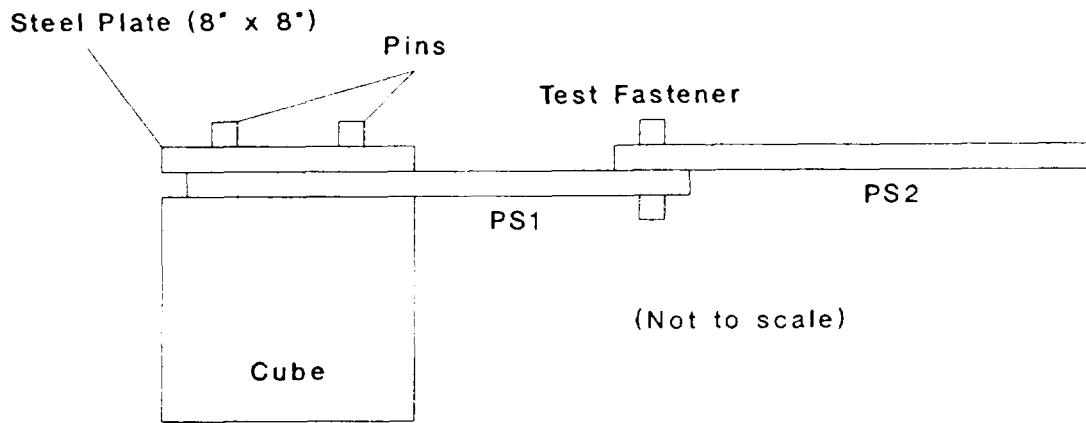

Test Set-up #1

Fixture ID	PS1 & PS2
Bolt ID	1/4-20 UNC-2A
Nut ID	1/4-20 UNC-2B
End Mass ID	None
Mass Bolt ID	None
Mass Nut ID	None
Spacer ID	None
Fastener Size	1/4" diam.
Lubrication (threads)	None
Hole Tolerance	Oversize
Pre-load	40% yield
Nut Locking Device	None
Grip Length	0.5"
Pitch (thds/in)	20
Lubricant (mating materials)	None
Class of Fit	2
Joint Configuration	Eccentric
Mass of Configuration	MPS2

Setup 2

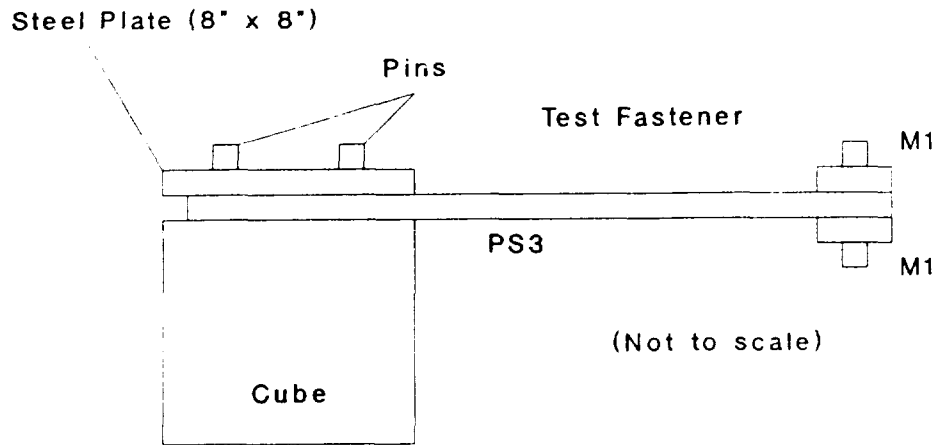

Test Set-up #2

Fixture ID	PS3
Bolt ID	1/4-28 UNF-3A
Nut ID	1/4-28 UNF-3B
End Mass ID	M1
Mass Bolt ID	None
Mass Nut ID	None
Spacer ID	None
Fastener Size	1/4" diam.
Lubrication (threads)	None
Hole Tolerance	Oversize
Pre-load	40% yield
Nut Locking Device	None
Grip Length	1.0"
Pitch (thds/in)	28
Lubricant (mating materials)	Tri-Flow
Class of Fit	3
Joint Configuration	Concentric
Mass of Configuration	M1

Setup 3

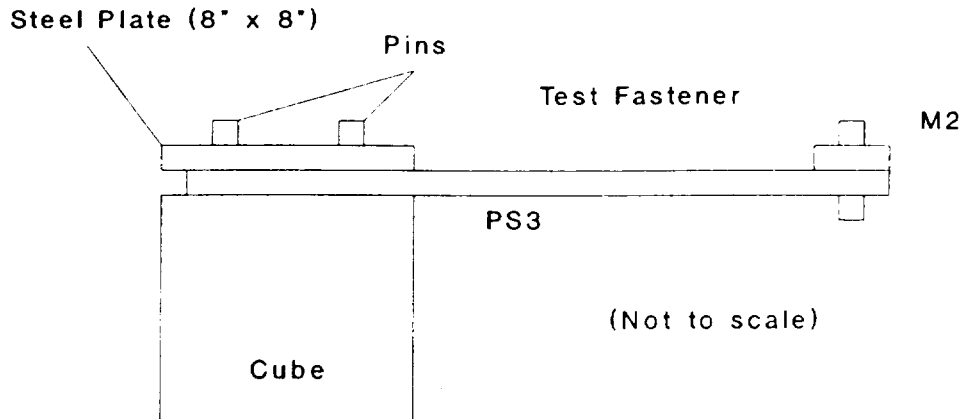

Test Set-up #3

Fixture ID	PS3
Bolt ID	1/4-20 UNC-3A
Nut ID	1/4-20 UNC-3B
End Mass ID	M2
Mass Bolt ID	None
Mass Nut ID	None
Spacer ID	None
Fastener Size	1/4" diam.
Lubrication (threads)	None
Hole Tolerance	Tight
Pre-load	80% yield
Nut Locking Device	Nylon Insert
Grip Length	0.5"
Pitch (thds/in)	20
Lubricant (mating materials)	None
Class of Fit	3
Joint Configuration	Concentric
Mass of Configuration	M2

Setup 4

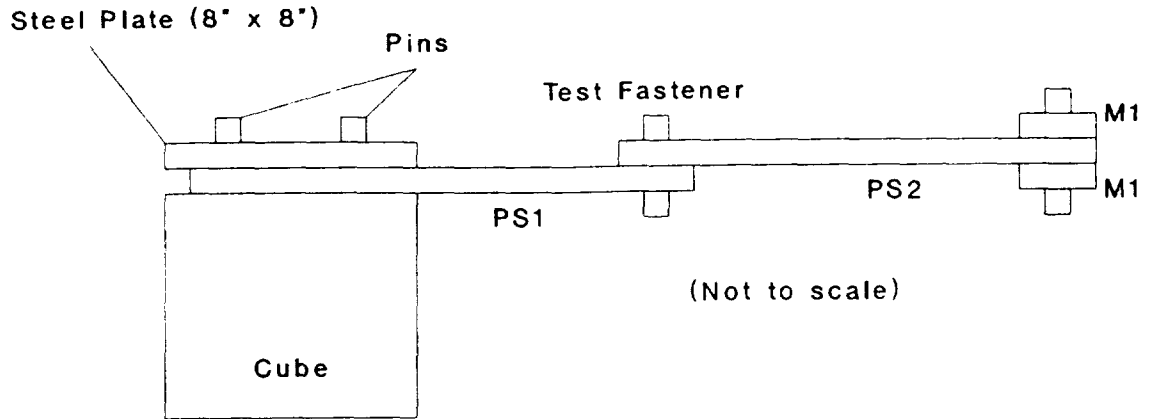

Test Set-up #4

Fixture ID	PS1 & PS2
Bolt ID	1/4-28 UNF-2A
Nut ID	1/4-28 UNF-2B
End Mass ID	M1
Mass Bolt ID	3/4-16 UNF-2A
Mass Nut ID	3/4-16 UNF-2B
Spacer ID	None
Fastener Size	1/4" diam.
Lubrication (threads)	Tri-Flow
Hole Tolerance	Oversize
Pre-load	40% yield
Nut Locking Device	Nylon Insert
Grip Length	0.5"
Pitch (thds/in)	28
Lubricant (mating materials)	Tri-Flow
Class of Fit	2
Joint Configuration	Eccentric
Mass of Configuration	MPS2 + M1

Setup 5

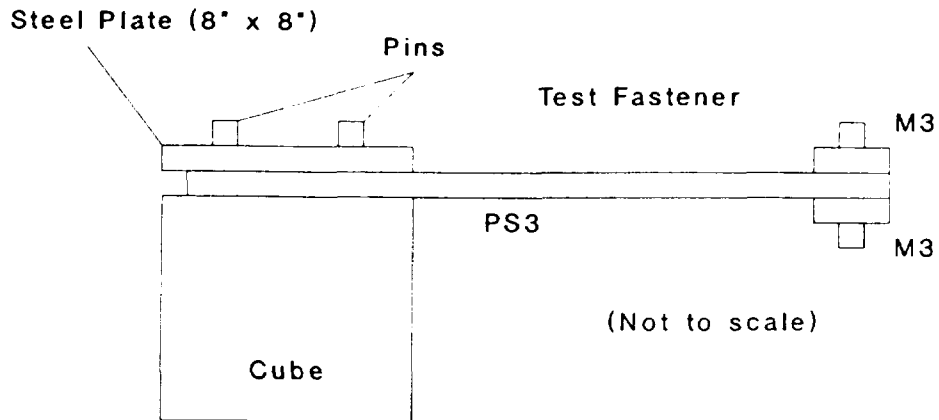

Test Set-up #5

Fixture ID	PS3
Bolt ID	1/4-20 UNC-2A
Nut ID	1/4-20 UNC-2B
End Mass ID	M3
Mass Bolt ID	None
Mass Nut ID	None
Spacer ID	None
Fastener Size	1/4" diam.
Lubrication (threads)	Tri-Flow
Hole Tolerance	Tight
Pre-load	80% yield
Nut Locking Device	Nylon Insert
Grip Length	1.0"
Pitch (thds/in)	20
Lubricant (mating materials)	Tri-Flow
Class of Fit	2
Joint Configuration	Concentric
Mass of Configuration	M3

Setup 6

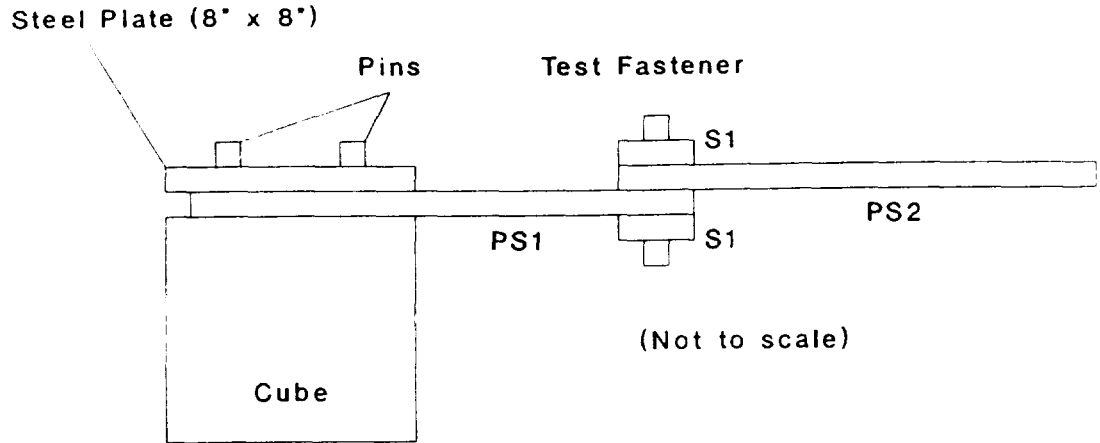

Test Set-up #6

Fixture ID	PS1 & PS2
Bolt ID	1/4-28 UNF-3A
Nut ID	1/4-28 UNF-3B
End Mass ID	None
Mass Bolt ID	None
Mass Nut ID	None
Spacer ID	S1 (0.5" Total)
Fastener Size	1/4" diam.
Lubrication (threads)	Tri-Flow
Hole Tolerance	Tight
Pre-load	80% yield
Nut Locking Device	None
Grip Length	1.0"
Pitch (thds/in)	28
Lubricant (mating materials)	None
Class of Fit	3
Joint Configuration	Eccentric
Mass of Configuration	MPS2

Setup 7

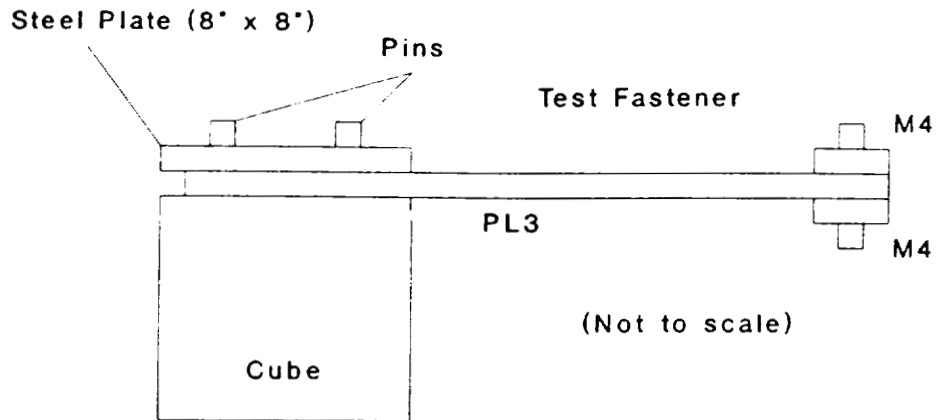

Test Set-up #7

Fixture ID	PL3
Bolt ID	3/4-16 UNF-2A
Nut ID	3/4-16 UNF-2B
End Mass ID	M4
Mass Bolt ID	None
Mass Nut ID	None
Spacer ID	None
Fastener Size	3/4" diam.
Lubrication (threads)	None
Hole Tolerance	Tight
Pre-load	80% yield
Nut Locking Device	None
Grip Length	1.0"
Pitch (thds/in)	16
Lubricant (mating materials)	Tri-Flow
Class of Fit	2
Joint Configuration	Concentric
Mass of Configuration	M4

Setup 8

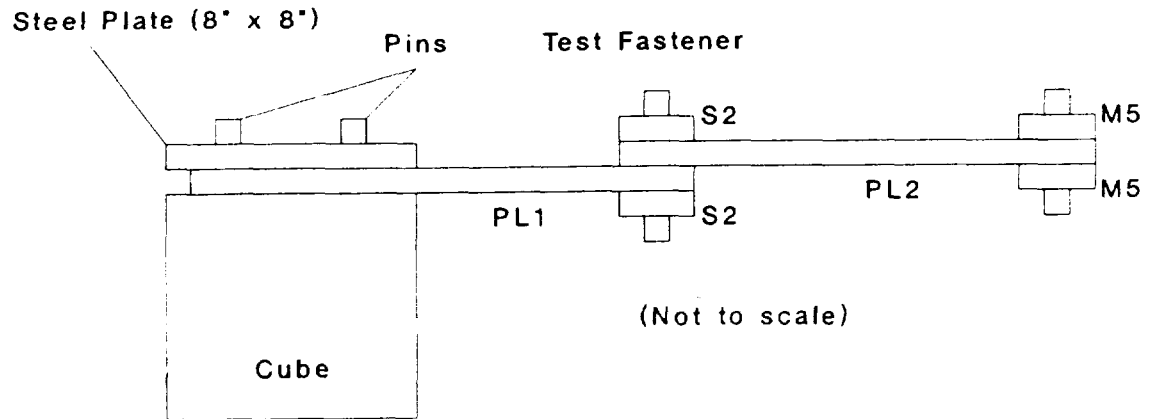

Test Set-up #8

Fixture ID	PL1 & PL2
Bolt ID	3/4-16 UNF-2A
Nut ID	3/4-16 UNF-2B
End Mass ID	M5
Mass Bolt ID	3/4-16 UNF-2A
Mass Nut ID	3/4-16 UNF-2B
Spacer ID	S2 (1.0" Total)
Fastener Size	3/4" diam.
Lubrication (threads)	None
Hole Tolerance	Tight
Pre-load	80% yield
Nut Locking Device	Nylon Insert
Grip Length	2.0"
Pitch (thds/in)	16
Lubricant (mating materials)	None
Class of Fit	2
Joint Configuration	Concentric
Mass of Configuration	MPL2 + M5

Setup 9

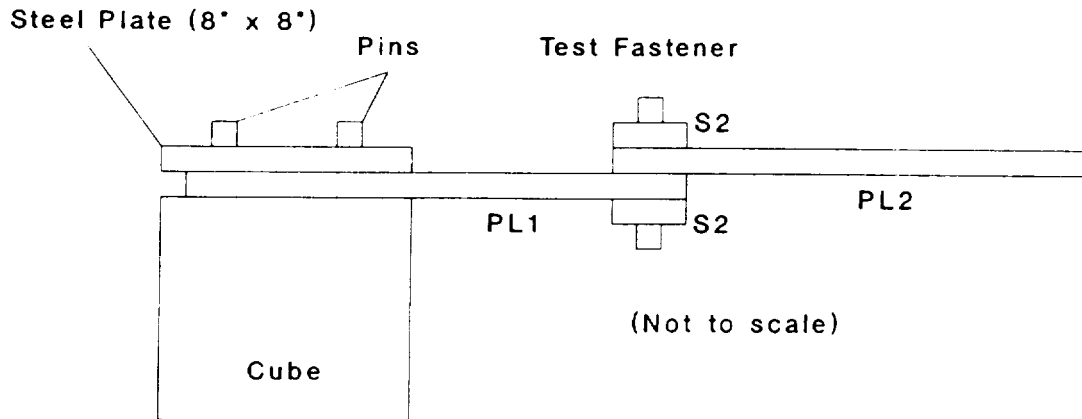

Test Set-up #9

Fixture ID	PL1 & PL2
Bolt ID	3/4-10 UNC-3A
Nut ID	3/4-10 UNC-3B
End Mass ID	None
Mass Bolt ID	None
Mass Nut ID	None
Spacer ID	S2 (1.0" Total)
Fastener Size	3/4" diam.
Lubrication (threads)	None
Hole Tolerance	Oversize
Pre-load	40% yield
Nut Locking Device	Nylon Insert
Grip Length	2.0"
Pitch (thds/in)	10
Lubricant (mating materials)	Tri-Flow
Class of Fit	3
Joint Configuration	Eccentric
Mass of Configuration	MPL2

Setup 10

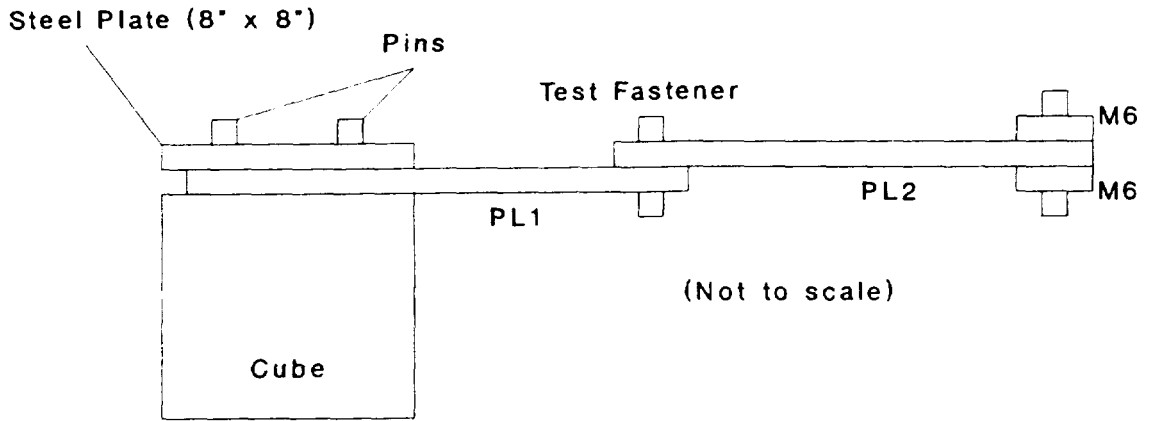

Test Set-up #10

Fixture ID	PL1 & PL2
Bolt ID	3/4-10 UNC-3A
Nut ID	3/4-10 UNC-3B
End Mass ID	M6
Mass Bolt ID	3/4-16 UNF-2A
Mass Nut ID	3/4-16 UNF-2B
Spacer ID	None
Fastener Size	3/4" diam.
Lubrication (threads)	Tri-Flow
Hole Tolerance	Tight
Pre-load	80% yield
Nut Locking Device	None
Grip Length	1.0"
Pitch (thds/in)	10
Lubricant (mating materials)	Tri-Flow
Class of Fit	3
Joint Configuration	Eccentric
Mass of Configuration	MPL2 + M6

Setup 11

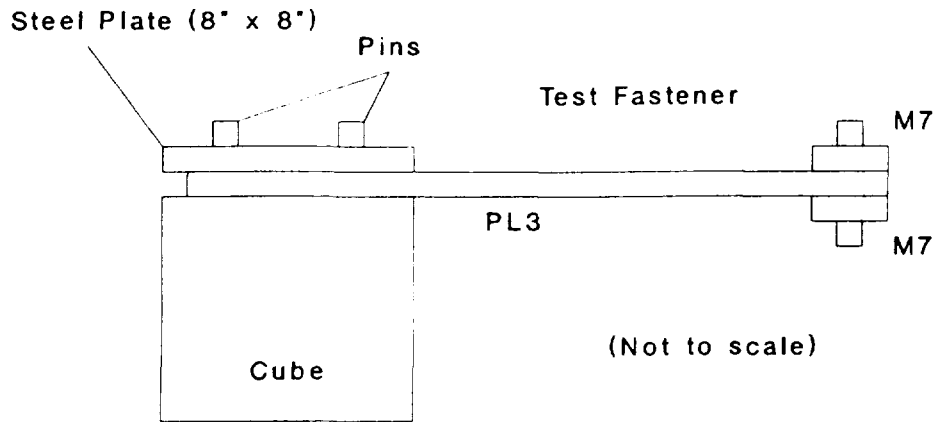

Test Set-up #11

Fixture ID	PL3
Bolt ID	3/4-10 UNC-2A
Nut ID	3/4-10 UNC-2B
End Mass ID	M7
Mass Bolt ID	None
Mass Nut ID	None
Spacer ID	None
Fastener Size	3/4" diam.
Lubrication (threads)	Tri-Flow
Hole Tolerance	Oversize
Pre-load	40% yield
Nut Locking Device	None
Grip Length	2.0"
Pitch (thds/in)	10
Lubricant (mating materials)	None
Class of Fit	2
Joint Configuration	Concentric
Mass of Configuration	M7

Setup 12

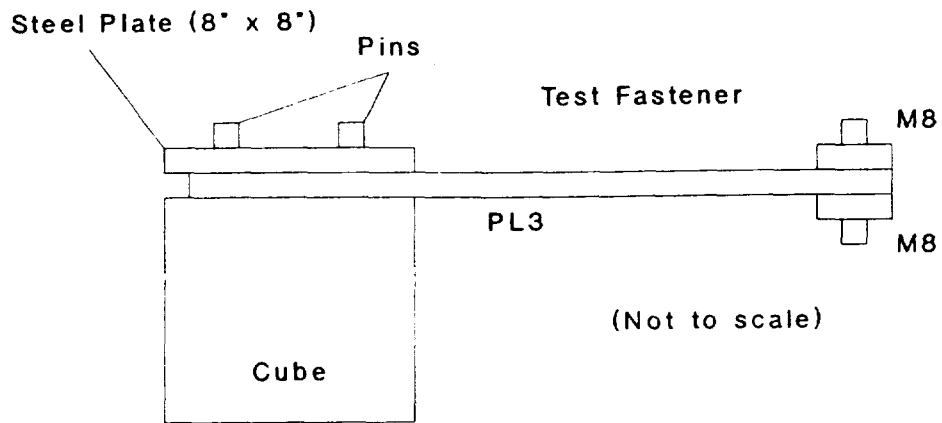

Test Set-up #12

Fixture ID	PL3
Bolt ID	3/4-16 UNF-3A
Nut ID	3/4-16 UNF-3B
End Mass ID	M8
Mass Bolt ID	None
Mass Nut ID	None
Spacer ID	None
Fastener Size	3/4" diam.
Lubrication (threads)	Tri-Flow
Hole Tolerance	Oversize
Pre-load	40% yield
Nut Locking Device	Nylon Insert
Grip Length	1.0"
Pitch (thds/in)	16
Lubricant (mating materials)	None
Class of Fit	3
Joint Configuration	Concentric
Mass of Configuration	M8

APPENDIX B
FABRICATION PROCUREMENT DRAWINGS
AND
LISTINGS FOR TEST SPECIMENS, BOLTS, AND NUTS

TOLERANCES
XX - ±0.030

MATERIAL
AL 8061-T8

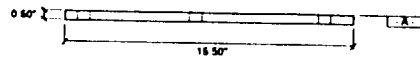
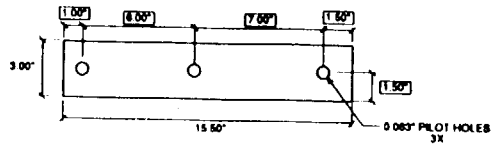

PL1 (5 REQD)

TOLERANCES
XX - ±0.030

MATERIAL
AL 8061-T8

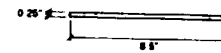
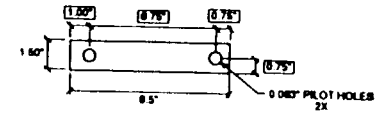

PS2 (5 REQD)

TOLERANCES
XX - ±0.030

MATERIAL
AL 8061-T8

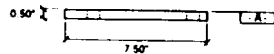
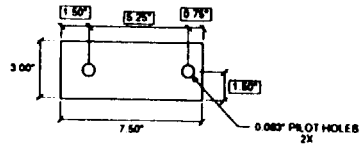

PL2 (5 REQD)

TOLERANCES
XX - ±0.030

MATERIAL
AL 8061-T8

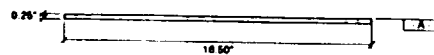
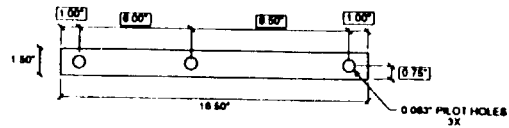

PS1 (5 REQD)

AUBURN UNIVERSITY DEPARTMENT OF CIVIL ENGINEERING	
MSFC BOLT LOOSENING PROJECT	
DESIGNED BY: RCJ	DATE: 11-30-93
DRAWN BY: R S.	REVISED 12-20-93
SHEET NO 1 OF 2	

TOLERANCES
XX = ±0.030

MATERIAL
AL 6061-T6

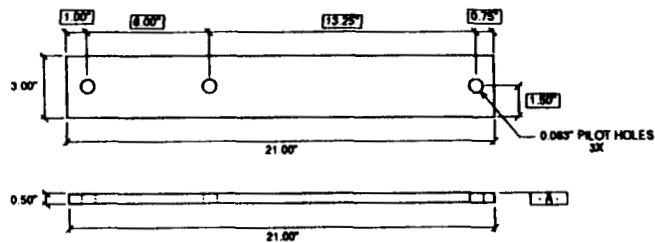

PL3 (5 REQD)

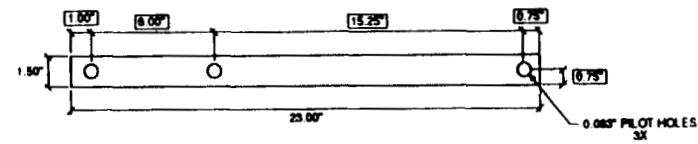

PS3 (5 REQD)

TOLERANCES
XX = ±0.030

MATERIAL
A36 STEEL

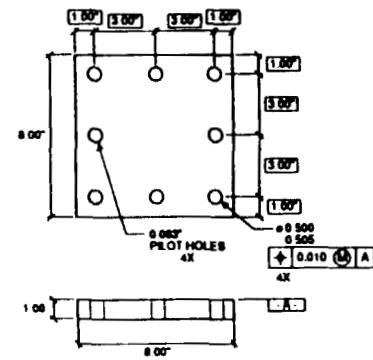

CPU (2 REQD)

AUBURN UNIVERSITY DEPARTMENT OF CIVIL ENGINEERING	
MSFC BOLT LOOSENING PROJECT	
DESIGNED BY: RCJ	DATE: 11-30-93
DRAWN BY: R.S.	REVISED: 12-20-93
SHEET NO. 2 OF 2	

TOLERANCES
XX = ±0.030

MATERIAL
A36 STEEL

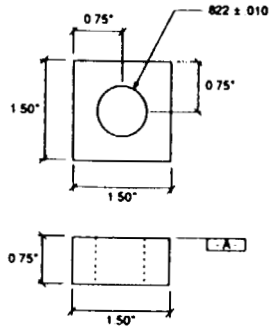

M1 (1 REQD)

TOLERANCES
XX = ±0.030

MATERIAL
A36 STEEL

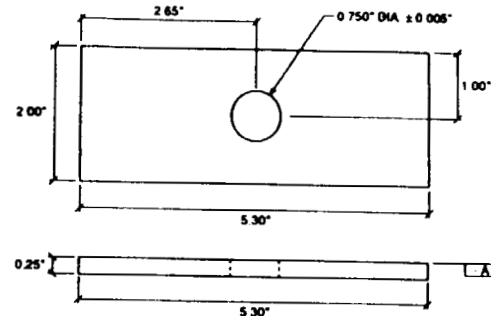

M4 (1 REQD)

TOLERANCES
XX = ±0.030

MATERIAL
A36 STEEL

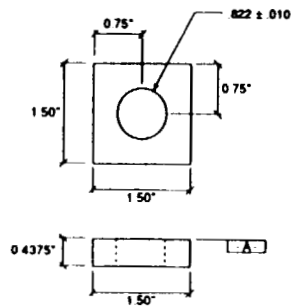

M2 (1 REQD)

TOLERANCES
XX = ±0.030

MATERIAL
A36 STEEL

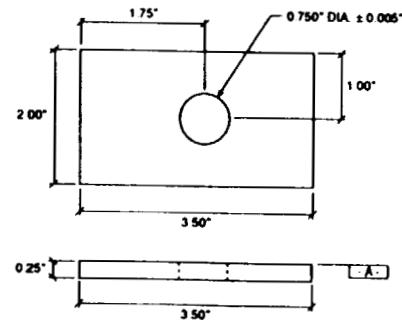

M3 (1 REQD)

AUBURN UNIVERSITY DEPARTMENT OF CIVIL ENGINEERING	
MSFC BOLT LOOSENING PROJECT	
DESIGNED BY: RCJ	DATE 11-30-93
DRAWN BY: R S	REVISED 1-18-94
SHEET NO. 3 OF 5	

TOLERANCES
XX = ±0.030

MATERIAL
A36 STEEL

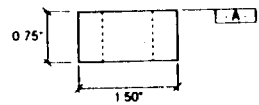
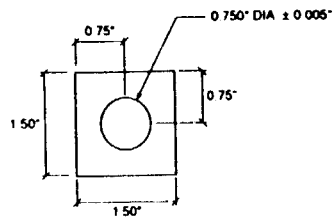

M5 (1 REQD)

TOLERANCES
XX = ±0.030

MATERIAL
A36 STEEL

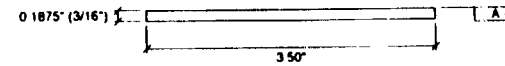
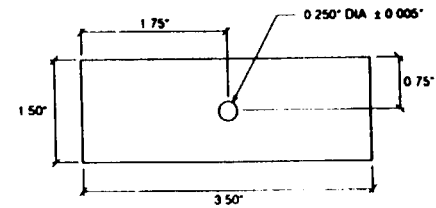

M7 (1 REQD)

TOLERANCES
XX = ±0.030

MATERIAL
A36 STEEL

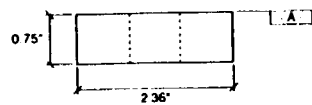
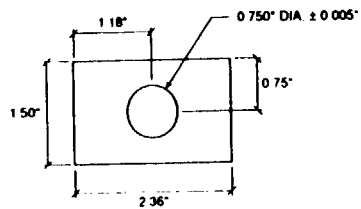

M6 (1 REQD)

AUBURN UNIVERSITY DEPARTMENT OF CIVIL ENGINEERING	
MSFC BOLT LOOSENING PROJECT	
DESIGNED BY RCJ	DATE 11 30 93
DRAWN BY R S	REVISED 1-18-94
SHEET NO 4 OF 5	

TOLERANCES
XX = ±0.030

MATERIAL
A36 STEEL

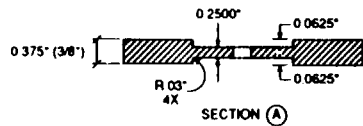
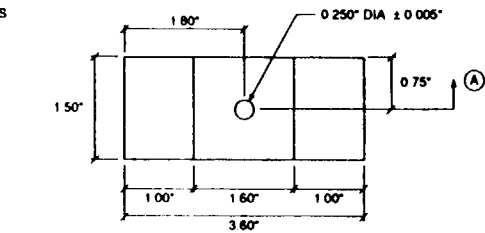

MB (1 REQD)

TOLERANCES
XX = ±0.030

MATERIAL
A36 STEEL

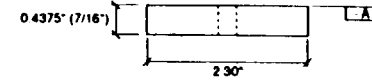
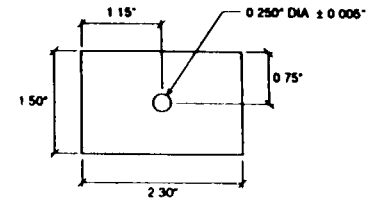

M10 (1 REQD)

TOLERANCES
XX = ±0.030

MATERIAL
A36 STEEL

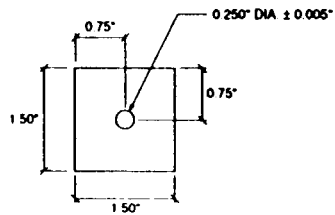

MB (1 REQD)

AUBURN UNIVERSITY DEPARTMENT OF CIVIL ENGINEERING	
MSFC BOLT LOOSENING PROJECT	
DESIGNED BY: RCJ	DATE: 11-30-93
DRAWN BY: R S	REVISED: 1-18-94
SHEET NO 5 OF 5	

BOLT/NUT REQUIREMENTS					
Item No	Description	Specification	Length Under Head (in.)	Quantity	Task No
1	1/4" Bolt-Class 2 & Coarse Thread	1/4-20 UNC-2A MS 16208-8	1.25	10	1
	Mating Plain Nut	1/4-20 UNC-2B MS 35692-3		10	
2	1/4" Bolt-Class 3 & Fine Thread	1/4-28 UNRF-3A NAS 1351C-4-32	2.0	10	2
	Mating Plain Nut	1/4-28 UNF-3B MS 9356-10		10	
3	1/4" Bolt-Class 1 & Coarse Thread	1/4-20 UNRC-3A NAS 1352C-4-24	1.50	10	3
	Mating Self-Locking Nut	1/4-20 UNC-3B MS 16228-4C		10	
4	1/4" Bolt-Class 2 & Fine Thread	1/4-28 UNRF-2A MS 35308-310	1.25	10	4
	Mating Self-Locking Nut	1/4-28 UNF-2B MS 51922-6		10	
5	1/4" Bolt-Class 2 & Coarse Thread	1/4-20 UNC-2A MS 16208-11	2.0	10	5
	Mating Self-Locking Nut	1/4-20 UNC-2B MS 51992-2		10	
6	1/4" Bolt-Class 3 & Fine Thread	1/4-28 UNRF-3A NAS 1351C-4-32	2.0	20	6 A1 B1
	Mating Self-Locking Nut	1/4-28 UNF-3B MS 21044-C4		5	
	Mating Plain Nut	1/4-28 UNF-3B MS 9356-10		15	
7	3/4" Bolt-Class 2 & Fine Thread	3/4-16 UNF-2A MS 35308-490	2.75	10	7
	Mating Plain Nut	3/4-16 UNF-2B MS 35692-43		10	
8	3/4" Bolt-Class 2 & Fine Thread	3/4-16 UNF-2A MS 35308-494	3.75	10	8
	Mating Self-Locking Nut	3/4-16 UNF-2B MS 51922-62		10	
9	3/4" Bolt-Class 3 & Coarse Thread	3/4-10 UNRC-3A NAS 1352C-12-56	3.5	10	9
	Mating Self-Locking Nut	3/4-10 UNC-3B MS 16228-12C		10	
10	3/4" Bolt-Class 3 & Coarse Thread	3/4-10 UNRC-3A NAS 1352-12-44	2.75	10	10
	Mating Plain Nut	3/4-10 UNC-3B MS 16228-12C(*)		10	
11	3/4" Bolt-Class 2 & Coarse Thread	3/4-10 UNC-2A MS 16208-173	3.75	10	11
	Mating Plain Nut	3/4-10 UNC-2B MS 35692-59		10	
12	3/4" Bolt-Class 3 & Fine Thread	3/4-16 UNRF-3A NAS 1351C-12-44	2.75	20	12 A2 B2
	Mating Self-Locking Nut	3/4-16 UNF-3B MS 21044-C12		15	
	Mating Plain Nut	3/4-16 UNF-3B MS 9356-17		5	
13	3/4" Bolt-Class 2 & Fine Thread	3/4-16 UNF-2A MS 35308-493	3.0	2	
	Mating Self-Locking Nut	3/4-16 UNF-2B MS 51922-62			
14	3/4" Bolt-Class 2 & Fine Thread	3/4-16 UNF-2A MS 35308-488	2.25	2	
	Mating Self-Locking Nut	3/4-16 UNF-2B MS 51922-62			
15	1/2" Pin Spring x 4" Long	MS 171790	4.0	208	All

(*) Insert to be removed

**ORIGINAL PAGE IS
OF POOR QUALITY.**

APPENDIX C
EXECUTION OF TEST MATRIX DATA

		(in)
Test #1a		Length chng.
Length before testing	1.5116	
Length after torquing	1.5147	0.0031
Length after sine-sweep	1.5147	0.0031
Length after burnishing	1.5130	0.0014
Length after level-1	1.5130	0.0014

Length Chng.	0.0014
Stress Chng.	0

(in*lb)	
On-torque	85
Off-torque	40

Torq. Chng.	45
-------------	----

		(in)
Test #1b		Length chng.
Length before testing	1.5111	
Length after torquing	1.5135	0.0024
Length after burnishing	1.5125	0.0014
Length after level-1	1.5122	0.0011

Length Chng.	0.0011
Stress Chng.	-17.4

(in*lb)	
On-torque	85
Off-torque	55

Torq. Chng.	30
-------------	----

		(in)
Test #1c		Length chng.
Length before testing	1.5175	
Length after torquing	1.5202	0.0027
Length after burnishing	1.5193	0.0018
Length after level-2	1.5193	0.0018

Length Chng.	0.0018
Stress Chng.	0

(in*lb)	
On-torque	85
Off-torque	75

Torq. Chng.	10
-------------	----

		(in)
Test #1d		Length chng.
Length before testing	1.5138	
Length after torquing	1.5151	0.0013
Length after burnishing	1.5148	0.0010
Length after level-2	1.5145	0.0007

Length Chng.	0.0007
Stress Chng.	-17.4

(in*lb)	
On-torque	95
Off-torque	85

Torq. Chng.	10
-------------	----

Test #1e		(in) Length chng.
Length before testing	1.5111	
Length after torquing	1.5128	0.0017
Length after sine-sweep	1.5128	0.0017
Length after burnishing	1.5128	0.0017
Length after level-1	1.5116	0.0005

Length Chng.	0.0005
Stress Chng.	-69.6

(in*lb)	
On-torque	85
Off-torque	50

Torq. Chng.	35
-------------	----

Test #1f		(in) Length chng.
Length before testing	1.5098	
Length after torquing	1.5114	0.0016
Length after burnishing	1.5112	0.0014
Length after level-1	1.5107	0.0009

Length Chng.	0.0009
Stress Chng.	-29

(in*lb)	
On-torque	85
Off-torque	50

Torq. Chng.	35
-------------	----

Test #1g		(in) Length chng.
Length before testing	1.5161	
Length after torquing	1.5178	0.0017
Length after burnishing	1.5175	0.0014
Length after level-2	1.5161	0.0000

Length Chng.	0.0000
Stress Chng.	-81.2

(in*lb)	
On-torque	85
Off-torque	70

Torq. Chng.	15
-------------	----

Test #1h		(in) Length chng.
Length before testing	1.5163	
Length after torquing	1.5175	0.0012
Length after burnishing	1.5175	0.0012
Length after level-2	1.5163	0.0000

Length Chng.	0.0000
Stress Chng.	-69.6

(in*lb)	
On-torque	85
Off-torque	0

Torq. Chng.	85*
-------------	-----

* Total loss of preload

Test #2a		(in) Length chng.
Length before testing	2.2246	
Length after torquing	2.2271	0.0025
Length after sine-sweep	2.2269	0.0023
Length after burnishing	2.2269	0.0023
Length after level-1	2.2269	0.0023

Length Chng.	0.0023
Stress Chng.	0

(in*lb)	
On-torque	95
Off-torque	80

Torq. Chng.	15
-------------	----

Test #2b		(in) Length chng.
Length before testing	2.2253	
Length after torquing	2.2275	0.0022
Length after burnishing	2.2263	0.0010
Length after level-1	2.2262	0.0009

Length Chng.	0.0009
Stress Chng.	-2.9

(in*lb)	
On-torque	95
Off-torque	80

Torq. Chng.	15
-------------	----

Test #2c		(in) Length chng.
Length before testing	2.2273	
Length after torquing	2.2306	0.0033
Length after burnishing	2.2301	0.0028
Length after level-2	2.2284	0.0011

Length Chng.	0.0011
Stress Chng.	-49.3

(in*lb)	
On-torque	95
Off-torque	75

Torq. Chng.	20
-------------	----

Test #2d		(in) Length chng.
Length before testing	2.2242	
Length after torquing	2.2266	0.0024
Length after burnishing	2.2266	0.0024
Length after level-2	2.2266	0.0024

Length Chng.	0.0024
Stress Chng.	0

(in*lb)	
On-torque	95
Off-torque	70

Torq. Chng.	25
-------------	----

Test #2e		(in) Length chng.
Length before testing	2.2236	
Length after torquing	2.2260	0.0024
Length after sine-sweep	2.2260	0.0024
Length after burnishing	2.2260	0.0024
Length after level-1	2.2243	0.0007

Length Chng.	0.0007
Stress Chng.	-49.3

(in*lb)	
On-torque	90
Off-torque	65

Torq. Chng.	25
-------------	----

Test #2f		(in) Length chng.
Length before testing	2.2261	
Length after torquing	2.2287	0.0026
Length after burnishing	2.2283	0.0022
Length after level-1	2.2260	-0.0001

Length Chng.	-0.0001
Stress Chng.	-66.7

(in*lb)	
On-torque	90
Off-torque	70

Torq. Chng.	20
-------------	----

Test #2g		(in) Length chng.
Length before testing	2.2225	
Length after torquing	2.2250	0.0025
Length after burnishing	2.2249	0.0024
Length after level-2	2.2249	0.0024

Length Chng.	0.0024
Stress Chng.	0

(in*lb)	
On-torque	90
Off-torque	65

Torq. Chng.	25
-------------	----

Test #2h		(in) Length chng.
Length before testing	2.2200	
Length after torquing	2.2227	0.0027
Length after burnishing	2.2227	0.0027
Length after level-2	2.2214	0.0014

Length Chng.	0.0014
Stress Chng.	-37.7

(in*lb)	
On-torque	95
Off-torque	65

Torq. Chng.	30
-------------	----

		(in)
Test #3a		Length chng.
Length before testing	1.2317	
Length after torquing	1.2340	0.0023
Length after sine-sweep	1.2340	0.0023
Length after burnishing	1.2340	0.0023
Length after level-1	1.2332	0.0015

Length Chng.	0.0015
Stress Chng.	-46.4

(in*lb)	
On-torque	150
Off-torque	100

Torq. Chng.	50
-------------	----

		(in)
Test #3b		Length chng.
Length before testing	1.2321	
Length after torquing	1.2344	0.0023
Length after burnishing	1.2342	0.0021
Length after level-1	1.2335	0.0014

Length Chng.	0.0014
Stress Chng.	-40.6

(in*lb)	
On-torque	150
Off-torque	100

Torq. Chng.	50
-------------	----

		(in)
Test #3c		Length chng.
Length before testing	1.2400	
Length after torquing	1.2435	0.0035
Length after burnishing	1.2430	0.0030
Length after level-2	1.2430	0.0030

Length Chng.	0.0030
Stress Chng.	0

(in*lb)	
On-torque	140
Off-torque	110

Torq. Chng.	30
-------------	----

		(in)
Test #3d		Length chng.
Length before testing	1.2343	
Length after torquing	1.2369	0.0026
Length after burnishing	1.2368	0.0025
Length after level-2	1.2365	0.0022

Length Chng.	0.0022
Stress Chng.	-17.4

(in*lb)	
On-torque	140
Off-torque	110

Torq. Chng.	30
-------------	----

Test #3e	(in) Length chng.	
Length before testing	1.2365	
Length after torquing	1.2390	0.0025
Length after sine-sweep	1.2390	0.0025
Length after burnishing	1.2389	0.0024
Length after level-1	1.2375	0.0010

Length Chng.	0.0010
Stress Chng.	-81.2

(in*lb)	
On-torque	140
Off-torque	90

Torq. Chng.	50
-------------	----

Test #3f	(in) Length chng.	
Length before testing	1.2335	
Length after torquing	1.2363	0.0028
Length after burnishing	1.2363	0.0028
Length after level-1	1.2360	0.0025

Length Chng.	0.0025
Stress Chng.	-17.4

(in*lb)	
On-torque	150
Off-torque	100

Torq. Chng.	50
-------------	----

Test #3g	(in) Length chng.	
Length before testing	1.2356	
Length after torquing	1.2385	0.0029
Length after burnishing	1.2384	0.0028
Length after level-2	1.2368	0.0012

Length Chng.	0.0012
Stress Chng.	-92.8

(in*lb)	
On-torque	150
Off-torque	110

Torq. Chng.	40
-------------	----

Test #3h	(in) Length chng.	
Length before testing	1.2374	
Length after torquing	1.2413	0.0039
Length after burnishing	1.2410	0.0036
Length after level-2	1.2405	0.0031

Length Chng.	0.0031
Stress Chng.	-29

(in*lb)	
On-torque	150
Off-torque	80

Torq. Chng.	70
-------------	----

		(in)
Test #4a		Length chng.
Length before testing	1.4070	
Length after torquing	1.4085	0.0015
Length after sine-sweep	1.4085	0.0015
Length after burnishing	1.4085	0.0015
Length after level-1	1.4075	0.0005

Length Chng.	0.0005
Stress Chng.	-58

(in*lb)	
On-torque	90
Off-torque	50

Torq. Chng.	40
-------------	----

		(in)
Test #4b		Length chng.
Length before testing	1.4215	
Length after torquing	1.4230	0.0015
Length after burnishing	1.4230	0.0015
Length after level-1	1.4221	0.0006

Length Chng.	0.0006
Stress Chng.	-52.2

(in*lb)	
On-torque	110
Off-torque	80

Torq. Chng.	30
-------------	----

		(in)
Test #4c		Length chng.
Length before testing	1.4211	
Length after torquing	1.4230	0.0019
Length after burnishing	1.4230	0.0019
Length after level-2	1.4230	0.0019

Length Chng.	0.0019
Stress Chng.	0

(in*lb)	
On-torque	100
Off-torque	80

Torq. Chng.	20
-------------	----

		(in)
Test #4d		Length chng.
Length before testing	1.4017	
Length after torquing	1.4025	0.0008
Length after burnishing	1.4025	0.0008
Length after level-2	1.4020	0.0003

Length Chng.	0.0003
Stress Chng.	-29

(in*lb)	
On-torque	100
Off-torque	70

Torq. Chng.	30
-------------	----

Test #4e		(in) Length chng.
Length before testing	1.4244	
Length after torquing	1.4260	0.0016
Length after sine-sweep	1.4260	0.0016
Length after burnishing	1.4265	0.0021
Length after level-1	1.4260	0.0016

Length Chng.	0.0016
Stress Chng.	-29

Test #4f		(in) Length chng.
Length before testing	1.4248	
Length after torquing	1.4262	0.0014
Length after burnishing	1.4262	0.0014
Length after level-1	1.4256	0.0008

Length Chng.	0.0008
Stress Chng.	-34.8

Test #4g		(in) Length chng.
Length before testing	1.4252	
Length after torquing	1.4270	0.0018
Length after burnishing	1.4270	0.0018
Length after level-2	1.4260	0.0008

Length Chng.	0.0008
Stress Chng.	-58

Test #4h		(in) Length chng.
Length before testing	1.4295	
Length after torquing	1.4310	0.0015
Length after burnishing	1.4310	0.0015
Length after level-2	1.4300	0.0005

Length Chng.	0.0005
Stress Chng.	-58

(in*lb)	
On-torque	100
Off-torque	80

Torq. Chng.	20*
-------------	-----

* Outer segment of specimen rotated
Approx. 10 degrees
and then microwelded.

(in*lb)	
On-torque	100
Off-torque	55

Torq. Chng.	45
-------------	----

(in*lb)	
On-torque	100
Off-torque	***

Torq. Chng.	***
-------------	-----

* Failed to record. Nut
did not loosen
completely.

(in*lb)	
On-torque	100
Off-torque	90

Torq. Chng.	10
-------------	----

Test #5a		(in) Length chng.
Length before testing	2.1619	
Length after torquing	2.1655	0.0036
Length after sine-sweep	2.1655	0.0036
Length after burnishing	2.1653	0.0034
Length after level-1	2.1653	0.0034

Length Chng.	0.0034
Stress Chng.	0

(in*lb)	
On-torque	140
Off-torque	100

Torq. Chng.	40
-------------	----

Test #5b		(in) Length chng.
Length before testing	2.1595	
Length after torquing	2.1643	0.0048
Length after burnishing	2.1642	0.0047
Length after level-1	2.1641	0.0046

Length Chng.	0.0046
Stress Chng.	-2.9

(in*lb)	
On-torque	145
Off-torque	110

Torq. Chng.	35
-------------	----

Test #5c		(in) Length chng.
Length before testing	2.1537	
Length after torquing	2.1582	0.0045
Length after burnishing	2.1582	0.0045
Length after level-2	2.1577	0.0040

Length Chng.	0.0040
Stress Chng.	-14.5

(in*lb)	
On-torque	140
Off-torque	110

Torq. Chng.	30
-------------	----

Test #5d		(in) Length chng.
Length before testing	2.1563	
Length after torquing	2.1592	0.0029
Length after burnishing	2.1590	0.0027
Length after level-2	2.1590	0.0027

Length Chng.	0.0027
Stress Chng.	0

(in*lb)	
On-torque	155
Off-torque	120

Torq. Chng.	35
-------------	----

Test #5e	(in) Length chng.	
Length before testing	2.1999	
Length after torquing	2.2045	0.0046
Length after sine-sweep	2.2045	0.0046
Length after burnishing	2.2042	0.0043
Length after level-1	2.2042	0.0043

Length Chng.	0.0043
Stress Chng.	0

(in*lb)	
On-torque	150
Off-torque	110

Torq. Chng.	40
-------------	----

Test #5f	(in) Length chng.	
Length before testing	2.1527	
Length after torquing	2.1562	0.0035
Length after burnishing	2.1560	0.0033
Length after level-1	2.1560	0.0033

Length Chng.	0.0033
Stress Chng.	0

(in*lb)	
On-torque	160
Off-torque	115

Torq. Chng.	45
-------------	----

Test #5g	(in) Length chng.	
Length before testing	2.1544	
Length after torquing	2.1590	0.0046
Length after burnishing	2.1590	0.0046
Length after level-2	2.1590	0.0046

Length Chng.	0.0046
Stress Chng.	0

(in*lb)	
On-torque	160
Off-torque	115

Torq. Chng.	45
-------------	----

Test #5h	(in) Length chng.	
Length before testing	2.1583	
Length after torquing	2.1631	0.0048
Length after burnishing	2.1630	0.0047
Length after level-2	2.1630	0.0047

Length Chng.	0.0047
Stress Chng.	0

(in*lb)	
On-torque	160
Off-torque	130

Torq. Chng.	30
-------------	----

Test #6a		(in) Length chng.
Length before testing	2.2297	
Length after torquing	2.2358	0.0061
Length after sine-sweep	2.2358	0.0061
Length after burnishing	2.2358	0.0061
Length after level-1	2.2358	0.0061

Length Chng.	0.0061
Stress Chng.	0

(in*lb)	
On-torque	150
Off-torque	***

Torq. Chng.	***
-------------	-----

* Failed to record.
Nut did not loosen completely.

Test #6b		(in) Length chng.
Length before testing	2.2264	
Length after torquing	2.2318	0.0054
Length after burnishing	2.2306	0.0042
Length after level-1	2.2299	0.0035

Length Chng.	0.0035
Stress Chng.	-20.3

(in*lb)	
On-torque	130
Off-torque	80

Torq. Chng.	50
-------------	----

Test #6c		(in) Length chng.
Length before testing	2.2307	
Length after torquing	2.2360	0.0053
Length after burnishing	2.2360	0.0053
Length after level-2	2.2315	0.0008

Length Chng.	0.0008
Stress Chng.	-130.5

(in*lb)	
On-torque	145
Off-torque	95

Torq. Chng.	50
-------------	----

Test #6d		(in) Length chng.
Length before testing	2.2248	
Length after torquing	2.2299	0.0051
Length after burnishing	2.2273	0.0025
Length after level-2	2.2270	0.0022

Length Chng.	0.0022
Stress Chng.	-8.7

(in*lb)	
On-torque	150
Off-torque	105

Torq. Chng.	45
-------------	----

Test #6e		(in) Length chng.
Length before testing	2.2385	
Length after torquing	2.2436	0.0051
Length after sine-sweep	2.2435	0.0050
Length after burnishing	2.2435	0.0050
Length after level-1	2.2418	0.0033

Length Chng.	0.0033
Stress Chng.	-49.3

(in*lb)	
On-torque	150
Off-torque	120

Torq. Chng.	30
-------------	----

Test #6f		(in) Length chng.
Length before testing	2.2338	
Length after torquing	2.2376	0.0038
Length after burnishing	2.2376	0.0038
Length after level-1	2.2376	0.0038

Length Chng.	0.0038
Stress Chng.	0

(in*lb)	
On-torque	130
Off-torque	80

Torq. Chng.	50
-------------	----

Test #6g		(in) Length chng.
Length before testing	2.2240	
Length after torquing	2.2290	0.0050
Length after burnishing	2.2290	0.0050
Length after level-2	2.2290	0.0050

Length Chng.	0.0050
Stress Chng.	0

(in*lb)	
On-torque	130
Off-torque	95

Torq. Chng.	35
-------------	----

Test #6h		(in) Length chng.
Length before testing	2.2240	
Length after torquing	2.2284	0.0044
Length after burnishing	2.2283	0.0043
Length after level-2	2.2270	0.0030

Length Chng.	0.0030
Stress Chng.	-37.7

(in*lb)	
On-torque	145
Off-torque	100

Torq. Chng.	45
-------------	----

Test #7a		(in) Length chng.
Length before testing	3.1668	
Length after torquing	3.1695	0.0027
Length after sine-sweep	3.1695	0.0027
Length after burnishing	3.1695	0.0027
Length after level-1	3.1690	0.0022

Length Chng.	0.0022
Stress Chng.	-14.5

(ft*lb)	
On-torque	180
Off-torque	160

Torq. Chng.	20
-------------	----

Test #7b		(in) Length chng.
Length before testing	3.1710	
Length after torquing	3.1746	0.0036
Length after burnishing	3.1746	0.0036
Length after level-1	3.1736	0.0026

Length Chng.	0.0026
Stress Chng.	-29

(ft*lb)	
On-torque	180
Off-torque	140

Torq. Chng.	40
-------------	----

Test #7c		(in) Length chng.
Length before testing	3.1706	
Length after torquing	3.1730	0.0024
Length after burnishing	3.1730	0.0024
Length after level-2	3.1723	0.0017

Length Chng.	0.0017
Stress Chng.	-20.3

(ft*lb)	
On-torque	180
Off-torque	125

Torq. Chng.	55
-------------	----

Test #7d		(in) Length chng.
Length before testing	3.1760	
Length after torquing	3.1758	-0.0002
Length after burnishing	3.1758	-0.0002
Length after level-2	3.1758	-0.0002

Length Chng.	-0.0002
Stress Chng.	0

(ft*lb)	
On-torque	180
Off-torque	145

Torq. Chng.	35
-------------	----

		(in)
Test #7e		Length chng.
Length before testing	3.1714	
Length after torquing	3.1737	0.0023
Length after sine-sweep	3.1736	0.0022
Length after burnishing	3.1736	0.0022
Length after level-1	3.1736	0.0022

Length Chng.	0.0022
Stress Chng.	0

(ft*lb)	
On-torque	180
Off-torque	155

Torq. Chng.	25
-------------	----

		(in)
Test #7f		Length chng.
Length before testing	3.1725	
Length after torquing	3.1737	0.0012
Length after burnishing	3.1728	0.0003
Length after level-1	3.1728	0.0003

Length Chng.	0.0003
Stress Chng.	0

(ft*lb)	
On-torque	180
Off-torque	155

Torq. Chng.	25
-------------	----

		(in)
Test #7g		Length chng.
Length before testing	3.1720	
Length after torquing	3.1718	-0.0002
Length after burnishing	3.1718	-0.0002
Length after level-2	3.1715	-0.0005

Length Chng.	-0.0005
Stress Chng.	-8.7

(ft*lb)	
On-torque	180
Off-torque	160

Torq. Chng.	20
-------------	----

		(in)
Test #7h		Length chng.
Length before testing	3.1725	
Length after torquing	3.1720	-0.0005
Length after burnishing	3.1744	0.0019
Length after level-2	3.1741	0.0016

Length Chng.	0.0016
Stress Chng.	-8.7

(ft*lb)	
On-torque	180
Off-torque	160

Torq. Chng.	20
-------------	----

(in)

Test #8a		Length chng.
Length before testing	4.1482	
Length after torquing	4.1507	0.0025
Length after sine-sweep	4.1507	0.0025
Length after burnishing	4.1506	0.0024
Length after level-1	4.1500	0.0018

Length Chng.	0.0018
Stress Chng.	-8.7

(ft*lb)

On-torque	180
Off-torque	150

Torq. Chng.	30
-------------	----

(in)

Test #8b		Length chng.
Length before testing	4.1560	
Length after torquing	4.1545	-0.0015
Length after burnishing	4.1553	-0.0007
Length after level-1	4.1568	0.0008

Length Chng.	0.0008
Stress Chng.	21.75

(ft*lb)

On-torque	180
Off-torque	145

Torq. Chng.	35
-------------	----

(in)

Test #8c		Length chng.
Length before testing	4.1510	
Length after torquing	4.1538	0.0028
Length after burnishing	4.1531	0.0021
Length after level-2	4.1547	0.0037

Length Chng.	0.0037
Stress Chng.	23.2

(ft*lb)

On-torque	180
Off-torque	140

Torq. Chng.	40
-------------	----

(in)

Test #8d		Length chng.
Length before testing	4.1480	
Length after torquing	4.1500	0.0020
Length after burnishing	4.1500	0.0020
Length after level-2	4.1500	0.0020

Length Chng.	0.0020
Stress Chng.	0

(ft*lb)

On-torque	180
Off-torque	155

Torq. Chng.	25
-------------	----

		(in)
Test #8e		Length chng.
Length before testing	4.1406	
Length after torquing	4.1420	0.0014
Length after sine-sweep	4.1420	0.0014
Length after burnishing	4.1420	0.0014
Length after level-1	4.1420	0.0014

Length Chng.	0.0014
Stress Chng.	0

(ft*lb)	
On-torque	180
Off-torque	140

Torq. Chng.	40
-------------	----

		(in)
Test #8f		Length chng.
Length before testing	4.1275	
Length after torquing	4.1288	0.0013
Length after burnishing	4.1282	0.0007
Length after level-1	4.1282	0.0007

Length Chng.	0.0007
Stress Chng.	0

(ft*lb)	
On-torque	180
Off-torque	145

Torq. Chng.	35
-------------	----

		(in)
Test #8g		Length chng.
Length before testing	4.1510	
Length after torquing	4.1535	0.0025
Length after burnishing	4.1570	0.0060
Length after level-2	4.1547	0.0037

Length Chng.	0.0037
Stress Chng.	-33.35

(ft*lb)	
On-torque	180
Off-torque	135

Torq. Chng.	45
-------------	----

		(in)
Test #8h		Length chng.
Length before testing	4.1530	
Length after torquing	4.1545	0.0015
Length after burnishing	4.1540	0.0010
Length after level-2	4.1530	0.0000

Length Chng.	0.0000
Stress Chng.	-14.5

(ft*lb)	
On-torque	180
Off-torque	150

Torq. Chng.	30
-------------	----

		(in)
Test #9a		Length chng.
Length before testing	4.2055	
Length after torquing	4.2095	0.0040
Length after sine-sweep	4.2095	0.0040
Length after burnishing	4.2095	0.0040
Length after level-1	4.2095	0.0040

Length Chng.	0.0040
Stress Chng.	0

(ft*lb)	
On-torque	135
Off-torque	110

Torq. Chng.	25
-------------	----

		(in)
Test #9b		Length chng.
Length before testing	4.2005	
Length after torquing	4.2050	0.0045
Length after burnishing	4.2050	0.0045
Length after level-1	4.2050	0.0045

Length Chng.	0.0045
Stress Chng.	0

(ft*lb)	
On-torque	135
Off-torque	120

Torq. Chng.	15
-------------	----

		(in)
Test #9c		Length chng.
Length before testing	4.2111	
Length after torquing	4.2157	0.0046
Length after burnishing	4.2157	0.0046
Length after level-2	4.2152	0.0041

Length Chng.	0.0041
Stress Chng.	-14.5

(ft*lb)	
On-torque	135
Off-torque	110

Torq. Chng.	25
-------------	----

		(in)
Test #9d		Length chng.
Length before testing	4.2106	
Length after torquing	4.2153	0.0047
Length after burnishing	4.2153	0.0047
Length after level-2	4.2150	0.0044

Length Chng.	0.0044
Stress Chng.	-8.7

(ft*lb)	
On-torque	140
Off-torque	***

Torq. Chng.	***
-------------	-----

* Failed to record.
Nut did not loosen completely.

Test #9e		(in) Length chng.
Length before testing	4.2045	
Length after torquing	4.2100	0.0055
Length after sine-sweep	4.2098	0.0053
Length after burnishing	4.2098	0.0053
Length after level-1	4.2098	0.0053

Length Chng.	0.0053
Stress Chng.	0

(ft*lb)	
On-torque	130
Off-torque	120

Torq. Chng.	10
-------------	----

Test #9f		(in) Length chng.
Length before testing	4.1955	
Length after torquing	4.2020	0.0065
Length after burnishing	4.1975	0.0020
Length after level-1	4.1975	0.0020

Length Chng.	0.0020
Stress Chng.	0

(ft*lb)	
On-torque	130
Off-torque	*** *

Torq. Chng.	*** *
-------------	-------

* Failed to record.
Nut did not loosen completely.

Test #9g		(in) Length chng.
Length before testing	4.2064	
Length after torquing	4.2115	0.0051
Length after burnishing	4.2115	0.0051
Length after level-2	4.2115	0.0051

Length Chng.	0.0051
Stress Chng.	0

(ft*lb)	
On-torque	140
Off-torque	130

Torq. Chng.	10
-------------	----

Test #9h		(in) Length chng.
Length before testing	4.2128	
Length after torquing	4.2165	0.0037
Length after burnishing	4.2163	0.0035
Length after level-2	4.2163	0.0035

Length Chng.	0.0035
Stress Chng.	0

(ft*lb)	
On-torque	140
Off-torque	105

Torq. Chng.	35
-------------	----

		(in)
Test #10a		Length chng.
Length before testing	3.4745	
Length after torquing	3.4850	0.0105
Length after sine-sweep	3.4850	0.0105
Length after burnishing	3.4850	0.0105
Length after level-1	3.4830	0.0085

Length Chng.	0.0085
Stress Chng.	-58

(ft*lb)	
On-torque	180
Off-torque	140

Torq. Chng.	40
-------------	----

		(in)
Test #10b		Length chng.
Length before testing	3.4760	
Length after torquing	3.4870	0.0110
Length after burnishing	3.4870	0.0110
Length after level-1	3.4830	0.0070

Length Chng.	0.0070
Stress Chng.	-116

(ft*lb)	
On-torque	180
Off-torque	150

Torq. Chng.	30
-------------	----

		(in)
Test #10c		Length chng.
Length before testing	3.4825	
Length after torquing	3.4855	0.0030
Length after burnishing	3.4855	0.0030
Length after level-2	3.4855	0.0030

Length Chng.	0.0030
Stress Chng.	0

(ft*lb)	
On-torque	180
Off-torque	125

Torq. Chng.	55
-------------	----

		(in)
Test #10d		Length chng.
Length before testing	3.4800	
Length after torquing	3.4860	0.0060
Length after burnishing	3.4860	0.0060
Length after level-2	3.4840	0.0040

Length Chng.	0.0040
Stress Chng.	-58

(ft*lb)	
On-torque	180
Off-torque	105

Torq. Chng.	75
-------------	----

Test #10e		(in) Length chng.
Length before testing	3.4765	
Length after torquing	3.4840	0.0075
Length after sine-sweep	3.4840	0.0075
Length after burnishing	3.4800	0.0035
Length after level-1	3.4800	0.0035

Length Chng.	0.0035
Stress Chng.	0

(ft*lb)	
On-torque	180
Off-torque	145

Torq. Chng.	35
-------------	----

Test #10f		(in) Length chng.
Length before testing	3.4830	
Length after torquing	3.5070	0.0240
Length after burnishing	3.4785	-0.0045
Length after level-1	3.4750	-0.0080

Length Chng.	-0.0080
Stress Chng.	-101.5

(ft*lb)	
On-torque	180
Off-torque	140

Torq. Chng.	40
-------------	----

Test #10g		(in) Length chng.
Length before testing	3.4805	
Length after torquing	3.4850	0.0045
Length after burnishing	3.4850	0.0045
Length after level-2	3.4850	0.0045

Length Chng.	0.0045
Stress Chng.	0

(ft*lb)	
On-torque	180
Off-torque	140

Torq. Chng.	40
-------------	----

Test #10h		(in) Length chng.
Length before testing	3.4845	
Length after torquing	3.4800	-0.0045
Length after burnishing	3.4820	-0.0025
Length after level-2	3.4945	0.0100

Length Chng.	0.0100
Stress Chng.	362.5

(ft*lb)	
On-torque	180
Off-torque	145

Torq. Chng.	35
-------------	----

(in)

Test #11a		Length chng.
Length before testing	4.1709	
Length after torquing	4.1722	0.0013
Length after sine-sweep	4.1722	0.0013
Length after burnishing	4.1722	0.0013
Length after level-1	4.1714	0.0005

Length Chng.	0.0005
Stress Chng.	-11.6

(ft*lb)

On-torque	125
Off-torque	85

Torq. Chng.	40
-------------	----

(in)

Test #11b		Length chng.
Length before testing	4.1675	
Length after torquing	4.1709	0.0034
Length after burnishing	4.1708	0.0033
Length after level-1	4.1700	0.0025

Length Chng.	0.0025
Stress Chng.	-11.6

(ft*lb)

On-torque	125
Off-torque	80

Torq. Chng.	45
-------------	----

(in)

Test #11c		Length chng.
Length before testing	4.1738	
Length after torquing	4.1769	0.0031
Length after burnishing	4.1761	0.0023
Length after level-2	4.1761	0.0023

Length Chng.	0.0023
Stress Chng.	0

(ft*lb)

On-torque	125
Off-torque	90

Torq. Chng.	35
-------------	----

(in)

Test #11d		Length chng.
Length before testing	4.1706	
Length after torquing	4.1766	0.0060
Length after burnishing	4.1744	0.0038
Length after level-2	4.1735	0.0029

Length Chng.	0.0029
Stress Chng.	-13.05

(ft*lb)

On-torque	125
Off-torque	90

Torq. Chng.	35
-------------	----

Test #11e		(in) Length chng.
Length before testing	4.1540	
Length after torquing	4.1570	0.0030
Length after sine-sweep	4.1570	0.0030
Length after burnishing	4.1570	0.0030
Length after level-1	4.1568	0.0028

Length Chng.	0.0028
Stress Chng.	-2.9

(ft*lb)	
On-torque	125
Off-torque	85

Torq. Chng.	40
-------------	----

Test #11f		(in) Length chng.
Length before testing	4.1521	
Length after torquing	4.1569	0.0048
Length after burnishing	4.1569	0.0048
Length after level-1	4.1569	0.0048

Length Chng.	0.0048
Stress Chng.	0

(ft*lb)	
On-torque	125
Off-torque	90

Torq. Chng.	35
-------------	----

Test #11g		(in) Length chng.
Length before testing	4.1705	
Length after torquing	4.1737	0.0032
Length after burnishing	4.1737	0.0032
Length after level-2	4.1729	0.0024

Length Chng.	0.0024
Stress Chng.	-11.6

(ft*lb)	
On-torque	125
Off-torque	90

Torq. Chng.	35
-------------	----

Test #11h		(in) Length chng.
Length before testing	4.1686	
Length after torquing	4.1713	0.0027
Length after burnishing	4.1710	0.0024
Length after level-2	4.1709	0.0023

Length Chng.	0.0023
Stress Chng.	-1.45

(ft*lb)	
On-torque	125
Off-torque	90

Torq. Chng.	35
-------------	----

		(in)
Test #12a		Length chng.
Length before testing	3.4225	
Length after torquing	3.4259	0.0034
Length after sine-sweep	3.4259	0.0034
Length after burnishing	3.4259	0.0034
Length after level-1	3.4259	0.0034

Length Chng.	0.0034
Stress Chng.	0

(ft*lb)	
On-torque	110
Off-torque	125

Torq. Chng.	-15
-------------	-----

		(in)
Test #12b		Length chng.
Length before testing	3.4375	
Length after torquing	3.4405	0.0030
Length after burnishing	3.4405	0.0030
Length after level-1	3.4405	0.0030

Length Chng.	0.0030
Stress Chng.	0

(ft*lb)	
On-torque	115
Off-torque	100

Torq. Chng.	15
-------------	----

		(in)
Test #12c		Length chng.
Length before testing	3.4220	
Length after torquing	3.4268	0.0048
Length after burnishing	3.4268	0.0048
Length after level-2	3.4268	0.0048

Length Chng.	0.0048
Stress Chng.	0

(ft*lb)	
On-torque	115
Off-torque	95

Torq. Chng.	20
-------------	----

		(in)
Test #12d		Length chng.
Length before testing	3.4463	
Length after torquing	3.4500	0.0037
Length after burnishing	3.4500	0.0037
Length after level-2	3.4500	0.0037

Length Chng.	0.0037
Stress Chng.	0

(ft*lb)	
On-torque	115
Off-torque	100

Torq. Chng.	15
-------------	----

Test #12e		(in) Length chng.
Length before testing	3.4366	
Length after torquing	3.4405	0.0039
Length after sine-sweep	3.4405	0.0039
Length after burnishing	3.4405	0.0039
Length after level-1	3.4405	0.0039

Length Chng.	0.0039
Stress Chng.	0

(ft*lb)	
On-torque	115
Off-torque	105

Torq. Chng.	10
-------------	----

Test #12f		(in) Length chng.
Length before testing	3.4297	
Length after torquing	3.4333	0.0036
Length after burnishing	3.4333	0.0036
Length after level-1	3.4333	0.0036

Length Chng.	0.0036
Stress Chng.	0

(ft*lb)	
On-torque	115
Off-torque	100

Torq. Chng.	15
-------------	----

Test #12g		(in) Length chng.
Length before testing	3.4294	
Length after torquing	3.4325	0.0031
Length after burnishing	3.4323	0.0029
Length after level-2	3.4323	0.0029

Length Chng.	0.0029
Stress Chng.	0

(ft*lb)	
On-torque	115
Off-torque	100

Torq. Chng.	15
-------------	----

Test #12h		(in) Length chng.
Length before testing	3.4326	
Length after torquing	3.4359	0.0033
Length after burnishing	3.4359	0.0033
Length after level-2	3.4358	0.0032

Length Chng.	0.0032
Stress Chng.	-2.9

(ft*lb)	
On-torque	115
Off-torque	100

Torq. Chng.	15
-------------	----

APPENDIX D
STATIC ON-TORQUE VS. OFF-TORQUE DATA

Test #1 bolt

Rep. #	Bolt 1		Bolt 2		Bolt 3		Avg.
	On-Torque	Off-Torque	On-Torque	Off-Torque	On-Torque	Off-Torque	Off-Torque
1	85	60	85	60	85	65	62
2	85	55	85	65	85	65	62
3	85	60	85	70	85	65	65
Avg.=		58		65		65	

Test #2 bolt

Rep. #	Bolt 1		Bolt 2		Bolt 3		Avg.
	On-Torque	Off-Torque	On-Torque	Off-Torque	On-Torque	Off-Torque	Off-Torque
1	95	70	95	75	95	80	75
2	95	75	95	70	95	75	73
3	95	80	95	80	95	75	78
Avg.=		75		75		77	

Test #3 bolt

Rep. #	Bolt 1		Bolt 2		Bolt 3		Avg.
	On-Torque	Off-Torque	On-Torque	Off-Torque	On-Torque	Off-Torque	Off-Torque
1	150	100	150	90	150	100	97
2	150	95	150	95	150	95	95
3	150	105	150	95	150	100	100
Avg.=		100		93		98	

Test #4 bolt

Rep. #	Bolt 1		Bolt 2		Bolt 3		Avg.
	On-Torque	Off-Torque	On-Torque	Off-Torque	On-Torque	Off-Torque	Off-Torque
1	100	80	100	80	100	85	82
2	100	75	100	80	100	90	82
3	100	80	100	80	100	90	83
Avg.=		78		80		88	

Test #5 bolt

Rep. #	Bolt 1		Bolt 2		Bolt 3		Avg.
	On-Torque	Off-Torque	On-Torque	Off-Torque	On-Torque	Off-Torque	Off-Torque
1	150	95	150	100	150	110	102
2	150	95	150	95	150	100	97
3	150	105	150	100	150	95	100
Avg.=		98		98		102	

Test #6 bolt

Rep. #	Bolt 1		Bolt 2		Bolt 3		Avg. Off-Torque
	On-Torque	Off-Torque	On-Torque	Off-Torque	On-Torque	Off-Torque	
1	150	130	150	105	150	110	115
2	150	125	150	110	150	110	115
3	150	105	150	110	150	115	110
Avg.=		120			108	112	

Test #7 bolt

Rep. #	Bolt 1		Bolt 2		Bolt 3		Avg. Off-Torque
	On-Torque	Off-Torque	On-Torque	Off-Torque	On-Torque	Off-Torque	
1	180	155	180	145	180	150	150
2	180	155	180	150	180	150	152
3	180	165	180	150	180	155	157
Avg.=		158			148	152	

Test #8 bolt

Rep. #	Bolt 1		Bolt 2		Bolt 3		Avg. Off-Torque
	On-Torque	Off-Torque	On-Torque	Off-Torque	On-Torque	Off-Torque	
1	180	130	180	130	180	145	135
2	180	145	180	135	180	160	147
3	180	160	180	145	180	145	150
Avg.=		145			137	150	

Test #9 bolt

Rep. #	Bolt 1		Bolt 2		Bolt 3		Avg. Off-Torque
	On-Torque	Off-Torque	On-Torque	Off-Torque	On-Torque	Off-Torque	
1	135	100	135	110	135	95	102
2	135	95	135	105	135	100	100
3	135	105	135	115	135	95	105
Avg.=		100			110	97	

Test #10 bolt

Rep. #	Bolt 1		Bolt 2		Bolt 3		Avg. Off-Torque
	On-Torque	Off-Torque	On-Torque	Off-Torque	On-Torque	Off-Torque	
1	180	130	180	145	180	150	142
2	180	130	180	140	180	145	138
3	180	140	180	140	180	145	142
Avg.=		133			142	147	

Test #11 bolt

Rep. #	Bolt 1		Bolt 2		Bolt 3		Avg.
	On-Torque	Off-Torque	On-Torque	Off-Torque	On-Torque	Off-Torque	Off-Torque
1	125	100	125	100	125	85	95
2	125	90	125	90	125	90	90
3	125	95	125	85	125	90	90
Avg.=		95		92		88	

Test #12 bolt

Rep. #	Bolt 1		Bolt 2		Bolt 3		Avg.
	On-Torque	Off-Torque	On-Torque	Off-Torque	On-Torque	Off-Torque	Off-Torque
1	115	90	115	100	115	100	97
2	115	95	115	95	115	95	95
3	115	105	115	95	115	100	100
Avg.=		97		97		98	

- Notes: 1. All torque values shown for Test #1 - #6 are in in*lb.
 2. All torque values shown for Test #7 - #12 are in ft*lb.

APPENDIX E
CONFIRMATION TEST DATA

Confirmation Test #1

		(in)
CTest#1a		Length chng.
Length before testing	3.4369	
Length after torquing	3.4381	0.0012
Length after burnishing	3.4380	0.0011
Length after level-1	3.4388	0.0019

Length Chng.	0.0019
Stress Chng.	-40.6

		(ft*lb)
On-torque		180
Off-torque		135
Torq. Chng.		45

Static Testing:

180	150
Diff	30

		(in)
CTest#1b		Length chng.
Length before testing	3.4379	
Length after torquing	3.4415	0.0036
Length after burnishing	3.4413	0.0034
Length after level-1	3.4385	0.0006

Length Chng.	0.0006
Stress Chng.	142.1

		(ft*lb)
On-torque		180
Off-torque		155
Torq. Chng.		25

Static Testing:

180	155
Diff	25

		(in)
CTest#1c		Length chng.
Length before testing	3.4235	
Length after torquing	3.4323	0.0088
Length after burnishing	3.4294	0.0059
Length after level-1	3.4291	0.0056

Length Chng.	0.0056
Stress Chng.	15.225

		(ft*lb)
On-torque		180
Off-torque		135
Torq. Chng.		45

Static Testing:

180	155
Diff	25

		(in)
CTest#1d		Length chng.
Length before testing	3.4230	
Length after torquing	3.4274	0.0044
Length after burnishing	3.4274	0.0044
Length after level-1	3.4230	0.0000

Length Chng.	0.0000
Stress Chng.	223.3

		(ft*lb)
On-torque		180
Off-torque		135
Torq. Chng.		45

Static Testing:

180	140
Diff	40

Confirmation Test #2

		(in)
CTest#2a		Length chng.
Length before testing	1.5108	
Length after torquing	1.5153	0.0045
Length after burnishing	1.5153	0.0045
Length after level-1	1.5135	0.0027

Length Chng.	0.0027
Stress Chng.	52.2

		(in*lb)
On-torque		90
Off-torque		55
Torq. Chng.		35

Static Testing:

90	70
Diff	20

		(in)
CTest#2b		Length chng.
Length before testing	1.5134	
Length after torquing	1.5164	0.0030
Length after burnishing	1.5164	0.0030
Length after level-1	1.5158	0.0024

Length Chng.	0.0024
Stress Chng.	17.4

		(in*lb)
On-torque		90
Off-torque		70
Torq. Chng.		20

Static Testing:

90	70
Diff	20

		(in)
CTest#2c		Length chng.
Length before testing	1.5158	
Length after torquing	1.5208	0.0050
Length after burnishing	1.5208	0.0050
Length after level-1	1.5208	0.0050

Length Chng.	0.0050
Stress Chng.	0

		(in*lb)
On-torque		90
Off-torque		70
Torq. Chng.		20

Static Testing:

90	75
Diff	15

		(in)
CTest#2d		Length chng.
Length before testing	1.5185	
Length after torquing	1.5216	0.0031
Length after burnishing	1.5216	0.0031
Length after level-1	1.5216	0.0031

Length Chng.	0.0031
Stress Chng.	0

		(in*lb)
On-torque		90
Off-torque		70
Torq. Chng.		20

Static Testing:

90	75
Diff	15

APPENDIX F
ADDITIONAL TEST DATA

Additional Test #1

A Test #1a	(psi)	Stress chng.
Load after torquing	11,300	
Load after level-2	12,200	900

(in*lb)	
On-torque	30
Off-torque	15

Torq. Chng.	15
-------------	----

A Test #1b	(psi)	Stress chng.
Load after torquing	11,300	
Load after level-2	0	-11,300

(in*lb)	
On-torque	30
Off-torque	0

Torq. Chng.	30
-------------	----

Additional Test #2

A Test #2a	(psi)	Stress chng.
Load after torquing	22,200	
Load after level-2	25,900	3,700

(in*lb)	
On-torque	75
Off-torque	30

Torq. Chng.	45
-------------	----

A Test #2b	(psi)	Stress chng.
Load after torquing	26,700	
Load after level-2	0	-26,700

(in*lb)	
On-torque	60
Off-torque	0

Torq. Chng.	60
-------------	----

Additional Test #3

A Test #3a	(psi)	Stress chng.
Load after torquing	12,000	
Load after level-2	0	-12,000

(in*lb)	
On-torque	30
Off-torque	0

Torq. Chng.	30
-------------	----

A Test #3b	(psi)	Stress chng.
Load after torquing	12,400	
Load after level-2	0	-12,400

(in*lb)	
On-torque	30
Off-torque	0

Torq. Chng.	30
-------------	----

Additional Test #4

A Test #4a	(psi)	Stress chng.
Load after torquing	25,300	
Load after level-2	22,100	-3,200

(in*lb)	
On-torque	50
Off-torque	35

Torq. Chng.	15
-------------	----

A Test #4b	(psi)	Stress chng.
Load after torquing	22,500	
Load after level-2	0	-22,500

(in*lb)	
On-torque	70
Off-torque	0

Torq. Chng.	70
-------------	----

Additional Test #5

A Test #5a	(psi)	Stress chng.
Load after torquing	11,300	
Load after level-2	10,000	-1,300

(ft*lb)	
On-torque	35
Off-torque	30

Torq. Chng.	5
-------------	---

A Test #5b	(psi)	Stress chng.
Load after torquing	12,200	
Load after level-2	0	-12,200

(ft*lb)	
On-torque	8
Off-torque	0

Torq. Chng.	8
-------------	---

Additional Test #6

A Test #6a	(psi)	Stress chng.
Load after torquing	24,500	
Load after level-2	16,700	-7,800

(ft*lb)	
On-torque	100
Off-torque	60

Torq. Chng.	40
-------------	----

A Test #6b	(psi)	Stress chng.
Load after torquing	25,400	
Load after level-2	17,800	-7,600

(ft*lb)	
On-torque	70
Off-torque	50

Torq. Chng.	20
-------------	----

Additional Test #7

A Test #7a	(psi)	Stress chng.
Load after torquing	12,300	
Load after level-2	14,000	1,700

(ft*lb)	
On-torque	40
Off-torque	30

Torq. Chng.	10
-------------	----

A Test #7b	(psi)	Stress chng.
Load after torquing	11,700	
Load after level-2	13,000	1,300

(ft*lb)	
On-torque	50
Off-torque	45

Torq. Chng.	5
-------------	---

Additional Test #8

A Test #8a	(psi)	Stress chng.
Load after torquing	***	
Load after level-2	***	***

(ft*lb)	
On-torque	***
Off-torque	***

Torq. Chng.	***
-------------	-----

A Test #8b	(psi)	Stress chng.
Load after torquing	24,500	
Load after level-2	30,000	5,500

(ft*lb)	
On-torque	75
Off-torque	75

Torq. Chng.	0
-------------	---