

# International Space Station Alpha Trace Contaminant Control Subassembly Life Test Final Report

---

*J.D. Tatara*  
*ION Electronics • Huntsville, Alabama*

*and*

*J.L. Perry*  
*Marshall Space Flight Center • MSFC, Alabama*

National Aeronautics and Space Administration  
Marshall Space Flight Center • MSFC, Alabama 35812

---

March 1995



## TABLE OF CONTENTS

<u>SECTION</u>	<u>PAGE</u>
LIST OF TABLES AND FIGURES	iv
ACRONYMS	vi
1.0 INTRODUCTION	1
1.1 Test Background and Description	1
1.2 Report Format	4
1.2.1 Graph Descriptions	4
2.0 TEST SUMMARIES	5
2.1 Test Weeks 1-33	6
2.1.1 Performance (Weeks 1-33)	14
2.2 Test Weeks 34-47	15
2.2.1 Performance (Weeks 34-47)	22
2.3 Test Weeks 47-60	23
2.3.1 Performance (Weeks 47-60)	30
2.4 Test Weeks 61-72	31
2.4.1 Performance (Weeks (61-72)	38
2.5 Test Weeks 73-86	39
2.5.1 Performance (Weeks 73-86)	46
2.6 Test Weeks 86-99	47
2.6.1 Performance (Weeks 86-99)	54
2.7 Test Weeks 100-114	55
2.7.1 Performance (Weeks 100-114)	62
3.0 TEST CONCLUSIONS	63



## LIST OF TABLES AND FIGURES

<u>TABLES</u>	<u>PAGE</u>
1.0-1 Life Test Responsibilities	1
3.0-1 Sample Numbers and Corresponding Dates	64
3.0-2 Sample Numbers and Corresponding Dates	65
<u>FIGURES</u>	<u>PAGE</u>
1.0-1 TCCS Life Test Gantt Chart	2
1.1-1 TCCS Schematic	3
2.1-1 JF02: Oxidizer Low Leg Flow Rate	8
2.1-2 JF04: Methane Bleed Rate	9
2.1-3 JT03: Pre Oxidizer Temperature	10
2.1-4 JT04: Catalytic Oxidizer Temperature	11
2.1-5 JT05: Post Oxidizer Temperature	12
2.1-6 FT01: High Bay Temperature	13
2.1.1-1 Oxidation Efficiency (1 - 33 Summary)	14
2.2-1 JF02: Oxidizer Low Leg Flow Rate	16
2.2-2 JF04: Methane Bleed Rate	17
2.2-3 JT03: Pre Oxidizer Temperature	18
2.2-4 JT04: Catalytic Oxidizer Temperature	19
2.2-5 JT05: Post Oxidizer Temperature	20
2.2-6 FT01: High Bay Temperature	21
2.2.1-1 Oxidation Efficiency (34 - 47 Summary)	22
2.3-1 JF02: Oxidizer Low Leg Flow Rate	24
2.3-2 JF04: Methane Bleed Rate	25
2.3-3 JT03: Pre Oxidizer Temperature	26
2.3-4 JT04: Catalytic Oxidizer Temperature	27
2.3-5 JT05: Post Oxidizer Temperature	28
2.3-6 FT01: High Bay Temperature	29
2.3.1-1 Oxidation Efficiency (47 - 60 Summary)	30
2.4-1 JF02: Oxidizer Low Leg Flow Rate	32
2.4-2 JF04: Methane Bleed Rate	33
2.4-3 JT03: Pre Oxidizer Temperature	34
2.4-4 JT04: Catalytic Oxidizer Temperature	35
2.4-5 JT05: Post Oxidizer Temperature	36
2.4-6 FT01: High Bay Temperature	37
2.4.1-1 Oxidation Efficiency (61 - 72 Summary)	38
2.5-1 JF02: Oxidizer Low Leg Flow Rate	40
2.5-2 JF04: Methane Bleed Rate	41
2.5-3 JT03: Pre Oxidizer Temperature	42
2.5-4 JT04: Catalytic Oxidizer Temperature	43
2.5-5 JT05: Post Oxidizer Temperature	44
2.5-6 FT01: High Bay Temperature	45
2.5.1-1 Oxidation Efficiency (73 - 86 Summary)	46

## LIST OF TABLES AND FIGURES (continued)

<b><u>FIGURES</u></b>	<b><u>PAGE</u></b>
2.6-1 JF02: Oxidizer Low Leg Flow Rate	48
2.6-2 JF04: Methane Bleed Rate	49
2.6-3 JT03: Pre Oxidizer Temperature	50
2.6-4 JT04: Catalytic Oxidizer Temperature	51
2.6-5 JT05: Post Oxidizer Temperature	52
2.6-6 FT01: High Bay Temperature	53
2.6.1-1 Oxidation Efficiency (86 - 99 Summary)	54
2.7-1 JF02: Oxidizer Low Leg Flow Rate	56
2.7-2 JF04: Methane Bleed Rate	57
2.7-3 JT03: Pre Oxidizer Temperature	58
2.7-4 JT04: Catalytic Oxidizer Temperature	59
2.7-5 JT05: Post Oxidizer Temperature	60
2.7-6 FT01: High Bay Temperature	61
2.7.1-1 Oxidation Efficiency (100 - 114 Summary)	62
3.0-1 Overall Oxidation Efficiency (Lab Analyses)	64
3.0-2 Overall Oxidation Efficiency (In-line Analyzer)	65

## ACRONYMS

ACC	Analytical Control Coordinator
ECLSS	Environmental Control and Life Support Systems
ED62	Structures and Dynamics Laboratory, Life Support Systems Branch
EL65	Systems Analysis and Integration Laboratory, Development Test Branch
ELTP	ECLSS Life Test Program
FID	Flame Ionization Detector
FT01	High Bay Temperature Sensor
GC	Gas Chromatograph
HTCO	High Temperature Catalytic Oxidizer
ION	ION Electronics Inc.
ISSA	International Space Station Alpha
JF04	TCCS Lower Leg Flow Rate Sensor
JT03	Pre Catalytic Oxidizer Temperature Sensor
JT04	Catalytic Oxidizer Temperature Sensor
JT05	Post Catalytic Oxidizer Temperature Sensor
MDL	Method Detection Limit
ppm <sub>v</sub>	Parts Per Million by Volume
QC	Quality Control
RTV	Rubber Sealant Compound
SCATS	System Components Automated Test System
SCFM	Standard Cubic Feet per Minute
SCIM	Standard Cubic Inches per Minute
TCCS	Trace Contaminant Control Subassembly
TCD	Thermal Conductivity Sensor





## 1.0 INTRODUCTION

The Environmental Control and Life Support System (ECLSS) Life Test Program (ELTP) began with Trace Contaminant Control Subassembly (TCCS) Life Testing on November 9, 1992, at 0745 (**Figure 1.0-1**). TCCS Life Testing ended successfully on January 17, 1995. Test data and operator log book entries were gathered and evaluated daily by ION Electronics (ION) personnel. Weekly and quarterly reports were prepared to document test progress and were distributed to NASA ELTP Test Engineers (**Table 1.0-1**). Formal and informal review meetings were held between representatives of ION, ED62, and EL65.

**Table 1.0-1 Life Test Responsibilities**

<u>Subsystem</u>	<u>ION</u>	<u>ED62</u>	<u>EL65</u>
TCCS	Jim Tatara*	Jay Perry*	Darlene Springer* Dale Armstrong
* Overall Life test lead			

The purpose of the test, as stated in the NASA document entitled *Requirements for Trace Contaminant Control Subassembly High Temperature Catalytic Oxidizer Life Testing (Revision A)*, was to "provide for the long duration operation of the ECLSS TCCS [High Temperature Catalytic Oxidizer] HTCO at normal operating conditions... [and thus]... to determine the useful life of ECLSS hardware for use on long duration manned space missions. Specifically, the test was designed to demonstrate thermal stability of the catalyst." An investigation, separate from the Life Test, is looking at the effects of catalyst poisoning, and recovery. A separate report will be issued upon completion of the study.

The following sections detail TCCS operation and stability. Graphs are included to aid in evaluating trend analyses and subsystem anomalies. This final report summarizes activities through January 17, 1995 (Test Day 762).

### 1.1 Test Background and Description

A TCCS utilizing a 0.5% palladium on alumina catalyst (3.175 mm pellets) is scheduled for use on the ISSA for oxidizing trace organics in cabin air, yielding primarily CO<sub>2</sub> and H<sub>2</sub>O. These products will be removed from the airstream, by other ECLSS components, prior to the airstream's reentry into the cabin atmosphere. The organics to be oxidized will be introduced into the cabin as human metabolic products, and through off-gassing of materials used in ISSA construction.

TCCS Life Testing utilized hardware previously used during the *Skylab* program. The axial fan and the low leg blower were both refurbished by the vendor prior to the beginning of the test. The HTCO was fitted with additional thermocouples to more efficiently monitor internal temperatures. The flight-like test hardware was the HTCO assembly, and the palladium on alumina catalyst found within the HTCO housing. A TCCS simplified schematic is shown in **Figure 1.1-1**.

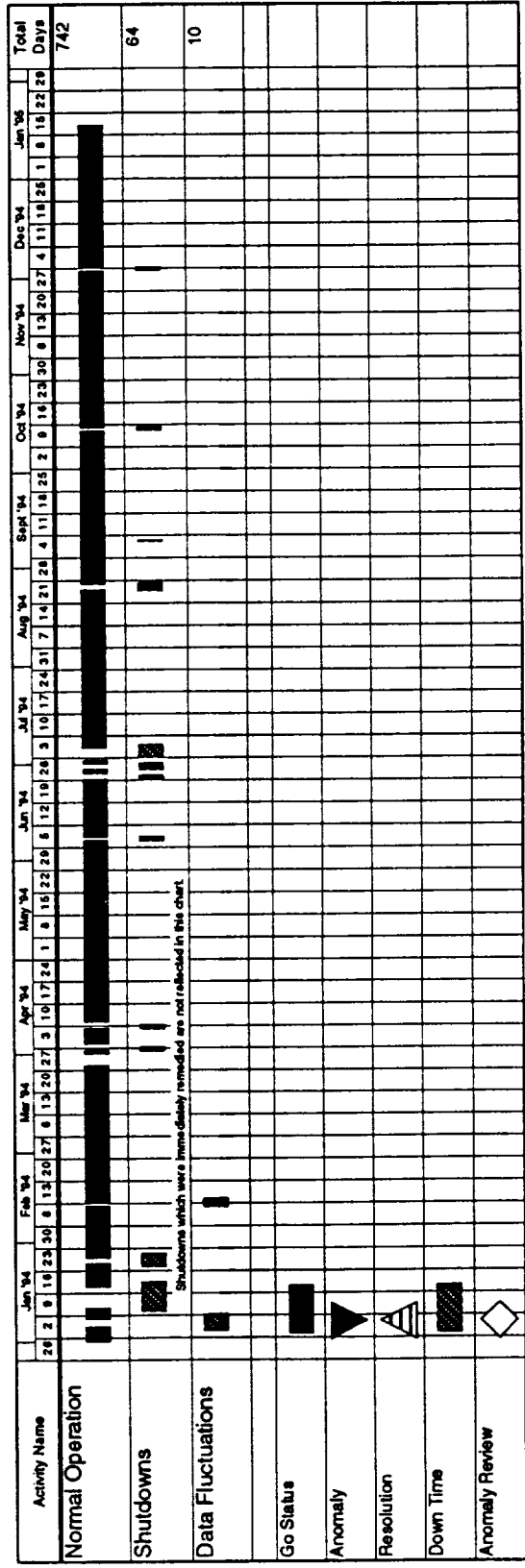
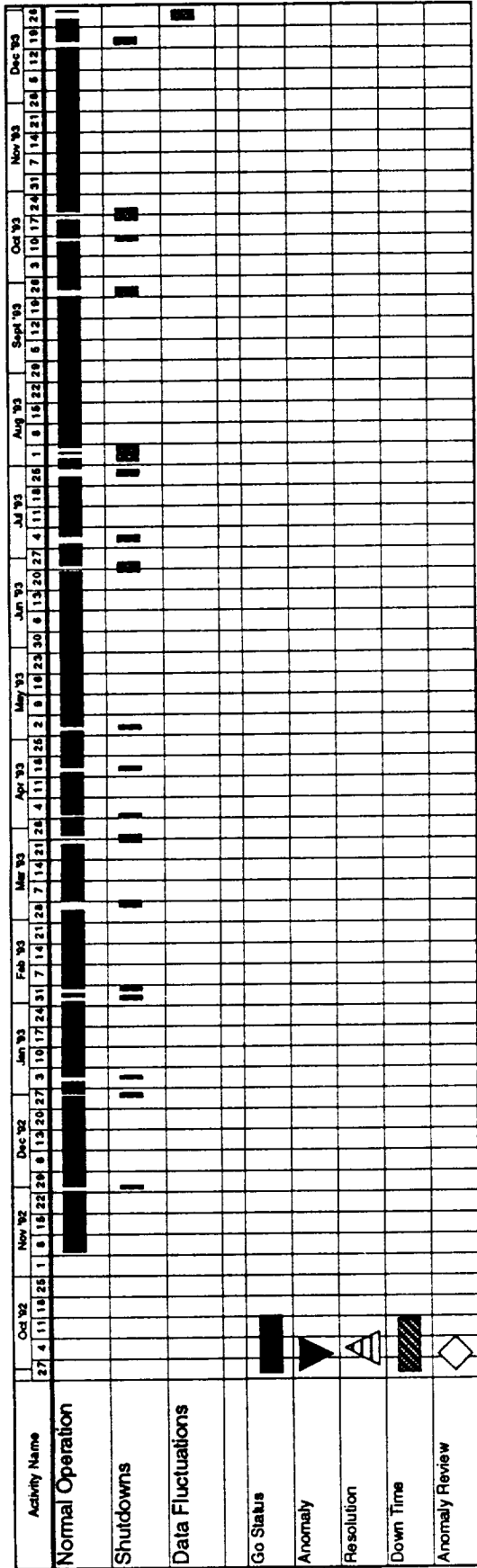
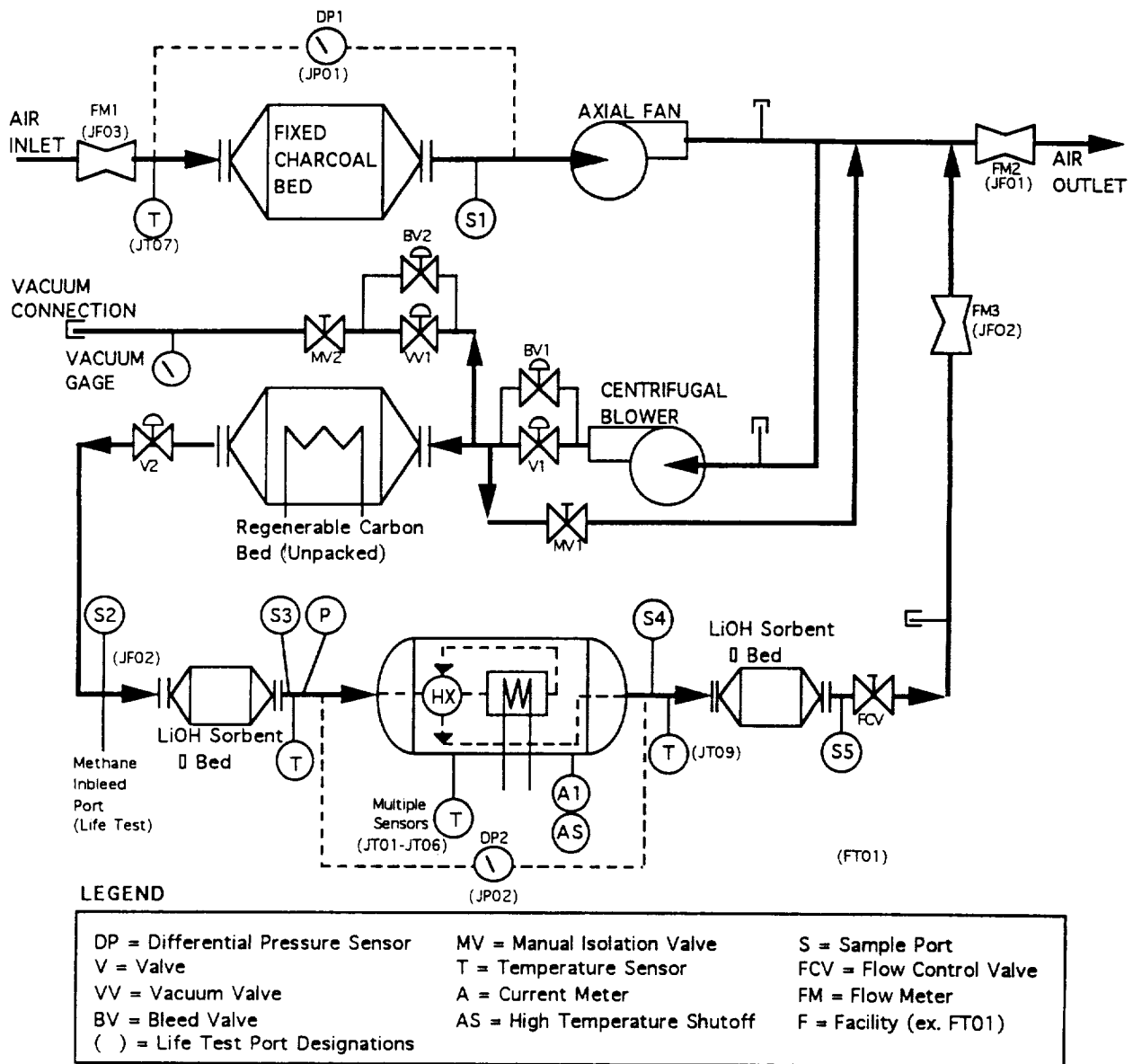

Figure 1.0-1 TCCS Life Test Gantt Chart Overall (Weeks 1-114)



**Figure 1.1-1 TCCS Schematic**

In the TCCS catalyst Life Test, 3% methane in air was bled into an air stream in the catalytic oxidizer lower leg (at JF04). This is just prior to the Lithium Hydroxide (LiOH) Presorbent Bed canister. The canister was used as a mixing chamber for this test, and was otherwise inoperable. The air stream methane concentration, as it left the presorbent canister, was approximately 90 ppm. The air stream then entered the HTCO assembly (containing the palladium catalyst), where it passed through a heat exchanger, and then the catalyst bed. Within the bed, methane and other organic contaminants were oxidized. The air stream containing the oxidation by-products then left the bed, passed again through the heat exchanger (cooling somewhat as it gave up heat to the incoming air stream), and exited the assembly.

## 1.2 Report Format

Graphs were produced from data collected by the TCCS LabView software, which samples all TCCS sensors once every 60 seconds. The above subassembly shutdowns are denoted by numbers in boxes on the following graphs (**Sections 2.1 - 2.8**). For presentation purposes, the data set was reduced through averaging. First, the sixty second data were averaged to provide one sample point per hour. Five hourly data points were then selected daily (six hour intervals beginning at midnight), and averaged to provide the daily data points shown in the graphs. This method of data reduction does not show detail, and should not be utilized for analytical evaluation of subassembly performance. The method does, for the purposes of a life test, provide a means of reducing large data sets and accurately representing long-term subassembly stability.

Only selected TCCS sensors are presented in this report. The sensor data analysis will provide the information needed to evaluate the TCCS HTCO. An additional 14 temperature, dewpoint, and flow sensors provided TCCS Life Testing data. This data is available in the TCCS LabView archive and in the System Components Automated Text System (SCATS).

### 1.2.1 Graph Descriptions

JF02 data show the air flow, in Standard Cubic Feet per Minute (SCFM), through the TCCS low leg. The flow consistently remained around 2.7 SCFM, with no trend toward higher or lower flow rates. This suggests that the TCCS axial fan and the centrifugal blower were both performing nominally throughout the test.

JF04 data show the methane bleed flow rate into the TCCS in Standard Cubic Inches per Minute (SCIM). The rate, throughout the test, remained relatively stable at 14.2 SCIM. The methane bled into the subassembly was approximately 3% in air, and the actual concentration of each cylinder was certified by the vendor. The sensor was monitored as a control to ensure the desired levels of methane were introduced to the test catalyst.

JT03 data show the temperature, in degrees Fahrenheit (°F), just prior to the catalytic oxidizer catalyst bed. The oxidizer bed temperature was controlled at this point. The temperature at JT03 was relatively steady, at 720°F, throughout the test.

JT04 data show the temperature, in °F, within the catalytic oxidizer catalyst bed. A degradation in this temperature could suggest a degradation in the catalyst efficiency. The temperature at JT04 was relatively steady, at 748 °F, throughout the test.

JT05 data show the temperature just after the catalytic oxidizer catalyst bed in °F. As with JT04, it is anticipated that a reduction in this temperature would have suggested a degradation in catalyst efficiency. The temperature at JT05 was relatively steady, at 751 °F, throughout the test.

FT01 data show the test temperature, within the building 4755 high bay TCCS vicinity, in °F. The temperature was monitored to provide an inlet air baseline temperature. The average highbay temperatures ranged from 65-85°F. Highbay temperature was found to have minimal affect on internal TCCS temperatures.

## 2.0 TEST SUMMARIES

Graphical representations of data are presented in groups of test weeks. This was done to facilitate final report preparation, by allowing the use of previously reduced data sets. In some instances, the report periods from one section to the next will overlap. This occurs since report periods often ended in the middle of a test week. It then became necessary to report the last week of a one report period as the first week of the next report period (causing duplication of some data). Such a method ensures that all relevant data are reported, and shows the data flow from one report period to the next.

Analytical data (methane in air) is provided for all data sets. The data presented for the test period 1 - 33 is, however, suspect. This is because of a problem with the Boeing analytical method for methane in air. Early in the test, on several occasions, Quality Control (QC) samples for constituent gasses in air were submitted by the Analytical Control Coordinator (ACC) to the Boeing laboratory. The samples contained Methane at concentrations near, but above, the method detection limit of 3 ppm<sub>v</sub>. Despite this, Boeing consistently returned results for these samples of <3 ppm<sub>v</sub> methane. A verbal warning was issued by the ACC of a possible method problem. Independent analyses were performed on the QC samples to ensure sample integrity. The sample results showed that the QC samples were within acceptable limits. The ACC advised Boeing of a definite problem with the analytical method (ION TM July 16, 1993). An investigation into the method resulted, and determined the actual method detection limit fell in the 40 ppm<sub>v</sub> range. A new method was developed with a methane in air detection limit of 5 ppm<sub>v</sub>. All Life Testing air samples (TCCS and 4BMS) collected on or after 8/16/93 (test day 271 of TCCS Life Testing) were analyzed using the corrected and verified method.

The initial method error occurred during its development. Detection limits, with the detector being used (Thermal Conductivity Detector, TCD), were determined for each individual air constituent (Nitrogen, Oxygen, Carbon Dioxide, Methane, Carbon Monoxide, and Helium), in pure Helium (Helium was determined in Nitrogen). While the detection limit determined was correct for Methane in Helium, the detection limits did not translate to an air matrix. In test samples, interference from Nitrogen, Oxygen, and moisture in the air resulted in a masking of the methane peak. In addition, electronic "cross talk" from the Gas Chromatograph (GC) used in the analysis resulted in false peaks. The method was redeveloped, using a more sophisticated Flame Ionization Detector (FID). Constituent gas detection limits were determined, in an air matrix, and the electronic "cross talk" problem was corrected. Subsequent QC on the method, showed much increased accuracy, and methane detection limits very near 5 ppm<sub>v</sub>.

The problem showed the importance of following proper AC requirements for test methods. The AC Plan requires that all methods be submitted for approval, by the ACC with the assistance of experts in the field. The method in question was not submitted for review prior to the test. The corrected method was submitted, reviewed by experts in GC analysis, and comments were submitted to Boeing by the ACC.

Following introduction of the new method, methane removal efficiencies for the TCCS catalytic oxidizer dropped. While earlier results showed methane levels at the catalytic oxidizer outlet below 3 ppm<sub>v</sub> (possibly in error) the new method showed methane values, at the same port, of around 8 ppm<sub>v</sub>. The higher values gave

calculated efficiency values in the range of 88-91%, depending on the inlet methane concentration. The average efficiency fell from the artificially high (95%+) recoveries of test weeks 1 - 33, reported through the initial analytical method. Results for the erroneous method are included in this report for consistency. The method was accurate at Methane in Air concentrations above 45 ppm<sub>v</sub>.

## **2.1 Test Weeks 1 - 33**

The TCCS performed well during the report period with no anomalies. There were 12 shutdowns during the period, but none were flight-like. A shutdown summary follows:

1. (Monday, 11/30/92, 1345) - Scanner communication to the TCCS computer was interrupted during sampling. The scanner was bumped by the sample cart. Communication was regained immediately after shutdown. A scanner cover was installed to alleviate the possibility of a repeat incident.
2. (Thursday, 12/31/92, 1345) - A short duration TCCS shutdown occurred due to a blown fuse in the TCCS power unit.
3. (Wednesday, 01/06/93, 0945) - The cable between the scanner and the controlling computer was inadvertently disconnected during a subsystem modification. This caused the subsystem to shut down. Following the discovery of the problem, the cable was reconnected, and the subsystem was brought back on-line.
4. (Tuesday, 02/02/93, 1002) - The TCCS shut down during a subassembly hardware modification. The inlet air flow was temporarily restricted during the installation of a dust filter at the TCCS air inlet. The restricted air flow sent the subassembly into an orderly shutdown.
5. (Friday, 02/05/93, 1200) - The TCCS was temporarily brought down for software maintenance.
6. (Friday, 03/05/93, 1455) - The subassembly was brought down for the weekend through an orderly shutdown. This was done because a weekend facility power outage was scheduled. The subassembly was brought back on-line the following Monday.
7. (Saturday, 03/27/93, 1200) - A facility power interruption caused a TCCS shutdown.
8. (Sunday, 04/04/93, 1230) - A facility power interruption caused a TCCS shutdown.
9. (Tuesday, 04/20/93, 2200) - A facility power interruption, caused by construction activity in the 4755 parking area, resulting in a TCCS shutdown.
10. (Tuesday, 05/04/93, 0925) - The subassembly was inadvertently shut down due to operator error, and was immediately brought back on-line.

11. (Saturday, 06/26/93, 0148) - A facility power interruption caused a TCCS shutdown.

12. (Monday, 06/28/93, 0828) - The subassembly was intentionally brought down for scanner modifications.

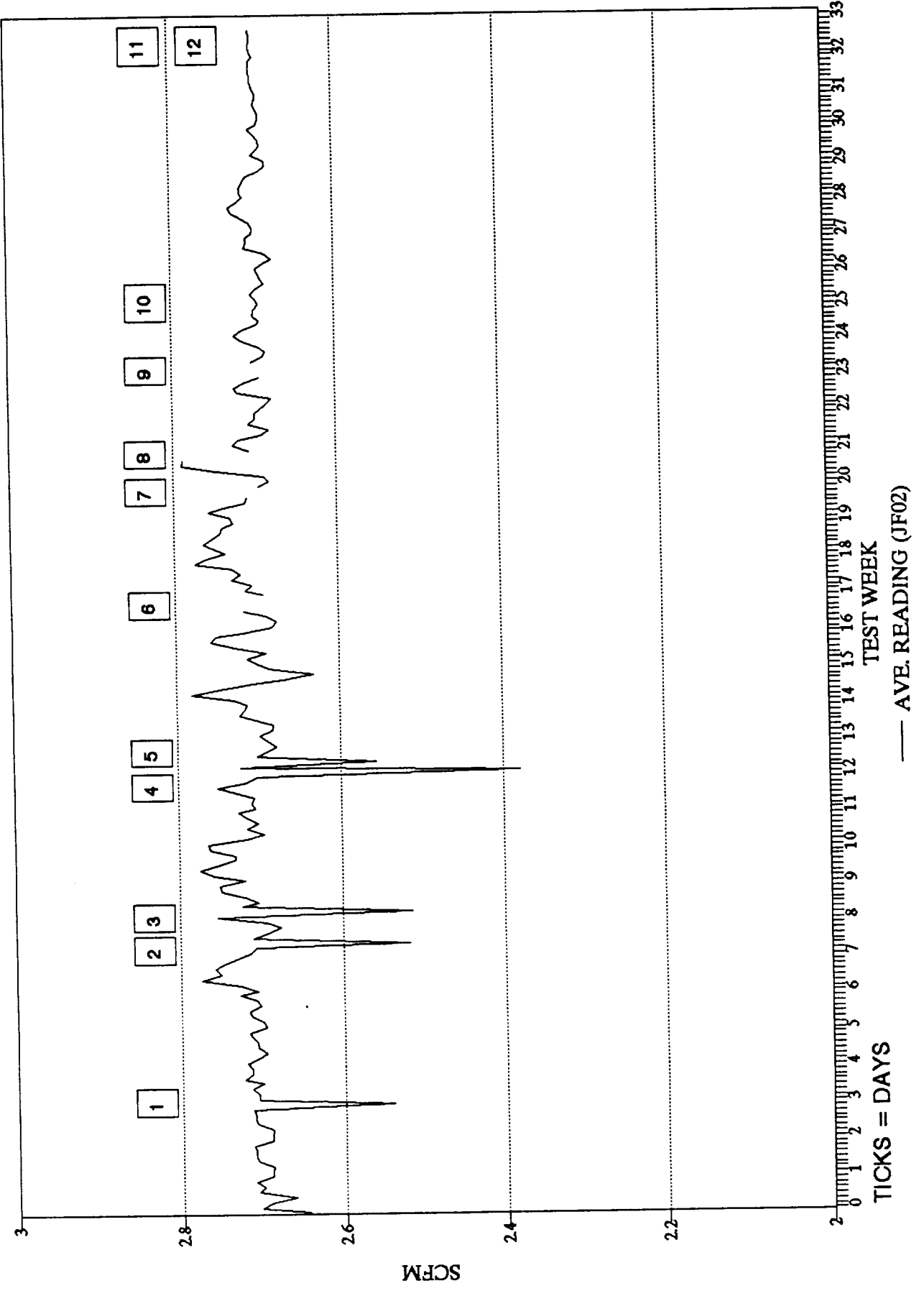
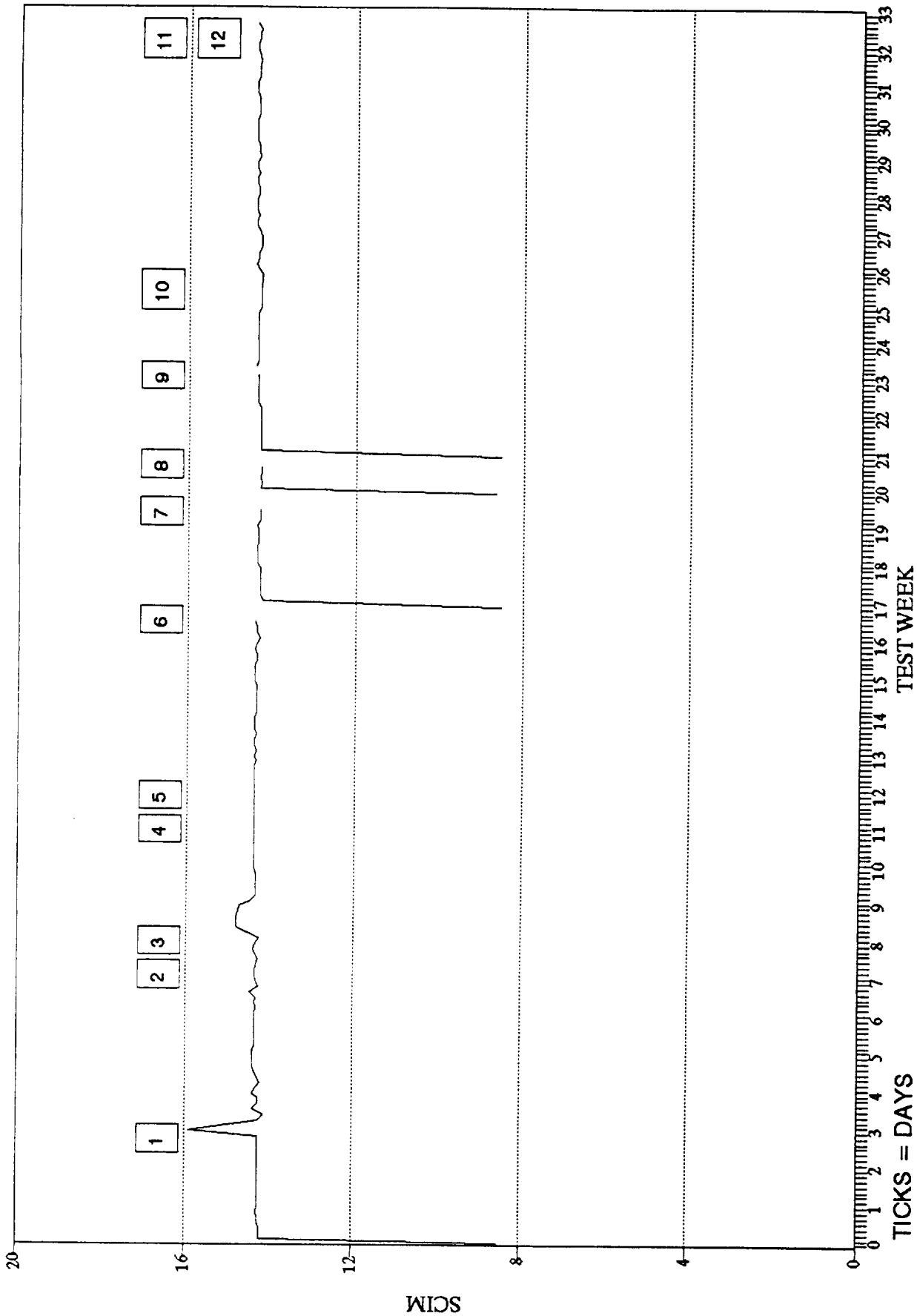

Figure 2.1-1 JF02: Oxidizer Low Leg Flow Rate





— AVE. READING (JF04)

Figure 2.1-2 JF04: Methane Bleed Rate

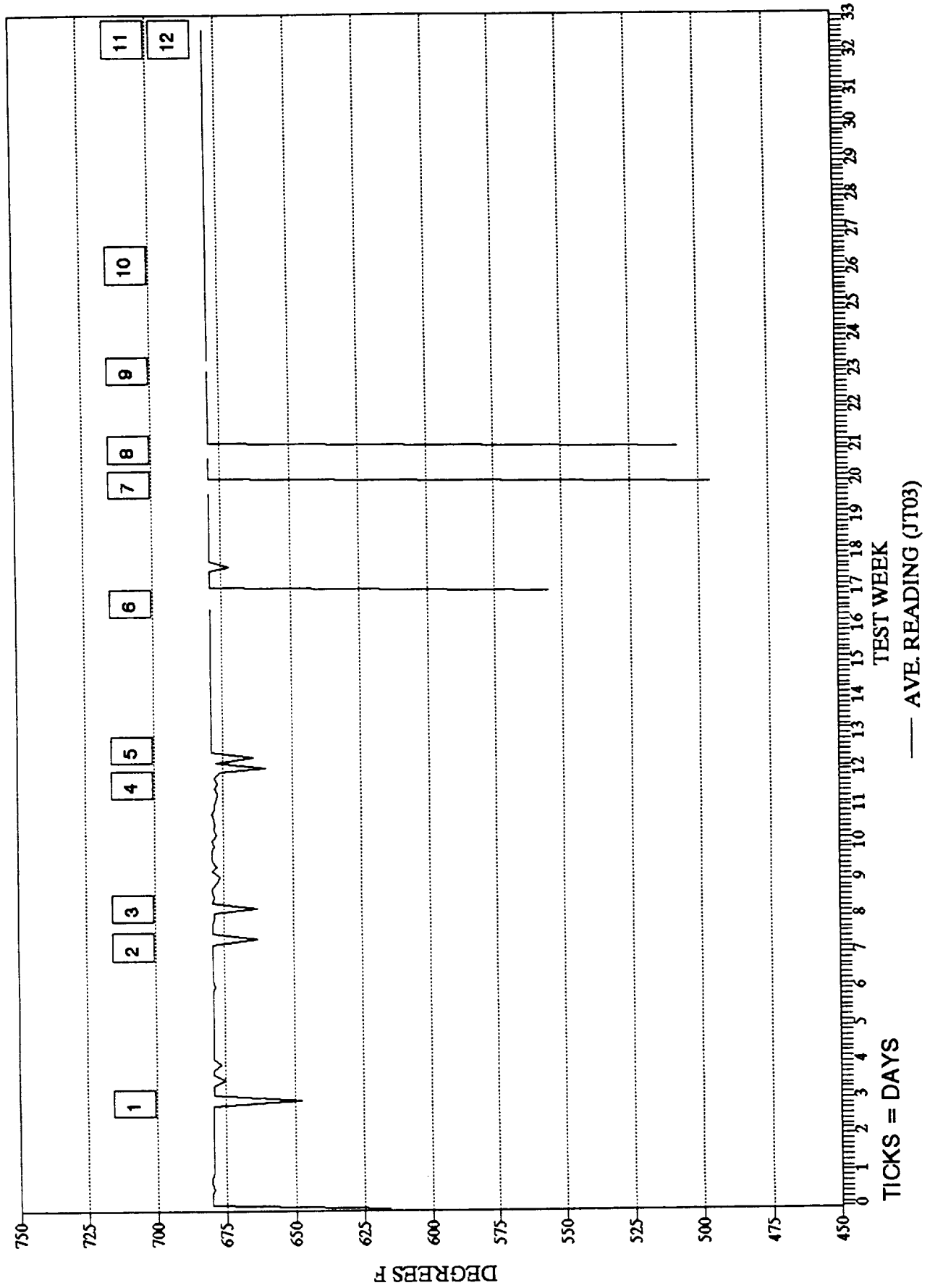
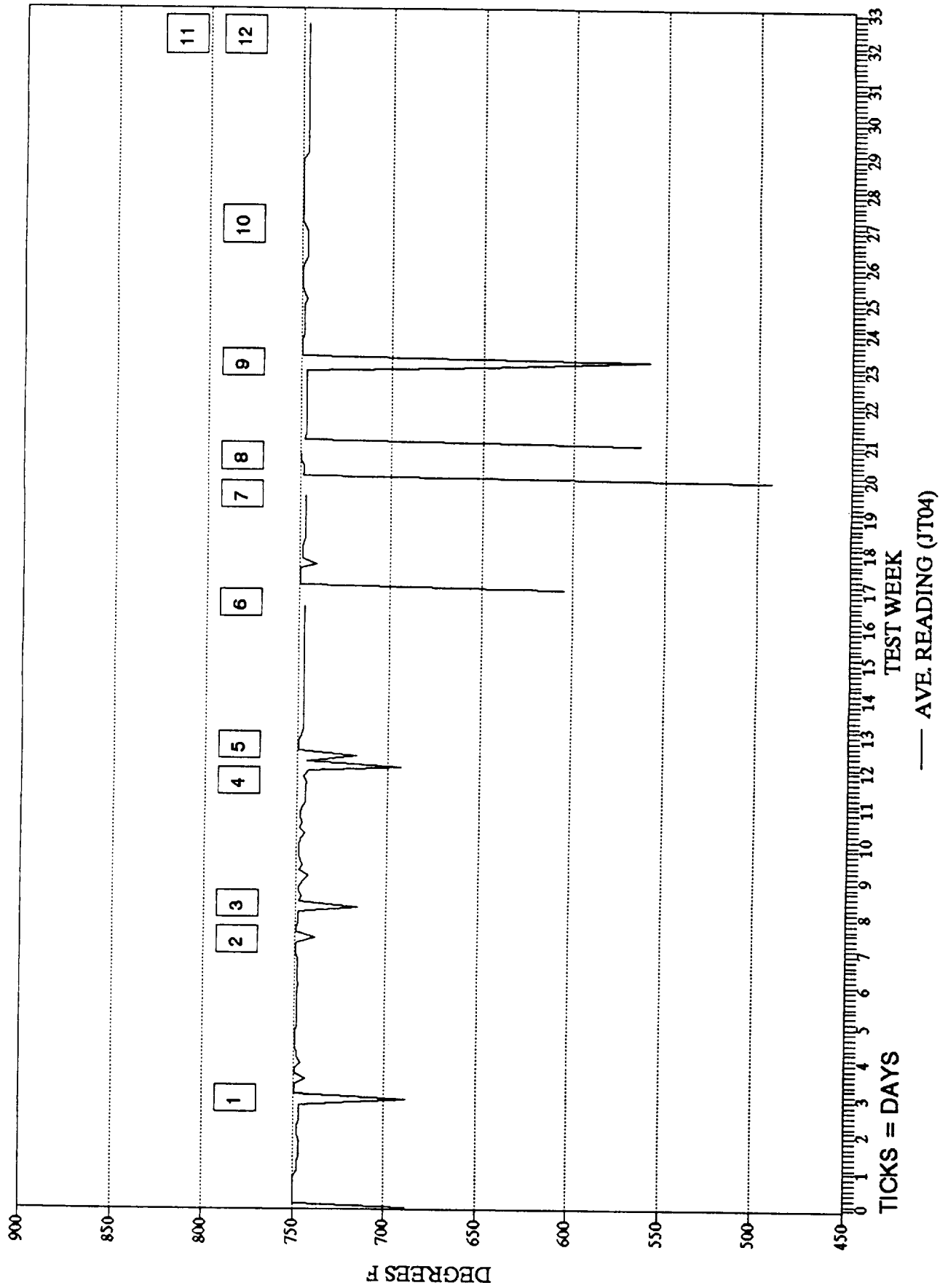

Figure 2.1-3 JT03: Pre Oxidizer Temperature



**Figure 2.1-4 JT04: Catalytic Oxidizer Temperature**

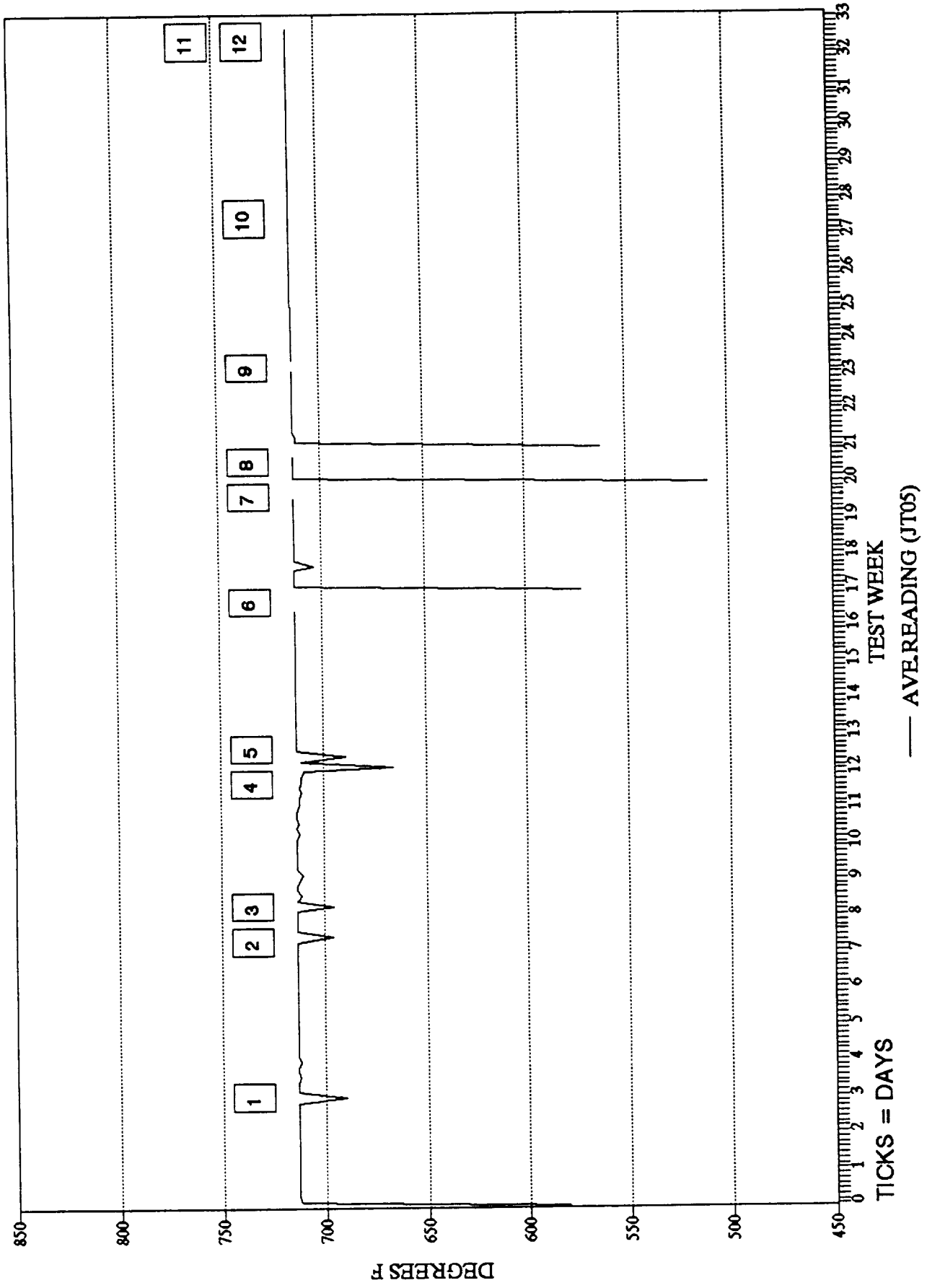
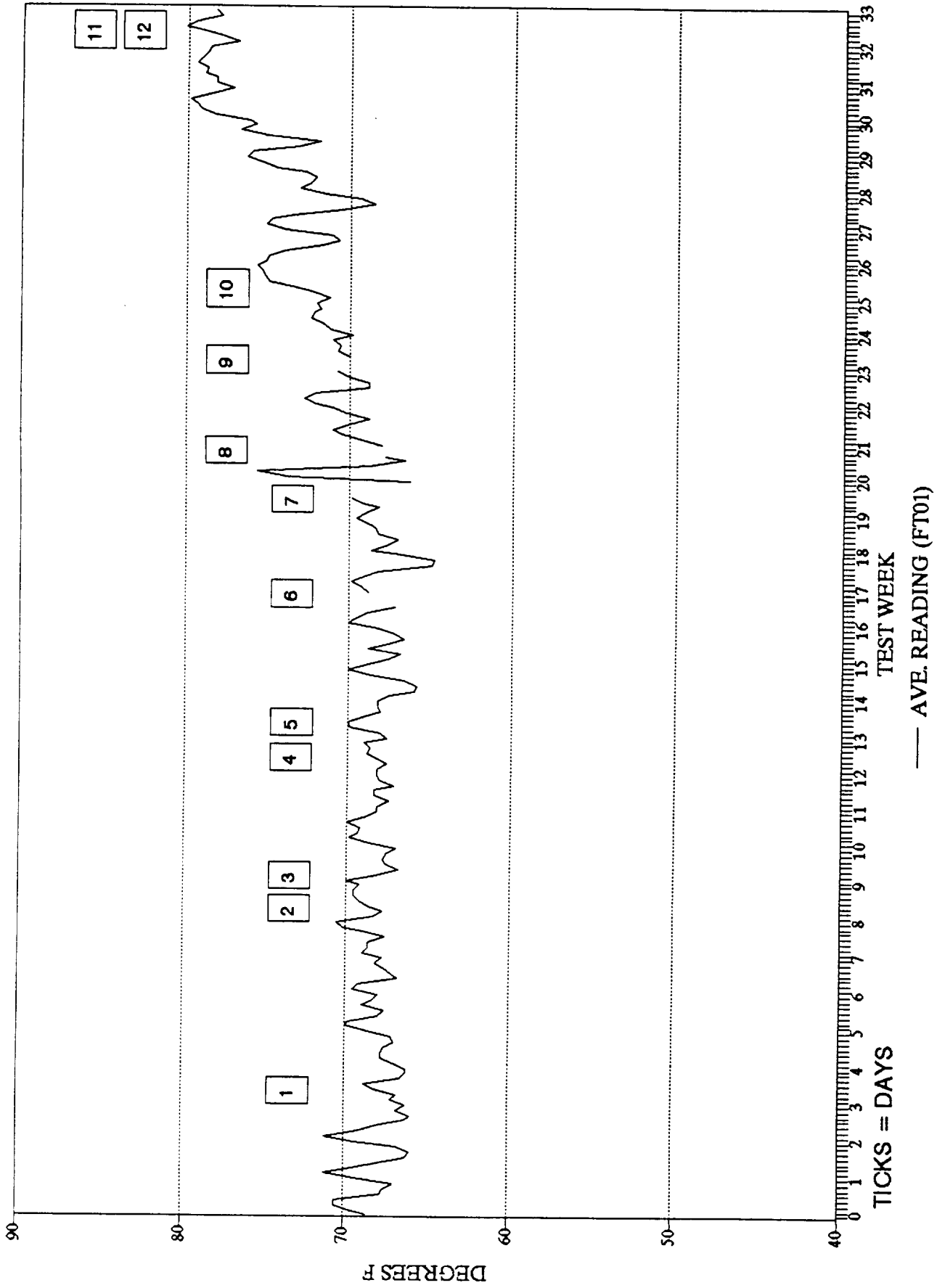

Figure 2.1-5 JT05: Post Oxidizer Temperature



**Figure 2.1-6 FT01: High Bay Temperature**

### 2.1.1 Performance (Weeks 1 - 33)

The TCCS performed well through test week 33. Calculated Methane removal efficiencies were (though suspect - see Section 2.0) at or above 95% (Figure 2.1.1-1).

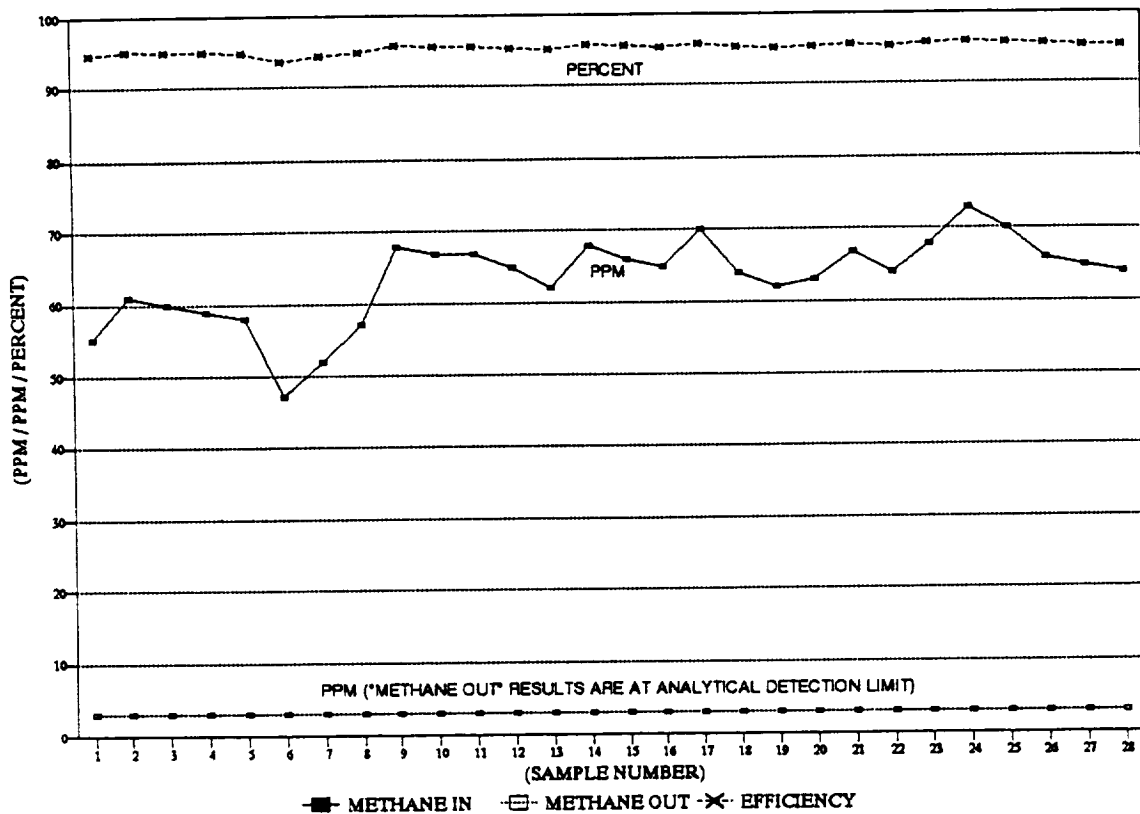

Figure 2.1.1-1 Oxidation Efficiency (1 - 33 Summary)

## 2.2 Test Weeks 34 - 47

The TCCS performed well during the period with no anomalies. There were 6 shutdowns between weeks 34 and 47 (inclusive), but none were flight-like. A summary follows:

1. (Saturday, 06/26/93, 0148) - A facility power interruption caused a TCCS shutdown. This outage actually occurred during week 33 of testing, but carried into week 34 (Monday, 06/28/93, 0828), when the subassembly was restarted.
2. (Tuesday, 07/06/93, 1340) - A facility power interruption caused a TCCS shutdown. The subassembly was restarted the same day.
3. (Thursday, 07/28/93, 0703) - A subassembly shutdown occurred due to an unscheduled facility power "brown out". The subassembly was restarted at approximately 0730 of the same day.
4. (Monday, 08/02/93, 0457) - A facility power interruption caused a TCCS shutdown. The subassembly was restarted at approximately 0600 on the same day.
5. (Thursday, 08/05/93, 2310) - A facility power interruption caused a TCCS shutdown. The subassembly was restarted at approximately 0600 on 08/06/93.
6. (Sunday, 09/26/93, 1300) - A facility power interruption caused a TCCS shutdown. The power outage was caused by a thunderstorm. The subassembly was allowed to remain down until the morning of 09/28/93 since a second power outage was scheduled for the evening of 09/27/93. The subassembly was restarted at approximately 0600 on 09/28/93.

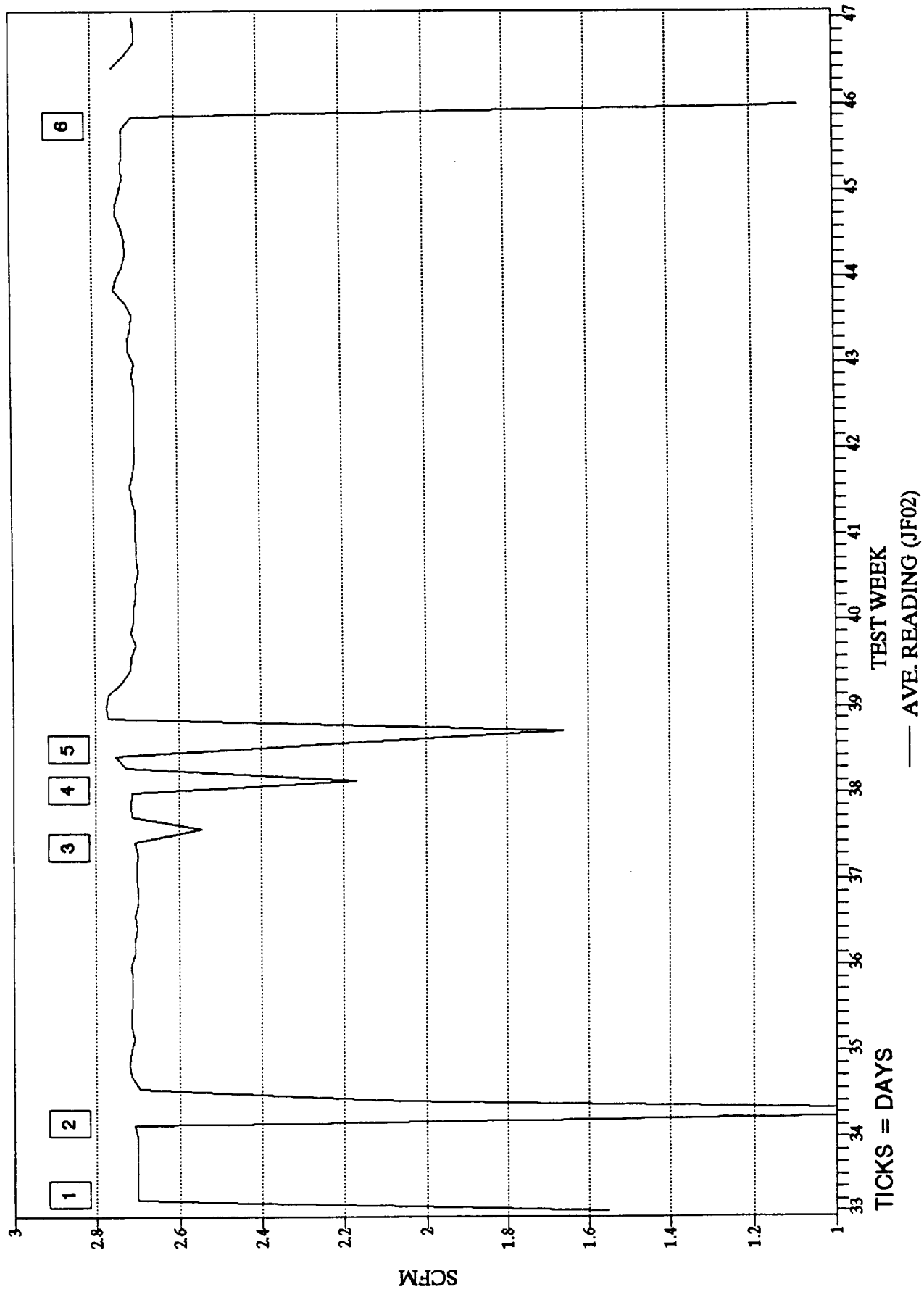

Figure 2.2-1 JF02: Oxidizer Low Leg Flow Rate



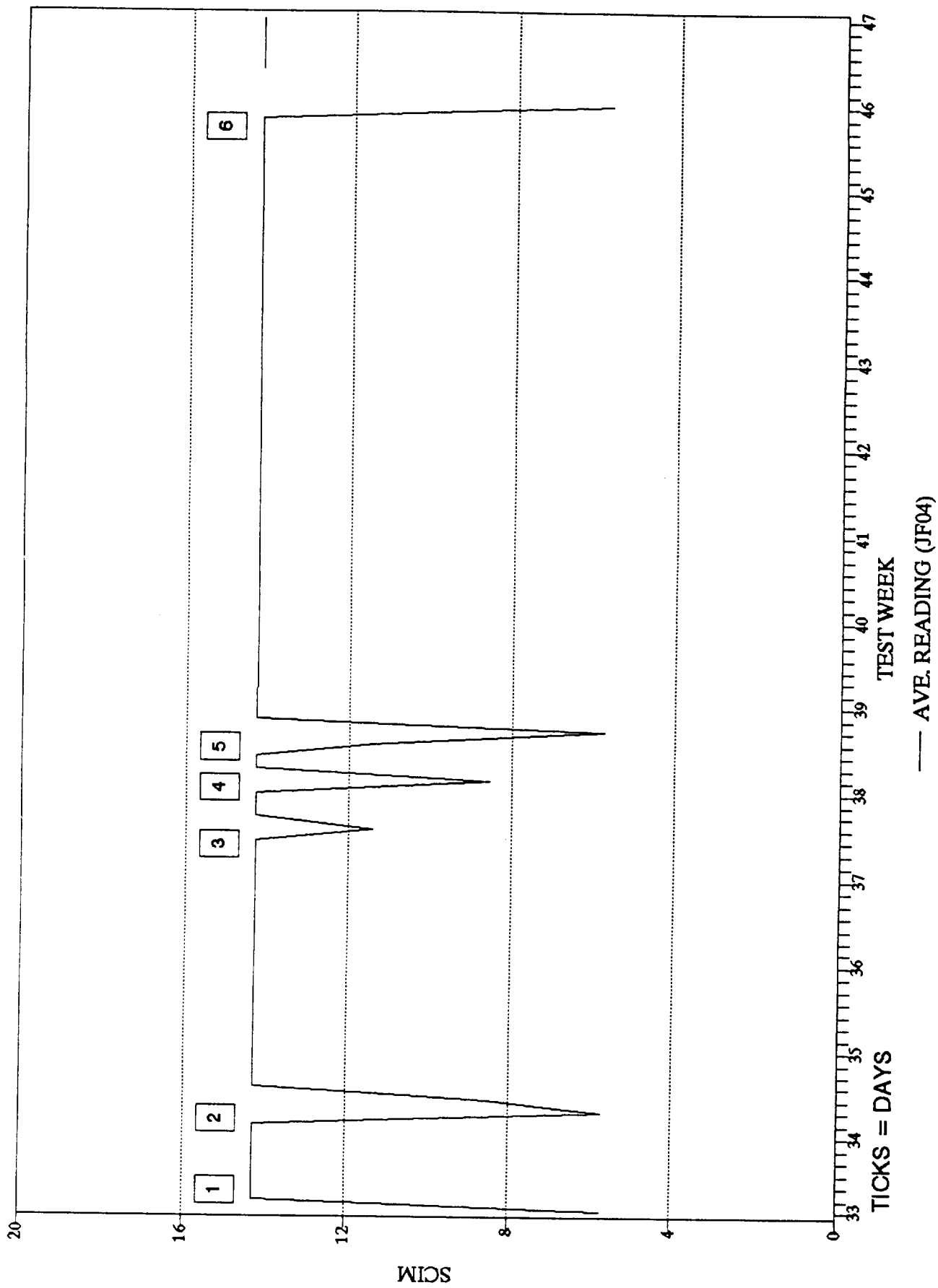

Figure 2.2-2 JF04: Methane Bleed Rate

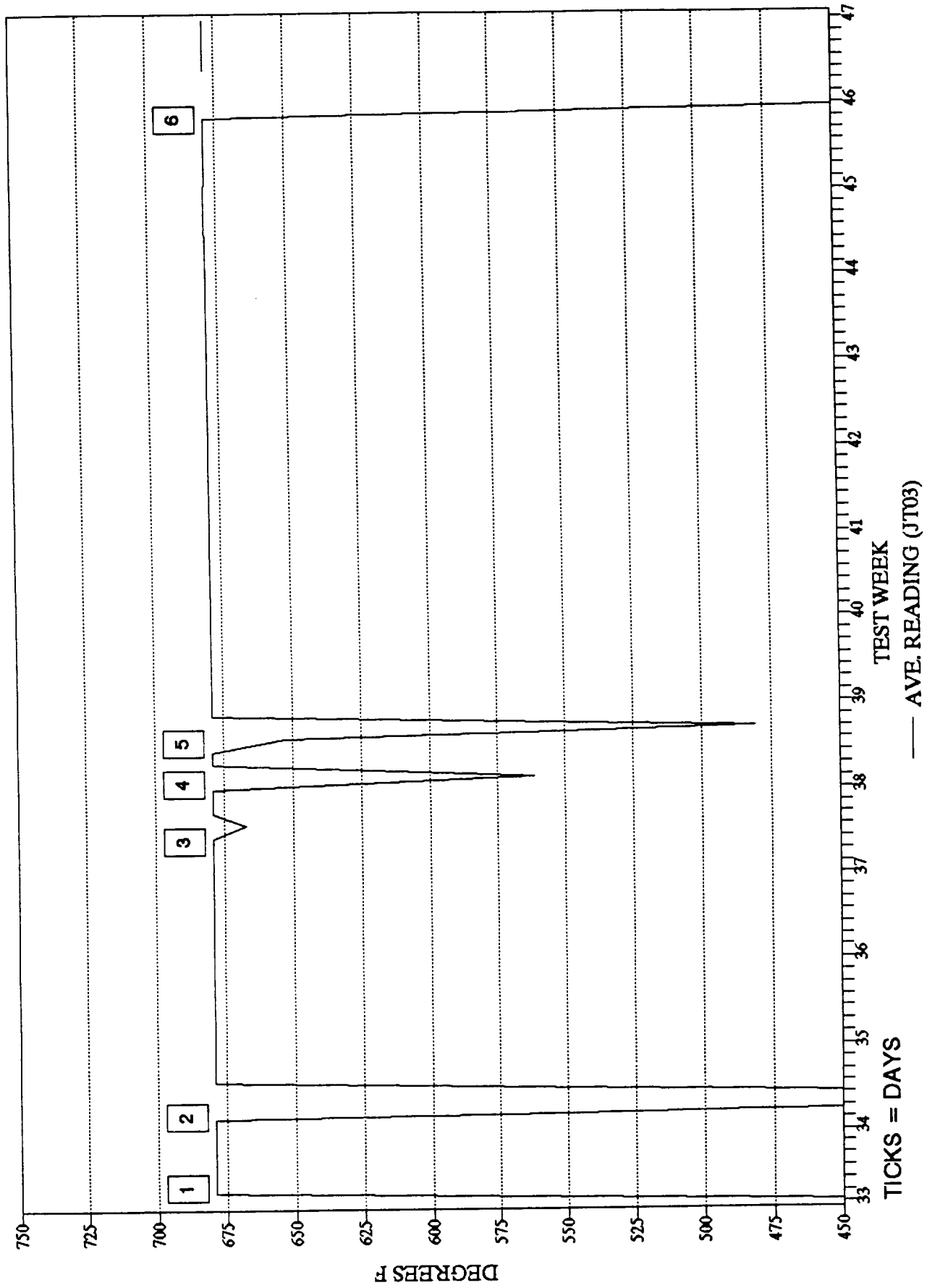

Figure 2.2-3 JT03: Pre Oxidizer Temperature

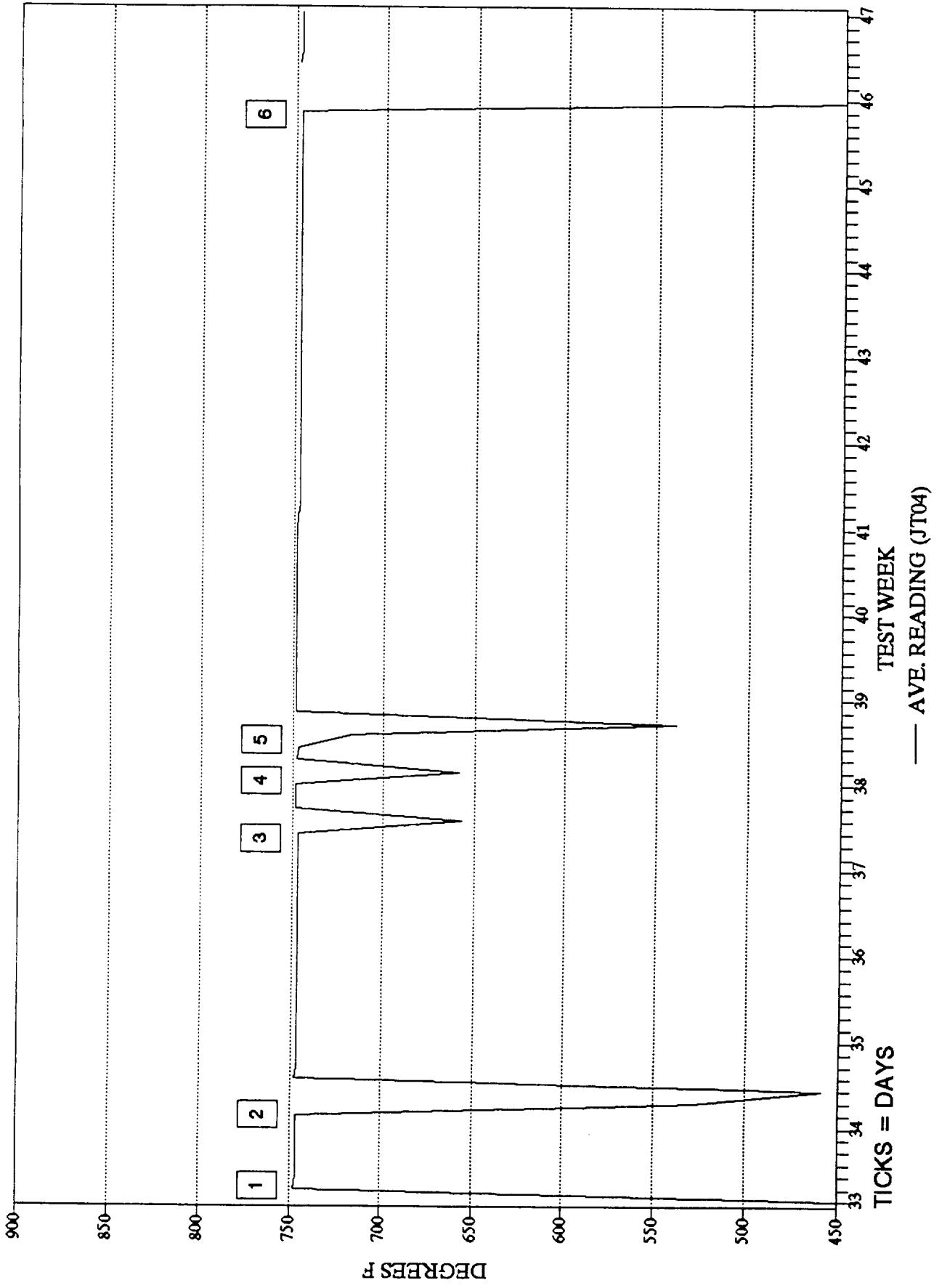

Figure 2.2-4 JT04: Catalytic Oxidizer Temperature

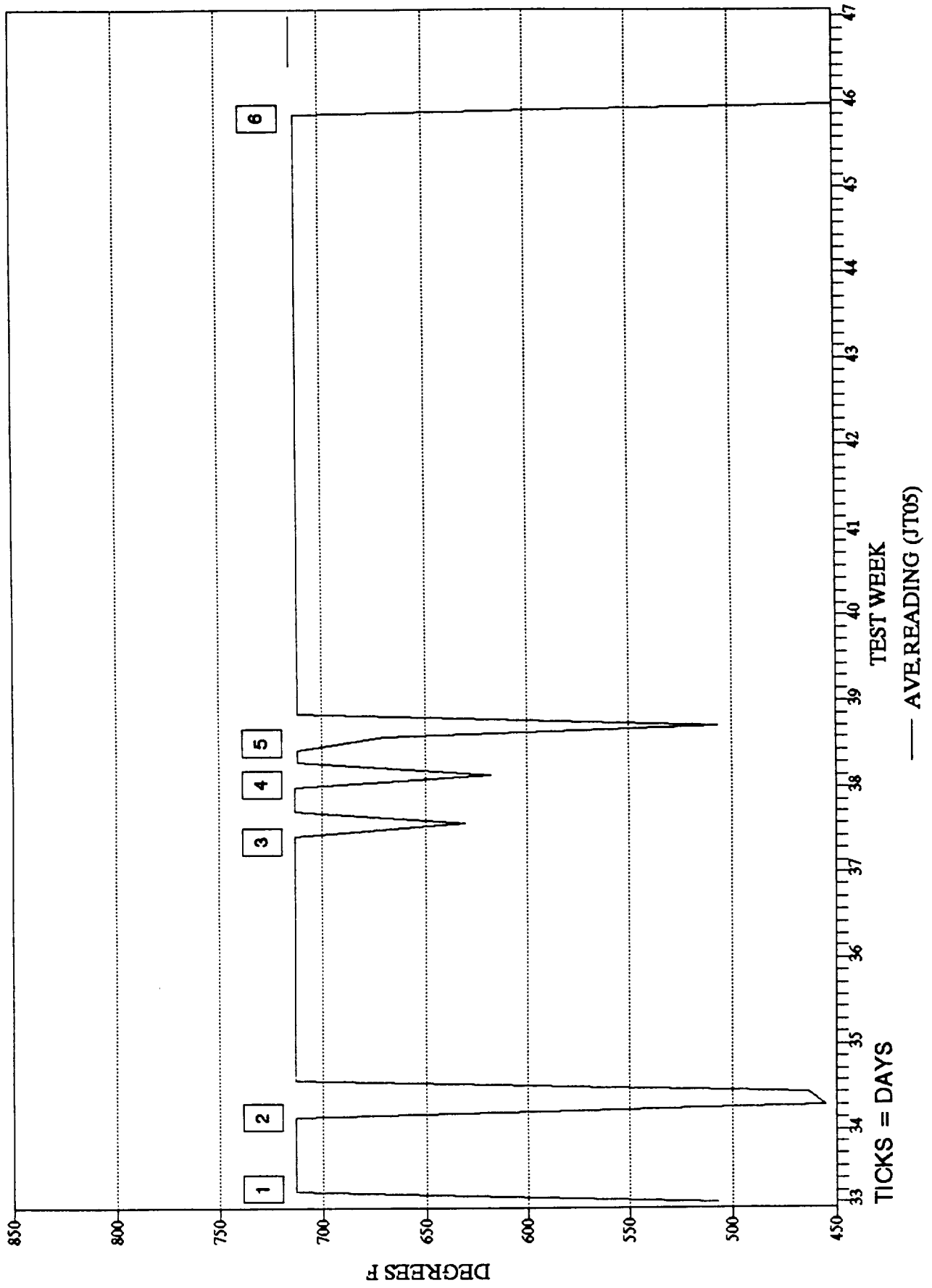
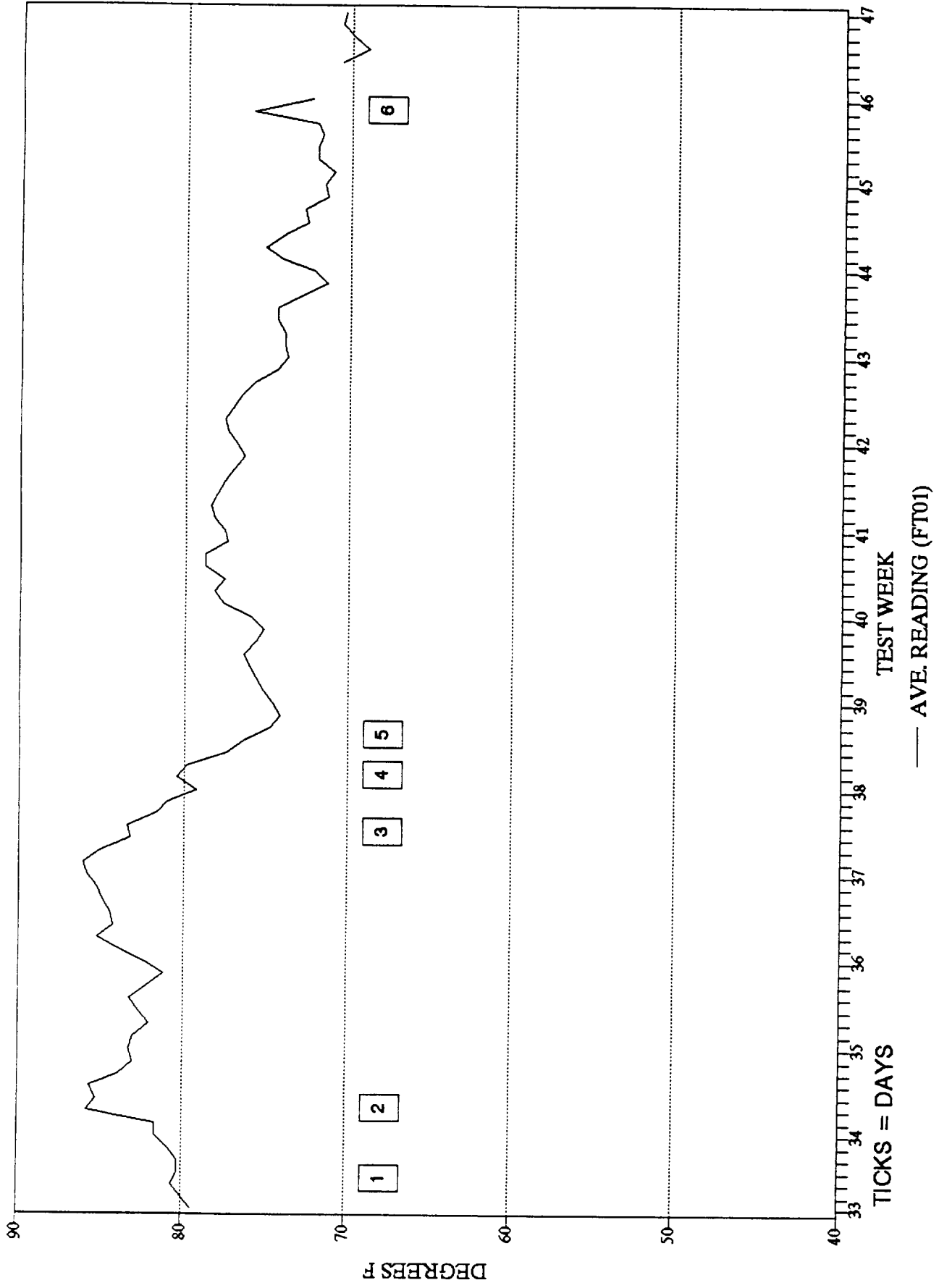

Figure 2.2-5 JT05: Post Oxidizer Temperature



**Figure 2.2-6 FT01: High Bay Temperature**

### 2.2.1 Performance (Weeks 34 - 47)

The TCCS performed well during the test period. **Figure 2.2.1-1** gives a summary of TCCS efficiency for the period.

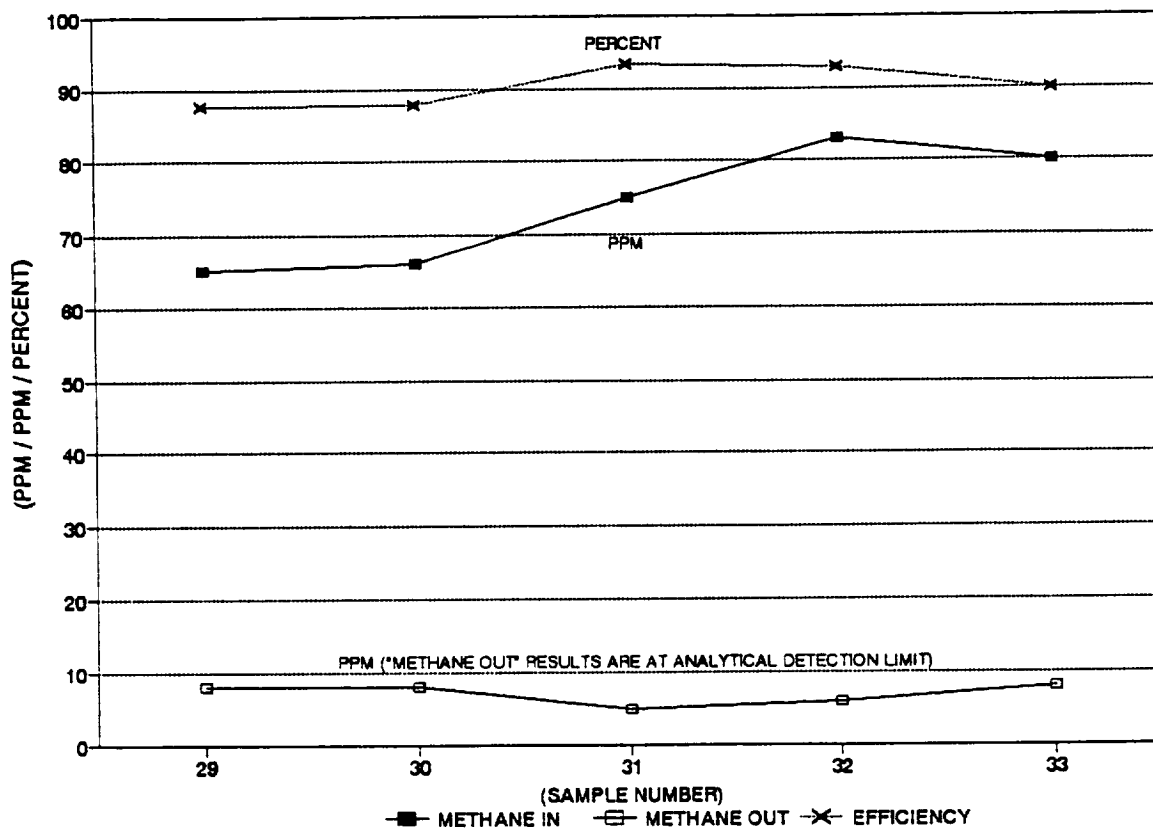

**Figure 2.2.1-1 Oxidation Efficiency (34 - 47 Summary)**

### 2.3 Test Weeks 47 - 60

The TCCS performed well during the period with no anomalies. There were four shutdowns and one data fluctuation between weeks 47 and 60 (inclusive), but none were flight-like. A summary follows:

1. (Sunday, 09/26/93, Time NA) - A facility power interruption caused a TCCS shutdown. The power outage was caused by a thunderstorm. The TCCS was allowed to remain down until day two of the following week (09/28/93) since a power outage was scheduled for day one of the week (09/27/93). The TCCS was brought back on-line at 0600 on 09/28/93.
2. (Friday, 10/15/93, 1315) - The TCCS was brought into an orderly shutdown for a facility power outage scheduled for 10/15/93 at 1730. Fifteen minutes into the shutdown, the power outage was canceled, and the TCCS was brought back on-line.
3. (Friday, 10/22/93, 1330) - The TCCS was brought down, through an orderly shutdown, for a scheduled facility power outage (on 10/22/93 at 1730). The subassembly was brought back on-line on 10/25/93 at 0600.
4. (Monday, 12/20/93, Approximately 2000) - A facility power interruption caused a TCCS shutdown. The subassembly was brought back on-line on 12/21/93 at 0730.
5. (Tuesday, 12/28/93, Approximately 1100) - The temperature at thermocouples JT03, JT04, and JT05, all within the HTCO, began dropping off. The temperature drop occurred over a two day period before stabilizing at 732°F. This represents a temperature change of -15°F. Methane samples were collected for the subassembly, and HTCO efficiency remained at 93%+ (efficiency in fact increased to over 96% due to increased inlet methane concentrations and relatively stable outlet concentrations). The temperature drop was not a result of catalyst failure. It was theorized that a leak may have developed in the HTCO causing a portion of the heat exchanger to be bypassed. Such a bypass would result in a loss of pre-heat potential, and lower overall reactor temperature (see **Section 2.4, #4**, for resolution of the problem).

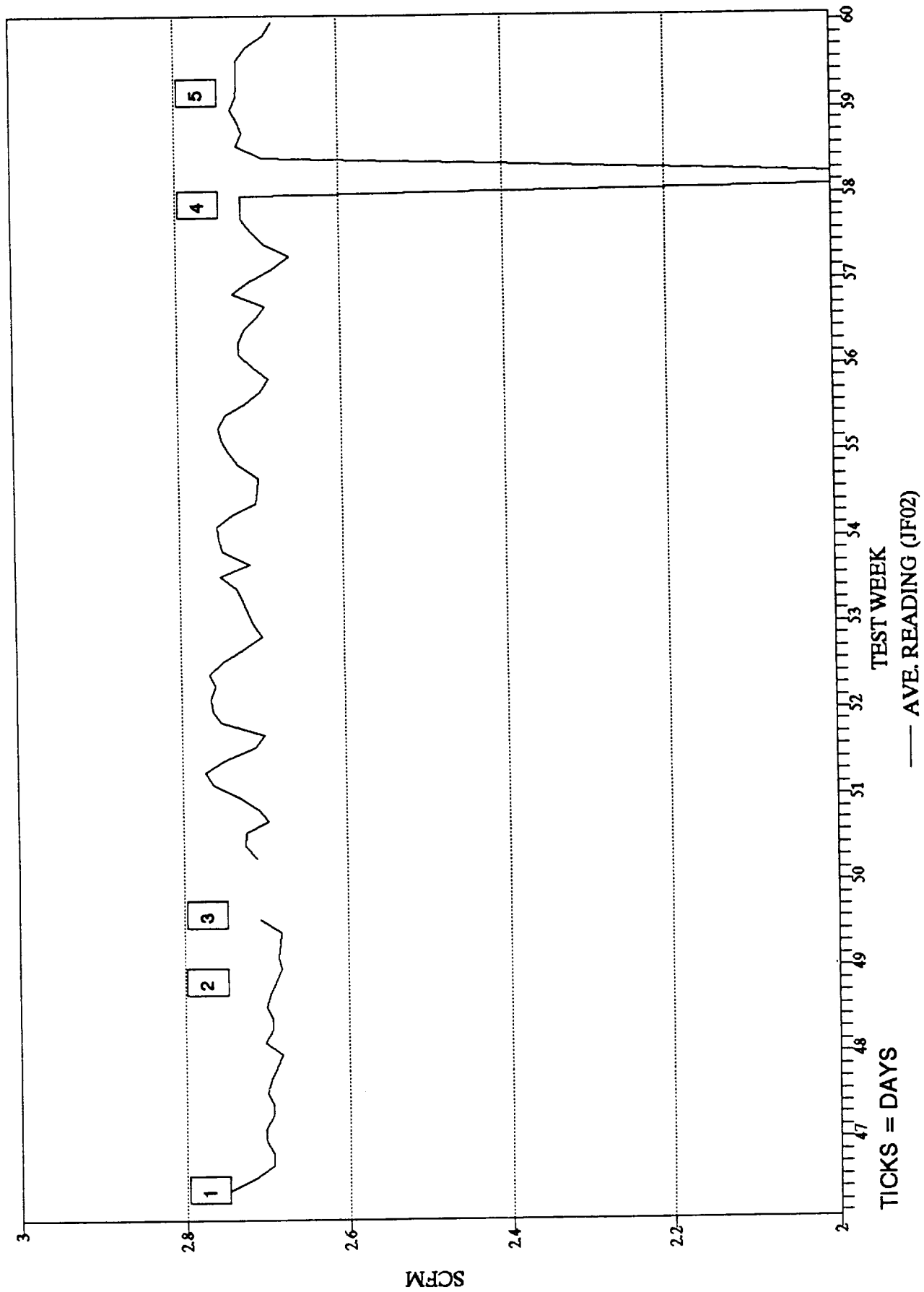
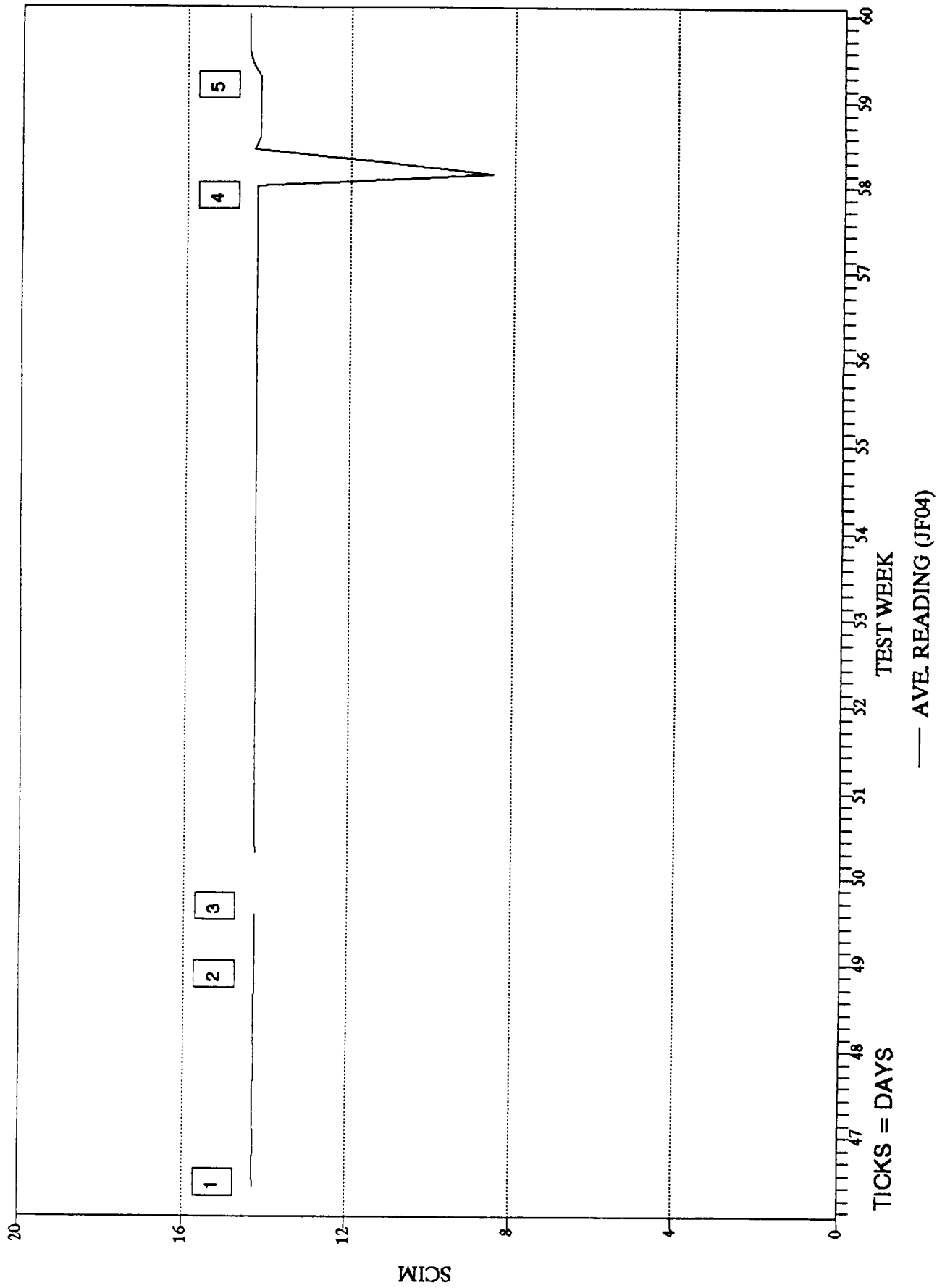

Figure 2.3-1 JF02: Oxidizer Low Leg Flow Rate





**Figure 2.3-2 JF04: Methane Bleed Rate**

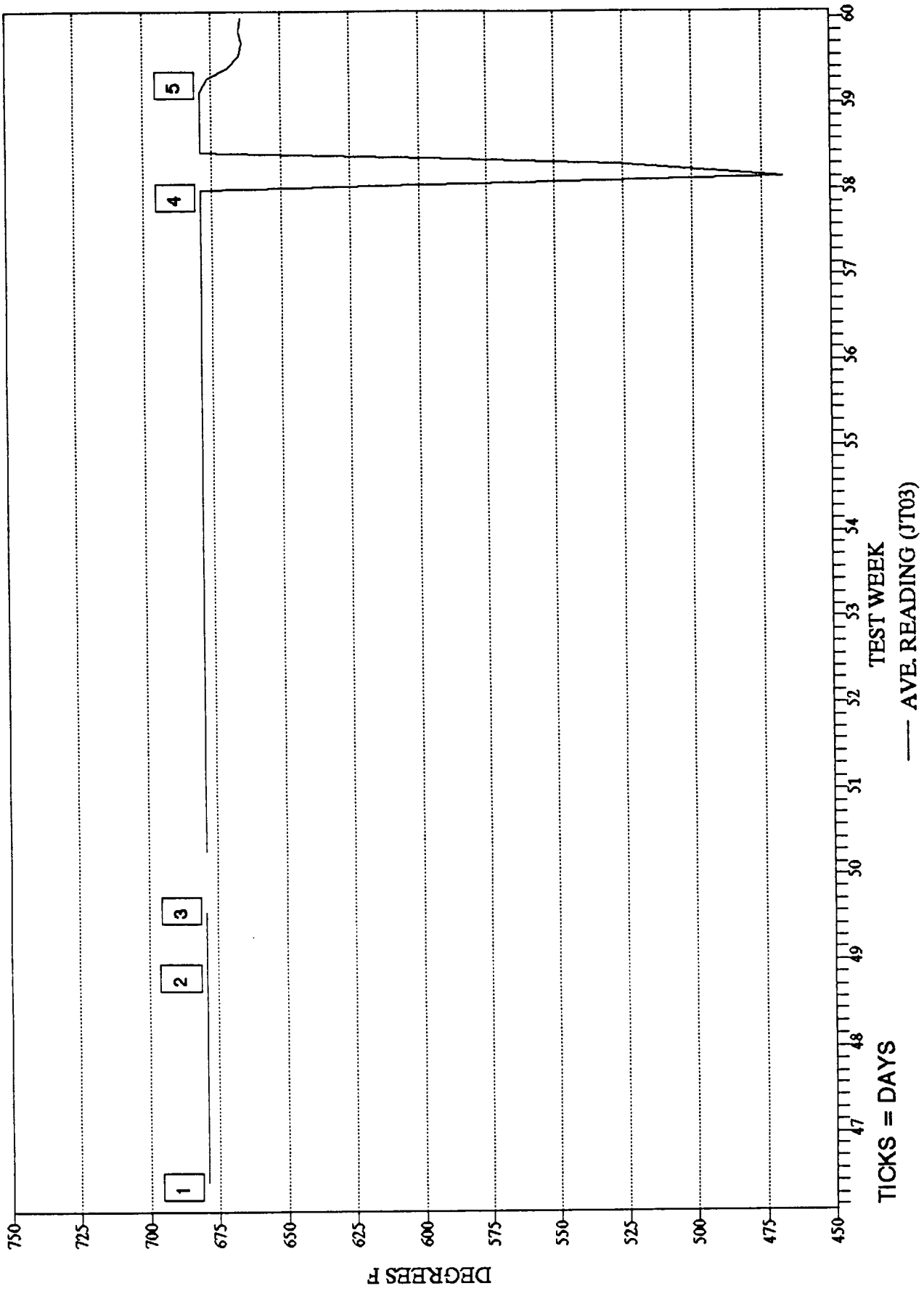

Figure 2.3-3 JT03: Pre Oxidizer Temperature

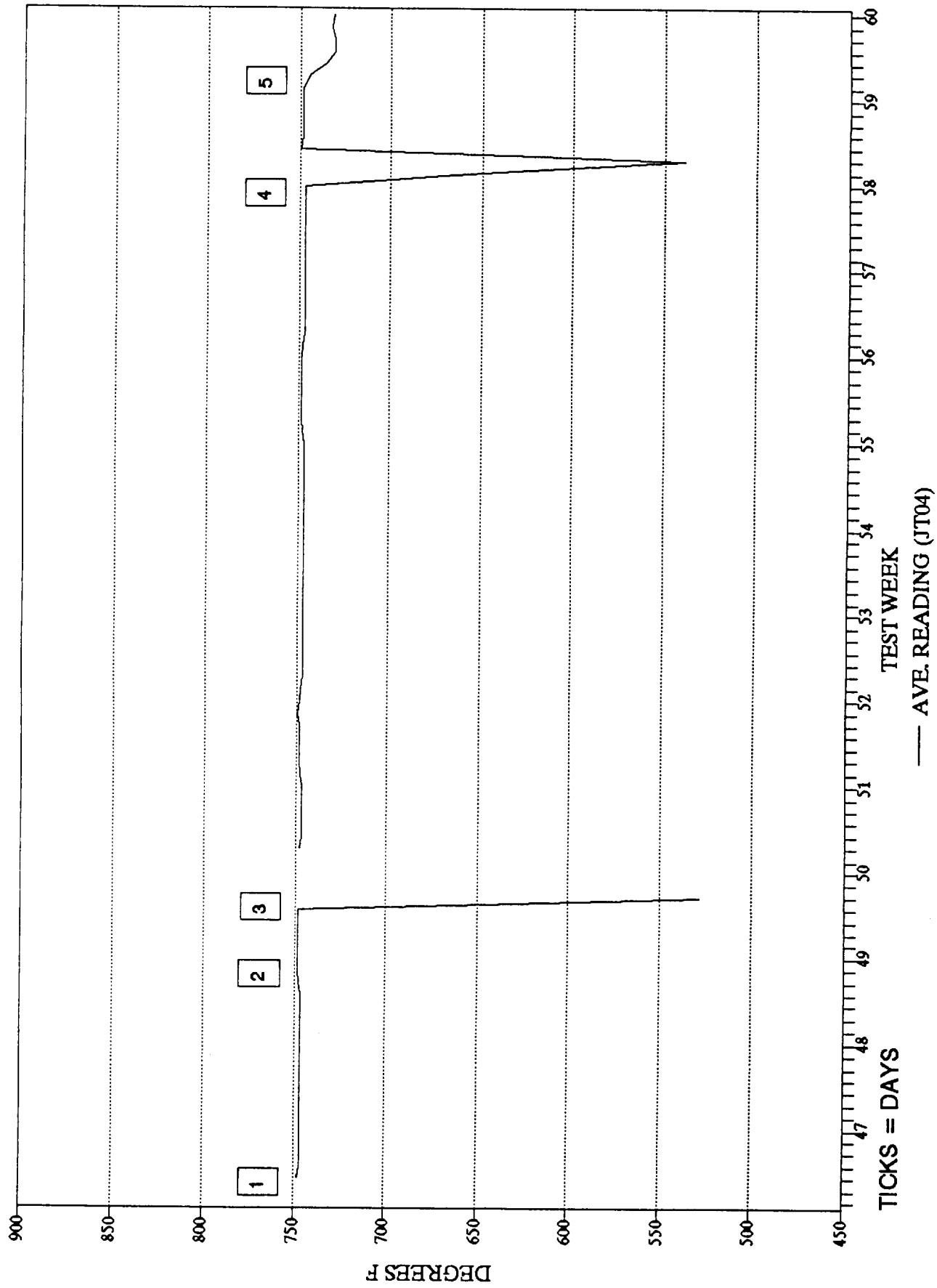

Figure 2.3-4 JT04: Catalytic Oxidizer Temperature

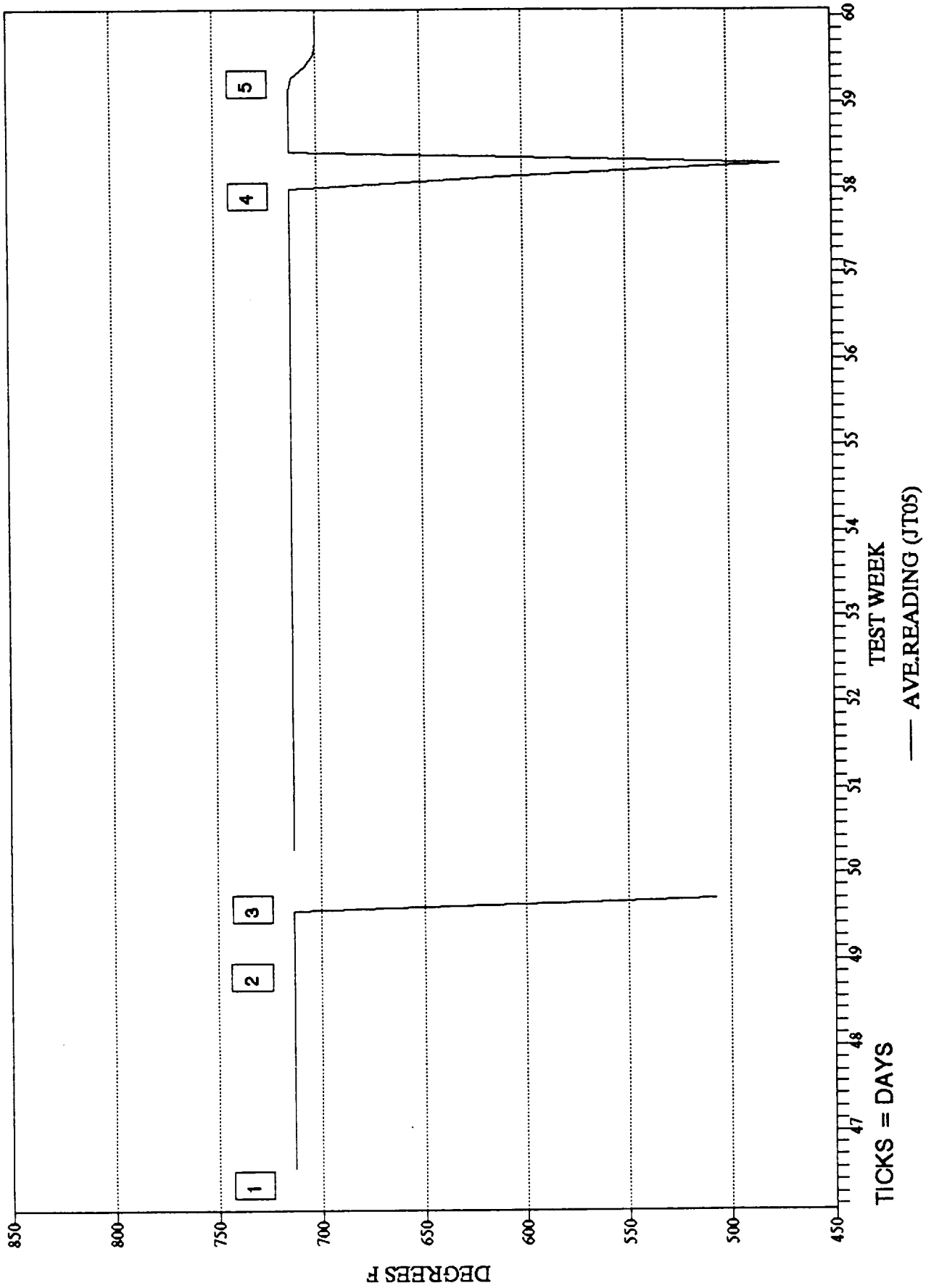
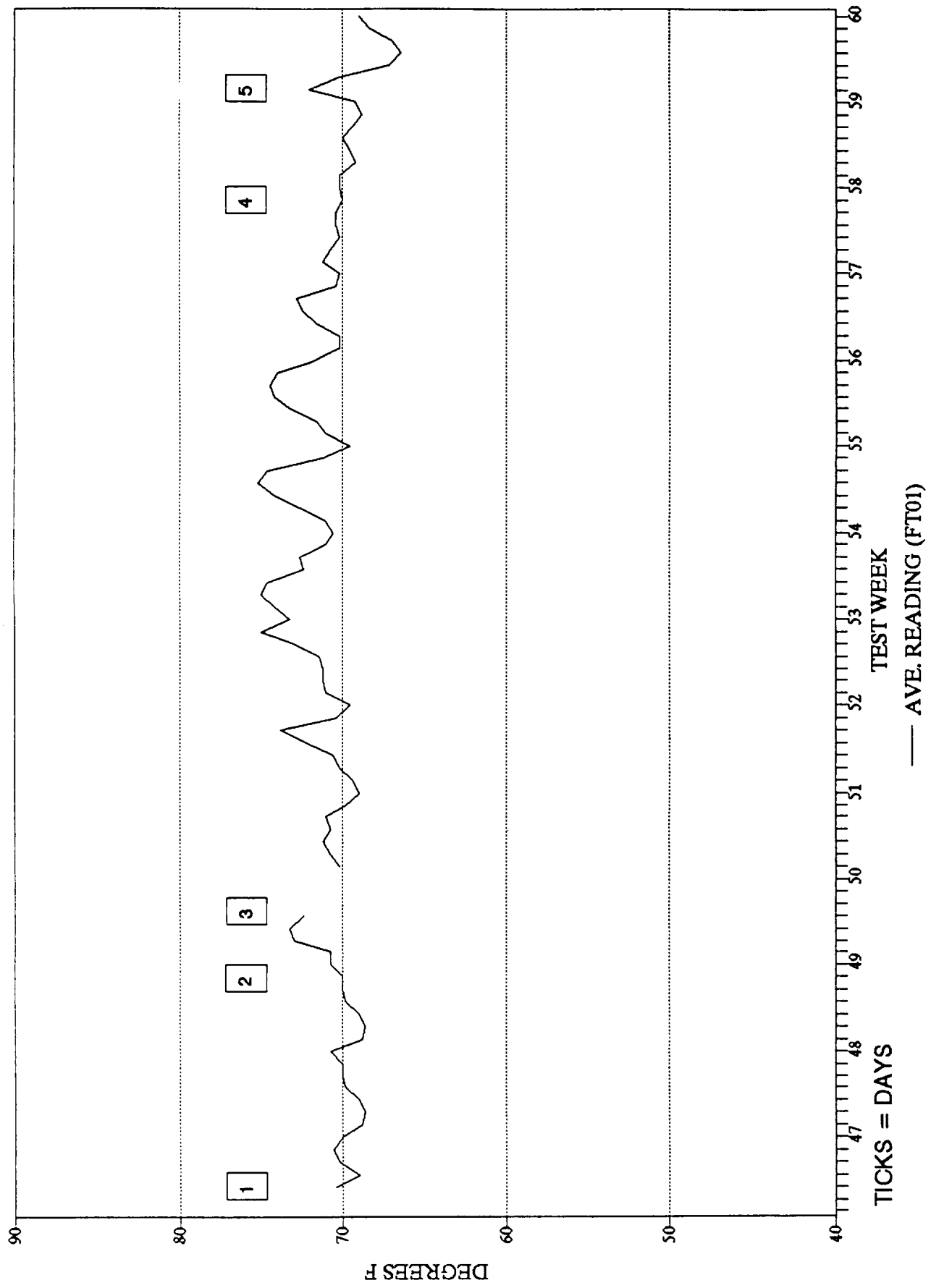

Figure 2.3-5 JT05: Post Oxidizer Temperature



**Figure 2.3-6 FT01: High Bay Temperature**

### 2.3.1 Performance (Weeks 47 - 60)

The TCCS HTCO has performed well to date (through week 60 of testing). There have been no subassembly anomalies. Methane removal efficiencies for this report period ranged between 91.89% and 96.55% (Figure 2.3.1-1) despite the drop in HTCO temperatures noted in Section 2.3 and resolved in Section 2.4.

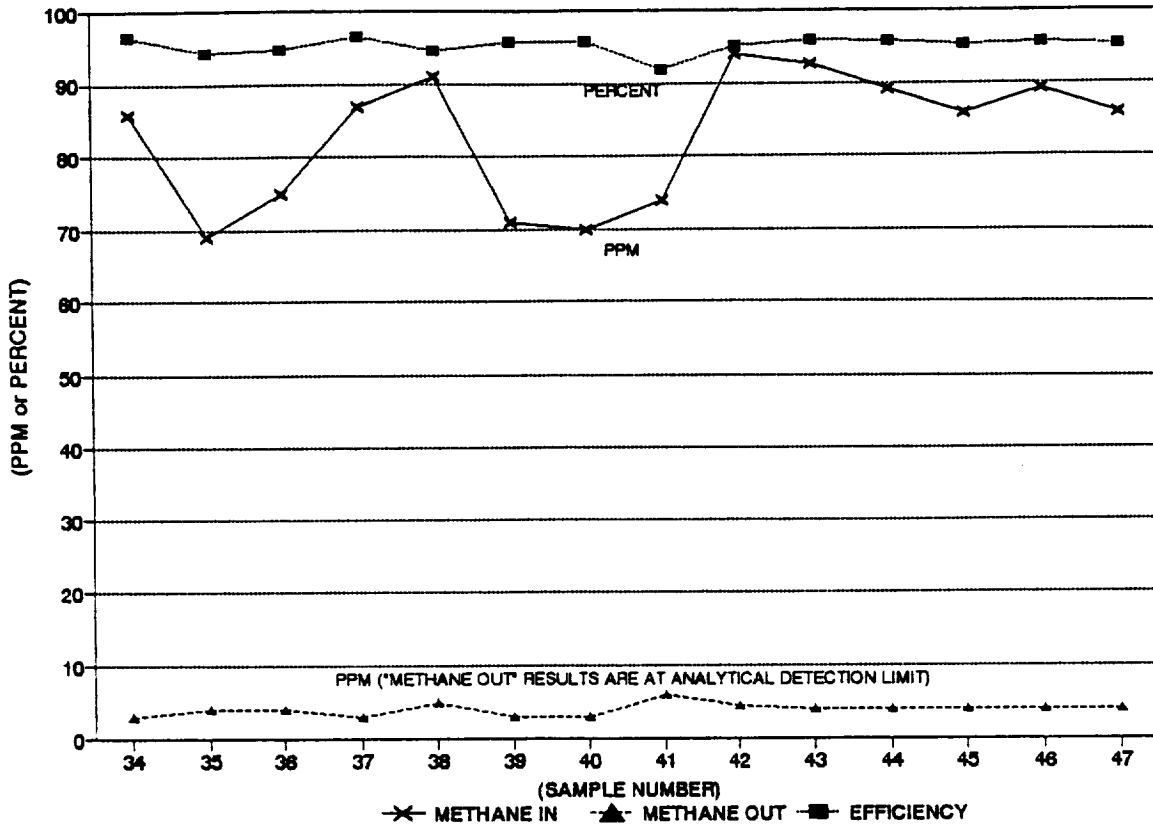

Figure 2.3.1-1 Oxidation Efficiency (47 - 60 Summary)

## 2.4 Test Weeks 61 - 72

The TCCS performed well during the report period with no anomalies. There were 4 shutdowns and 2 data fluctuations between test weeks 61 and 72 (inclusive), but none were flight-like. A summary follows:

1. (Tuesday through Saturday, 01/04/94-01/08/94) - A test was performed to determine whether the HTCO catalyst was oxidizing methane in the TCCS air stream. At 1035 of 01/04/94, the methane in-bleed to the HTCO was turned off, and the subassembly temperature was allowed to equilibrate. By approximately 1300 on 01/05/94, the HTCO temperature at JT04 (catalyst bed) had steadied at 710°F (an approximate drop of 21°F from the temperature with the methane in-bleed on). At 1320 the methane in-bleed was resumed. The temperature slowly climbed to 735°F, fell off slightly to 721°F, and stabilized at 721°F on 01/08/94. The rise in temperature, when the methane in-bleed resumed, showed that methane oxidation was indeed taking place.
2. (Tuesday, 01/10/94, 1540) - The TCCS was placed into an orderly shutdown. The subassembly was brought down to allow for calibration and maintenance. The subassembly was temporarily brought back on-line late in the week, and was again brought down to allow for software modifications.
3. (Wednesday, 01/18/94, 0615) - The TCCS subassembly was brought back on-line following a maintenance shutdown.
4. (Monday, 01/24/94, 0930) - The TCCS was brought down when an air leak around the HTCO heater power inlet was discovered. A plug of RTV sealant broke away allowing air to pass around the heater power lead. The leak was repaired using high temperature RTV sealant, and an additional thermocouple was installed to monitor the temperature at the new joint. The TCCS was brought back on-line at 0725 on 01/27/94, and HTCO temperatures quickly stabilized at the levels noted in 1993 (prior to the development of the leak). It is believed that the second temperature drop noted in #1 above was the result of the original plug falling out of place when the HTCO re-heated and expanded.
5. (Saturday, 2/12/94, Approximately 1200) - The sudden drop in the JT04 and Delta T curves is the result of a correction to the JT04 calibration curve originally installed. The method originally used in thermocouple calibration was incorrect, and resulted in high values at the upper end of the temperature range. The calibration was corrected, and a new baseline was established. The mistake had minimal effect on the test.
6. (Wednesday, 2/16/94, Approximately 0600) - The methane bleed was turned off, and the heater controller set-point was increased to 700°F. This was done to determine if the previous temperature reading could be achieved with the new (corrected) thermocouple readings (see #5 above). This was done with the methane off to simultaneously determine the baseline temperature for zero percent oxidation efficiency. The methane in-bleed resumed on Thursday, 02/17/94, and HTCO temperature increased to the desired level (Approximately 748°F).

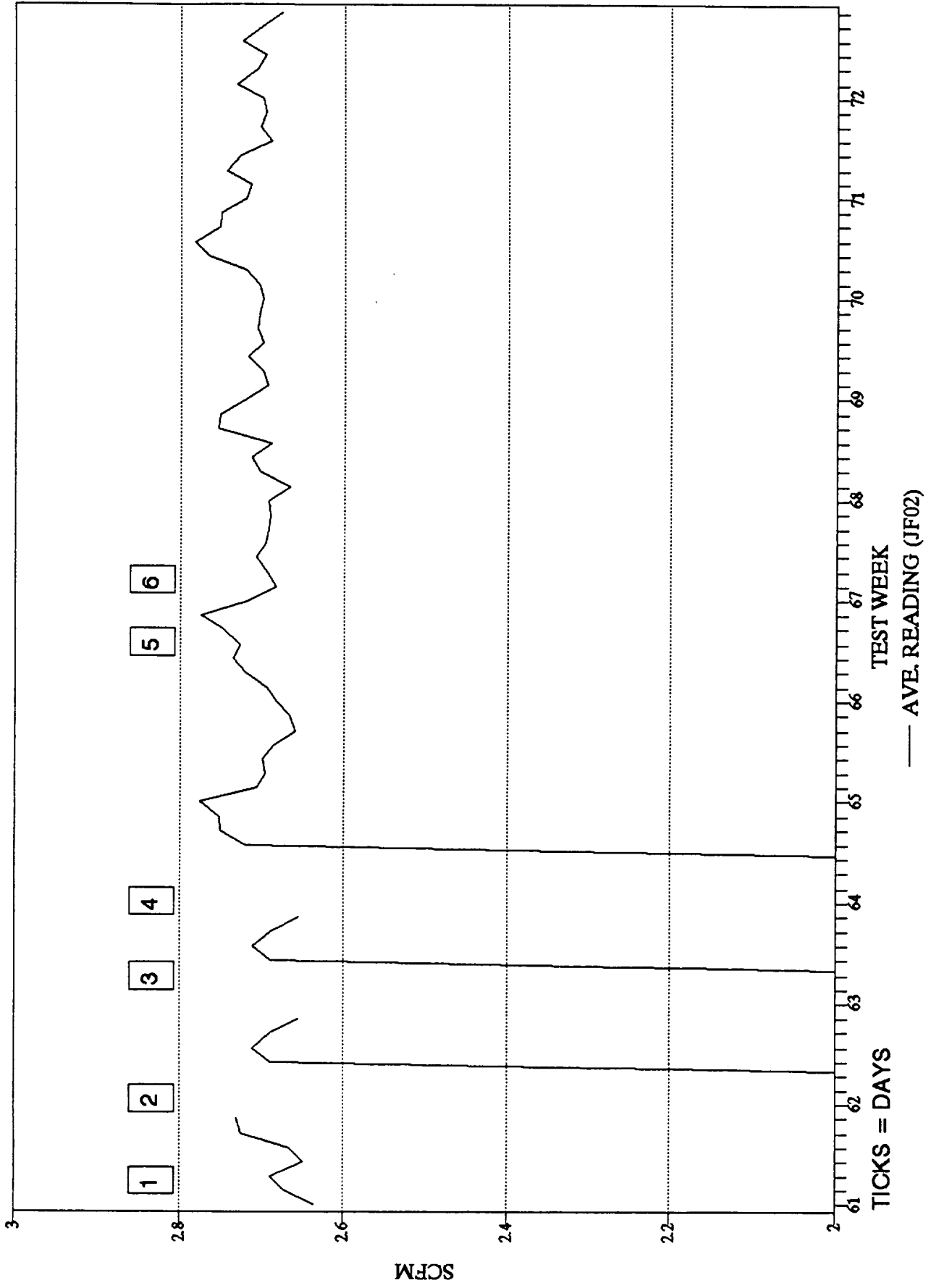

Figure 2.4-1 JF02: Oxidizer Low Leg Flow Rate



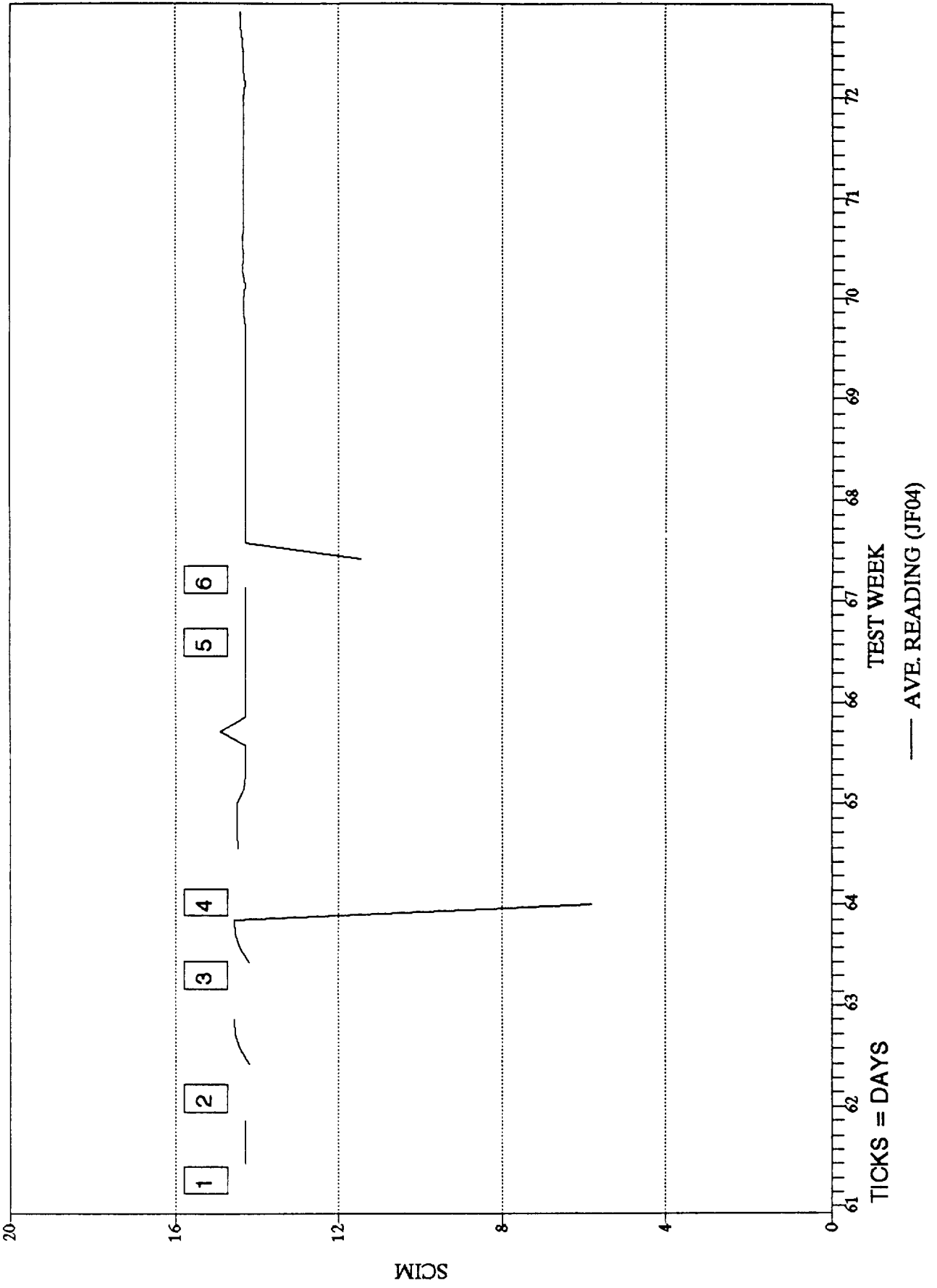

Figure 2.4-2 JF04: Methane Bleed Rate

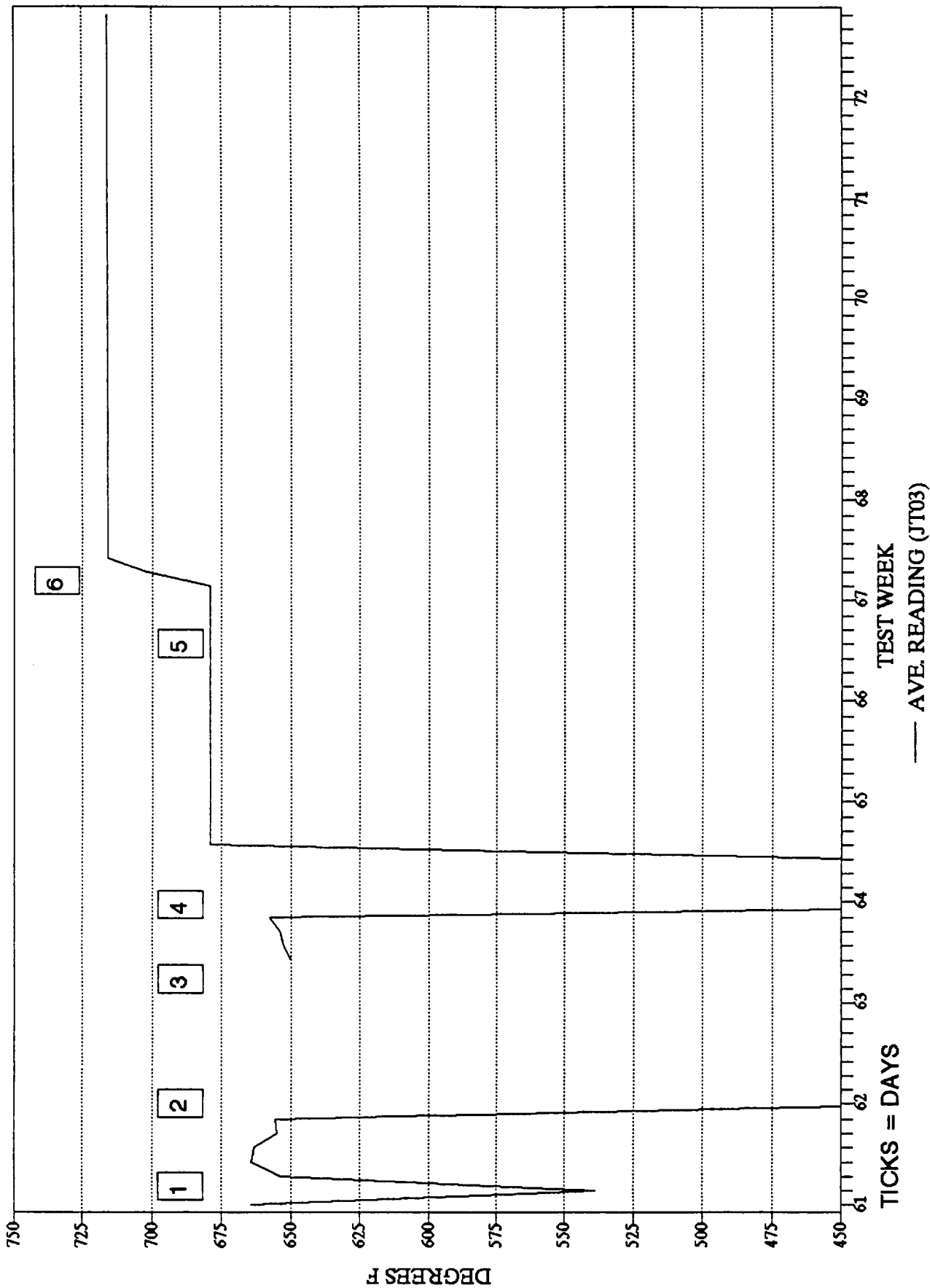

Figure 2.4-3 JT03: Pre Oxidizer Temperature

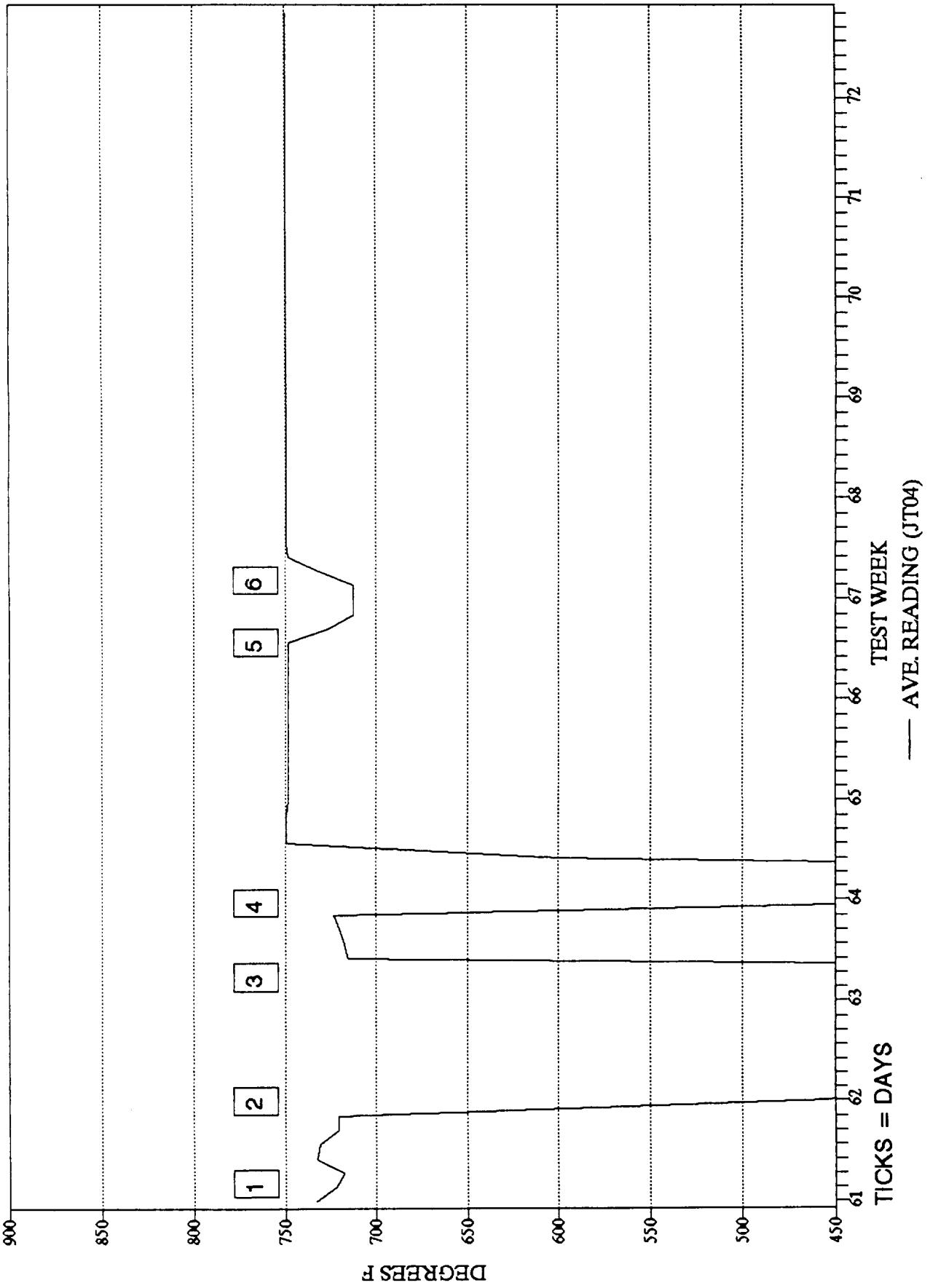

Figure 2.4-4 JT04: Catalytic Oxidizer Temperature

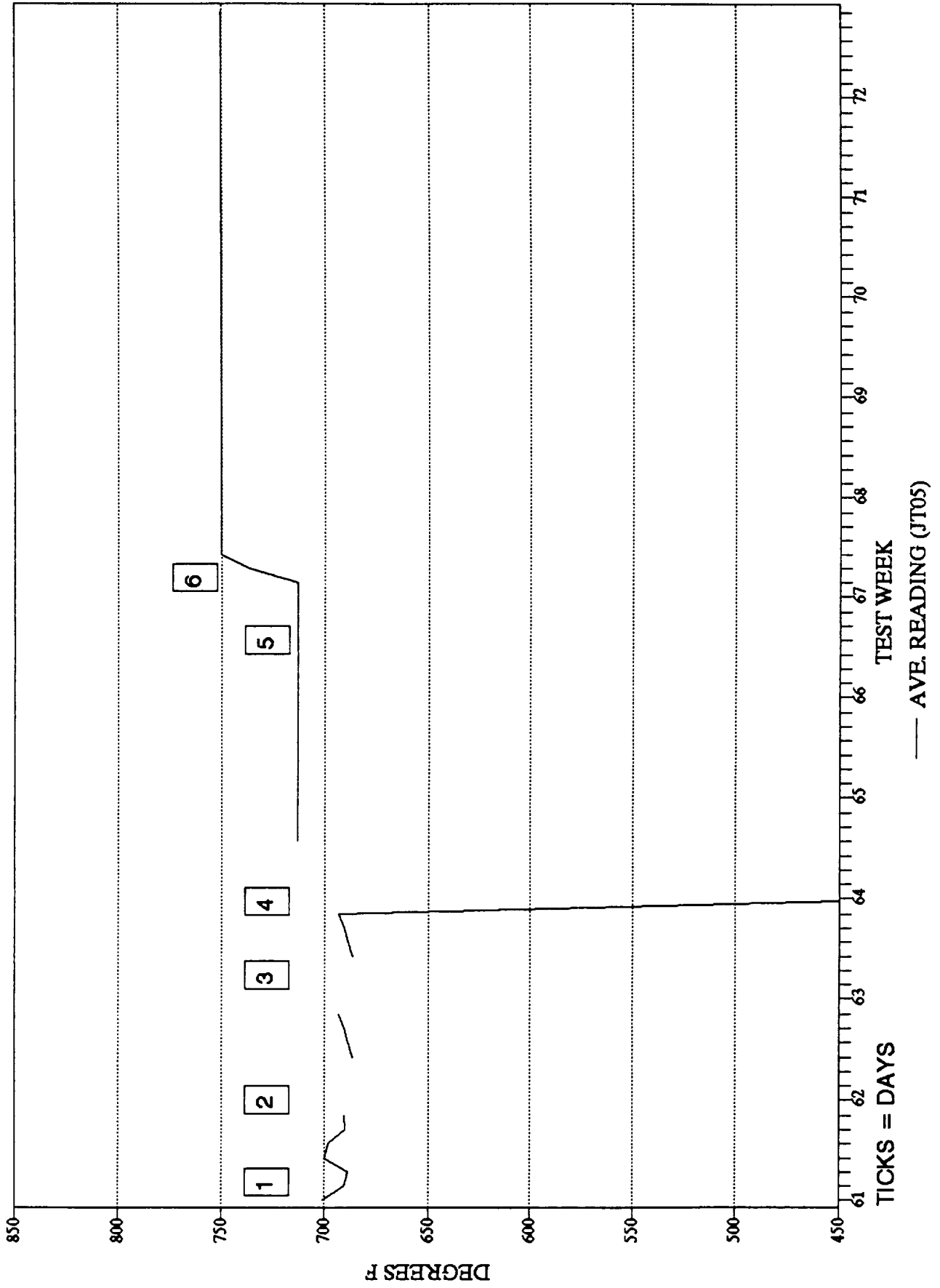
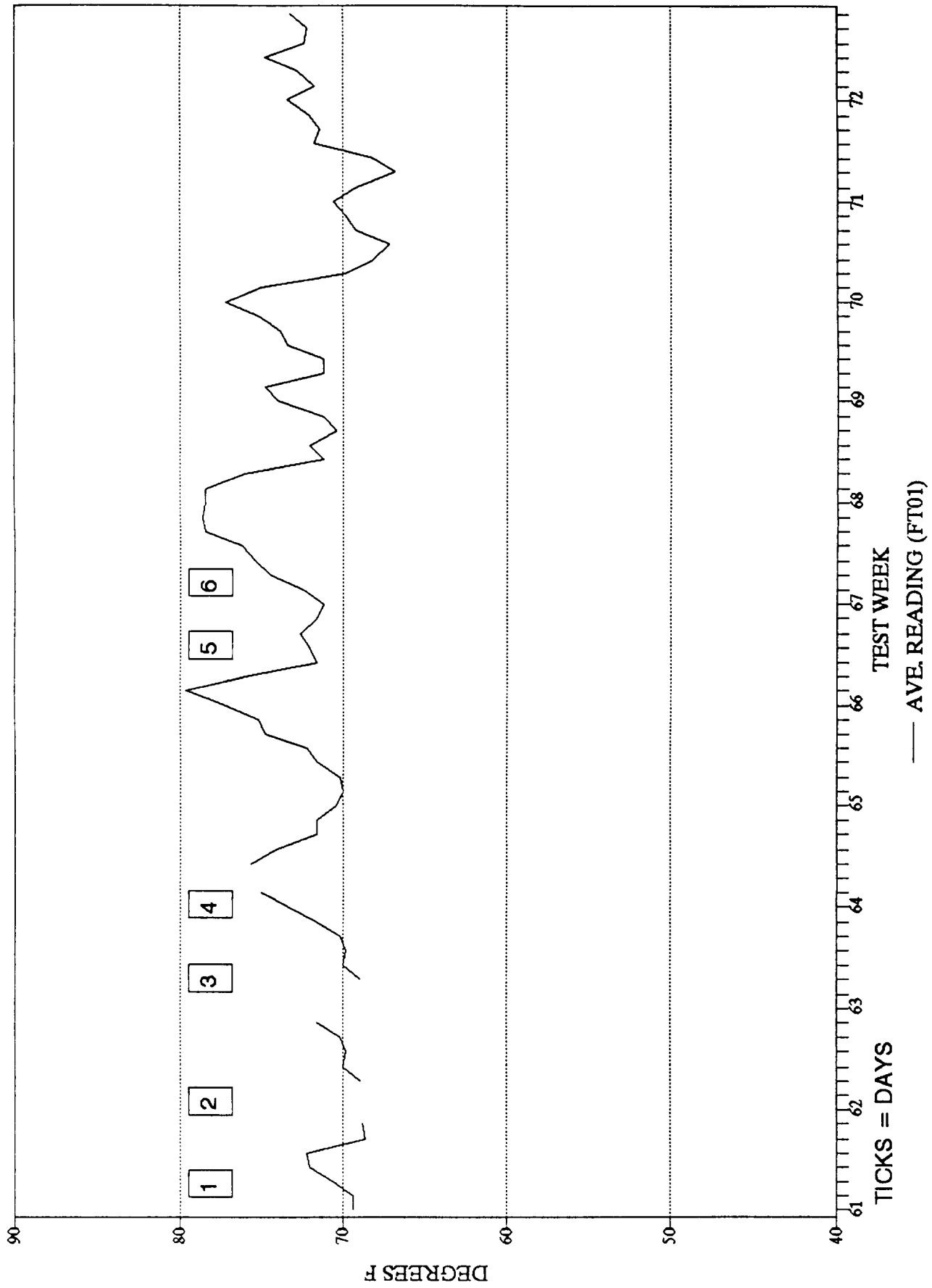

Figure 2.4-5 JT05: Post Oxidizer Temperature



**Figure 2.4-6 FT01: High Bay Temperature**

### 2.4.1 Performance (Weeks 61-72)

The TCCS HTOC has performed well to date (through week 72 of testing). There have been no subassembly anomalies. Methane removal efficiencies for this report period range between 98.22 and 102.60 percent (**Figure 2.4.1-1**) based on calculations from in-line CO<sub>2</sub> monitoring. Results for this period are not based on methane analyses due to a temporary loss of laboratory support (expired contract).

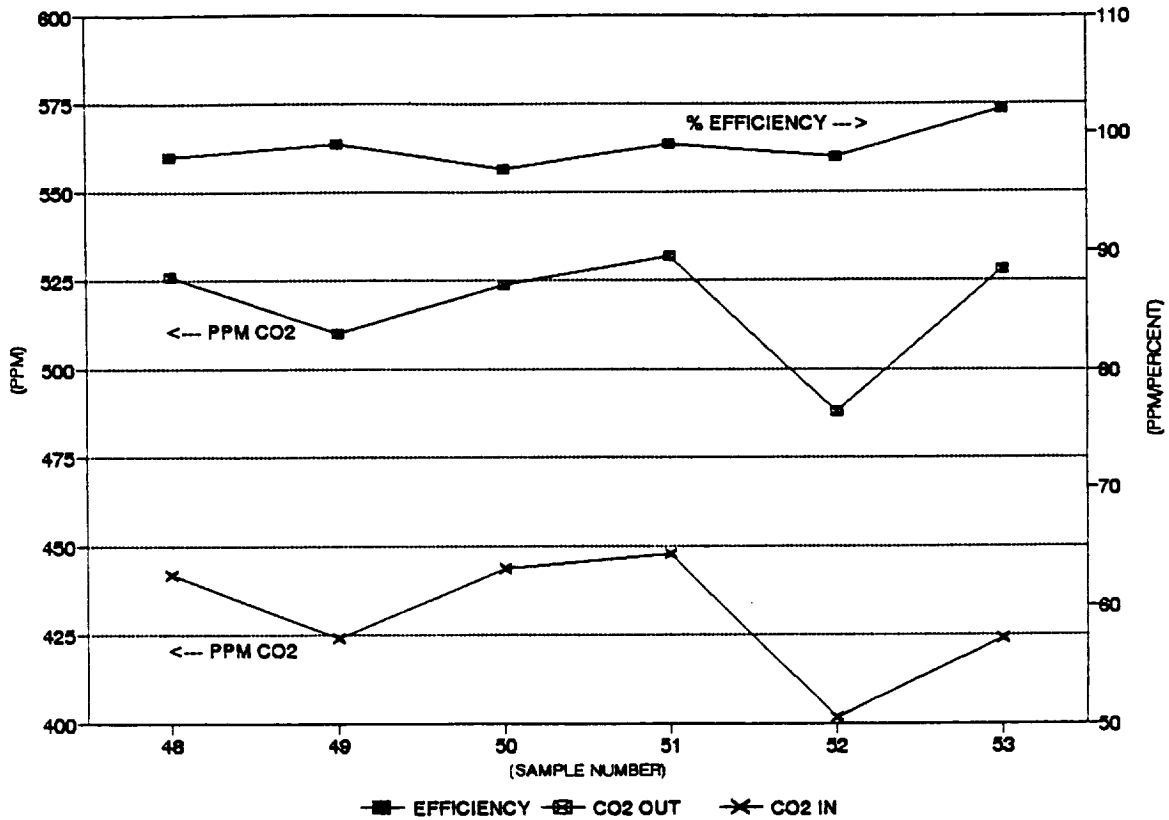

Figure 2.4.1-1 Oxidation Efficiency (61 - 72 Summary)

## 2.5 Test Weeks 73 - 86

The TCCS performed well during the report period with no anomalies. There were 9 shutdowns between test weeks 73 and 86 (inclusive), but none were flight-like. A summary follows:

1. (Friday, 4/1/94, Approximately 1800) - A facility power outage caused the TCCS to shutdown. The subassembly was brought back on-line on 4/4/94.
2. (Friday, 4/8/94, Approximately 1700) - The LabView software stopped functioning for unknown reasons. The program was restarted on 4/11/94.
3. (Tuesday, 6/7/94, 0607) - The TCCS was placed into an orderly shutdown to accommodate a scheduled power outage. The subassembly was restarted on 6/8/94.
4. (Wednesday, 6/22/94, 1403) - A thunderstorm caused a facility power outage resulting in a TCCS shutdown. The subassembly was immediately brought back on-line.
5. (Saturday, 6/25/94, 1300) - A thunderstorm caused a facility power outage resulting in a TCCS shutdown. The subassembly was brought back on-line on 6/27/94.
6. (Monday, 6/27/94, 0735) - The subassembly was inadvertently shut down during the warm-up process (following the 6/25/94 shutdown), when the low leg flow was adjusted to below the minimum allowable of 2 scfm. The subassembly was immediately brought back on-line.
7. (Wednesday, 6/29/94, 0633) - A facility power outage caused a TCCS shutdown. The subassembly was brought back on-line on 4/4/94.
8. (Wednesday, 6/29/94, 0837) - A thunderstorm caused a facility power outage resulting in a TCCS shutdown. The subassembly was immediately brought back on-line.
9. (Saturday, 7/2/94, Approximately 1200) - The TCCS shut down due to a facility power outage. The subassembly was brought back on-line on 7/5/94.

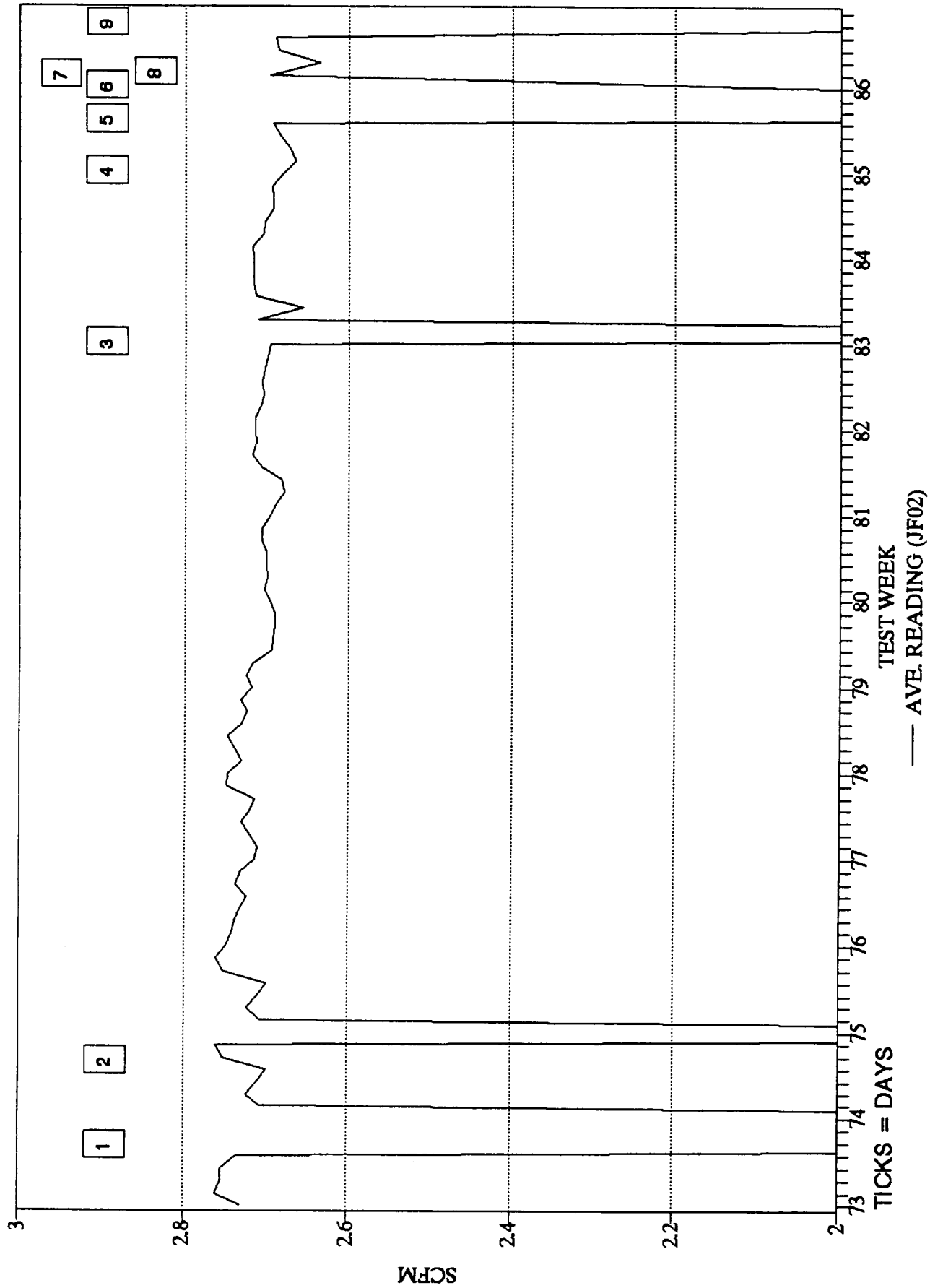

Figure 2.5-1 JF02: Oxidizer Low Leg Flow Rate



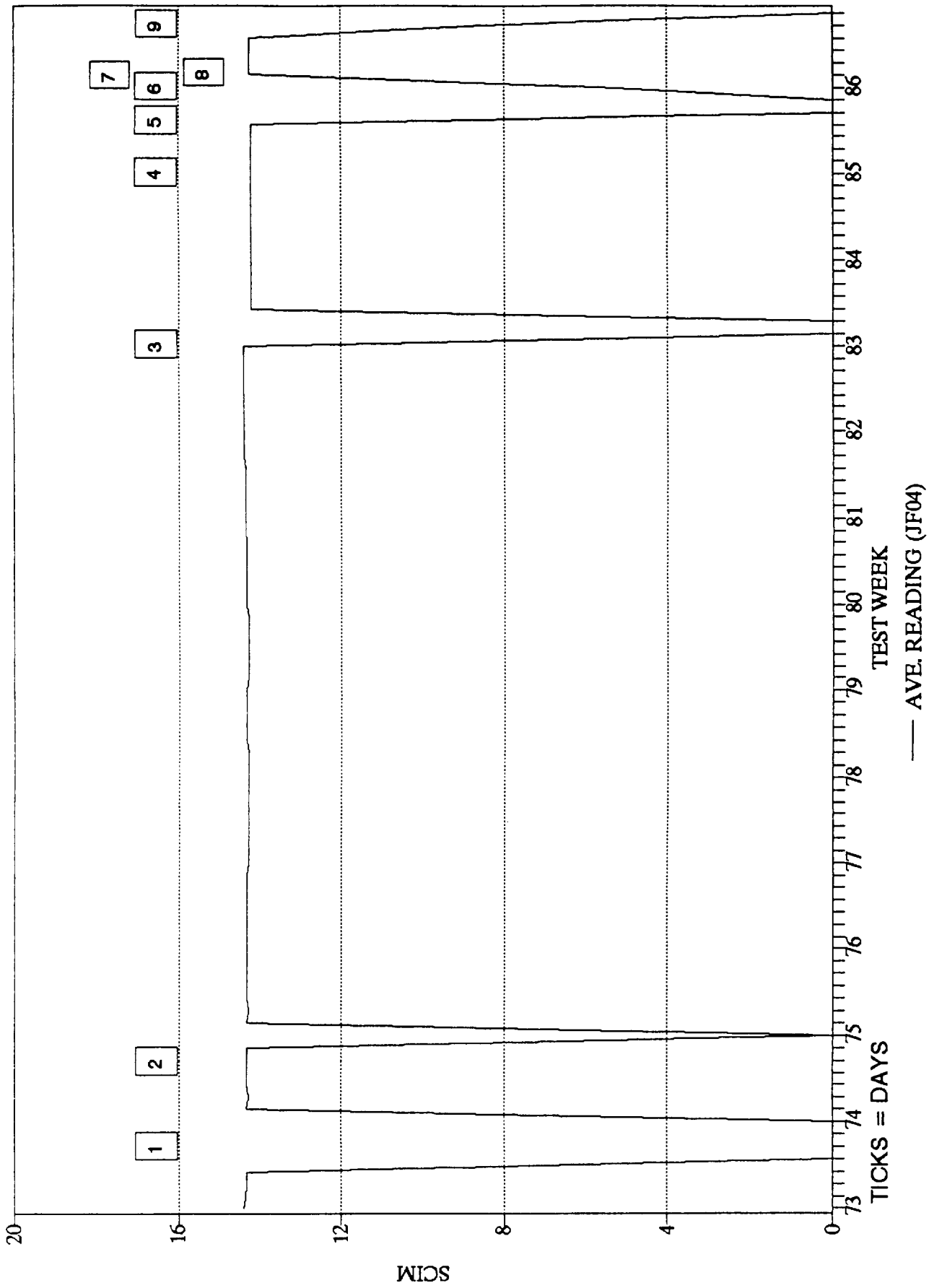

Figure 2.5-2 JF04: Methane Bleed Rate

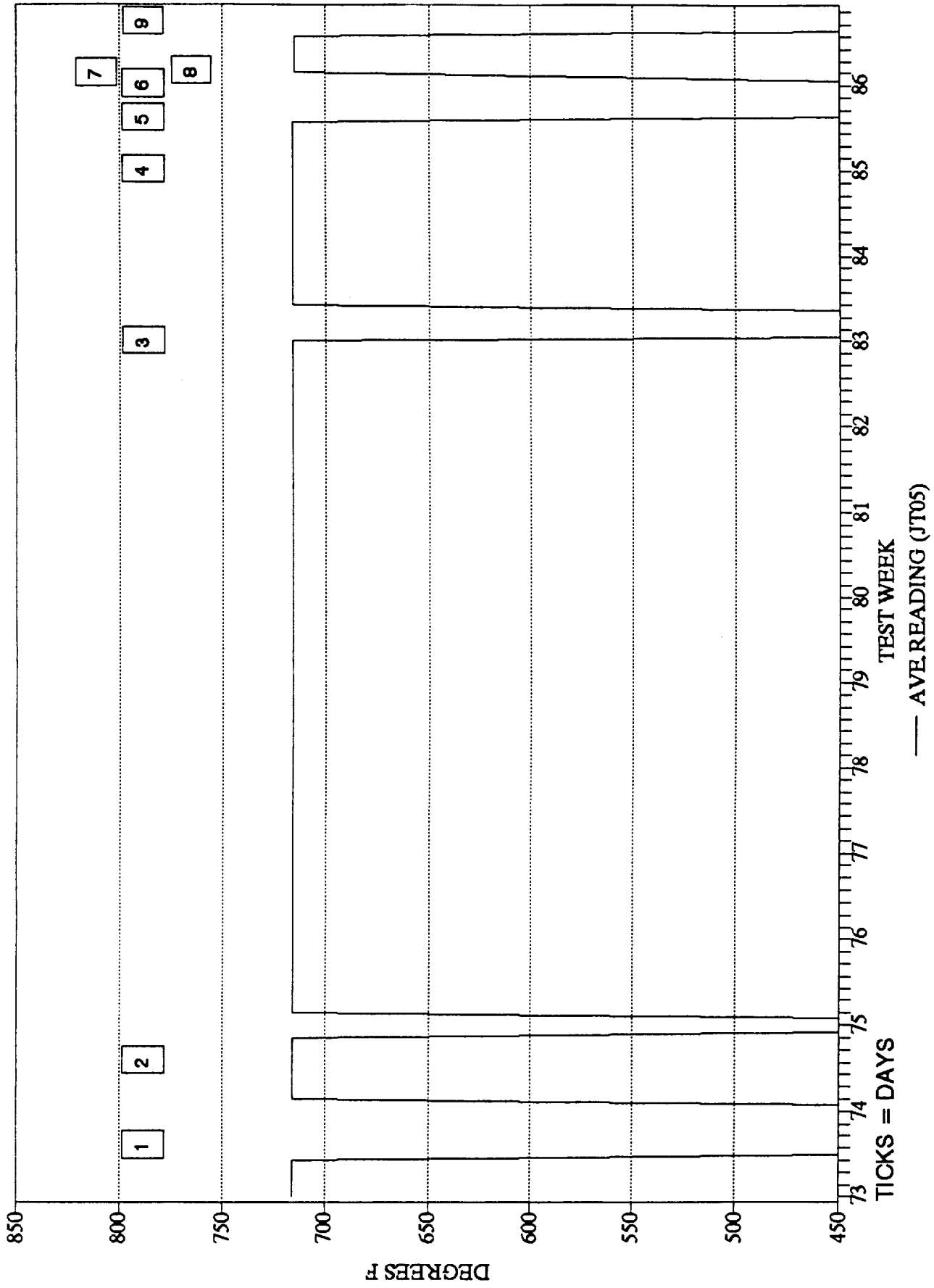

Figure 2.5-3 JT03: Pre Oxidizer Temperature

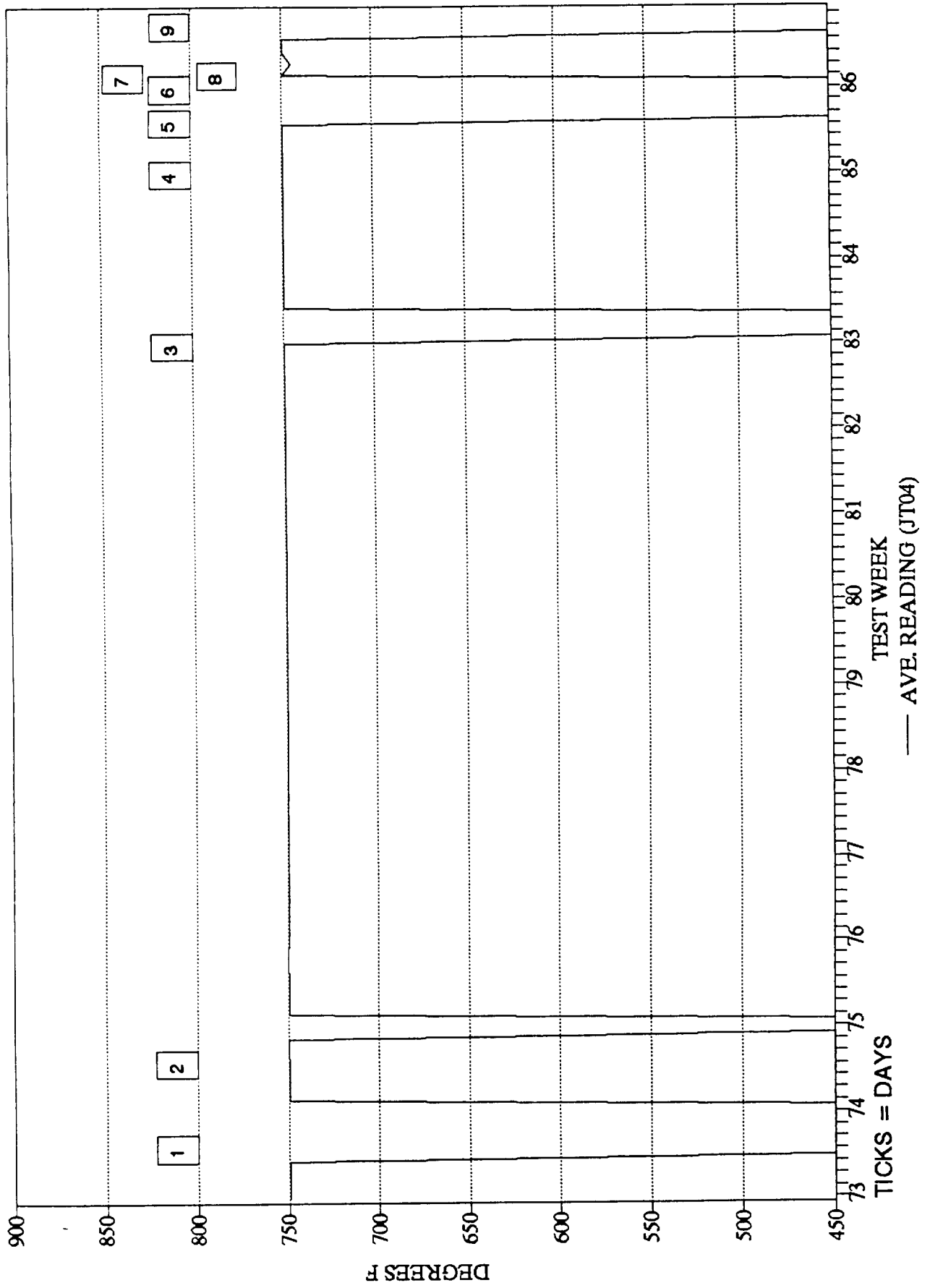

Figure 2.5-4 JT04: Catalytic Oxidizer Temperature

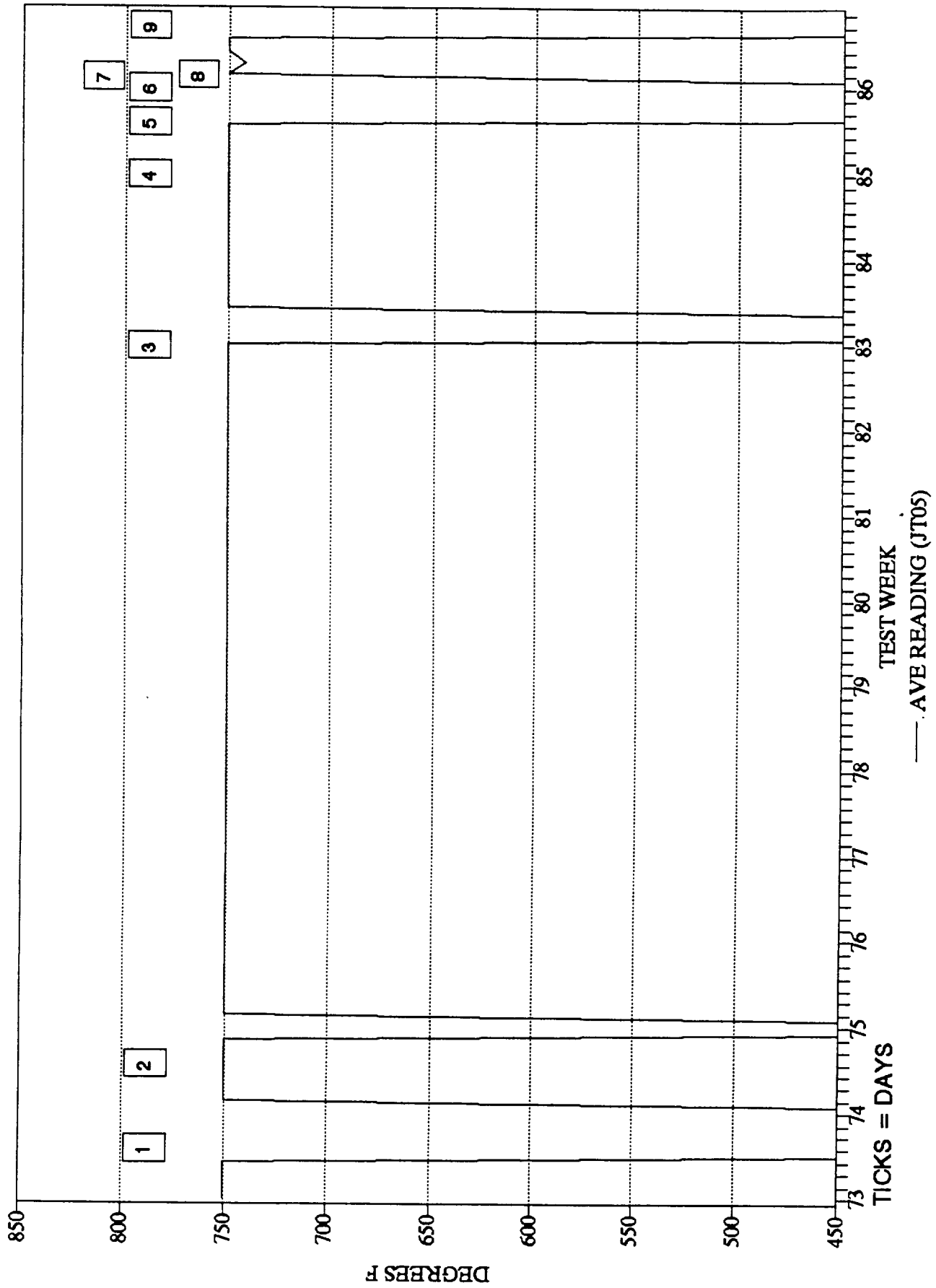

Figure 2.5-5 JT05: Post Oxidizer Temperature

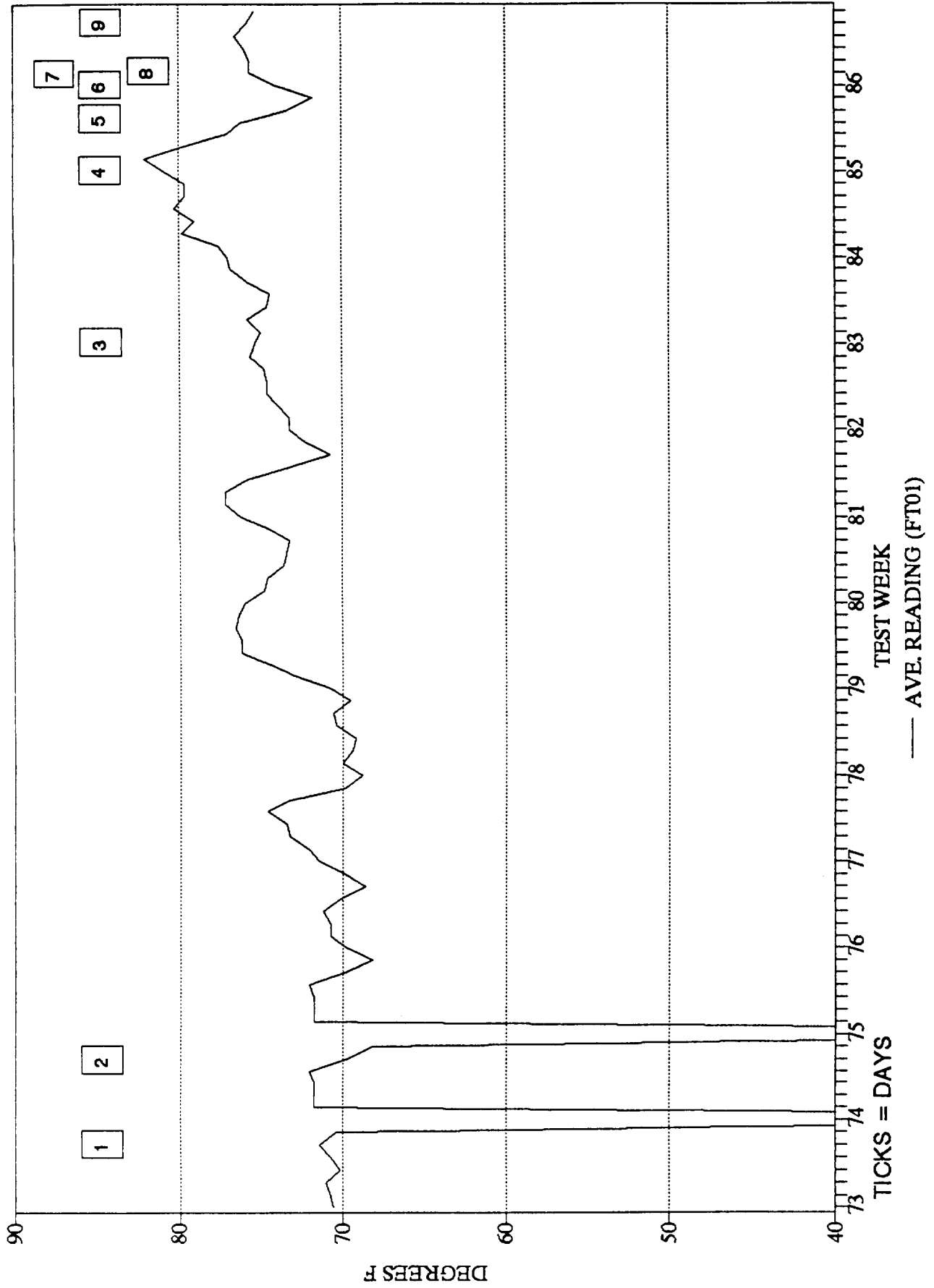

Figure 2.5-6 FT01: High Bay Temperature

### 2.5.1 Performance (Weeks 73 - 86)

The TCCS HTCO has performed well to date (through test week 86). There were no subassembly anomalies. Methane removal efficiencies for this report period range between 95.64 and 103.00 percent (Figure 2.5.1-1) based on calculations from in-line CO<sub>2</sub> monitoring.

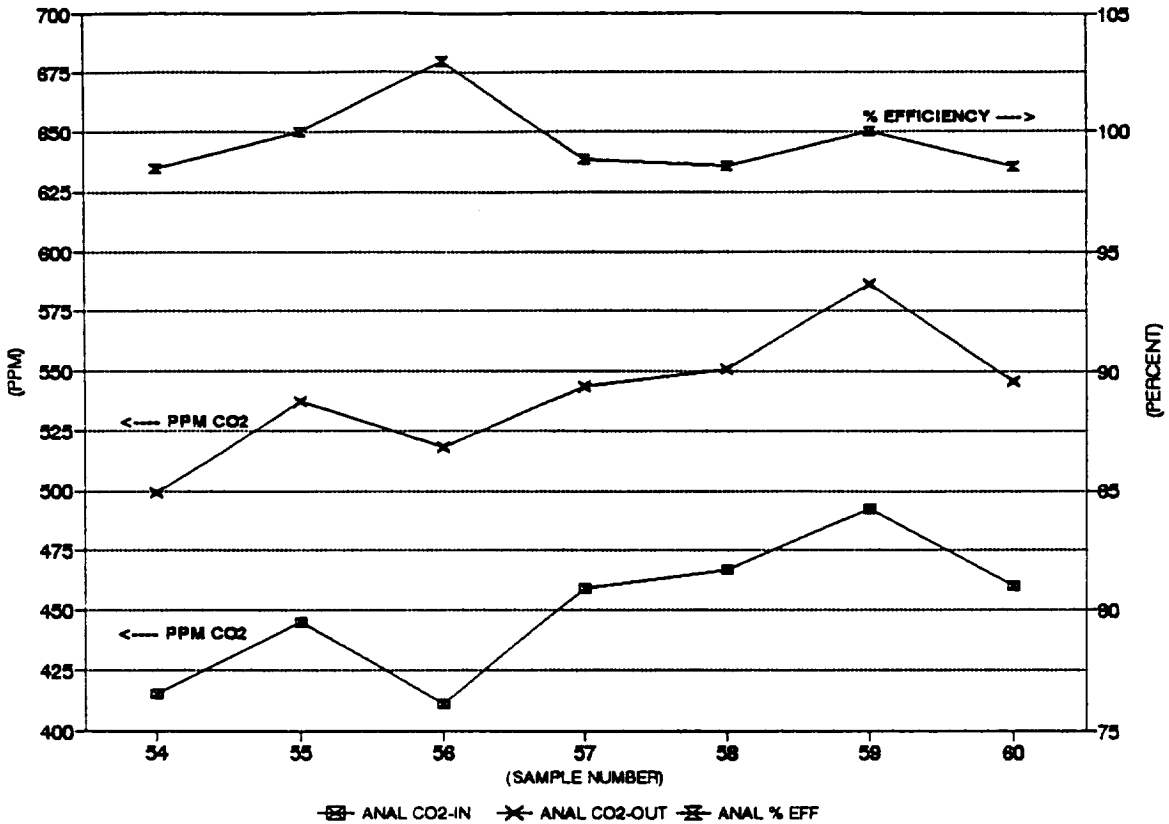

Figure 2.5.1-1 Oxidation Efficiency (73 - 86 Summary)

## 2.6 Test Weeks 86 - 99

The TCCS performed well during the report period with no anomalies. There were 8 shutdowns between test weeks 86 and 99 (inclusive), but none were flight-like. A summary follows:

1. (Monday, 6/25/94, Approximately 1300) - A facility power outage caused the TCCS to shut down during the weekend. On 6/27/94, at approximately 0732, the subassembly was brought back on-line.
2. (Monday, 6/27/94, Approximately 0733) - The subassembly shut down due to a mis-adjustment of the low leg flow rate (JF02). On 6/27/94, at approximately 0735, the subassembly was brought back on-line.
3. (Wednesday, 6/29/94, 0633) - A facility power outage caused the TCCS to shut down. The subassembly was brought back on-line on 6/29/94 at approximately 0645.
4. (Wednesday, 6/29/94, 0837) - A thunderstorm caused a facility power outage resulting in a TCCS shutdown. The subassembly was immediately brought back on-line.
5. (Saturday, 7/2/94, Approximately 1200) - The TCCS was shut down due to a facility power outage. The subassembly was brought back on-line at approximately 0600 on 7/5/94.
6. (Thursday, 8/25/94, 1159) - The TCCS shut down due to a facility power outage. The subassembly was brought back on-line at approximately 1600 the same day.
7. (Friday, 8/26/94, 0750) - The TCCS shut down due to a facility power outage. The subassembly was brought back on-line at approximately 1600 the same day.
8. (Friday, 9/9/94, 1305) - The TCCS shut down for unknown reasons. Evidence suggests the computer was inadvertently re-booted during an inspection. The subassembly was brought back on-line at 1328.

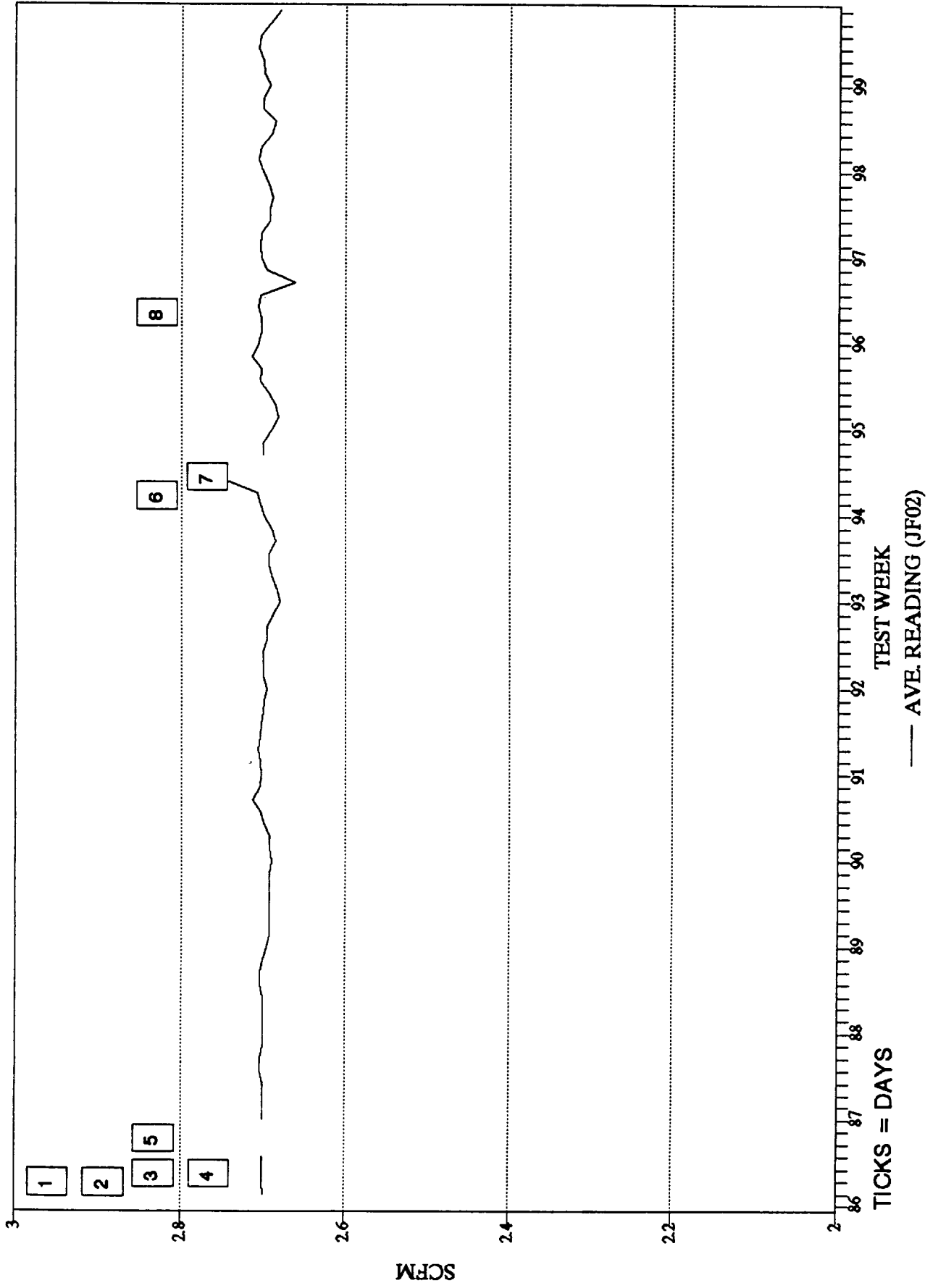

Figure 2.6-1 JF02: Oxidizer Low Leg Flow Rate



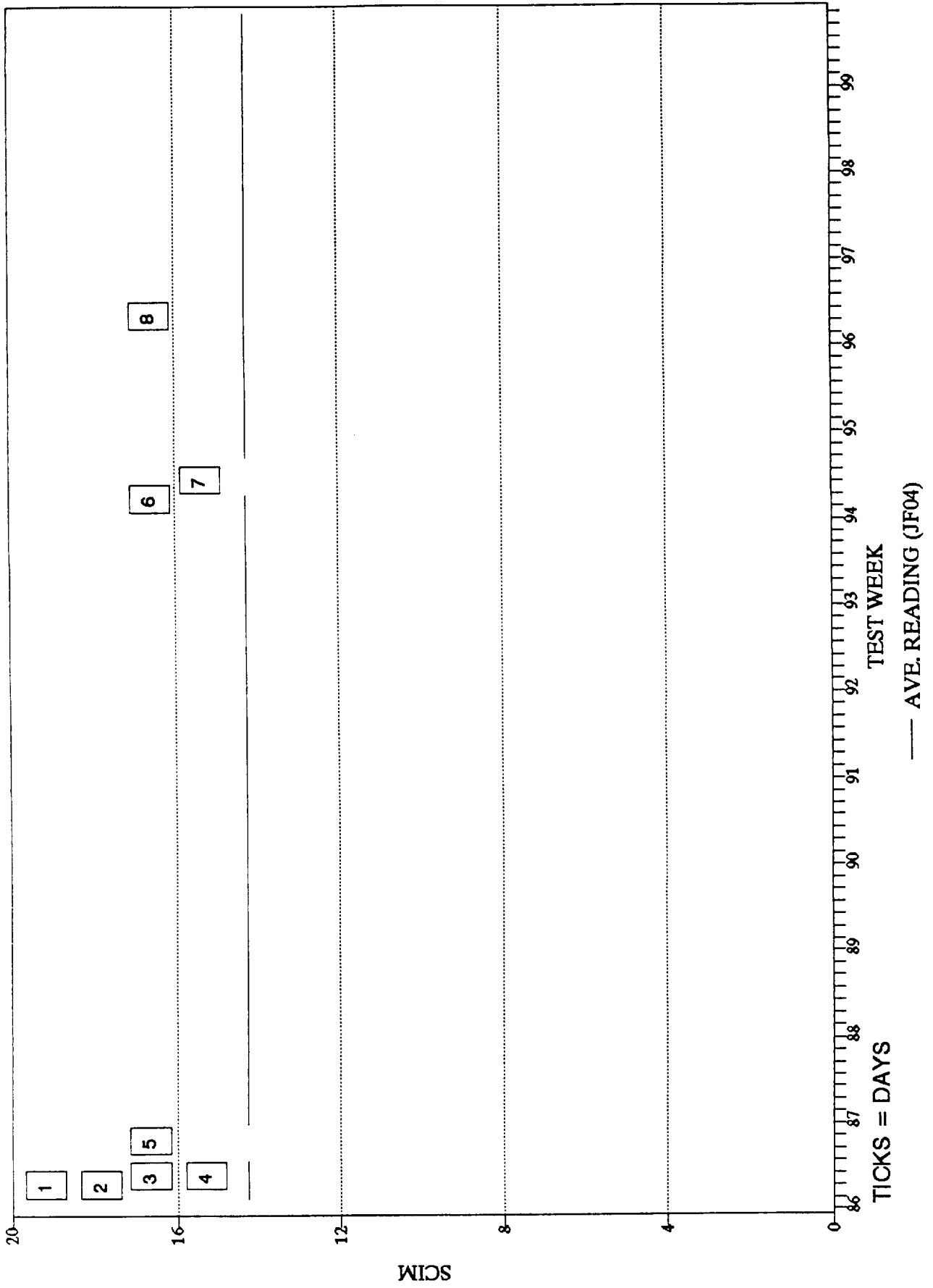

Figure 2.6-2 JF04: Methane Bleed Rate

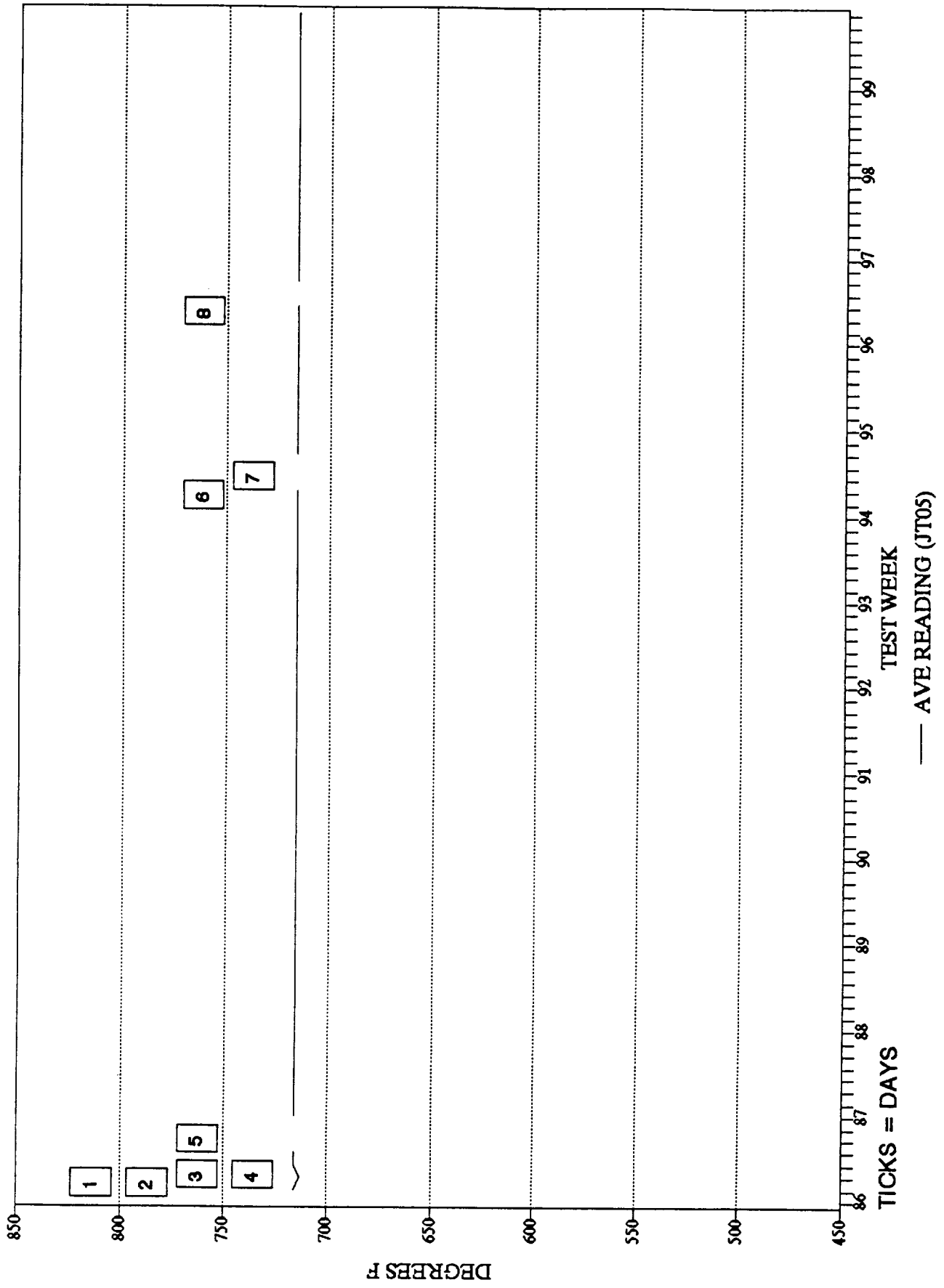

Figure 2.6-3 JT03: Pre Oxidizer Temperature

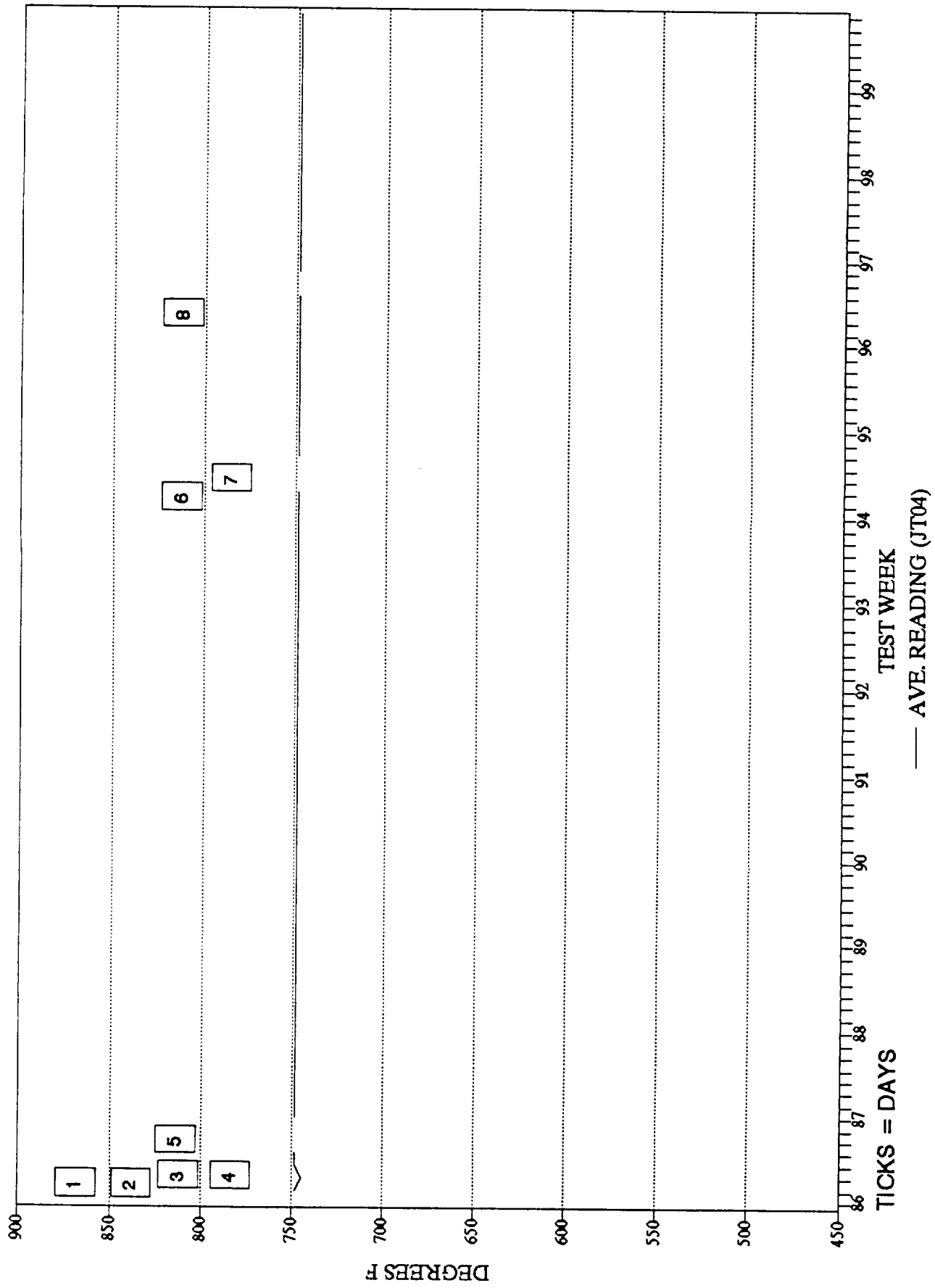

Figure 2.6-4 JT04: Catalytic Oxidizer Temperature

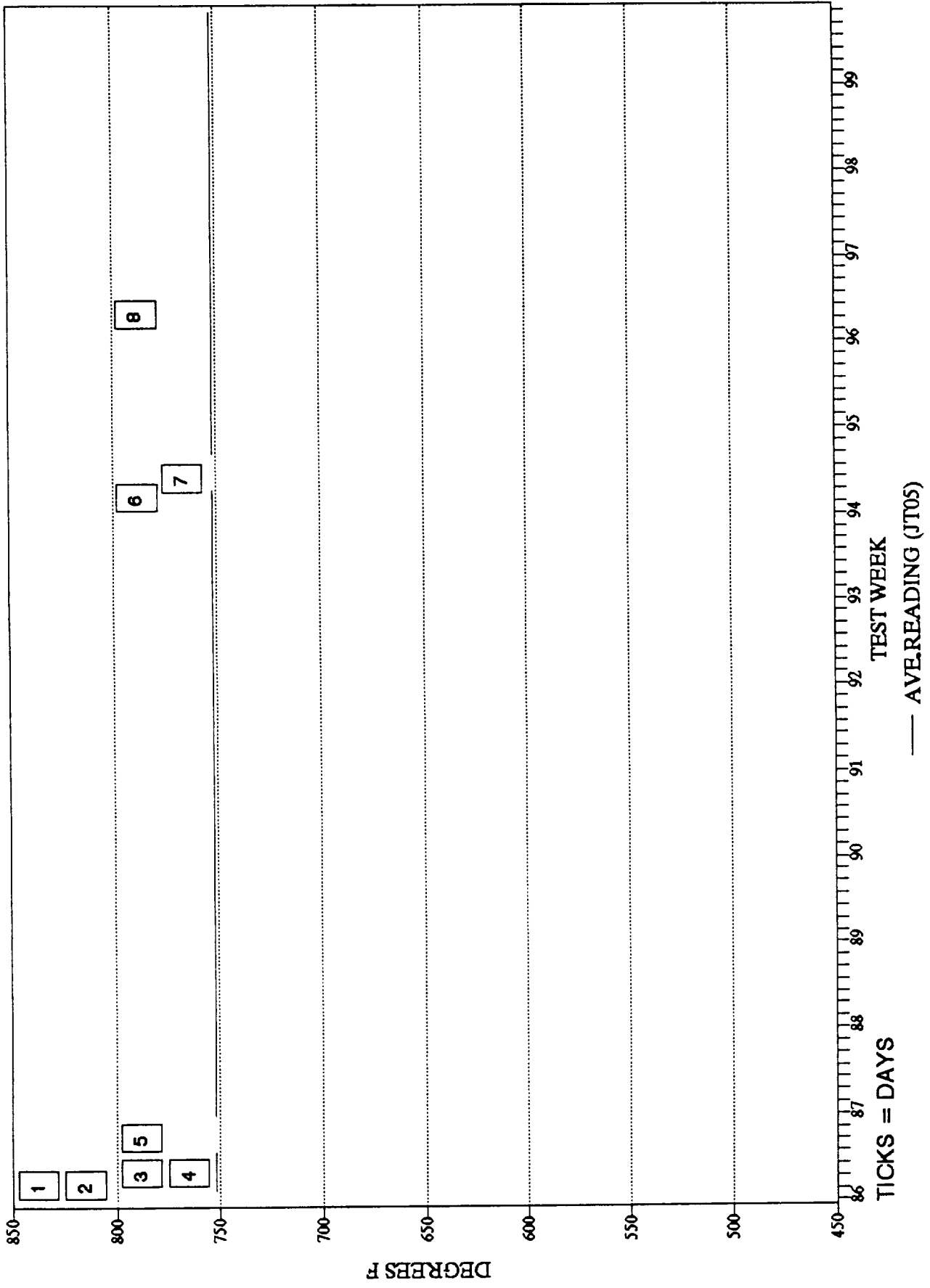
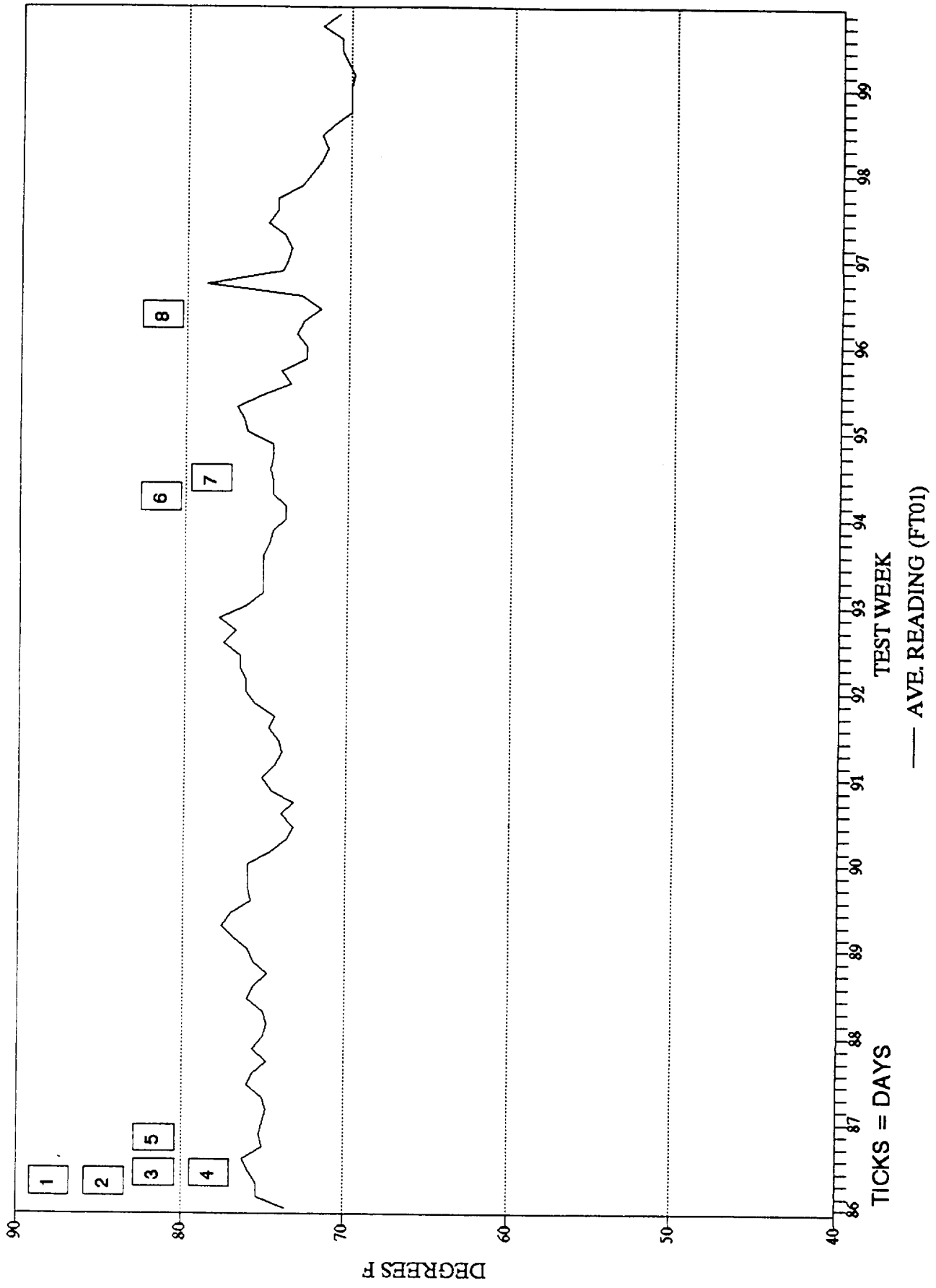

Figure 2.6-5 JT05: Post Oxidizer Temperature



**Figure 2.6-6 FT01: High Bay Temperature**

### 2.6.1 Performance (Weeks 86 - 99)

The TCCS HTCO performed well during this period with no subassembly anomalies. Methane removal efficiencies range between 90.0 and 99.4 percent (Figure 2.6.1-1) based on calculations from laboratory methane analyses.

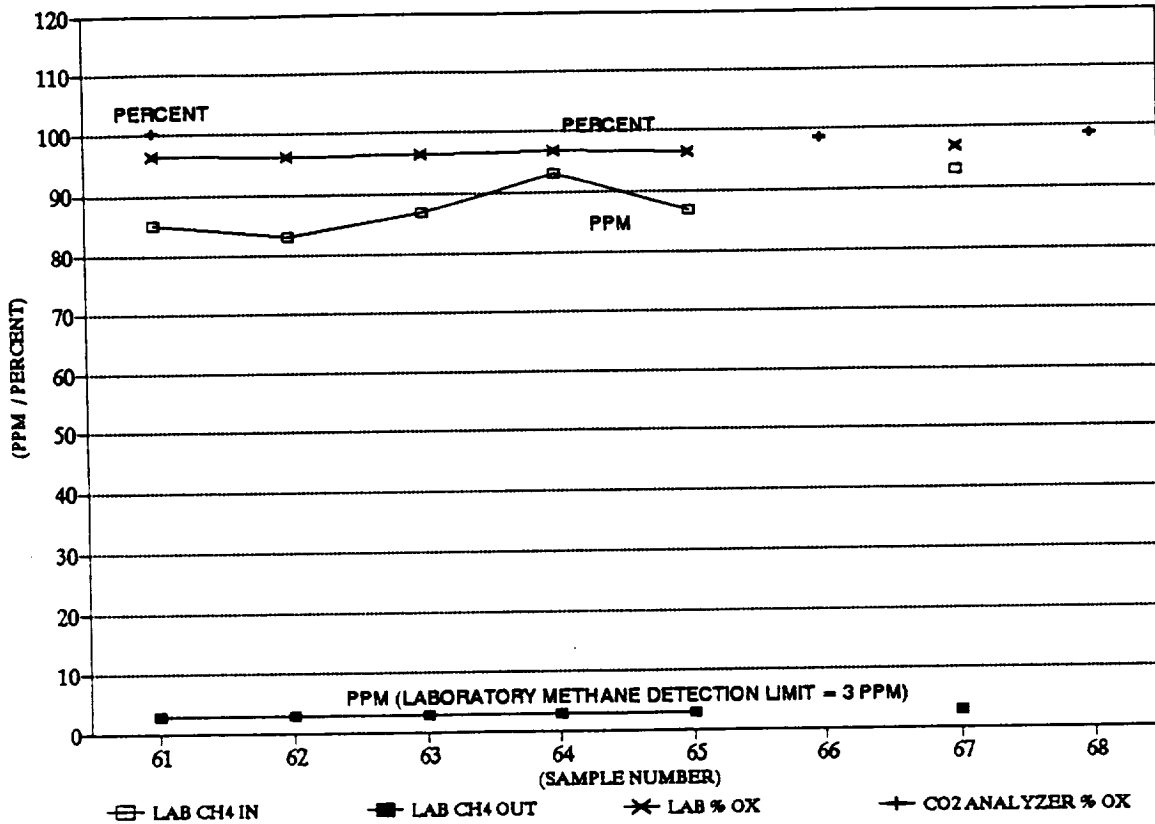

Figure 2.6.1-1 Oxidation Efficiency (86 - 99 Summary)

## **2.7 Test Weeks 100 - 114**

The TCCS performed well during the report period with no anomalies. There were two shutdowns between test weeks 100 and 114 (inclusive), but none were flight-like. A summary follows:

1. (Friday, 10/14/94, 1100) - The TCCS shut down due to a facility power outage. The subassembly was brought back on-line at approximately 1900.
2. (Saturday, 12/3/94, 1030) - The TCCS shut down due to a facility power outage. The subassembly was brought back on-line at approximately 1200.

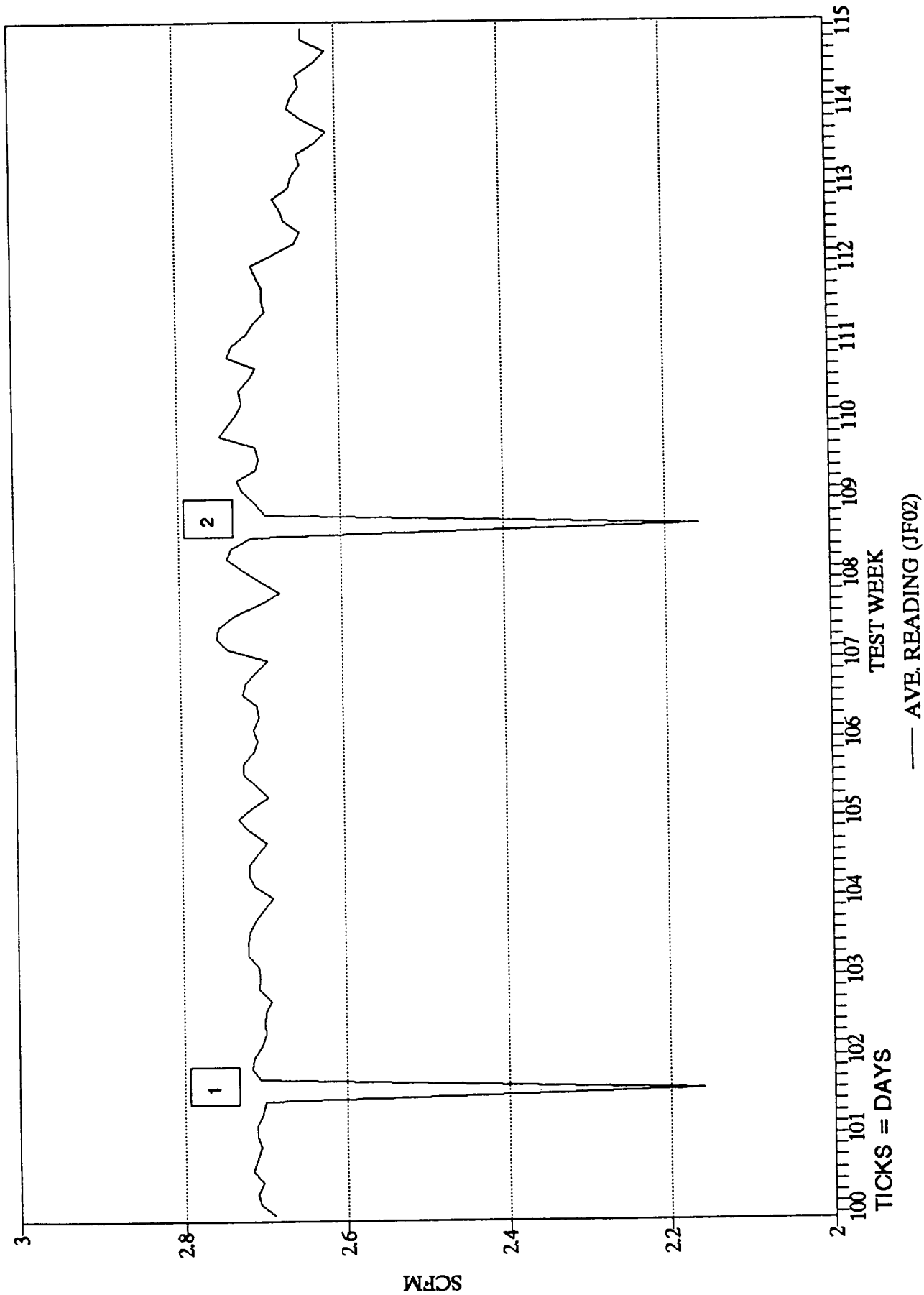

Figure 2.7-1 JF02: Oxidizer Low Leg Flow Rate



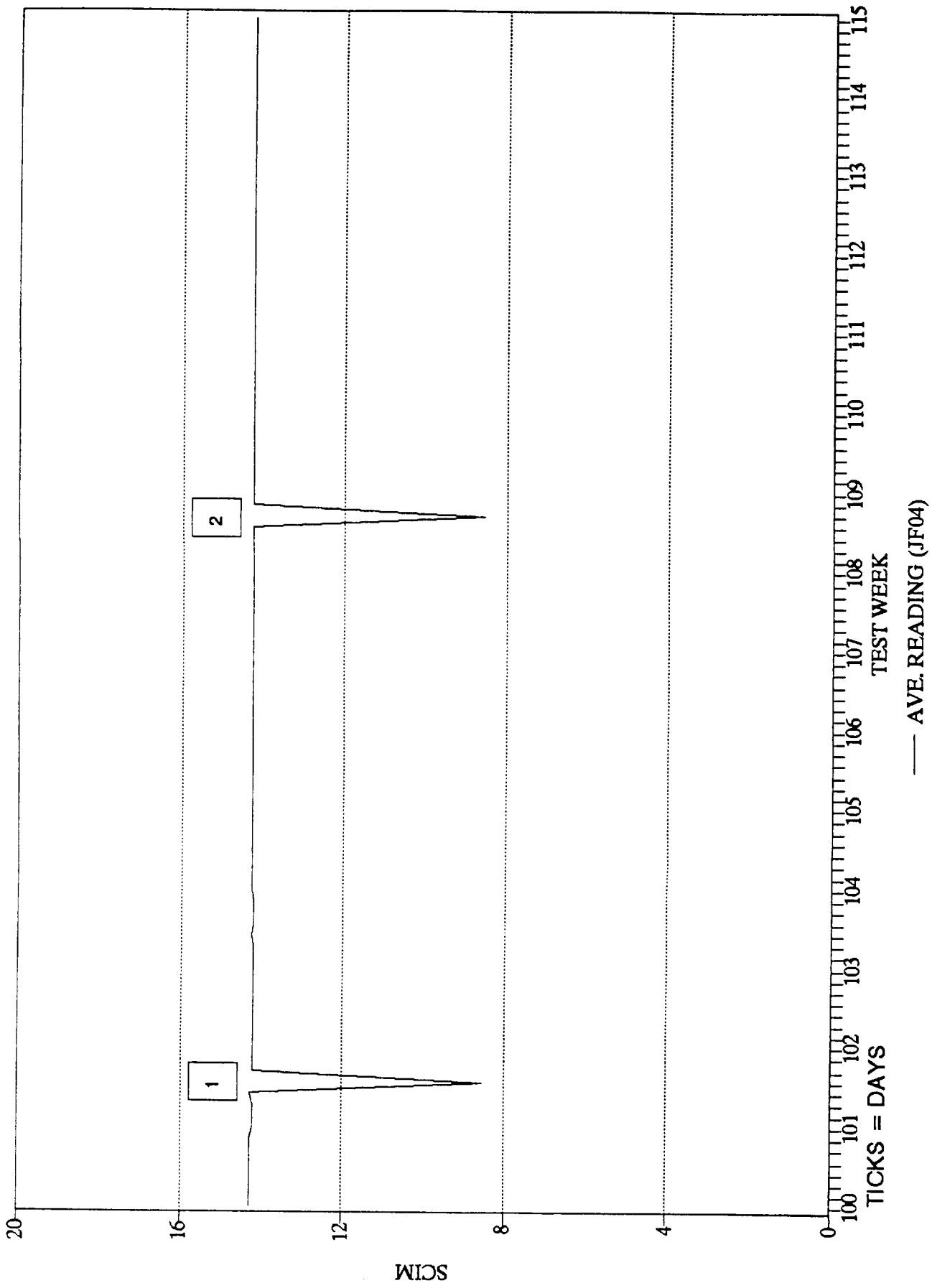

Figure 2.7-2 JF04: Methane Bleed Rate

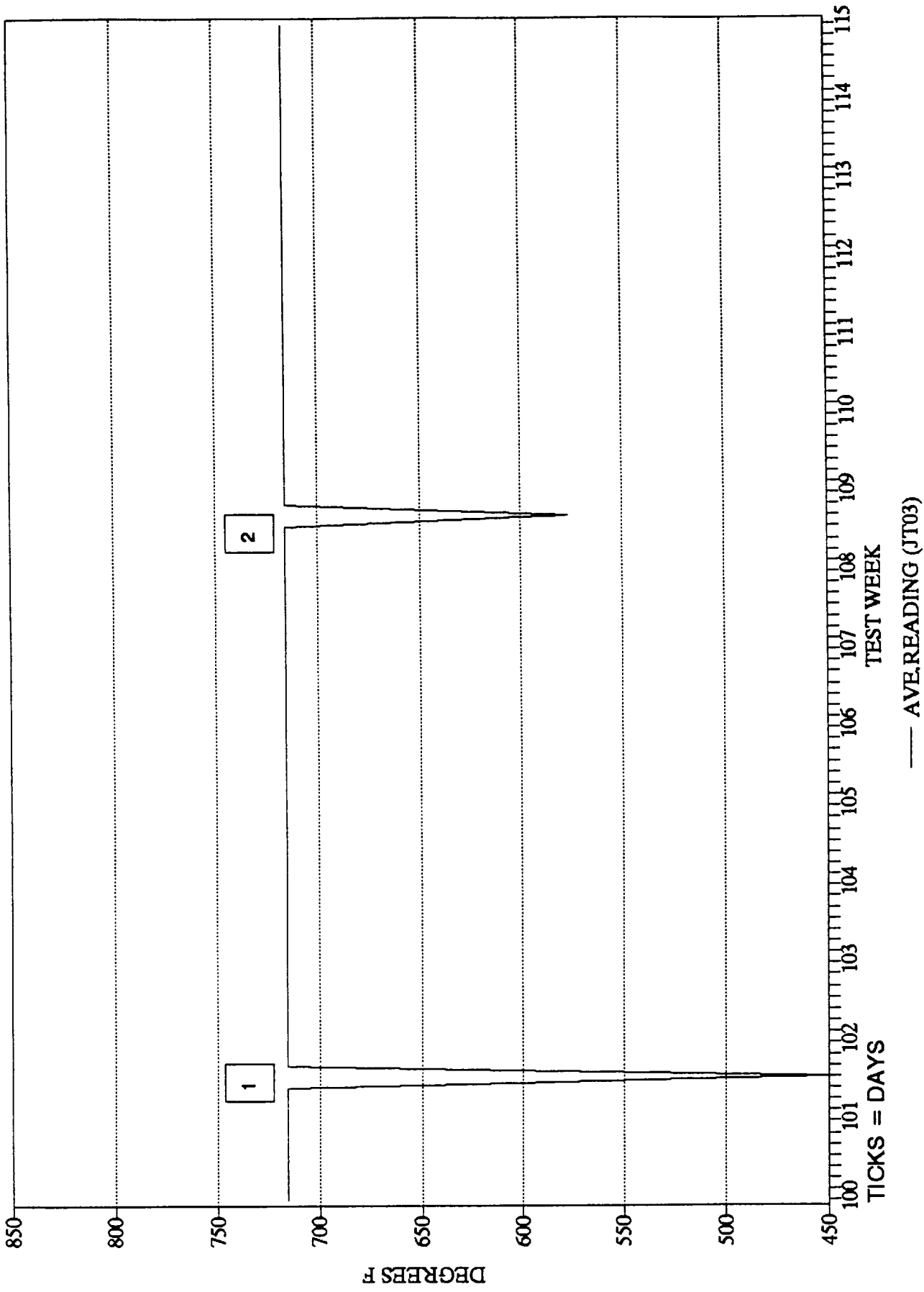
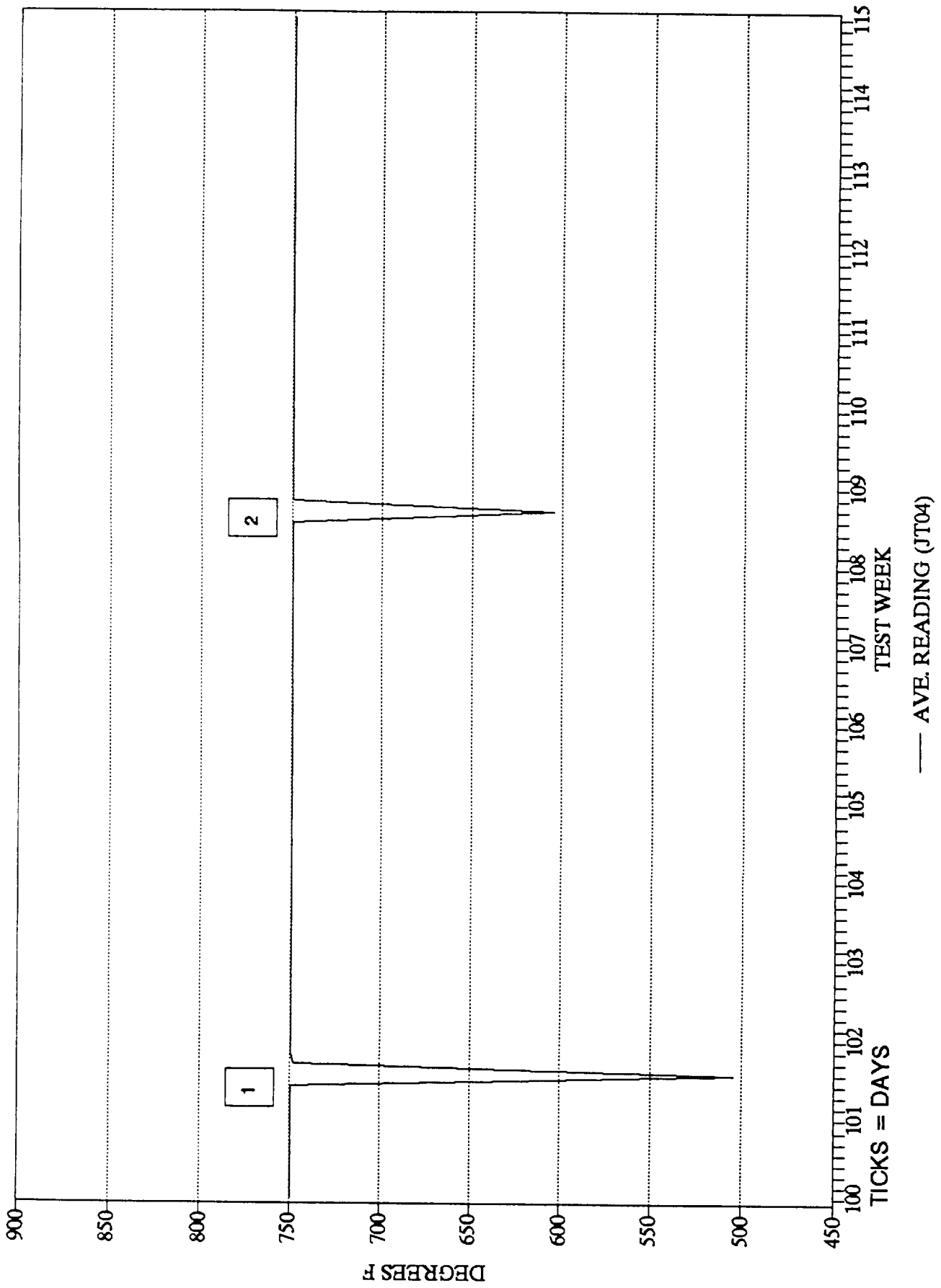

Figure 2.7-3 JT03: Post Oxidizer Temperature



**Figure 2.7-4 JT04: Catalytic Oxidizer Temperature**

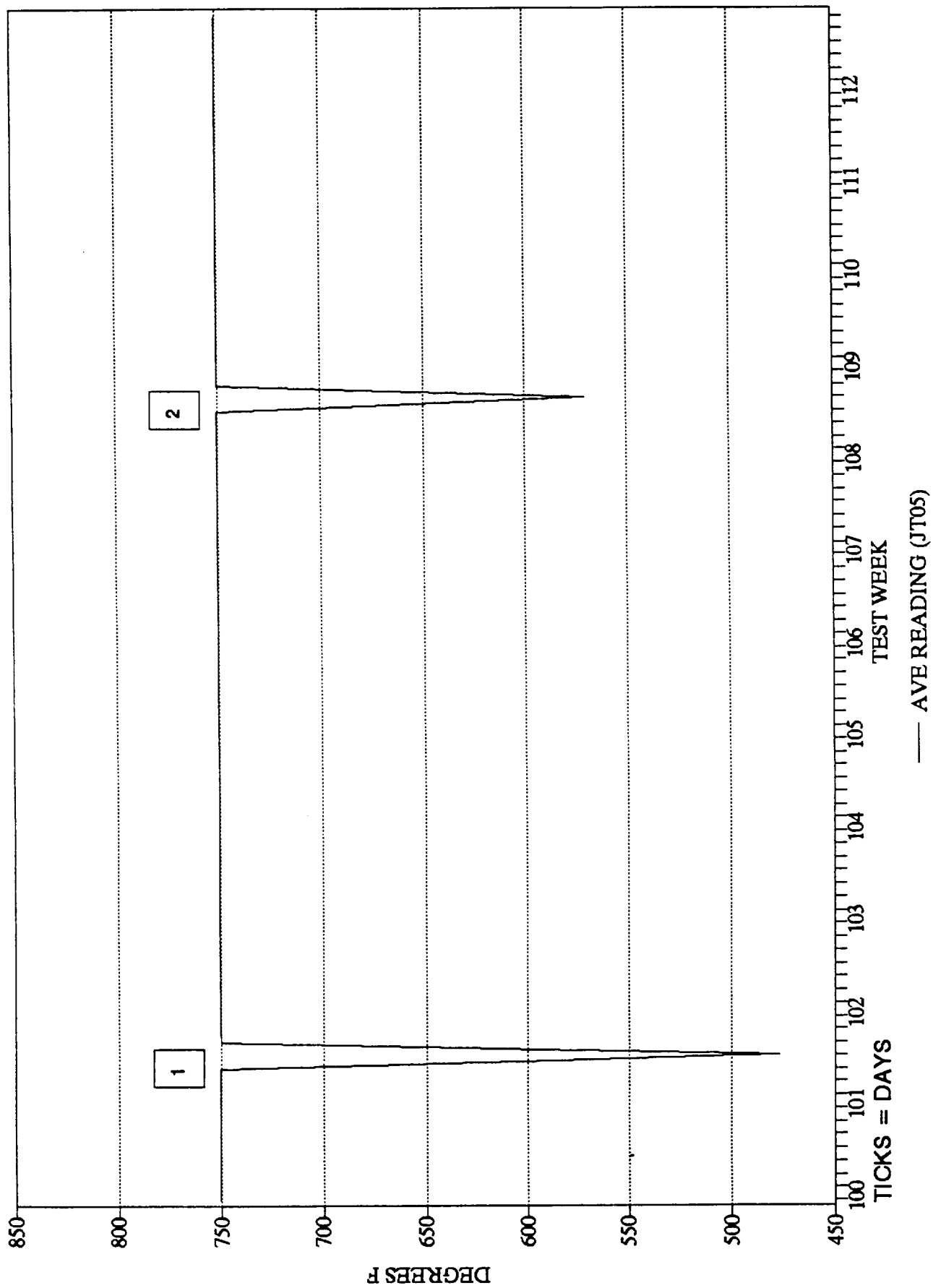
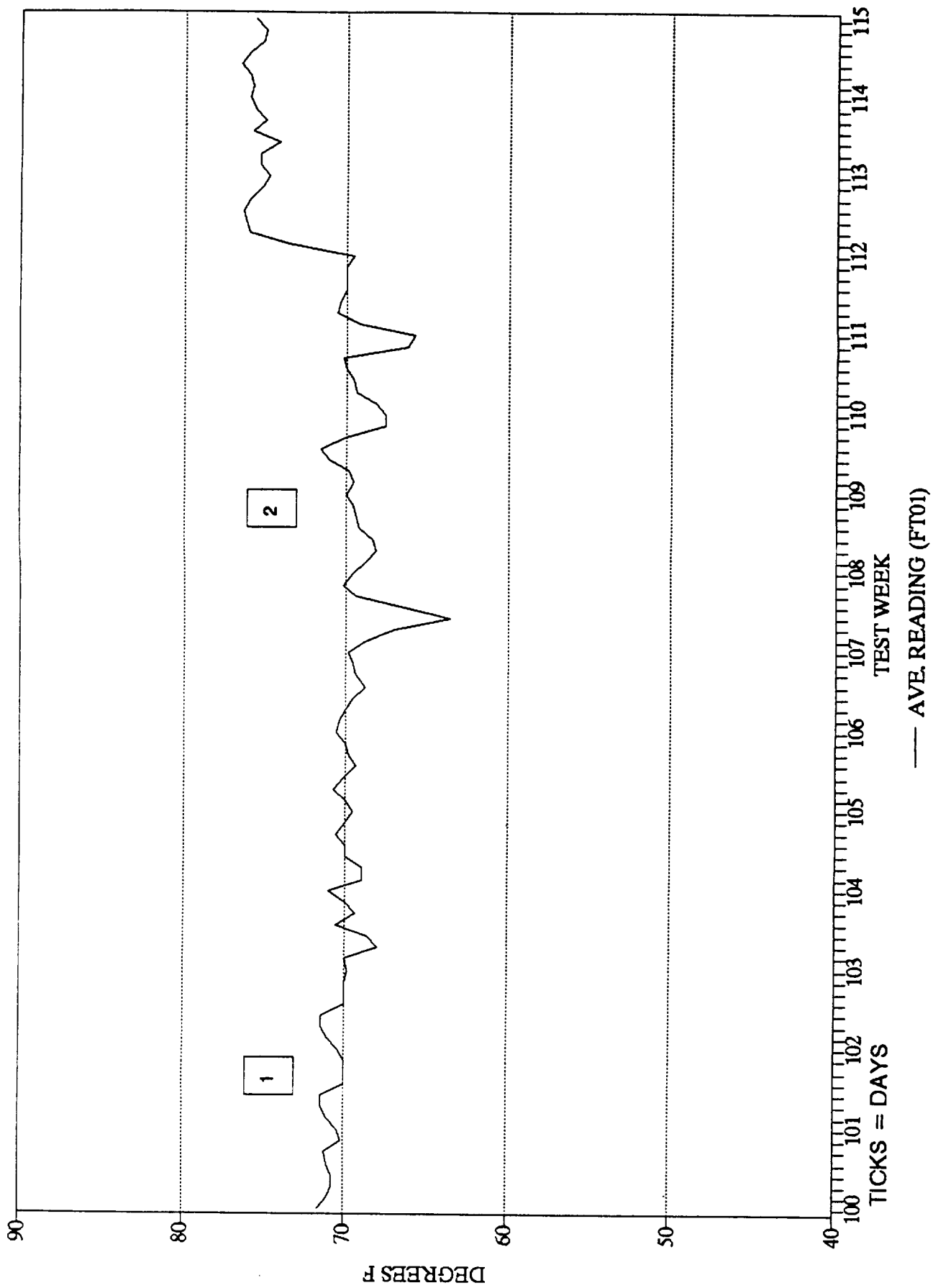

Figure 2.7-5 JT05: Post Oxidizer Temperature



**Figure 2.7-6 FT01: High Bay Temperature**

### 2.7.1 Performance (Weeks 100 - 114)

The TCCS HTO has performed well during the period with no anomalies. Methane removal efficiencies, for this report period, are reflected in **Figure 2.7.1-1**. The results are based on calculations from in-line CO<sub>2</sub> monitoring and laboratory methane analyses.

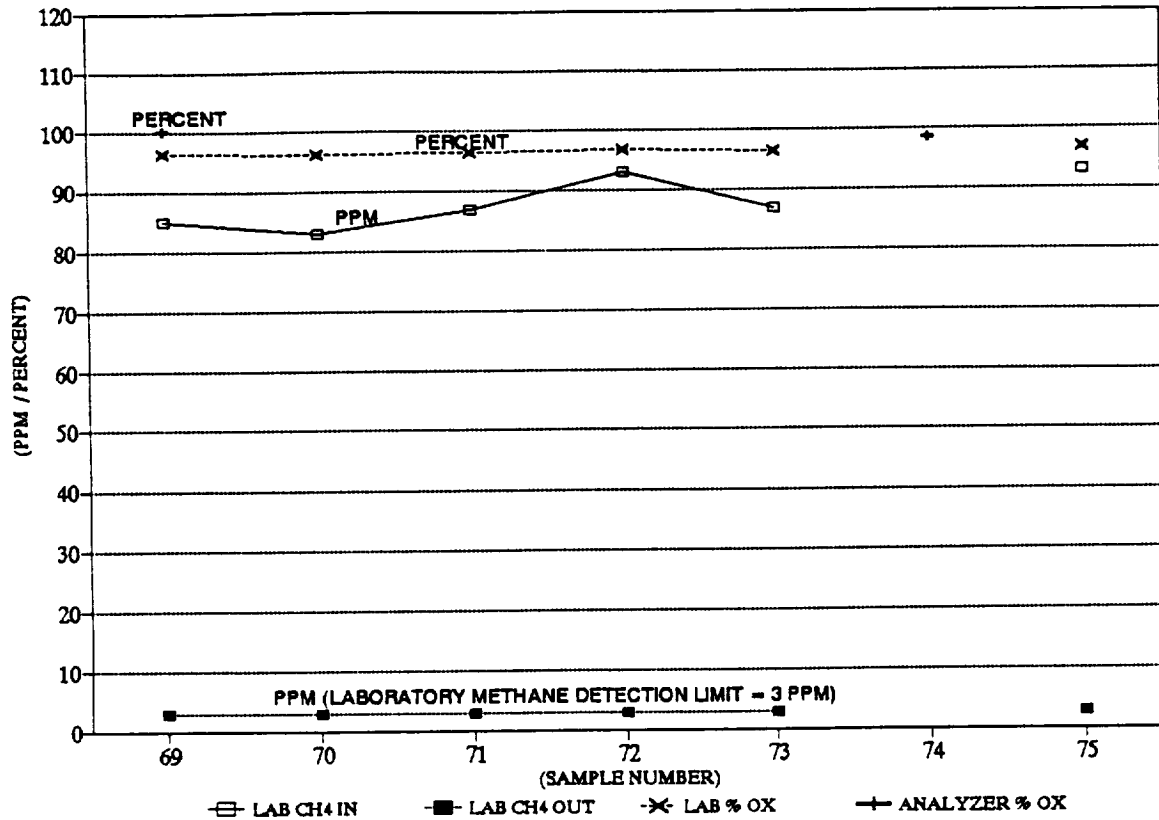

Figure 2.7.1-1 Oxidation Efficiency (100 - 114 Summary)

### 3.0 TEST CONCLUSIONS

**Figure 3.0-1** shows the overall oxidation efficiency of the HTCO catalyst since the beginning of the test. The graph is based on results gathered from the Boeing analytical laboratory. **Table 3.0-1** gives sample dates corresponding to the X-axis sample place holders. **Table 3.0-1** is specific to **Figure 3.0-1** and should not be used to define sample dates for any other figures found in this report. Data collected prior to April 18, 1994, is suspect, due to method error, and was not included in the graph (see **Section 2.0** for details, and **Section 2.1** for the removed data).

In the data presented, the catalyst's Oxidation Efficiency (calculated) is limited by the Method Detection Limit (MDL) for methane in air since:

$$\% \text{ Oxidation Efficiency} = \frac{(\text{Methane In}) - (\text{Methane Out}) \leftarrow \text{Restricted by MDL}}{\text{Methane In}} \times 100$$

Based on this equation, the higher the MDL, the lower the %Oxidation Efficiency. Were the MDL nearer zero, the %Oxidation Efficiency would be nearer 100% (assuming the actual "Methane Out" value is appreciably lower than the present detection limit of 3 ppm<sub>v</sub>).

**Figure 3.0-2** shows the overall oxidation efficiency of the HTCO catalyst since the beginning of the test. The graph is based on results gathered from the in-line CO<sub>2</sub> analyzer. **Table 3.0-2** gives sample dates corresponding to the X-axis sample place holders. **Table 3.0-2** is specific to **Figure 3.0-2** and should not be used to define sample dates for any other figures found in this report.

Life Testing of the TCCS has provided some very useful information. Above all, the test has shown that the HTCO catalyst life is much longer than previously estimated. While the ISSA logistics plan calls for catalyst replacement every 180 days, the Life Test has shown that, under non-poisoning conditions, the catalyst can remain effective in excess of two years. This represents tremendous cost savings in a program that is presently burdened with cost restrictions. In addition preliminary catalyst poisoning test results have shown that a poisoned catalyst of this type can recover to a usable extent with increased heat, and exposure to a nonpoisoning atmosphere. This study is ongoing, and final results will be published under separate cover.

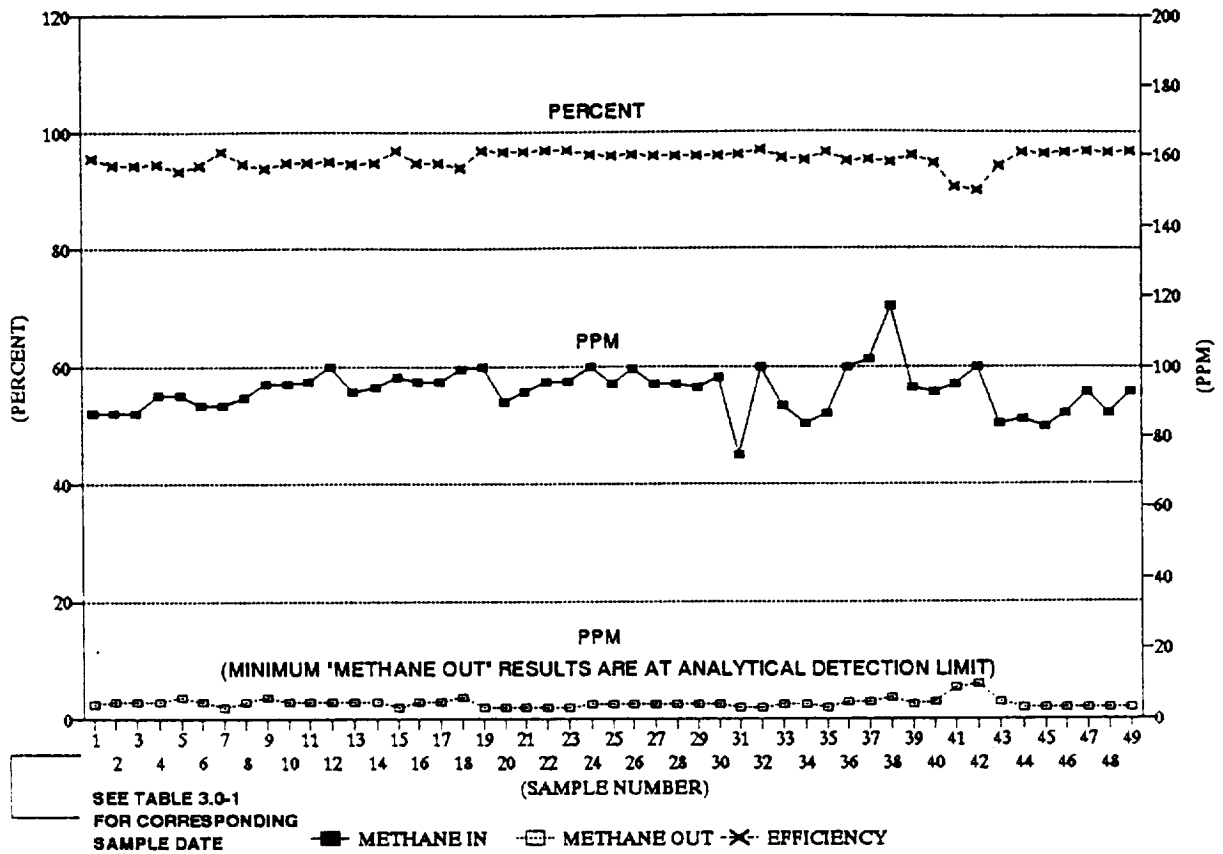
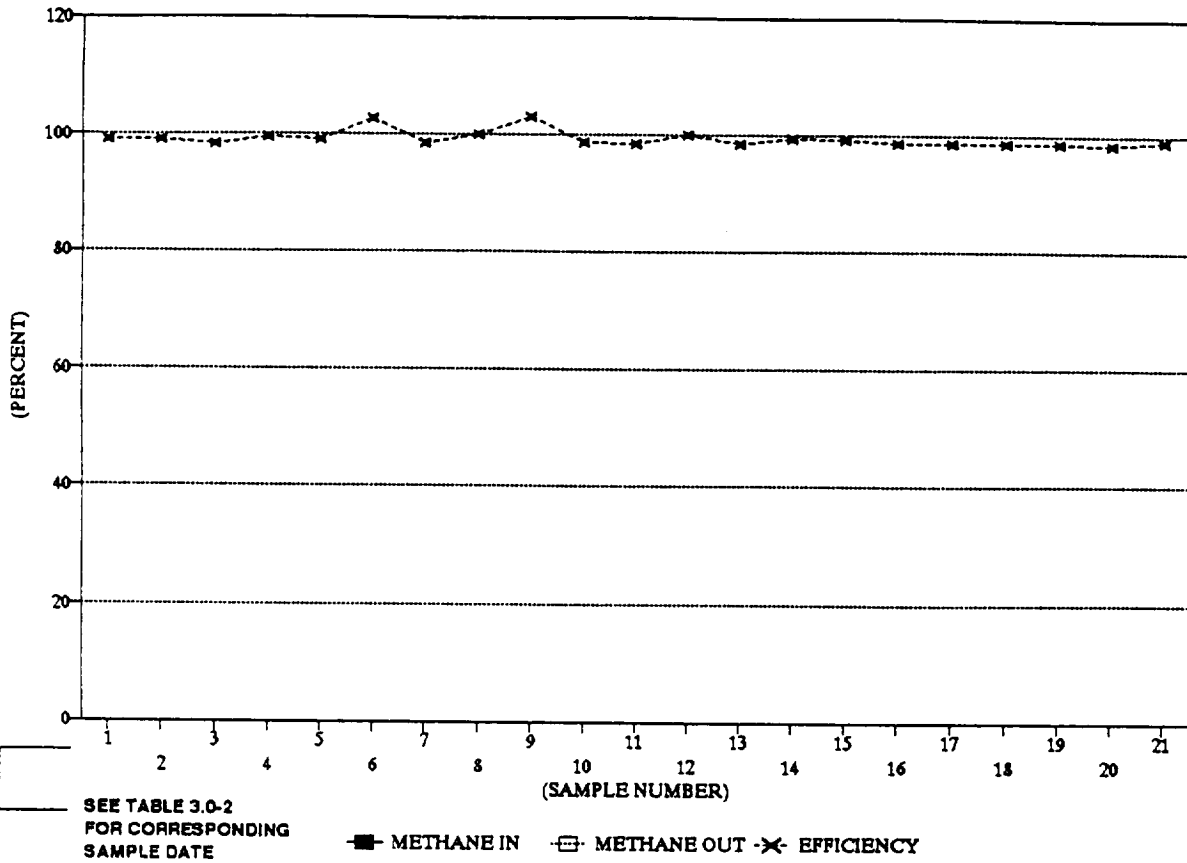

**Figure 3.0-1 Overall Oxidation Efficiency (Lab Analyses)**

**Table 3.0-1 Sample Numbers and Corresponding Dates**

SAMPLE NUMBER	SAMPLE DATE	SAMPLE NUMBER	SAMPLE DATE	SAMPLE NUMBER	SAMPLE DATE	SAMPLE NUMBER	SAMPLE DATE
1	4/18/94	14	5/18/94	27	7/8/94	40	9/6/94
2	4/20/94	15	5/23/94	28	7/11/94	41	9/15/94
3	4/22/94	16	5/27/94	29	7/13/94	42	9/20/94
4	4/25/94	17	6/1/94	30	7/15/94	43	9/27/94
5	4/27/94	18	6/3/94	31	7/18/94	44	10/4/94
6	4/29/94	19	6/6/94	32	7/20/94	45	10/11/94
7	5/2/94	20	6/10/94	33	7/22/94	46	10/18/94
8	5/4/94	21	6/13/94	34	7/25/94	47	10/31/94
9	5/6/94	22	6/15/94	35	8/1/94	48	11/7/94
10	5/9/94	23	6/17/94	36	8/8/94	49	1/12/95
11	5/11/94	24	6/22/94	37	8/15/94		
12	5/13/94	25	6/24/94	38	8/23/94		
13	5/16/94	26	6/29/94	39	8/30/94		





**Figure 3.0-2 Overall Oxidation Efficiency (In-line Analyzer)**

**Table 3.0-2 Sample Numbers and Corresponding Dates**

SAMPLE NUMBER	SAMPLE DATE	SAMPLE NUMBER	SAMPLE DATE	SAMPLE NUMBER	SAMPLE DATE
1	2/17/94	8	4/4/94	15	7/28/94
2	2/22/94	9	4/12/94	16	8/22/94
3	3/1/94	10	4/25/94	17	9/21/94
4	3/7/94	11	5/9/94	18	10/7/94
5	3/14/94	12	5/23/94	19	10/11/94
6	3/21/94	13	6/21/94	20	12/20/94
7	3/28/94	14	7/6/94	21	1/12/95

**APPROVAL**

**INTERNATIONAL SPACE STATION ALPHA  
TRACE CONTAMINANT CONTROL  
SUBASSEMBLY LIFE TEST  
FINAL REPORT**

Prepared by: J.D. Tatara and J.L. Perry

The information in this document has been reviewed for technical content. Review of any information concerning Department of Defense or nuclear energy activities or programs has been made by the MSFC Security Classification Officer. This document, in its entirety, has been determined to be unclassified.

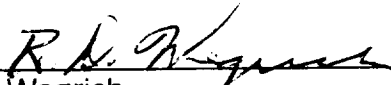
  
\_\_\_\_\_  
R.D. Wegrich  
Chief, Thermal and Life Support Division

3-29-95  
Date

  
\_\_\_\_\_  
J.C. Blair  
Director, Structures and Dynamics Laboratory

3-30-95  
Date

# REPORT DOCUMENTATION PAGE

*Form Approved*  
*OMB No. 0704-0188*

Public reporting burden for this collection of information is estimated to average 1 hour per response, including the time for reviewing instructions, searching existing data sources, gathering and maintaining the data needed, and completing and reviewing the collection of information. Send comments regarding this burden estimate or any other aspect of this collection of information, including suggestions for reducing this burden, to Washington Headquarters Services, Directorate for Information Operations and Reports, 1215 Jefferson Davis Highway, Suite 1204, Arlington, VA 22202-4302, and to the Office of Management and Budget, Paperwork Reduction Project (0704-0188), Washington, DC 20503.

1. AGENCY USE ONLY (Leave blank)		2. REPORT DATE <p style="text-align: center;">March 1995</p>		3. REPORT TYPE AND DATES COVERED <p style="text-align: center;">Technical Memorandum</p>	
4. TITLE AND SUBTITLE <p style="text-align: center;">International Space Station Alpha Trace Contaminant Control Subassembly Life Test Final Report</p>				5. FUNDING NUMBERS	
6. AUTHOR(S) <p style="text-align: center;">J.D. Tatará* and J.L. Perry</p>					
7. PERFORMING ORGANIZATION NAME(S) AND ADDRESS(ES) <p style="text-align: center;">George C. Marshall Space Flight Center Marshall Space Flight Center, Alabama 35812</p>				8. PERFORMING ORGANIZATION REPORT NUMBER	
9. SPONSORING/MONITORING AGENCY NAME(S) AND ADDRESS(ES) <p style="text-align: center;">National Aeronautics and Space Administration Washington, D.C. 20546</p>				10. SPONSORING/MONITORING AGENCY REPORT NUMBER <p style="text-align: center;">NASA TM - 108488</p>	
11. SUPPLEMENTARY NOTES <p style="text-align: center;">Prepared by Structures and Dynamics Laboratory, Science and Engineering Directorate *ION Electronics, Huntsville, AL</p>					
12a. DISTRIBUTION/AVAILABILITY STATEMENT <p style="text-align: center;">Unclassified - Unlimited</p>				12b. DISTRIBUTION CODE	
13. ABSTRACT (Maximum 200 words) <p>The Environmental Control and Life Support System (ECLSS) Life Test Program (ELTP) began with Trace Contaminant Control Subassembly (TCCS) Life Testing on November 9, 1992, at 0745. The purpose of the test, as stated in the NASA document <i>Requirements for Trace Contaminant Control Subassembly High Temperature Catalytic Oxidizer Life Testing (Revision A)</i>, was to "provide for the long duration operation of the ECLSS TCCS [High Temperature Catalytic Oxidizer] HTCO at normal operating conditions... [and thus]... to determine the useful life of ECLSS hardware for use on long duration manned space missions." Specifically, the test was designed to demonstrate thermal stability of the HTCO catalyst. The report details TCCS stability throughout the test. Graphs are included to aid in evaluating trends and subsystem anomalies. The report summarizes activities through the final day of testing, January 17, 1995 (Test Day 762).</p>					
14. SUBJECT TERMS <p style="text-align: center;">Life Test, ECLSS, Trace Contaminant Control, TCCS, Environmental Control, Catalyst, Catalytic Oxidizer, Space Station</p>				15. NUMBER OF PAGES <p style="text-align: center;">71</p>	
				16. PRICE CODE <p style="text-align: center;">NTIS</p>	
17. SECURITY CLASSIFICATION OF REPORT <p style="text-align: center;">Unclassified</p>	18. SECURITY CLASSIFICATION OF THIS PAGE <p style="text-align: center;">Unclassified</p>	19. SECURITY CLASSIFICATION OF ABSTRACT <p style="text-align: center;">Unclassified</p>	20. LIMITATION OF ABSTRACT <p style="text-align: center;">Unlimited</p>		

