

**IMPACT OF COMPOSITES  
ON FUTURE TRANSPORT AIRCRAFT**

Robert H. Kinder  
Douglas Aircraft Company

51-24  
~~51-24~~

**Direct Operating Cost Objective**

In the current environment, new technology must be cost-effective in addition to improving operability. Various approaches have been used to determine the "hurdle" or "breakthrough" return that must be achieved to gain customer commitment for a new product or aircraft, or in this case, a new application of the technology. These approaches include return-on-investment, payback period, and addition to net worth. An easily understood figure-of-merit and one used by our airline customers is improvement in direct operating cost per seat-mile. Any new technology must buy its way onto the aircraft through reduction in direct operating cost (DOC).

# *Impact Measured by Aircraft Direct Operating Cost*

## Direct Operating Cost Trends

Advanced technology has played a vital role in the continual productivity improvement of transport aircraft over the past 40 years. Speed, propulsion, aerodynamics, and capacity have contributed to a continual decrease in DOC in each decade. With the introduction of the jet engine, improvement was achieved through increased speed. In the 1970s, wide-body aircraft offered dramatic increases in capacity and fuel efficiency. Over the past two decades, direct operating cost reductions have largely been the result of reduced fuel consumption derived from lower weight, reduced engine SFC, and aircraft drag. But, as the chart shows, it is becoming increasingly difficult to achieve further reductions in DOC.

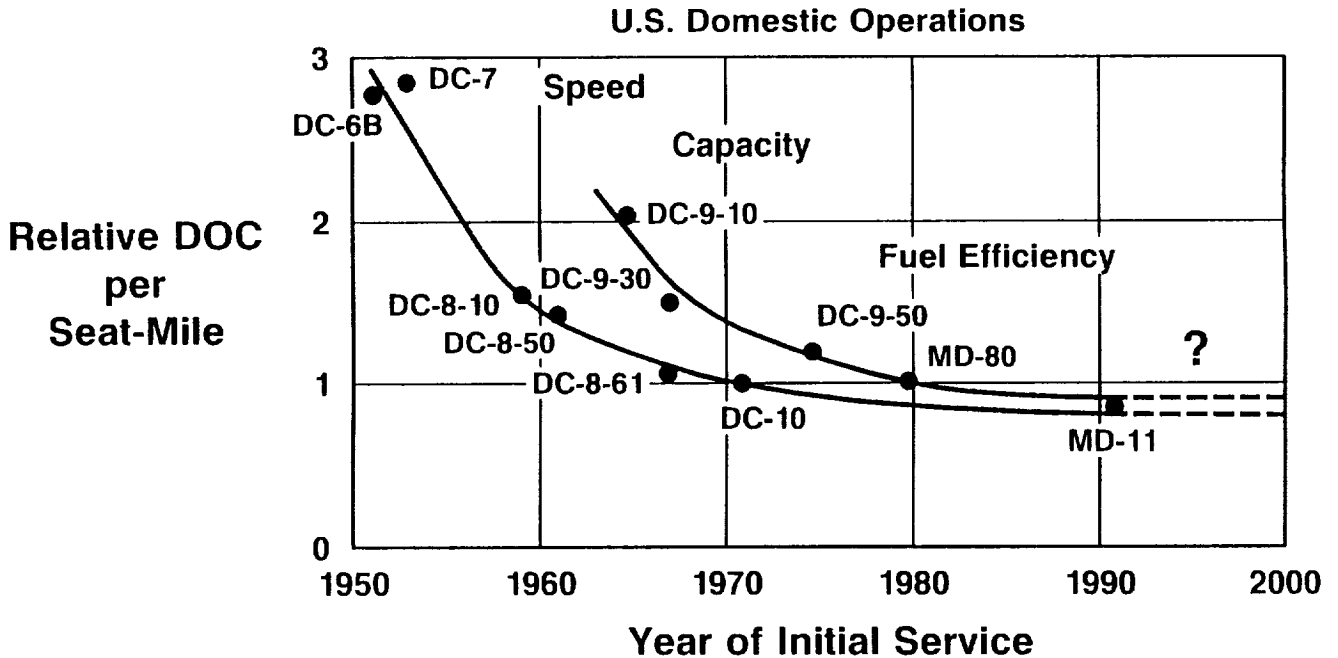

## Operating Cost Distribution

The major component influencing direct operating cost is the ownership cost. Future advances in aerodynamics, engine SFC, and structural weight will continue to shrink the fuel contribution to total cost. However, reductions in ownership cost dominate the equation to justify the development of new aircraft.

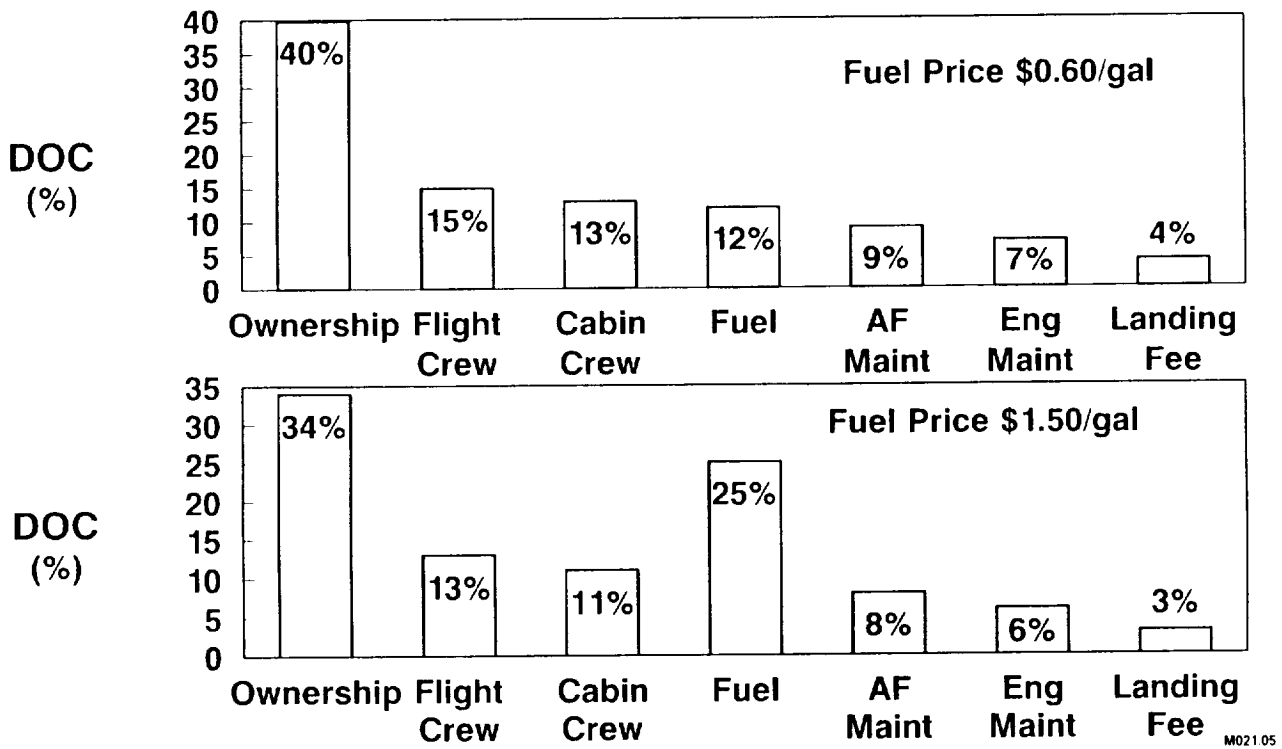

## U. S. Jet Kerosene Price

The forecast by McDonnell Douglas is that long-term fuel prices will remain flat in constant dollar terms at about 60 cents per gallon. This is based upon an abundant oil supply remaining (over 40 years supply at present consumption) and the short-term nature of dramatic fluctuations due to political events. Therefore, ownership costs are expected to continue as the largest element in the DOC equation.

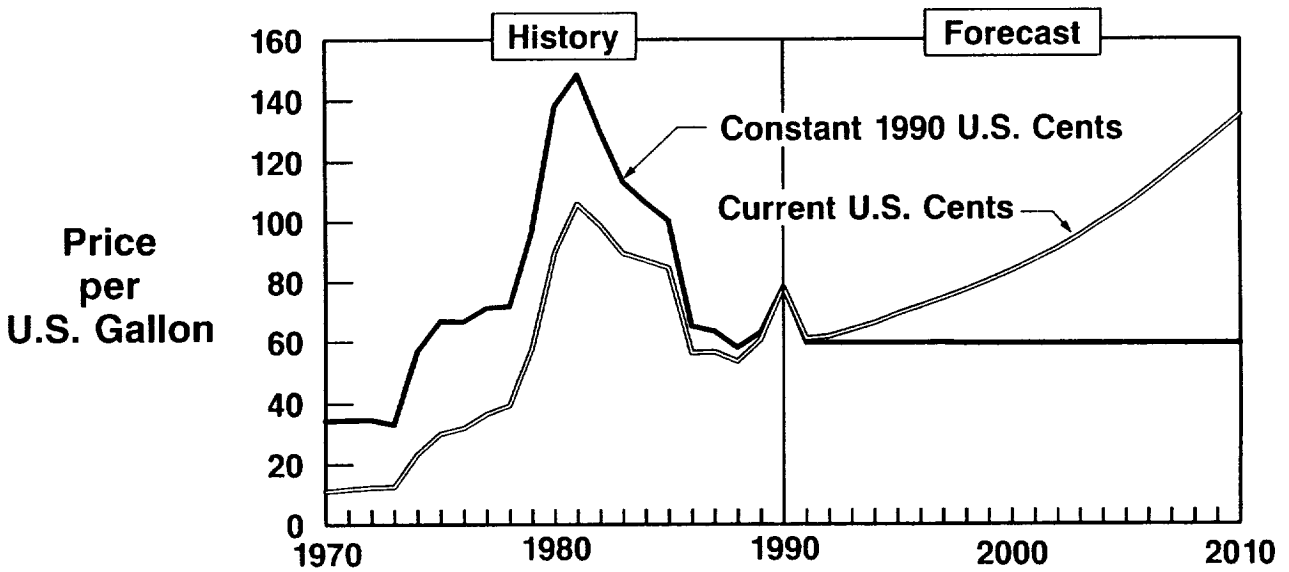

## Passenger Aircraft Deliveries

World passenger traffic is expected to grow at a 6.5% annual rate through 2010. During this period, international passenger traffic is projected to grow to 7.8% a year while domestic traffic is predicted to increase 4.9% annually. Pacific/Asia will experience the fastest growth while North American traffic growth will remain essentially constant. To meet the increased traffic demand, the world's jet aircraft fleet is expected to more than double in the next 20 years (17,000 passenger aircraft by 2010 compared to 8,000 today). The requirement for additional capacity combined with aircraft retirements results in a McDonnell Douglas forecast of over 14,000 passenger jet aircraft deliveries during this time period. These aircraft are split almost evenly between narrow-body and wide-body units. In constant 1990 dollars, their value is almost one trillion dollars.

### *By Domiciled Region, 1991-2010*

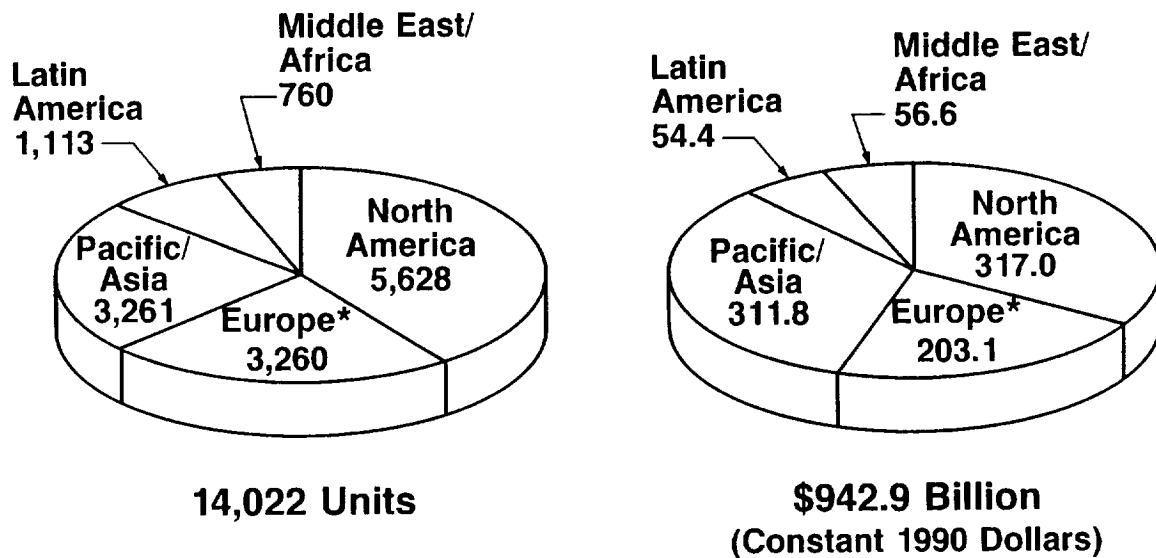

\*Excludes USSR

## The Challenge to Technology

An improvement in any of the DOC parameters is very difficult to achieve. Consider that a ten percent reduction in the cost/price of the aircraft is a very large reduction, but reduces DOC by only four percent. However, a new aircraft should provide roughly a 10% improvement in operating cost to provide the sales potential necessary for production commitment. To contribute to the achievement of that objective, composite primary structure must provide a cost benefit as well as the expected weight savings. This is the goal that must be achieved to realize the use of composite primary structure on a transport (commercial or military) aircraft.

### *DOC Drivers*

*A 10-Percent Improvement in Each Parameter Has This Impact on DOC*

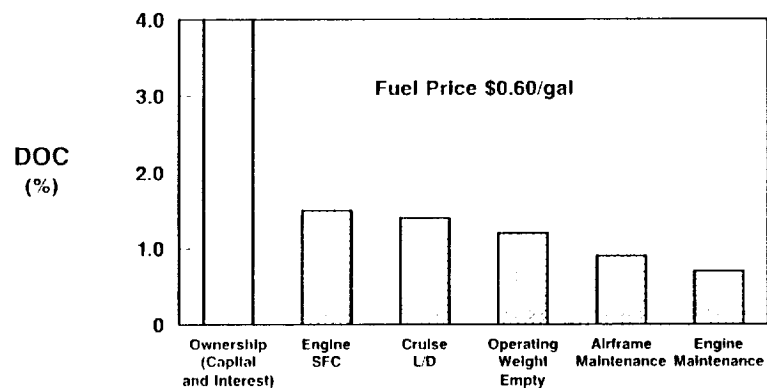

### *Direct Operating Cost Objective*

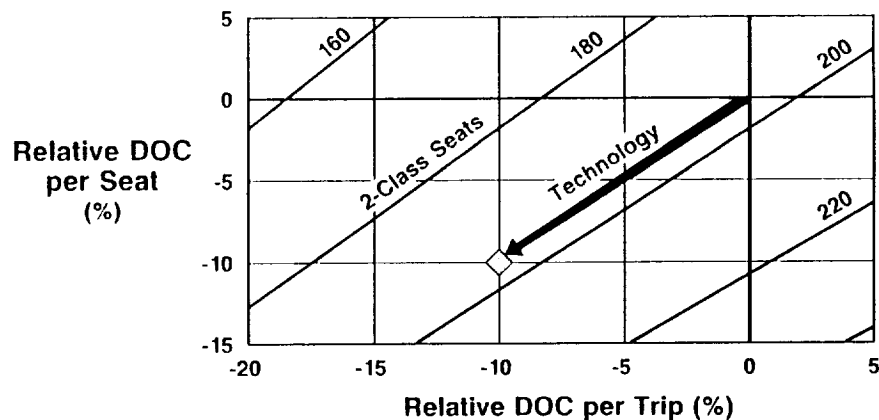

**Reductions in operating costs  
that will justify inclusion in the product**

## MD-11, C-17, MD-12 Composite Construction

The extent of composites usage has continued to increase with time. Aircraft currently in production utilize composites in numerous secondary structures such as fairings and control surfaces. Composites account for 4 to 6 percent of the empty weight of these aircraft. The MD-12 will utilize composites for the vertical and horizontal stabilizer boxes and floor beams, increasing the composite content to about 9 percent of empty weight.

# *Composites Application in Douglas Transport Aircraft*

## *MD-11 Composite Construction*

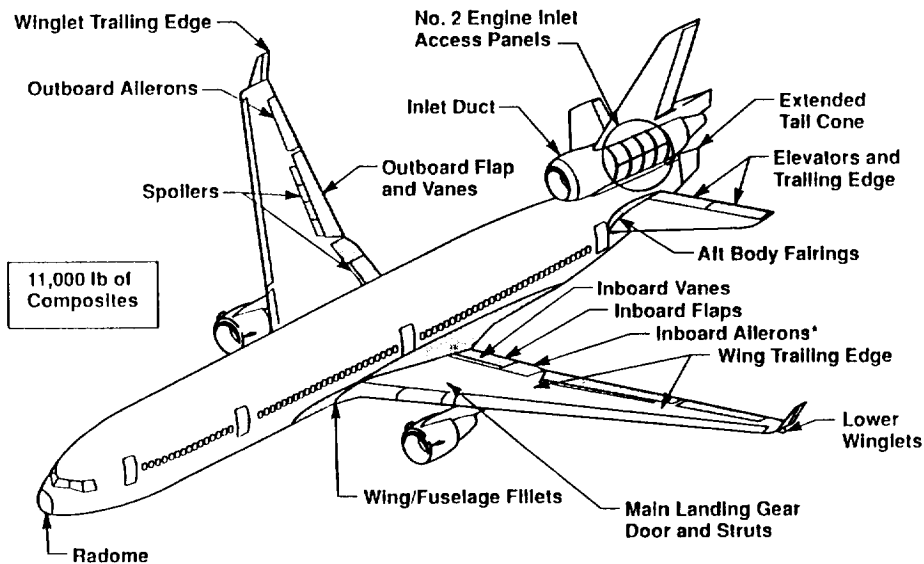

## *C-17 Composite Applications*

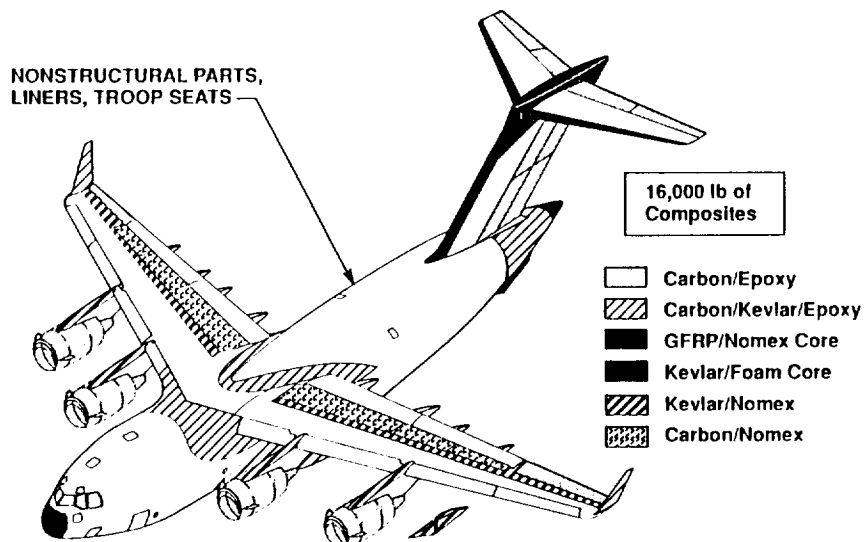

# MD-12

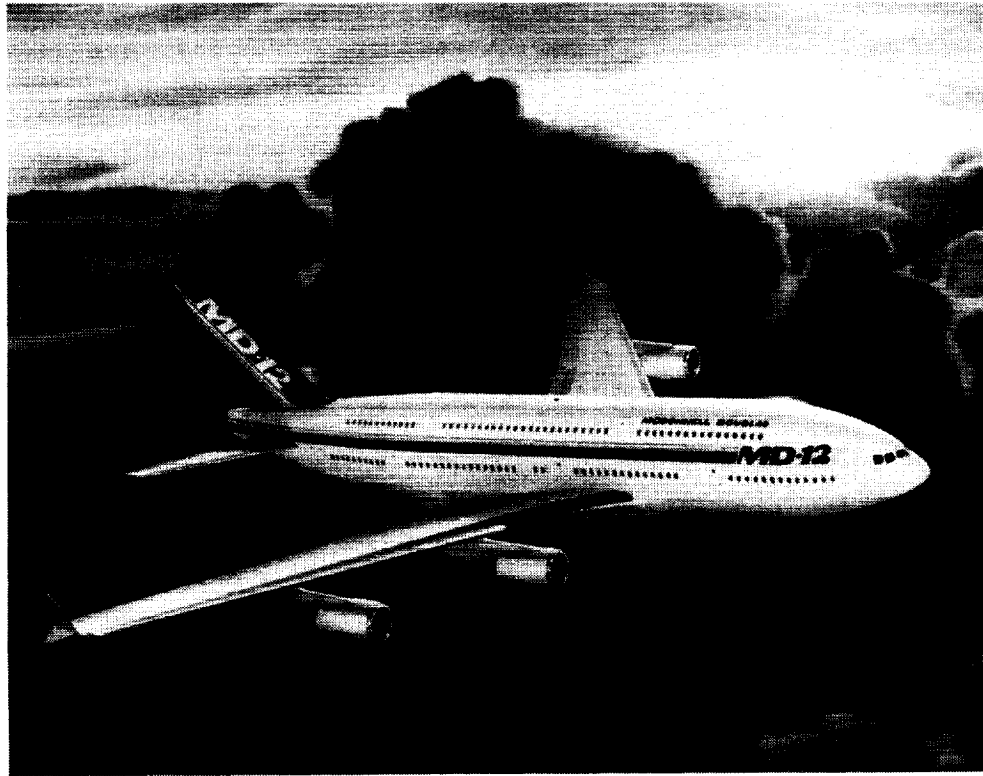

## Wide-Body Cross Section Comparison

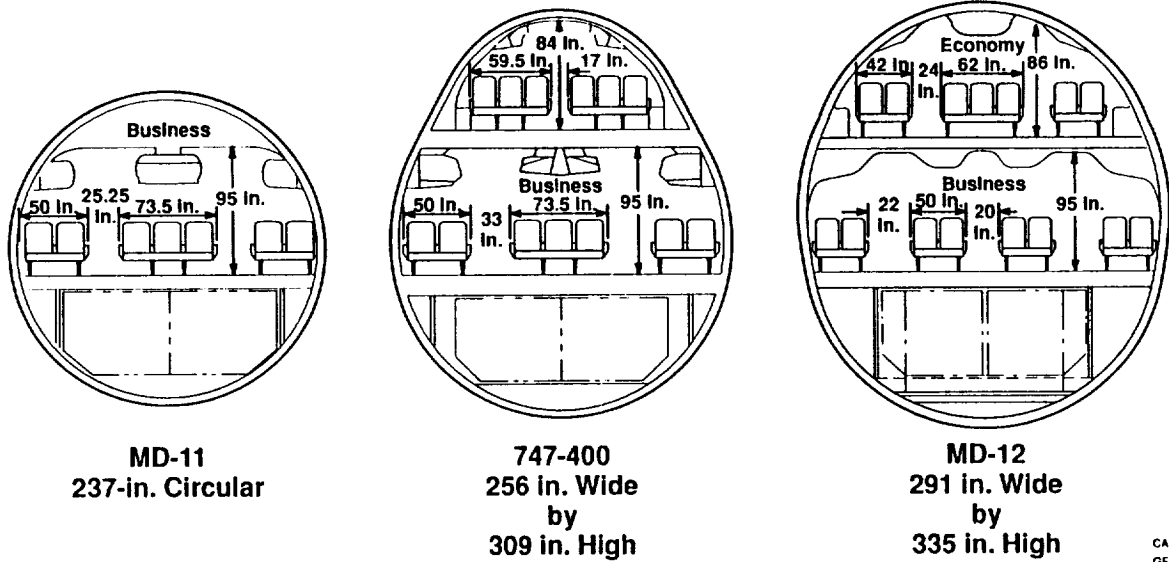

CA3010.02a  
GFVC024-7



# MD-12 Composite Construction

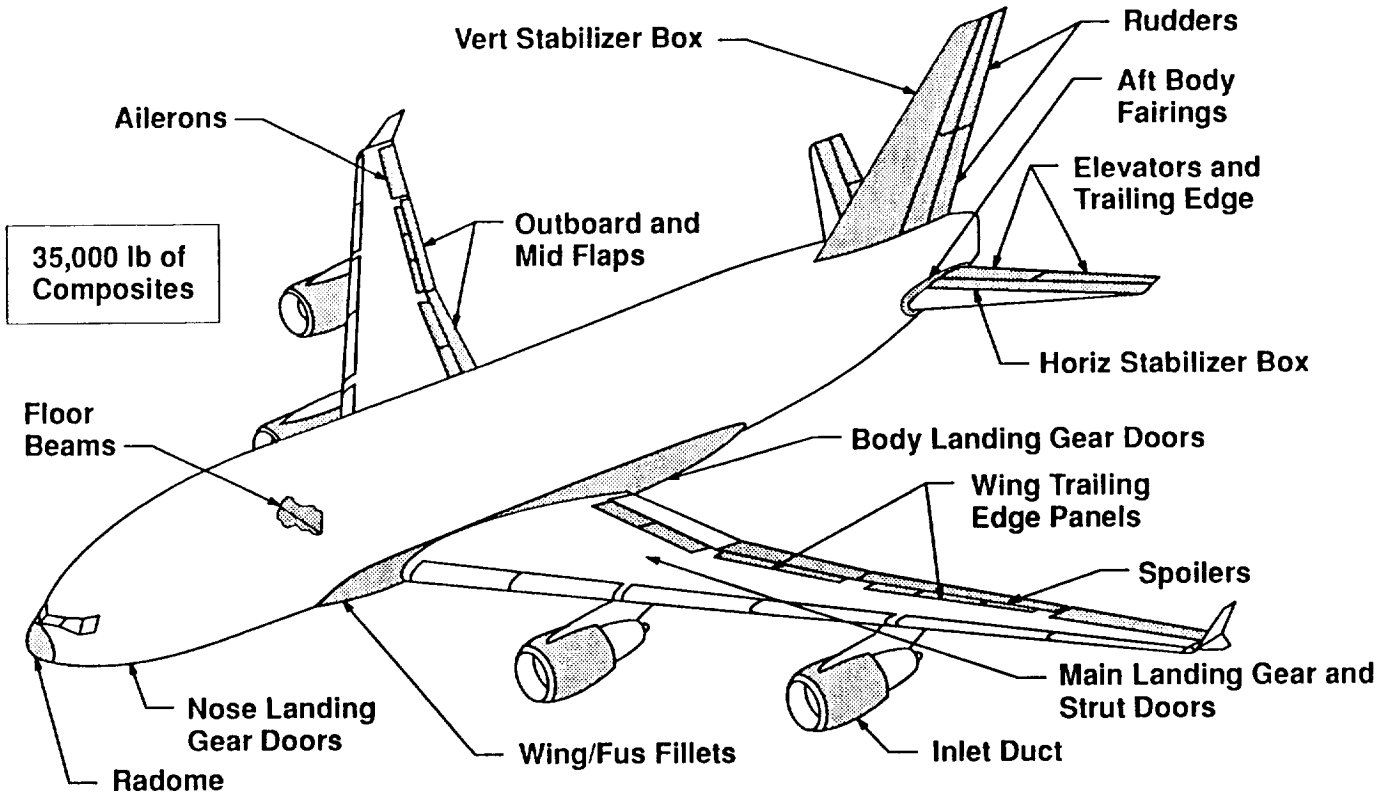

## MD-XX Composite Construction

With composite wing and tail, the composite content of the MD-XX will grow to over 20 percent of empty weight. If the MD-XX were to also have a composite fuselage, the percent composite would be over 40% of aircraft empty weight.

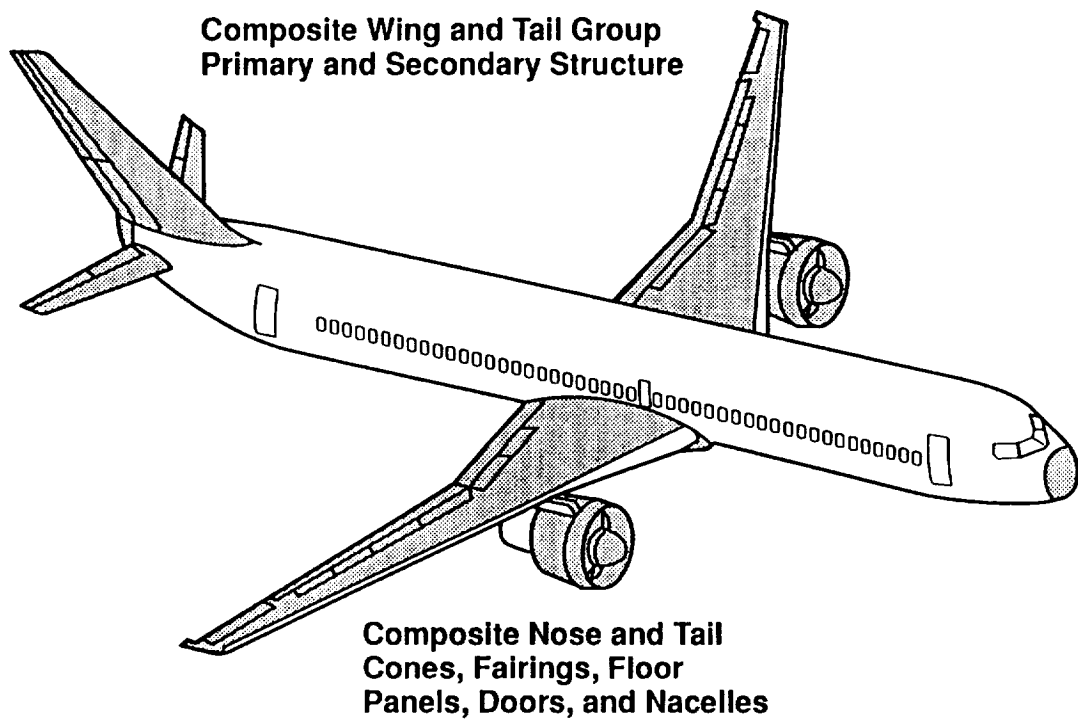

## Wing Box Data Projection

Conventional composite construction reduces weight but at increased cost. McDonnell Douglas studies of a wing box unit show a 25 percent weight savings but a 50 percent or greater cost increase for a conventional composite unit. Using the ICAPS methodology, the weight savings will be retained with a goal of achieving better than a 40 percent improvement in cost compared to the conventional composite unit.

### *Objectives of DAC Composites Program With NASA*

Develop Primary Structure Technology  
Below the Cost of Metal

### *Wing Box Cost Data Projection*

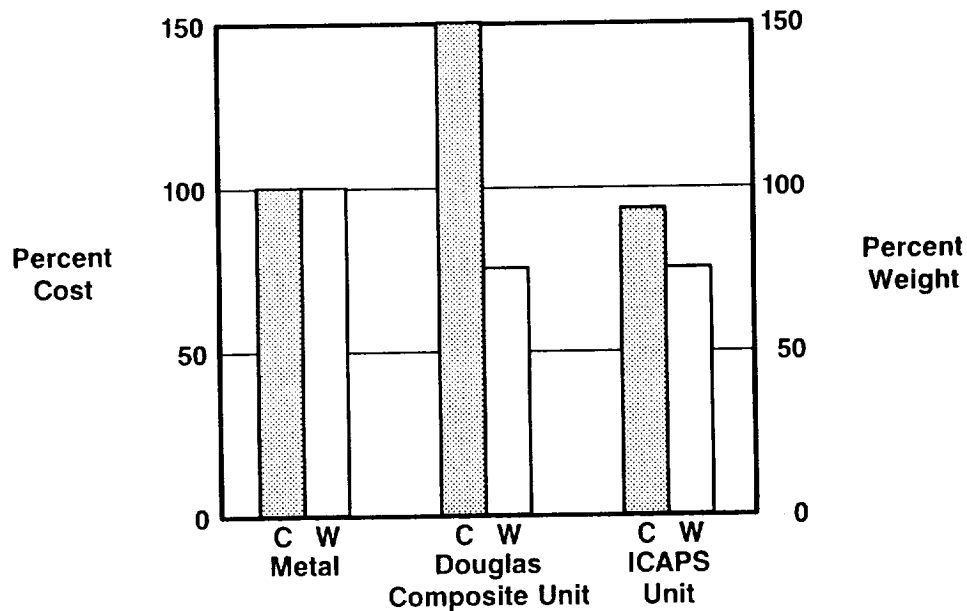

## Aircraft Cost Distribution

Ownership costs (to the operator) are directly related to the vehicle price which, in turn, depends on the manufacturer's cost. Structure costs are larger than propulsion, avionics, or equipment costs. The largest components of structure costs are the fuselage and wing. These two components provide the largest potential for a significant impact on ownership cost and total operating cost. McDonnell Douglas has elected to focus its initial effort on the wing. Success with a composite wing will yield two benefits: reduced weight and reduced drag. Reduced drag results from the stiffness characteristics of composite which allows higher aspect ratio without attendant weight penalties.

### *1990 Technology Aircraft*

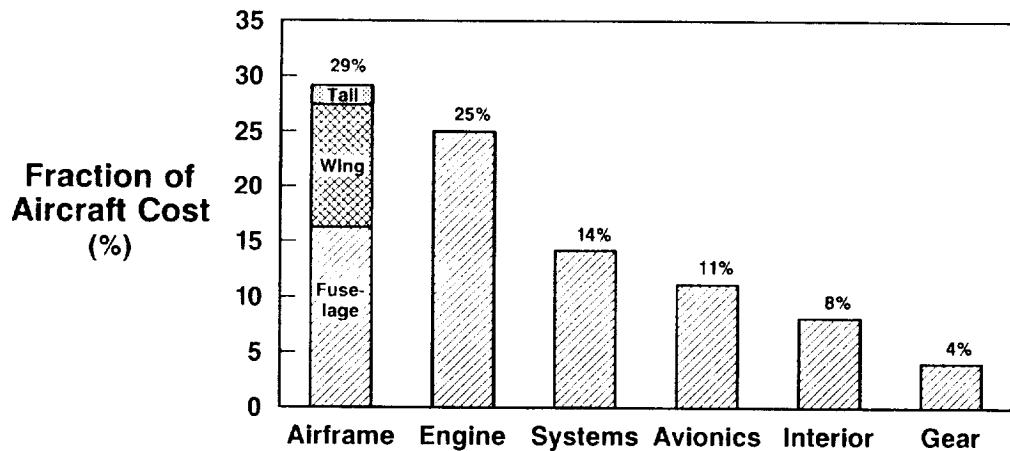

## *MD-XX Composite Wing Technology*

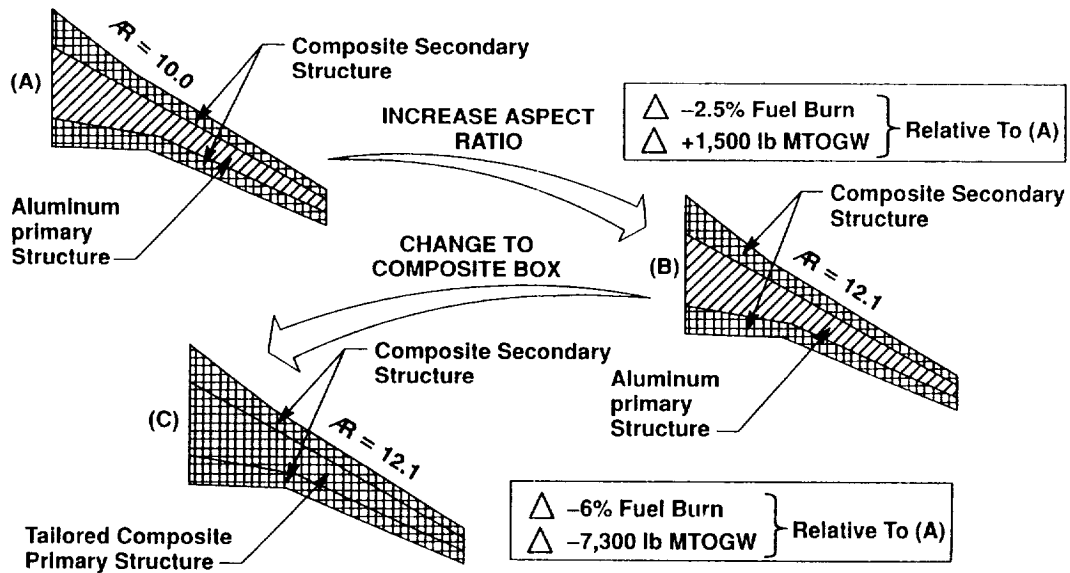

### One-Third Reduction in Fuel Burned

It is possible, through incorporation of several new technologies, to achieve a one-third reduction in aircraft fuel consumption. However, a full one-third reduction in fuel burned exclusively is not enough to achieve a ten percent reduction in DOC. An all-new aircraft with a thirty-three percent reduction in fuel burned would provide an economic benefit of only four to eight percent in DOC depending on fuel price.

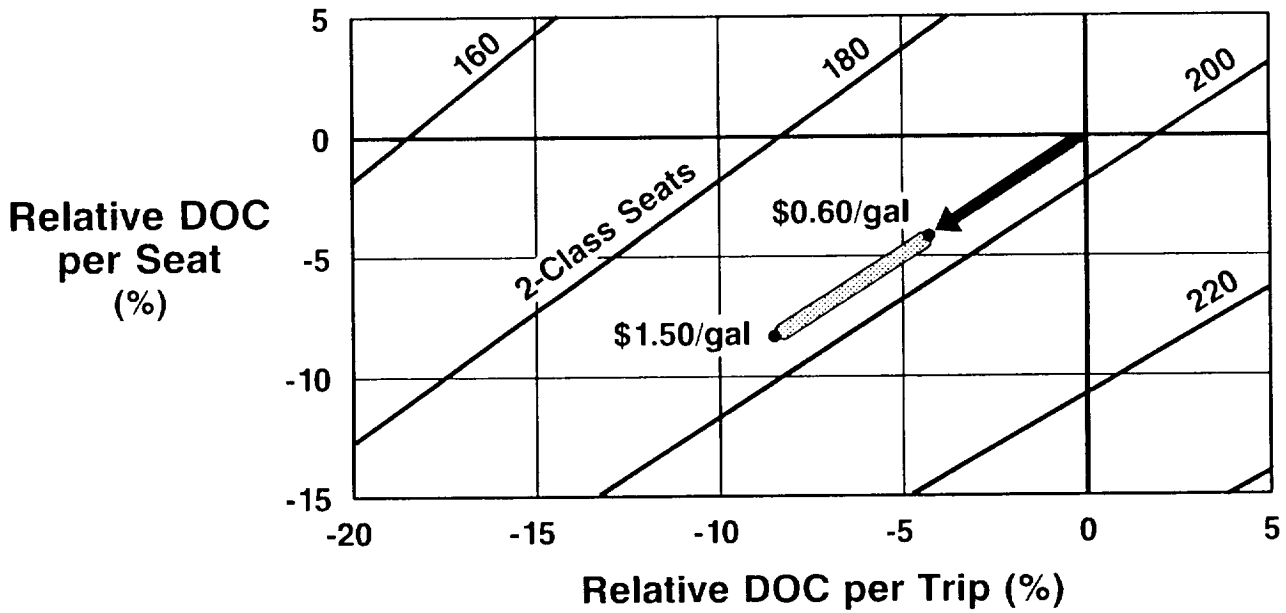

### DOC Using Conventional vs. ICAPS Wing Box

The benefit of the ICAPS wing on the total direct operating cost has been calculated for an MD-XX aircraft. Reducing the cost of the wing by just ten percent provides an additional two percent reduction in DOC.

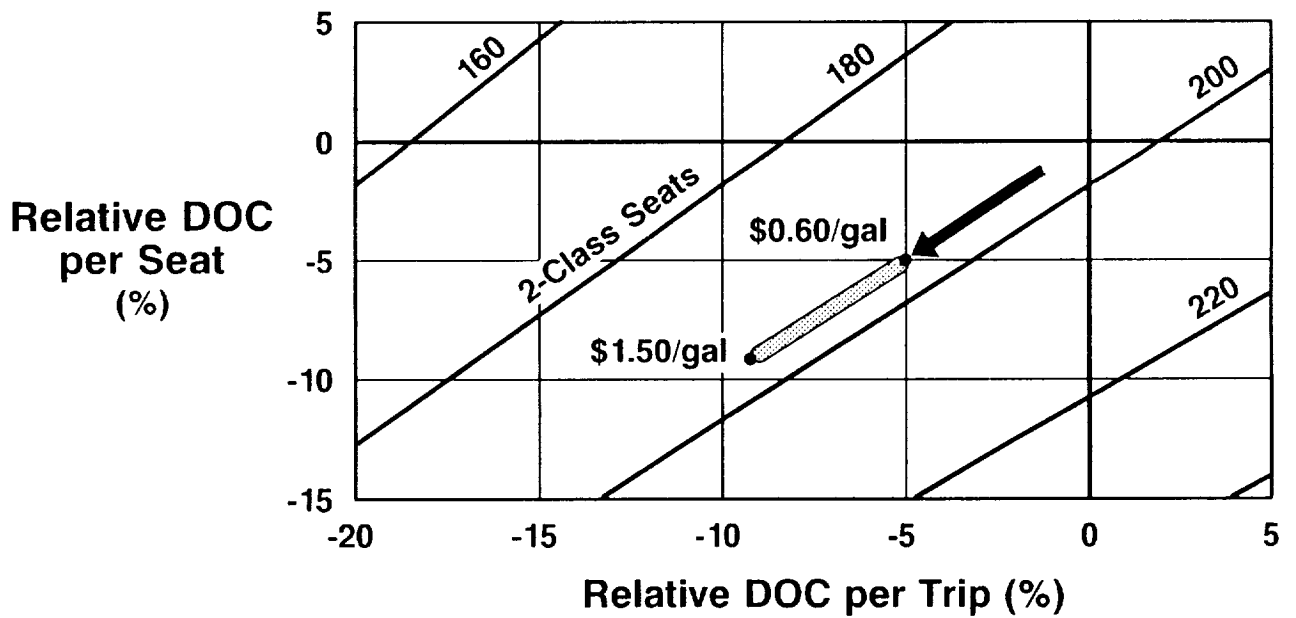

## DOC Using ICAPS Wing and Fuselage

Extending the use of the ICAPS methodology (i.e., weight and cost reduction) to include the fuselage improves the total operating cost picture even further.

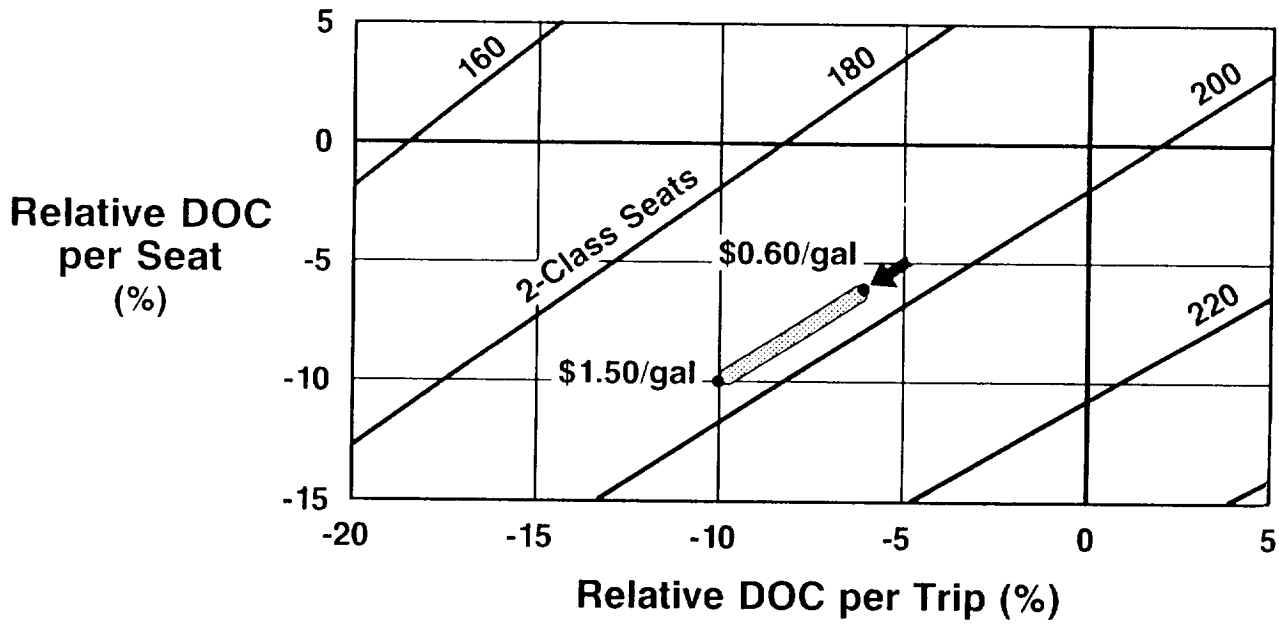

## DOC Using Current Composite Construction Costs

Extensive application of composites at today's cost of construction is prohibitive. The resulting increased cost of ownership has offset nearly all the fuel consumption benefits associated with the application of several new technologies.

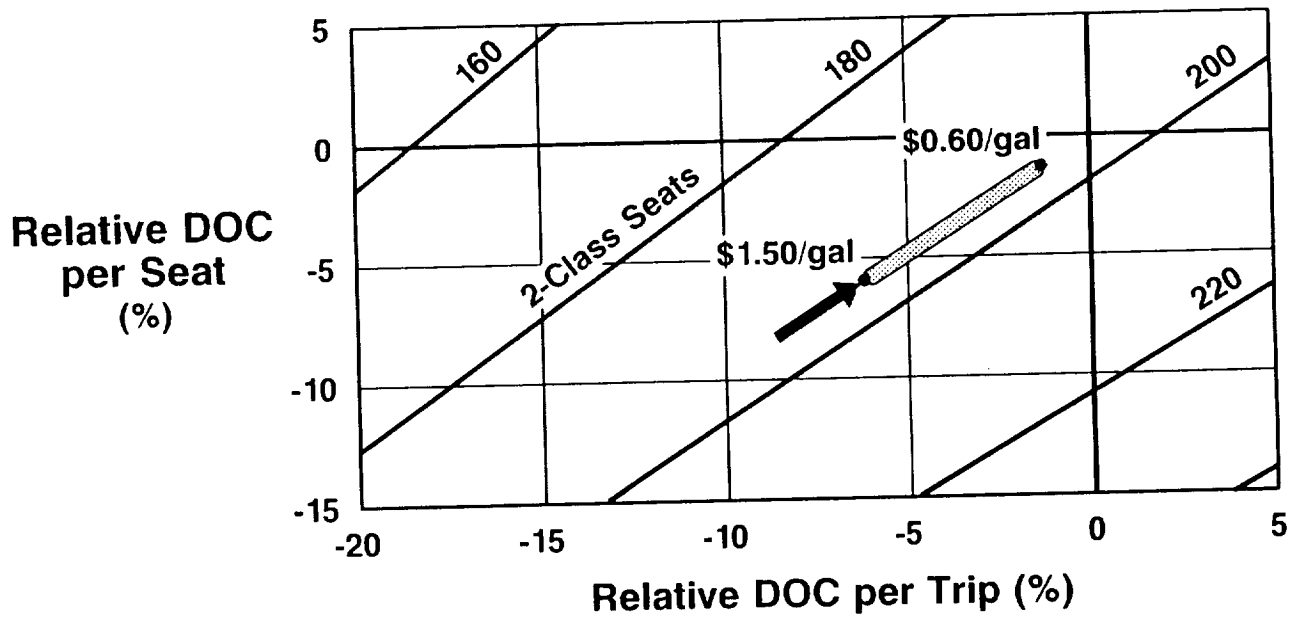



## Innovative Composite Aircraft Primary Structure

The following charts depict the schedule and some of the results to date of the Douglas composite primary structure program. The program will conclude with the construction and testing of a full scale (approximately 60 ft.) semi-span. The wing stub box is currently under construction. Single and multi-needle sewing machines are shown making performed parts prior to RTM. These machines will potentially replace expensive drivematic riveting machines used in manufacturing metal wings.

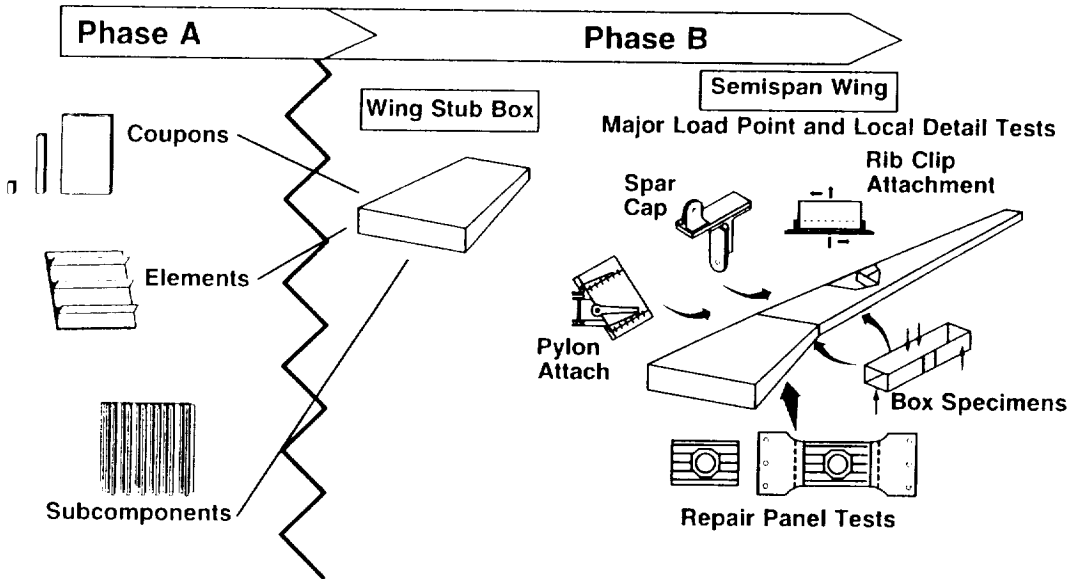

4 by 6 Foot Stitched Preform

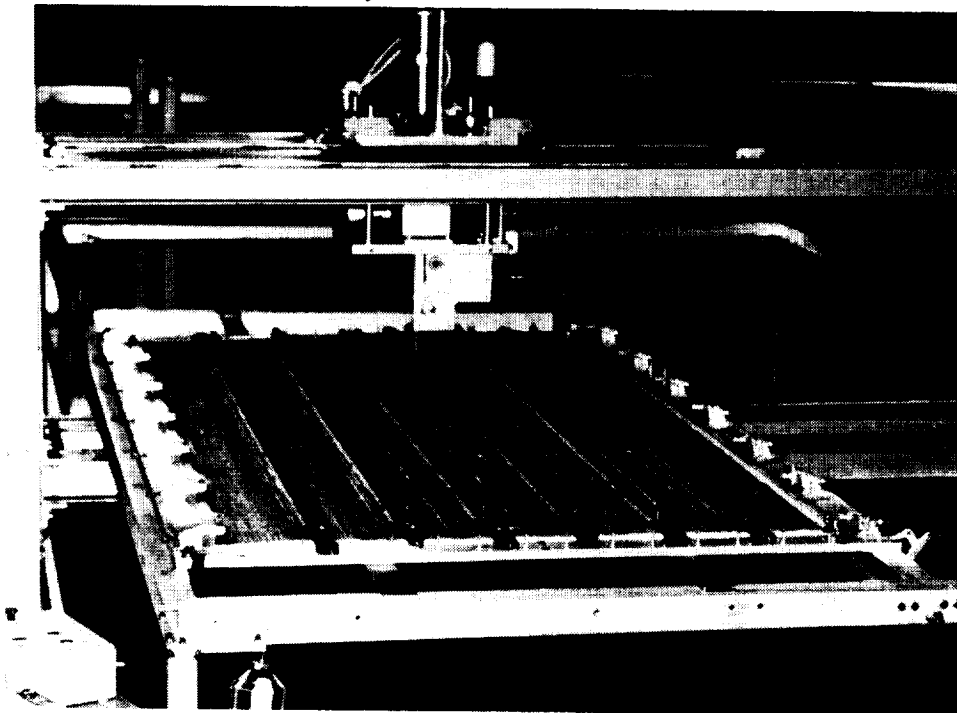

Stitching Machine Operation

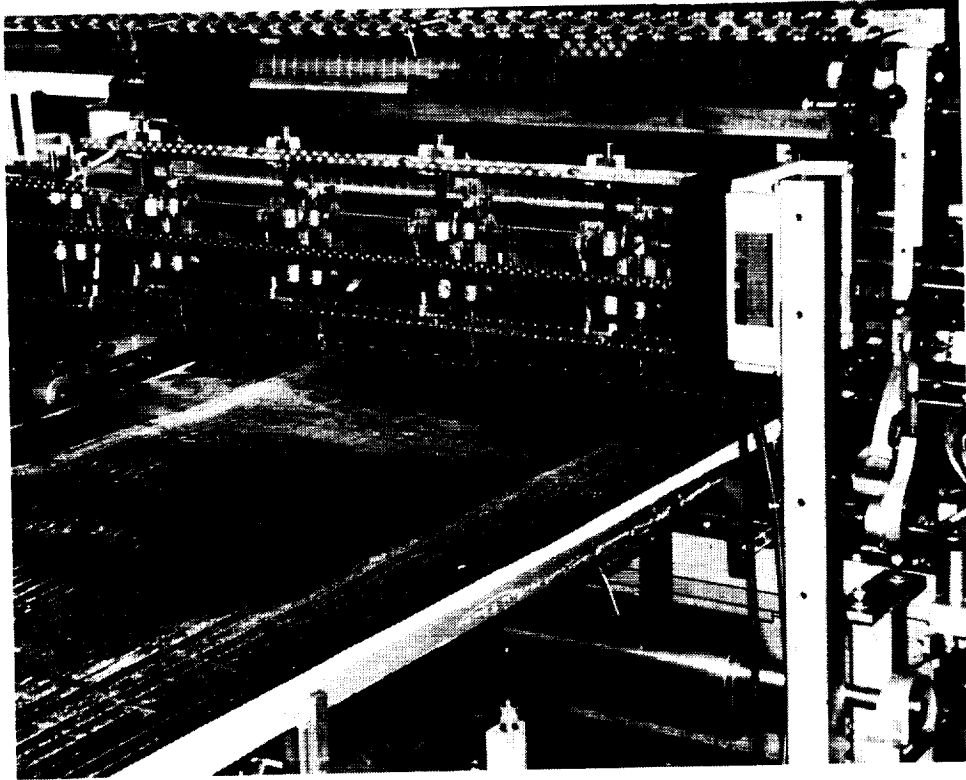

128 Needle Stitching Machine

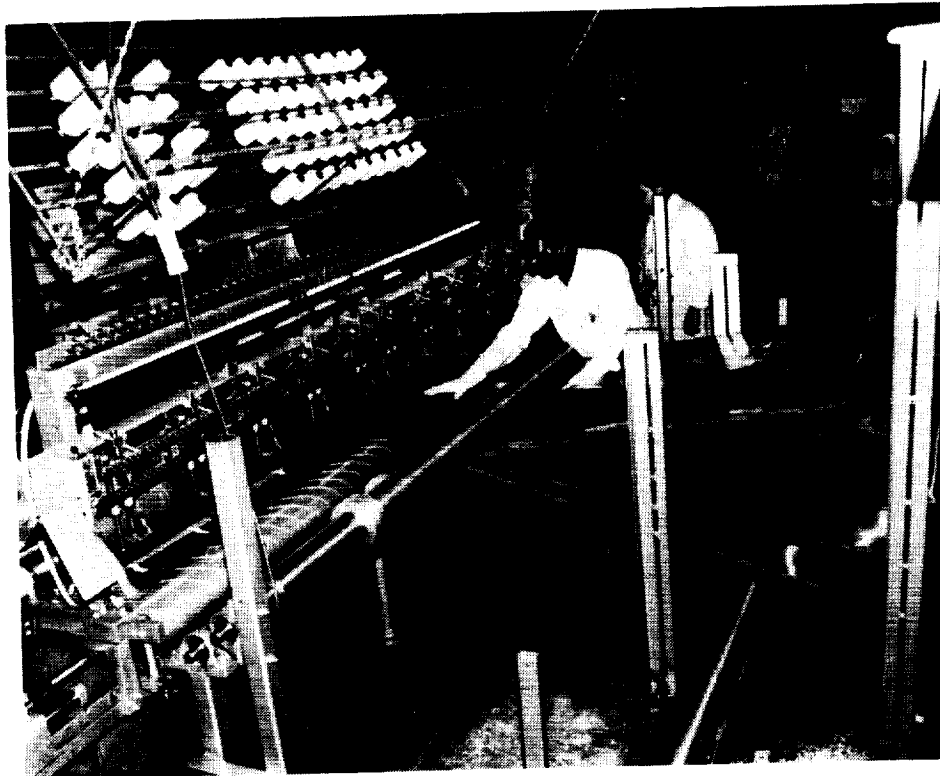

## *Wing Section In Drivematic*

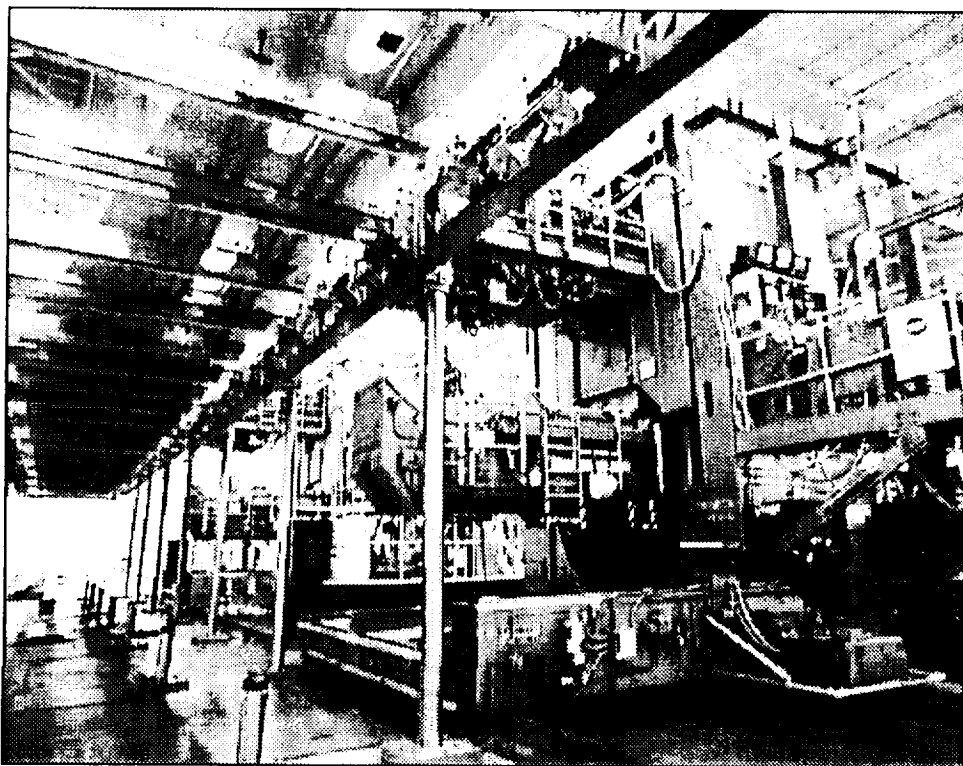

## Damage Area Comparison for Blade-Stiffened Panel

While composite laminates have excellent properties in the plane of the layers, they are weak in the through-the-thickness direction. Stitching provides a means for suppressing the types of delamination failures arising from that weakness. One advantage provided by stitching is the reduction in the incidence and size of damage from impacts and the subsequent reduction of maintenance and repair costs. Weight saving is realized because the working allowable stress levels for damaged compression structure is increased.

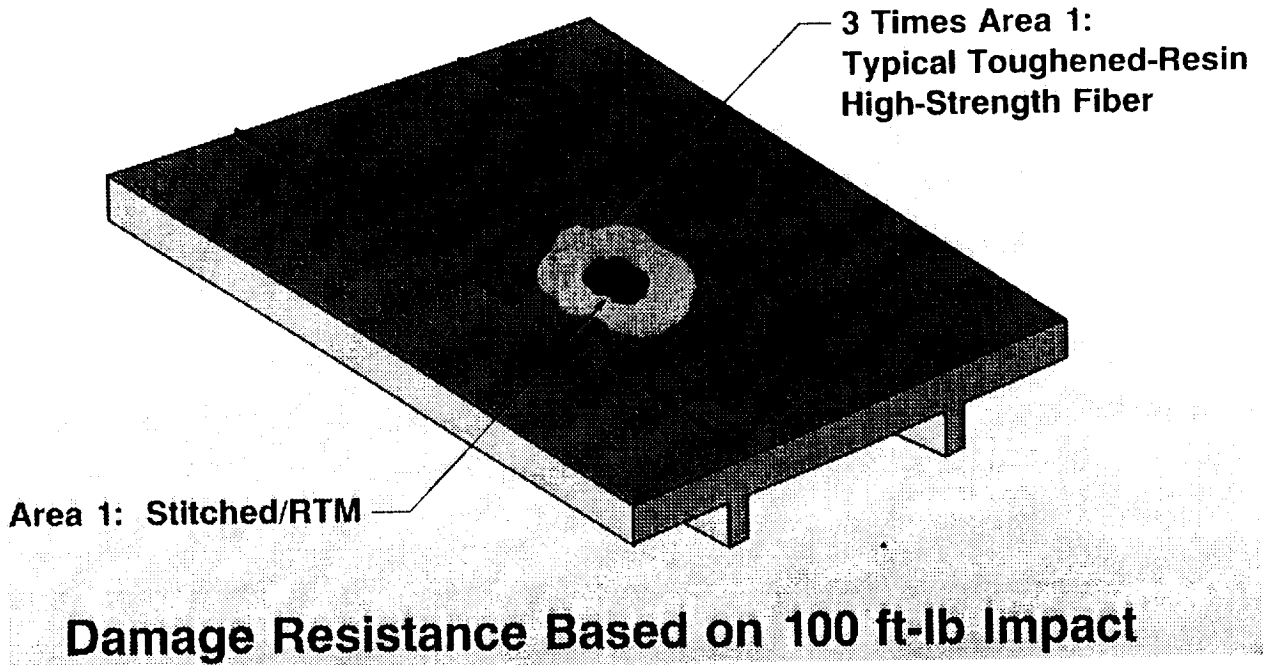

## Typical Compression Test

Composite panels loaded in compression typically fail with extensive splitting apart of the laminate layers. This mode of failure can be totally suppressed when high-density stitching is used. Stitched compression panels fail on a 45° shear plane in a manner much more typical of that expected from homogeneous metal panels.

Brooming Failure of Toughened Resin and High Strength Fibers  
(Prepreg Panel-Unstitched)



Compression Failure at 45-deg Shear on  
Blade Stiffener and Skin (Stitched/RTM-Blade Stiffened)  
Wing Compression Test Panel

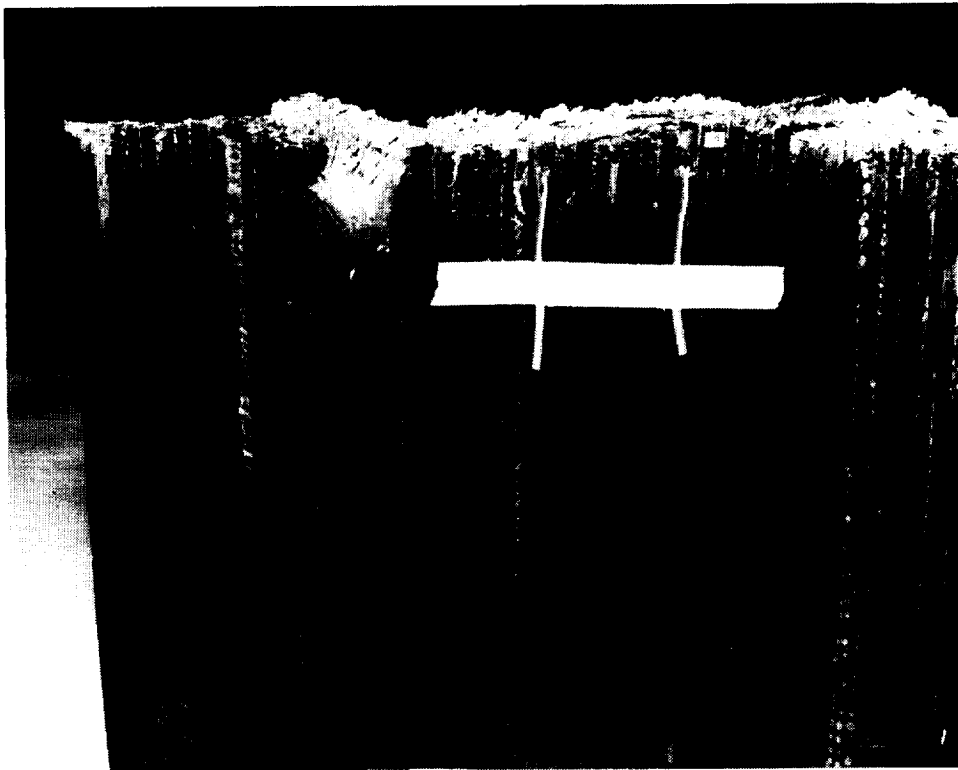

## Summary

In summary, there is a requirement for a large number of new conventional aircraft over the next 20 years. Sales of these aircraft will go to the builders who can offer the best operating economics. Ownership costs will continue to dominate the economics equation. To find application on these new transport aircraft, composite primary structure must provide production cost reduction as well as fuel consumption and maintenance benefits.

**Conventional subsonic transports will continue to dominate the market.**

**Ownership cost will continue to increase as a percentage of total operating cost.**

**Composite primary structure can benefit several elements of the operating cost picture - ownership, fuel, maintenance.**

**A well-conceived and implemented ICAPS plan will provide major benefit to the next transport aircraft.**