

TM-110655

**Minutes
of the
12th Joint NASA/DARA-DLR
Life Sciences Program
Working Group Meeting**

(NASA-TM-110655) MINUTES OF THE
12TH JOINT NASA/DARA-DLR LIFE
SCIENCES PROGRAM WORKING GROUP
MEETING Final Report (NASA. Ames
Research Center) 234 p

N95-32719
--THRU--
N95-32731
Unclas

G3/51 0055692

October 26 - 27, 1994

**NASA Ames Research Center
Moffett Field, California**



•

•

•

•

MINUTES

12th Joint NASA/DARA-DLR

Life Sciences Working Group Meeting

NASA Ames Research Center, Moffett Field, CA

October 26 and 27, 1994

Welcome and Introductory Remarks

The 12th NASA/DARA-DLR Life Sciences Working Group Meeting was held at NASA Ames Research Center (ARC), Moffett Field, California, October 26 and 27, 1994. Dr. Ronald J. White, chairman of the NASA delegation and Senior Program Scientist of the Life and Biomedical Sciences and Applications Division, welcomed both delegations and introduced Dr. Gunter Ruyters as the Head of Section Life Sciences at DARA and chairman of the German delegation.

The agenda for the present meeting (Enclosure 1) was discussed and there were no amendments. Action items from the meeting in Potsdam were reviewed.

German Life Sciences Status Report

Dr. Ruyters presented (Enclosure 2) an update of the new organization of DARA and the German Life Sciences Program. The program is shifting from a descriptive way of doing science toward a more in depth analysis of the effects of the space environment on living systems. The focal points of the scientific research areas are physiology and work on Bioregenerative Life Support Systems, with more funding being allocated to the Gravitational Biology and Radiation Health Programs due to the work being done in the Specialized Centers of Research and Training (SCORTS). Dr. Ruyters cited statistics showing that more than 50% of all of the German experiments in space have been flown in the last two and a half years. This same trend in flight rate is seen in the NASA Life Sciences Program. He expressed concern that: (1) a gap exists in flight opportunities between EuroMir '94 and '95, and Neurolab '98; and (2) DARA is lacking expertise in the musculoskeletal and human factors areas. Dr. Ruyters provided insight on DARA's considerations for Space Station hardware development and expressed interest in developing MEDEX as the German part of the joint French/German CARDIOLAB and an aquatic research facility. Budget figures for the Life Sciences Program show a decline for the future, but it has been requested that funding for the basic flight and science programs be kept constant.

NASA Life Sciences Status Report

Dr. Joan Vernikos, Director of the Life and Biomedical Sciences and Applications Division, presented an overview of the new structural organization of the Life Sciences Division (Enclosure 3). She outlined a new structure for all of the Division's activities by placing each activity into one of only three research areas: gravitational research, environmental research, and life support research. The overall budget for the Division indicates an estimated 13% decrease in funding from 1994 to 1995. Dr. Vernikos noted, however, that the cost of facility development is increasing, and that this is responsible for the budget increases. In an outline of the Orbital Research program, Dr. Vernikos briefly described the status of near term missions, including the Life and Microgravity Sciences (LMS) mission, Bion 11 and 12, the Shuttle/MIR Program, and International Space Station Alpha (ISSA). In addressing ISSA, she remarked on the unique opportunity that ISSA will provide to integrate cellular, animal, plant, and human programs. Dr. Vernikos concluded her presentation by speaking about programmatic objectives and applications of technology that have had their roots formed at NASA and in the Life Sciences Programs. She pointed out that the main objectives of the Division are to "spread the word and improve the quality" of Life Sciences and to that end, improve the quality of life on Earth from what is learned through our programs.

Centers of Excellence Session

- **Radiation Health - Directors' Reports**

Dr. Alope Chatterjee, Director of the Radiation Health NASA Specialized Center of Research and Training (NSCORT) at Lawrence Berkeley Laboratory (LBL) and Dr. Jürgen Kiefer, Director of the Radiation Health German SCORT at Gießen, briefed the delegations on the highlights of the Radiation Programs at their respective Centers (Enclosures 4 and 5). They reported that there would be an exchange of investigators and students between the two Centers which in turn would provide for a good interchange of scientific ideas between the two agencies. Drs. Chatterjee and Kiefer outlined the major focuses of the research projects currently being done in the SCORTs with an emphasis on repair mechanisms and mutations in cells.

- **Integrated Physiology - Overview**

In a brief summary, Dr. Gunnar Blomqvist of the Integrated Physiology NSCORT at the University of Texas Southwestern Medical Center, outlined the organization of the program and described its overall theme as "the biology of disuse atrophy in organ systems." He explained the research currently being done in the NSCORT as well as plans for future studies. A proposal to the university for an integrated physiology training program is in the developmental stages and a formal application will be made this spring. From this program Dr. Blomqvist hopes to gain the well-trained physiologists who are needed in the Life Sciences Programs. The need to bridge areas of research was discussed and exemplified by the strong presence of musculoskeletal investigators in the NSCORT but the lack of them in the German Life Sciences Program.

- **Overview of Research and Facilities at Ames Research Center**

Mr. Kenneth Souza, Associate Director for Life Sciences at ARC, reviewed the organization of ARC and its four directorates. He cited the specific scientific thrusts of the Space Directorate as being focused on fundamental aspects of space biology and medicine encompassing life, Earth, and space. In addition, he gave an overview of the facilities at ARC.

After the briefing, the German delegation was taken on a tour of the Ames facility and was given the chance to speak with Project Managers.

Plenary Session

- **Neurolab**

Dr. Mary Anne Frey presented a report on the current status of the Neurolab mission (Enclosure 6). She indicated that the strong international cooperation and integrated peer review processes being implemented for Neurolab might serve as models for the management of ISSA. She outlined the structure of the science teams indicating the possible need for a steering committee meeting in early May 1995 to determine the final investigation list for the mission.

During the presentation Dr. Ruyters expressed two concerns to the group about the Neurolab mission. Firstly, which agency should develop the Lower Body Negative Pressure (LBNP) equipment to be used on Neurolab and secondly, he expressed a desire on the part of DARA to have a German Payload Specialist assigned to the mission. Dr. White explained that there is a technical issue that needs to be addressed concerning the development of the LBNP and that it would be discussed during a December meeting in Cologne, Germany. Dr. White then discussed the qualifications that will be required to be a Payload Specialist on Neurolab and stated that crew selection for this mission will follow the standard NASA procedure. Finally, in a brief statement on the status of the Closed Equilibrated Biological Aquatic System (CEBAS), Dr. Ruyters reported that sample distribution plans were being worked.

- **Shuttle/MIR Program**

Dr. Victor Schneider, US/MIR Program Scientist, gave an update on the Shuttle/MIR Program. He described the two-part phase (1A and 1B) of the mission and outlined overall priorities. He explained that phase 1A is a cooperative program with the Russians where there is no financial exchange but there are joint research proposals. Use of MIR for phase 1B, however, requires the U.S. to pay \$400 million to Russia over four years. Only scientists from Johnson Space Center (JSC) were eligible to compete in phase 1A (because of tight time constraints) and 23 of 26 of their proposals were selected for definition and possible flight. The launch date of the Spektr module has slipped and because of this the science to be done on MIR has not been defined at this time. It is now possible that a U.S. astronaut could be on MIR without the benefit of research equipment for most of the mission. Concern was expressed that Russian cosmonauts might not be available as research subjects on the phase 1B missions.

Mr. Tad Savage of NASA ARC spoke briefly on the Shuttle/MIR Program. He reported that a team will be sent to Moscow to determine if the scientific objectives of the Russians are comparable to those of the U.S. He also pointed out that NASA wants to have the Biorack available for use on three of the MIR missions, but for this to happen there needs to be a reprioritization of mission goals because currently the Biorack is not officially manifested for MIR. Also under consideration is having Spacehab flown instead of the Spacelab, in which case, the Biorack design will have to be reconfigured appropriately.

- **MIR '96 Mission**

Dr. Ruyters presented a broad review of the cooperative German/Russian MIR '96 mission which will concentrate on human physiology investigations (Enclosure 7). He addressed the logistical concern of transport to and from MIR for the German astronaut by outlining alternative ways of proceeding, including possible transport on the Shuttle. It was thought that any opportunity for NASA to obtain data from long-term investigations through cooperative agreements should be pursued.

- **"New" Spacelab Mission**

Dr. Victor Schneider briefly reported on the status of the LMS mission and gave some insight into the hardware currently being developed. During the presentation, Dr. Ruyters noted there are rumors that the cartridges for the Advanced Gradient Heating Furnace (AGHF) were not working well and probably will not be ready for the mission. He brought this to the attention of the NASA delegation in light of the restructuring of the Slow Rotating Centrifuge Microscope (NIZEMI) which can be used if the AGHF is unavailable. Interest was expressed from the NASA side for having the NIZEMI integrated into the ISSA Gravitational Biology Facility (GBF); DARA is currently investigating this possibility at the contractor's site.

- **Small Payloads Hardware Status**

Ms. Joni Richards, Biorack Program Manager, described the status of the hardware in the Small Payloads Program (Enclosure 8). Extensively discussed was DARA's CEBAS with talks centering around proposed precursor flights to Neurolab utilizing the Small Payloads Program to test the flight suitability of the minimodule. CEBAS is still in the developmental stages and a date for delivery has not been set.

- **Human Factors**

Dr. Guy Fogleman, Acting Chief of the Environmental Systems and Technology Division, presented the current status of the Human Factors Program. He emphasized the programmatic goal of translating space-based knowledge and concepts into applied benefits for Earth. The next NASA Research Announcement (NRA) will include a request for investigations for applied aspects of Human Factors.

- **CO₂ Study at DLR**

Dr. Mary Anne Frey presented a report on the CO₂ studies currently being undertaken at DLR (Enclosure 9). The study concerns itself with learning the effects of moderately elevated levels of CO₂ on human physiology as well as on results of science investigations.

Dr. Hans Wegmann of DLR presented the current levels of CO₂ and O₂ on MIR and indicated that they were in the high range. Dr. Charles Wade of NASA ARC told the group that no changes in total body weight of animals subjected to higher levels of CO₂ have been noted. However, at 2% CO₂ the lungs of rats are heavier and the femur is lighter.

- **International Plant Space Research Plan**

On behalf of the Life Sciences Program, Dr. Tom Scott a Senior Scientist for NASA, proposed the initiation of a cooperative assembly of partner agencies interested in an exchange of ideas among plant researchers on an international level. Because this area of research is noncontroversial and well focused, it is thought that it will meet with success. NASA proposed this to DARA first because of the German agency's extensive interest and experience in the area of plant gravitational biology.

- **Data Archive Status and Plans**

Dr. White briefed the delegations on the uses and status of the Data Archive and Spaceline (Enclosure 10). He invited DARA and the German scientific community to contribute to and access the Archive when it is open for public use in late 1995. Dr. White also called on DARA to be responsible for putting together CD-ROMs of Life Sciences missions that they take the lead for and to make them available in the Data Archive.

- **Cardiolab**

Dr. Ruyters gave a presentation on Cardiolab, a cardiovascular research facility jointly being developed by DARA and CNES for use aboard ISSA (Enclosure 11). He indicated that DARA may be interested in having Cardiolab implemented into NASA's Human Research Facility (HRF). (A NASA working group will define what types of equipment will be going into racks of the HRF.)

- **Closing Discussion**

The 12th Joint NASA/DARA-DLR Life Sciences Program Working Group Meeting concluded with a review of the general action items, and an overall summary of the meeting was given by Dr. White. Members of both delegations commented on the amiable and productive work environment. The meeting was then adjourned.

General Action Items :

1. DARA is developing a calendar of Life Sciences activities which will list technology and science breakthroughs. DARA will send a copy to NASA. (DARA)
2. Provide to DARA one pagers detailing NASA Life Sciences Earth benefits. (NASA)
3. It was proposed that DARA organize a review of their Radiation SCORT some time in the next year. This will be a topic for discussion at the next NASA/DARA meeting. (DARA-DLR)
4. Dr. Ruyters asked whether the list of hardware available from ESA and CNES for use on MIR included a list of German hardware as well. Drs. White and Schneider will look into this. (NASA)
5. With respect to MIR '96, it has been proposed by DARA that a German astronaut return from MIR on a U.S. shuttle. Dr. White suggested that DARA think about how it wants to phrase the formal invitation to NASA. Subsequently, NASA will take the proposal into account. (DARA, NASA)
6. Dr. Schneider will provide a list of U.S. hardware that may go to MIR for use by German scientists. (NASA)
7. NASA will prepare the necessary paperwork to include German hardware in the next NRA. (NASA)
8. Mr. Souza will provide a template of dates for reviews and other milestones to enable DARA to assess the feasibility of the CEBAS minimodule being delivered for a precursor flight in 1997. (NASA)
9. Develop a proposal for DARA inviting its participation in the development of an International Plant Space Research Plan. (NASA)
10. Jointly examine the possibility of putting the underutilized NIZEMI into a configuration with the Gravitational Biology Facility (GBF). (NASA, DARA)
11. Provide to NASA a description of the planned hardware elements that will go into Cardiolab. (DARA)

ENCLOSURE # 1

**12th Joint NASA/DARA-DLR
LIFE SCIENCES WORKING GROUP MEETING
Ames Research Center
Moffett Field, California
October 26-27, 1994**

AGENDA

Wednesday, October 26

9:00 am	Welcome and Introductory Remarks • Discussion of Agenda • Review of Minutes/Action Items	NASA/DARA
9:15	Status Report: German Life Sciences	DARA
9:45	Status Report: NASA Life Sciences	NASA
10:15	Coffee Break	
10:30	Centers of Excellence Session • Radiation Health - Directors' Reports • Integrated Physiology - Overview	DARA/NASA NASA
12:30 pm	Lunch	
2:00	Overview of Research and Facilities at Ames Research Center	NASA
5:00	Adjourn	
6:00	Dinner	

Thursday, October 27

9:00 am	Plenary Session Flight Activities	
	• Neurolab	NASA
	• Shuttle/MIR Program	NASA
	• MIR '96 Mission	DARA
	• "New" Spacelab Mission	NASA
	• Small Payloads Hardware Status	NASA/DARA
10:30	Coffee Break	
10:45	Plenary Session (continued)	
	• CO ₂ Study at DLR	NASA/DARA
	• Human Factors	NASA/DARA
	• International Plant Space Research Plan	NASA
	• Data Archive Status and Plans	NASA
12:00 pm	Closing Discussion and Actions	DARA/NASA
1:00	Adjourn/Lunch	

ENCLOSURE # 2

RESEARCH UNDER SPACE CONDITIONS

LIFE SCIENCES

12th Joint NASA/DARA-DLR LSWG

DARA *Life Sciences*

Organisation 27.05.1994

ORIGINAL PAGE IS OF POOR QUALITY

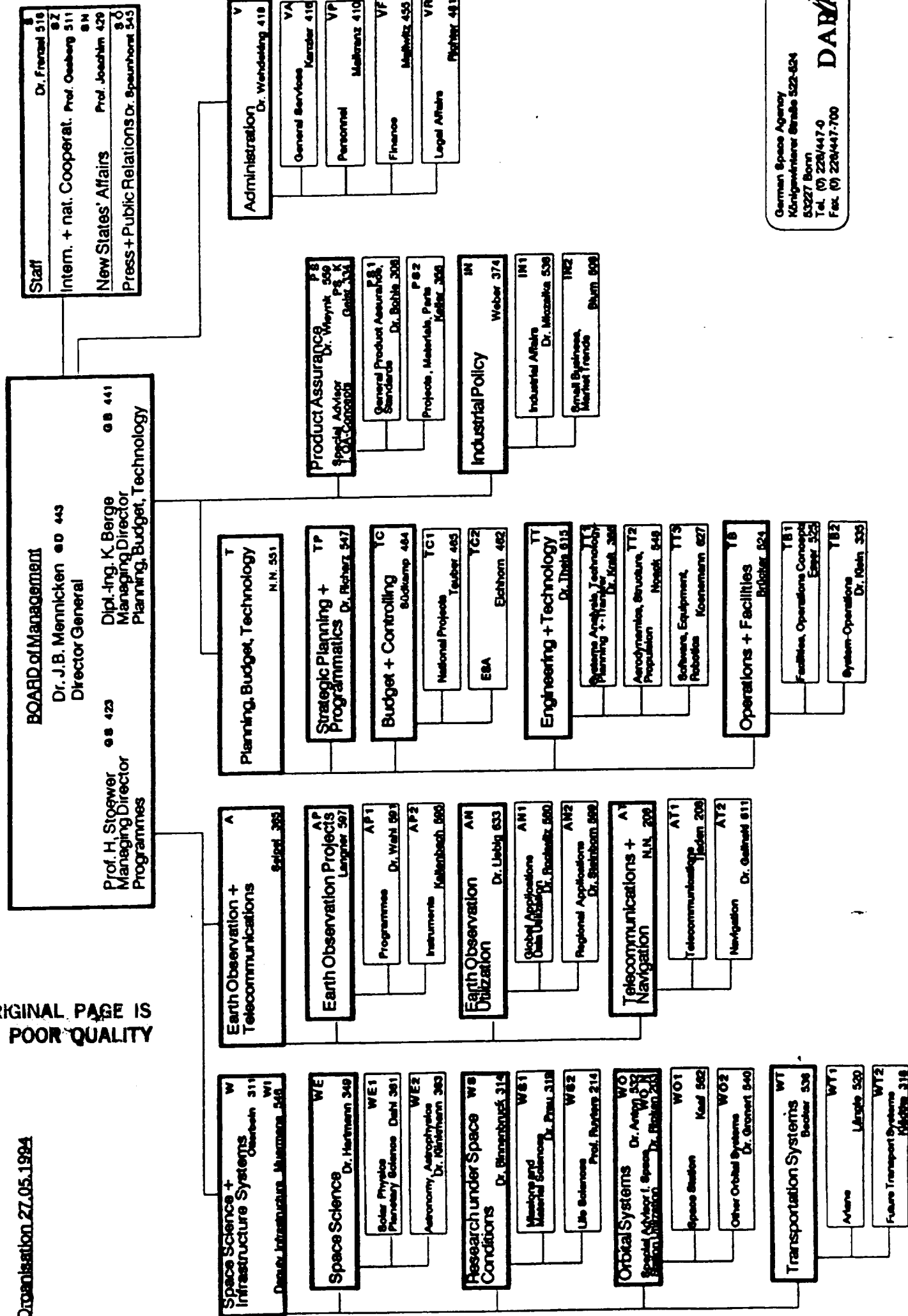

German Space Agency
 Königswinterer Straße 522-524
 53227 Bonn
 Tel. (0) 228/447-0
 Fax (0) 228/447-700

DLR

and: 21.06.1994
:aureforg 13091.gem

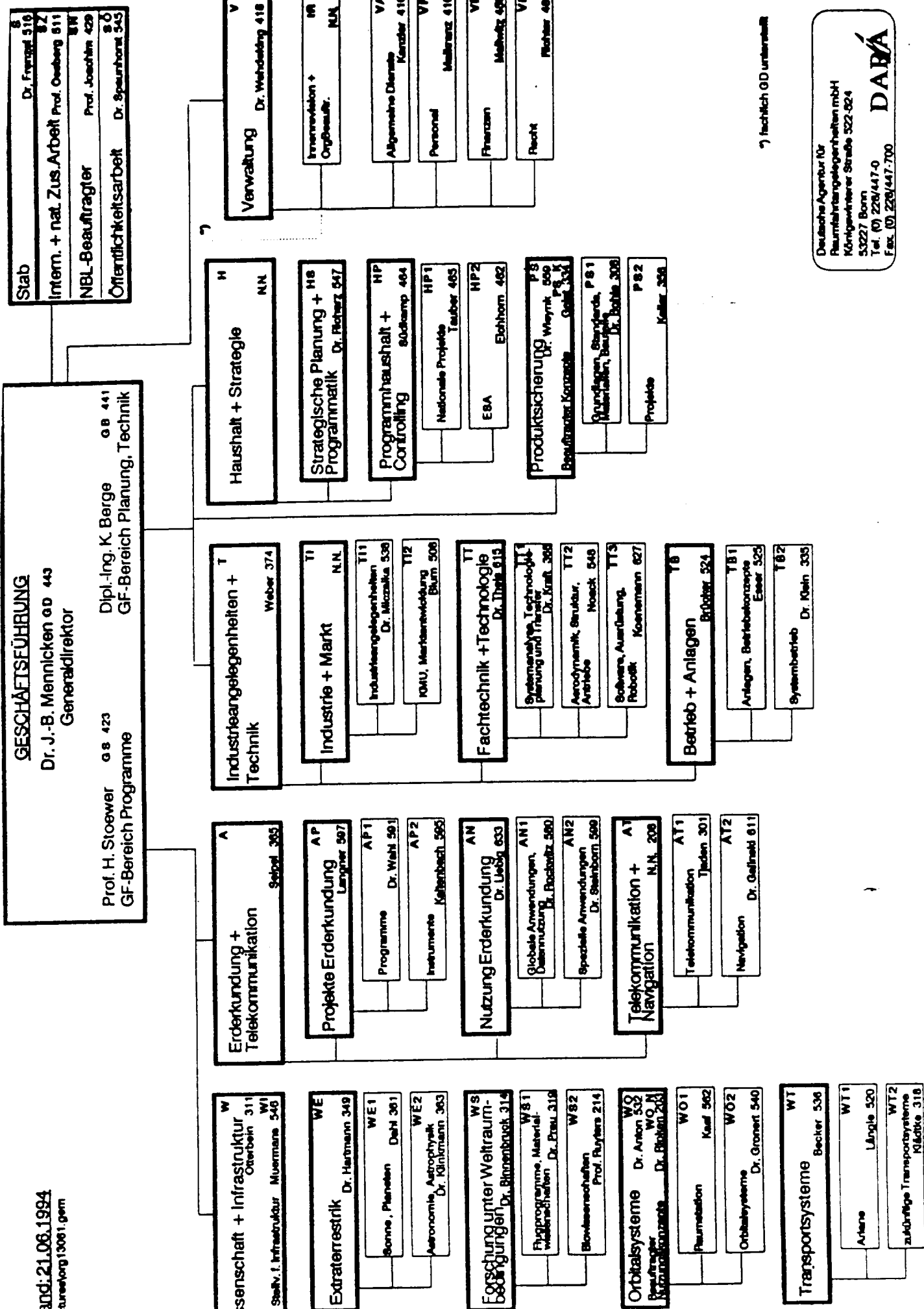

*) fachlich GD unterstellt

Deutsche Agentur für
 Raumfahrtangelegenheiten mbH
 Königswinterer Straße 522-524
 53227 Bonn
 Tel. (0) 228/447-0
 Fax. (0) 228/447-700

DARA

**Section
Life Sciences
Prof. Dr. G. Ruyters**

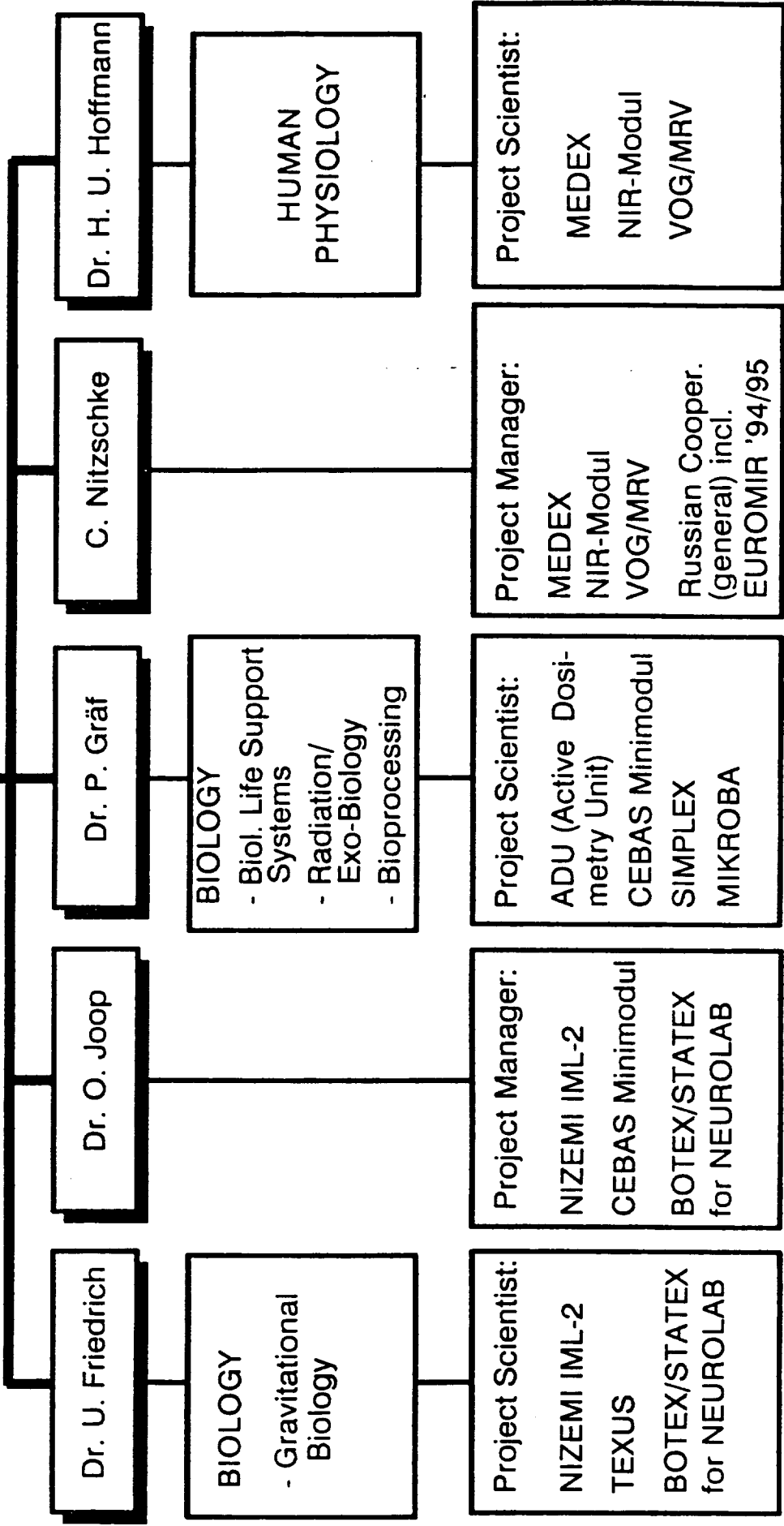

FLIGHT EXPERIMENTS IN LIFE SCIENCES

(100% = 195 experiments; 1972 - 10/1994)

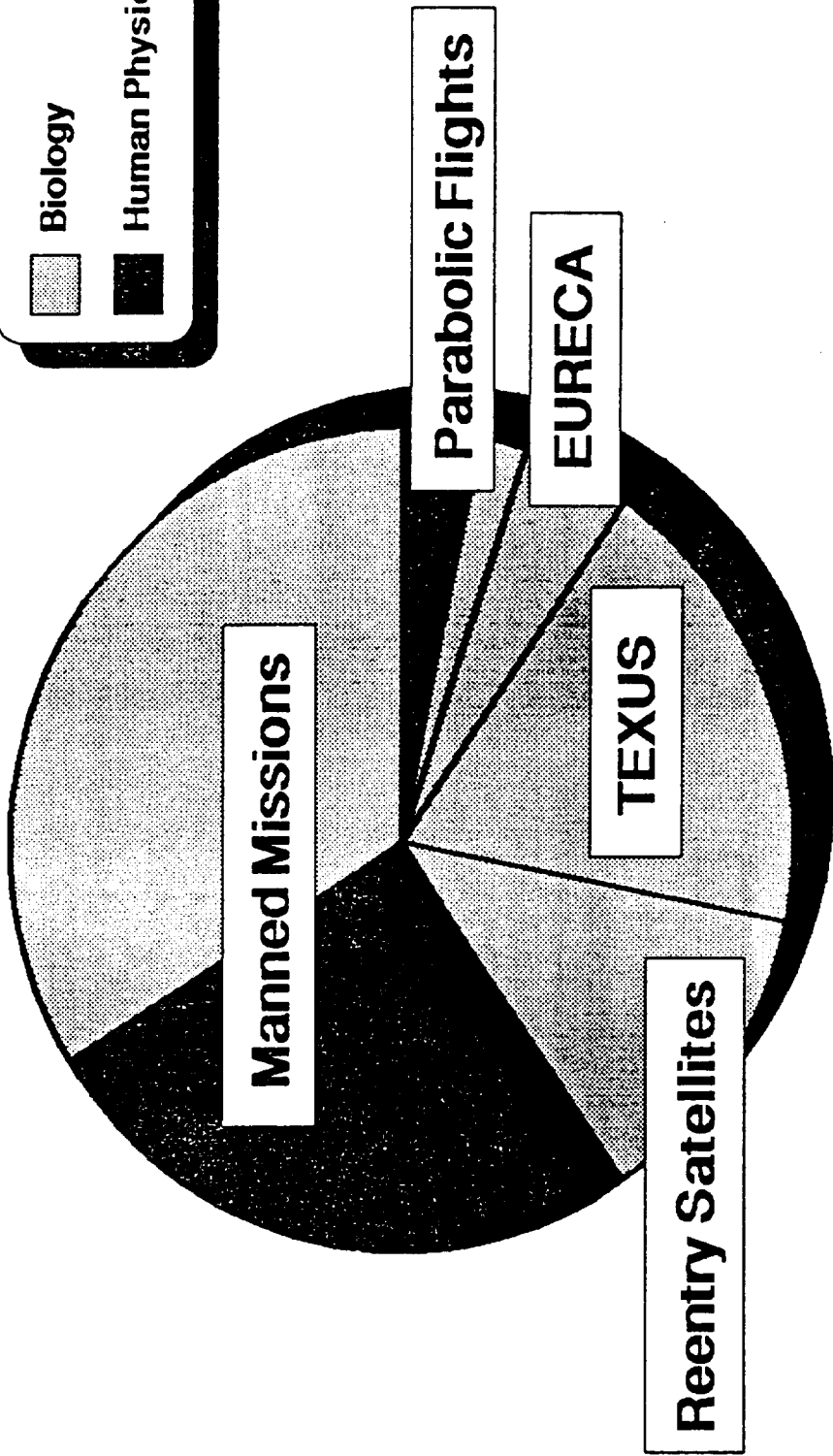
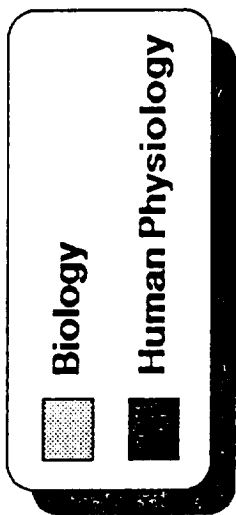

Life Sciences - Program Structure

BIOLOGY

Gravitational Biology

Biological Life
Support Systems

Radiation Biology

Exobiology

Bioprocessing
Techniques

HUMAN PHYSIOLOGY

Cardiovascular
System

Neurophysiology

Musculoskeletal
System

Endocrinology and
Metabolism

Operational
Medicine

RESEARCH AREAS

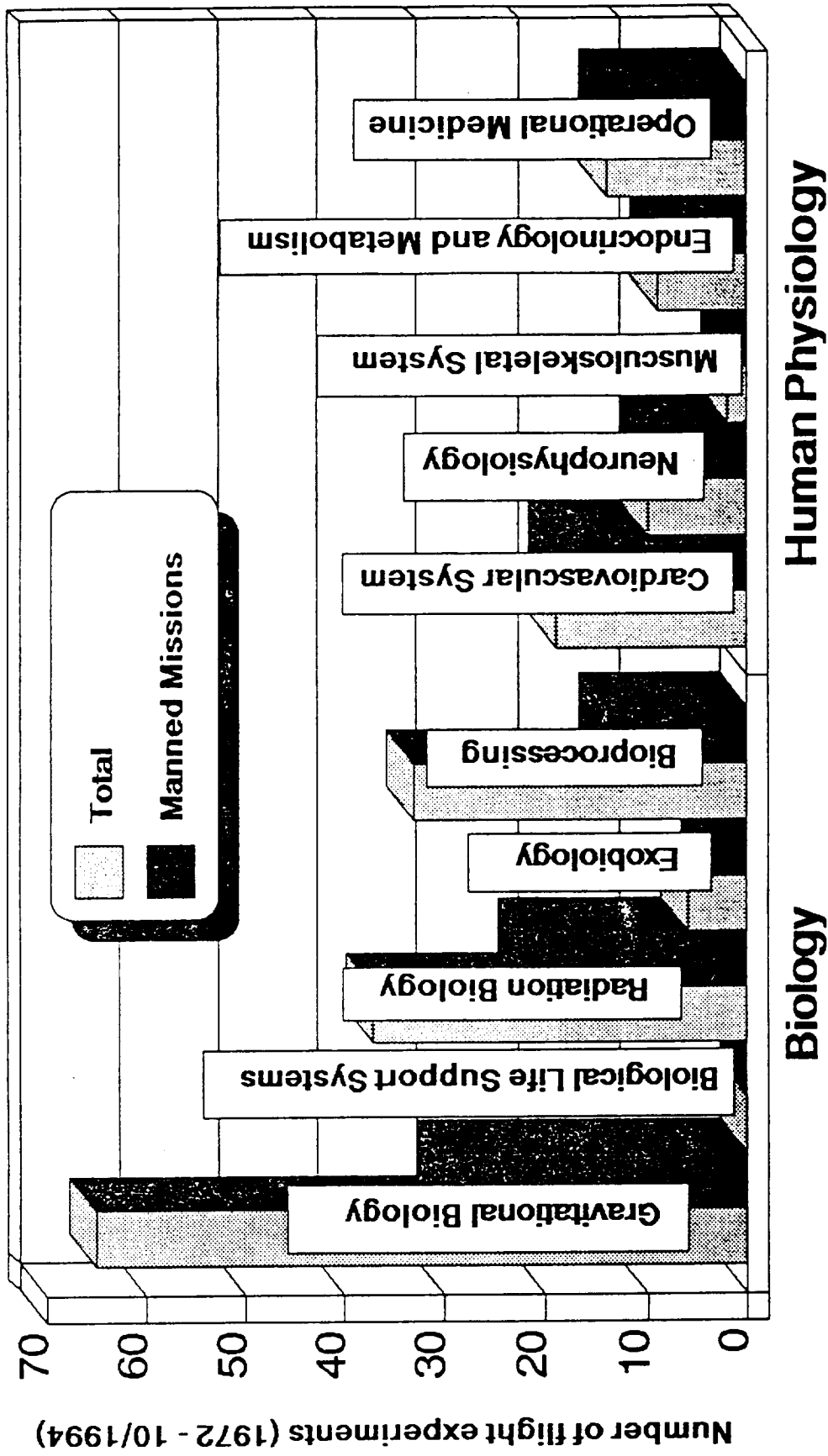

Flight Experiments in Life Sciences

(1972 - 10/1994)

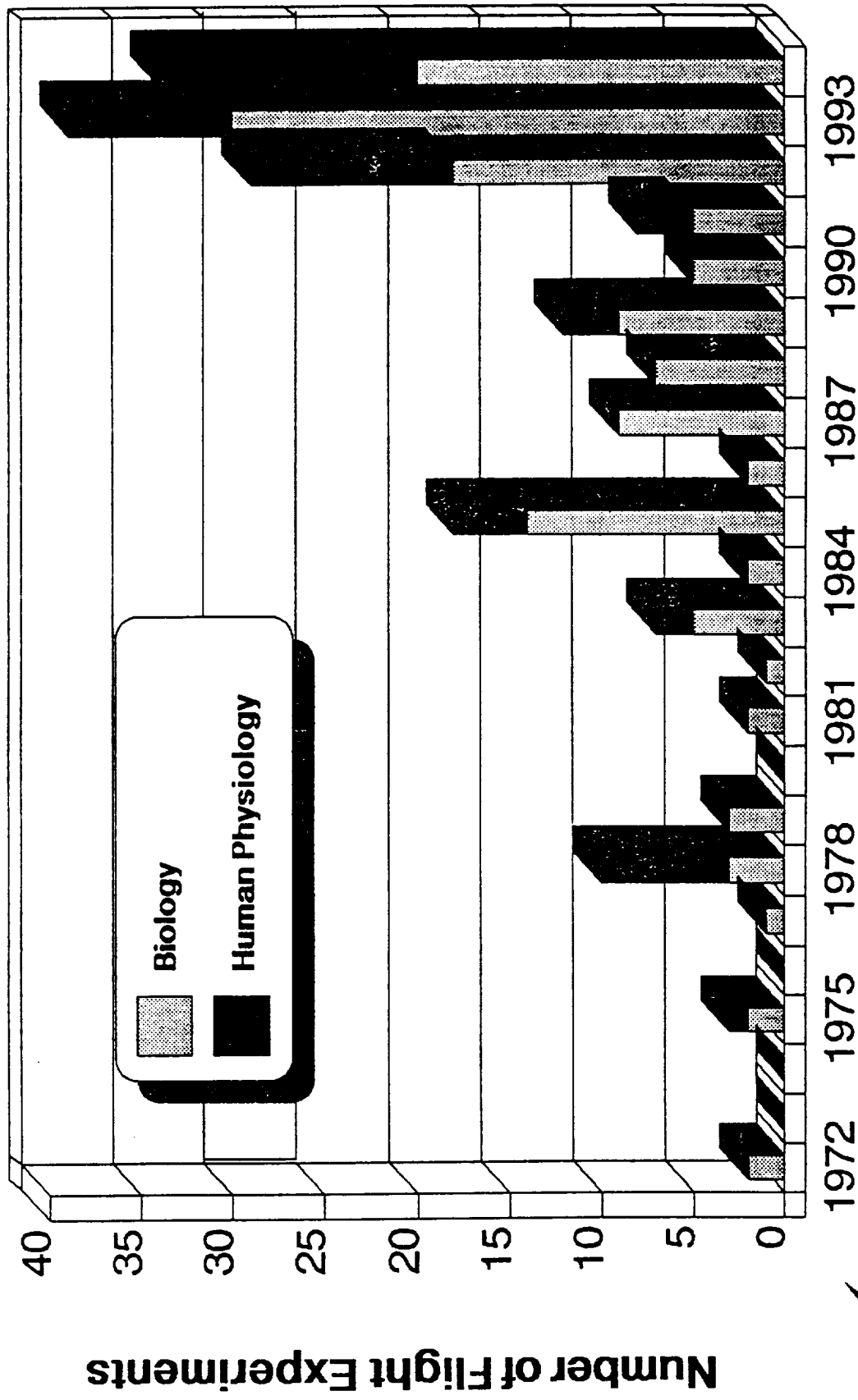

DABA

Missions with German Participation

Jan '92 - Jul '94

Jan '92	IML-1
Mar '92	MIR '92
Jul '92	EURECA Launch
Nov '92	TEXUS 29
Dec '92	BION 10
Apr '93	D-2
May '93	TEXUS 30
Jul '93	EURECA Retrieval
Jan/Apr '94	MIR '92 Extension
May '94	TEXUS 32
Jul '94	IML-2

in addition, participation in parabolic flights (NASA, KSC-135) and Drop Tower (Bremen) experiments

August 1994

Flight Experiments In Life Sciences (cont.)

TEXUS 32 (05.05.94)

H. Schnabl (Univ. Bonn):

Protein Pattern in Mesophyll Protoplasts of *Vicia Faba*.

R. Hampf (Univ. Tübingen):

Effect of Changes in Gravitation on Energy Metabolism of Plant Cells

FOTON 9 (14.06. - 02.07.94)

G. Reitz (DLR Cologne):

Relative Contributions of Individual Components of the Cosmic Radiation Spectrum and Effectiveness of Shield Rug

G. Horneck (DLR Cologne):

Exposure of Bacteria and Isolated DNA to Solar UV to Study Limits of Survival and Concepts for Organisms on Meteorites

PARABOLIC FLIGHTS

19th ESA Campaign (July '94)

E. Igenbergs (Univ. Munich):

Test of the Munich Space Chair

20th ESA Campaign (Oct. '94)

T. Probst (Univ. Düsseldorf):

Human Vestibularly Evoked Scalp Potentials from the Vertical Semi-circular Canals without Otolithic Contamination

The logo for DARA (Deutscher Aerospace Research Agency) is displayed in a stylized, italicized font. The letters 'D', 'A', and 'R' are larger and more prominent, with the 'A' being particularly tall and narrow. The 'A' has a diagonal slash through it. The letters are black and set against a white background.

PARTICIPATION OF GERMANY IN IML-2

TEMPUS	DARA	Electromagnetic Containerless Processing Facility	Egry Fecht Herlach Urban
BDPU	ESA	Bubble Drop and Particle Unit	Langbein Straub Klein
CPF	ESA	Critical Point Facility	Hamacher
QSAM	DARA/DLR	Quasi-Steady Accelerometer Measurement	

APCF	ESA	Advanced Protein Crystallization Facility	Erdmann Wagner Yonath
NIZEMI	DARA	Slow-Rotating Centrifuge With Microscope	Block Häder Hemmersbach-K. Leonartz Sievers Volkmann
BIOSTACK	DARA/DLR	Radiation Biology	Reitz
BIORACK	ESA	Molecular, Cell and Radiation Biology	Heinlein Horneck Reitz

DARA

GN-WS 2

NIZEMI on IML-2

Graphik: Friedrich
Stand: Oktober 1994
Code:iml-bett.gem

NIZEMI Experiments on IML-2

CHARA	Ni-10	A. Sievers (Bonn)	Experiments on Gravireaction in Chara in Microgravity and on Earth
CRESSROOTS	Ni-11	D. Volkmann (Bonn)	Gravisensitivity of Cress Roots
EUGLENA	Ni-01	D.P. Häder (Erlangen)	Graviorientation in Flagellates
JELLYFISH	Ni-13	D. Spangenberg (Norfolk)	Effects of Microgravity on Aurelia Ephyra Behavior and Development
LOXODES	Ni-07	R. Hemmersbach-Krause (Köln)	Influence of Accelerations on the Spatial Orientation of the Protozoon Loxodes striatus
MONI	Ni-09	K. Leonartz (Aachen)	Convective Stability of a Planar Solidification Front
MOTION	Ni-12	A. Cogoli (Zürich)	Lymphocyte Movements and Interactions (ESA experiment)
SLIMEMOLD	Ni-09	I. Block (Köln)	Gravisensitivity and Geo(gravi)taxis of the Slime Mold Physarum polyc.

DARA
GN-WS

NIZEMI on IML-2



German Life Science Experiments on IML-2 (without NIZEMI)

Radiation Biology (Biostack and Biorack)

- Reitz, G. (DLR Cologne): Biostack
- Reitz, G. (DLR Cologne): Dosimetric Mapping inside Biorack on IML-2
- Horneck, G. (DLR Cologne): Efficiency of Radiation Repair in Prokaryotes
- Horneck, G. (DLR Cologne): Radiation Repair Kinetics in Eukaryotes

Cell Biology (Biorack)

Heinlein, U.A.O. (Univ. Düsseldorf): Molecular Biological Investigations of Reconstituted Multi-cell Aggregates

Protein Crystallization (APCF)

- Wagner, G. (Univ. Gießen): Crystallization of Small Receptor Molecules - Archaeobacterial Rhodopsin and Plant Calmodulin
- Yonath, A. (MPI Hamburg): Crystallization of Intact Ribosomal Particles
- Erdmann, V.A. (Freie Univ. Berlin): Crystallization of Ribosomal 5S RNA

DARA

GN-WS 2

IML-2

Graphik: Friedrich
Stand: Oktober 1994
Code: iml-bet2.gem

**RESEARCH UNDER SPACE CONDITIONS - LIFE SCIENCES
- PLANNED FLIGHT EXPERIMENTS -**

MIR '92-E: (Jan-April '94)	4 experiments in Human Physiology
TEXUS 32 (May '94)	2 experiments in Gravitational Biology
IML-2: (June '94)	6 experiments in Gravitational Biology (DARA NIZEMI)
	3 experiments in Radiation Biology (ESA Biorack, DLR Biostack)
	3 experiments in Bioprocessing (protein crystallization in ESA APCF)
EUROMIR '94: (Oct. '94)	9 experiments in Human Physiology 2 experiments in Radiation Biology
EUROMIR '95: (Aug-Dec '95)	4 experiments in Human Physiology 2 experiments in Radiation Biology
SLS-4 NEUROLAB: (Mar '98)	1 experiment in Human Physiology 2 experiments in Gravitational Biology

In addition, experiments are planned or under consideration in cooperation with NASA in the Shuttle middeck (Small Payload Program) or Spacelab, in cooperation with CNES on MIR (e.g. the French Russian Cassiopée mission in 1996). Also, the Bremen Drop Tower, the TEXUS Sounding Rocket Program and Russian Reentry Satellites will be utilized for realizing the goals of the LIFE SCIENCES PROGRAM.



RESEARCH AREAS

Number of projects (DARA funded + DLR; Status May 1994)

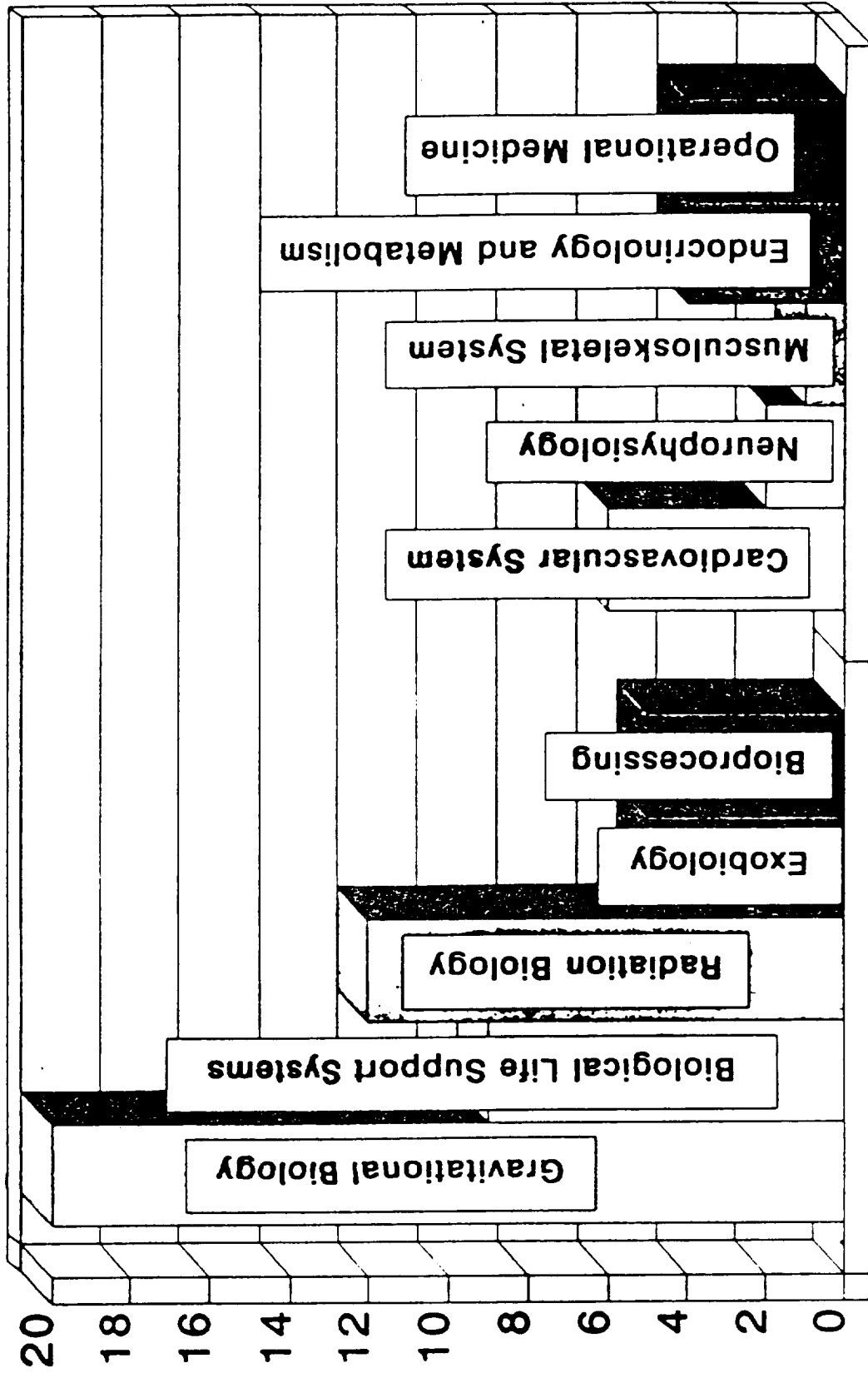

Biology

Human Physiology

DARA

German H/W Planning for Space Station - Human Physiology -

Status

MEDEX

use of components during MIR '92
lab model available

Planning

development for use on MIR from
1995 and on SLS-4 (1997)

follow-on development in cooperation
with CNES to a combined PHYSIOLAB/
MEDEX for space station

VOG/MRV

use of VOG during MIR '92, MIR '92 E,
EURO MIR '94

development for use on SLS-4 (1997)
as well as for space station

ADOSI

phase B study;
lab model available

development for use on any flight
opportunity

DABA

German H/W Planning for Space Station

- Biology -

	Status	Planning
NIZEMI	available (IML - 2)	utilization offered for Shuttle-Mir missions and SLS-4 follow-on development to SS-NIZEMI in addition to ESA-BIOLAB from 2000
CEBAS	minimodule in phase B, C/D from mid'94	utilization offered for SLS-4 and NASA Small Payload Program follow-on development to SS-CEBAS not before 2001
SIMPLEX	phase C/D until mid '94	utilization offered for NASA Small Payload Program
in addition: BIOLABOR components (e.g. threshold centrifuge, incubators, workbench)	available	offered for use on Shuttle-MIR missions

DARÁ

Program Support - Present Activities (May '94) -

1. Center of Excellence

- o BIOLOGY
 - Gravitational Biology
 - Bioreg. Life Support Systems
 - Radiation Biology
 - o HUMAN PHYSIOLOGY
 - Human Physiology /Operational Medicine
- AGRAVIS (Univ. Bonn)
CEBAS (Univ. Bochum)
SCORT Radiation Health (Univ. Gießen)
- Inst. for Aerospace Medicine, DLR Cologne

2. New H/W development

- o BIOLOGY
 - Gravitational Biology
 - Bioreg. Life Support Systems
 - Radiation Biology
 - o HUMAN PHYSIOLOGY
- BIOM AUS (plant growth unit based on the GAS concept)
NIZEMI - slow rotation centrifuge microscope
SIMPLEX (middeck incubator with 1g reference centrifuge)
CEBAS Minimodule
ADU (Active Dosimetry Unit)
MEDEX (Human Physiology Data Acquisition Center)
MRV (Multifactoral stimulatory system for study of vestibular system) for VOG
NIR-Module (Non-invasive near-infrared diagnostics)

DARA

Summary: Strategy of German Space Life Sciences Research

Scientific Program: Concentrate on specific areas and on critical questions

Program Support: Establish "Centers of Excellence" in focal areas

Develop H/W for research in focal areas -
If possible, in cooperation with partner agencies

Flight Program: Utilize flight opportunities according to scientific needs and in
cooperation with partner agencies

DARA

**Exemplary results of basic and applied research:
Spin-offs within the program LIFE SCIENCES**

Science

**In the field of vestibular physiology:
new concepts on the mechanisms of the caloric nystagmus and the
vestibulo-ocular reflex;
important for development of diagnosis and therapy of balance diseases**

**In the field of cardiovascular function:
new ideas on the regulatory principles of fluid distribution;
important for shock and trauma therapy, post-operational treatment and
oedema prevention**

**In the field of bone and muscle physiology:
new understanding of turnover regulation
important for therapy of muscle atrophy and osteoporosis**

**In the field of cell biology:
demonstration of gravity effects on single cells;
important for the understanding of immune system function and
demineralization processes in the bone**

**essential improvements for the understanding of signal -transduction -
chains by new results about the role of the cytoskeleton**

**In the field of hormone system physiology:
elucidation of the role of the peptide hormone urodilatin for regulation of
water and mineral excretion;
important for post-operational renal function stabilization**

**In the field of radiation protection:
dosimetric detection of cosmic radiation and elucidation of the effects on
organisms**

DARA

**Exemplary results of basic and applied research:
Spin-offs within the program LIFE SCIENCES**

Technology

**Tissue thickness and tissue compliance measurement system:
already in research and clinical application; surveillance of oedema
disposition ; oedema prevention in high altitude working personal**

**Self-tonometer for quick-look intraocular pressure monitoring e.g. in
glaucoma patients:
ready for industrial production**

**Mobile impedance cardiograph for monitoring basic cardiovascular
parameters:
important in pre-operational preparation; diagnosis in labour-, social-, and
sports-medicine**

**Mobile vestibular laboratory:
application for diagnosis of orientational and vestibular dysfunction**

**Carbondioxid-absorption with lithiumhydroxid:
developed for space station , application in submarines, isolation
environments etc.**

**Oxygen sensor for monitoring environmental air concentration:
developed for space station , application in submarines, isolation
environments etc.**

DARA

Nationales Förderprogramm 1993 - 1997

Aufteilung der Mittel auf die Programme

Gesamtmittel: 1.648 Mio DM

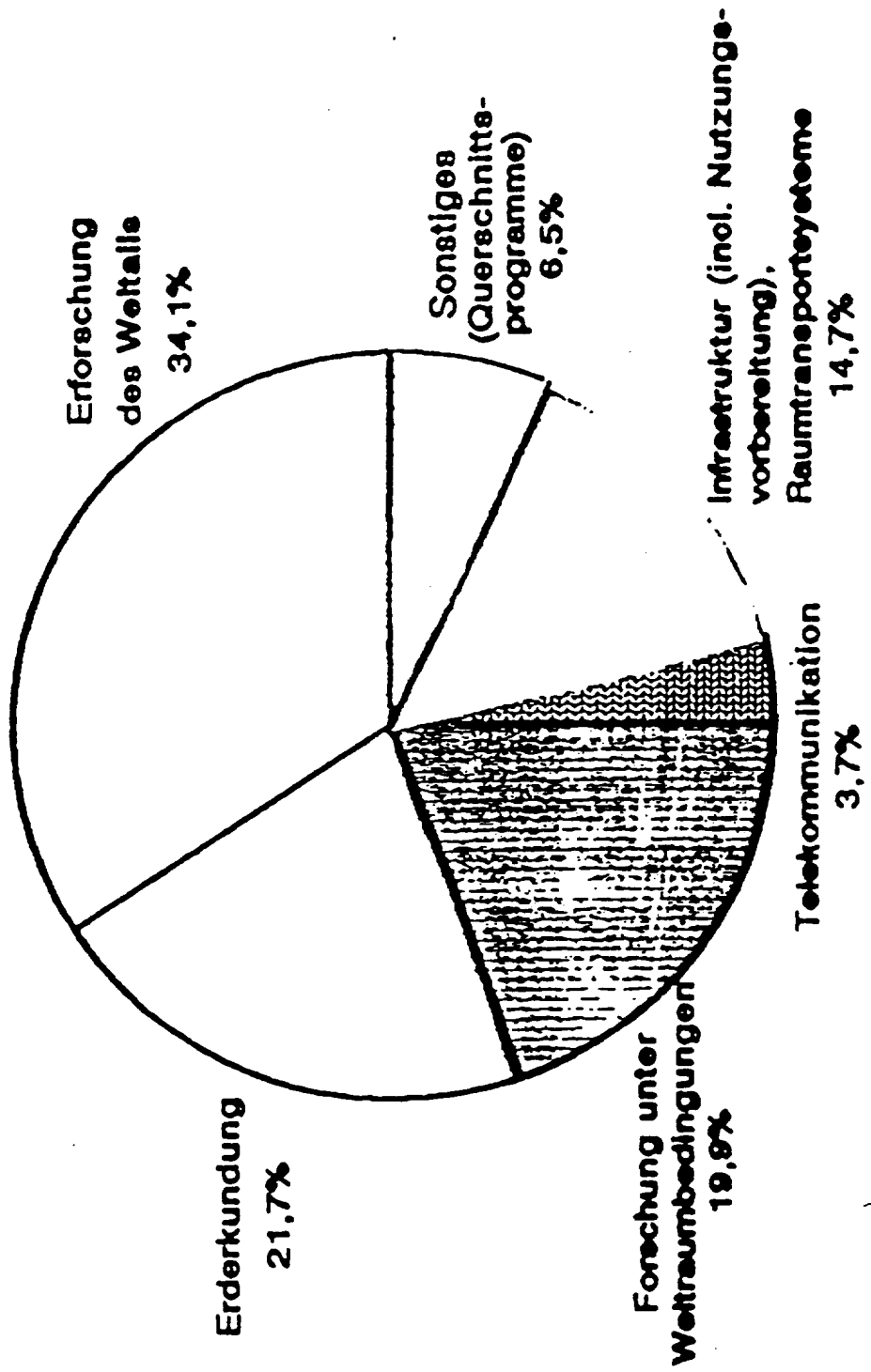

DARA

Deutsche ESA-Beiträge 1993 - 1997

Aufteilung der Mittel auf die Programme

Deutsche ESA-Beiträge *): 6.747 Mio DM

(Kurs 1 RE = 2,05 DM)

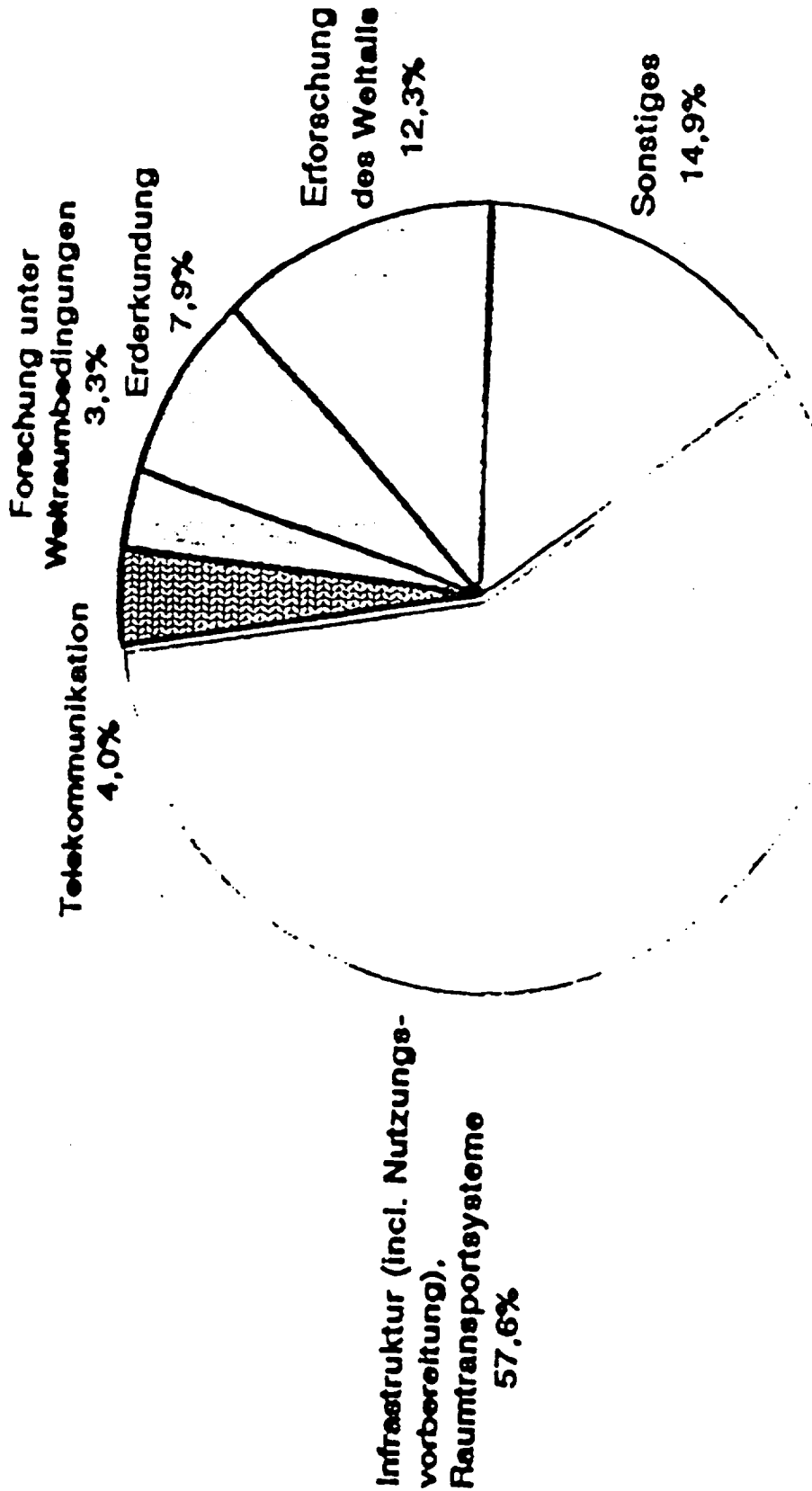

DABA *) ohne "neue" Programme, incl. Verpflichtungen aus Vorjahren

ORIGINAL PAGE IS OF POOR QUALITY

Nationales Förderprogramm und Deutsche ESA-Beiträge 1993 - 1997

Aufteilung der Mittel auf die Programme

Nationales Förderprogramm: 1.648
 Deutsche ESA-Beiträge *): 6.747
 Gesamt 8.395

(In Mio DM; Kurs 1 RE = 2.05 DM)

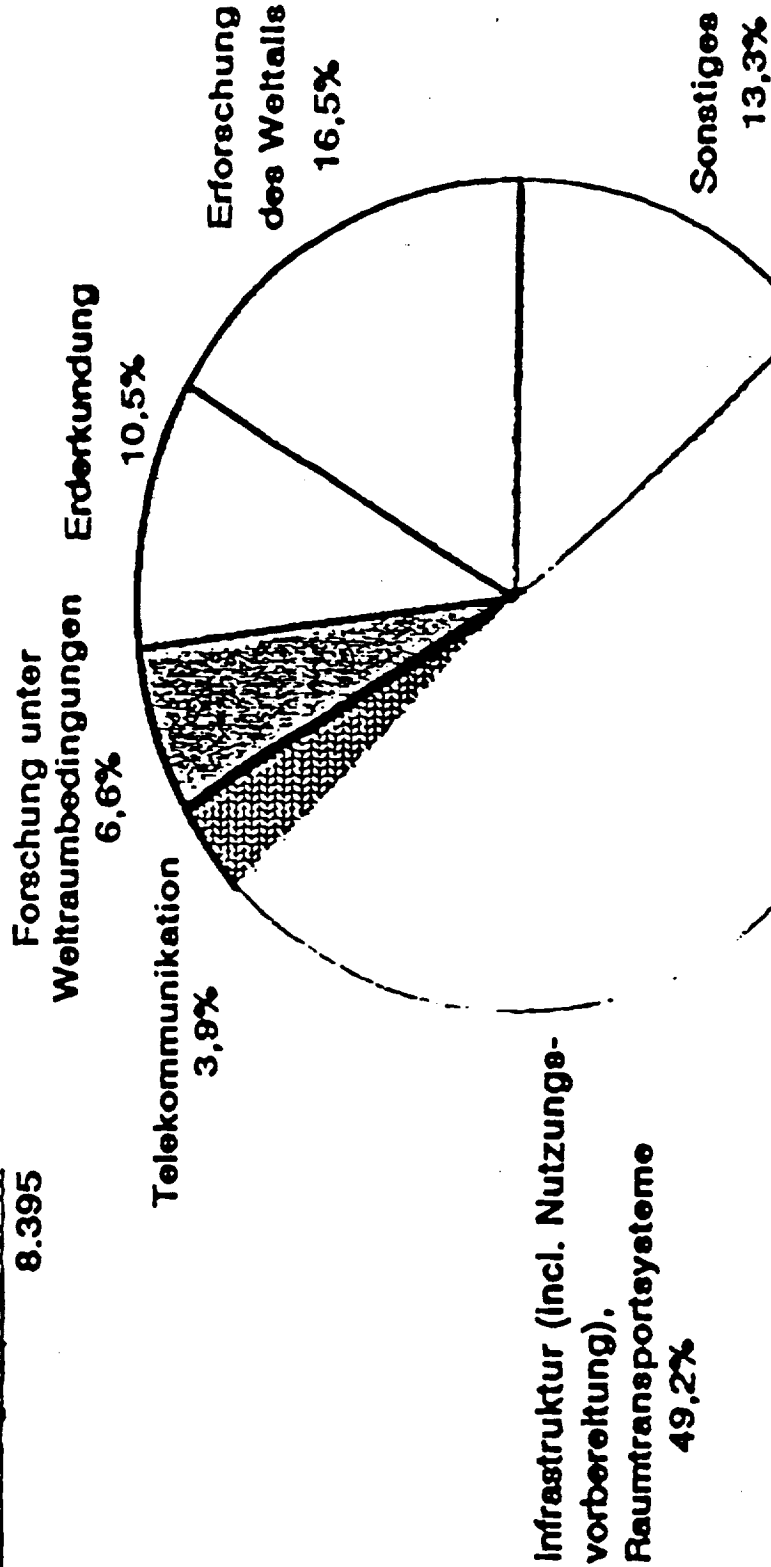

*) ohne 'neue' Programme, incl. Verpflichtungen aus den Vorjahren

DARA

Forschung unter Weltraumbedingungen

Datum: 12.04.1994
Stand: 12.04.1994

Programmplanung auf Basis der Haushaltsaufstellung 1995 GS-Baseline

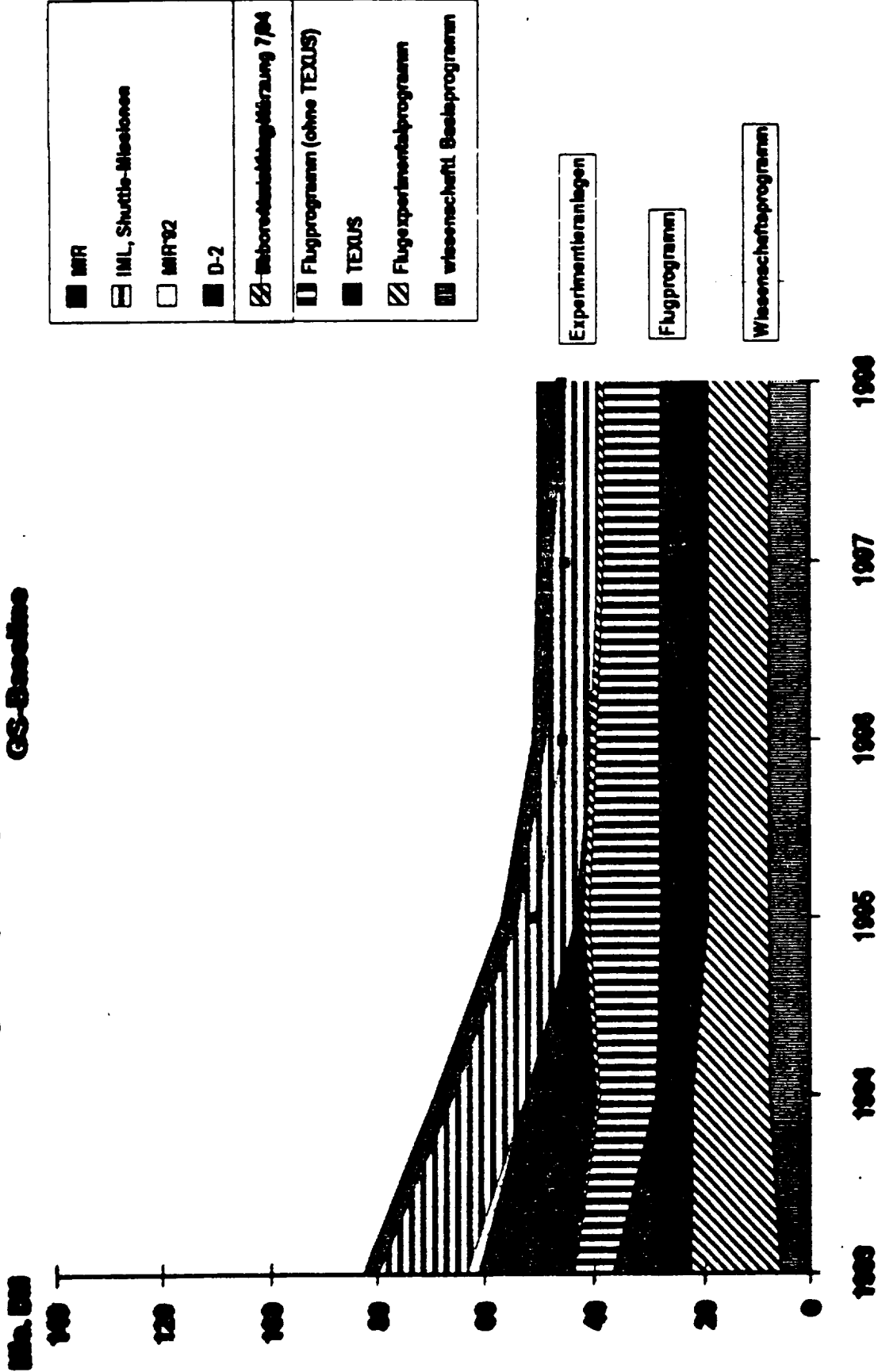

■	MIR
▨	IML, Shuttle-Missionen
□	MIR92
■	D-2
▨	Stabunterstützung 7/84
▨	Flugprogramm (ohne TEXUS)
■	TEXUS
▨	Flugexperimentprogramm
▨	wissenschaftl. Belegprogramm

Experimentieranlagen

Flugprogramm

Wissenschaftsprogramm

MARKT/BOEC

ENCLOSURE # 3

National Aeronautics And Space Administration

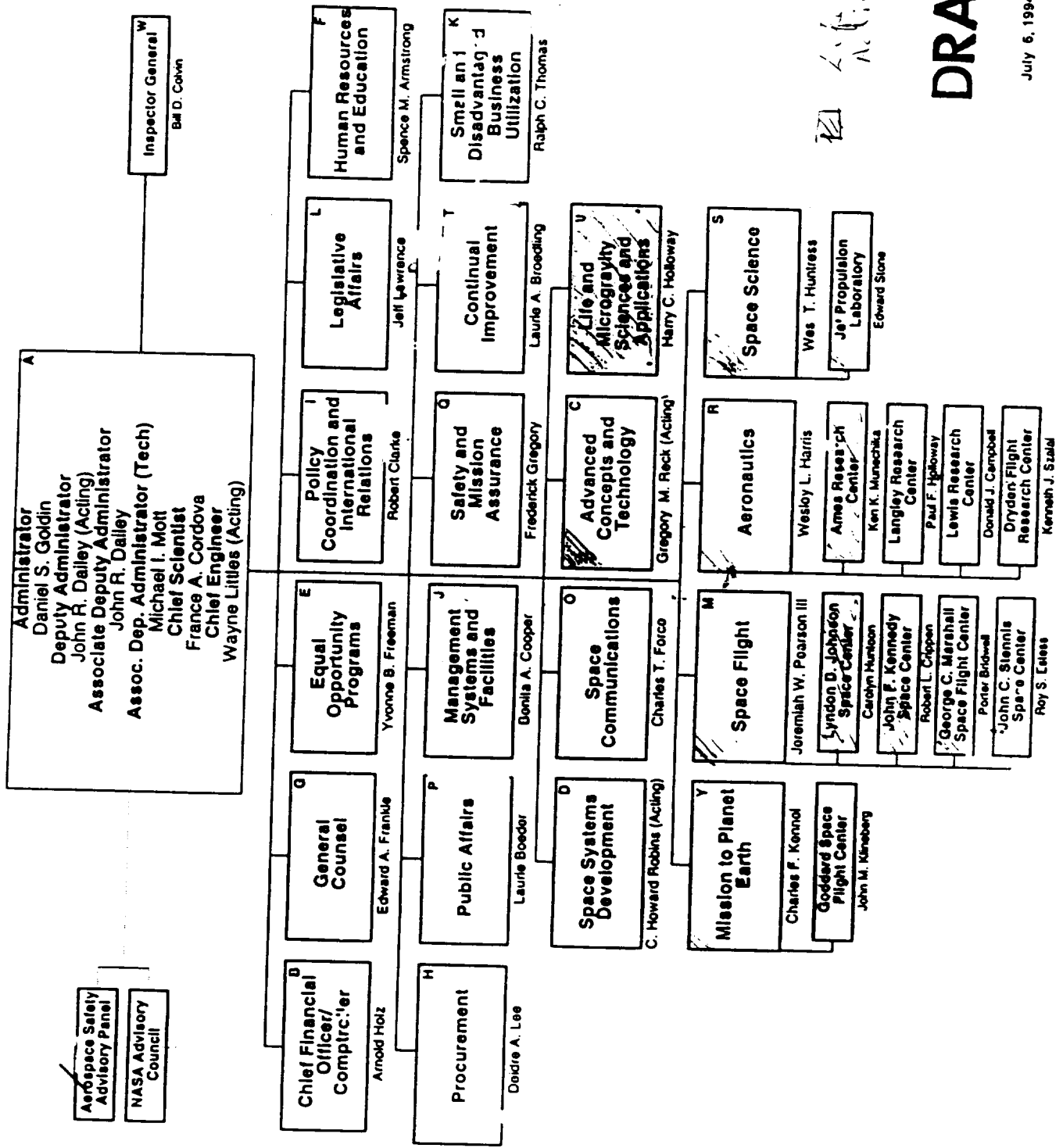

SECRET
AUG 1994

DRAFT

July 6, 1994

12TH JOINT NASA/DARA-DLR
LIFE SCIENCES WORKING GROUP MEETING
AMES RESEARCH CENTER
MOFFETT FIELD, CA



OCTOBER 26-27, 1994

Joan Vernikos, Ph.D.
Director, Life and Biomedical Sciences
and Applications Division



NASA HEADQUARTERS OFFICE OF LIFE AND MICROGRAVITY SCIENCES AND APPLICATIONS

Office of Life and
Microgravity
Sciences and
Applications
(OLMSA)

**SPECIAL ASSISTANT FOR
PROGRAMS & STRATEGIC PLANNING**
Dr. B. Dunbar

**SPECIAL ASSISTANT FOR
RESEARCH & OPERATIONS POLICY**
Dr. E. Ferguson

ASSOCIATE ADMINISTRATOR
Dr. H. Holloway

**DEPUTY ASSOCIATE ADMINISTRATOR
FOR OPERATIONS & SPACE FLIGHT**
Dr. A. Nicogossian

**DEPUTY ASSOCIATE ADMINISTRATOR
FOR PROGRAMS**
Vacant

Policy
Vision
Values
Goals
Strategy
Planning
Budget
Advocacy

External relations:
—OMB, Congress
—Interagency, International
—Universities, Industry
Flight Program Policy,
Review, Assessment
Liaison with Supporting
Codes

POLICY AND PROGRAM MANAGEMENT
Mr. S. Fogleman

Chief of Staff
Policy and Planning
Resource & Program Integration
Management Operations
Continuous Quality Improvement

**LIFE AND BIOMEDICAL
SCIENCES AND APPLICATIONS**
Dr. J. Vernkos

Biology
Biomedical
Human Factors/Psychology
Environmental Health
Life Support (EVA/IVA)
Applications & Technology
Flight Experiments & Facility Dev.

**MICROGRAVITY SCIENCES
AND APPLICATIONS**
Mr. R. Rhome

Material Sciences R & T
Biotechnology
Applications & Technology
Fluids and Combustion
Flight Experiments & Facility Dev.

**FLIGHT
SYSTEMS**
Dr. E. Reeves

Payload Mission Management
for STS, Spacelab, & Planning
for Space Station
Systems Engineering Support
System and Instrument Dev.
Support

**OCCUPATIONAL HEALTH
AND AEROSPACE MEDICINE**
Dr. M. Levine

Occupational & Environmental Health
Aviation Medicine
Space Flight Medicine
Employee Preventive Health Program
Acute Injury & Illness Program
Employee Assistance Program
Worker's Compensation Program

LIFE AND BIOMEDICAL SCIENCES AND APPLICATIONS DIVISION

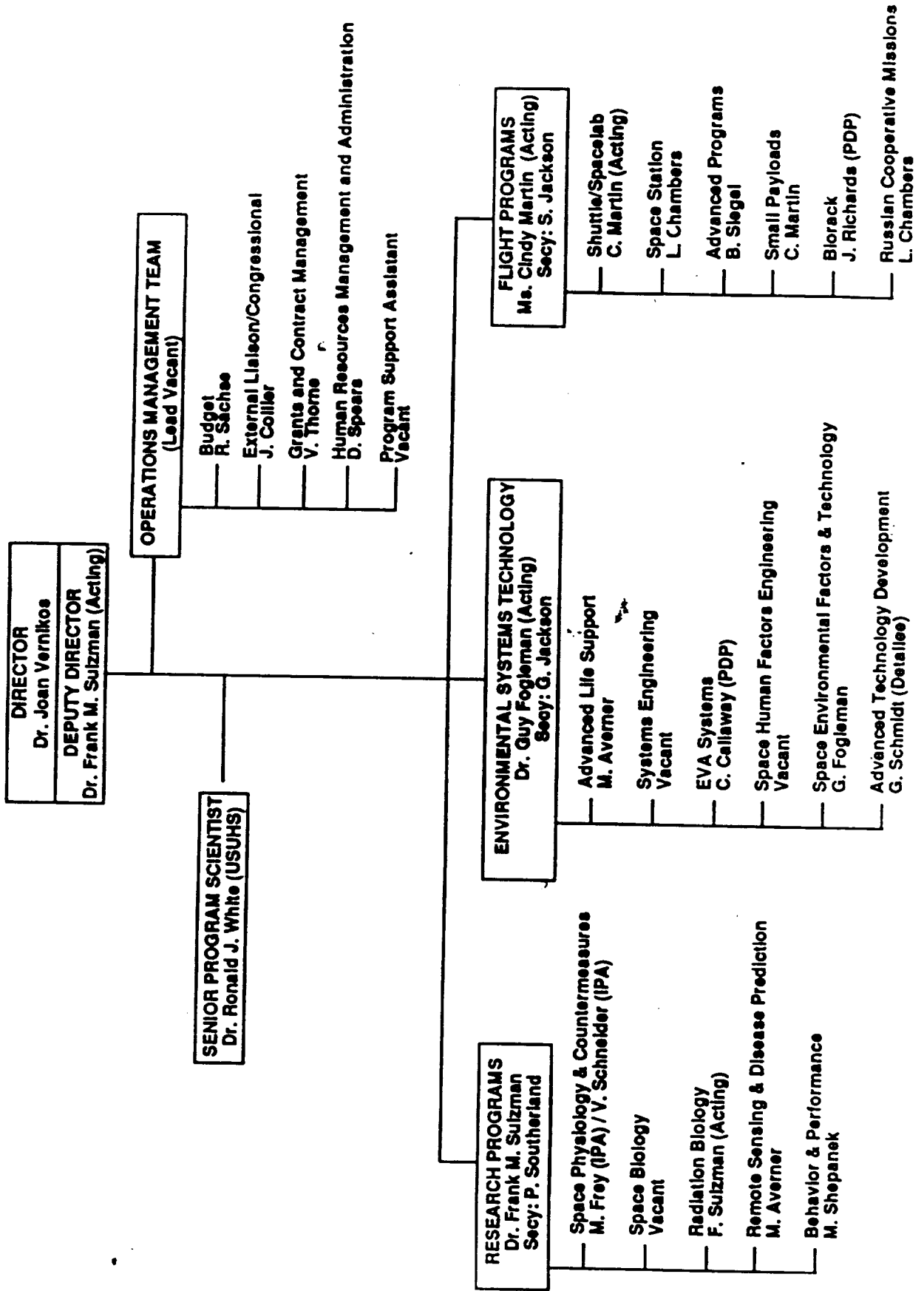

Life and Biomedical Sciences and Applications Division

Gravitational Research Environmental and Human Factors Advanced Life Support

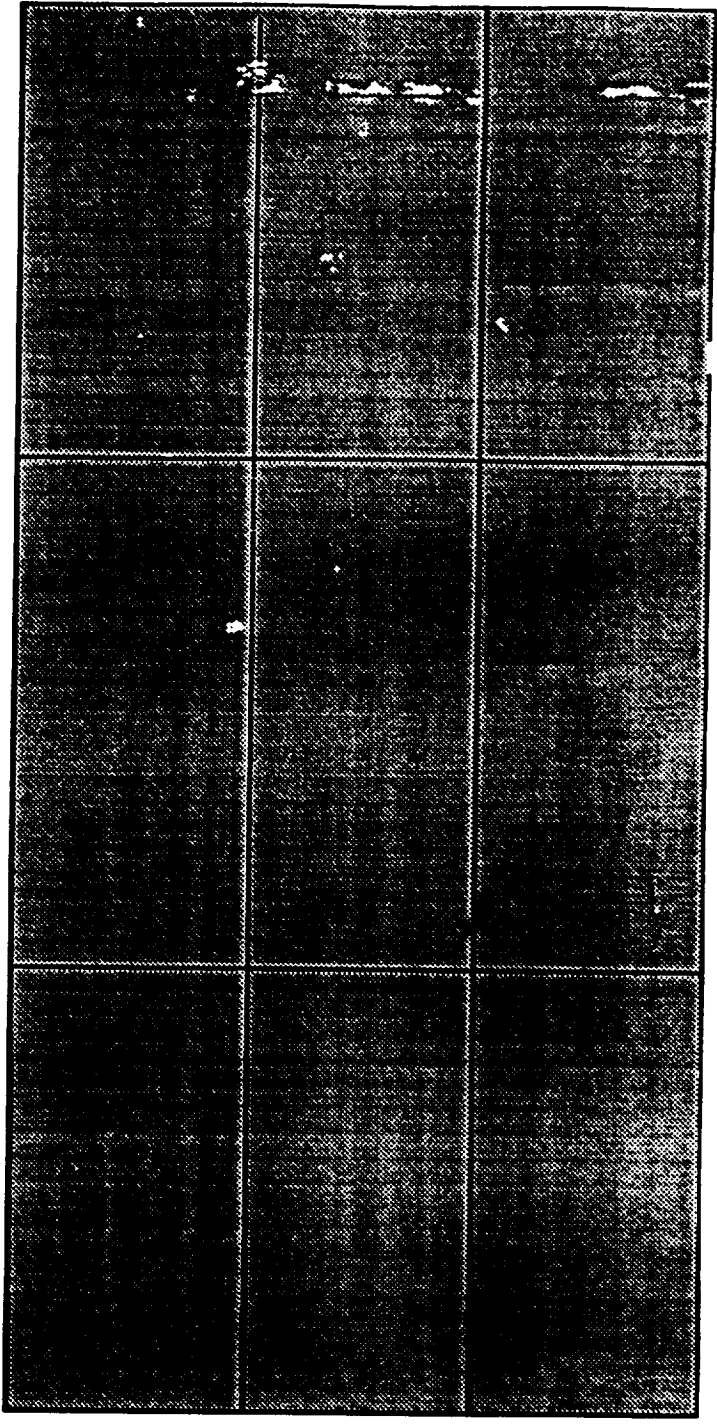

Basic Research
(Scientific Merit Driven)

Applied Research
(Program Need Driven)

Facilities & Technology

Life and Biomedical Sciences and Applications Division

Gravitational Research Environmental and Human Factors Advanced Life Support

<p>Biology Physiology Psychology</p>	<p>Behavior & Performance Toxicology Radiobiology</p>	<p>Barophysiology Microbiology Crop Plant Physiology</p>
<p>Countermeasures Simulations and Analogues</p>	<p>CO₂ Effects Radiation Effects Human-Machine Interaction</p>	<p>Pre-Breathe Protocols EVA Glove Life Support Systems</p>
<p>Ground and Flight</p>	<p>Radiation Dosimetry Environmental Monitoring Technology</p>	<p>Human Rated Chambers Plant Growth Chambers</p>

Basic Research
(Scientific Merit Driven)

Applied Research
(Program Need Driven)

Facilities & Technology



OLMSA FY 1995 CONGRESSIONAL BUDGET

Office of Life and
Microgravity
Sciences and
Applications
(OLMSA)

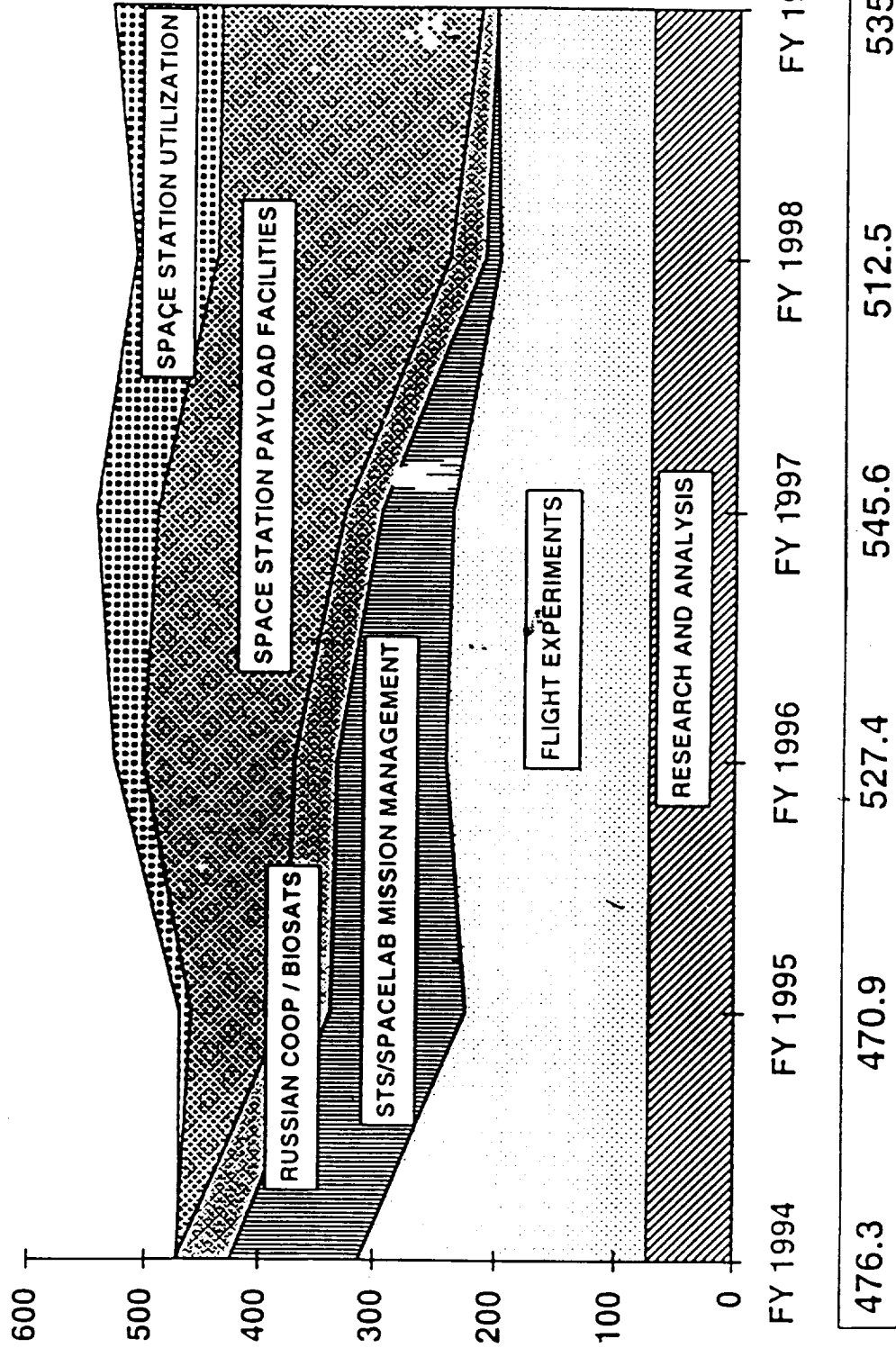

Life and Biomedical Sciences and Applications Division 1995 Current Year Estimate, As Appropriated

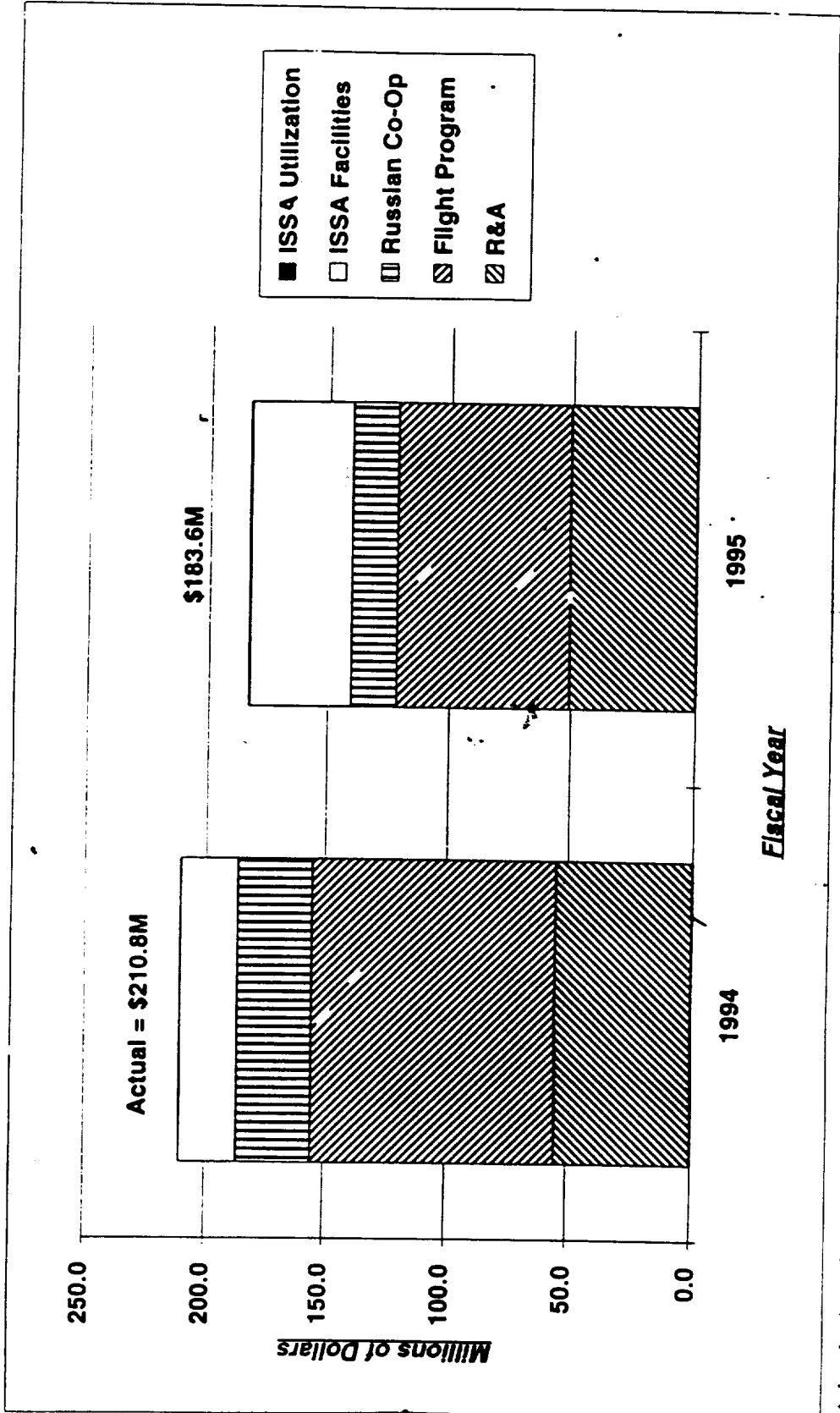

* Includes Space Station Facilities, both years

** Excludes Space Station Lab Support Equipment from 1995 Appropriation

ORBITAL RESEARCH PROGRAM

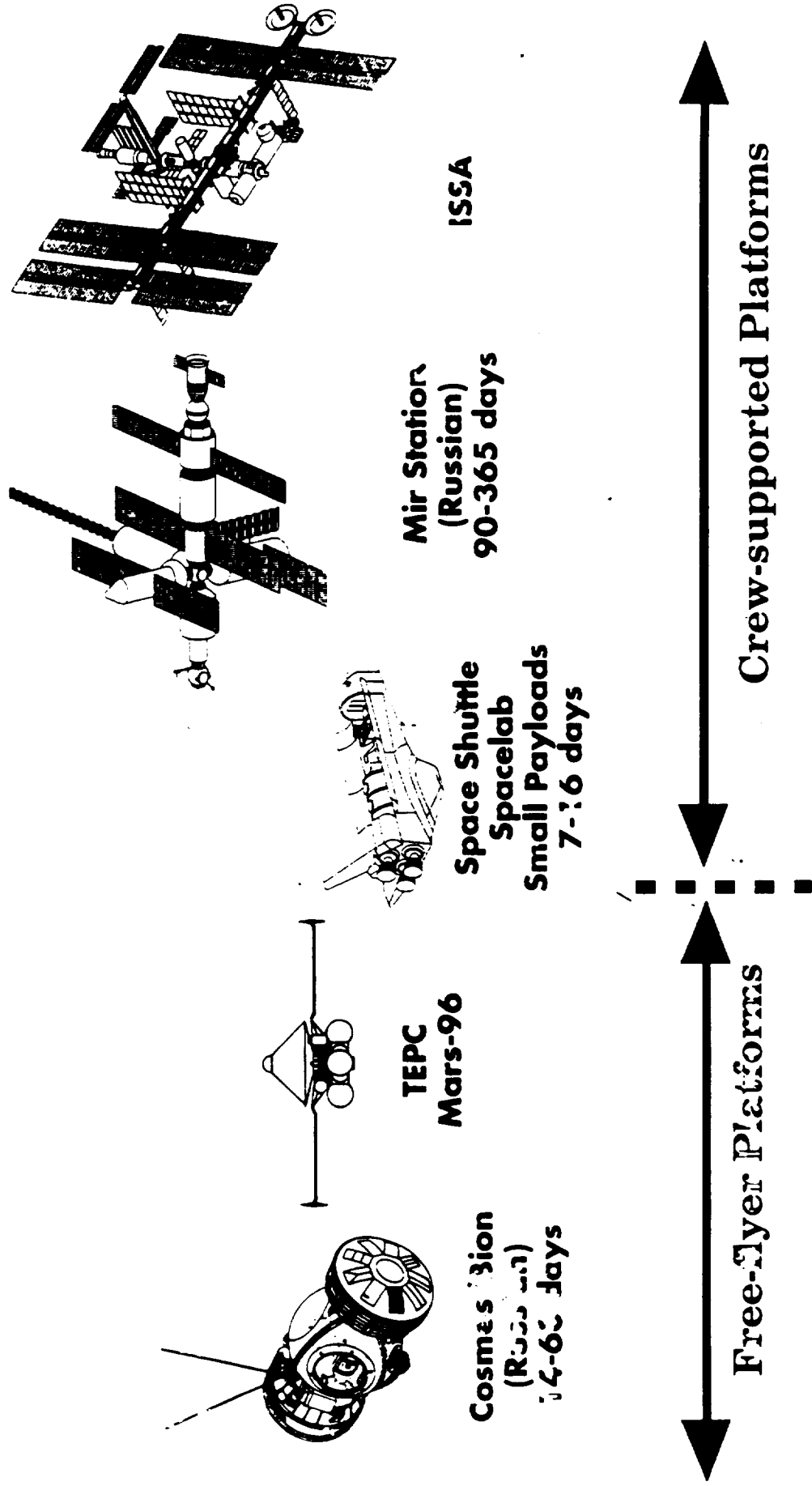

OLMSA ORBITAL RESEARCH PROGRAM

	CY 1993	CY 1994	CY 1995	CY 1996	CY 1997	CY 1998	CY 1999	CY 2000
SHUTTLE/ SPACELAB MISSIONS (Per FAWG Manifest Rev POP-94 GUIDELINES (REV-1) -MARCH 22, 1994)	SL-02 SLS-02	USAMP-02 ML-02	USAMP-03 USML-02	USAMP-03 LMS	USAMP-04 MSL-01	NeuroLab		
RUSSIAN COOPERATION	STS-40	STS-43 to MMR-1	STS-71 to MMR-1	▲▲▲	▲▲▲			
SPACE STATION					U.S.FEL	3-CREW U.S. Lab PHPC		8-CREW PHC (2002)
SUBORBITAL & GROUND BASED								
BION	▲			▲ ¹¹		▲ ¹²		

FACILITIES

SPACE STATION UTILIZATION

GROUND-BASED & SUBORBITAL RESEARCH

SIGNIFICANT CONTRIBUTIONS OF MIR

- **Compliments Capabilities of Spacelabs**
 - Provides Extended Duration Research Opportunities
 - Risk Mitigation
- **Research Opportunities**
 - Human Physiology and Behavior
 - Plant Biology
 - Avian Developmental Biology
 - Life Support Technology and Environmental Health
 - Space Human Factors
- **Test Bed for ISSA**
 - Procedures
 - Interfaces
 - Standards
 - Technologies
 - International Research

UNIQUE ATTRIBUTES OF ISSA

- **Continuous Extended Duration Exposure to Microgravity**
 - Enable More Frequent Access to Flight Opportunities
 - Multi-generation Studies
 - Enable Integrated Cellular, Animal, Plant, and Human Program
 - Ability to do Repetitive Measures
 - Enable Interactive, Iterative Experiments
 - Comprehensive Evaluation of Microgravity Adaptive State
- **Examine Fractional G**
 - Biological Thresholds
 - Simulate Moon and Mars
- **Intermittent G Effects**
- **Access to 1G**
 - Control For Other Space Flight Factors
 - Do Acute Studies

GRAVITATIONAL BIOLOGY RESEARCH

GBF

CENTRIFUGE FACILITY PROJECT ^{PLANTS} _{ANIMALS}
HUMAN RESEARCH FACILITY

• MEDICAL RESEARCH

GBF

CFP

HRF

• ENVIRONMENTAL HEALTH RESEARCH

• ADVANCED LIFE SUPPORT RESEARCH

• HUMAN FACTORS RESEARCH + ENGINEERING

Life Sciences Space Station Hardware/Discipline Matrix

Scientific Discipline	Habitat Hold. Systems, Habitats & Centrifuge	Human Research Facility	Gravitational Biology Facility	CELSS Test Facility	Laboratory Support Equipment
Gravitational Biology	•		•	•	•
Space Physiology		•			•
Radiation Biology	•	•	•		•
Regenerative Life Support Systems	•		•	•	•
Environmental Health	•	•			•
Operational Medicine		•			•
Human Factors, Behavior & Performance		•			•

HOW DO WE CONDUCT OUR PROGRAM?

INTRAMURAL / EXTRAMURAL

NASA CENTERS

NSUORTS

NASA / WITH

NASA / NSF & OTHER AGENCIES

PI initiated research

INTERNATIONAL

• SPREADING THE WORD

• IMPROVING THE QUALITY



SIGNIFICANT LIFE SCIENCES ACTIVITIES AT NASA CENTERS

Office of Life and
Microgravity
Sciences and
Applications
(OLMSA)

Ames Research Center

- Basic human and non-human research
- Development and flight of animal and biological payloads
- Centrifuge and Gravitational Biology Facility development
- Advanced Life Support systems studies and hardware
- Animal Care Facility and Animal Care and Use Committee
- Space Human Factors

Johnson Space Center

- Human applied and operational research
- Human subject payloads (basic and applied) for flight
- Extended Duration Orbiter (EDO) medical experiments
- Mission payload integration of life science investigations
- Advanced Life Support Human Rated Test Facility Project
- Managed Systems

Kennedy Space Center

- Controlled Ecological Life Support Test Bed
- Flight support facility for specimen integration
- Payload integration

LBSAD NRA/AO SCHEDULE

Activities	1993												1994												1995					
	Jul	Aug	Sept	Oct	Nov	Dec	Jan	Feb	Mar	Apr	May	Jun	Jul	Aug	Sept	Oct	Nov	Dec	Jan	Feb	Mar	Apr	May	Jun	Final Selection					
AO-93 OLMSA-01, Neurolab	AO Release				Proposals (166 Rec'd)				Peer Review	Selection for Definition	Letters of Notification																			
NRA 93, OLMSA-02, Tissue Sharing Program	NRA Proposals Release (17 Rec'd)					Peer Review		Selection		Letters of Notification																				
NRA 93, OLMSA-03, Physiological and Anatomical Rodent Experiment	NRA Proposals Release (38 Rec'd)				Peer Review		Selection for definition		Letters of Notification																					
NRA 93, OLMSA-05, Plant Flight Research I	NRA Release				Proposals (26 Rec'd)		Peer Review		Selection		Letters of Notification																			
NRA 93, OLMSA-04, Musculoskeletal Cell Culture	NRA Proposals Release (23 Rec'd)				Peer Review		Selection		Letters of Notification																					
NRA 93, OLMSA-06, Avian Developmental Biology	NRA Proposals Release (16 Rec'd)				Peer Review		Selection		Letters of Notification																					
Division Annual NRA 93-OLMSA-07					NRA Proposals Release (572 Rec'd)		Peer Review		Selection		Letters of Notification																			
NRA 94, OLMSA-01, MIR-Phase 1B					NRA Proposals Release (Rec'd 130)		Peer Review		Selection		Letters of Notification																			
NRA 93, OLMSA-02, NSF/NASA Plant Research NSCORT					NRA Proposals Released		Peer Review		Selection		Letters of Notification																			
NASAVESA For BIORACK																														
Division Annual NRA 94-OLMSA																														
Plant NRA II																														

NASA SPECIALIZED CENTERS OF RESEARCH AND TRAINING (NSCORT)

1991

Gravitational Biology
Dr. Brian Spooner
Kansas State University
Manhattan, Kansas

Bioregenerative Life Support
Dr. Cary Mitchell
Purdue University
West Lafayette, Indiana

Environmental Health
Dr. Thomas Clarkson
University of Rochester
School of Medicine
& Dentistry
Rochester, New York

1992

Radiation Health
Dr. Alope Chatterjee
Lawrence Berkeley Laboratory
Berkeley, California

Radiation Health
Jurgen Keifer
Radiation Center Strahlencentrum
der Justus-Liebig-Universität
Giessen D-6300
German (supported by DARA)

1993

Integrated Physiology
Dr. Gunnar Blomqvist
University of Texas
Southwestern Medical Ctr.
Dallas, Texas

Joint NASA/NIH (NIDCD)
Center for Vestibular Research
Dr. Barry Peterson
Northwestern University Medical Center
Chicago, Illinois

1994

Joint NASA/NSF
Center on Plant Physiology

INTERNATIONAL COOPERATION

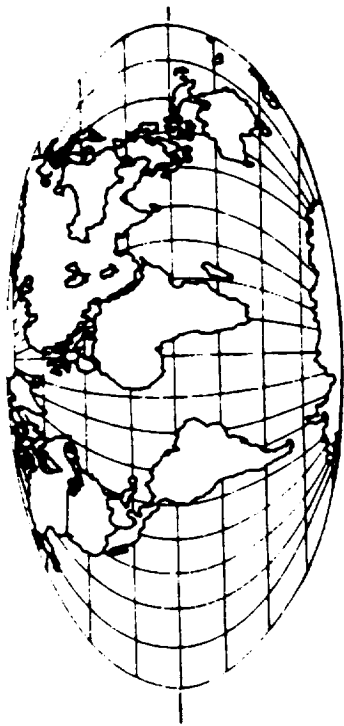

RISA

• IML-2 launched July 8, 1994 carrying NASA-sponsored and international investigations

• Shuttle-Mir and Bion (free flyer) with Russia

• Neurolab

— Partners include CSA, CNES, DARA, ESA, and NASDA

— PI's selected for definition

• Research in the Antarctic

— Australia

— France

• International Space Life Sciences Strategic Planning Working Group meetings held regularly

• Joint Working Group meetings with DARA, ESA, CNES, CSA NASDA, and Russia

• Joint programs for NASA-Mir and Bions

SPACELINE

SPACELINE: AN ONLINE BIBLIOGRAPHIC DATABASE IN THE SPACE LIFE SCIENCES

- Cooperative Activity of the Life and Biomedical Sciences and Applications Division of NASA and the National Library of Medicine. Analogous to MEDLINE.
- Consolidates the results of the growing body of space life sciences research into a single, accessible resource, and enhances dissemination and visibility of this research to the space life sciences community, the broader scientific and educational communities, and the public
- Initial online database consists of a subset of NLM databases, from 1966 to the present, and NASA references of recent (1992-95) publications, primarily of investigators supported by NASA. When mature, SPACELINE will include both U.S. and international publications, reporting flight and ground-based research across the spectrum of space life sciences subject areas, from 1961 onward.
- Accessed via direct searching, which requires some familiarity with NLM searching, or via NLM's Grateful Med software, an interface that provides easy-to-use, inexpensive access to the literature

Schedule

- Fall 94: creation of SPACELINE prototype; begin transferring NASA data to NLM
- Early-mid 1995: database testing by volunteer testers
- fall 1995: target date for first online availability

LIFE SCIENCES DATA ARCHIVE

Goal

- To develop a method for archiving and distributing results of space life sciences research sponsored by the NASA Life and Biomedical Sciences and Applications Division

Purposes of the Archive

- To increase the effectiveness of space life sciences data management in order to maximize the science output from these missions
- To provide a central repository of space life sciences data
- To provide researchers, educators, students and the general public with better access to life sciences information and results
- To provide access to data and information for future experiment planning and retrospective data analysis

Approach

- Existing assets are utilized
- Data from a particular mission are archived at the major data collection centers (ARC, JSC, KSC).
- Existing computer systems and user support services of the National Space Sciences Data Center (NSSDC) are used as the initial computer entry point for users
- Detailed information and data for each experiment are archived on CD-ROM by the appropriate NASA data collection center
- Activities of these existing facilities are coordinated at a NASA life sciences central node
- Central node also develops a mission CD-ROM product, which contains an overview of all the experiment data archived for a particular mission

Schedule

- December 1994 Delivery of prototype system to NASA Headquarters
- Jan. - Oct. 1995 Evaluation of prototype by potential user groups
- October 1995 SLS-1 information will be available to all users
- 1997 Fully operational, multiple-mission archive

APPLICATIONS
MAKING LIFE BETTER

NASA DEVELOPED .
LIFE SCIENCE DEVELOPED

- TECHNOLOGY
- KNOWLEDGE
- EDUCATION

ENCLOSURE # 4

NASA SPECIALIZED CENTER
OF
RESEARCH AND TRAINING

(NSCORT)

1991 - 1996

LBL AND COLORADO STATE UNIVERSITY (FORT COLLINS)

Research: Health Hazards Due To Galactic Cosmic Rays
(Basic Studies Involving Molecular, Cellular and
Tissue Biology)

Training: Student and Post Doctoral Trainees

NSCORT BASIC AND APPLIED RESEARCH

1. Fluence Dosimetry, Track Structure, and Calculations of Initial DNA Damage.
2. Enzymatic Repair Processes in Human and Rodent Cells.
3. Mutagenesis in Human and Rodent Cells.
4. Epithelial Cell Transformation and Carcinogenesis.
5. Helium-Ion-Induced Human Cataractogenesis.
6. Integration of Research to Human Risk Assessment.

TRAINING AND RESEARCH
IN
TRACK STRUCTURE EFFECTS

Craig Mariano (Student)

Tom Borak (CSU)

William Holley (LBL)

Aloke Chatterjee (LBL)

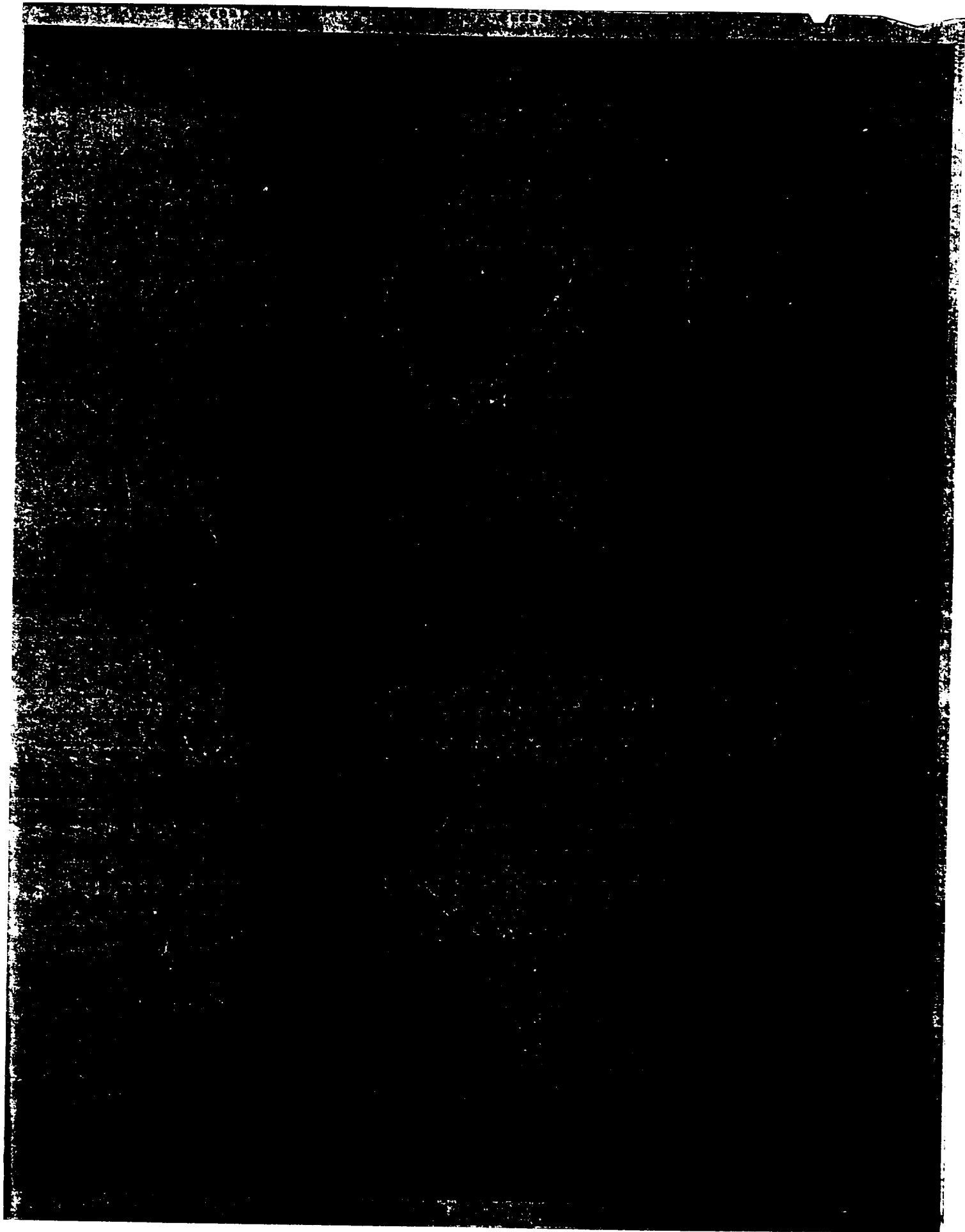

QUESTIONS

- 1. Can cell's repair machinery handle clusters of damage either in the form of locally multiple damaged sites (20 bp - 30 bp) or regionally multiple damaged sites (2 kbp - 3 kbp)?***
- 2. Is there a threshold of cluster density, below which repair takes place with good fidelity?***

**ENZYMATIC REPAIR
PROCESSES
IN
HUMAN AND RODENT CELLS**

Priscilla Cooper (LBL)

Bjorn Rydberg (LBL)

Bijon Fouladi (Student)

***Markus Lobrich
(German-SCORT)***

Correct vs. Total Rejoining of DSBs Induced by 80 Gy X-ray

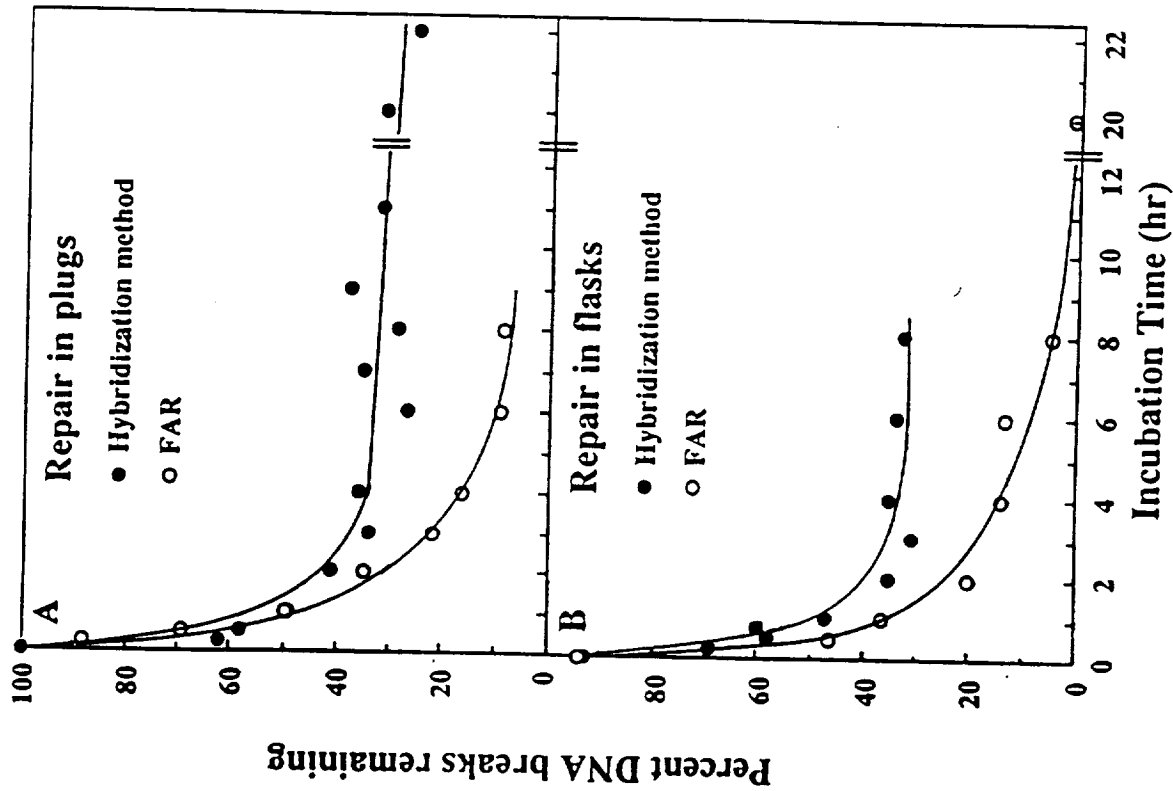

Overall Rejoining of DSBs In 4 Hrs After Heavy Ion Irradiation (FAR)

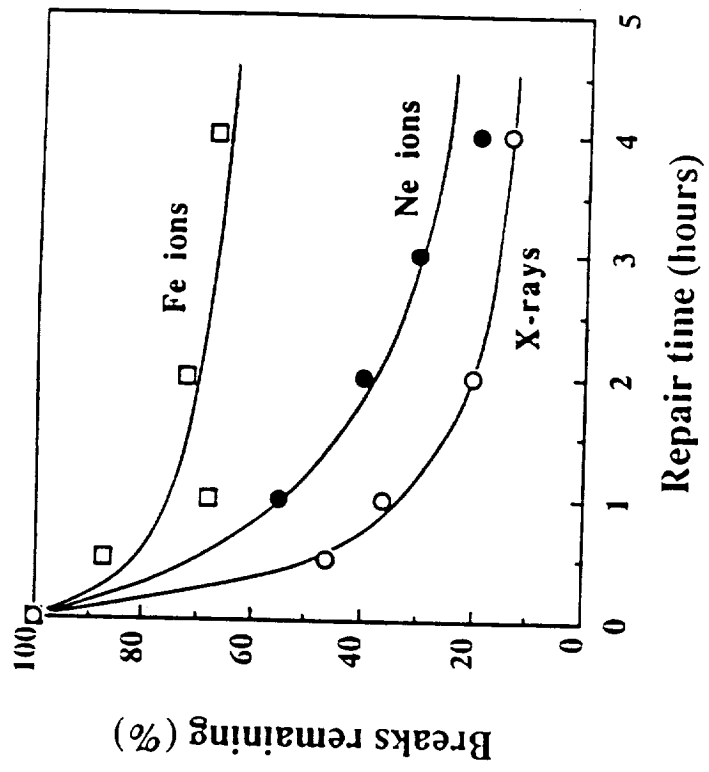

Radiation Type	Cell Killing RBE	Remaining Breaks RBE
X-rays	1	1
Ne ions	1.2	~1.6
Fe ions	2.3	~2.3

**MUTAGENESIS
IN HUMAN AND
RODENT CELLS**

AMY KRONENBERG (LBL)

CHARLES WALDREN (CSU)

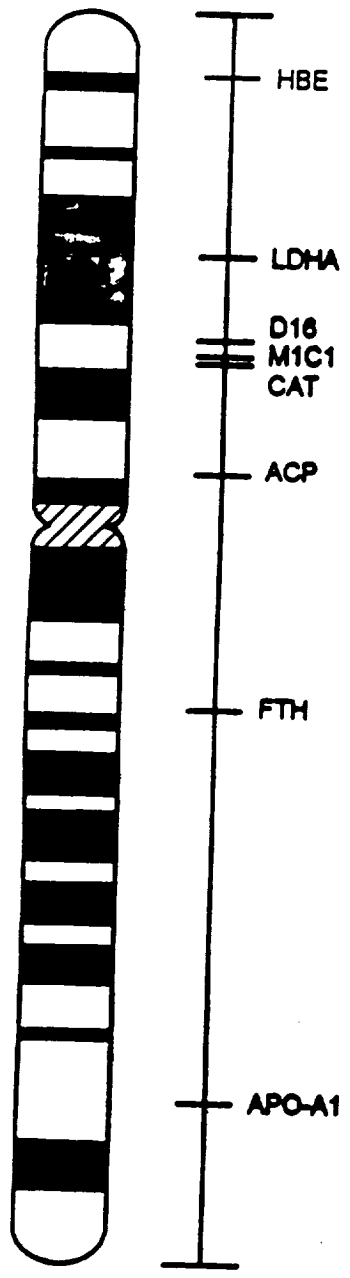

Complex Rearrangements HZE (Fe)

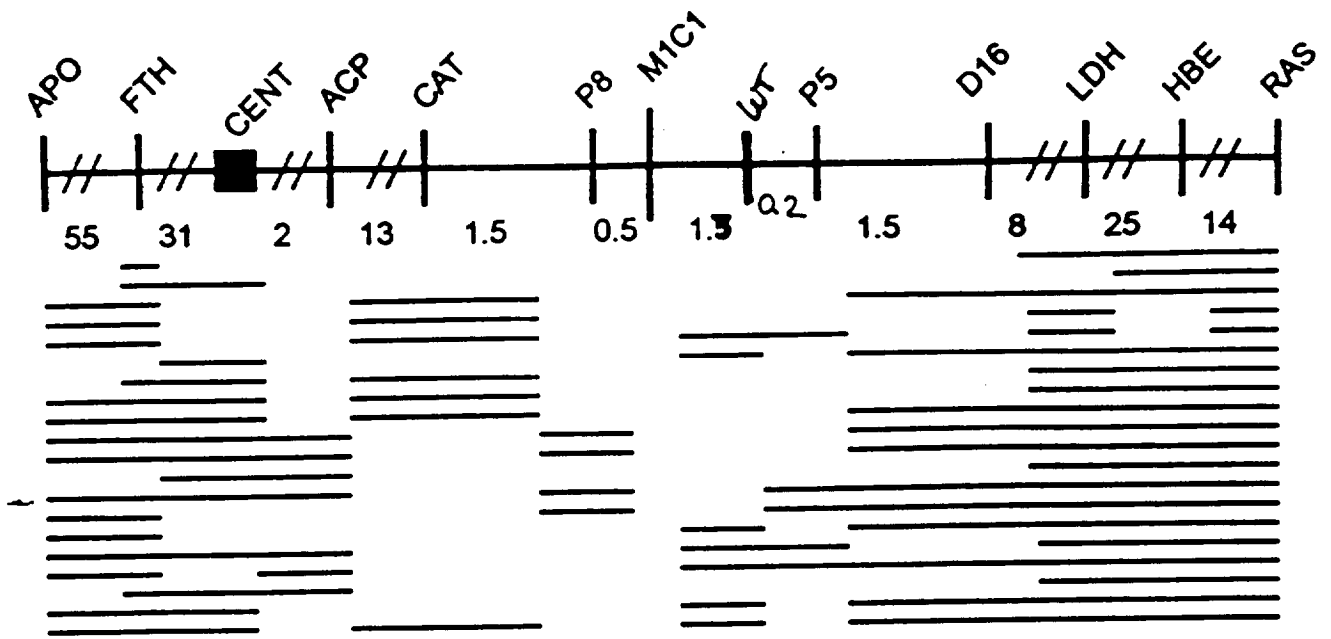

Summary

- Linkage constraints to essential genes can reduce the recovery of viable Fe-induced mutations by a factor of 50 within the same cell type.
- Fe particles can induce very complex rearrangements.
- Complex rearrangements where the centromere is apparently missing, must be translocations.
- There are also a few simple mutants with large deletions including the centromere that are likely translocations.
- For the same locus, *hpert*, Fe particles are about four times more efficient in producing mutants than x-rays.

**EPITHELIAL CELL
TRANSFORMATION AND
CARCINOGENESIS**

Mary Helen Barcellos-Hoff (LBL)

E. J. Ehrhart (Student)

Edward Gillette (CSU)

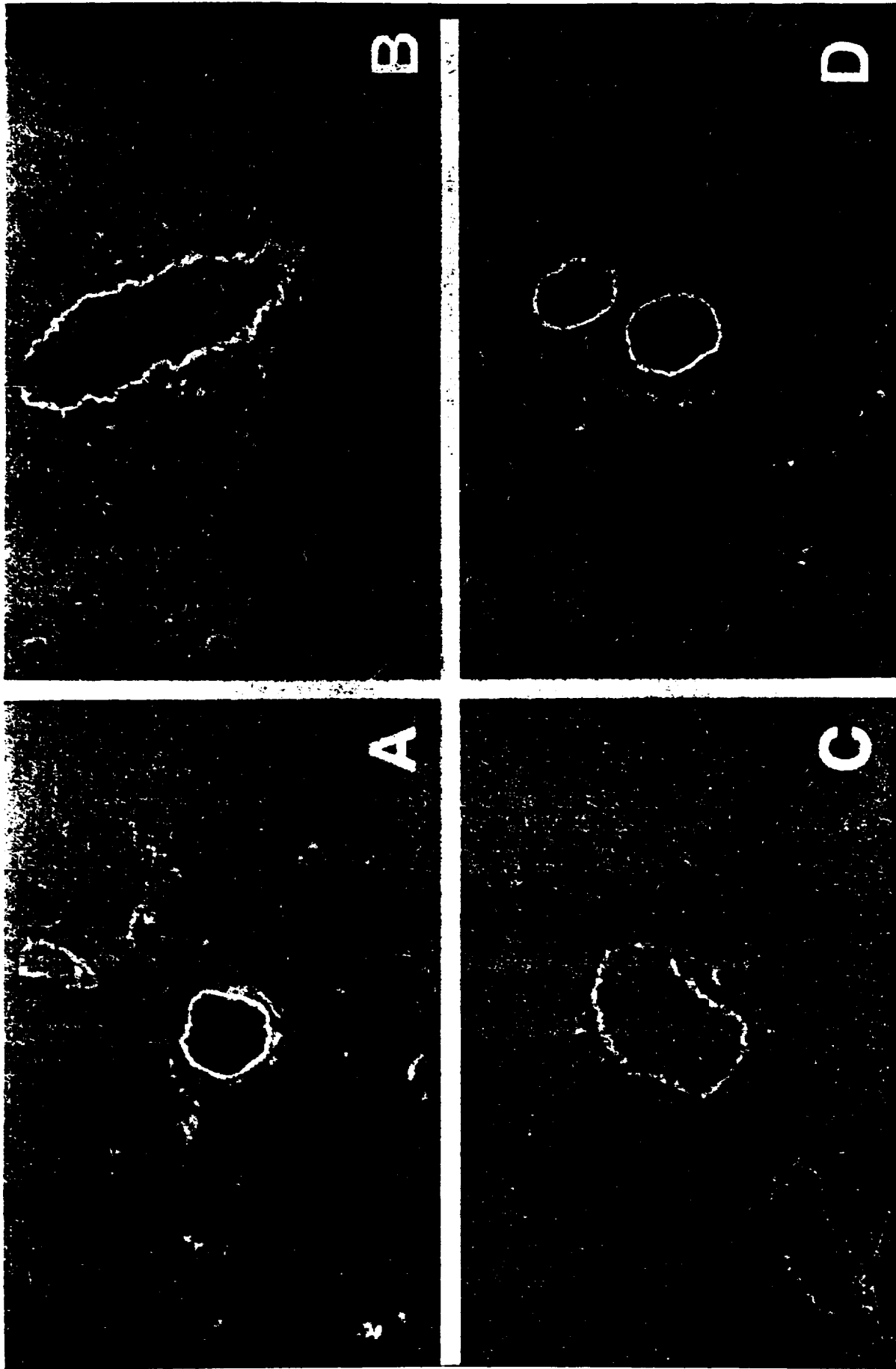

ORIGINAL PAGE IS
OF POOR QUALITY

100-100000-0000

PROTEINS

- **Tenacin - developmentally regulated and found in association with malignant carcinoma
(This protein is induced)**
- **Laminan - it is a basement membrane protein and it is important in initiating differentiation.
(This protein is degraded)**
- **TGF β - is involved in normal tissue growth, proliferation and differentiation; it is supposed to be involved in mediating carcinogenesis.
(This protein is activated)**

RISK ESTIMATION

FOR

**RADIATION INDUCED
CARCINOGENESIS**

**STAN CURTIS (HCC)
WILLIAM R. HOLLEY (LBL)**

ENCLOSURE # 5

SCORT

SCORT GERMANY

Committee members

J. Kiefer, SZ Giessen (Director)

G. Horneck, DLR Köln (Deputy Director)

F. Anders, Genetics, Giessen

W. Heinrich, Physics, Siegen

G. Kraft, GSI Darmstadt

G. Reitz, DLR Köln

Oct. 1993

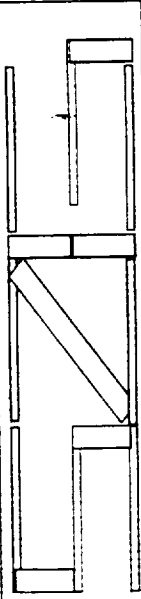

STRAHLENZENTRUM GIESSEN

SCORT

SCORT GERMANY

Funding situation

- Official start of project:
April 1, 1993
- Actual start of funding:
July 1, 1993
- Official end of the first round of funding:
March 31, 1996

Oct. 1993

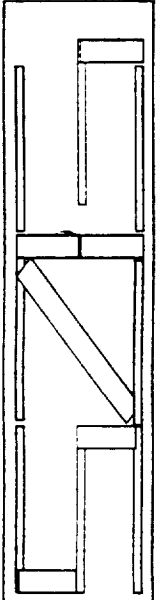

STRAHLENZENTRUM GIESSEN

SCORT

Cooperative Meetings

(Directors and Members)

- 10. 5. 93 Giessen/Germany
- 23. 9. 93 Potsdam/Germany
- 23. 3. 94 Sophia-Antipolis/France
- 17. 7. 94 Hannover/Germany

NASA/DARA Oct. 1994

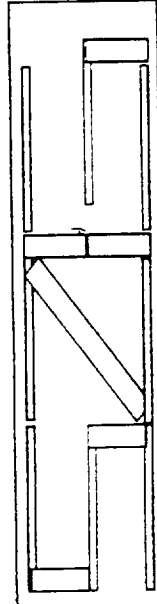

STRAHLENZENTRUM GIESSEN

SCORT

SCORT GERMANY

Current projects

- Survival and DNA breaks in *E. coli* and *M. radiodurans* (DLR)
Survival and mutation induction in *B. subtilis* (DLR)
Molecular analysis of mutation in *lacZ* (DLR)
- Melanoma induction in *Xiphophorus* (Giessen)
Single cell investigations in yeast and human cells (Giessen)
Molecular analysis of mutations in human cells and yeast (Giessen)
DNA breaks and their repair in mammalian cells (Giessen)
Mutation and DNA breaks in yeast (Giessen)
- Chromosomal aberrations and "chromosome painting" in mammalian cells (GSI)
Studies on hamster-humana hybrid cells (GSI)
DNA breaks in CHO cells
- Fragmentation of heavy ions in various materials by "inverse" kinematics (Siegen)

Oct. 1993

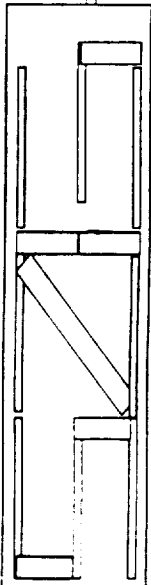

STRAHLENZENTRUM GIESSEN

Contents

1	PROTON-INDUCED FRAGMENTATION OF CARBON AT ENERGIES BELOW 100 MeV	1
2	DOSIMETRY OF HEAVY IONS BY USE OF CCD DETECTORS	5
3	ESTIMATION OF SPATIALLY RESTRICTED LET USING TRACK STRUCTURE MODELS	11
4	HEAVY ION INDUCED DNA-DSB IN YEAST AND MAMMALIAN CELLS (STATUS REPORT)	15
5	INACTIVATION, DNA DOUBLE STRAND BREAK INDUCTION AND THEIR REJOINING IN BACTERIAL CELLS IRRADIATED WITH HEAVY IONS	13
6	DNA-DSB IN CHO-K1 CELLS INDUCED BY HEAVY IONS: BREAK REJOINING AND RESIDUAL DAMAGE (GSI)	23
7	CHROMOSOMAL DAMAGE OBSERVED IN FIRST POSTIRRADIATION METAPHASES OF REPAIR-PROFICIENT AND DEFICIENT CELL LINES	26
8	MUTATION INDUCTION IN BACTERIA AFTER HEAVY ION IRRADIATION	23
9	HEAVY ION INDUCED MUTATIONS IN MAMMALIAN CELLS: CROSS SECTIONS AND MOLECULAR ANALYSIS (STATUS REPORT)	30
10	HEAVY ION ACTION ON SINGLE CELLS: CELLULAR INACTIVATION CAPABILITY OF SINGLE ACCELERATED HEAVY IONS	33
11	COSMIC HEAVY ION TRACKS IN MESOSCOPIC BIOLOGICAL TEST OBJECTS.	36
12	X-RAY-PROVOKED NON-MENDELIAN TRANSGENERATIONAL ONCODETERMINANTS	41
	PUBLICATIONS	47
	CONFERENCE CONTRIBUTIONS, SEMINARS AND REPORTS	53
	DOCTORAL DISSERTATIONS	60

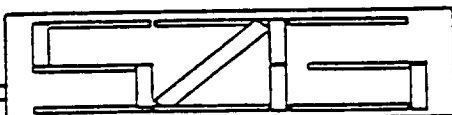

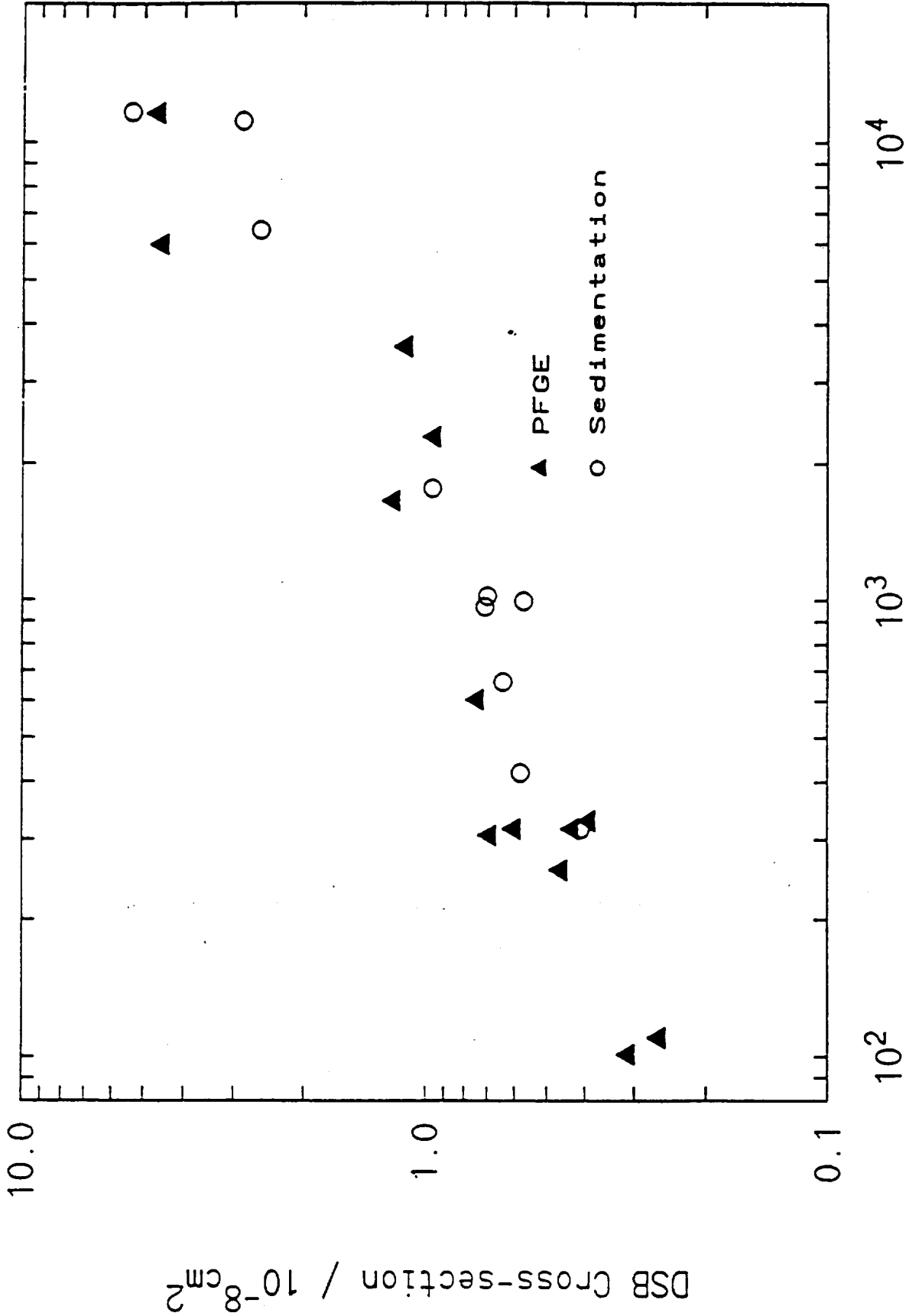

Fig.

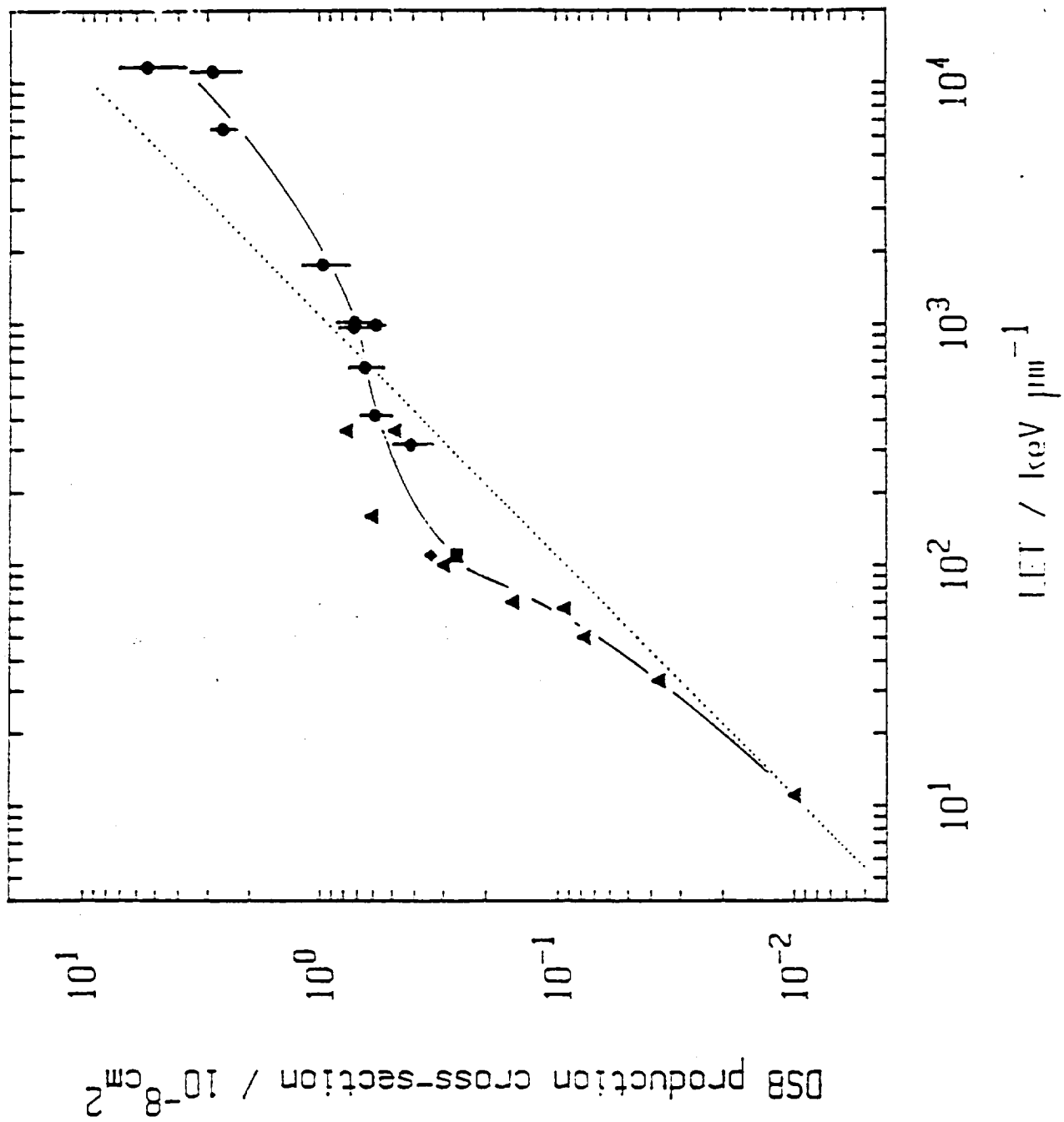
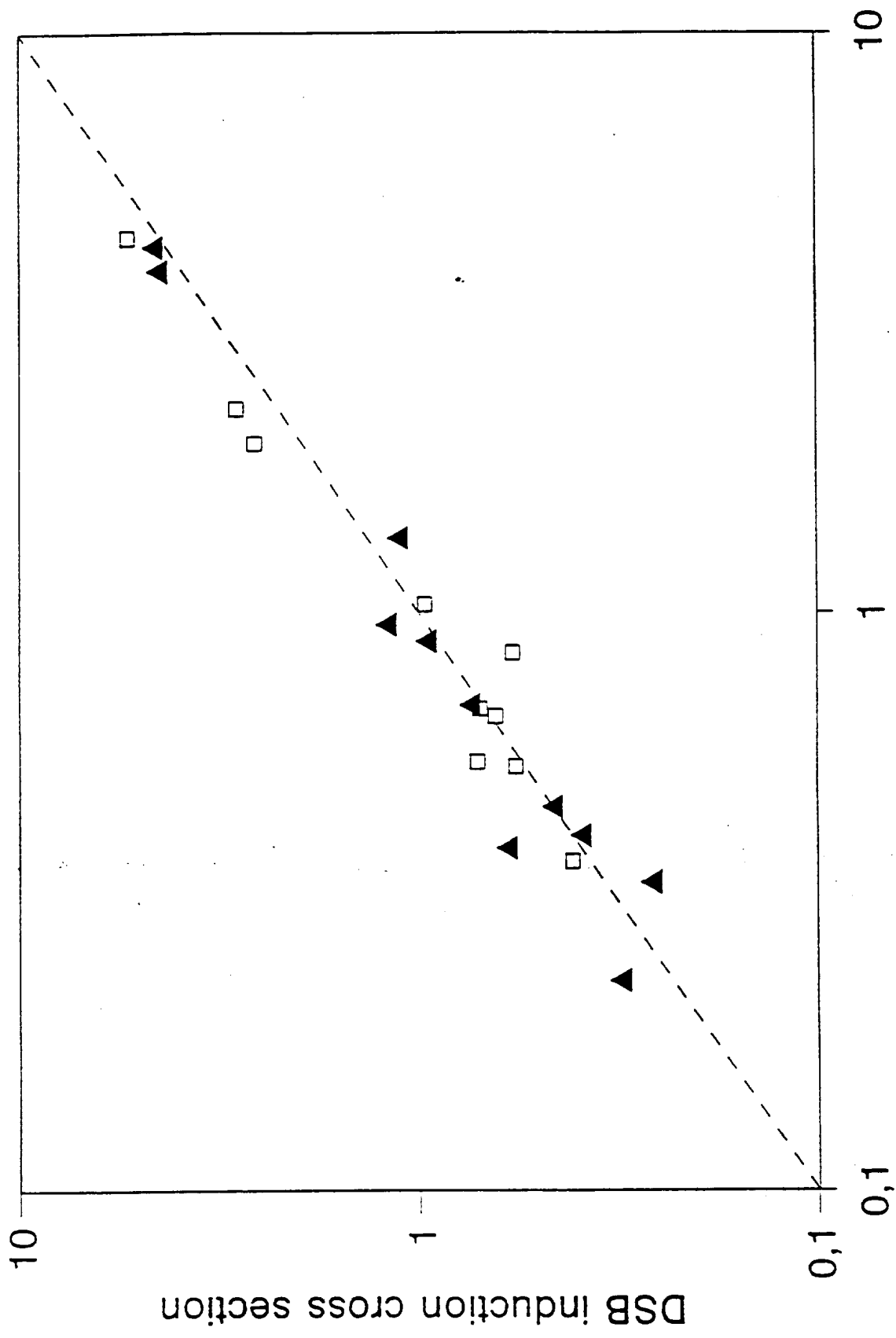

Figure 3

Fig. 6



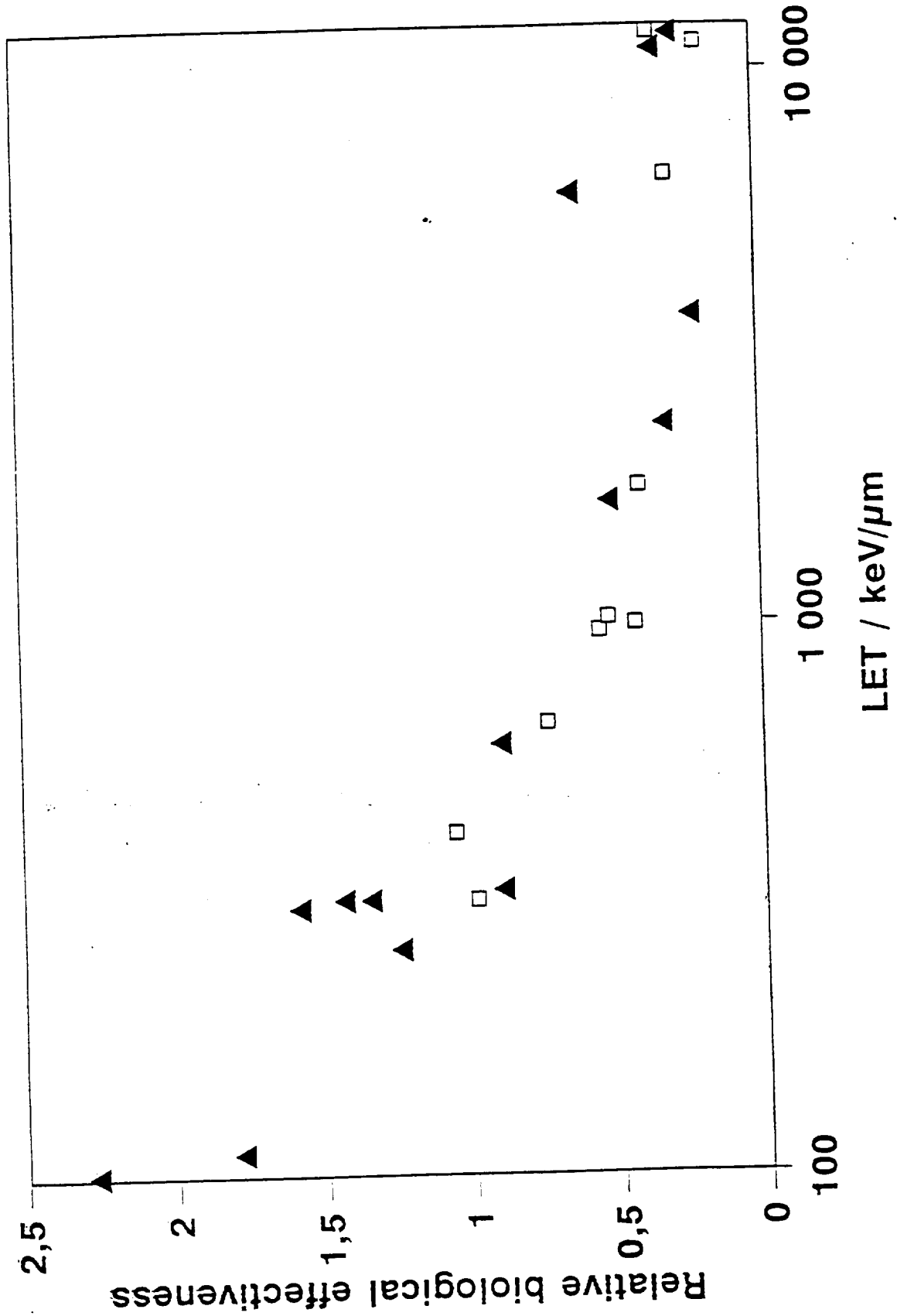
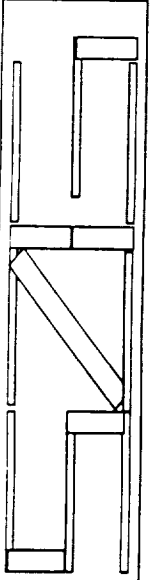

Fig. 5



Material and methods

- **Cells:** V 79 Chinese hamster cells
- **Mutation assay:** Resistance to 6-thioguanine (HPRT-gene)
- **Molecular analysis:** Multiplex PCR
- **Ions:** Oxygen, Neon, Argon, Nickel, Gold, Lead
- **Energy range:** 2 - 1000 MeV/u
- **LET range:** 10 - 14 000 keV/micron

COSPAR 1994

Ion	E/M at cell surface (MeV/u)	LET (H ₂ O) (keV/μm)	Z ^{*2} /β ²	rp (μm)	σ _i (μm ²)	σ _m (10 ⁻⁴ μm ²)	σ _m /σ _i (10 ⁻⁵)
O	1.9	750	11455	0.18	72 ± 5	10.1 ± 0.4	1.4 ± 0.1
	8.2	311	3394	2.2	50 ± 4	20.0 ± 4.0	4.0 ± 0.8
	10.8	255	2641	3.5	52 ± 3	8.8 ± 1.1	1.66 ± 0.3
	400.0	19.2	125	1633.4	1 ± 0.1	0.15 ± 0.01	1.4 ± 0.2
Ne	7.7	494	5466	1.98	45 ± 4	21.3 ± 3.0	4.75 ± 1.1
	8.9	448	4821	2.5	48 ± 5	4.6 ± 1.8	0.95 ± 0.5
	10.6	395	4105	3.4	51 ± 3	15.1 ± 6.0	2.93 ± 1.3
	10.7	392	4070	3.5	53 ± 4	18.1 ± 1.7	3.4 ± 0.6
	12.0	360	3665	4.2	42 ± 3	15.0 ± 5.5	3.5 ± 1.3
	14.4	310	3108	5.7	31 ± 4	6.1 ± 2.	1.95 ± 0.9
Ca	14.1	1164	11510	5.5	46 ± 7	7.0 ± 0.4	1.5 ± 0.25
Ti	4.4	2544	31538	0.76	54 ± 3	14.0 ± 1.0	2.6 ± 0.3
	14.8	1341	13133	6.0	50 ± 6	8.6 ± 1.6	1.7 ± 0.38
Ni	5.3	3377	40270	1.0	61 ± 6	9.1 ± 0.8	1.5 ± 0.3
	9.0	2673	28620	2.6	65 ± 2	8.3 ± 1.2	1.3 ± 0.18
	14.6	2055	20197	5.9	87 ± 5	5.7 ± 1.8	0.65 ± 0.05
	160	406	2884	344	50 ± 2	5.9 ± 1.1	1.14 ± 0.27
	400	235	1535	1633	35 ± 3	5.0 ± 0.5	1.4 ± 0.28
	650	180		3729	34 ± 1	6.6 ± 0.8	2.0 ± 0.3
Xe	10.6	6661	69282	3.4	70*	12.0 ± 2.5	1.7 ± 0.36
Au	2.2	13195	193900	0.24	57 ± 2	4.1 ± 0.7	0.7 ± 0.2
	8.8	11673	125771	2.48	90 ± 6	8.3 ± 2.1	0.9 ± 0.3
Pb	11.5	11428	117136	3.9		8.7 ± 0.6	
	15.6	10399	101074	5.5	88 ± 8	9.2 ± 2.6	1.1 ± 0.33
	200	2590		503	93 ± 6	12.6 ± 2.6	1.4 ± 0.38
	500	1630		2387	85 ± 3	7.6 ± 2.4	0.9 ± 0.31
	1000	1318		7755	63 ± 2	8.3 ± 1.8	1.3 ± 0.33
U	5.1	15166	183547	0.95	71 ± 5	15.0 ± 2.0	2.1 ± 0.37
	10.6	13494	140359	3.4	105 ± 10	8.5 ± 1.5	0.8 ± 0.16
	14.1	12494	123515	5.5	90 ± 9	4.5 ± 2.0	0.5 ± 0.20
X-ray	300 kV						3.1 ± 0.4
α - particles		163			42 ± 2	11.9 ± 0.8	2.8 ± 0.2

Table I: Heavy ion physical data and cross sections for mutation, inactivation and mutagenicity

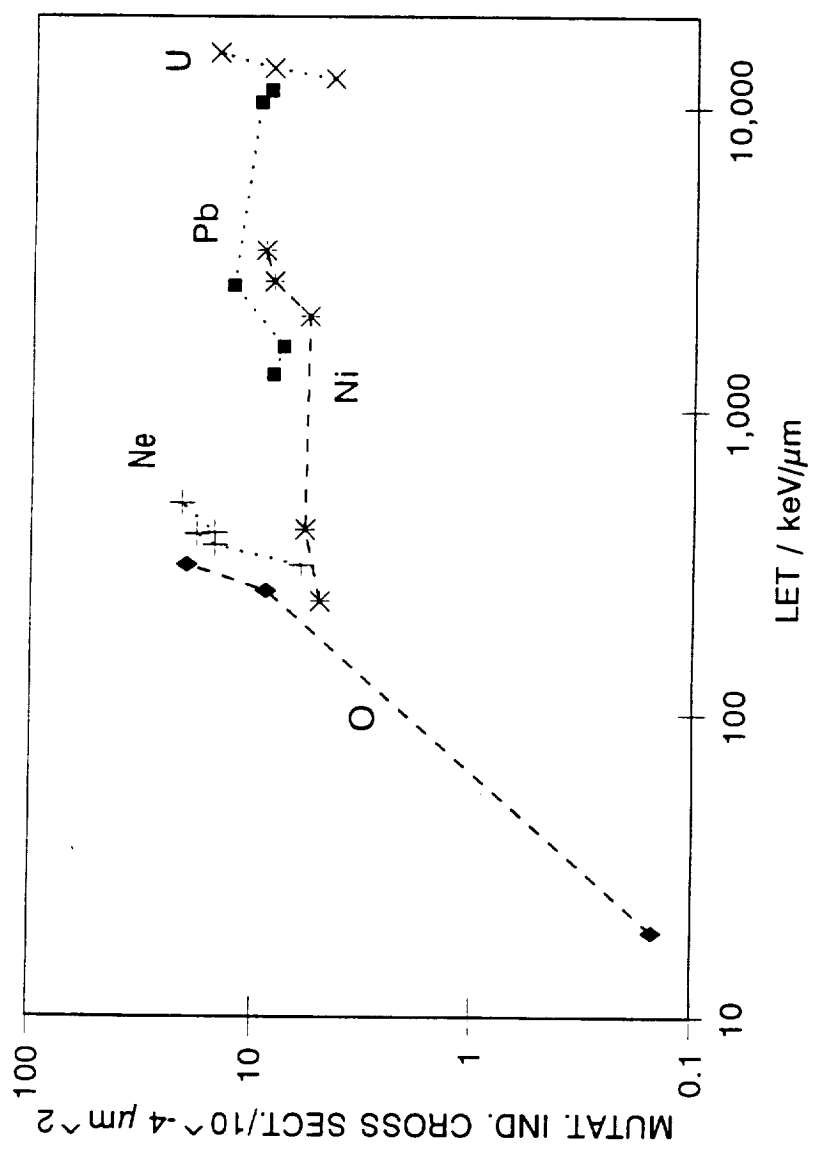
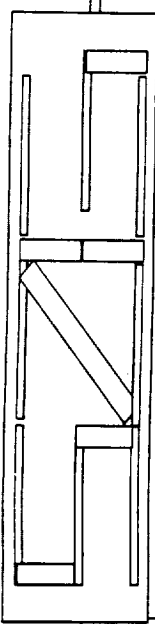

STRAHLENZENTRUM GIESSEN

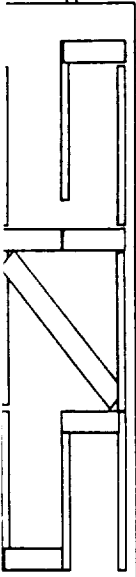

Relative biological efficiencies

Oxygen ions

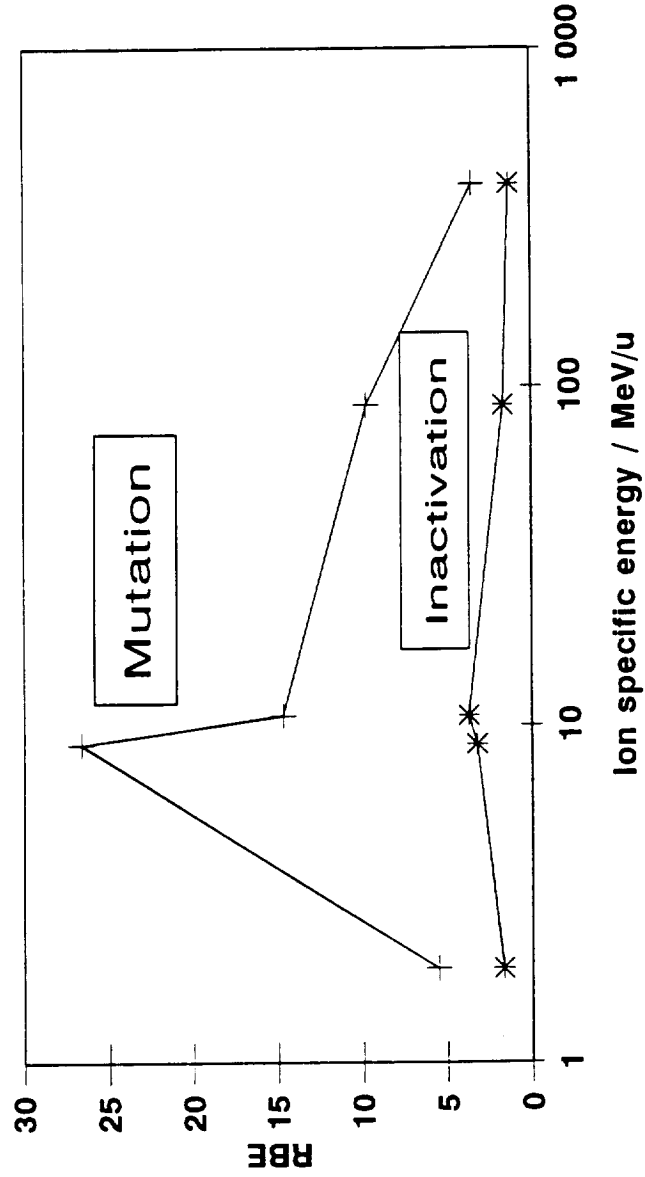

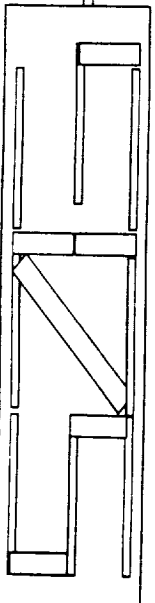

Relative biological efficiencies

Neon ions

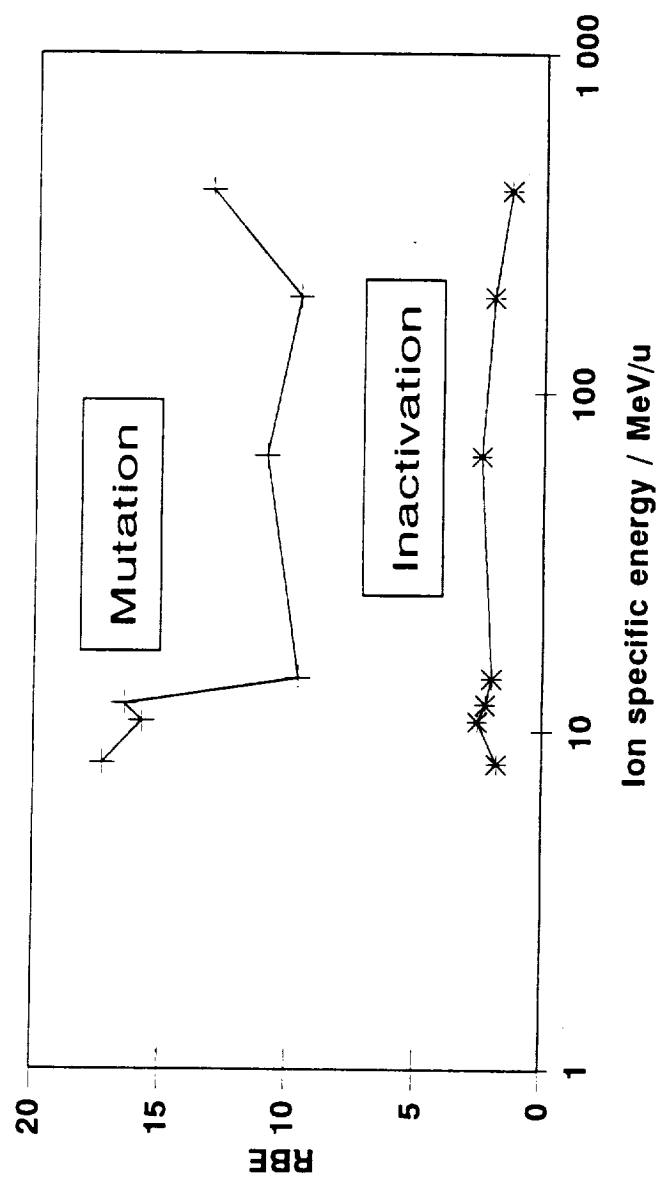

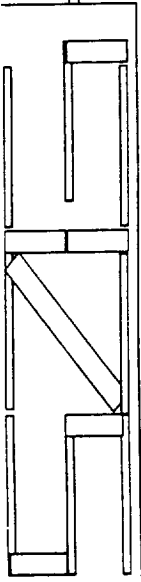

Relative biological efficiencies

Nickel ions

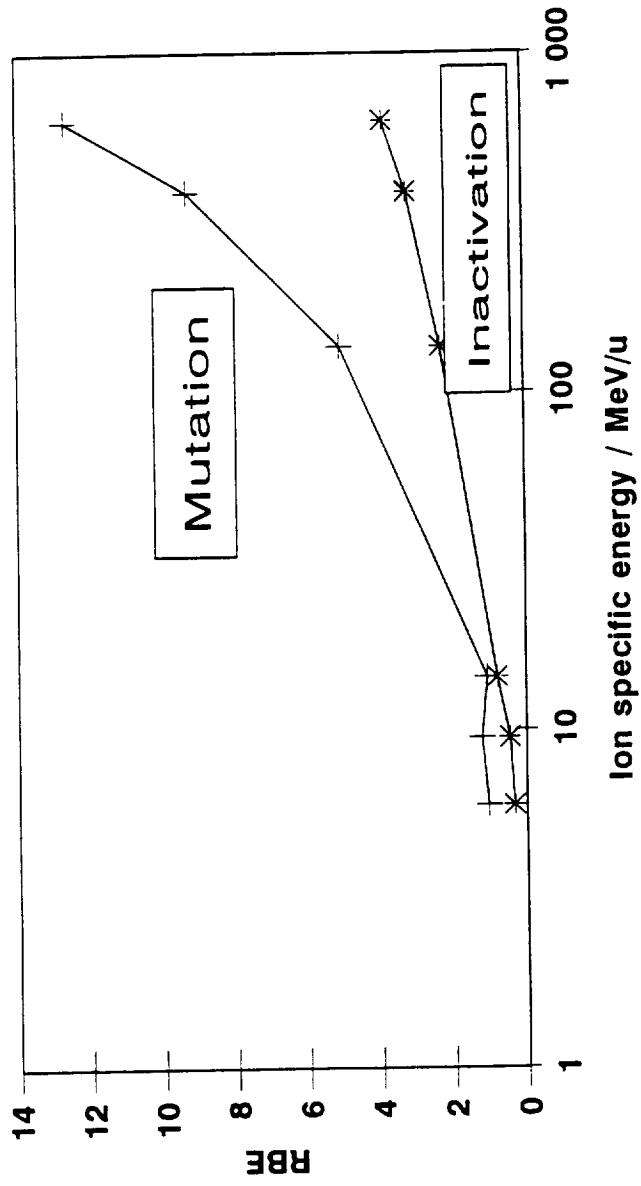

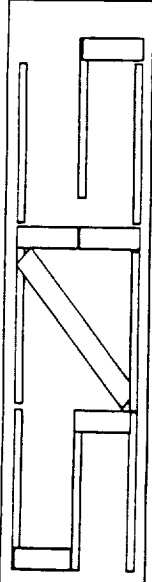

Relative biological efficiencies

Gold and Lead ions

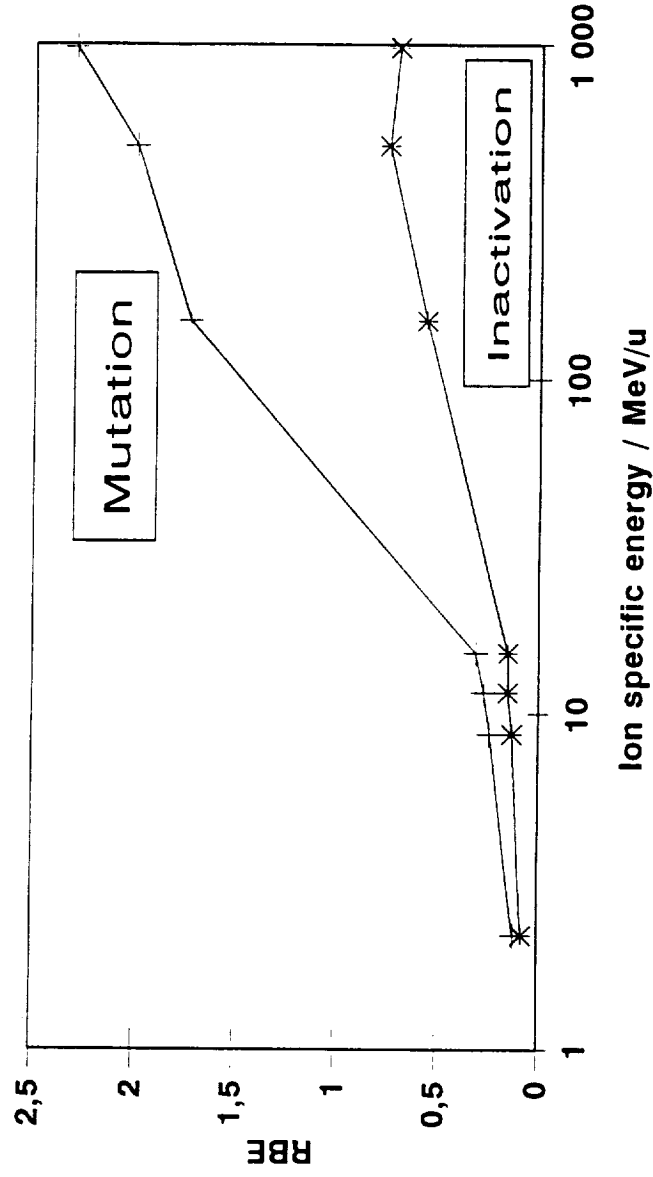

Molecular analysis of mutations

Polymerase chain reaction

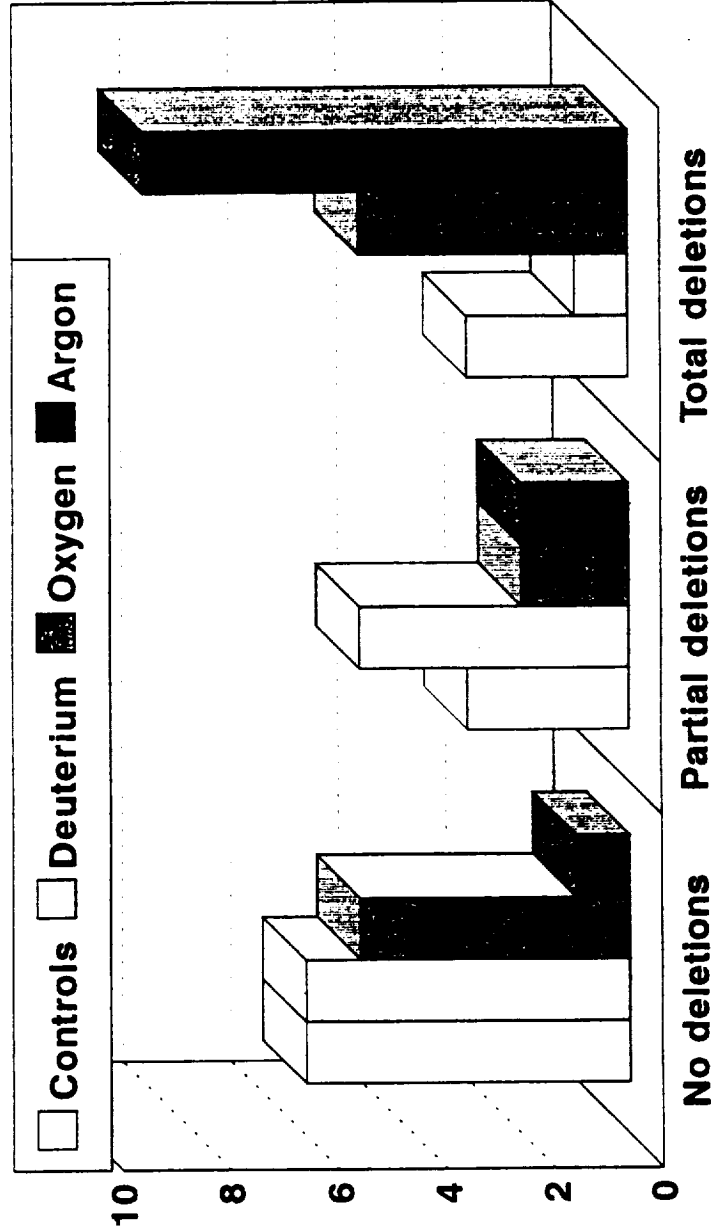

SCORT

Specialized Center of Research and Training

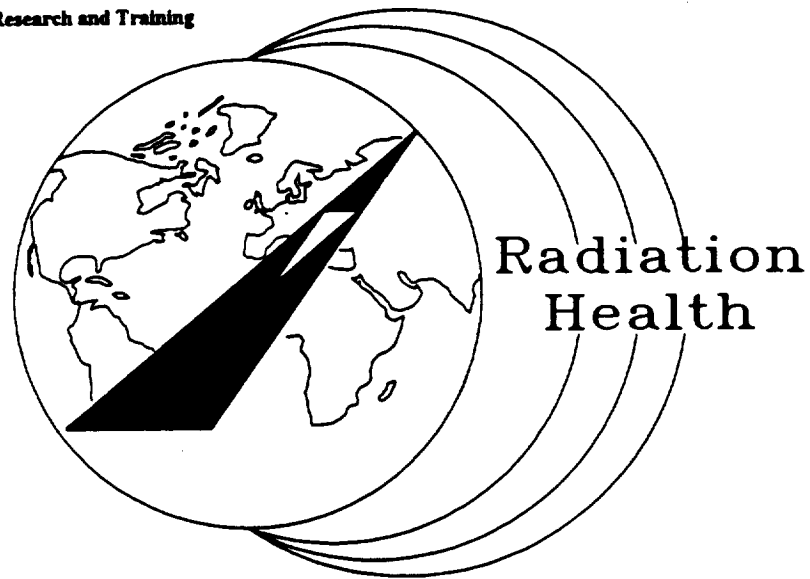

REPORT
1993/94

Gießen, Darmstadt, Köln, Siegen

COMMITTEE MEMBERS

J. Kiefer, Speaker
Strahlencentrum der
Justus-Liebig-Universität Gießen

G. Horneck, Deputy Speaker
DLR
Deutsche Forschungsanstalt
für Luft- und Raumfahrt
Institut für Luft- und Raumfahrtmedizin
Abteilung Strahlenbiologie

F. Anders
Institut für Genetik
Justus-Liebig-Universität Gießen

W. Heinrich
Fachbereich Physik
Universität GH Siegen

G. Kraft
GSI
Gesellschaft für Schwerionen-
forschung mbH Darmstadt

G. Reitz
DLR
Deutsche Forschungsanstalt
für Luft- und Raumfahrt
Institut für Luft- und Raumfahrtmedizin
Abteilung Strahlenbiologie

Scientific Secretary: E. Schneider, Gießen

Administration: Ina Allendörfer, Gießen

PARTICIPATING GROUPS

Strahlencentrum der Justus-Liebig-Universität Gießen Cell and Radiation Biophysics

Professor Dr. J. Kiefer

Scientists and graduate students

Dr. E. Schneider, Dr. M. Kost, Dr. M. Löbrich, Dr. U. Stoll

R. Egenolf, H.-D. Pross, P. Schmidt, U. Weidmann

S. Ikpeme (Nigerian Defense Academy, Kaduna, Nigeria)

A. Kassimu (Ahmadu Bello University, Zaria, Nigeria)

K. Santoso (Bogor Agricultural University, Bogor, Indonesia)

Prof. Wei Zenquan (Institute of Modern Physics, Academia Sinica, Lanzhou,
China)

Technical Staff: B. Beier, B. Barth, N. Scheerer, H. Schneider

DLR, Institute of Aeromedicine, Radiation Biology Division, Köln

Dr. G. Horneck, Dr. G. Reitz

Scientists and graduate students

Dr. R. Facius, Dr. P. Rettberg, Dr. M. Schäfer, Dr. J. U. Schott, Dr. J. Wehner

A. Anton, H. Zimmermann

Technical Staff: J. Helmig, K. Scherer, C. Schmitz, W. Strauch

Institute of Genetics, Justus-Liebig-Universität, Gießen

Professor Dr. F. Anders

Scientists and graduate students

Dr. A. Anders, P. Brix, C. Fleming, H. Gröger

Technical Staff: M. Meier, H. Schneider

Department of Physics, Universität GHS Siegen

Professor Dr. W. Heinrich

Scientists and graduate students

M. Schmitz, T. Streibel, H. Röscher, J. Dreute, S. E. Hirzebruch, G. Hüntrup

Gesellschaft für Schwerionenforschung, Biophysics Group, Darmstadt

Dr. G. Kraft

Scientists and graduate students

Dr. W. Kraft-Weyrather, Dr. S. Ritter, Dr. G. Taucher-Scholz

G. Becker, K. Füssel

Technical Staff: G. Becker, E. Kehr

ADDRESSES

- Prof. Dr. J. Kiefer
Strahlenzentrum der
Justus-Liebig-Universität, Gießen
Leihgesterner Weg 217
D-35392 Gießen

Tel.: ++49 641 702 2602

Fax: ++49 641 702 2672

- Dr. G. Horneck
DLR
Deutsche Forschungsanstalt für
Luft- und Raumfahrt
Institut für Luft- und Raumfahrtmedizin
Abt. Strahlenbiologie
Linder Höhe
D-51147 Köln

Tel.: ++49 2203 601 3594

Fax: ++49 2203 61970

- Dr. G. Reitz
DLR
Deutsche Forschungsanstalt für
Luft- und Raumfahrt
Institut für Luft- und Raumfahrtmedizin
Abt. Strahlenbiologie
Linder Höhe
D-51147 Köln

Tel.: ++49 2203 601 3137

Fax: ++49 2203 61970

- Dr. G. Kraft
GSI - Gesellschaft für
Schwerionenforschung mbG, Darmstadt
Planckstraße 1
D-64291 Darmstadt

Tel.: ++49 6151 359 2607

Fax: ++49 6151 359 2785

- Prof. Dr. W. Heinrich
Fachbereich Physik
Universität GH Siegen
Adolf-Reichwein-Straße
D-57076 Siegen

Tel.: ++49 271 740 4130
Fax: ++49 271 740 2330

- Prof. Dr. F. Anders
Genetisches Institut der
Justus-Liebig-Universität, Gießen
Heinrich-Buff-Ring 58
D-35392 Gießen

Tel.: ++49 641 74438
Fax: ++49 641 702 5903

PREFACE

The radiation field in space constitutes undoubtedly an important and largely unavoidable danger to astronauts. Its composition is vastly different from situations encountered on earth, not only in quantitative but above all also in qualitative terms. The possible danger related to this situation was not always realised in the early days since other problems appeared to be more imminent. With the technical developments achieved today which reduced the probabilities of technical failure and made space travel safer it was brought again to the attention of a wider part of the space community. Particularly with long term missions in outer space, e. g. to Mars or the installation of a lunar station, serious consideration about possible radiation hazards are in place. This was also realised by NASA when they sent out an "Announcement of Opportunity" in 1991 to establish "NASA Specialized Centers" in the field of "Radiation Health". The competition was world-wide. From Germany a consortium formed of the DLR Köln, GSI Darmstadt and the Universities of Siegen and Giessen applied with the "Strahlencentrum der Justus-Liebig- Universität Giessen" as the core institution. After a number of stages of peer reviews and a site visit by an international team of leading experts in the field NASA announced in fall 1991 that two institutions were selected, namely LBL Berkeley and the German consortium. Since according to bilateral agreements NASA does not finance centres in Germany negotiations had to be started with the German Space Agency DARA to support the planned activities. They were not always easy but in the end a way was found and the German centre was able to start its work by the beginning of 1993. It is not only my obligation but also my personal desire to thank at this place all the partners in the proceedings for their understanding and endurance to bring this adventure which did not have any precedence to a success. With this first report of the scientific activities in 1993 and the first half of 1994 we want to demonstrate what was started and to a certain extent already achieved. It marks only a beginning and a promise how to go on. The German SCORT differs from its American counterpart since it is only the rather loose cooperation of dedicated groups without a firm institutional framework. The driving force is the desire to bring together the expertise of a number of groups to solve scientific problems without formal requirements to cooperate. Its success rests entirely on the good-will and the spirit of the contributing groups but I feel that this is how it really should be. The German SCORT is thus a scientific "love affair" - not a bad starting point, I think.

The scientific activities are exclusively centred on ground-based research which does, however, not exclude that the groups also participate in space missions but this is not part of the centre. Because of the special nature of the radiation field in space experiments with heavy ions play a decisive role. We are very happy that we have access to the accelerators at GSI, and that this institution agreed to support the work of the German SCORT which is also documented by the fact that G. Kraft who heads the Biophysics group at GSI is a member of our committee. The long-standing experience of the DLR Köln in space experiments links our "theoretical" work with the "real" world out in space. The more basic questions in physical fundamentals are represented by W. Heinrich of the University of Siegen. Since the carcinogenic action of radiation is one of the urgent problems it appears to be very fortunate that we have also one of the leading experts for

oncogenes in our team, namely F. Anders of the University of Giessen who believed already in oncogenes when they were not as fashionable as they are today. The Biophysics Group of the University of Giessen will support the work in the fields of radiation mutagenesis and theoretical models.

As said above, work has just started and future will show how far we can get. The close contact with our American sister institution and the German space agency DARA is not only gratefully acknowledged but constitutes a permanent stimulus. Already in the past eighteen months we felt that the establishment of a centre like this attracts promising young students to the field, and this is the greatest capital we have. The initiative of NASA and the support of the other agencies and people mentioned above have done an important service to space research in particular and to science as a whole for which everybody involved deserves our thanks. Starting and continuation, however, would not have been possible without the help of many individuals who contributed in numerous ways - the participating groups and their heads, the administrations at the different places and here in Giessen my students and colleagues who spent a number of nights to bring the originally rather bizarre idea into its final shape.

The contributions of this report are under the responsibility of the authors. Much of the work is yet unpublished and should only be quoted after consultation with the respective persons. For the preparation of the present volume I should like to thank all contributors and for the final compilation and layout my coworkers Ralf Egenolf and Uwe Stoll and my secretary Ina Allendörfer who never loses her good mood even if I get nervous.

Giessen, July 1994

J. Kiefer

Contents

1	PROTON-INDUCED FRAGMENTATION OF CARBON AT ENERGIES BELOW 100 MeV	1
2	DOSIMETRY OF HEAVY IONS BY USE OF CCD DETECTORS	5
3	ESTIMATION OF SPATIALLY RESTRICTED LET USING TRACK STRUCTURE MODELS	11
4	HEAVY ION INDUCED DNA-DSB IN YEAST AND MAMMALIAN CELLS (STATUS REPORT)	15
5	INACTIVATION, DNA DOUBLE STRAND BREAK INDUCTION AND THEIR REJOINING IN BACTERIAL CELLS IRRADIATED WITH HEAVY IONS	18
6	DNA-DSB IN CHO-K1 CELLS INDUCED BY HEAVY IONS: BREAK REJOINING AND RESIDUAL DAMAGE (GSI)	23
7	CHROMOSOMAL DAMAGE OBSERVED IN FIRST POSTIRRADIATION METAPHASES OF REPAIR-PROFICIENT AND DEFICIENT CELL LINES	26
8	MUTATION INDUCTION IN BACTERIA AFTER HEAVY ION IRRADIATION	28
9	HEAVY ION INDUCED MUTATIONS IN MAMMALIAN CELLS: CROSS SECTIONS AND MOLECULAR ANALYSIS (STATUS REPORT)	30
10	HEAVY ION ACTION ON SINGLE CELLS: CELLULAR INACTIVATION CAPABILITY OF SINGLE ACCELERATED HEAVY IONS	33
11	COSMIC HEAVY ION TRACKS IN MESOSCOPIC BIOLOGICAL TEST OBJECTS.	36
12	X-RAY-PROVOKED NON-MENDELIAN TRANSGENERATIONAL ONCODETERMINANTS	41
	PUBLICATIONS	47
	CONFERENCE CONTRIBUTIONS, SEMINARS AND REPORTS	53
	DOCTORAL DISSERTATIONS	60

1 PROTON-INDUCED FRAGMENTATION OF CARBON AT ENERGIES BELOW 100 MeV

M. Schmitz, T. Streibel, H. Röcher, J. Dreute, S.E. Hirzebruch, G. Hüntrup and W. Heinrich

Scientific Objectives

Radiation effects caused by single cosmic ray particles have been studied for many years in radiobiological experiments for different biological objects and biological end-points. Additionally, single event effects in microelectronic devices have gained large interest. There are two fundamental mechanisms by which a single particle can cause radiation effects. On the one hand, a cosmic ray ion with high linear energy transfer can deposit a high dose along its path. On the other hand, in a nuclear collision, a high dose can be deposited by short range particles emitted from the target nucleus. In low earth orbits a large contribution to target fragmentation events originates from trapped protons which are encountered in the South Atlantic Anomaly. These protons have energies up to a few hundred MeV.

We study the fragmentation of C, O and Si nuclei - the target nuclei of biological material and microelectronic devices - in nuclear collisions. Our aim is to measure production cross sections, energy spectra, emission directions and charge correlations of the emitted fragments. The present knowledge concerning these data is rather poor. M. Alurralde et al. [1] have calculated cross sections and average energies of fragments produced from Si using the cascade-evaporation model. D.M. Ngo et al. [2] have used the semiempirical cross section formula of Silberberg and Tsao [3] to calculate fragment yields and the statistical model of Goldhaber [4] to describe the reaction kinematics. Cross sections used in these models have uncertainties within a factor of two. Our data will help to test and improve existing models especially for energies below 300 MeV/nucleon. Charge correlations of fragments emitted in the same interaction are of particular importance, since high doses can be deposited if more than one heavy fragment with a short range is produced.

Experimental Method

The experiments are performed in inverse kinematics, using C, O and Si projectiles of the GSI SIS accelerator with energies of about 100 MeV/nucleon in combination with C and CH₂ targets. Thus the projectile fragments have energies which are sufficiently high to allow them to escape from the target. They move within a cone into forward direction. The incoming projectiles and outgoing fragments are measured using CR-39 plastic nuclear track detectors. These are mounted upstream and downstream the target. In our experiments we measure the charges and the emission angles of the fragments. Based on these data fragmentation cross sections and transverse momenta can be determined including all fragments with $Z \geq 2$. From the results for C and CH₂ targets the interaction characteristics for collisions with H target are derived. Results with high statistical significance can be achieved based on completely computerized track measurements of the etch cones in the detector foils [5].

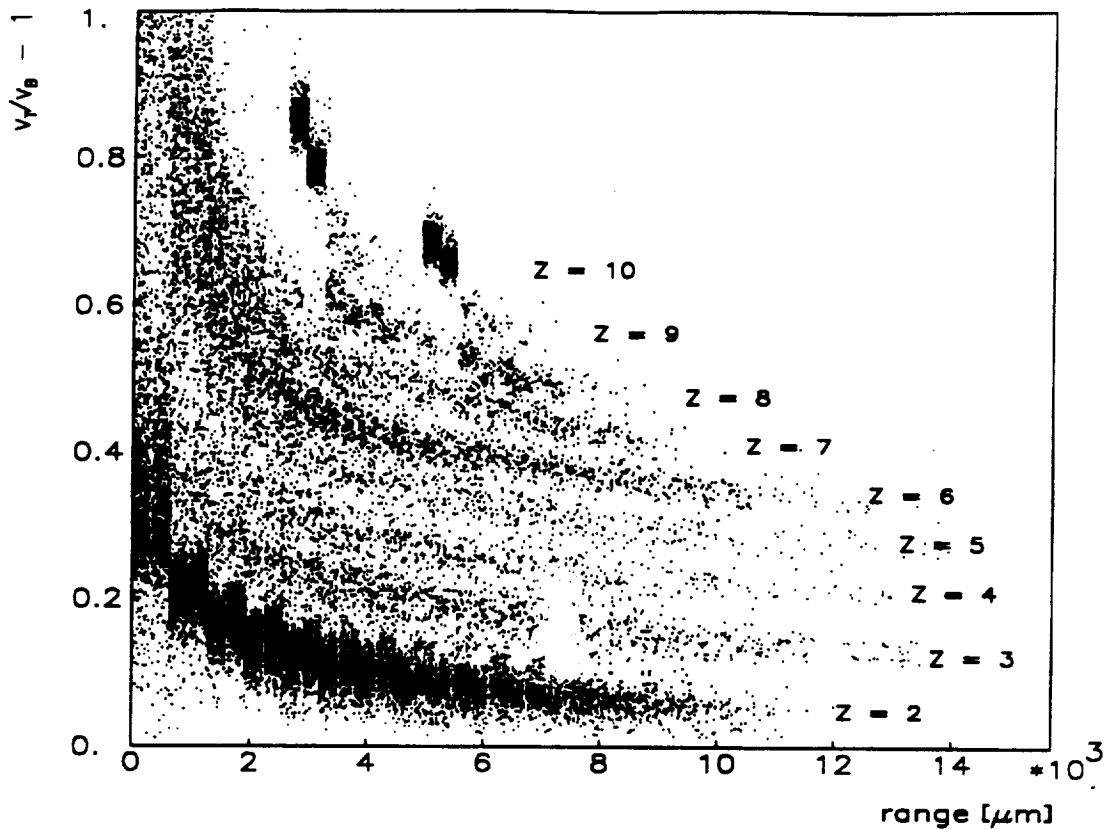

Figure 1: Track size as a function of residual range for Ne projectiles and projectile fragments produced in a CH_2 target. The track size is measured by the ratio of track etch rate v_T to bulk etch rate v_B .

Status of the Experiments:

Beam time for these experiments has been approved by the GSI Experiment- ausschuss. Exposures of our experimental setups will be performed in cave A of the SIS when the appropriate beams are scheduled. This will be frequently the case for C and O beams, since these ions are used in the GSI therapy project.

To develop the experimental technique we have started the investigations in 1993 with a prototype experiment exposed to 65 MeV/nucleon Ne ions. Fragments with charges between 2 and 9 and penetrating projectile nuclei with charge 10 have been measured behind the target. The trajectories of these particles have been reconstructed through the CR-39 stack. In figure 1 the measured track size for the individual etch cones is shown as a function of the residual range of the particles. These results show that charge resolution is excellent. The fragment production cross sections can be determined based on the fragment yields. Transverse momenta can be deduced from the angles of the fragments' trajectories in relation to the beam direction.

Recently (end of May 1994) a C beam of 80 MeV/nucleon was available. We have exposed 10 stacks with CH_2 target and 6 stacks with C target to the beam. The analysis of these stacks will provide cross sections and transverse momenta with reasonable statistical

significance for the fragmentation of C nuclei hit by a 80 MeV proton.

References

- [1] M.Alurralde et al., IEEE Trans. NS 38, 1210 (1991)
- [2] D.M.Ngo et al., IEEE Trans. NS 38, 2 (1991)
- [3] R.Silberberg, C.H.Tsao, Astrophys. J. Suppl. 25, 315 (1973)
- [4] A.S.Goldhaber, Phys. Lett. 53B, 306 (1974)
- [5] W.Trakowski et al., Nucl. Instrum. Methods 225, 92 (1984)

2 DOSIMETRY OF HEAVY IONS BY USE OF CCD DETECTORS

J.U. Schott

ABSTRACT

The design and the atomic composition of Charge Coupled Devices (CCDs) make them unique for investigations of single energetic particle events. As detector system for ionizing particles they detect single particles with local resolution and near real time particle tracking. In combination with its properties as optical sensor, particle transversals of single particles are to be correlated to any objects attached to the light sensitive surface of the sensor by simple imaging of their shadow and subsequent image analysis of both, optical image and particle effects, observed in affected pixels. With biological objects it is possible for the first time to investigate effects of single heavy ions in tissue or extinguished organs of metabolizing (i.e. moving) systems with a local resolution better than 15 microns. Calibration data for particle detection in CCDs are presented for low energetic protons and heavy ions.

INTRODUCTION

Typical experiments with single heavy ions in physics and applied sciences make use of particle track detectors for particle counting, the analysis of its parameters and geometrical correlations of the accumulated particle tracks. Their well fitting into the requirements of many experiments on earth and in space, easy handling, simple set ups, high efficiency, high reliability and low cost, enforced the investigation and development of a big variety of different detector materials and systems. However, the basic electronic and ionic properties of track forming solids rules out the acquisition of time resolved information, in general. Except with AgCl detectors [1], local and temporal data of single particles can be achieved in extended experimental set ups, only, i.e. [2]. Charge sensitive semiconducting micro devices, arranged as matrix elements on a silicon layer give access to both: time resolved data from prompt electronic signals or read out sequences, as well as local information from the position of the responding element. Out of the big variety of high integrated electronic circuits like memories and charge sensors, Charge Coupled Devices (CCDs) combine particle detector qualities with optical sensing, an interesting feature for applications in many fields with time resolved single particle experiments [3]. Easy handling and read out with well established methods of TV techniques and image analysis together with their high resistance against the environmental factors of space flight makes them useful for basic radiobiological investigations with metabolizing systems in the space radiation field. Geometric measurement of particle transversals are simply derived from column and line numbers of pixels affected. The correlation of particle effects measured in single pixels with parameters of the particle are to be investigated at accelerators.

DETECTION OF PARTICLES IN CCDs

The use of CCDs for particle detection is based on the detection of charge carriers being produced by transversing ionizing particles, separated and stored in single pixels, thereafter.

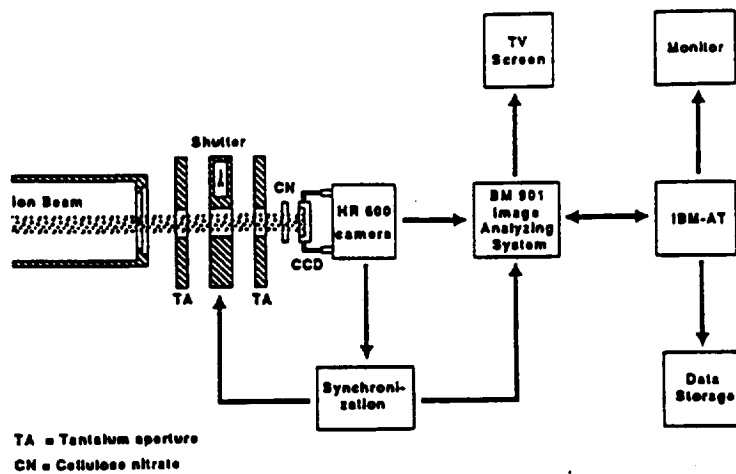

Figure 1: Experimental set up.

Out of all imaging sensor concepts, CCDs of the frame transfer type guarantee a full area sensitivity with a clear-cut correlation of the loci of charge production and storage to the co-ordinates of the read out channels of the pixel matrix.

METHODS AND INSTRUMENTATION

In order to simplify the overall instrumentation for the data acquisition of particle detection and optical imaging, we decided to use standard TV techniques and image analysis. The response of single pixels of a 1/2" format VALVO sensor type NXA 1011 with 600 x 576 pixels of $10 \times 15 \mu\text{m}$ of size, used in a AQUA camera type HR 600 has been analyzed with an image analyzing system BM 901. It permits to digitize and store the data of a sequence of up to 8 full frames with a resolution of 8 bit in real time. Fig. 1 shows the experimental set up.

For a clear correlation of data measured to the effect of ionizing particles, some measures have been taken into account:

- 1.) The exposures are to be limited to the integration phase of one frame (particle image), only, in order to avoid potential permanent damage of pixels by single high LET particles or by accumulating effects. A TV synchronized shutter system permits short particle exposures into one single frame.

- 2.) In order to discriminate against the response of single pixels due to any other reason than to actual particle exposure, the particle images have been corrected with frames (dark images) taken prior to the particle exposure, pixel wise.

- 3.) In the case of particles with sufficiently high linear energy transfer (LET) and range, a $100 \mu\text{m}$ thick cellulose nitrate (CN) foil in front of the CCD has been exposed together with the particle image for comparison purpose of the pattern of effects on both systems.

CALIBRATIONS

Exposures have been performed with protons, alpha particles and low energetic heavier ions at the accelerator of the University of Frankfurt, with heavy ions of medium energy at

Linie	Column								
	610	611	612	613	614	615	616	617	618
324	0	0	0	0	0	0	1	0	0
322	0	0	1	0	0	0	0	0	0
320	0	0	0	0	0	0	0	0	1
318	0	0	30	156	134	48	36	0	0
316	0	2	48	196	161	48	37	0	0
314	2	0	21	128	115	39	17	0	0
312	0	0	0	4	4	0	0	0	0
310	0	0	0	0	0	1	0	0	1
308	0	0	1	0	0	0	0	0	0

Table 1: Single Event upset in a NXA 1011 charge coupled device caused by an uranium ion (15 MeV/u). Numbers give the 8 bit digitized read out of the pixel elements of the corrected matrix.

GSI, and at GANIL with even higher energies at typical fluxes of $10^4 - 10^5$ particles/cm²s.

The particle exposures result in bright dots on the screen. On the digitized image one or more pixels show significantly higher amplitudes than the average of all. Table 1 shows an event from an uranium ion of 15 MeV/u in an 8 bit-digitized half image. The low background is due to a correction of the pixel matrix with an dark image taken before particle exposure.

A quantitative evaluation of the particle frames is managed by a software package. Using an iterative process, it determines the background in the pixel matrix as the mean of those pixels obviously not belonging to a particle event, and it detects pixels with values being significantly higher than the calculated background. Neighbouring detected pixel elements are put together as particle event. Thereafter a statistical evaluation is performed with respect to individual parameters of the event [4]. In a first step, the mean value of the sum of all pixel elements of each event has been plotted as signal/event against the LET of the particle. In order to exclude noise contributions of single pixel elements, events with a dimension of less than 2 pixel elements along a TV-line have been eliminated.

Fig. 2 shows spectra of particle events with more than one responding pixel as function of the contribution of all corresponding pixels from protons of different energy and 0.5 MeV/n argon ions. Fig. 3 shows the response of low energetic particles (< 5 MeV/n) in one of the tested CCDs at normal incidence against LET.

DISCUSSION

Assuming, that the effect of charged particles is based on ionization and charge separation only (damage on the semiconducting matrix, the insulation layers and dynamic effects being neglected), the pixel elements should show a linear response over a broad range of LET. Its lower limitation is given by the reset noise of thermal electrons and corresponds to a particle LET of about 6 MeV cm²/g at room temperature. The upper limit is given by the storage capacity for electrons at an LET of some 10⁴ MeV cm²/g.

For low energetic heavy ions, the linearity of the response with LET seems to be reasonable. However, from recent exposures with high energetic heavy ions, we have reason to doubt, that the radiation effects can be described by the LET of the particle.

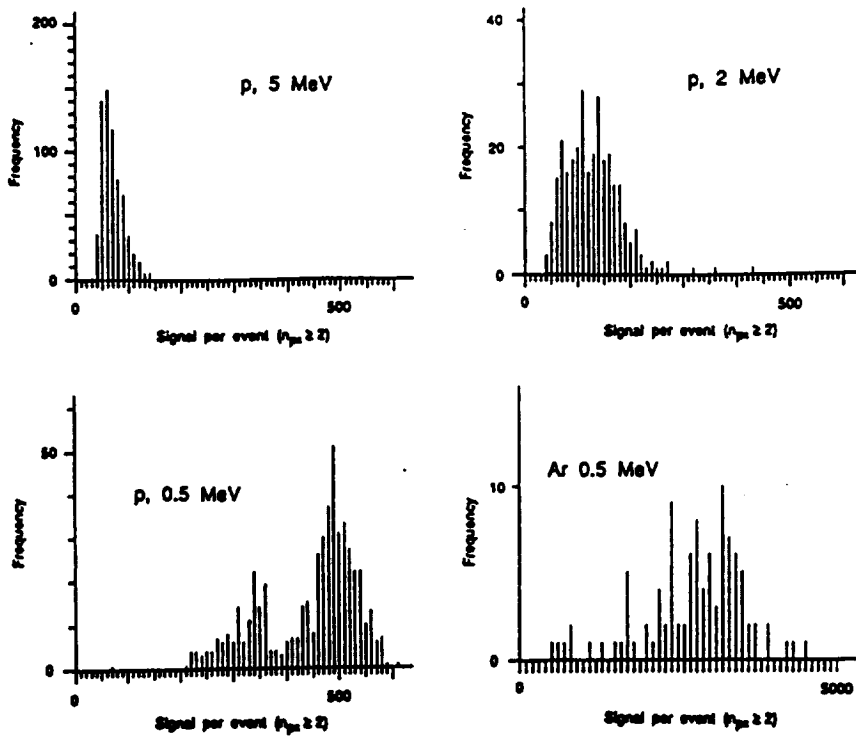

Figure 2: Spectra of proton and Ar particle events.

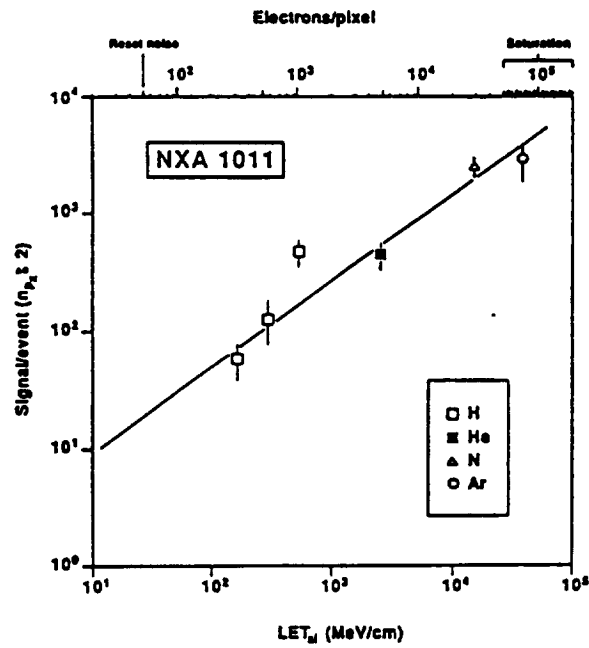

Figure 3: Response of CCD type NXA 1011 plotted against LET. The upper abscissa gives the transformation of LET into the number of electrons per pixel element neglecting other mechanisms than the production of free electrons.

only. First evaluations of exposures with Xe ions of 40 and 400 MeV/u at GANIL and SIS at GSI show a reduced response.

The local resolution for low ionizing particles with an one or two pixel response is limited to the pixel size of $10 \times 15 \mu m$. For high LET particles, forming events of big clusters of responding pixels, a better resolution is to be expected from an analysis of its charge distribution, in spite of some limitations due to structural inhomogeneity of the CCD matrix [5].

The time resolution is limited by the integration phase of the CCD to 20 ms, according to the instrumentation with standard TV equipment. Leaving standards, it can be increased by orders of magnitude [6].

CONCLUSIONS

It has been shown, that CCDs can be used as time resolving detector for ionizing particles with high local resolution. Low energetic particles show a fairly linear response with LET. For the determination of high energetic particles a new concept is under development. It makes use of the angular distribution of electrons, being ejected out of a thin foil at a short distance on top of the sensors surface and detected in pixels in the vicinity of the particle trajectory. Easy read out, data analysis and high resistivity against mechanical stress factors makes these devices suitable for single particle dosimetry on ground as well as in space environments. For the EUROMIR'95 mission a telescopic device of CCDs for the detection of charged particles inside the spacecraft has been accepted, adequate hardware and software is under development. Together with their optical properties as image sensor, radiobiological investigations of single particle effects in microscopic targets with individual track correlation can be extended to metabolizing (moving) biological objects for the first time [7].

Acknowledgements

For their support with charge coupled devices and exposure facilities Philips Imaging Technology (Eindhoven), GSI (Darmstadt), GANIL (Caen), and IKF (Frankfurt) are gratefully acknowledged.

References

- [1] Schopper E., Granzer G., Henig G., Schott J.U., Dardat K., Wendnagel Th., Haasa G., Zörrgiebel F., Proc. of the 8th Conf. on Nuclear Photography and Solid State Track Detectors, M. Nicolai (ed.), Bucarest (1972).
- [2] Beaujean R., Schmidt M., Enge W., Siegmon G., Krause J., Fischer E., Isotopic Stack: Measurement of Heavy Cosmic Rays, Science, Vol. 225, No. 4658, 193-195 (1984).
- [3] Schott J.U., Charge Coupled Devices (CCDs) - A detector system for particles with time resolution and local assignment with particle trajectories, Nucl. Tracks Radiat. Meas. 15, Nos 1-4, 81-89 (1988).
- [4] Lichtenberg G., Erfassung und Auswertung schwerioneninduzierter Ladungsbilder in CCD-Elementen, Diploma Thesis. Fachhochschule Giessen/DLR (1989).

- [5] Damerell C.J.S., Farley F.J.M., Gillman A.R., Wickens F.J., Charge Coupled Devices for particle detection with high spatial resolution, Nucl. Instr. and Meth. 185, 33-42 (1981).
- [6] Burt D.J., CCD performance limitations: theory and practice, Nucl. Instr. and Meth., A305, 564-573 (1991).
- [7] Schott J.U., Kranz A.R., Gartenbach K., Zimmermann M., Investigations of single particle effects in active metabolizing seedlings of *Arabidopsis thaliana*, Nuclear Physics at GANIL, Scientific Report 1989-1991.

3 ESTIMATION OF SPATIALLY RESTRICTED LET USING TRACK STRUCTURE MODELS

J. Kiefer

The spatial distribution of energy deposition is an important determinant in the formation of biologically significant lesions. It has been widely realized that Linear Energy Transfer (LET) being an average quantity is not sufficient to describe the situation at a submicroscopic scale. To remedy this to some extent "energy-cut-off" values are sometimes used but since they are related to secondary electron energy and only indirectly to their range they are also not adequate although they may be easily calculated (ICRU 1970). "Range-restricted LET" appears to be better but its determination is usually quite involved. Xapsos (1992) suggested a semi-empirical approximation based on a modified Bethe-formula which contains a number of assumption which are difficult to verify. A simpler and easier way is to use existing beam-models which describe energy deposition around an ions path (see e. g. Kiefer and Kost 1988 and references therein). They all agree that the energy density (i. e. energy deposited per unit mass) decreases with the inverse square of the distance from the track centre. This simple dependence can be used to determine the fraction of total LET which is deposited in a cylinder of a given radius. As an example our own beam model (Kiefer and Straaten 1986) is used. Energy density depends on distance x (measured in m) from the track centre according to the formula

$$\rho = C \frac{Z^{*2}}{\beta^2} \frac{1}{x^2} \quad (1)$$

where Z^* is the effective ion energy, β its velocity relative to that of light in vacuo and x the distance from the track centre. The coefficient $C = 0.78 \text{ eV/m}$ for water, the energy density is then given in eV/m^3 . Total LET (LET_∞) is obtained by integration over all concentric shells from a lower limit x_0 to the penumbra radius x_p

$$LET_\infty = 2\pi C \frac{Z^{*2}}{\beta^2} \int \frac{1}{x} dx = 2\pi C \frac{Z^{*2}}{\beta^2} \ln \frac{x_p}{x_0} \quad (2)$$

The lower limit x_0 is not defined and is chosen so that the correct LET-value is obtained:

$$x_0 = x_p \exp\left(-\frac{LET_\infty}{2\pi} C \frac{Z^{*2}}{\beta^2}\right) \quad (3)$$

The range-restricted $LET_\Delta(r)$ within a radius r can be calculated in an analogous way

$$LET_\Delta = 2\pi C \frac{Z^{*2}}{\beta^2} \ln \frac{r}{x_0} \quad (4)$$

The fraction f_r of total energy deposition within the cylinder is then

$$f_r = \frac{LET_\Delta}{LET_\infty} = \frac{\ln \frac{r}{x_0}}{\ln \frac{x_p}{x_0}} \quad (5)$$

This can be rewritten using equ. (3) as

$$LET_\Delta = 1 - 2\pi C \frac{Z^{*2}}{\beta^2} \ln \frac{x_p}{r} \quad (6)$$

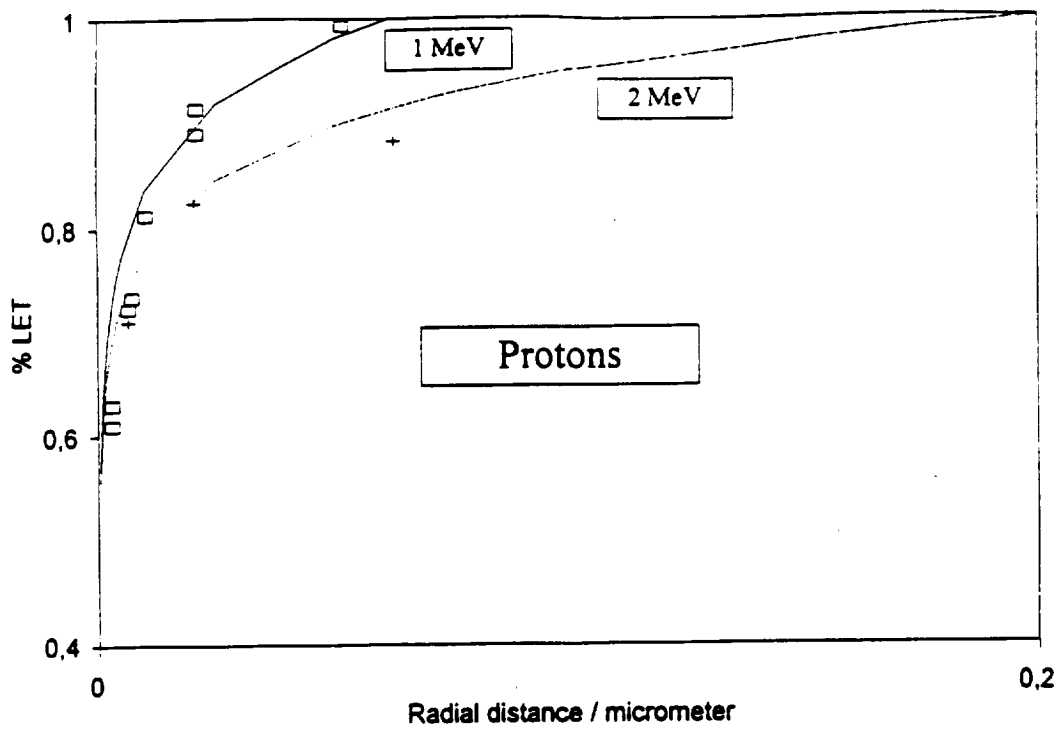

Figure 4:

Since LET scales with $\frac{Z^2}{\beta^2}$ the term before the logarithm is independent of ion charge and changes only with its specific energy. As an example figure 1 displays a comparison between the present theoretical approach and measurements of Wingate and Baum (1976). It is seen that the differences are quite small and give credence to the calculations.

Within the framework of our beam model equ. (6) can also be written in another form. Since the penumbra radius x_p depends only on the ion specific energy E

$$x_p = 0.0616E^{1.7} \quad (7)$$

it takes the form

$$f_r = 1 - 2\pi C \frac{Z^2}{\beta^2 LET_\infty} (1.7 \ln E - \ln r - 4.135) \quad (8)$$

which may be easier for some calculations.

The advantage of the here suggested way to determine range restricted LET is not only the simplicity of calculation but rather more that it starts with a beam model which is compatible with experimental data. No further assumptions are necessary than the $\frac{1}{r^2}$ -dependence of the energy density -which is well supported by measurements- and the penumbra extension. The latter, however, is not very critical since it is contained only in a logarithmic term.

References

- [1] ICRU 16, Int. Commission on Radiation Units and Measurements (1970): Linear energy transfer. ICRU: Washington.

- [2] Kiefer, J.; Kost M. (1988): Fine structure of energy deposition - introductory remarks, in: Quantitative mathematical models in radiation biology (J. Kiefer, Ed.), SPRINGER: Berlin - Heidelberg, pp.29-40
- [3] Kiefer, J.; Straaten, H. (1986): A model of ion track structure based on classical collision dynamics, Phys. Med. Biol. 31, 1201-1209
- [4] Xapsos, M. A. (1992): A spatially restricted linear energy transfer, Rad. Res. 132,282
- [5] Wingate, C. L.; Baum, J. W. (1976): Measured radial distribution of dose and LET for alpha and proton beams in hydrogen and tissue-equivalent gas. Rad. Res. 65,1-19

4 HEAVY ION INDUCED DNA-DSB IN YEAST AND MAMMALIAN CELLS (STATUS REPORT)

M. Löbrich, S. Ikpeme, J. Kiefer

Molecular changes at the DNA are assumed to be the main cause for radiation effects in a number of organisms. During the course of the last decades techniques have been developed for measuring DNA double-strand breaks (dsb), generally assumed to be the most critical DNA lesions. The outcome of all those different approaches portray a collection of data useful for a theoretical description of radiation action mechanisms. However, in the case of heavy ion induced DNA dsb the picture is not quite clear yet and further projects and strategies have to be developed.

The biological systems studied in our group are yeast and mammalian cells. While in the case of yeast cells technical and methodical reasons highlight these organisms mammalian cells reach greater importance when dsb repair studies are performed. In both types of organisms the technique of pulsed-field gel electrophoresis (PFGE) is applied, although with different modifications and evaluation procedures mainly due to the different genome sizes.

Yeast cells

Yeast chromosomes are in the size range that can be resolved by PFGE-technique. After the gel run the DNA molecules are labelled with the aid of a fluorescent dye, and the signal is recorded by a CCD camera system. The single bands, representing the different chromosomes of the yeast strains used, can be quantitated by a dedicated software and the intensity of the uppermost band, which represents the largest chromosome, can be used for the determination of the dsb induction frequency. It is assumed in this evaluation procedure that a decrease in band intensity to 37 resembles on average one break per molecule. Table I summarizes the results of several experiments performed at the UNILAC-facility in Darmstadt. The ions used were in the LET range of 100 to 11500 keV/ μ m and had energies between 3 and 18 MeV/n. So far no experiments with the much faster ions at the SIS facility have been performed. Figure 1 shows the dsb induction cross section of all the experiments (with yeast and mammalian cells) as a function of LET. Clearly, the cross section and hence the probability for dsb induction rises for values up to about 300 keV/ μ m. This region is followed by a plateau in the LET range between 300 and 1500 keV/ μ m, while for even higher values the cross sections increase again. This second rise probably reflects the importance of the far reaching delta-electrons, which build up the so called "ion-penumbra". The results fit almost perfect into the picture which was generated in the last years in our group by means of the sedimentation technique.

Mammalian cells

The mammalian chromosomes are too large to be resolved by PFGE technique. In order to circumvent this problem the chromosomes are treated with rarely cutting restriction enzymes prior to electrophoresis. The endonucleases cut the DNA at specific sequences yielding for all cells the same restriction pattern which appears after electrophoresis as a restriction fragment distribution. In the described experiments the enzyme NotI was used which delivered fragments in the size range of about 0.2 to 5 Megabasepairs (Mbp). To examine only one single fragment instead of the whole distribution (analogous to the

P.P.

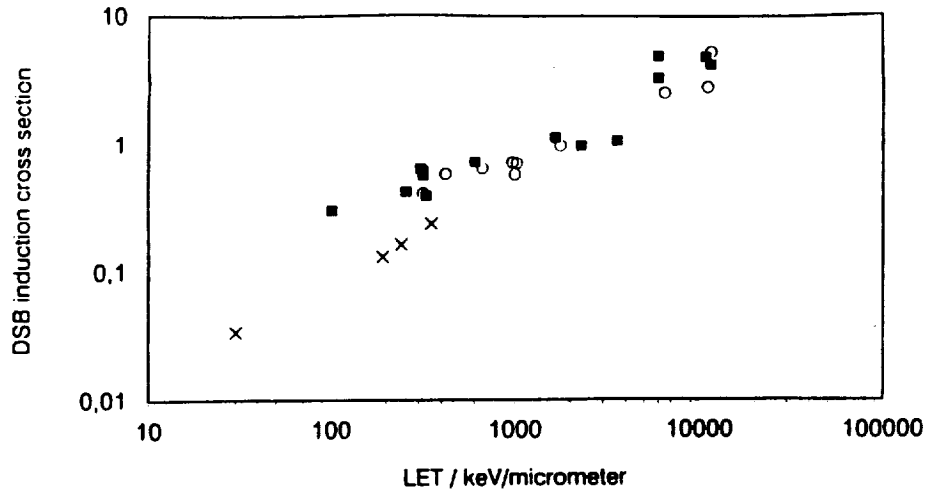

Figure 1: DNA-DSB versus LET: boxes: PFGE (Yeast), open circles: Sedimentation (Yeast), x: PFGE (Mammalian cells).

Table 1: Cross-sections for DNA-DSB for various ions, measured by means of pulsed-field gel electrophoresis.

Ion	Energy MeV/u	LET keV/ μ m	σ_{dsb} μ m ²	RBE
C	18	100	0.3	2.3
	3.4	330	0.4	0.9
O	10.7	256	0.4	1.3
	8	316	0.6	1.6
	2.9	604	0.7	0.9
Ne	15	306	0.6	1.5
	14.4	316	0.6	1.5
Ar	5.7	1650	1.1	0.5
Kr	11.2	1600	1.1	0.2
Ni	12.1	2280	1.0	0.3
Xe	14	5980	4.9	0.6
	14	5980	3.3	0.4
Au	11.7	10980	4.9	0.3
	9.3	11600	4.2	0.3

Ion	Energy MeV/u	LET keV/ μ m	σ_{dsb} μ m	RBE	% remaining (PFGE)	% remaining (Elution)
(X-ray)	-	0.3	-	1	32	15
Ne	425	32	0.034	0.76	41	31
Fe	600	190	0.24	0.48	70	68
Fe	400	240	0.16	0.48	-	-
Fe	250	350	0.13	0.48	-	-

Table 2: Data for DSB-induktion in mammalian cells. Cross-sections are normalized to a DNA-mass of 10^9 g/mol as in yeast.

situation with yeast cells) the method of "Southern hybridization" with radioactively labelled "single copy" DNA-probes was applied. Those probes bind to a DNA sequence which appears only once in the human genome and therefore only on one restriction fragment. Consequently, the restriction fragment size distribution can be reduced to a single band by analyzing the radioactive hybridization signal. The decrease of this band delivers the dsb induction rate analogous to the yeast method.

Experiments for dsb induction have been performed at the BEVALAC facility in Berkeley, CA with Ne and Fe ions inside the energy range of 250 to 600 MeV/n with the corresponding LET values of 30 to 350 keV/ μ m (see table 2). The relative biological effectiveness (RBE) for dsb induction was always found to be smaller than unity (compared to X-rays) what could be explained by dsb-"cluster" inside the "ion-core" where an extremely high energy density occurs. Inside this region close to the ion trajectory the breaks are induced too close to each other to be resolved as different breaks and hence counted by all available techniques only as one. Since approximately only half of the energy is deposited inside the "core" region, the RBE is not expected to decrease below 0.5.

For dsb repair experiments the described method (called PFGE in the table) was compared with the elution approach that measures only a change in molecular weight and therefore cannot distinguish between correct and incorrect dsb rejoining events. Since the PFGE method registers only the correct rejoining and hence the real repair events (since the band with the correct molecular weight has to reappear after a certain repair time to contribute to rejoining) the respective values for remaining breaks always lie above the values for the elution approach (see table 2). As the differences between the two methods are most significant for sparsely ionizing radiation, mis-repair events take place in that case that probably serve as a "life-saving" mechanism. The fact that the proportion of unrepaired/unrejoined breaks increases with LET again reflects most likely the appearance of dsb-"clusters", since in this case all breaks of a "cluster" have to be rejoined in order to register a rejoining event.

5 INACTIVATION, DNA DOUBLE STRAND BREAK INDUCTION AND THEIR REJOINING IN BACTERIAL CELLS IRRADIATED WITH HEAVY IONS

N95-32724

M. Schäfer, H. Zimmermann, C. Schmitz

Besides inactivation one of the major interest in our experiments is to study the primary damage in the DNA double strand breaks (DSB) after heavy ion irradiation [1]. These damages lead not only to cell death but also under repair activities to mutations. In further experiments we have investigated the inactivation with two different strains of *Deinococcus radiodurans* (R1, Rec 30) and the induction of DSB as well as the rejoining of DSB in stationary cells of *E. coli* (strain B/r) irradiated with radiations of different quality. In the latter case irradiations were done so that the cell survival was roughly at the same level. We measured the DSB using the pulse field gelelectrophoresis [2] which allows to separate between intact (circular) and damaged (linear) DNA. The irradiated cells were transferred to NB medium and incubated for different times to allow rejoining.

INACTIVATION OF DEINOCOCCUS CELLS

The radiosensitive *Deiococcus*-mutant Rec 30 differs distinctly in the response to sparseley ionizing radiation in comparison to the wildtype *D. radiodurans* R1 [3]. The inactivation curve after X-irradiation is exponential, whereas the curve of the wildtype has a broad shoulder [4]. The radiosensitivity of Rec 30 expressed by the slope of the curve is about 20 times higher as that of the wildtype.

First experiments were made to study the survival of Rec 30 after heavy ion irradiation. Fig. 1 shows the inactivation curves of Rec 30 after C- and U-irradiation. The calculated cross sections from the survival curves (table 1) show significant differences in comparison to the wildtype, where the cross sections were calculated from the exponential part of the survival curve. In case of heavy ion irradiation we find that the cross sections of both strains differ by factors (C: 10, U: 2 and 6) that do not correspond with their X-ray radiosensitivities. After U-irradiation the differences of the obtained cross sections for the two strains become smaller with decreasing energy of the ion. The same effect was measured by Baltschukat [5] for different strains of *Bacillus subtilis*. In comparison to the inactivation cross sections of *E. coli* B/r and *Bacillus subtilis* measured by Schäfer et al. [6],[7] the data of Rec 30 fit well to the data of *E. coli* B/r while the data obtained for *D. radiodurans* R1 are similar to those of *Bacillus subtilis*.

Table 1: Inactivation cross sections (σ_i) of *D. radiodurans* R1 and the mutant Rec 30 after irradiation with C (11,0 MeV/u) and U (1,7 and 3,4 MeV/u)

Ion	Energy MeV/u	<i>D. radiodurans</i> R1 $\sigma_i/\mu\text{m}^2$	Rec 30 $\sigma_i/\mu\text{m}^2$
C	11.0	0.026 ± 0.004	0.233 ± 0.142
U	1.7	0.616 ± 0.025	1.331 ± 0.448
U	3.4	0.888 ± 0.128	5.577 ± 0.625

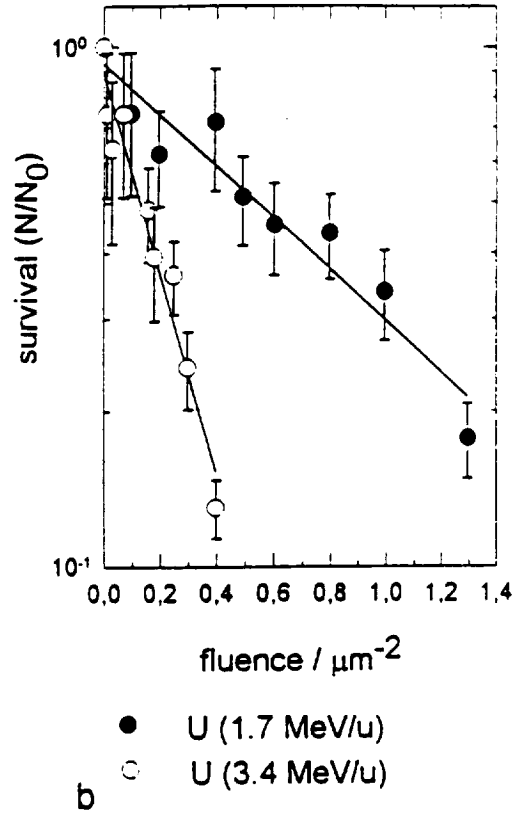
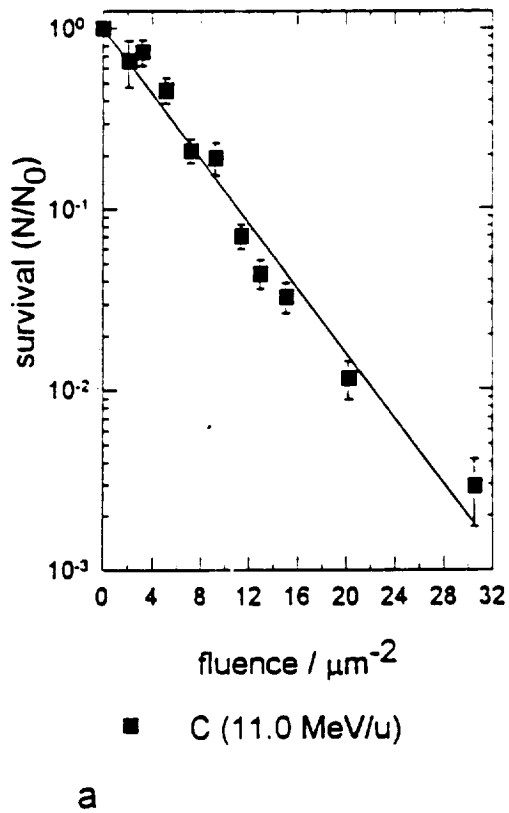

Figure 1: Survival curves of the Deincoccus-mutant Rec 30 after irradiation with C-(a) and U-ions (b)

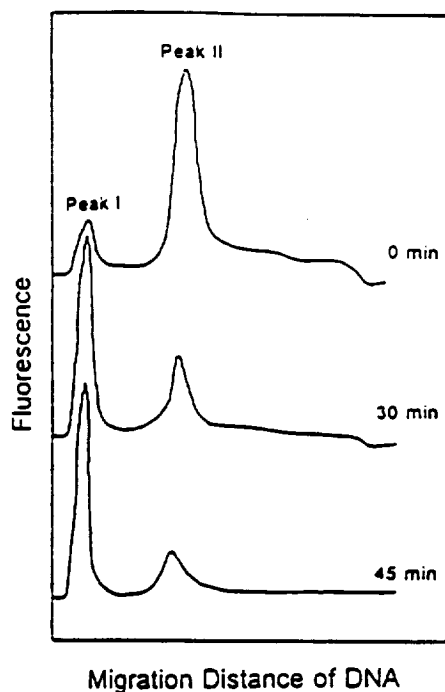

Figure 2: Scan profile of samples at selected repair times (Ni-ions: $E = 650 \text{ MeV/u}$, survival = 0.03)

DSB INDUCTION AND REJOINING OF DSB IN E. COLI CELLS

In order to measure the rejoining kinetics of DSB we can determine the increase of intact DNA in the agarose plugs or the decrease of damaged DNA which is able to move in the gel. Fig. 2 gives the scan profiles at some repair times demonstrating both the increase of DNA content in peak I and the decrease in peak II, respectively.

The results described here (Fig. 3) are based on the analysis of the DNA content in the agarose plugs. This method is limited up to about 60 min because at larger times cell growing in the nutrient medium is not neglectable. For some repair experiments we found that the total amount of DNA decreases continuously for increasing times. One possible explanation could be that a number of cells undergo lysis when incubated in the NB medium. Therefore, we have determined the amount of DNA relative to the total amount for each sample and plotted as a function of the repair time in Fig. 3. The data qualitatively show that repair activity is started without any time delay for different ions varying in their energies and X-rays. Also, we find that the number of breaks rejoined per time intervall depends on time and is remarkably reduced above 30 min. From the low number of experiments it is yet unclear whether the effects could be dependent also on the radiation quality. In principal, these results correspond to the break rejoining kinetics in other cell types.

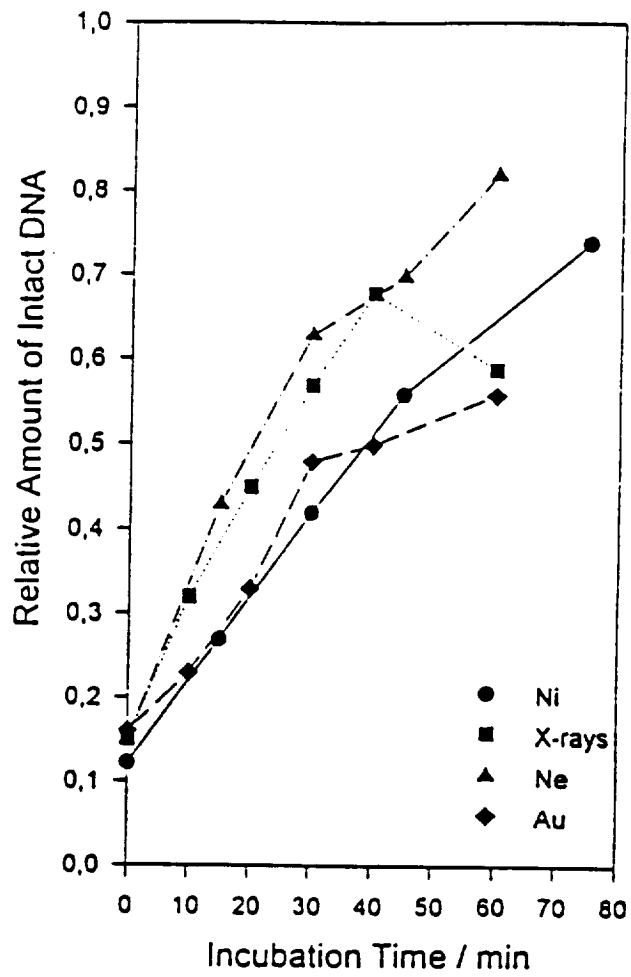

Figure 3: Dependence of the relative amount of DNA in the plug (Peak I) as a function of the repair time for different ions.

References

- [1] M. Schäfer et al., Adv. Space Res. in press
- [2] D.C. Schwartz and S.R. Cantor, Cell 37, 67 (1984)
- [3] B.E.B. Moseley and H.J.R. Copland, J. Bacteriol. 121, 422-428 (1975)
- [4] B.E.B. Moseley, Photobiol. Photochem. Rev. 7, 223-275 (1986)
- [5] K. Baltschukat and G. Horneck, Radiat. Environ. Biophys. 30, 87-103 (1991)
- [6] M. Schäfer, R. Facius, H. Bückner, GSI Report, 193 (1982)
- [7] M. Schäfer, R. Facius, H. Bückner, GSI Report, 213 (1986)

6 DNA-DSB IN CHO-K1 CELLS INDUCED BY HEAVY IONS: BREAK REJOINING AND RESIDUAL DAMAGE (GSI)

G. Taucher-Scholz, J. Heilmann, G. Becher, G. Kraft

DNA double strand breaks (DSBs) are the critical lesions involved in cellular effects of ionizing radiation. Therefore, the evaluation of DSB induction in mammalian cells after heavy ion irradiation is an essential task for the assessment of high-LET radiation risk in space.

Of particular interest has been the question of how the biological efficiency for the cellular inactivation endpoint relates to the initial lesions (DSBs) at varying LETs. For cell killing, an increased Relative Biological Efficiency (RBE) has been determined for high-LET radiation around 100-200 keV/ μm [3]. At higher LET, the RBEs decrease again to values below one for the very heavy particles. At GSI, DSB-induction was measured in CHO-K1 cells following irradiation with accelerated particles covering a wide LET range. The electrophoretic elution of fragmented DNA out of agarose plugs in a constant electrical field was applied for the detection of DSBs [5]. The fraction of DNA retained was determined considering the relative intensities of ethidium bromide fluorescence in the well and in the gel lane. Dose-effect curves were established, from which the RBE for DSB induction was calculated at a fraction of 0.7 of DNA retained.

RBE values are compiled in fig. 1, together with some literature values included for comparison. The data show RBEs between one and two up to an LET of 100 keV/ μm , followed by a steady decrease in RBE for higher LET values. In contrast to previously reported data [2], the yield of DSBs per unit dose does not increase in the LET region where enhanced cell inactivation is observed. Thus, the cellular endpoint is not related to induced DSBs directly but may rather depend on the fate of these lesions after processing in the cell. In order to gain information about the cellular capacity to cope with heavy ion induced strand breaks, rejoining of DSBs and residual DNA damage after repair incubation were investigated. For this purpose, CHO cells were incubated for various periods at 37 °C after irradiation with particle beams. In fig. 2 the effect of an increase in LET for one particle species is shown. Rejoining is dramatically impaired for the low energetic ions. The effect of increasing LET for higher Z particles is depicted in fig. 3.

In summary, these rejoining studies are in line with an enhanced severity of the DNA DSBs at higher LETs, resulting in a decreased reparability of the induced lesions. However, no information concerning the fidelity of strand breaks rejoining is provided in these studies. To assess correct rejoining of DNA fragments an experimental system involving individual DNA hybridization bands has been set up. In preliminary experiments, Sal I generated DNA fragments of 0.9 Mbp were irradiated with xrays and incubated for repair. However, restitution of the original signals was not observed, probably due to the high radiation dose necessary for breakage of a fragment of this size. A banding pattern with NotI hybridization signals in a higher MW range (3 Mbp) has been obtained by varying the electrophoretic conditions and correct rejoining studies will be further developed in this system.

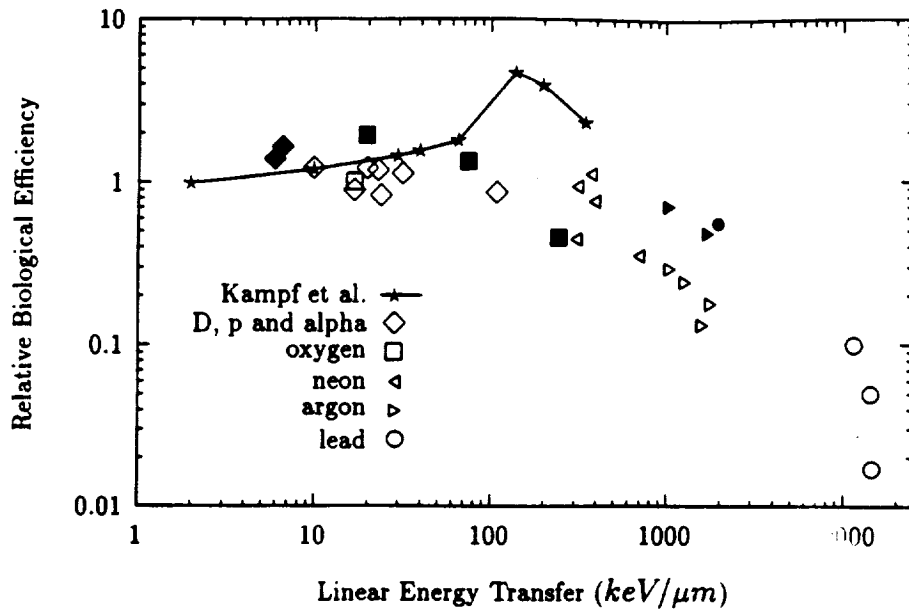

Figure 1: RBE values for the induction of DNA double strand breaks in mammalian cells. Own data are shown (closed symbols), together with results from others [1, 2, 4, 6]

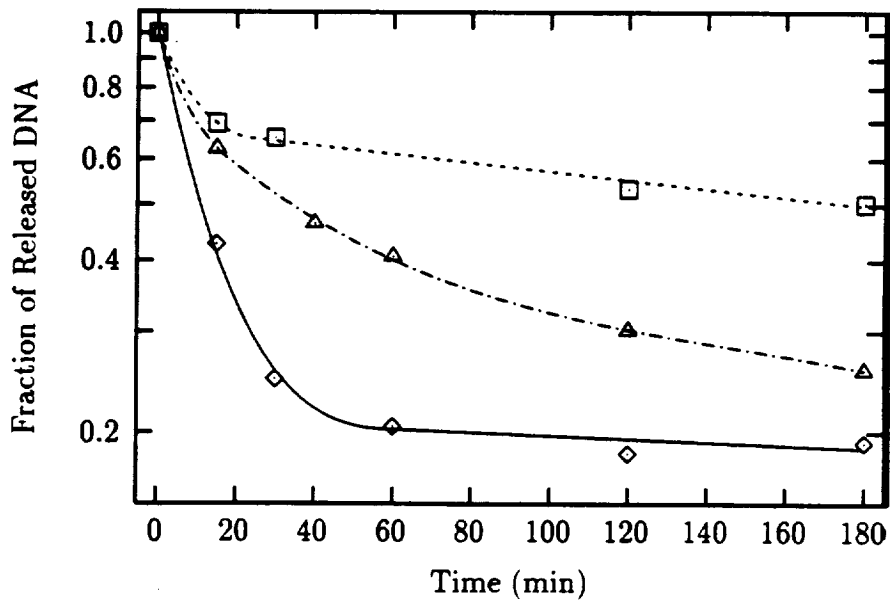

Figure 2: Rejoining of DNA double strand breaks in CHO-cells after irradiation with 250 kV X-rays (\diamond), 390 MeV/u neon-ions (\triangle) and 10 MeV/u neon-ions (\square). LETs correspond to 2 $keV/\mu m$, 30 $keV/\mu m$ and 370 $keV/\mu m$. With increasing LET, both kinetics and extent of rejoining decrease.

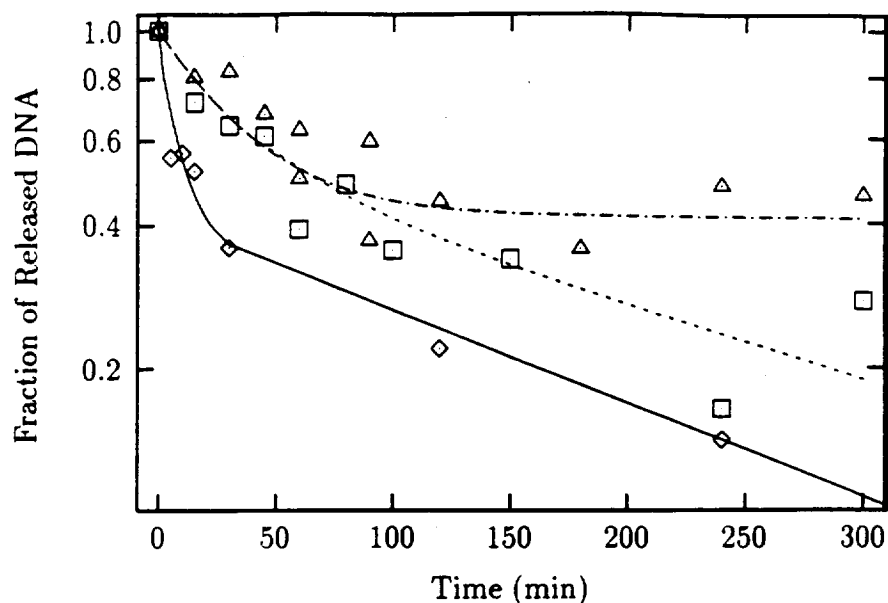

Figure 3: Rejoining of DNA double strand breaks in CHO-cells after irradiation with 250 kV X-rays (\diamond), 7.1 MeV/u argon-ions (\square) and 8.9 MeV/u gold-ions (\triangle). Initial damage in all three experiments is equivalent.

References

- [1] T.J. Jenner, M. Belli, D.T. Goodhead, F. Ianzini, G. Simone, and M.A. Tabocchini. Direct comparison of biological effectiveness of protons and alpha-particles of the same LET. III. Initial yield of DNA double-strand breaks in V 79 cells. *Int. J. Radiat. Biol.*, 61:631-637, 1992.
- [2] G. Kampf. Die Erzeugung von DNS-Strangbrüchen durch ionisierende Strahlen unterschiedlicher Qualität und ihre Bedeutung für die Zellinaktivierung. Technical report, Zentralinstitut für Kernforschung, Rossendorf KfR 504 Habil.-Schrift, 1983.
- [3] G. Kraft. Radiobiological effects of very heavy ions: inactivation, induction of chromosome aberrations and strand breaks. *Nucl. Sci. Appl.*, 3:1-28, 1987.
- [4] K.M. Prise, M. Folkard, S. Davies, and B.D. Michael. The irradiation of V 79 mammalian cells by protons with energies below 2 MeV. Part II. Measurement of oxygen enhancement ratios and DNA damage. *Int. J. Radiat. Biol.*, 58:261-277, 1990.
- [5] M. Schneider, G. Taucher-Scholz, J. Heilmann, and G. Kraft. Combination of Static Field Gel Electrophoresis and Densitometric Scanning for the Determination of Radiation Induced DNA Double Strand Breaks in CHO-Cells. *Radiat. Environ. Biophys.*, accepted November 18, 1993, 1994.
- [6] K.J. Weber and M. Flentje. Lethality of heavy ion induced DNA double-strand breaks in mammalian cells. *Int. J. Radiat. Biol.*, 64:169-178, 1993.

7 CHROMOSOMAL DAMAGE OBSERVED IN FIRST POSTIRRADIATION METAPHASES OF REPAIR-PROFICIENT AND -DEFICIENT CELL LINES

N95-32726

S. Ritter, W. Kraft-Weyrather, K. Fussel, E. Kehr, G. Kraft

Investigation of radiation induced damage in mutant strains of mammalian cells which show a defect in the rejoining of DNA double strand breaks provides an unique opportunity to examine the role of double strand breaks and the mechanisms of double strand break rejoining in the production of chromosome aberrations. This is particularly important, because there is increasing evidence that the DNA double strand break is the major lesion responsible for the formation of chromosome aberrations. To address this issue, we studied the induction of chromosome aberrations in xrs-5 cells, a X-ray sensitive strain of a Chinese hamster ovary cell line, which shows a defect in the rejoining of double strand breaks and their wild-type parent CHO-cells. Because radiosensitivity depends strongly on cellular age, the experiments were performed with synchronous cells.

Both cell lines were synchronized by mitotic shake off and were irradiated in G₁-phase with 780 MeV/u Au ions (LET; 150 keV/μm) at the SIS, Darmstadt. For comparison an experiment with 250 kV X-rays was performed. The amount of aberrant cells and aberrations was determined at serial, multiple sampling times following exposure, because recent experiments have shown that the amount of chromosomal damage varies with sampling time (2). By the use of the Fluorescence-plus-Giemsa technique it was assured that the analysis of chromosomal damage was restricted to first postirradiation metaphases. After X-ray exposure xrs-5 cells showed a five fold excess of aberrant cells and a twelve fold excess of aberrations/cell compared to CHO cells (fig 1a, b). After high LET radiation these differences were diminished. The number of aberrant cells was only slightly higher in xrs-5 cells (fig. 1c) and the aberration frequency/cell was only 2 times higher in the mutant strain compared to the wild-type parent (fig. 1d).

Furthermore, the comparison of the aberration types which were induced by densely and sparsely ionizing radiation in both cell lines showed that in CHO cells the distribution of aberration types changes as LET increases, but not in xrs-5 cells. In CHO cells the number of chromosomal breaks was found to rise from 45% after X-ray exposure to 58%, another repair-proficient Chinese hamster cell line (3). In xrs-5 cells the frequency of X-ray induced breaks was higher than in CHO-cells, i.e. 75% of all aberrations were chromosomal breaks, but there was no further increase following Au ion exposure.

Based on these observations as well as on other studies investigating the rejoining kinetics of radiation induced DNA strand breaks it is evident that X-ray induced lesions are repaired with a high efficiency in CHO cells and only a small amount of these lesions appears cytogenetically as aberrations. In xrs-5 cells however, which show a defect in DNA double strand repair similar doses of X-rays result in a much higher number of aberrant cells and aberrations/cell as shown in fig. 1 indicating that DNA double strand breaks are causal in the production of chromosome aberrations. When the wild-type cells and the mutant cells are exposed to high LET radiation these differences in the amount of chromosomal damage are diminished. Probably, even for repair-proficient cells the lesions induced by densely ionizing radiation are more severe and less rejoinable than those induced by sparsely ionizing radiation. Moreover, densely ionizing radiation seems to inactivate the mechanisms, which are responsible for the formation of exchange type

pp.

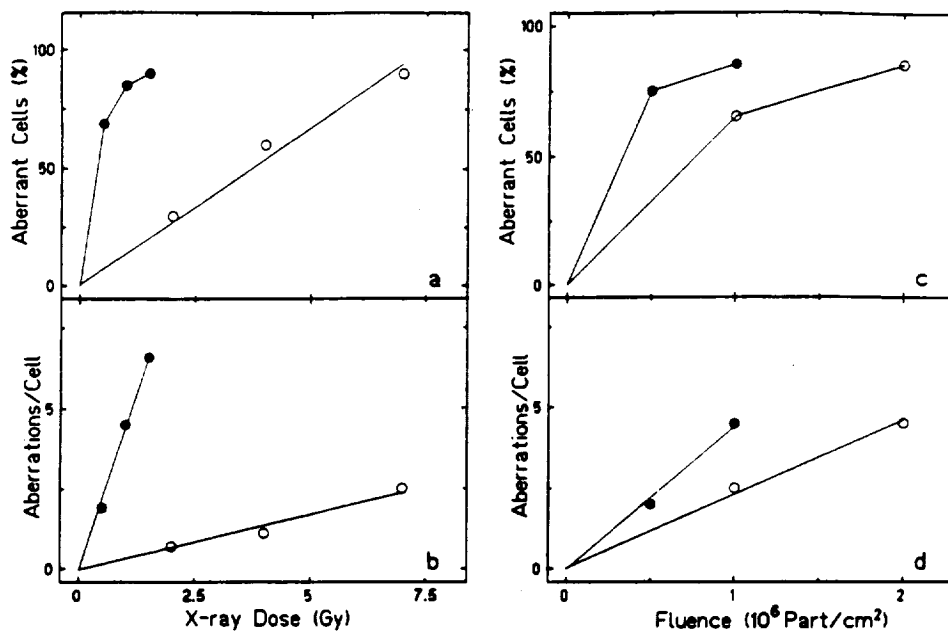

Figure 1: Frequency of aberrant cells and aberrations/cell induced in 1st generation CHO-K1 (open symbols) and xrs-5 cells (closed symbols) by X-rays and 780 MeV/u Au ions. Cells were irradiated in G₁-phase and chromosomal damage was investigated at several sampling times following exposure. The contribution of each sample to the overall damage was considered (for details see (3)) and the compiled data were plotted.

aberrations in CHO cells. In xrs-5 cells however, these processes are probably not present or work less efficiently, because there was no increase in the frequency of chromosomal breaks among the total number of aberrations with LET.

Further experiments are in progress to investigate in both cell lines the dependence of the pattern of radiation induced cytogenetical damage from radiation quality.

References

- [1] P.A. Jeggo, Mutation Research 145, 171-176 (1985)
- [2] S. Ritter et al., GSI Scientific Report 94-01, p229.
- [3] S. Ritter et al., GSI Scientific Report 92-01, p296.

8 MUTATION INDUCTION IN BACTERIA AFTER HEAVY ION IRRADIATION

N95-32727

G. Horneck and S. Kozubek¹

From a compilation of experimental data on the mutagenic effects of heavy ions in bacteria [2], [3] main conclusions have been drawn as follows:

- The mutagenic efficacy of heavy ions in bacteria depends on physical and biological variables. Physical variables are the radiation dose, energy and charge of the ion; the biological variables are the bacterial strain, the repair genotype of bacteria, and the endpoint investigated (type of mutation, induction of enzymes related to mutagenesis).
- The responses on dose or fluence are mainly linear or linear quadratic. The quadratic component, if found for low *LET* radiation, is gradually reduced with increasing *LET*.
- At low values of *Z* and *LET* the cross section of mutation induction σ_m (as well as SOS response, σ_{SOS} , and λ phage induction, σ_λ) versus *LET* curves can be quite consistently described by a common function which increases up to approximately 100 keV/ μ m. For higher *LET* values, the σ_m versus *LET* curves show the so-called "hooks" observed also for other endpoints [1].
- For light ions ($Z \leq 4$), the cross sections mostly decrease with increasing ion energy, which is probably related to the decrease of the specific energy deposited by the ion inside the sensitive volume (cell). For ions in the range of $Z=10$, σ_m is nearly independent on the ion energy. For heavier ions ($Z \geq 16$), σ_m increases with the energy up to a maximum or saturation around 10 MeV/u. The increment becomes steeper with increasing atomic number of the ion. It correlates with the increasing track radius of the heavy ion.
- The mutagenic efficiency per lethal event changes slightly with ion energy, if *Z* is small indicating a rough correlation between cellular lethality and mutation induction, only. For ions of higher *Z* this relation increases with energy, indicating a change in the "mode" of radiation action from "killing-prone" to "mutation-prone".
- Repair genotype substantially influences the radiation induced mutagenesis. Different mechanisms of mutation induction and/or different types of biologically significant lesions in wild type cells compared to repair deficient strains are a likely explanation.

The observed results suggest the following interpretation. For a bacterial cell, affected by a heavy ion, the injury will be either "killing-prone" or "mutation-prone". In the track core of densely ionizing radiation, the cells will be inactivated with high probability and mutations are unlikely to be produced. Mutations are most likely to be produced by δ -rays. Therefore, in the cross section of a track, one can imagine a "zone" between the track core and the track edge where mutations are induced with high probability. This "mutagenic belt" is restricted to an area where the density of the deposited energy is low

¹Institute of Biophysics, Academy of Sciences of the Czech Republic, Brno

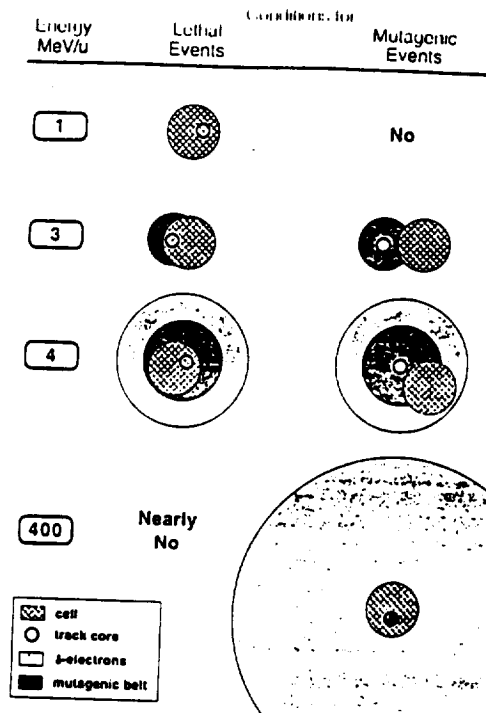

Figure 1: The "mutagenic belt" as an interpretation of mutagenesis by heavy ions in bacteria.

enough in order not to kill the cells and high enough to produce mutations (Figure 1). The "mutagenic belt" can be reduced if the density of departed energy is increased - from one side - or decreased - from the other side. For light ions, the "mutagenic belt" includes the track core owing to the low density of departed energy even in the track core which, in this case, decreases with increasing energy. Hence, the mutagenic efficacy decreases with increasing energy of light ions. For ions of high Z , there is no "mutagenic belt" if the energy is low owing to the very high concentration of energy in the track core and a very short range of δ -electrons. Therefore, no mutations are induced by those ions of high Z at low energies. Increasing energy leads to a growth in the "mutagenic belt" which should be more pronounced the greater the Z of the ion. This "mutagenic belt" interpretation demonstrates the important role of δ -electrons in heavy ion mutagenesis. A theoretical approach for interpretation of this "mutagenic belt" phenomenon is in preparation.

References

- [1] Baltschukat K, Horneck G, 1991, Responses to accelerated heavy ions of *Bacillus subtilis* of different repair capacity, *Radiat. Environ. Biophys.* 30: 87-103
- [2] Horneck G., Krasavin E.A., Kozubek S., 1994, Mutagenic effects of heavy ions in bacteria, *Adv. Space Res.* 14, (10)315-(10)329
- [3] Kozubek S., Ryznar L., Horneck G., Mutation induction by accelerated heavy ions in bacteria, *Mut. Res.* (in press)

9 HEAVY ION INDUCED MUTATIONS IN MAMMALIAN CELLS: CROSS SECTIONS AND MOLECULAR ANALYSIS (STATUS REPORT)

N95- 32728

U. Stoll, P. Schmidt, E. Schneider, J. Kiefer

Our investigations of heavy ion-induced mutations in mammalian cells, which had been begun a few years ago, were systematically continued. For the first time, it was possible to cover a large LET range with a few kinds of ions (Fig. 1). To do this, both UNILAC and SIS were used to yield comparable data for a large energy range. This is a necessary condition for a comprehensive description of the influence of such ion parameters as energy and LET. In these experiments, the induced resistance against the poison 6-thioguanin (6-TG), which is linked to the HPRT locus on the genome, is being used as mutation system.

The cells used so far are V-79 Chinese Hamster cells, but recently considerable efforts have been made to find a suitable human system. Preliminary experiments were performed with the P3 cell line originally isolated from a teratocarcinoma of a woman and the MGH-U1 cell line derived from a bladder carcinoma of a man. All data presented in this part of the report were obtained with V-79. Table 1 lists the data collected so far.

The LET dependence of mutation induction is displayed in fig. 1 for a few selected ions. The course of the curves for the various ions seems to be qualitatively similar; a systematic relation, however, between the cross sections σ_m and the LET does not seem to exist. Each ion appears to have its own specific curve. This confirms earlier observations made with other systems and end points, namely that the track structure of a specific type of ionising radiation plays a very important role, and the LET can not serve as a unifying parameter. On the basis of these and future data, it is planned to develop a theoretical description of the atomic mechanisms underlying the biological action of ionising radiation.

In addition to the mutation-induction cross-section measurements, the molecular changes of the DNA are being investigated by means of Multiplex PCR ("Polymerase Chain Reaction") gene amplification. From these experiments we expect further elucidation of the mutation-inducing mechanisms composing the biological action of heavy-ion radiation. First experiments have been performed at the Department of Clinical Genetics at the University of Ulm (Prof. G. Speith), but by now this method is being used regularly in our own laboratory as well. Contrary to what one might expect, first results suggest that heavy-ion radiation does not only produce deletions of larger parts of the gene, but also "point mutations" meaning that single bases are lost or altered. Even in this context, track-structure parameters appear to play an important role. Heavy ions of relatively low kinetic energy and correspondingly small penumbra radii seem to result mainly in large deletions, as opposed to high-energy heavy ions, which yield a large portion of small, localised alterations of the DNA.

Table 1: Physical parameters and biological results from the various heavy ion exposures.
 * : Data from Kranert *et al.*, (1990).

Ion	E/M at cell surface (MeV/u)	LET (H ₂ O) (keV/μm)	Z ^{*2} /β ²	rp (μm)	σ _i (μm ²)	σ _m (10 ⁻⁴ μm ²)	σ _m /σ _i (10 ⁻⁵)
O	1.9	754	11455	0.18	71.2±4.7	11.4±0.6	1.6±0.2
	* 8.8	276	3182	2.5	50±4	20.0±4.0	4.0±0.8
	10.7	238	2663	3.5	49.5±2.7	9.5±1.1	1.91±0.2
	88	46	387	125	4.3±0.2	1.22±0.12	2.88±0.4
	396.0	18	126	1606	1.3±0.1	0.17±0.01	1.3±0.2
Ne	8.0	452	5293	2.11	45±4	21.3±3.0	4.75±1.1
	10.7	366	4070	3.5	52±4	15.7±5.0	3.03±1.2
	* 12.0	335	3666	4.2	42±3	15.0±5.5	3.5±1.3
	14.3	294	3127	5.7	33±4	7.7±2	2.32±0.9
	65	91	792	74	12.5±1	2.7±0.5	2.18±0.5
	191	42	321	465	4.7±0.2	1.1±0.1	2.26±0.3
	395	28	197	1599	2.1±0.2	1.0±0.1	4.73±0.7
Ar	5.6	1611	19633	1.15	50±3.5		
Ca	14.1	1088	11509	5.5	46±7	7.0±0.4	1.5±0.25
Ti	4.8	2414	29779	0.89	54±3	14.0±1.0	2.6±0.3
	15.0	1238	12997	6.15	50±6	8.6±1.6	1.7±0.38
Ni	6.0	3190	37205	1.3	61±6	9.1±0.8	1.5±0.3
	* 9.5	2517	27580	2.8	65±2	8.3±1.2	1.3±0.18
	* 14.3	1961	20535	5.7	87±5	5.7±1.8	0.65±0.05
	136	407	3285	261	52±2	5.6±1.1	1.1±0.2
	387	218	1565	1544	39±3	5.5±0.5	1.4±0.32
	630	180	1225	3536	38.5±1	6.2±0.6	1.6±0.2
Xe	9.7	7126	72739	2.9	70	12.0±2.5	1.7±0.36
Au	2.2	12895	193900	0.24	57±2	4.1±0.7	0.7±0.2
	8.7	12568	126411	2.44	90±6	8.3±2.1	0.9±0.3
Pb	11.6	11948	116633	4.0		8.7±0.6	
	* 15.2	10800	102501	6.3	88±8	9.2±2.6	1.1±0.33
	150	3090	23064	308	97±5	14.5±2.5	1.5±0.38
	500	1630	11489	2387	68±3	8.9±1.3	0.9±0.2
	980	1325	8829	7493	52±5	8.3±1.2	1.2±0.23
U	3.9	15817	195911	0.62	71±5	15.0±2.0	2.1±0.37
	10.8	15220	139202	3.5	105±10	8.5±1.5	0.8±0.16
	12.7	13468	129809	4.6	90±9	4.5±2.0	0.5±0.20
α	0.85	163			42	11.9	2.8

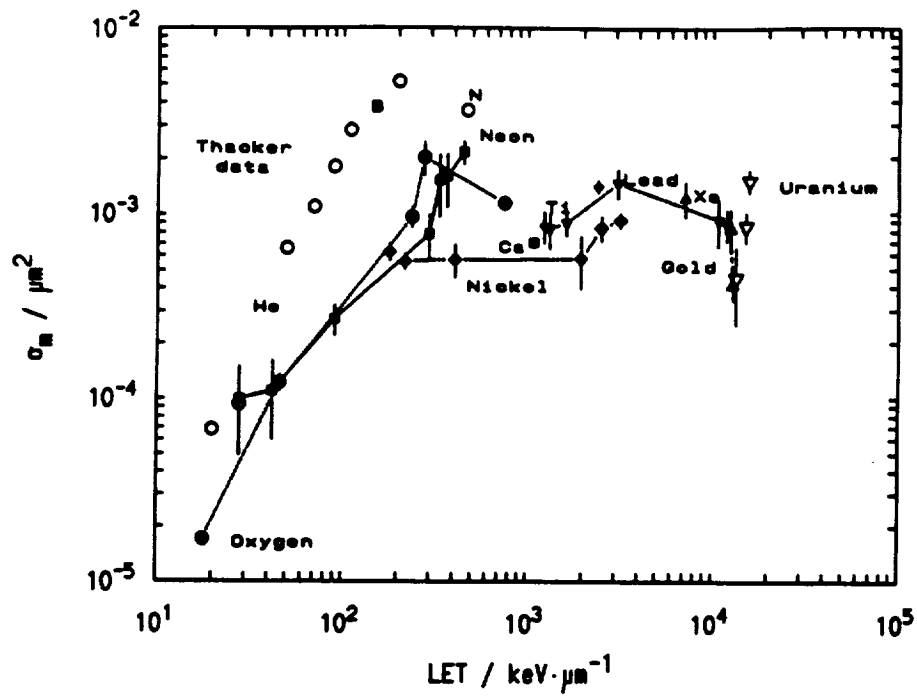

Figure 1: Mutation induction cross sections plotted versus LET together with data from Thacker *et al.*, (1979) (open circles) and 3 uranium experiments from Kranert *et al.*, (1990).

References

- [1] T. Kranert, E. Schneider, and J. Kiefer. Mutation induction in V79 Chinese hamster cells by very heavy ions. *Int. J. Radiat. Biol.*, 58:975-987, 1990.
- [2] J. Thacker, A. Stretch, and M. A. Stephens. Mutation and inactivation of cultured mammalian cells exposed to beams of accelerated heavy ions. II. Chinese hamster V79 cells. *Int. J. Radiat. Biol.*, 36:137-148, 1979.

10 HEAVY ION ACTION ON SINGLE CELLS: CELLULAR INACTIVATION CAPABILITY OF SINGLE ACCELERATED HEAVY IONS

Kost M., Pross H.-D., Rußmann C., Schneider E. and Kiefer J.
Kraft G., Lenz G. and Becher W.

Introduction

Heavy ions (HZE-particles) constitute an important part of radiation in space. Although their number is small the high amount of energy transferred by individual particles may cause severe biological effects. Their investigation requires special techniques which were tested by experiments performed at the UNILAC at the GSI (Darmstadt). Diploid yeast was used which is a suitable eucaryotic test system because of its resistance to extreme conditions like dryness and vacuum. Cells were placed on nuclear track detector foils and exposed to ions of different atomic number and energy. To assess the action of one single ion on an individual cell, track parameters and the respective colony forming abilities (CFA) were determined with the help of computer aided image analysis. There is mounting evidence that not only the amount of energy deposited along the particle path, commonly given by the LET, is of importance but also the spatial problem of energy deposition at a submicroscopical scale. It is virtually impossible to investigate track structure effects in detail with whole cell populations and (globally applied) high particle fluences. It is, therefore, necessary to detect the action of simple ions in individual cells. The results show that the biological action depends on atomic number and specific energy of the impinging ions, which can be compared with model calculations of recent track structure models.

Techniques and Methods

Diploid wildtype yeast cells, *Saccharomyces cerevisiae*, are plated as monolayers with a cell density of $3 \cdot 10^6 / \text{cm}^2$, embedded in a thin layer of nonnutrient agarose gel completed by D-Trehalose, on the surface of the detector foil. As track detectors 200 μm polycarbonate "LEXAN" and 100 μm CN-foil were used. Their advantages are good mechanical rigidity and easy handling. Irradiation was performed with about 10^6 particles/ cm^2 , the X-ray dose used in combination experiments was 360 Gy. In order to simulate the effect of a mixed radiation field, as can be found in space in a rather complex composition, combined irradiations with X-rays and Oxygen-ions and α -particles, respectively, were performed, using the methods mentioned above. Preirradiation took place about 1 h before particle irradiation, the resulting radial inactivation dependencies are shown in the figures 2 and 3 below. The method of analysis based on a computer-aided image analysis equipment, is depicted in figure 1.

The biological samples, consisting of a track detector with a biological layer, were irradiated, then an additional layer of nutrient agar was moved on the area of interest, providing on the one hand a suitable growth substrate, on the other hand the quality of microscopic images could be improved. Colony forming ability (CFA) was tested by incubating under growth conditions for 6 hours, based on the assumption, that after a lag time of about 2 hours, the cells can divide two times to form a microcolony. Colonies with at least four cells after the above mentioned time were accepted as survivors. After removal of the biological layer, track etching took place. Microscopical pictures of specially

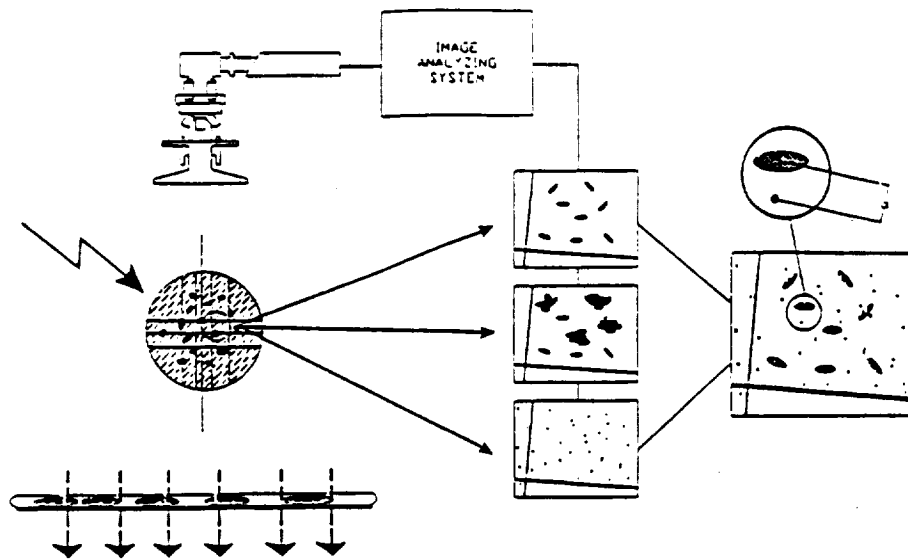

Figure 1: The principle of the Experimental Method

marked areas were taken by the computer-coupled Video-camera at three stages: 'Single cells', 'colonies' and 'etch-pits'. The superposition of the three pictures on screen provided information on the CFA of specified single cells as well as on the impact parameter of ion tracks in the vicinity of individual cells with an accuracy of about $0.5 \mu\text{m}$ (see figure 1).

Results and Conclusions

Single ion experiments

The inactivation range of α -particles is much larger than the calculated penumbra-radii and the inactivation probability of the α -particles (fig. 2) is lower compared to accelerated oxygen ions (fig. 3). Even direct hits into the cell nucleus show an inactivation probability of less than 100%. For the oxygen ions the calculated penumbra radii are similar to the experimental data.

Combination experiments with X-preirradiation

For both ion types it can be clearly seen that, except for small impact parameters, that preirradiation with α -particles causes a significant expansion of the effect towards higher impact parameters. This might be understood as an additional inactivation of sublethally damaged cells in this area, whereas for small impact parameters, the large amounts of energy transferred by the particle exert an overriding influence. In conclusion it can be stated that these data can complete the hitherto existing results with respect to the understanding of the biological effect of heavy ions on cellular systems.

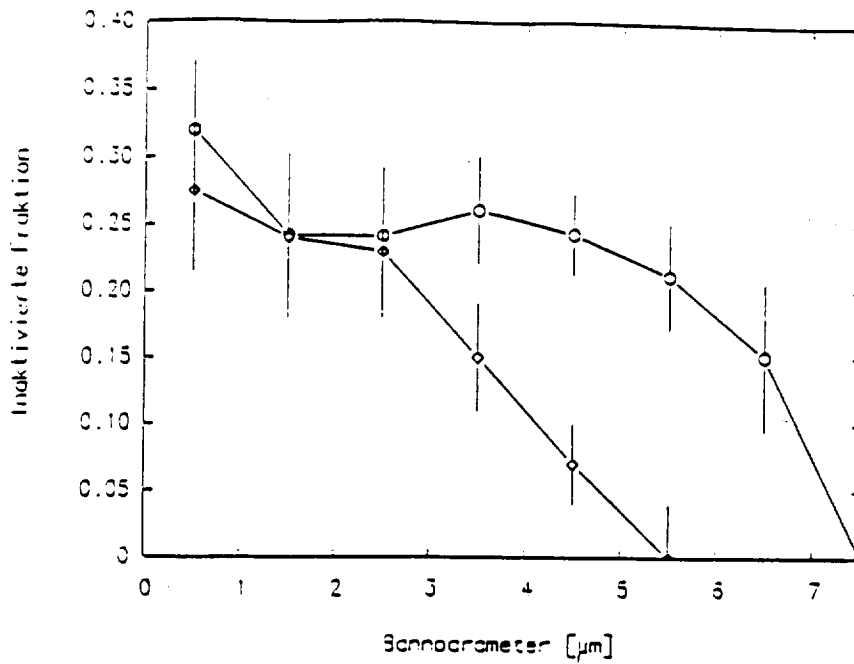

Figure 2: Normalized inactivated fraction of yeast cells for individual impact parameters after irradiation with 1.13 MeV/u α -particles (diamonds) and additionally preirradiated with 360 Gy 80 keV X-Rays (circles).

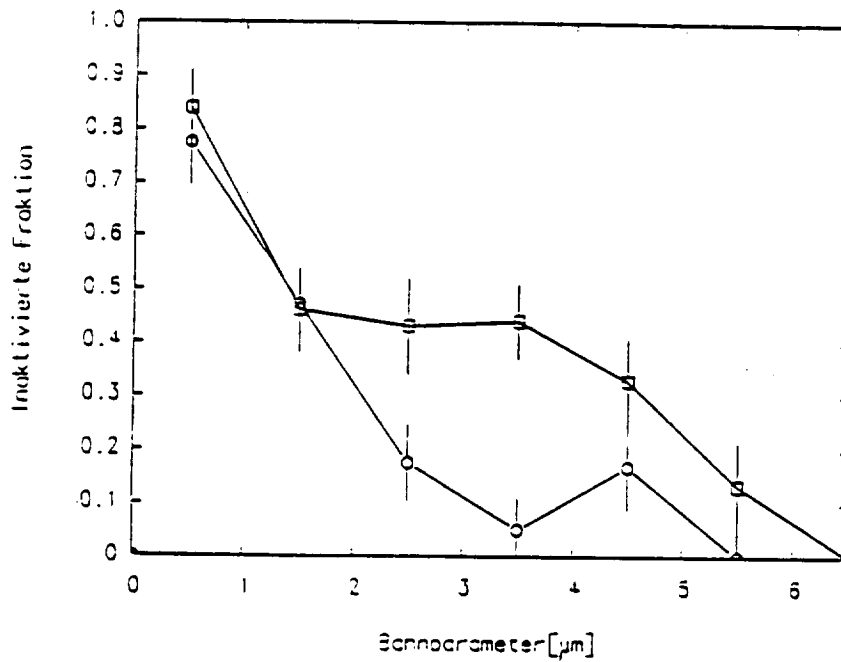

Figure 3: Normalized inactivated fraction of yeast cells for individual impact parameters after irradiation with 11.4 MeV/u oxygen-ions (circles) and additional preirradiation with 360 Gy 80 keV X-Rays (squares).

11 COSMIC HEAVY ION TRACKS IN MESOSCOPIC BIOLOGICAL TEST OBJECTS.

N95- 32730

R. Facius

Since more than 20 years, when the National Academy of Sciences and the National Research Council of the USA released their report on "HZE particle effects in manned spaced flight", it has been emphasized how difficult - if not even impossible - it is to assess their radiobiological impact on man from conventional studies where biological test organisms are stochastically exposed to 'large' fluences of heavy ions. An alternative, competing approach had been realized in the BIOSTACK experiments, where the effects of single - cosmic as well as accelerator - heavy ions on individual biological test organisms could be investigated. Although presented from the beginning as the preferable approach for terrestrial investigations with accelerator heavy ions too ("The BIOSTACK as an approach to high LET radiation research.") only recently this insight is gaining more widespread recognition. It has been claimed, e.g., that radiation protection for the workforce in the nuclear fuel cycle will rest on poorly understood grounds unless we can describe quantitatively the effects a single -particle may engender in the one lung cell which usually is irradiated. In part this delayed recognition may be due to the significantly more demanding techniques and procedures necessary for a successful application of the 'single particle effects' approach. This applies to the experimental techniques by which such data can only be gathered as well as to the statistical analysis required for their proper evaluation.

Whether recognized or not, this approach is the only feasible technique for meaningful investigations of the radiobiological effects of cosmic heavy ions. In space flight experiments, additional constraints imposed by the infrastructure of the vehicle or satellite further impede such investigations. Restrictions concern the physical detector systems needed for the registration of the cosmic heavy ions' trajectories as well as the biological systems eligible as test organisms. Test organisms must be able to endure immobilization for the duration of the space mission and the substantial time intervals of preparation and storage before and after the mission itself. Since the possibilities of 'life support' are minimal, biological systems in a dormant state or phase of their life cycle are preferred test objects. For investigations addressing the basic biophysical mechanisms of track structure and radial dose distributions, microscopic and rather radiation resistant test systems are the preferred choice. For biological endpoints more pertinent to radiation protection, such as e.g. chromosome aberrations or genetic 'late' effects, only more complex test organisms are suited. In every instance the experimental techniques to establish the geometrical correlation between the ions' trajectories and the 'sensitive' parts of the chosen test organisms have to be adapted to their size, shape and structure.

Such optimized procedures and techniques were developed for the investigations on chromosome aberrations induced by cosmic heavy ions in cells of the stem meristem of lettuce seeds (*Lactuca sativa*) and for the investigation of the radiobiological response of *Wolffia arriza*, which is the smallest flowering (water) plant. The biological effects were studied by the coworkers of the Russian Institute of Biomedical Problems (IBMP) which in cooperation with the European Space Agency ESA organized the exposure in the Biosatellites of the Cosmos series. Since biological investigations and physical measurements of particle tracks had to be performed in laboratories widely separated, the preferred fixed contact between biological test objects and the particle detectors until the geometrical correlation between tracks and organisms has been established could not be maintained.

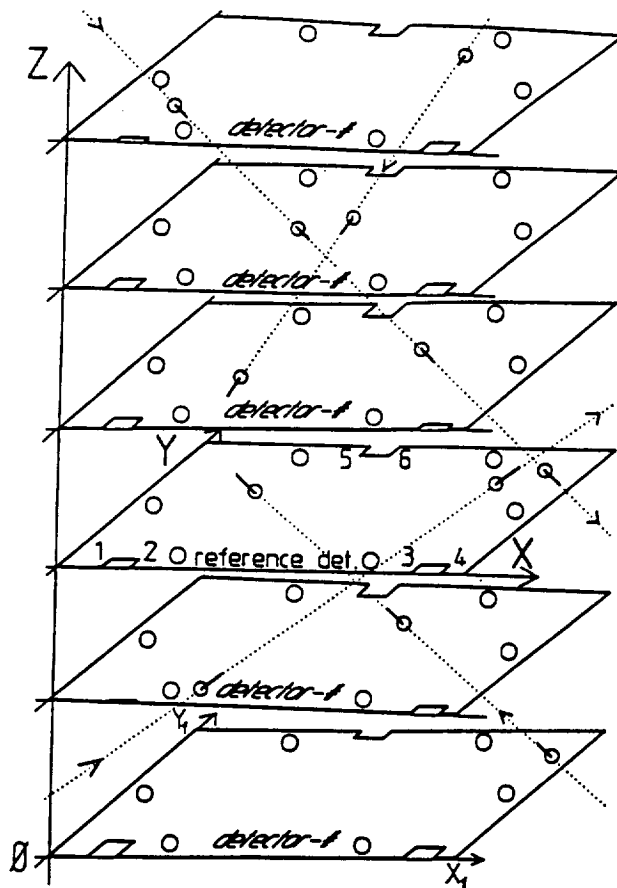

Figure 1: Relation between cosmic ray particle trajectories, etch tracks in coordinate systems of individual detectors, and between the stack- and detector-systems as displayed by the positions of grooves in the detector-system.

This gave rise to half a dozen of coordinate systems for different measurements which finally had to be related to a single stack reference system (Fig. 1).

For the first Biosatellite 8 mission the position and orientation of the seeds were determined visually from magnified shadowgraphs of the stack layers bearing the seeds. Classification of seeds as hit or non hit by heavy cosmic ions was determined by an overlay of these shadowgraphs with a map of heavy ion trajectories reconstructed for the corresponding layer (Fig. 2).

For the next Biosatellite 9 mission, the position and orientation of the seeds was determined from measurements in these shadowgraphs and in addition the location of the stem meristem was estimated by the biological specialist performing these measurements. This allowed the distance between particle trajectories and the estimated centre of the stem meristem - the impact parameter - to be estimated (Fig. 3). The quantitative uncertainty the particle trajectories could be reconstructed with was much smaller than the extension of the meristem (Fig. 4).

The *Wolffia arrhiza* plants had to be exposed in an environment which at least provided enough humidity to survive the exposure during the Biosatellite 10 mission. This humidity in turn was a new factor to be accounted for in the trajectory reconstruction since the

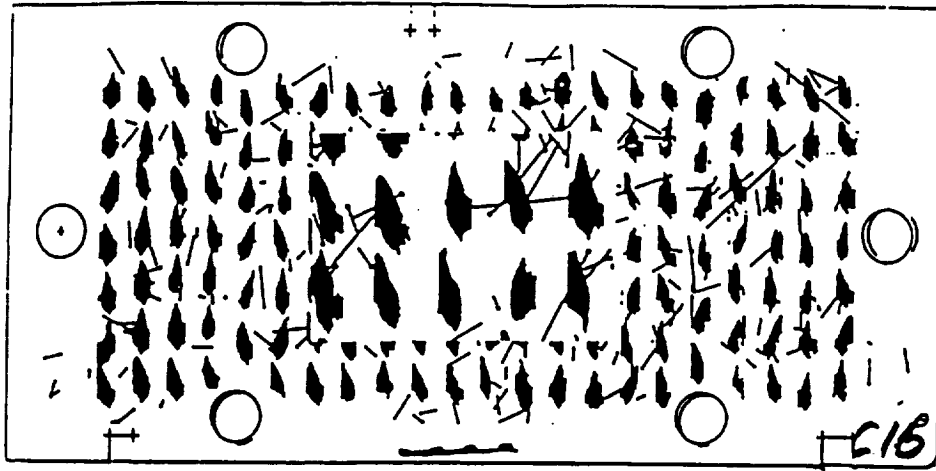

Figure 2: Map of projected particle transits through a biological layer overlain by its contact photography. The corners of the stack-reference grooves are marked by a (+) as well as the origin of the detector-system in the centre of the leftmost alignment hole. Magnified inset shows shadows of seeds and enlarged points of intersection of trajectories with the positive surface of the layer.

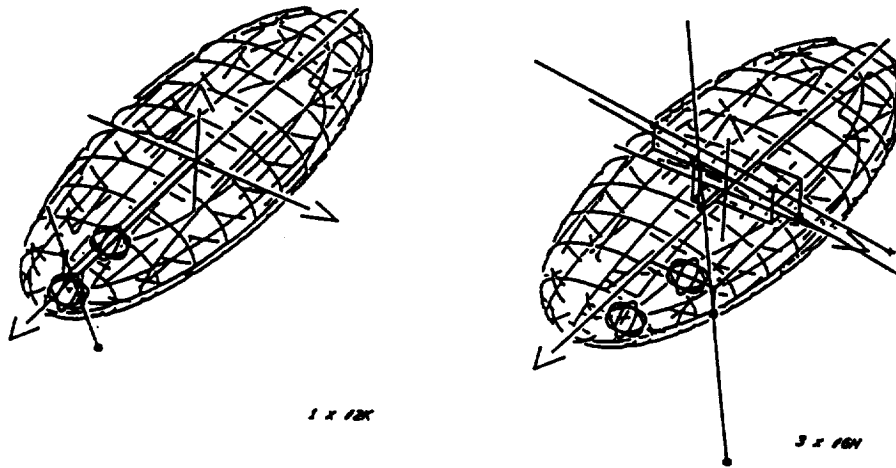

Figure 3: Threedimensional drawings of two seeds penetrated by 1 and 3 particles respectively. Root and stem meristems are apprx. by spheres of $150 \mu m$ radius at the position, where they had been located in the shadowgraphs. Higher and lower ends of trajectories are marked by (+) or (0), respectively.

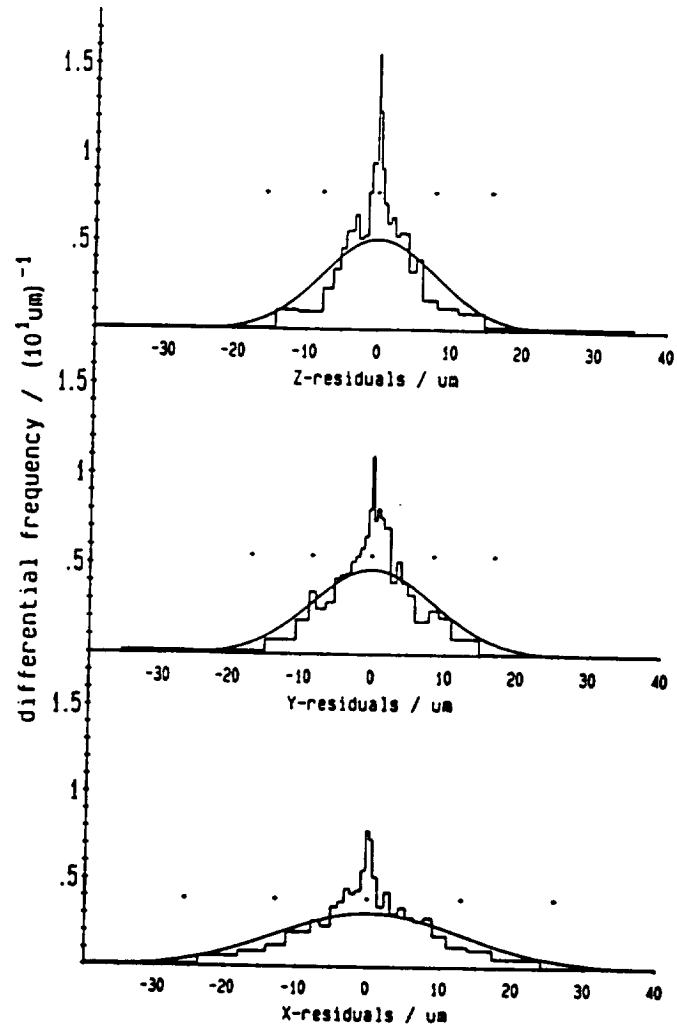

Figure 4: Quantitative precision of trajectory reconstruction as shown by the distribution of residuals between etch track coordinates and corresponding points on the trajectories.

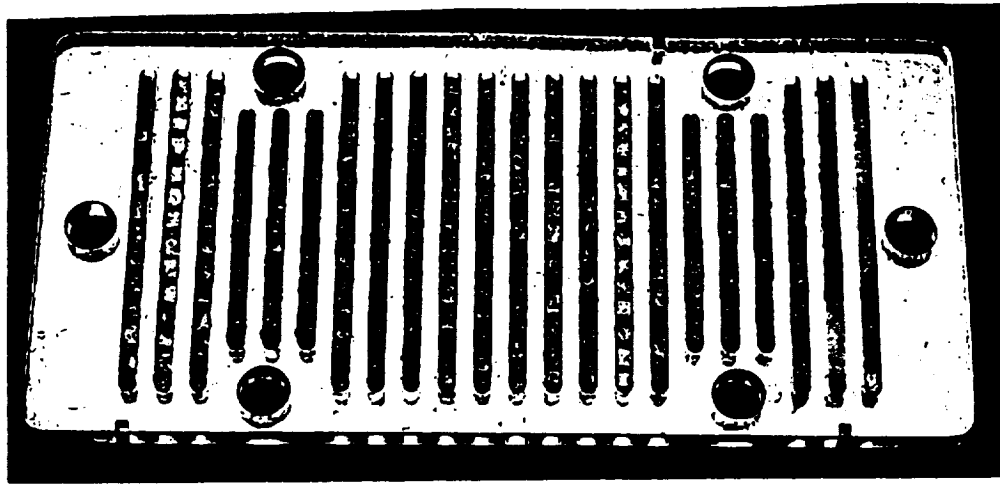

Figure 5: Wolffia arrhiza plants in their biological stack layer.

particle detectors significantly increased their size due to swelling of the plastic material. This time the position, orientation and size of the plants had to be determined immediately in the biological stack layers, where they had been fixed by small pieces of artificial sponge (Fig. 5). Despite the uncertainty added by the swelling the impact parameter to the budding zone of the plants could be determined with nearly the same precision.

References

- [1] D. Grahn, (ed.): HZE-particle effects in manned spaceflight. National Academy of Sciences, Space Science Board, Washington DC, 1973
- [2] H. Bückler, R. Facius, M. Schäfer: The Biostack as an approach to high LET research. in : Life Sciences and Space Research XIV (P.H.A Sneath, ed.), p. 233-239, Akademie Verlag, Berlin, 1976
- [3] D. Hildebrand, H. Bückler, R. Facius, M. Schäfer, B. Toth, W. Rüter, R. Pfohl, R. Kaiser: The Biostack as an approach to high LET radiation research. in : Proc. 5th Symp. on Microdosimetry (J. Booz, H.G. Ebert, B.G.R. Smith, eds.), p. 929-952, The Commission of the European Communities, EUR 5452, Luxembourg, 1976
- [4] R. Facius, G. Reitz, H. Bückler, L.V. Nevzgodina, E.N. Maximova, E.V. Kaminskaya, A.I. Vikrov, A.M. Marenniy and Yu.A. Akatov : Reliability of trajectory identification for cosmic heavy ions and cytogenetic effects of their passage through plant seeds. Nucl. Tracks Radiat. Meas. 17 (1990) 121-132
- [5] R. Facius, G. Reitz, H. Bückler, L.V. Nevzgodina and E.N. Maximova : Impact parameter determination for the passage of cosmic heavy ions through mesoscopic biological test organisms. Nucl. Tracks Radiat. Meas. 20 (1992) 207-216
- [6] R. Facius, K. Scherer, G. Reitz, H. Bückler, L.V. Nevzgodina and E.N. Maximova : Particle trajectories in seeds of Lactuca sativa and chromosome aberrations after exposure to cosmic heavy ions on COSMOS biosatellites 8 and 9. Adv. Space Res. 14 #10 (1994) (10)93-(10)103

12 X-RAY-PROVOKED NON-MENDELIAN TRANSGENERATIONAL ONCODETERMINANTS

A. Anders, C. Fleming, H. Schneider H. Gröger, E. Schneider, J. Kiefer, F. Anders

Introduction

Cancer is the most important risk of radiation exposure. There is a definite lack of suitable test systems, human epidemiological data are only available for certain radiation types, especially not for charged particles. We use the *Xiphophorus* model [1] which is genetically well characterised. As a prelude to experiments with heavy ions we report here on results obtained with x-rays to establish the necessary baseline for future studies. Apart from this direct aim we hope to obtain also a better insight in the genetical determination of cancer formation.

The normal xiphophorine pigment cell pattern, i.e. the cellular basis on which melanoma develops, is determined by developmental genes (oncogenes) that are conducted by *x-erbB^{aa}*, a xiphophorine homolog of the erythroblastosis virus *erbB* oncogene (Zechel et al., 1988; F. Anders, 1991; [5],[2]). The oncogenes are negatively controlled by directly acting suppressor genes and positively controlled by indirectly acting oncostatic genes (F. Anders et al., 1985 [3]). Xiphophorine melanoma, like neoplasia in general, develops mainly following loss, impairment or malfunction of the controllers, and is boosted by endogenous or exogenous tumorpromoters (A. Anders et al., 1991 [1]). The oncodeterminants, in reality normogenetic developmental genes and their controllers, are inherited according to Mendelian rules (F. Anders and Zechel, 1993 [4]).

We are studying a so far unknown oncodeterminant which, following a single treatment of embryos or eggs with X-rays, generates a non-Mendelian transmission of melanoma and an accelerating increase of its incidence through the succeeding generations.

The results obtained although interesting have to be considered as preliminary. They will be supplemented by investigating lower doses and in the case of pregnant fish different stages of embryogenesis.

Materials and methods

Platyfish (*Xiphophorus maculatus*) exhibiting black spots on the body side (*Sp*) or a black spot at the dorsal fin (*Sd*), or stripes on the side of the body (*Sr*) were used. Mature fish were irradiated in a metal basin filled 2 cm with water. It was placed 80 cm from the focus of a Röntgen Müller apparatus MG 150. X-rays were emitted at a dose rate of 0.22 Gy/min, 150 kV, 12 mA and filtered through 0.2 mm Cu and 0.5 mm Al. Germ cells were irradiated in the parental individuals, embryos in pregnant females. For young and small fish which require a more gentle treatment we replaced the metal basin by cell culture flasks. The fish were silenced by cooling to 12 °C and - after the treatment - waken up by warming. Whole-body x-ray doses in the range of 1-15 Gy were used which did not cause significant lethality. Only surviving animals were included in scoring.

Results

Insensitivity of purebred adult platyfish to provocation of melanoma.

Whole body X-irradiation with 1 to 20 Gy which has been performed with several thou-

sands of purebred adults for different purposes, has no detectable effect on the number of melanophores, as well as on spots and stripes that, in principle, may grow out to melanoma. This observation contributes to our so far indisputable findings that, based upon Mendelian genes, natural selection in the wild populations is directed against neoplasia and makes the animals largely unsusceptible to neoplasia, i.e. insensitive to carcinogens.

Sensitivity of germ line cells and embryos of purebreds to provocation of outgrowth of spots to benign melanoma in the development to adults.

Males, and females bearing eggs and embryos in their belly were treated with a single X-irradiation of 9 or 15 Gy, respectively. While this treatment does not impair the health of the parents and the offspring, and has no effect on the spot and stripe patterns of the parental adults, it causes - irrespective of whether eggs, embryos or both were hit - a uniform increase in the number of the spots and an enlargement of the spots to confluent and thickened areas in the developing generation. No such enlargement was observed in the stripes. A clear dose-effect relationship could not yet be established.

The enlarged spot areas resemble those of the wellknown benign melanomas which develop "spontaneously" in the platyfish-swordtail F1 hybrids and in those BC segregants, that harbor the oncogenic differentiation gene *Diff*. The genetic basis of the X-ray-provoked benign melanoma of the purebreds, however, is not identical to that of the hybridization provoked spontaneously developing benign melanoma: Matings between benign melanoma bearing F1 hybrids produce offspring exhibiting tumor expression from zero to extreme malignant whole-body melanoma. This result suggests a Mendelian inheritance of oncodeterminants. In contrast, the result of matings between the benign melanoma bearing purebreds grown up from irradiated germ line cells and embryos follows mechanisms other than Mendelian laws:

The nontreated adult offspring of the animals which had been treated as embryos or eggs in the belly of their grandmothers (9 or 15 Gy) exhibit benign melanomas like their directly treated (as embryos and eggs) parental generation. This enhancement of the tumorous phenotype remained unchanged without any further treatment through 45 inbred generations of two closed stocks. Since this increase takes place in all fish developing from the irradiated embryos and germ cells as well as in the descending generations, we conclude that both somatic and germ cells are hereditarily altered in the same direction by a so far unknown mechanism.

In order to examine more closely the genetics of the X-ray-provoked increase of phenotypic expression of the spots to benign melanoma, three types of crossing procedures were accomplished between nonirradiated platyfish carrying chromosomes that had been either irradiated or non-irradiated in the ancestry (Table 1; a,b,c):

a). Nonirradiated $X^{Sp}-X^{Sp}$ females bred from purebred ancestors which were irradiated as embryos and, therefore, exhibit spot outgrowths to benign melanoma (the irradiated chromosomes are symbolized by contour letters in the table) were crossed with nonirradiated X^{Sp} Ymales bred from nonirradiated normal spotted purebreds (the nonirradiated chromosomes are symbolized by normal letters). Double reciprocal crosses with respect to sex and to the irradiated and nonirradiated ancestry were also made. These crosses resulted in similar increase of *Sp* expression irrespective of whether the descendants carry the irradiated or the non-irradiated X^{Sp} chromosome.

b). To distinguish the effects of irradiated and nonirradiated autosomes and X- and Y-chromosomes individually, nonirradiated females of *Sp* stocks bred from fish which were irradiated as embryos in the ancestry were crossed with nonirradiated males of *Sd* stocks bred from nonirradiated fish. Triple reciprocal crosses with respect to sex and the *Sp*-and

Figure 1: Increase of tumor expression from spots to melanoma in descendents of crosses of nonirradiated animals carrying irradiated (9 or 15 Gy; contoured symbols) and/or nonirradiated chromosomes (normal Symbols). 5 experimental sets each. (A, autosomes; X, Y, sex chromosomes; Sp, spotted body side; Sd, spotted dorsal fin)

Genotypes of ancestral generations	No. of descendents	Tumor expression in the descendents
a. $AA \ XSp \ XSp \times AA \ XSp \ Y$ $AA \ XSp \ XSp \times AA \ XSp \ Y$	several thousands in 35 generations	all animals exhibit increased Sp
b. $AA \ XSp \ XSp \times AA \ XSp \ Y$ $AA \ XSp \ XSp \times AA \ XSp \ Y$ $AA \ XSp \ XSp \times AA \ XSp \ Y$ $AA \ XSp \ XSp \times AA \ XSp \ Y$	44 43 124 93	all animals exhibit increased Sp and Sd (n = 304)
c. $AA \ XSp \ XSp \times AA \ XSp \ Y$ $AA \ XSp \ XSp \times AA \ XSp \ Y$ $AA \ XSp \ XSp \times AA \ XSp \ Y$	91 54 32	normal to less increased normal to increased increased

Sd- chromosome from irradiated and nonirradiated stocks were made. All of these crosses reveal an increased expression from spots to benign melanoma in both irradiated and nonirradiated *Sp*- and *Sd*-phenotype in the male and female offspring (n= 304) to the same extent as observed in those parents having the complete set of irradiated chromosomes. Individuals inheriting both *Sp* and *Sd* phenotypes show outgrowths to benign melanoma in both. The results indicate firstly that the increase of *Sp* and *Sd* expression in the offspring is neither dependent on a specific mutation of the critical *x-erbB^a* oncogene nor due to any other genetic change restricted to the irradiated *XSp* or *XSp* chromosome, secondly, that this genetic alteration cannot involve mutations of cytoplasmic constituents contributed in different quantities by ovum and sperm because the increase of phenotypic expression from spots to melanomas is independent of the sex of the parent contributing the irradiated chromosomes to the offspring, and thirdly, that half of the diploid chromosome set that is irradiated is as effective in the offspring as the entire irradiated chromosome set in the parents. The latter observation suggests a matching of the effect in the offspring up to that of the parents.

c). To test the distribution of the determinants of the increased *Sp*- and *Sd*-expression in the genome more closely, males and females having half of their chromosomes ancestrally irradiated, were crossed with fish having none of, half of, or the complete set of chromosomes irradiated. The result indicates that the variation of the phenotypic elevation of the spots to melanomas corresponds to the variation of the mode number of irradiated chromosomes in the offspring. This variation points to a large number of oncodeterminants that are widely distributed in the chromosomes. Nonchromosomal determinants cannot be involved in the increase of spot expression to melanoma because one would not assume that these are transmitted to the offspring in proportions similar to those of the

chromosomes.

The question arises whether the chromosomes treated in the ancestry of the platyfish carrying the benign melanoma outgrowth will intensify the well known ordinary benign and malignant melanoma that appears in the platyfish swordtail hybrids "spontaneously" (see F. Anders, 91). Therefore, nonirradiated platyfish of the *Sp* and *Sd* stocks bred from fish irradiated as embryos 10 generations earlier, were crossed and backcrossed with nonirradiated swordtails bred from nonirradiated ancestors. Four sets of experiments produced benign melanoma bearing F1- and BC-hybrids (with *Diff*) and malignant melanoma bearing BC-hybrids (without *Diff*), and all of them (n=155) revealed an earlier onset and a boost of tumor severity as compared to the standard displayed by the ordinary Mendelian tumor determinants of the oncogene-suppressorgene machinery.

Tumourigenesis in hybrid fish: the "I-model"

The genotypes used so far are highly suitable for the detection of the transgenerational uniform augmentation of Mendelian-based melanoma development by the non-Mendelian oncodeterminants at the individual level; however, they are inadequate for the detection of Mendelian-independent tumor frequencies at the populational level that could mimic the mysterious increase of melanoma frequency in human populations. To study the putative influence of the transgenerational oncodeterminants at the populational level we developed a hybrid fish model in which all individuals are equally strong protected from melanoma by a particular critical suppressor gene which is closely linked to the *x-erbB^a* oncogene. Both *x-erbB^a* and the linked suppressor are the only platyfish-specific oncodeterminants in the swordtail genome. The insensitivity to hybridization-conditioned Mendelian melanoma and the sensitivity to X-ray-induced melanoma in the model appear as different developmental processes. Insensitivity to hybridization of the *Sr* phenotype remains unchanged in the model, its insensitivity to X-rays, however, changes to sensitivity, and neoplasia can be provoked by mutations of the only Mendelian controller that is retained in the model. Because initiation is required for melanoma in this model we called it "I-Model". All individuals of the I-Model are equally endowed with the capacity to develop melanoma. The non-Mendelian transgenerational oncodeterminants which appear to be selfish are expected to turn the balance from non-tumorous to tumorous fish in a given experimental population (Table 2; a,b,c):

Thousands of fish of the I-Model have been bred. Generally they remain lifelong tumorfree. However, if the adults of the I-model were treated with X-rays (10 Gy/3 x 45 min, 6 intervals), 19% of the survivors (390/2010) developed malignant melanoma after 8 to 10 months. The sharply circumscribed shape of the melanomas suggests their somatic mutation-conditioned unicellular origin. We are planning to use this model in future studies both with x-rays and heavy ions.

We compared also two successive siblings of one pair of parents each. The one siblings were born before, and the others after their mother was treated with X-rays. Melanoma formation of the treated animals starts developing early in embryonic life and may end lethally as wholebody melanoma at the time of birth. They are of unicellular origin like the irradiation-provoked melanomas in the adults although they look, due to their early appearance, large-faced like the common Mendelian ones that actually are of multicellular origin. An average 33 % of the adults treated as embryos develop severe melanoma. No Mendelian background of melanoma incidence was observed. Non-tumorous adults showed no signs of being cryptically affected by the treatment as embryos.

Figure 2: Increasing X ray.initiated melanoma incidence running through the generations of the I-model as compared to the lack of increase in the promoter-promoted P-model (counted in adults of age 8-10 months).

Treatment of	M e l a n o m a i n A d u l t s			
	Initiation in the I-Model	%	Promotion in the P-Model	%
a. Adults	390/2010 (589/3348) # after 8-10 months; in the adults only	19 (18)#	832/974 § after 8-10 weeks;	85
b. Embryos	234/703 starting in the embryos	33	0/218 §	0
c. Embryos in the 17th ancestral generation	591/1131 starting spontaneously in the embryos of the descendent generations	52	0/567 §	0

Total of data for treatment with X-rays, MNU, ENU, IQ; § Total of data for treatment with Methyltestosterone, Trenbolone, Stanozolol, Tamoxifen.

Non-tumorous mates of siblings treated as embryos were inbred in closed stocks. Tumorous offspring resembling those of the irradiated ancestry in shape and percentage occurred without any further treatment. As these tumorous fish occurred in the closed stock laboratory populations, they were excluded from their possible contributions to the succeeding generations. Selective decrease of tumor incidence which was to be expected was not observed. Instead, melanoma incidence increased in the populations of the closed stocks. Since the beginning of the irradiation/selection experiment 8 years ago we estimate an average run of 17 generations through the populations of the closed stocks of the I-Model. When the fish reach an age of about 20 months, they become more melanomatous, and additional sarcomas and carcinomas develop. At present the number of generations bred in the closed populations is estimated to 22, and no further change was observed. It appears that a balance between increase of tumor incidence and rate of tumor deaths stopped the endogenous populational dynamics, as if the phenomenon were epidemic.

In parallel to the phenomenological investigations studies at the molecular level are in preparation.

References

- [1] Anders A, Zechel C, Schlatterer B, Gröger H, Schmidt D, Smith A, Anders F: Genetic and molecular approach for breeding and use of laboratory fish for the detection of agents with carcinogenic and/or promoting activity. Bull Cancer 78: 415-433. 1991

- [2] Anders F: Contributions of the Gordon-Kosswig melanoma system to the present concept of neoplasia. *Pigment Cell Res.* 3: 7-29, 1991.
- [3] Anders F, Scharl M, Barnekow A, Schmidt CR, Lüke W, Jaenel-Dess G, Anders A: The genes that carcinogens act upon. *Haematology and Blood Transfusion* 29; Neth, Gallo, Greaves, Janka (eds.): *Modern Trends in Human Leukemia VI*, Springer-Verlag Berlin/Heidelberg 1985, pp 228-385
- [4] Anders F, Zechel C: Oncogenes in Melanoma. In: FJ Lejeune, PK Chaudhuri, TK Das Gupta (eds). *Malignant Melanoma*. McGraw-Hill, Inc. New York 1993, pp 51-64.
- [5] Zechel C, Schleenbecker U, Anders A, Anders F: *v-erbB* related sequences in *Xiphophorus* that map to melanoma determining Mendelian loci and overexpress in a melanoma cell line. *Oncogene* 3: 605-617, 1988.

PUBLICATIONS

Anders F.

A Gene alone may not make a tumor

AIDS Research and Human Retroviruses 8, pp. 833-852, (1993)

Anders F., C. Zechel

Oncogenes in melanoma

In: F.J. Lejeune, P.K. Chaudhuri, T.K. Das Gupta (eds.): Malignant Melanoma

New York, McGraw-Hill Inc., pp.51-64

Blüm V., J. Kiefer, K.H. Kreuzberg, D. Volkmann

Biologische Forschung im Weltraum

Naturwissenschaftliche Rundschau, Heft 2/93, S. 51-56

Bücker H., Horneck G., Facius R., Reitz G.,

Radiation exposed in manned spaceflight

Kerntechnik, Vol. 58, No. 4, 229-234 (1993)

Facius R., Reitz G., Schäfer M.

Inactivation of individual *Bacillus subtilis* spores in dependence on their distance to single cosmic heavy ions

Adv. Space Res. 14, (10)1027-(10)1038 (1994)

Facius R., Scherer K., Reitz G., Bücker H., Nevzgodina L.V., Maximova E.N.

Particle trajectories in seeds of *Lactuca sativa* and chromosome aberrations after exposure to cosmic heavy ions on Cosmos biosatellites 8 and 9

Adv. Space Research Vol. 14, Nr. 10, (10)93-(10)103 (1994)

Heinrich W.

Cosmic Rays and their Interactions with the Geomagnetic Field and Shielding Material

Rad. Phys. Chem., Vol. 43, No. 1/2, p. 19-34, 1994

Heinrich W., E.V. Benton, B. Wiegel, G. Gusch and E. Becker

Comparison of measured Cosmic Ray LET Spectra with Models and Predictions

Adv. Space Res., Vol. 14, No. 10, (10)969-(10)977, 1994

Heinrich W., E.V. Benton, B. Wiegel, R. Zens and G. Rusch

Galactic Cosmic Ray Abundances and Spectra behind defined Shielding

Adv. Space Res., Vol. 14, No. 10, (10)815-(10)824, 1994

Horneck G.

Radiation biology in space, results of experiments and perspectives for future research
Proc. Symp. "Radiation Biology and its Application in Space Research"
26.-27.11.1992, Brno, Czech. Rep., 3-13 (1993)

Horneck G.

The Biostack concept and its application in space and at accelerators: Studies
on *Bacillus subtilis* spores
NATO ASI Series A: Life Sciences, Vol. 243A, 99-115 (1993)

Horneck G., Krassavin E.A., Kozubek S.

Mutagenic effects of heavy ions in bacteria
Adv. Space Research 14, (10)315-(10)329 (1994)

Kiefer J.

Issues and Problems for Radiobiological Research in Space
Adv. Space Res., Vol. 14, No. 10, (10)979-(10)988, (1994)

Kiefer J.

Mutation Induction in Yeast by very Heavy Ions
Adv. Space Res., Vol. 14, No. 10, (10)331-(10)338, (1994)

Kiefer J.

On the Biological Significance of Radiation Exposure in Air Transport
Radiation Protection Dosimetry, Vol. 48, 107-110, 1993

Kiefer J.

Problems, pitfalls, perspectives and potentials of quantitative theoretical
models for cellular radiation action
Mutation Research, 289, 27-37, (1993)

Kiefer J., S. Ikpeme, T.C. Akpa and K.J. Weber

DNA Double Strand Break Induction by Very Heavy Ions: Dependence on
Physical Parameters
Radiation Protection Dosimetry, Vol. 52, Nos. 1-4, 295-298, (1994)

Kiefer J., U. Stoll and E. Schneider

Mutation Induction by Heavy Ions
Adv. Space Res., Vol. 14, No. 10, (10)257-(10)265, (1994)

Kozubek S., Horneck G.

Mathematical models of lesion induction and repair in irradiated cells
NATO ASI Series A: Life Sciences, Vol. 243A, 291-293 (1993)

Kozubek S., Horneck G. (eds.)
Radiation Biology and its Application in Space Research
Proceeding, Intern. Symp., 26.-27.11.1992, Brno, Czech. Rep.,
Verlag Institute of Biophysics, Brno, Chzech. Rep., 1993

Kozubek, S., Horneck G.
A biophysical model of radiation induced mutagenesis
Proc. Symp. "Radiation Biology and its Application in Space Research",
26.-27.11.1992, Brno, Czech. Rep., 112-117 (1993)

Kraft G., M. Krämer
Track structure DNA damage and RBE
Adv. in Space Res. 14, 10(997-10(1004), (1994)

Kraft G., M. Scholz
On the parametrization of the biological effects in a mixed radiation field
Adv. in Space Res. 14, 10(151)-10(159), (1994)

Krämer M., G. Kraft
Heavy ion track structure calculations
Radiat. Env. Biophys. 33, 91-109, (1994)

Krassavin E.A., Horneck G., Kozubek S.
"Complex" DNA lesions and radiobiological effects induced by radiation
with different LET
Proc. Symp. "Radiation Biology and its Application in Space Research"
26.-27.11.1992, Brno, Czech. Rep., 59-62 (1993)

Löbrich M., S. Ikpeme and J. Kiefer
Measurement of DNA Double-Strand Breaks in Mammalian Cells by
Pulsed-Field Gel Electrophoresis: A New Approach using Rarely Cutting
Restriction Enzymes
Radiation Research, Vol. 138, 186-192, (1994)

Löbrich M., S. Ikpeme, J. Kiefer
Analysis of the Inversion Effect in Pulsed-Field Gel Electrophoresis
by a Two Dimensional Contour-Clamped Homogeneous Electric Field
System
Analytical Biochemistry, 208, 65-73, 1993

Löbrich M., S. Ikpeme, P. Haub, K.J. Weber, J. Kiefer
DNA double-strand break induction in yeast by X-rays and
-particles measured by pulsed-field gel electrophoresis
Int. J. Rad. Biol., Vol. 64, No. 5, 539-546, 1993

Micke U., Horneck G., Kozubek S.
Double strand breaks in the DNA of *Bacillus subtilis* cells irradiated
by heavy ions
Adv. Space Research 14, (10)207-(10)211 (1994)

Pross H.-D., M. Kost and J. Kiefer
Repair of Radiation Induced Genetic Damage under Microgravity
in: Biological Effects and Physics of Solar and Galactic Cosmic Radiation,
NATO ASI Series A: Life Sciences Vol. 243 A, p. 125-128
C.E. Swenberg, G. Horneck and E.G. Stassinopolous (eds.)
Plenum Press New York and London

Pross H.-D., M. Kost and J. Kiefer
Repair of radiation induced genetic damage under microgravity
Adv. Space Res., Vol. 14, No. 10, (10)125-(10)130, (1994)

Reitz G.
Radiation environment in the stratosphere
Radiation Protection Dosimetry; Vol. 48, No. 1, 5-29 (1993)

Reitz G., Beaujean R., Heckeley N., Obe G.
Dosimetry in the space radiation field
Clinical Investigator, 71: 710-717 (1993)

Schäfer M., Facius R., Reitz G.
Inactivation of individual *Bacillus subtilis* spores in dependence on their
distance to single accelerated heavy ions
Adv. Space Research 14, (10)1039-(10)1046 (1994)

Schäfer M., Schmitz C., Bückner H.
DNA double strand breaks induced in *Escherichia coli* cells by radiations
of different quality
Radiation Protection Dosimetry 52, Nos. 1-4, 233-236 (1994)

Schäfer M., Schmitz C., Bückner H.
Heavy ion induced DNA double strand breaks in cells of *E. coli*
Adv. Space Research 14, (10)203-(10)206 (1994)

Schneider M., G. Taucher-Scholz, J. Heilmann, G. Kraft
Combination of static-field gel electrophoresis and densitometric scanning
for the determination of radiation-induced DNA double strand breaks in
CHO cells
Radiat. Env. Biophys. 33, 111-124, (1994)

Scholz M., W. Kraft-Weyrather, S. Ritter, G. Kraft
Cell cycle delays induced by heavy ion irradiation of synchronous mammalian cells
GSI-94-18 Reprint (März 1994),
Int. J. Radiat. Biol. (in press)

Schott J.U.,
Time resolving detector systems for radiobiological investigations of effects of single
heavy ions
NATO ASI Series A: Life Sciences, Vol. 243B, Part B., 153-163 (1993)

Schott J.U., Kranz A.R., Gartenbach K., Zimmermann M.
Particle radiation mapping in growing organisms with charge-coupled devices
(CCDs)
Proc. Symp. "Radiation Biology and its Application in Space Research",
26.-27.11.1992, Brno, Czech. Rep., 31-36 (1993)

Schott J.U., Kranz A.R., Gartenbach K., Zimmermann M.
Particle radiation mapping in growing organisms with charge-coupled devices (CCDs),
Journal of Photographic Science, Vol. 41, 115-116 (1993)

Stanton J., G. Taucher-Scholz, M. Schneider, J. Heilmann, G. Kraft
Protection of DNA from high LET radiation by two OH radical scavengers
tris (hydroxymethyl) aminomethanol and 2-mercaptoethanol
Radiat. Env. Biophys. 32, 21-32, (1993)

Stoll U., E. Schneider, T. Kranert and J. Kiefer
Mutation Induction in Chinese Hamster V79 Cells after
Heavy Ion Exposure
in: Molecular mechanisms in radiation mutagenesis and carcinogenesis
K.H. Chadwick, R. Cox, H.P. Leenhouts, J. Thacker (eds.)
Report European Commission (EUR 15294), p. 197-202, 1994

Stoll U., E. Schneider, T. Kranert, J. Kiefer
Mutation Induction in Chinese Hamster V79 Cells after Heavy
Ion Exposure: Baselines for Risk Estimations in Space
Proceedings of the Symposium at Brno, Czech Rep., p. 53-58, 1993

Swenberg C.E., Horneck G., Stassinopoulos E.G. (eds)
Biological Effects and Physics of Solar and Galactic cosmic Radiation
Part A, NATO ASI Series A: Life Sciences, Vol. 243A, Plenum Press New York, (1993)

Swenberg C.E., Horneck G., Stassinopoulos E.G. (eds.)
Biological Effects and Physics of Solar and Galactic Cosmic Radiation
Part B, NATO ASI Series A: Life Sciences, Vol. 243B, Plenum Press New York, (1993)

Tantithakura O., F. Anders, A. Anders, W. Förster
High resolution technique: A new approach, to study fish chromosomes
Fish Genetics 1993, pp. 45-53, (1993)

Wehner J.; Horneck G., Bücken H.
Plasmids as test system for the detection of DNA strand breaks
NATO ASI Series A: Life Sciences, Vol. 243A, 49-52 (1993)

Zechel C., U. Schleenbecker, A. Anders, F. Anders
Regulation of gene expression in the Gordon-Kosswig melanoma system:
Approach to study genes involved in the first step of neoplasia
In: J.H. Schröder, J. Bauer, M. Scharl (eds.), Trends Ichthyology, GSF Bericht 7/92
Blackwell Scientific Publications 1993, pp. 93-110

Zimmermann H., Schäfer M., Schmitz C., Bücken H.
Effects of heavy ions on inactivation and DNA double strand breaks
in *Deinococcus radiodurans* R1,
Adv. Space Res. 14, (10)213-(10)216 (1994)

CONFERENCE CONTRIBUTIONS, SEMINARS AND REPORTS

Abel T., J. Kiefer:

Zellzyklusverzögerungen in V79 chinesischen Hamsterzellen nach Alphabestahlung
Symposium: Molekulare und zelluläre Grundlagen der biologischen Strahlenwirkung,
Erlangen, April 1993

Anders A., C. Fleming, H. Gröger:

Differential carcinogenicity, tumor promotion, and tumor regression
J. Tumor Marker Oncology 9, p. 34, 1994
June 12-17, 1994, Naples, Italy

Anders A., H. Gröger, F. Anders:

Genetic control of cancer remission
J. Tumor Marker Oncology 8, p. 5, 1993
Sept. 8-11, 1993, Bonn, Germany

Anders F., C. Zechel, M. Burcin, H. Petry, M. Ueffing, W. Hoffmann, K. Petry,
J. Leers, P. Brix, H. Gröger, A. Anders:
Tumor determinants in concert
8th Symposium on Molecular Biology of Hematopoiesis, July 9-13, 1993,
Basel/CH

Anders F., C. Zechel, M. Burcin, H. Petry, M. Ueffing, W. Hoffmann, K. Petry,
J. Leers, P. Brix, H. Gröger, A. Anders:
Xiphophorine tumor determinants in concert
J. Cancer Research and Clin. Oncology 119 (suppl. 2), p 64, 1993
Conferment of the Deutsche Krebspreis 1993, Heidelberg, March 24-26, 1993

Anders F., H. Gröger, P. Brix, H. Petry, K. Petry, A. Anders:
Increase of xiphophorine melanoma incidence by retrotransponons?
Pigment Cell Research 6, p. 323, 1993
XVth Intern. Pigment Cell Conference, London, Sept. 26-30, 1993

Anders F., H. Gröger, P. Brix, K. Petry, H. Petry, W. Lüke, C. Zechel,
M. Ueffing, W. Hofmann, A. Anders:
Genetics of cancer growth control
J. Tumor Marker Oncology 8, p. 4, 1993
Sept. 8-11, 1993, Bonn, Germany

Anders F., P. Brix, H. Petry, K. Petry, H. Gröger, A. Anders:
Increase of tumor incidence by retrotransposons?
Annual Tumor Cell Biology Meeting im NCI, NIH,
Bethesda/USA, 1993

Anders F., W. Lüke, H. Petry, K. Petry, H. Gröger, A. Anders:
Increase of melanoma incidence by retrotransposons
In: Melanoma, the Way Forward. International Melanoma Conference
April 6-9, 1994, Brisbane/Australia

Anders F., W. Lüke, H. Petry, P. Brix, C. Fleming, H. Gröger, A. Anders:
Transgenerational acceleration of tumor incidence
J. Tumor Marker Oncology 9, p. 33, 1994
June 12-17, 1994, Naples, Italy

Anders F.:
Carcinogenesis in a fish model
Colloquie, Toxicology, Recherche & Formation, Cancérogenèse et Toxicologie, Carré
des Sciences - Paris, Association pour la Recherche en Toxicologie 1994, pp. 6-8
Paris, April 28, 1994

Anders F.:
Oncodeterminants in concert
Deutsche Gesellschaft für Zellbiologie (invited paper),
Lübeck, 20.-24. März 1994

Anton A., Horneck G., Rydberg B., Cooper P.:
Genetic effects of heavy ions in bacteriophage T1: Survival, repair,
strandbreaks (ssb and dsb)
Molekulare und zelluläre Mechanismen der biologischen Strahlenwirkung,
5. Symp., 29.-31.03.1993, Erlangen

Egenolf R., M. Feige und J. Kiefer:
DNA-Doppelstrangbrüche nach UV-Bestrahlung in Hefezellen (Poster)
14. Tagung der Gesellschaft für Umwelt-Mutationsforschung (GUM) und
3. Workshop der deutschen Sektion des DNA REPAIR NETWORK
Universität Göttingen, 01.-04.03.1994, Göttingen

Füssel K.:
In situ-Hybridisierung zur Untersuchung strahleninduzierter Chromosomenschäden
Diplomarbeit der TH Darmstadt
GSI-Report 94-07

Heilmann J., G. Taucher-Scholz, M. Kikuchi, G. Becker, G. Kraft:
Heavy ion damage in DNA double-strand breaks and their rejoining
GSI Scientific Report 94-1, p.222

Heinrich W.:
Strahlungsfelder in Satelliten und hochfliegenden Verkehrsflugzeugen
Physikertagung Hamburg, 14.-18. März 1994

Horneck G., Baltshukat K., Anton K., Rettberg P., Eschweiler U., Kozubek S.:
Mutation induction in bacterial spores by accelerated heavy ions
European Society for Radiation Biology, 25th Annual Meeting, 10.-14.06.1993,
Stockholm, Schweden

Horneck G.:
Mutagenic effects of heavy ions in bacteria (lecture),
Inter. University, Training Course on Radiation Protection
26.07.-07.08.1993, Dubna, Russia

Horneck G.:
Radiation Biology,
Astronaut Training Lecture,
24.06.1993, DLR Köln, Germany

Horneck G.:
Radiobiological experiments in space
COSPAR Colloquium No. 6, Intern. Round Table on Radiation Risk in Humans
on Exploratory Missions in Space, 11.-14.05.1993, Bad Honnef, Germany

Horneck G.:
Strahlenbiologische Experimente im Weltraum,
Seminarvortrag, Universität Bonn, Exp. Radiologie und Strahlenbiologie,
Universitäts-Klinik, 12.01.1994

Ikpeme S., M. Löbrich, B. Barth, H.-D. Pross, E. Schneider, J. Kiefer:
Heavy Ion Induced DNA Double-Strand Breaks in Yeast as Measured by
Pulsed Field Gel Electrophoresis
GSI Scientific Report 94-1, pp. 221-222, March 1994

Kiefer J. und K. Bernhardt:
Das Repair-Fixation-Modell der zellulären Strahlenwirkung:
Vergleich experimenteller und theoretischer Daten
14. Tagung der Gesellschaft für Umwelt-Mutationsforschung (GUM) und
3. Workshop der deutschen Sektion des DNA REPAIR NETWORK
Universität Göttingen, 01.-04.03.1994, Göttingen

Kiefer J., M. Kost, C. Rußmann:
Action of single ions on individual yeast cells
L.H. Gray Workshop on Microbeams in Biology
Northwood, England, 08.07.-10.07.1993

Kiefer J., U. Stoll, E. Schneider, T. Kranert:
Mutation Induction in Chinese Hamster V79 Cells after Heavy Ion Exposure
Radiation Research 93,
Guildford, England, 11.07.13.07.1993

Kiefer J.:
Biological heavy ion effects and ways to their interpretation
Nuclear Science Centre, New Delhi, India, December 1993

Kiefer J.:
Biological Radiation Effects
10.09.1993, Universitas Indonesia, Jakarta, Indonesia

Kiefer J.:
Radiation induced mutations (invited paper)
Symposium: Emerging frontiers in radiation biology,
Bombay, India 03-06.12.1993

Kiefer J.:
Induction of Mutations by Ionizing Radiations (invited paper)
European Society for Radiation Biology, Joint Meeting,
June 1-4, 1994, Amsterdam, Netherlands

Kost M., C. Rußmann, J. Kiefer:
Das zelluläre Inaktivierungsvermögen einzelner beschleunigter Ionen
Symposium: Molekulare und zelluläre Grundlagen der biologischen Strahlenwirkung,
Erlangen, April 1994

Kost M., C. Rußmann, J. Kiefer:
The Cellular Inactivation Capability of Singel Accelerated Heavy Ions
Fifth European Symposium on Life Sciences Research in Space,
Arcachon, France, 26.09.-01.10.1993

Kozubek S., Horneck G., Roessler K., Ryznar L., Mlejnek P., Vitova H.:
Inactivation, mutation induction, and DNA strand break induction in cells
irradiated at very low temperature
European Society for Radiation Biology, 25th Annual Meeting, 10.-14.06. 1993,
Stockholm, Sweden

Kozubek S., Horneck G.:
Theoretische Interpretation der Mutationsauslösung in Bakterien durch
schwere Ionen
Molekulare und zelluläre Mechanismen der biologischen Strahlenwirkung,
5. Symp., 29-31.03.1993, Erlangen

Kraft G.:
Schwerionenstrahlen in Biophysik und Medizin
DESY, Hamburg 10.12.1993

Kraft-Weyrather W., S. Ritter, M. Scholz, G. Kraft:
Therapy related radiobiological measurements with light ions at SIS and Unilac
GSI Scientific Report 1993, p. 231

Reitz G., Beaujean R.:
Results of dosimetric measurements in space missions,
14th European Cosmic Ray Symposium, 28.08.-03.09.1994,
Balatonfüred, Ungarn

Reitz G., Bücken H.:
The radiobiological experiments on LDEF,
10th IAA Man in Space Symposium, 19.-23.04.1993, Tokio, Japan

Reitz G., Horneck G.:
Radiation health considerations for a Lunar base
2nd Lunar Analysis Laboratory Workshop (LAL-II Workshop),
31.03.-02.04.1993, Dijon, Frankreich

Reitz G.:
Dosimetric results on LDEF and EURECA,
Third LDEF Post-Retrieval Symposium, 08.-12.11.1993, Williamsburg, USA

Reitz G.:
Results of dosimetric measurements in manned missions
5th European Symposium on Life Science Research in Space,
26.09.-01.10.1993, Arcachon, France

Reitz G.:
Results of space experiments
Heavy Ions Research: Space, Radiation Protection and Therapy,
Intern. Symposium, 21.-24.03.1994, Sophia-Antipolis, France

Reitz G.:
Use of nuclear track detectors in determining biological effects of single heavy ions,
IRaP94 - Ionizing Radiation and Polymers, Intern. Symposium, 14.-19.11.1994,
Saint-Francois, Guadeloupe, France

Reitz, G., Bücken H., Facius R., Schäfer M., Beaujean R., Heinrich W., Heilmann C.:
Environmental and personal dosimetry on D2
Symposium on Scientific Results of the German Spacelab Mission D-2;
14.-16.03.1994, Norderney

Rettberg P.:

Radioprotection by Thiol-mediated chemical repair and biological inactivation
(Poster),

5th European Symposium on Life Science Research in Space,
26.09.-01.10.1993, Arcachon, France

Ritter S., E. Nasonova, K. Füssel, G. Kraft:

A new approach to determine the total amount of radiation induced
chromosomal damage

GSI Scientific Report 94-1, p. 229

Ritter S.:

Induktion genetischer Veränderungen durch Röntgen- und Schwerionenstrahlung
GHS Kassel, 23.06.1993

Ritter S.:

Induktion von Chromosomenaberrationen in CHO-K1 Zellen und
reparaturdefizienten XRS-5 Zellen nach hoch LET Bestrahlung
DNA Schäden und ihre Reparatur, 14. Tagung der Gesellschaft für
Umwelt-Mutationsforschung (GUM) und 3. Workshop der deutschen Sektion
des DNA Repair Network, 01.-04.03.1994, Göttingen

Roessler K., Horneck G., Kozubek S.:

Bacteria and spores under 10 MeV ion bombardement at 77 K,
European Geophysical Society (EGS) Meeting 1993, 03.-07.05.1993, Wiesbaden, Germany

Schäfer M., Zimmermann H., Schmitz C.:

Induktion von Doppelstrangbrüchen und ihre Reparatur in bakterieller DNA
nach Bestrahlung mit schweren Ionen, DNA Schäden und ihre Reparatur,
14. Tagung der GUM, 3. WS Dtsche Sektion DNA Repair Network
01.-04.03.1994, Göttingen

Stoll U., E. Schneider, N. Scheerer, B. Barth, J. Kiefer:

Mutationsauslösung in V79 chinesischen Hamsterzellen nach Bestrahlung
mit Ionen hoher Energie

Symposium: Molekulare und zelluläre Grundlagen der biologischen Strahlenwirkung,
Erlangen, April 1993

Stoll U., J. Kiefer, E. Schneider, T. Kranert:

Mutation Induction in Chinese Hamster V79 Cells after Heavy Ion Exposure
International Seminar Molecular Mechanisms in Radiation Mutagenesis and
Carcinogenesis

Doorwerth, Germany, 19.04.-22.04.1993

Stoll U., R. Helbig, P. Schmidt, E. Schneider, J. Kiefer:

Mutation Induction by Heavy Ions: Cross Sections and Molecular Analysis
GSI Scientific Report 94-1, p 226

Taucher-Scholz G.:

Induktion und Rejoining von DNA-Doppelstrangbrüchen in Säugetierzellen nach Bestrahlung mit beschleunigten C12-Ionen
DNA Schäden und ihre Reparatur, 14. Tagung der Gesellschaft für Umwelt-Mutationsforschung (GUM) und 3. Workshop der deutschen Sektion des DNA Repair Network, 01.-04.03.1994, Göttingen

Wagner E., U. Burcin, J. Leers, H. Gröger, C. Zechel, H. Hug, B. Fiebich, A. Smith, A. u. F. Anders:

Oncogene expression and PI response before and after the onset of xiphophorine melanoma
J. Cancer Research and Clin. Oncology 119 (suppl. 2), p 64, 1993

Wehner J., Horneck G.:

Vergleich von Mutationsspektren in dem E. coli Plasmid pUC19 nach Bestrahlung mit UV- und Röntgenstrahlen, DNA Schäden und ihre Reparatur,
14. Tagung der GUM, 3. WS Dtsche Sektion DNA Repair Network,
01.-04.03.1994, Göttingen

Wehner J., Horneck G.:

VUV-Effekte auf pUC19 DNA: Inaktivierung, Mutationsauslösung,
DNA-Strangbrüche
Molekulare und zelluläre Mechanismen der biologischen Strahlenwirkung,
5. Symp., 29.-31.03.1993, Erlangen

Wehner J.:

Vacuum UV effects in pUC19: Inactivation, mutation induction and DNA strand breaks
(Poster)
5th European Congress of Photobiology, 19-26.09.1993, Marburg/Lahn

Zimmermann H., Schäfer M., Schmitz C.:

Schwerioneneffekte in Deinococcus radiodurans: Inaktivierung,
DNA-Strangbrüche
Molekulare und zelluläre Mechanismen der biologischen Strahlenwirkung,
5. Symp., 29-31.03.1993, Erlangen

DOCTORAL DISSERTATIONS

Anton, A.

Genetische Effekte schwerer Ionen auf dem Bakteriophagen T1 - Inaktivierung, Schutz, Reparatur und Strangbruchrate

(Genetic effects of heavy ions on bacteriophage T1 - inactivation, protection, repair and strand breaks)

University of Bonn, 1994

Foster, C.E.

Action spectra for light induced cell inactivation and mutation to ouabain resistance in V79 Chinese hamster fibroblasts

University of Gießen, 1993

Papavassiliou, A.

UV-Inaktivierung des Bakteriophagen T1 im Ultrahochvakuum und bei verschiedenen relativen Feuchten

(UV inactivation of bacteriophage T1 in ultra high vacuum and at different degrees of humidity)

University of Frankfurt/Main, 1994

Ramm, U.

Delta-Elektronen Emission in Stößen schneller schwerer Ionen mit Atomen und einfachen Molekülen

(Delta-electron emission in heavy ion collisions with atoms and simple molecules)

University of Frankfurt/Main, 1993

Schall, I.

Untersuchung der Kernfragmentierung leichter Ionen

(Investigations on nuclear fragmentation of light ions)

Technical University of Darmstadt, 1994

Stoll, U.

Mutationsauslösung durch beschleunigte schwere Ionen in Säugerzellen: Wirkungsquerschnitte und molekulare Veränderungen

(Mutation induction in mammalian cells by accelerated heavy ions: cross sections and molecular alterations)

University of Gießen, 1994

Zimmermann, H.

Wirkung schwerer Ionen auf Zellen von *Deinococcus radiodurans* im Vergleich zu dünn ionisierender Strahlung

(Heavy ion action on Deinococcus radiodurans cells in comparison to sparsely ionising radiation)

University of Köln, 1994

Wehner, J.

Vakuum-UV-Effekte auf das *E. coli* Plasmid pUC19: Inaktivierung, Strangbruchinduktion und Mutationsinduktion

(Vacuum-UV-effects on E. coli plasmid pUC19: Inactivation, strand break induction and mutation induction)

University of Bonn, 1993

Zimmermann, H.

Wirkung schwerer Ionen auf Zellen von *Deinococcus radiodurans* im Vergleich zu dünn ionisierender Strahlung

(Heavy ion action on Deinococcus radiodurans cells in comparison to sparsely ionizing radiation)

University of Köln, 1994

ENCLOSURE # 6

NEUROLAB

12th Joint NASA / DARA-DLR Life Sciences Working Group Meeting

**Ames Research Center
Moffett Field, California
October 26-27, 1994**

**Mary Anne Frey, Ph.D.
Neurolab Program Scientist
LBSAD**

PARTNERS

- UNITED STATES
 - National Aeronautics and Space Administration
 - National Institutes of Health
 - Division of Research Grants
 - National Institute on Aging
 - National Institute of Child Health and Human Development
 - National Institute on Deafness and Other Communication Disorders
 - National Institute of Neurological Disorders and Stroke
 - National Heart, Lung, and Blood Institute
 - National Science Foundation (Sensory Systems and Neuroscience Program)
 - Office of Naval Research

PARTNERS (Continued)

- **INTERNATIONAL**
 - Canadian Space Agency
 - Centre National d'Etudes Spatiales
 - Deutsche Agentur für Raumfahrt-Angelegenheiten
 - European Space Agency
 - National Space Development Agency of Japan

TEAMS, TEAM LEADS, AND PRINCIPAL INVESTIGATORS

- 34 Principal Investigators selected into definition
- 8 science teams formed to integrate science and to optimize use of resources
 - 4 teams with human investigations
 - Autonomic Nervous System
 - Sleep
 - Vestibular
 - Sensory, Motor, and Performance
- 4 teams with animal investigations
 - Adult Rodent
 - Mammalian Development
 - Aquatic
 - Neurobiology
- Team integration facilitated by Team Lead and NASA Project Office

HUMAN INVESTIGATIONS

Autonomic Nervous System

Team Lead: Ron White

Principal Investigator

Affiliation

Experiment Title

Friedhelm Baisch

DLR, Institute of Aerospace Medicine, Germany

Artificial Neural Networks and Cardiovascular Regulation

Gunnar Blomqvist

University of Texas Southwestern, USA

Integration of Neural Cardiovascular Control in Space

Dwain Eckberg

McGuire Research Institute, Inc., USA

Autonomic Neuroplasticity in Weightlessness

David Robertson

Vanderbilt University, USA

Autonomic Neurophysiology in Microgravity

Sleep

Team Lead: Jim Kiley

Principal Investigator

Affiliation

Experiment Title

Charles Czeisler

Brigham and Women's Hospital, USA

Clinical Trial of Melatonin as Hypnotic for
Neurolab Crew

John West

University of California, San Diego, USA

Sleep and Respiration in Microgravity

HUMAN INVESTIGATIONS

Vestibular **Team Lead: Wally Wolfe**

<u>Principal Investigator</u>	<u>Affiliation</u>	<u>Experiment Title</u>
Bernard Cohen	Mount Sinai School of Medicine, USA	Spatial Orientation of the Vestibulo-Ocular Reflex
Gilles Clement	CNRS, College de France	Visual-Otolithic Interactions in Microgravity

Sensory, Motor, and Performance **Team Lead: Jacob Bloomberg**

<u>Principal Investigator</u>	<u>Affiliation</u>	<u>Experiment Title</u>
Otmar Bock	Inst. for Space & Terrestrial Science, Canada	Visuo-Motor Coordination during Spaceflight
Alain Berthoz	CNRS, College de France	Frames of Reference and Internal Models
Philip Njemanze	Chidicon Medical Center, Nigeria	Visual Cortex Blood Flow in Perceptual & Psychomotor Tasks
Chuck Oman	Massachusetts Institute of Technology, USA	Role of Visual Cues in Spatial Orientation
Tracey Shors	Princeton University, USA	The Stress of Space Flight: Effects on Learning

ANIMAL INVESTIGATIONS

Adult Rodent **Team Lead: Mal Cohen**

<u>Principal Investigator</u>	<u>Affiliation</u>	<u>Experiment Title</u>
Ottavio Pompeiano	University of Pisa, Italy	Effects of Microgravity on Gene Expression in the Brain
Gay Holstein	Mount Sinai School of Medicine, USA	Anatomical Studies of Central Vestibular Adaptation
Bruce McNaughton	University of Arizona, USA	Ensemble Neural Coding of Place & Direction in Zero-G
Scott Brady	University of Texas Southwestern, USA	Space Flight, Stress, and Neuronal Plasticity
Charles Fuller	University of California, Davis, USA	CNS Control of Rhythms & Homeostasis during Spaceflight
Muriel Ross	NASA Ames Research Center, USA	Multidisciplinary Studies of Neural Plasticity in Space

Aquatic **Team Lead: David Liskowsky**

<u>Principal Investigator</u>	<u>Affiliation</u>	<u>Experiment Title</u>
Shiro Usui	Toyohashi University, Japan	Subcellular Calcium Regulation in Microgravity
Bruce Jenks	University of Nijmegen, Netherlands	Effect of Microgravity on Brain Differentiation
Barbara Chapman	Cal. Inst. of Technology, USA	Microgravity Effects on Developing Vestibular Afferents
Michael Wiederhold	Univ. of Texas, San Antonio, USA	Development of Vestibular Organs in Microgravity
Stephen Highstein	Washington University, USA	Chronic Recording of Otolith Nerves in Microgravity

ANIMAL INVESTIGATIONS

Mammalian Development

Team Lead: **Bill Heetderks**

<u>Principal Investigator</u>	<u>Affiliation</u>	<u>Experiment Title</u>
Tsuyoshi Shimizu	Fukushima Med. College, Japan	Postnatal Development of Aortic Nerves in Space
Kenneth Kosik	Brigham & Women's Hospital, USA	Neuronal Development under Conditions of Space Flight
Kerry Walton	NYU Medical Center, USA	Effects of Gravity on Postnatal Motor Development
Kenneth Baldwin	University of California, Irvine, USA	Neural-Thyroid Interaction on Skeletal Isomyosin Expression
Richard Nowakowski	Robert W. Johnson Med. School, USA	Reduced Gravity: Effects in the Developing Nervous System
Danny Riley	Medical College of Wisconsin, USA	Effects of Microgravity on Neuromuscular Development
Jacqueline Raymond	Universite de Montpellier II, France	Microgravity and Development of Vestibular Circuits

Neurobiology

Team Lead: **Rose Grymes**

<u>Principal Investigator</u>	<u>Affiliation</u>	<u>Experiment Title</u>
Ingrid Block	DLR, Inst. of Aerospace Med., Germany	Graviperception and Signal Transduction in Single Cells
Eberhard Horn	University of Ulm, Germany	Development of an Insect Gravity Sensory System in Space
Haig Keshishian	Yale University, USA	Effects of Spaceflight on Drosophila Neural Development

NASA PERSONNEL CHANGES

HEADQUARTERS

Frank Sulzman Acting Deputy to LBSAD Division Director
Mary Anne Frey Neurolab Program Scientist
Bill Gilbreath JSC Space Station Office
Cindy Martin Neurolab Program Manager

JOHNSON SPACE CENTER

Howard Schneider Retired
Jerry Homick Neurolab Mission Scientist

INVESTIGATORS WORKING GROUP MEETING

August 2-4, 1994

- Objectives
 - Introduction and orientation to NASA for Principal Investigators selected into definition
 - Working group meeting for teams to start integration of proposals

- Results
 - Crew time allocated to each team
 - PIs directed to submit draft copy of integrated proposal on October 1, 1994

TEAM LEAD MEETING

October 12, 1994

- Objectives
 - ARC and JSC Projects provided an overall assessment of their teams requested resources
 - Each Team Lead provided a status on their team's integrated protocols
 - Team Leads provided a status on
 - Functional objectives
 - Resources required to support these activities
 - Crew time
 - Subjects
 - Hardware
 - Rack space / Stowage volume
 - National Institutes of Health (NIH) Division of Research Grants (DRG) provided a description of Science Peer Review of the integrated proposals
 - Format for the Team Integrated Proposals
 - Protocols
 - Co-Investigators
 - Budget

TENTATIVE SCHEDULE

1994

November 5	Send PIs instructions for integrated proposals and revised budgets
Nov. 15 - Dec. 15	NASA meetings with partners on Neurolab budgets
November	Preliminary feasibility assessment analysis in progress by NASA Projects and Mission Science
December	Preliminary feasibility assessment to NASA Headquarters
Nov '94 - April '95	Experiment / Discipline Document

1995

Early January	Tentative Team Lead Meeting
January	Tentative Steering Committee Meeting (Dependent on preliminary Neurolab payload)
January/February	Investigators Working Group Meeting #2 (IWG #2) at KSC (Final version of integrated proposals due)
February	Payload Specialist Selection process starts
March	Integrated Experiments Requirements Document (IERD), Preliminary
March	NIH Science Review

TENTATIVE SCHEDULE (Continued)

1995 (Continued)

April	NASA Payload Recommendation Meeting
April	Steering Committee Meeting
Nov. '94 - April	Experiment / Discipline Document
May	NIH Council Meetings
May / June	Selection for Development (Recommend payload to NASA Associate Administrator)
May	Mission Science Requirements Document (MSRD), Preliminary
May	JSC Project Preliminary Design Review (PDR)
July 1	Start funding for development
July	ARC Project PDR
July	Timeline, Preliminary
August	IWG #3
September	Human Research Policy and Procedures Committee - Payload Protocols
November	Integrated PDR
Nov. - Jan. '96	JSC Mock-up Integration

TENTATIVE SCHEDULE (Continued)

1996

February	IWG #4
February	Projects' Critical Design Review (CDR)
February	Safety Reviews Phase 0/I (Flight and Ground)
February	Payload Crew Selection
March -Jan. '98	Crew Training
June	Integrated CDR
August	IWG #5
August	Orbiter Crew Selection
September	Safety Review Phase II (Flight and Ground)
October	Flight Hardware Delivery to JSC
December	Science Verification Testing
Dec. Sept. '97	KSC Level IV Integration

TENTATIVE SCHEDULE (Continued)

1997

February	IWG #6
February	Safety Review Phase III, Ground
February / March	Hardware Delivery to KSC
Feb. - Nov.	Mission Integrated Training Simulation (MITS)
June	Safety Review Phase III, Flight
August	IWG #7
August	Science Readiness Review
Oct. - May '98	Baseline Data Collection
Sept. - Dec.	KSC Level III/II Integration
November	Flight Operations Readiness Review
Nov - Feb. '98	Joint Integrated Training Simulations (JIS)
December	Payload Readiness Review
Dec. - Feb. '98	KSC Level I Integration

TENTATIVE SCHEDULE (Continued)

1998

January	Launch Readiness Review
February	NeuroLab Mission
March	Postflight Operations Review Report
August	6 Month Postflight Science Report
August	IWG #8

1999

February	Final Science Report / Meeting
----------	--------------------------------

ENCLOSURE # 7



German-CLS-Cooperation in Life Sciences

1. before 1992:

- 1978 Salyut 6: experiments in the frame of the INTERKOSMOS program (GDR) on the Soviet space station; German cosmonaut (Jähn)
- experiments in gravitational and radiation biology on reentry satellites

2. 1992:

- March '92: German MIR '92 mission with 13 Life Sciences Experiments; German cosmonaut (Flade)
- December '92 / January '93: BION 10; cooperative experiment in gravitational biology; experiments in radiation biology within the ESA frame

3. 1993:

- July '93: cooperative experiment (HSD) during the French MIR mission

German-Russian-Cooperation in Life Sciences

4. 1994:
 - MIR '92 extension (cooperative experiments HSD, VOG, SUR, PSY)
 - strong participation in the EUROMIR '94 mission (11 experiments)
 - CPK/CNES/DARA pre-/postflight study (1994 - 1996)
5. Present planning or considerations:
 - participation in the EUROMIR '95 mission (6 experiments)
 - further MIR utilization, e. g. cooperative MIR '96 (?)
 - in addition, further utilization of reentry satellites

GERMAN EXPERIMENTS FOR EUROMIR '94 MISSION

- Status July 1994 -

Principal Investigator

Experiment Title

CARDIOVASCULAR SYSTEM

Kirsch (U Berlin)

Fluid Shifts into and out of Superficial
Tissues and Tissue Stability along Body
Axis under Micro-g Conditions in Man

Gunga (U Berlin)

Effects of Changes in Central Venous
Pressure on the Erythropoietic System
under 1-g and Micro-g Conditions

NEUROPHYSIOLOGY

Scherer (U Berlin)

Adaptation of Basic Vestibulo-Oculomotor
Mechanisms to Altered Gravity Conditions

MUSCULOSKELETAL SYSTEM

Zange (DLR)

Magnetic Resonance Spectroscopy, Imaging
of Human Muscles, and Muscle Biopsy
before and after Space Flight

ENDOCRINOLOGY and METABOLISM

Drummer (DLR)

Fluid and Electrolyte Balance during
Weightlessness and Possibilities of their
Regulation

Riepl (U München)

Gastroenteropancreatic Peptides during
Zero Gravity and their Possible
Involvement in Space Motion Sickness

Strasburger (U München)

Non-Invasive Stress-Monitoring in Space
Flight by Hormone Measurement in Saliva

GERMAN EXPERIMENTS FOR EUROMIR '94 (contd.)

- Status July 1994 -

Principal Investigator

Experiment Title

OPERATIONAL MEDICINE

Gundel (DLR)

Circadian Rhythms and Sleep during a
30-Day Space Mission

Mittelstaedt (MPI
Seewiesen)

Spatial Orientation and Space Sickness

RADIATION BIOLOGY

Reitz (DLR)

Radiation Health during Prolonged Space
Flight

Obe (U Essen)

Chromosomal Aberrations in Peripheral
Lymphocytes of Astronauts

GERMAN EXPERIMENTS FOR EUROMIR '95 MISSION

- Status July 1994 -

Principal Investigator

Experiment Title

NEUROPHYSIOLOGY

Dietrich (U München)

Differential Effects of Otolith Input on Ocular Lateropulsion, Cyclorotation, Perceived Visual Vertical, Straight Ahead and Tonic Neck Reflexes in Man

Markham/Scherer
(USA/U Berlin)

Correlation of Eye Torsion Changes with the Time Course of the Space Adaptation Syndrome

ENDOCRINOLOGY AND METABOLISM

Drummer (DLR)

Non-invasive Monitoring of Drug Metabolism and Drug Effect During Prolonged Weightlessness

MUSCULOSKELETAL SYSTEM

Zange (DLR)

MR Spectroscopy and Imaging of Human Muscles and Bones Before and After Space Flights

RADIATION BIOLOGY

Reitz (DLR)

Radiation Health during Prolonged Spaceflight

Obe (U Essen)

Chromosomal Aberrations in Peripheral Lymphocytes of Astronauts

Agreement on Scientific Cooperation between CPK, CNES and DARA

Goal

- o **Cooperation of the three partners in pre- and postflight investigations on Russian cosmonauts in the field of human physiology in 1994 - 1996.**
- o **Using jointly the Russian facilities at CPK and special equipment provided by CNES and DARA for possible future space station implementation**

DARA contribution to the scientific program

- o **determination of the human cardiovascular functional status**
- o **evaluation of cardiovascular deconditioning and fluid shift phenomena**
- o **evaluation of longterm physiological changes of muscle efficiency**

Agreement on Scientific Cooperation between CPK, CNES and DARA (contd.)

DARA contribution to the equipment

MEDEX Diagnosis System consisting of

- Central Data Processing Unit
- Data Transfer Interface
- Laptop Control panel
- Basic Module (ECG, EMG, Temp. etc.)
- Impedance Module
- EEG Module
- NIR (Near Infra Red; peripheral blood flow)

Scientific Program at CPK

- | | |
|-----------|--|
| 1994 | MEDEX-System validation with LBNP and centrifuge protocol, tilt table and orthostasis test |
| 1995 - 97 | Pre- and postflight measurements of cosmonauts (6 equipages = 12 crew members) |

	<p>NASA/DARA Meeting MIR '96 Concept MIR '96</p>	<p>WO2</p>
---	--	------------

Programmatic Aspects

Objectives

Manned spaceflight has been an important element of the German space program over the last decades (Spacelab System, Spacelab-/MIR-Missions, Ground Infrastructure).

Germany intends to maintain its leading role in Europe in the area of manned spaceflight.

Future manned space activities will be strongly oriented towards international cooperation, both in the area of scientific programs as well as in the area of space infrastructure.

	<p>NASADARA Meeting MIR '96 Concept MIR '96</p>	WO2
---	---	-----

Detailed objectives of a cooperative MIR '96 mission are:

- Continuity of scientific programs
 - regular access to space between 1995 and the space station era
 - maximization of scientific return by internationally coordinated programs in view of scarce mission opportunities
 - multidisciplinary research comparable to space station utilization

	<p>NASADARA Meeting MIR '96 Concept MIR '96</p>	WO2
---	---	-----

- Cooperation with international partners
 - strengthening of scientific cooperation
 - gain of experience in common system/payload operations including DARA, NASA, and RSA
 - effective utilization of scarce resources



NASA/DARA Meeting MIR '96
Concept MIR '96

WO2

- Preparation of space station utilization
 - preparation of user community for space station operations
 - test of operational interfaces between German and Russian systems
 - optimization of user services with regard to ground/orbit interactivity
 - strengthening of know-how and experience of user support centers

	<p>NASADARA Meeting MIR '96 Concept MIR '96</p>	<p>WO2</p>
---	---	------------

Cooperation principles

- exchange of scientific data for cooperative scientific programs
- common utilization of scientific equipment
- distribution of tasks for system-/payload operations as for space station operations
- no exchange of funds

Required STS Services

- flight of German astronaut aboard the shuttle (return only)
- stowage accommodation for samples

	<p>NASA/DARA Meeting MIR '96 Concept MIR '96</p>	<p>WO2</p>
---	--	------------

Mission Scenarios

- DARA proposal
 - launch of German astronaut with Soyus
 - mission duration onboard MIR for 2 - 3 month
 - return of German astronaut with Shuttle
 - prelaunch BDC in Star City, postflight BDC at KSC
- Constraining factor: max. 3 crew-members possible with 1 Soyus capsule docked to MIR, i.e. German and American Astronaut not feasible onboard MIR at a time (with one crew rescue vehicle).

	<p style="text-align: center;">NASA/DARA Meeting MIR '96 Concept MIR '96</p>	<p style="text-align: center;">WO2</p>
---	--	--

- RSA proposal
 - 30 day mission with Soyus launch/landing; mission operations during crew exchange
 - * Soyus TM 25: Nov., 1996
 - * Soyus TM 26: Apr., 1997
 - * Soyus TM 27: Aug., 1997
- Possible solutions for extended mission duration (> 30 days) with Shuttle involvement to be investigated



Scientific Program MIR '96

WS2

MIR '96 to be seen as multidisciplinary mission with experiments from

- Earth Observation
- Space Science
- Technology
- Research under Space Conditions
 - Life Sciences
 - Biology
 - Human Physiology
 - Materials Science

Being a manned mission, emphasis is on Life Sciences, especially on HUMAN
PHYSIOLOGY



Scientific Program

MIR '96

- Human Physiology -

<u>Research Area</u>	<u>Research Topic</u>	<u>Facility</u>
Cardiovascular and Pulmonary Physiology	cardiovascular deconditioning, fluid shift, homeostatic regulation	MEDEX System HSD Tonometer PHYSIOLAB (CNES) RMS-II (ESA) MIR Ergometer (Russia) MIR LBNP (Russia)
Neurovestibular Physiology	graviperception and gravisensibility, vestibular-ocular interactions, neural integration and regulation, space adaptation syndrome	VOG Cognilab (CNES)



Scientific Program

MIR '96

- Human Physiology - (cont.)

<u>Research Area</u>	<u>Research Topic</u>	<u>Facility</u>
Bone and Muscle Physiology	Muscular structure and function, bone decalcification	NMR (Pre-/Postflight) Bone Densitometer (ESA)
Endocrinology and Metabolism	Hormonal regulation, immune system	Blood Collection Kit, Urine Monitoring System, Saliva Sampling Kit
Operational Medicine	Human performance, circadian rhythms	Computer, Questionnaire



Scientific Program

MIR '96

- Biology -

Research Area

Gravitational Biology

Radiation Biology

Research Topic

signal transduction chain
(graviperception-gravitransduction-
graviresponse)

dosimetric mapping,
radiation effects
chromosomal aberration

Facility

BIOLABOR D-2
components (e.g.
incubators)

Biostack
Active Dosimetry Unit



Scientific Program

MIR '96

- Materials Science -

Research Area

Materials Research

Physical Chemistry and
Processing

Research Topic

Crystal growth of semiconductors,
solidification dynamics of alloys,
phase separation phenomena in
miscibility gap systems

Thermophysical properties of
undercooled melts, critical point
phenomena

Facility

CSK-4 (CSK-1)
GALLAR (Russia)
KRATER (Russia)
ZONA-3 (Russia)
OPTIZON (Russia)

CSK-4
ALICE (CNES)



Scientific Program

MIR '96

- Cooperation -

MIR '96 is proposed as a cooperative mission, from operational as well as scientific point of view.

—> Scientific cooperation appreciated with scientists from

- IBMP
- ZPK
- Other Russian Institutions
- CNES
- ESA
- (NASA)



Scientific Program

MIR '96

- Cooperation - (cont.)

—> Cooperative use of facilities from

- Russia (e.g. LBNP, Ergometer)
- CNES (e.g. Physiolab, Cognilab)
- ESA (e.g. Bone Densitometer, Respiratory Monitoring System)
- NASA (to be elucidated)



Scientific Program

MIR '96

- Cooperation - (cont.)

MIR '96 as German cooperative mission is to be coordinated with the complete MIR utilization scenario:

- Russian scientific activities
- EUROMIR '95
- Shuttle/MIR missions
(e.g. utilization of ESA BIORACK)
- Cassiopeeé (French MIR 7/96)
- GERMAN MIR '96 (e.g. 10 - 12/96)
- French MIR '97 (?)
- EUROMIR '97 (?)

ENCLOSURE # 8



**NASA-DARA WORKING GROUP
Ames Research Center
October 26-28, 1994**

SMALL PAYLOADS

- PRIMARILY UTILIZES SHUTTLE MIDDECK LOCKERS FOR FLIGHT OPPORTUNITIES
- RESEARCH AREAS INCLUDE:
DEVELOPMENTAL BIOLOGY
National Institutes of Health- Rodent Series
 - 2-3 flights per year over five years, first flight 11/94
 - utilizes animal enclosure modules
 - workings toward mouse flights, first flight early 1996

Aquatic Research Facility

- joint agreement with CSA (50/50) for one flight, TBD for future opportunities
- first flight planned for early 1996

Closed Equilibrated Biological Aquatic System

- joint agreement with DARA for one flight
- first flight planned for mid-late 1997
- hardware under fabrication by DARA



NASA-DARA WORKING GROUP
Ames Research Center
October 26-28, 1994

SMALL PAYLOADS (cont.)

PLANT RESEARCH and TECHNOLOGY

Plant Growth in Microgravity Series (PGIM)

- one to two flights per year
- utilizes new plant growth facility (PGF), which includes active environment and temp control
- first flight planned for early 1996

Microgravity Plant Nutrient Experiment

- plant nutrient delivery system porous tube technology flight planned for early 1996

Chromosomes and Plant Cell Division in Space Series (CHROMEX)

- Flown five times to date, mostly reproductive studies
- anticipate to be less active with start-up of PGIM series, because utilizes less advanced Plant Growth Unit (PGU)



**NASA-DARA WORKING GROUP
Ames Research Center
October 26-28, 1994**

SMALL PAYLOADS (cont.)

HUMAN FACTORS

Human Performance Series (HP)

- First flight planned for early 1996 focuses on the stability and accuracy of cognitive and psychomotor performance across work shifts
- one to two flights planned per year

CELLULAR RESEARCH

National Institutes of Health Series - Cells

- two to three flights per year over five years
- musculoskeletal cell studies undertaken for five flights
- first flight occurred in April 1994
- utilize Space Tissue Loss hardware developed by the Walter Reed Army Institute of Research (automated cell culture system)
- second flight scheduled for November 1994, examines in-vitro calcification, and effects of space on skeletal Myofibers



NASA-DARA WORKING GROUP
Ames Research Center
October 26-28, 1994

SMALL PAYLOADS (cont.)

ACROSS DISCIPLINES

Biological Research in a Can Series (BRIC)

- simple, passive petri dish container, which can be terminated with GN2 freezing
- one to three flights planned per year, not dedicated to a particular research area
- has flown twice, from gypsy moth larvae to starch concentration

Simplex

- centrifuge/incubator which utilizes Type I containers
- planned to be flight ready mid 1995
- hardware under fabrication by DARA

FUTURE ACTIVITY (Space Station ERA)

- EXPRESS RACK payloads, which are drawer size, or middeck size payloads will be flown in a rack dedicated to quick turnaround payloads, such as those in the small payloads program



NASA-DARA WORKING GROUP
Ames Research Center
October 26-28, 1994

SMALL PAYLOADS (cont.)

DARA SMALL PAYLOADS PARTICIPATION

- Will provide hardware details on the following for submission to the division wide NRA to solicit science utilization
 - SIMPLEX
 - GN2 Insert (test tube adaptability)
 - Cell culture containers (simple initiation/termination systems used on D2)
- One flight of CEBAS with Wiederhold and Blum projected for mid-late 1997
- Possible small payload flight candidate - I. Block (DLR) for BRIC flight planned for mid-late 1995

ENCLOSURE # 9

CO₂ STUDY AT DLR

**Presentation to
12th Joint NASA/DARA-DLR
LIFE SCIENCES WORKING GROUP MEETING
Ames Research Center
Moffett Field, California
October 26-27, 1994**

**Mary Anne Frey, Ph.D.
Program Manager
LBSAD**

CO₂ STUDY AT DLR

PURPOSES

- **Learn the effect of moderately elevated CO₂ levels on human physiology as a guide for setting CO₂ limits for the Space Shuttle, Spacelabs, and International Space Station**
- **Understand the impact of elevated levels of CO₂ that occur in Mir on human physiology**

CO₂ STUDY AT DLR INVESTIGATIONS

- **CIRCADIAN RHYTHMS**
 - **PARISI**
 - Effects of CO₂ on the circadian system, sleep, and respiration
 - **GUNDEL**
 - Sleep regulation and circadian rhythmicity during exposure to elevated CO₂ levels
 - **SAMEL**
 - Circadian rhythms and stress under different CO₂ concentrations and confinement conditions

CO₂ STUDY AT DLR

INVESTIGATIONS (CONT.)

- **METABOLISM**
 - **NOTH/KRASNEY**
 - Effects of sustained low-level elevations of CO₂ on cerebral blood flow and autoregulation of the cerebral vasculature in humans
 - **STROHL**
 - Low-level CO₂ effects on dead space, gas mixing, and closing volume
 - **DRUMMER**
 - Effect of elevated CO₂ concentration on calcium, sodium, and water metabolism
 - **HOFFMAN**
 - Effects of a long-term CO₂ exposure on parameters of physical fitness

CO₂ STUDY AT DLR

INVESTIGATIONS (CONT.)

- **PERFORMANCE**
 - **MANZEY**
 - Effects of CO₂ on cognitive, psychomotor, and time-sharing during confinement
 - **TUROWSKI**
 - Effect of elevated CO₂ levels on frontal Theta rhythm during task performance

CO₂ STUDY AT DLR

SCHEDULE

- READINESS REVIEW 10/6**
- START BASELINE TESTING 10/17**
- START 0.7% CO₂ EXPOSURE 10/19**
- END 0.7% CO₂ EXPOSURE 11/11**
- POST-CHAMBER TESTING 11/18**
- DATA ANALYSIS 11/19-12/14**
- MEETING TO DISCUSS RESULTS 12/15**
- SECOND CHAMBER STUDY Early '95**

CO₂ STUDY AT DLR

TOPICS FOR DISCUSSION

- **Tax on NASA payment to DLR**

ENCLOSURE # 10

DATA ARCHIVE STATUS AND PLANS

R. J. White

SPACELINE

SPACELINE: AN ONLINE BIBLIOGRAPHIC DATABASE IN THE SPACE LIFE SCIENCES

- Cooperative Activity of the Life and Biomedical Sciences and Applications Division of NASA and the National Library of Medicine. Analogous to MEDLINE.
- Consolidates the results of the growing body of space life sciences research into a single, accessible resource, and enhances dissemination and visibility of this research to the space life sciences community, the broader scientific and educational communities, and the public
- Initial online database consists of a subset of NLM databases, from 1966 to the present, and NASA references of recent (1992-95) publications, primarily of investigators supported by NASA. When mature, SPACELINE will include both U.S. and international publications, reporting flight and ground-based research across the spectrum of space life sciences subject areas, from 1961 onward.
- Accessed via direct searching, which requires some familiarity with NLM searching, or via NLM's Grateful Med software, an interface that provides easy-to-use, inexpensive access to the literature

Schedule

- Fall 94: creation of SPACELINE prototype; begin transferring NASA data to NLM
- Early-mid 1995: database testing by volunteer testers
- Fall 1995: target date for first online availability

LIFE SCIENCES DATA ARCHIVE

Goal

- To develop a method for archiving and distributing results of space life sciences research sponsored by the NASA Life and Biomedical Sciences and Applications Division

Purposes of the Archive

- To increase the effectiveness of space life sciences data management in order to maximize the science output from these missions
- To provide a central repository of space life sciences data
- To provide researchers, educators, students and the general public with better access to life sciences information and results
- To provide access to data and information for future experiment planning and retrospective data analysis

Approach

- Existing assets are utilized
- Data from a particular mission are archived at the major data collection centers (ARC, JSC, KSC)
- Existing computer systems and user support services of the National Space Sciences Data Center (NSSDC) are used as the initial computer entry point for users
- Detailed information and data for each experiment are archived on CD-ROM by the appropriate NASA data collection center
- Activities of these existing facilities are coordinated at a NASA life sciences central node
- Central node also develops a mission CD-ROM product, which contains an overview of all the experiment data archived for a particular mission

Schedule

- December 1994 Delivery of prototype system to NASA Headquarters
- Jan. - Oct. 1995 Evaluation of prototype by potential user groups
- October 1995 SLS-1 information will be available to all users
- 1997 Fully operational, multiple-mission archive

ENCLOSURE # 11

CARDIOLAB

CNES/DARA COOPERATION IN CARDIOVASCULAR RESEARCH

- DARA and CNES are involved in the development of facilities dedicated to the exploration of the cardiovascular system of astronauts with mainly two hardware systems:
 - MEDEX (DARA)
 - PHYSIOLAB (CNES)
- A thorough analysis of the functional aspects reveals that the approaches are absolutely complementary.
- On these bases, DARA and CNES decided to put together their respective competencies with the goal to develop a new hardware, CARDIOLAB, for its use on the future International Space Station. As preparatory and accompanying steps, an extensive cooperative program in cardiovascular research on ground and in space is planned.
- The scientific goals of this approach are the following:
 - to study the adaptation of the cardiovascular system to microgravity
 - to guarantee to the crew members a high level of safety from the point of view of operational medicine (prevention and diagnostics).

CARDIOLAB

CNES/DARA COOPERATION IN CARDIOVASCULAR RESEARCH

The following functions are assumed to be performed by CARDIOLAB:

- the basic cardiovascular parameters: simple ECG, systolic and diastolic blood pressure, respiratory activity signal, skin temperature, EMG signal,
- longitudinal impedance measurement and profile electrical impedance tomography,
- regulation of human peripheral micro-circulation,
- electro-encephalography signal (EEG),
- hours ECG and blood pressure,
- continuous blood pressure,
- venous compliance (plethysmography) and muscle tone,
- peripheral resistance (femoral, cerebral and aortic).

CARDIOLAB

CNES/DARA COOPERATION IN CARDIOVASCULAR RESEARCH

COOPERATION IN THREE PHASES

● Cooperation in ground studies

- Teams of German and French scientists will jointly participate in bedrest studies planned by CNES in 1995 and 1996.
- Between 1994 to 1996, investigations of physiological parameters of Russian cosmonauts during pre- and post-flight periods will be performed in the frame of a trilateral cooperation between DARA, CNES and CPK.

● Cooperation on board of MIR station:

- The first utilization of the CNES PHYSIOLAB in space will be during the French MIR '96 mission Cassiopee. The first utilization of MEDEX is foreseen in a German MIR '96 mission. Also, the Cassiopee PHYSIOLAB hardware will be available for a German MIR '96 mission in exchange for implementing French experiments. Vice-versa, CNES may use the German MEDEX hardware for a planned French MIR 97-98 and implement German experiments.

● Cooperation for Space Station:

- Based on the MEDEX and PHYSIOLAB experiences, CNES and DARA will jointly develop a common facility for cardiovascular research for its use aboard the International Space Station, the CARDIOLAB.

Concept of MEDEX

Human Physiological Data Acquisition and Diagnosis System

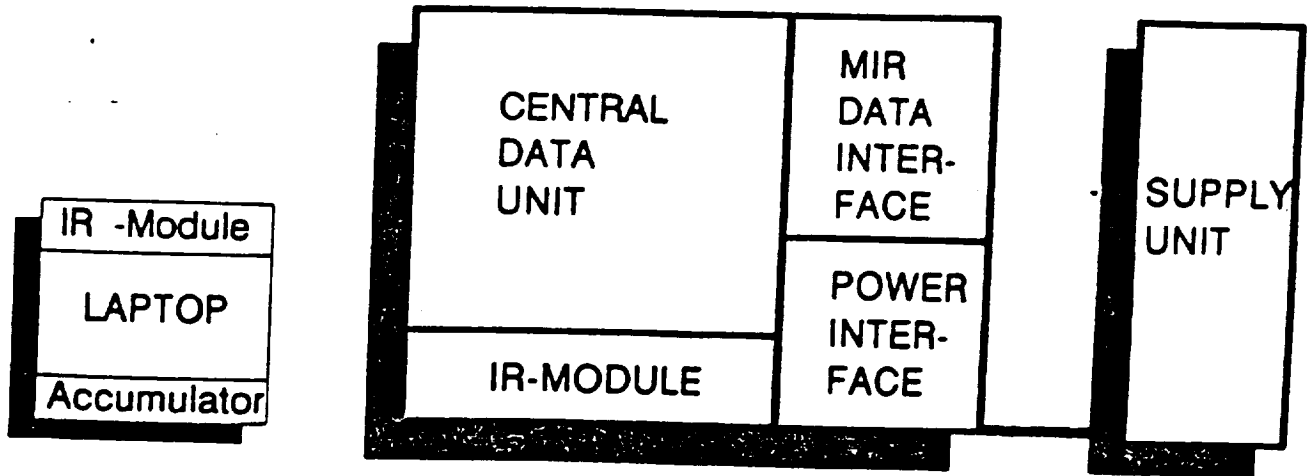

Measurement modules

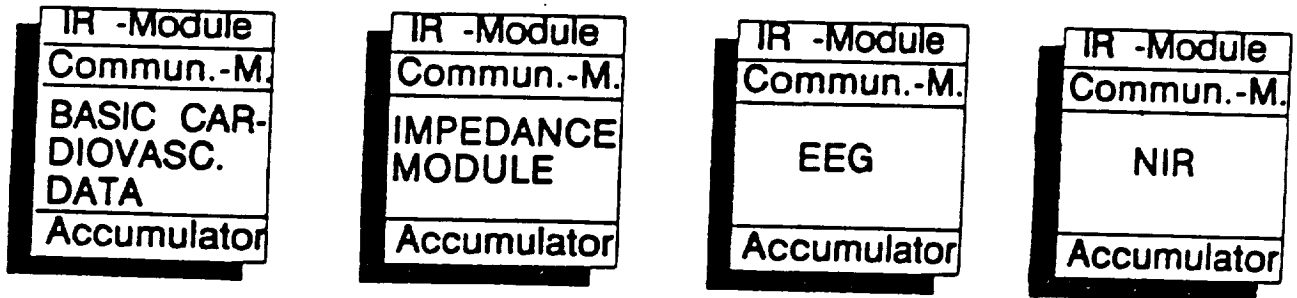

Stimulation devices

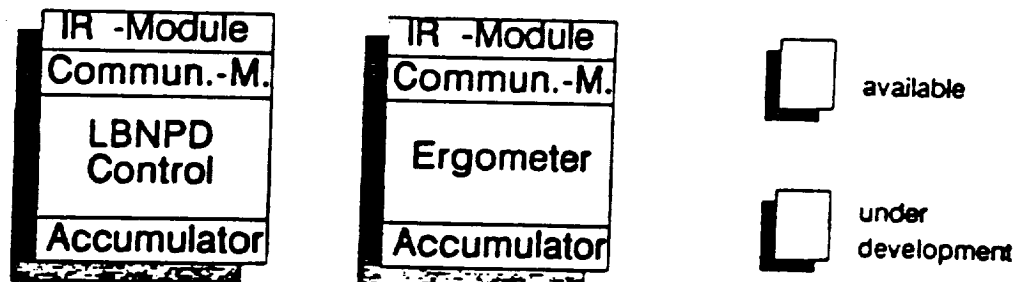

CARDIOLAB Configuration

Physiological Parameter	PHYSIOLAB component	MEDEX component
blood pressure	Portapress	
respiratory rate		Basic Module
temperature		Basic Module
ECG	Holter	Basic Module
EEG		EEG Module
arterial resistance	Portable Doppler	
venous compliance	Plethysmogr.	
muscle tonicity	Reflexometer	Imp. Module (BIM)
fluid distribution by body impedance		Imp. Module (EIT)
fluid distribution by tomography		NIR Module
microcirculation		
blood/urine analysis	(CNES study)	(DARA)
stimulation devices	(CNES)	(DARA)
data acquisition	(CNES)	

MEDEX - Schedule

Laboratory Model I	Delivery and functional test	18. Oct. 1994
Laboratory Model I	Delivery to ZPK, Moscow	24. Oct. 1994
	CNES/DARA Experimenter /Coordination Meeting for Pre-postflight Studies at ZPK	24./25. Nov. 1994
Laboratory Model I	Verification phase at ZPK	Nov. - Dec. 1994
Laboratory Model II	Manufacturing	15. Oct. 1994 - 31. Jan. 1994
Laboratory Model I	Pre- and postflight investigations at ZPK	6 Missions/Equipages i.e. 12 Cosmonauts

Lab. Model I

Central Unit with
Data Interface
Supply Unit

Mobile Terminal

Basic Module

Impedance Module

EEG Module

Lab. Model II

Central Unit with
Data Interface
Supply Unit

Mobile Terminal

Basic Module

Impedance Module

EEG Module

NIR Module

LBNP Control

Leg Ergometer

The logo for DARA, featuring the word "DARA" in a stylized, italicized, sans-serif font. The letters are bold and slanted to the right. A diagonal line cuts through the bottom right corner of the letters, creating a sense of motion or a signature.

ENCLOSURE # 12

12TH JOINT NASA/DARA-DLR LIFE SCIENCES WORKING GROUP MEETING
OCTOBER 26, 1994

<u>NAME</u>	<u>ORGANIZATION</u>	<u>PHONE/FAX</u>
Ronald White, Chairman, NASA Delegation	NASA/HQ	(202) 358-2530 / 358-4168
Gunter Ruyters, Chairman, DARA Delegation	DARA	449-228-447-214 / 700
Joan Vernikos	NASA/HQ	(202) 358-2530 / 358-4168
Joni Richards	NASA/HQ	(202) 358-2205 / 358-4168
Tom Scott	NASA/HQ	(202) 358-0870 / 358-4168
Jurgen Kiefer	DARA/NSCORT	449-641-702-2602 / 2672
Peter Graef	DARA	449-228-447-373 / 714
Hans-Ulrich Hoffmann	DARA	449-228-447-328 / 714
Aloke Chatterjee	LBL/NSCORT	(510) 486-5415
Hans Wegmann	DLR	(02203) 604-3076
Mary Anne Frey	NASA/HQ	(202) 358-2359 / 358-4168
Walter Schimmerling	USRA/NASA HQ	(202) 479-2609
Gunnar Blomqvist	Univ. of Texas, NSCORT	(214) 648-3425
John Lett	CSC/NSCORT	(303) 491-5542
Julianna Klejnot	LESC/DC	(202) 863-5284 / 863-5240

**12TH JOINT NASA/DARA-DLR LIFE SCIENCES WORKING GROUP MEETING
OCTOBER 27, 1994**

<u>NAME</u>	<u>ORGANIZATION</u>	<u>PHONE/FAX</u>
Ronald White, Chairman, NASA Delegation	NASA/HQ	(202) 358-2530 / 358-4168
Gunter Ruyters, Chairman, DARA Delegation	DARA	449-228-447-214 / 700
Joan Vernikos	NASA/HQ	(202) 358-2530 / 358-4168
Joni Richards	NASA/HQ	(202) 358-2205 / 358-4168
Tom Scott	NASA/HQ	(202) 358-0870 / 358-4168
Jurgen Kiefer	DARA/NSCORT	449-641-702-2602 / 2672
Peter Graef	DARA	449-228-447-373 / 714
Hans-Ulrich Hoffmann	DARA	449-228-447-328 / 714
Aloke Chatterjee	LBL/NSCORT	(510) 486-5415
Hans Wegmann	DLR	(02203) 604-3076
Mary Anne Frey	NASA/HQ	(202) 358-2359 / 358-4168
Walter Schimmerling	USRA/NASA/HQ	(202) 479-2609
Gunnar Blomqvist	Univ. of Texas, NSCORT	(214) 648-3425
John Lett	CSC/NSCORT	(303) 491-5542
Victor Schneider	NASA/HQ	(202) 358-2204 / 358-4168
Ken Souza	NASA/ARC	(415) 604-5736 / 604-1165
Robert Hogan	NASA/ARC	(415) 604-5248
Chris Maese	NASA/ARC	(415) 604-6633 / 604-0399
Chuck Winget	NASA/ARC	(415) 604-5753 / 604-0399
Tad Savage	NASA/ARC	(415) 604-5940 / 604-0399
Rose Grymes	NASA/ARC	(415) 604-3239 / 604-3954
Doug Gruendel	CSAT/NASA/HQ	(202) 863-5253 / 863-5240
Charles Wade	NASA/ARC	(415) 604-3943 / 604-3954
Julianna Klejnot	LESC/NASA/HQ	(202) 863-5284 / 863-5240

REPORT DOCUMENTATION PAGE

Form Approved OMB No. 0704-0188

Public reporting burden for this collection of information is estimated to average 1 hour per response, including the time for reviewing instructions, searching existing data sources, gathering and maintaining the data needed, and completing and reviewing the collection of information. Send comments regarding this burden estimate or any other aspect of this collection of information, including suggestions for reducing this burden to Washington Headquarters Services, Directorate for Information Operations and Reports, 1215 Jefferson Davis Highway, Suite 1204, Arlington, VA 22202-4302, and to the Office of Management and Budget, Paperwork

1. AGENCY USE ONLY (leave blank)	2. REPORT DATE May 1, 1995	3. REPORT TYPE AND DATES COVERED Final October 26 & 27, 1994
4. TITLE AND SUBTITLE Minutes of the 12th Joint NASA/DARA-DLR Life Sciences Program Working Group Meeting		5. FUNDING NUMBERS
6. AUTHOR(S) Roland J. White, Ph.D., Co-Chairman, NASA/DARA-DLR LSWG		
7. PERFORMING ORGANIZATION NAME(S) AND ADDRESS(ES) Life and Biomedical Sciences and Applications Division National Aeronautics and Space Administration Washington, D.C. 20546		8. PERFORMING ORGANIZATION REPORT NUMBER
9. SPONSORING / MONITORING AGENCY NAME(S) AND ADDRESS(ES) National Aeronautics and Space Administration Washington, DC 20546		10. SPONSORING / MONITORING AGENCY REPORT NUMBER NASA TM-110655
11. SUPPLEMENTARY NOTES		
12a. DISTRIBUTION / AVAILABILITY STATEMENT Unclassified/Unlimited Subject Cat.51		12b. DISTRIBUTION CODE
13. ABSTRACT This report contains the final minutes of the 12th Joint NASA/DARA-DLR Life Sciences Program Working Group Meeting and includes the presentations made by participants.		
14. SUBJECT TERMS Conferences, aerospace medicine, life sciences, life support systems, gravitational physiology		15. NUMBER OF PAGES 252
		16. PRICE CODE
17. SECURITY CLASSIFICATION OF REPORT Unclassified	18. SECURITY CLASSIFICATION OF THIS PAGE Unclassified	19. SECURITY CLASSIFICATION OF ABSTRACT Unclassified
20. LIMITATION OF ABSTRACT Unclassified		

Available from NASA Center for AeroSpace Information
800 Elkridge Landing Road
Linthicum Heights, MD 21090-2934
(301) 621-0390

