

NASA Technical Memorandum 4720

IN-05
555
p. 20

A Historical Overview of Flight Flutter Testing

Michael W. Kehoe

October 1995



(NASA-TM-4720) A HISTORICAL
OVERVIEW OF FLIGHT FLUTTER TESTING
(NASA, Dryden Flight Research
Center) 20 p

N96-14084

Unclas

H1/05 0075823

NASA Technical Memorandum 4720

A Historical Overview of Flight Flutter Testing

Michael W. Kehoe
Dryden Flight Research Center
Edwards, California



National Aeronautics and
Space Administration
Office of Management
Scientific and Technical
Information Program
1995

SUMMARY

This paper reviews the test techniques developed over the last several decades for flight flutter testing of aircraft. Structural excitation systems, instrumentation systems, digital data preprocessing, and parameter identification algorithms (for frequency and damping estimates from the response data) are described. Practical experiences and example test programs illustrate the combined, integrated effectiveness of the various approaches used. Finally, comments regarding the direction of future developments and needs are presented.

INTRODUCTION

Aeroelastic flutter involves the unfavorable interaction of aerodynamic, elastic, and inertia forces on structures to produce an unstable oscillation that often results in structural failure. High-speed aircraft are most susceptible to flutter although flutter has occurred at speeds of 55 mph on home-built aircraft. In fact, no speed regime is truly immune from flutter.

Aeroelasticity plays a significant role in the design of aircraft. The introduction of thinner wings, all-movable horizontal and vertical stabilizers, and T-tail configurations increases the likelihood of flutter occurring within the desired flight envelope. Today's aircraft designs undergo sophisticated aeroelastic analyses to ensure that the design is free of flutter within the flight envelope. These analytical results are often verified by wind-tunnel flutter models and ground vibration tests. Flight flutter testing provides the final verification of the analytical predictions throughout the flight envelope.

In the early years of aviation, no formal flutter testing of full-scale aircraft was carried out. The aircraft was simply flown to its maximum speed to demonstrate the aeroelastic stability of the vehicle. The first formal flutter test was carried out by Von Schlippe in 1935 in Germany (ref. 1). His approach was to vibrate the aircraft at resonant frequencies at progressively higher speeds and plot amplitude as a function of airspeed. A rise in amplitude would suggest reduced damping with flutter occurring at the asymptote of theoretically infinite amplitude as shown in figure 1. This idea was applied successfully to several German aircraft until a Junkers JU90 fluttered and crashed during flight tests in 1938.

Early test engineers were faced with inadequate instrumentation, excitation methods, and stability determination techniques. Since then, considerable improvements have been made in flight flutter test technique, instrumentation,

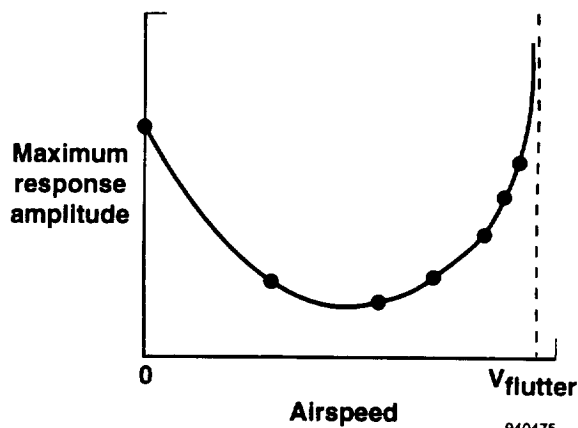

Figure 1. Von Schlippe's flight flutter test method.

and response data analysis. Flutter testing, however, is still a hazardous test for several reasons. First, one still must fly close to actual flutter speeds before imminent instabilities can be detected. Second, subcritical damping trends cannot be accurately extrapolated to predict stability at higher airspeeds. Third, the aeroelastic stability may change abruptly from a stable condition to one that is unstable with only a few knots' change in airspeed.

This paper presents a historical overview of the development of flight flutter testing, including a history of aircraft flutter incidents. The development of excitation systems, instrumentation systems, and stability determination methods is reviewed as it pertains to flight flutter testing.

FLUTTER HISTORY

The first recorded flutter incident was on a Handley Page O/400 twin engine biplane bomber in 1916. The flutter mechanism consisted of a coupling of the fuselage torsion mode with an antisymmetric elevator rotation mode. The elevators on this airplane were independently actuated. The solution to the problem was to interconnect the elevators with a torque tube (ref. 2).

Control surface flutter began to appear during World War I. Wing-aileron flutter was widely encountered during this time (ref. 3). Von Baumhauer and Koning suggested the use of a mass balance about the control surface hinge line as a means of avoiding this type of flutter. Although some mild instances of control surface flutter were encountered afterward, these were usually eliminated by increasing the mass balance of the control surface.

After World War I, higher airspeeds and a shift from external wire-braced biplanes to aircraft with cantilevered

wings resulted in more wing flutter incidents. Primary surface flutter began to appear around 1925 (ref. 4). Air racers experienced many incidents of flutter from the mid-1920's until the mid-1930's as attempts were made to break speed records. References 3, 4, and 5 give many examples of these incidents.

Another form of flutter dealt with in the 1930's was servo tab flutter. Collar (ref. 3) predicted that this type of flutter would be around for many years. This prediction was correct, for between 1947 and 1956, 11 cases of tab flutter incidences were reported for military aircraft alone (ref. 6). Even today servo tab flutter is still a problem. In 1986, the T-46A trainer experienced aileron flutter during a test flight that was being flown to find the proper amount of mass balance. These ailerons were free floating and driven by tabs at the trailing edge of the aileron (ref. 7).

New aeroelastic problems emerged as aircraft could fly at transonic speeds. In 1944, while flight testing the new P-80 airplane, NACA pilots reported an incident of aileron buzz (ref. 5). From 1947 to 1956, there were 21 incidences of flutter involving transonic control surface buzz. Prototypes of both the F-100 and F-14 fighters had incidences of rudder buzz. Today, the transonic flight regime is still considered the most critical from a flutter standpoint.

Chuck Yeager first achieved supersonic speeds in level flight in 1947. Supersonic flutter then began to be studied more seriously as these speeds became routinely flown. Supersonic speeds also produced a new type of flutter known as panel flutter. Panel flutter involves constant amplitude standing or traveling waves in aircraft skin coverings. This type of instability could lead to abrupt fatigue failure, so the avoidance of panel flutter is important. In the 1950's a fighter airplane was lost because of a failed hydraulic line that was attached to a panel that had experienced such panel flutter (ref. 5).

The carriage of external stores affects the aeroelastic stability of an aircraft. Seven incidents of flutter from 1947 to 1956 involved the carriage of external stores, as well as pylon-mounted engines (ref. 5). The stores carriage problem is still significant today, particularly with the many store configurations that an airplane can carry. Certain combinations of external stores carried by the F-16, F-18, and F-111 aircraft produce an aeroelastic instability known as a limit cycle oscillation (LCO) (refs. 8 and 9). Although these oscillations are mostly characterized by sinusoidal oscillations of limited amplitude, flight testing has shown that the amplitudes may either decrease or increase as a function of load factor (angle of attack) and airspeed.

Much has been learned about the prevention of flutter through proper aircraft design. Flight flutter incidences

still occur, however, on primary lifting surfaces as for the F-117 stealth fighter (ref. 10) and the E-6 Tacamo (ref. 11) aircraft, both of which experienced vertical fin flutter.

DEVELOPMENT OF FLIGHT FLUTTER TEST TECHNIQUES

Von Schlippe conducted the first formal flight flutter test in Germany in 1935. The objective of his test method was to lessen the risk associated with flutter testing. The usual practice at this time was to fly the airplane to the maximum speed and then to observe the stability of the structure.

Von Schlippe's technique consisted of exciting the structure using a rotating unbalance weight, measuring the response amplitude, and then recording the response amplitude as a function of airspeed. The forced response amplitude would rapidly increase as the aircraft approached its flutter speed. Therefore, the flutter speed could be estimated from data obtained at subcritical airspeeds.

The Germans successfully used this technique until 1938 when a Junkers JU90 aircraft fluttered in flight and crashed. Inadequate structural excitation equipment and unsatisfactory response measurement and recording equipment were identified as probable causes for this accident (ref. 4).

The United States attempted this technique in the 1940's with flutter tests of a Martin XPBM-1 flying boat and a Cessna AT-8 airplane (ref. 4). Figure 2, taken from reference 4, shows the response amplitude data as a function of airspeed. The graph shows that destructive flutter for this airplane was averted by the narrowest of margins during this flight test.

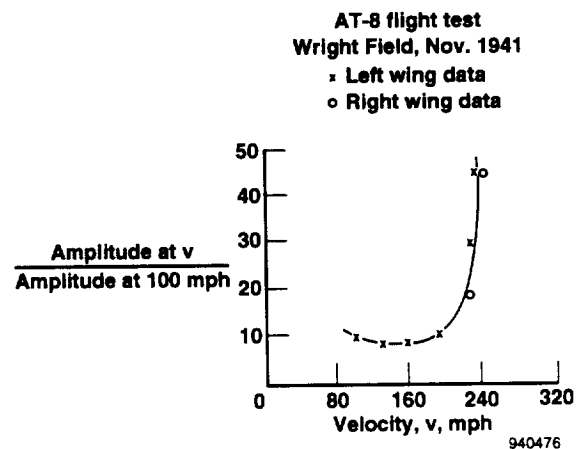

Figure 2. Response amplitude ratio as a function of airspeed (ref. 4).

In the late 1950's, excitation systems consisted of inertia shakers, manual control surface pulses, and thrusters (bonkers). Instrumentation had improved and response signals were then being telemetered to the ground for display and analysis. Some programs still displayed response signals on oscillographs in the airplane. Many experimenters realized the importance of adequate structural excitation for obtaining a high signal-to-noise ratio (ref. 12). The use of oscillating vanes to excite the structure was being considered during this time.

From the 1950's until the 1970's, many aircraft were equipped with excitation systems. Frequency sweeps were made to identify resonances. These sweeps were often followed by a frequency dwell-quick stop at each resonant frequency. In-flight analysis was usually limited to log decrement analysis of accelerometer decay traces on strip charts to determine damping.

The F-111 program is an example of this procedure. Figure 3 shows a schematic of the process, taken from

reference 13. Filtered and unfiltered accelerometer response data were displayed on strip charts and on X-Y frequency sweep plotters. Damping was manually determined from the frequency dwell-quick stop decay traces. Computers were not used for analysis of the data.

The P6M aircraft program took a departure from this methodology (ref. 14). This flight flutter program used random atmospheric turbulence to excite the structure and spectral analysis to analyze the response data for stability. The objective of this technique was to use every minute of flight time for dynamics data and to eliminate special test points for flutter.

Since the 1970's, digital computers have significantly affected flight flutter testing techniques. The computer has allowed for the rapid calculation of the fast Fourier transform (FFT). Computers have fostered the development of more sophisticated data processing algorithms that are useful for analysis of response data from either steady-state or transient excitation. Frequency and damping are

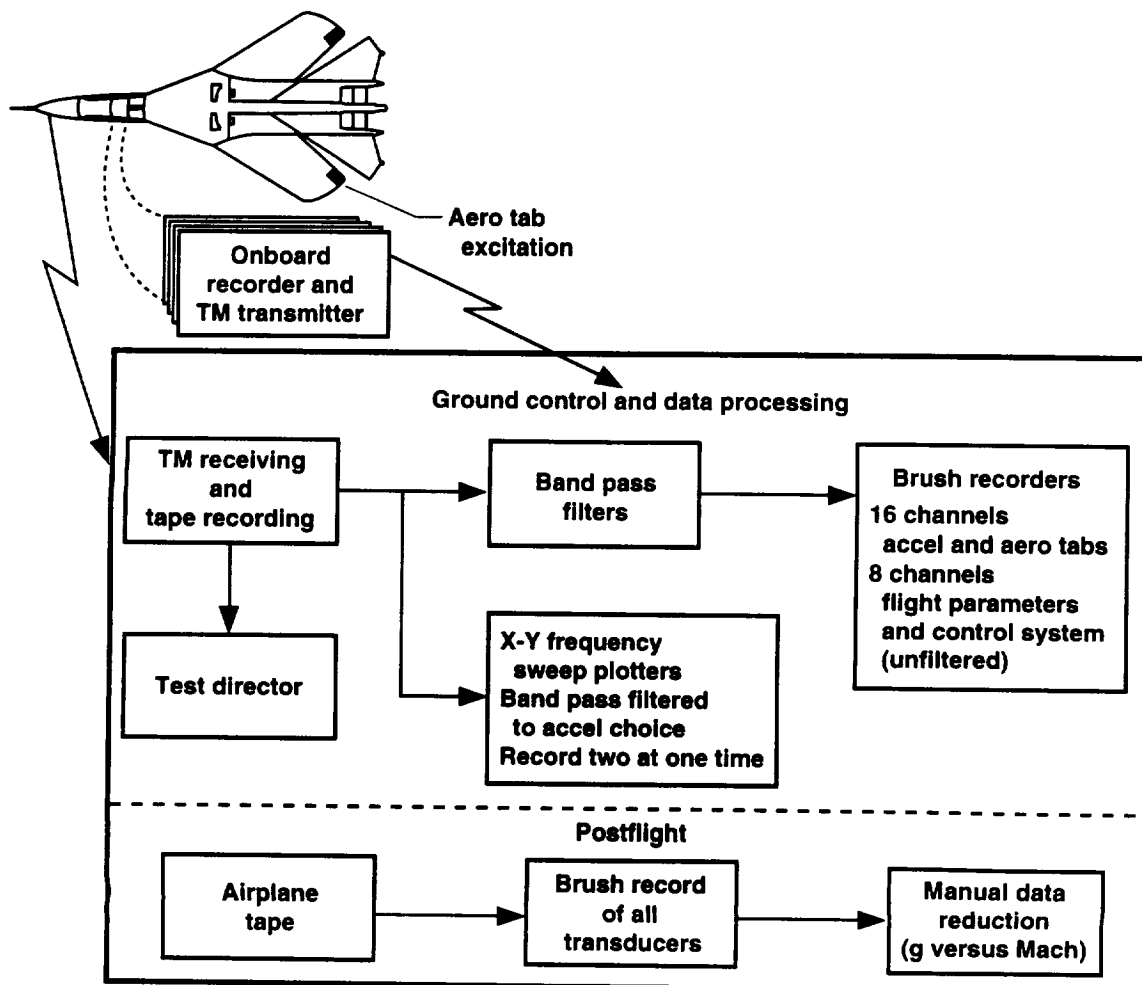

Figure 3. F-111 flight flutter test procedure (ref. 13).

now estimated with parameter identification techniques. Such analysis is done online in a near-real-time manner. Frequency and damping trends are established as a function of airspeed or Mach number. These trends are extrapolated to determine the stability at the next higher airspeed test point. As computer speeds have increased, the time required to conduct flight flutter testing per test point has decreased. The ability to analyze more data at each test point and the increased number of flight test points resulting from more sophisticated aircraft designs, however, have increased the total time to clear the flight flutter envelope.

The test technique typically used is to monitor the telemetered response signals with real-time frequency analyzers and strip charts. These data are also acquired by digital computers that process the data using parameter identification techniques for estimating frequency and damping (ref. 15). Figure 4 shows this process. In this figure, data are telemetered from the airplane and simultaneously displayed on strip charts, and real-time frequency analyzers.

A computer acquires the data for analysis to determine frequency and damping estimates. The test director, who communicates with the test aircraft, has access to all of this information to make decisions on continuing the flutter envelope expansion.

Although flight flutter test techniques have advanced, today's techniques are still based upon the same three components as Von Schlippe's method: structural excitation, response measurement, and data analysis for stability. Technology development associated with each component will be reviewed and a discussion of the impact on the safety of flight flutter testing will follow.

EXCITATION SYSTEMS

Structural excitation is a necessary part of the flight flutter testing methodology. Detection of impending aeroelastic instabilities cannot be made without adequate excitation. Adequate excitation provides energy to excite

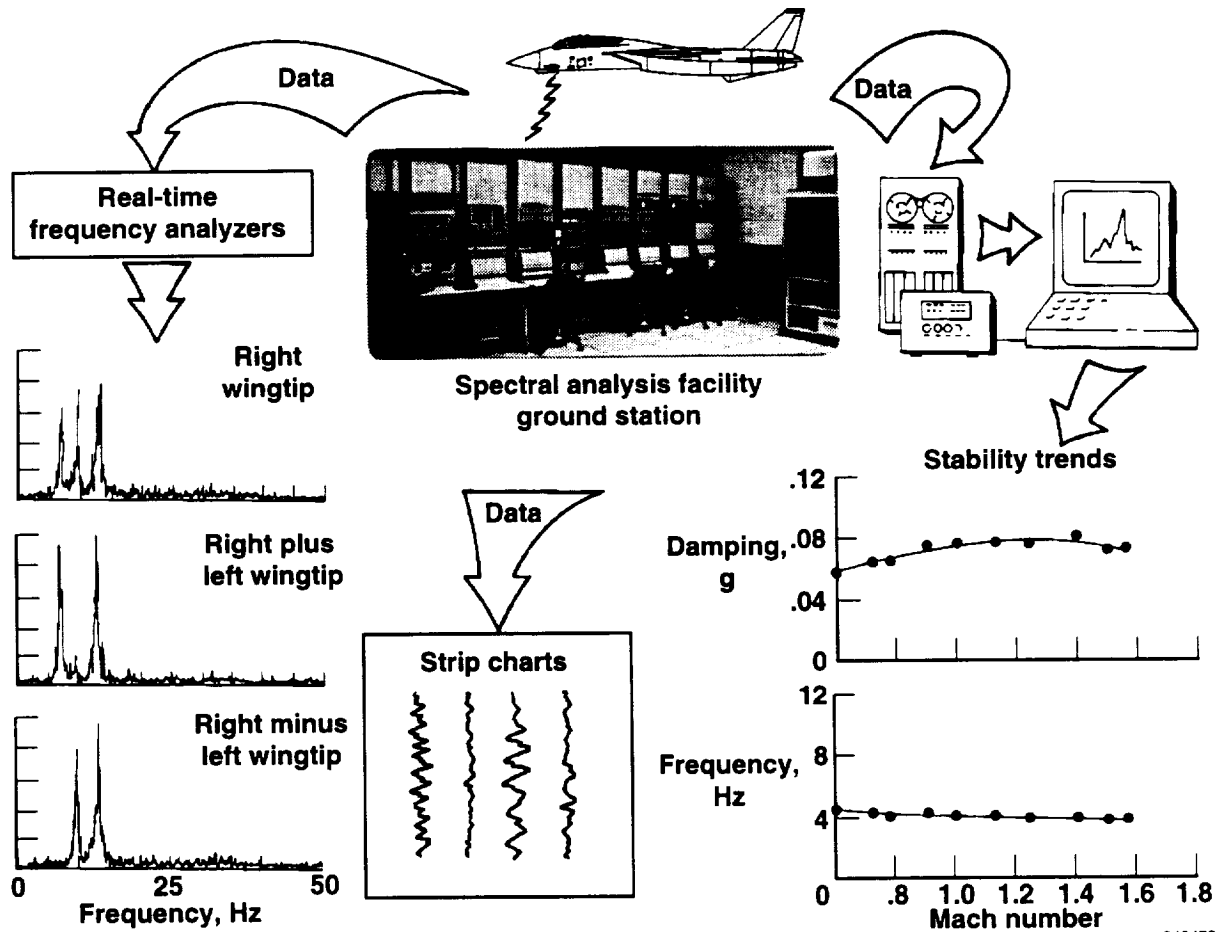

Figure 4. Typical modern flight flutter test process.

all of the selected vibration modes with sufficient magnitudes to accurately assess stability from the response data.

The Transavia PL12/T-400 airplane (ref. 16) clearly demonstrated the importance of adequate excitation levels in 1986. This airplane was excited on the initial flight tests by control surface pulses and random atmospheric turbulence. Flutter did not occur during the flight test. In a subsequent flight, the airplane experienced violent oscillations of the rudder and tail boom when it was flown in rough weather conditions. These weather conditions provided higher levels of excitation than the levels induced during the flight flutter test.

In the 1930's, the Germans decided that improper exciter location resulted in poor responses that prevented the determination of the onset of flutter and sometimes resulted in flutter occurring unexpectedly (ref. 4). In the 1950's, the United States learned that low excitation levels tend to give a large scatter in the damping values estimated from the response data. In addition, the estimated values suggested lower aerodynamic damping than actually existed. During flutter testing of the B-58 airplane (ref. 17), it was found that a structural excitation level at least three to four times higher than was obtained by random atmospheric turbulence was necessary to provide an acceptable level of excitation.

The excitation system must not only provide adequate force levels but must also (1) provide adequate excitation over the desired frequency range of interest, (2) be lightweight so as not to affect the modal characteristics of the airplane, and (3) have power requirements (electric or hydraulic) that the airplane can meet. It is difficult for any one system to meet these requirements simultaneously. Over the years, many types of excitation have been tried with varying degrees of success. Some more common means include control surface pulses, oscillating control surfaces, thrusters, inertial exciters, aerodynamic vanes, and random atmospheric turbulence.

Control Surface Pulses

Manual control surface pulses were the first means of excitation. This provided sudden control surface movements. Depending on the type of control system, modes up to about 10 Hz can be excited this way. Such pulses approximate a delta function that theoretically has a high frequency content. Two benefits of this type of excitation are that no special excitation equipment is required and that the transient response signature of the structure is easy to analyze for stability. Test duration for each pulse is short, so many can be applied at each test point.

There are several drawbacks, however. First, it is difficult to get repeatable pulses, and thus the degree of excitation is inconsistent. Second, either the pilot cannot provide a sharp enough input or the control system is unable to provide a sharp enough disturbance to excite any critical flutter modes above 10 Hz. Third, such pulses often do not provide an adequate level of excitation to determine the onset of flutter. The fact that flight was possible beyond the flutter speed without exciting flutter with pulses was demonstrated during a flight flutter test in the 1950's (ref. 18). The purpose of this particular flight was to investigate the stability of a vertical stabilizer. The structure was excited using rudder pulses and by thrusters (impulse generator). The thrusters excited flutter at a speed 5 knots below that where the structure was previously excited by rudder pulses without incident.

In spite of their limitations, control surface pulses have continued in use to excite the structures of many airplanes since 1950. The F-101 (mid-1950's), the early testing of the F-4 aircraft (late 1950's), the A-7A (1965), some of the early Boeing 747 flutter testing (1969), and low-speed testing of the DC-10 airplane (1970) all used control surface pulses for structural excitation.

Flight control surface pulses are still used today as excitation for flight testing. Most modern fly-by-wire flight control systems (analog and digital), however, have low-pass filters in the stick input path that filter out high-frequency signal content. For example, the F-16XL airplane flight control system has a 1.6-Hz low-pass filter (single pole) in the stick input path that would washout any sharp stick motion commands to the control surface actuators. Manual control surface pulses are still used today on most small aircraft and sailplanes because this is usually the only affordable type of excitation for these aircraft.

Oscillating Control Surfaces

Commanded oscillations of the control surfaces were also used in the 1950's. The XF3H-1 airplane used an oscillating rudder for excitation to investigate a rudder buzz instability (ref. 19). The rudder was oscillated by supplying a variable frequency command signal into the rudder servo of the autopilot system. This system could excite over a frequency range of 5 to 35 Hz and with the frequency stepped every 3 sec by an automatic rotary switch located in the cockpit.

In the mid-1960's, electronic function generators were developed to provide signals to control surface servos in the autopilot system. These function generators provided signals to oscillate the horizontal stabilator and the ailerons of the F-4 airplane (ref. 19). The stabilator could

sweep from 8 to 30 Hz and the ailerons from 2 to 16 Hz. The actuators for each surface were modified to provide the required gain and frequency response. A cockpit controller provided the capability to adjust the excitation amplitude, mode selection (sweep or dwell), start and stop sweep frequency, and dwell frequency. Further advances in electronics during the 1970's and 1980's resulted in the ability to send excitation signals to the control surface actuators that were not sinusoidal. The F-18 aircraft excitation system can generate sinusoidal and bandpass-filtered pseudo-random commands to the flight control surfaces (ref. 19).

This method of excitation has been successfully used for the X-31 and YF-22 airplanes and for the stores clearance work on the F-16, F-15, and F-18 airplanes. The X-31 airplane could sweep frequencies from 0.1 to 100 Hz. Although significant actuator roll-off occurred above 20 Hz, the combination of aerodynamic force at low frequencies and control surface inertia forces at higher frequencies provided adequate excitation for this airplane (ref. 20).

The primary advantage of this type of system is that no additional hardware is required except for an excitation control box located in the cockpit. As a result, the flutter speed of the airplane is not affected as it might be with other types of excitation systems.

A disadvantage of this type of system is the frequency response limitations of the control surface actuators. Often, special actuators are required to excite critical high-frequency modes, as was the case for the F-4 flutter testing (ref. 19).

Thrusters

Thrusters, sometimes known as bonkers, ballistic exciters or impulse generators, are an early device circa (1940) used for structural excitation. These small, single-shot, solid-propellant rockets have burn times of 18–26 msec and maximum thrust levels of 400–4,000 lbs (ref. 21).

Thrusters are simple, lightweight devices that generally do not affect the modal characteristics of the airplane. These devices produce transient responses of short duration, which is important when the airplane has to dive to attain a test condition.

The disadvantages for these devices include single-shot operation, difficulty in firing two or more either in phase or out of phase with respect to each other, and their inability to provide a wide frequency band of excitation. Usually required are thrusters with three different burn times to excite modes in a frequency range that covers 5 to 50 Hz.

Thrusters were used for part of the flutter clearance of the F-101 airplane in the mid 1950's. Six thrusters were mounted on each wingtip, three on top and three on the bottom. Use of these devices was partially successful for this program (ref. 18).

Thrusters were also used by Douglas Aircraft Company in the 1950's (ref. 19) on several airplanes to investigate flutter characteristics. Thrusters were also used for portions of the F-4 flutter testing in the early 1960's. Since then, thrusters have not been used in the United States for any major flight flutter test program.

Inertial Exciters

A large variety of rotating eccentric weight and oscillating weight inertia exciters have also been tried. The rotating unbalance exciter was widely used for flight flutter testing in the 1940's and 1950's. These systems derive their forces from mass reactions. The inertia force is proportional to the exciter weight multiplied by the square of the rotating speed. As a result, the excitation capability may be limited at lower frequencies and excessive at higher frequencies.

The Martin XPBM-1 flying boat flight flutter test program used such a system. The precise control of frequency was difficult with the equipment available; thus the exciter would not stay tuned on the resonant frequency. One method of tuning the exciter frequency, as done by a Convair F-92 pilot in 1950, was by observing a meter in the cockpit that measured the response of selected vibration pickups during flutter tests (ref. 4).

The magnitude of the forces required to adequately excite an airplane is usually very large. As a result, the hardware required to produce the unbalance forces often could not be contained within the wing contour. In addition, these systems often are very heavy and raise concerns about the effect on the modal characteristics of the airplane that they are installed on. For example, the rotating unbalance equipment designed for (but never installed on) the XB-36 had a maximum force output of 1000 lb, and installation in each wing weighed between 400 and 500 lb (ref. 12).

Inertia shakers were used for the B-58 flutter testing in the early 1950's. These shakers were hydraulically powered and electrically controlled and were used to excite a frequency range of 5 to 40 Hz. The overall dimensions were 4.5 by 4.5 by 8.5 in., and each unit weighed 25 lb. The force output was 40 lb at 7.5 Hz and 150 lb at 40 Hz; the force level increased linearly between these two frequency values (ref. 17). This type of shaker worked well, particularly in exciting the higher frequency modes of the airplane.

The Convair F-102A, which was flutter tested in the late 1950's, also used inertial shakers. In the frequency range between 5 and 50 Hz, the force varied from approximately 20 to 300 lb. This shaker was sufficiently compact to be installed inside the wing- tip, which has a depth of 4.5 in. The weight of the shaker was 8.5 lb (ref. 22).

After the 1950's, inertia exciters were not used extensively. However, there has been limited use of such systems to provide partial structural excitation for the F-14 horizontal stabilizer, the F-111 horizontal and vertical stabilizer, and the X-29 flaperon. The B-1A airplane also used an inertia shaker system (fig. 5) for flight flutter testing. The system consisted of five hydraulically driven, electronically controlled, oscillating mass exciters. One exciter was placed at each wingtip, one at each horizontal stabilizer tip, and one at the tip of the vertical stabilizer. Each wingtip and horizontal stabilizer tip could be operated in and out of phase with respect to each other. This system was capable of producing a maximum force of about 550 lb of force with an exciter weighing approximately 40 lb (ref. 23). This system adequately excited the modes of interest and was essential for safely expanding the flight envelope.

Aerodynamic Vanes

An aerodynamic vane consists of a small airfoil that is usually mounted to the tip of a wing or stabilizer. The vane is generally mounted on a shaft, driven either electrically or hydraulically, and oscillates about some mean angle. Oscillation of the vane will result in a varying aerodynamic force acting on the airplane. The amount of force depends on the size of the vane, dynamic pressure, and angle of rotation.

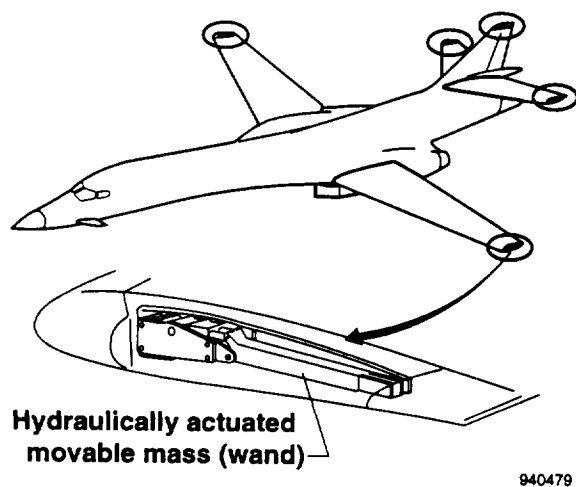

Figure 5. Inertial excitation system (ref. 23).

Aerodynamic vanes were first used in the 1950's. The YB-52 airplane used a wingtip oscillating airfoil shaker for flight flutter testing (ref. 24). This wingtip unit weighed 150 lb and was mounted on the right wingtip only. A similar amount of weight was installed on the opposite wingtip. Typical sweep times were approximately 7 min. The excitation frequency could be varied from 1.4 to 10 Hz.

Since then, many flight flutter test programs have used the aerodynamic vane as a means of excitation. These programs include the DC-10, L-1011, Boeing 747, Boeing 757, S-3A, F-14, F-111, A-10, C-17, and T-46A. Tables 1 and 2 which were taken from reference 13, show the characteristics of some of these excitation systems.

The advantage of this type of system is that it can excite low frequencies well; the amplitude at high frequencies is limited only by the response characteristics of the vane drive mechanism. The excitation frequency and amplitude at a given airspeed can be controlled, and the force time history produced is repeatable.

The main disadvantage is that the maximum force produced varies with the square of the equivalent airspeed. Other disadvantages include the addition of mass, the disturbance of the normal airflow around the wingtip or stabilizer tip with the vane present, and the large power requirements usually needed to operate this system.

There are two notable variations of the oscillating aerodynamic vane concept: a rotating vane and a fixed vane with a rotating slotted cylinder attached to the vane trailing edge.

The C-5A airplane excitation system consisted of a rotating vane mounted on top of the wing at each tip and on top of each horizontal stabilizer at each tip (ref. 13). The vanes were continuously rotated through 360 degrees, and both sets of vanes were synchronized to provide either symmetric or antisymmetric excitation. This system produced periodic excitation to the structure and was successfully used for flight flutter testing.

The fixed vane with a slotted rotating cylinder attached to the trailing edge (fig. 6) was developed by W. Reed (ref. 25). The vane/cylinder assembly weighs approximately 10 lb. The device generates periodic lifting forces by alternately deflecting the airflow upward and downward through the slot. This system was used for the flutter clearance of a F-16XL airplane with a modified laminar flow glove (ref. 26). Frequency sweeps were conducted from 5 to 35 Hz for this program. The system uses exceptionally little electric power and is easy to install.

Table 1. Summary of aerodynamic excitation systems used in U.S.

Airplane	Surface	Location	Frequency range	Time to sweep, sec	Sweep law
747	Wings	External vanes at wingtips	1.5–7.0 Hz	90	Exponential
DC-10	Wings horizontal Vertical tail	External vanes at tips of main surfaces	1–20 Hz and 1–10 Hz	90 90	Exponential
L-1011	Wing stabilizer	External vanes	1–18 Hz 3–25 Hz	90 30	Linear period
S-3A	Side of fuselage under stabilizer	External vanes	1.5–18 Hz 3–25 Hz	90	Linear period
C-5A	Wing stabilizer	External vanes on top of surfaces near tips	.5–25 Hz	60 normal 30 dive only	Exponential
F-14	Wing fin	Aero-tab External vane	5–50 Hz	15	Exponential
F-15	Normal control Ailerons Stabilator		2–16 Hz 5–10 Hz	100–200 45	Linear frequency
F-111	Wing	Aero-tab	35–2 Hz	45	Exponential

Table 2. Summary of inertial excitation systems used in U.S.

Airplane	Surface	Location	Frequency Range	Time to sweep, sec	Sweep law
F-14	Horizontal tail	Right side stabilizer only	5–50 Hz	15	Exponential
F-111	Horizontal, vertical tail surfaces	Inboard on stabilizer near side of fuselage, top of fin	35–2 Hz	45	Exponential

Random Atmospheric Turbulence

Atmospheric turbulence has been used for structural excitation in many flight flutter test programs (ref. 15). The greatest attraction to this type of excitation is that no special onboard exciter hardware is required. Turbulence excites all of the surfaces simultaneously, which causes both symmetric and antisymmetric modes to be excited at the same time. This method eliminates the need to perform symmetric or antisymmetric sweeps.

Natural turbulence is the random variation in wind speed and direction. Turbulence is generally produced by

weather-front winds and thermal activities; the extent of turbulence within an air mass can vary widely. Reference 27 provides an excellent description of turbulence and its use for excitation in flight flutter testing.

This approach was tried in the late 1950's. The P6M *Seamaster* flight flutter program (ref. 14) used random atmospheric turbulence to excite the structure and spectral analysis to analyze the response data for stability. Objectives of this technique were to use every minute of flight time for dynamics data and to eliminate special test flights for flutter. The YF-16 also used random atmospheric

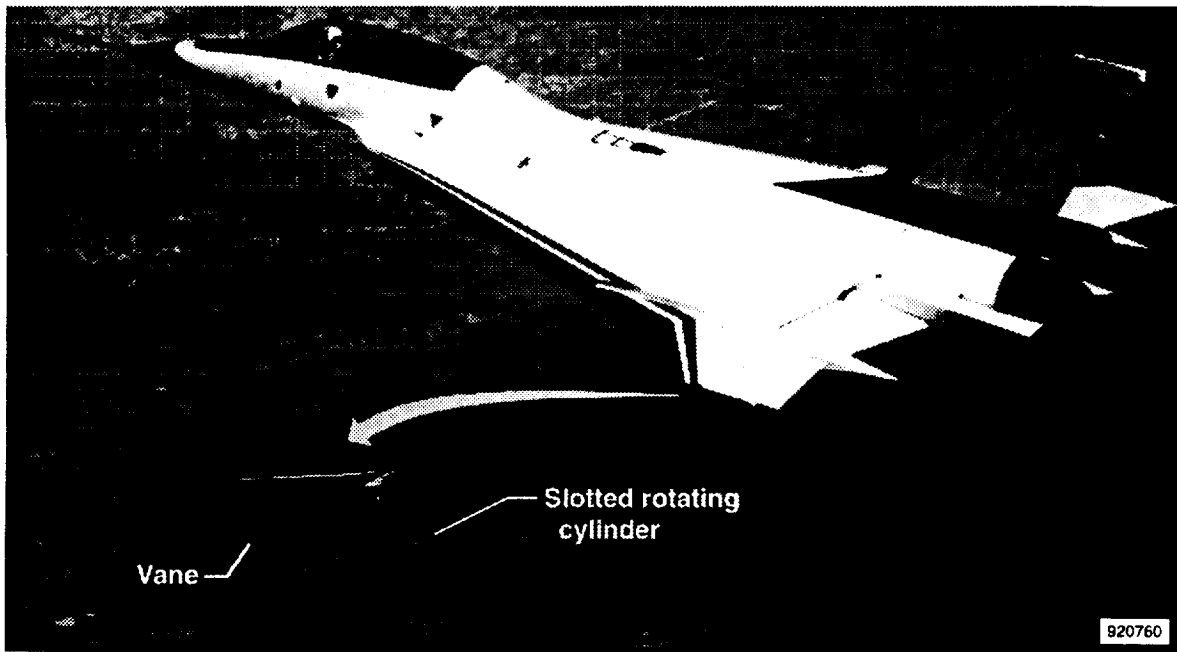

Figure 6. F-16XL with vane and rotating slotted cylinder excitation system (ref. 26).

turbulence along with the random decrement technique for data analysis to clear the flutter envelope of the basic airplane (ref. 28).

Although this method has been used with some success over the years, there are several disadvantages. The turbulence that is found is often not intense enough to produce sufficient excitation compared with that obtained with onboard exciters. Turbulence usually excites only the lower frequency modes for most airplanes. Long data records are required to obtain results with a sufficiently high statistical confidence level. The signal-to-noise ratio of the response data is often low, which makes data analysis very difficult. Flight time is lost looking for sufficient turbulence, and turbulence often interferes with other engineering disciplines data.

Figure 7 compares the power spectrum plots obtained from the F-16XL airplane excited by random atmospheric turbulence and by a vane with a slotted rotating cylinder attached to the trailing edge. The turbulence was reported to be light-to-moderate for this flight condition. All of the structural modes were excited by the vane, while only the 8-Hz mode was well excited by turbulence. This data comparison clearly indicates the poor data quality that is typically obtained with random atmospheric turbulence.

This flight test program also illustrates the lessons learned during the B-58 flutter test program. Inadequate

excitation levels usually give a large scatter of the estimated damping values, and the estimated damping values often indicate lower damping than actually exists. A comparison of response data damping values from random atmospheric turbulence and vane excitation (fig. 8) shows that the turbulence response data, which have a lower excitation level, consistently have lower estimated damping values.

Although the flutter envelopes of many modern aircraft (i.e., X-29A, advanced fighter technology integration (AFTI) F-111 mission adaptive wing, AFTI F-16, Schweizer SA 2-37A motor glider, and F-15 short takeoff and landing/maneuver technology demonstrator) have been cleared using atmospheric turbulence, caution should be used when using this form of excitation to ensure that the critical flutter mode has been excited throughout the flight envelope.

INSTRUMENTATION

The instrumentation used to record the structural responses of an airplane to excitation is another critical component of flight flutter testing methodology. The response data must be measured at enough locations and be of high enough quality that the flight can be conducted safely. Included in the instrumentation system is the measurement, telemetry, recording, and displaying of the flight data.

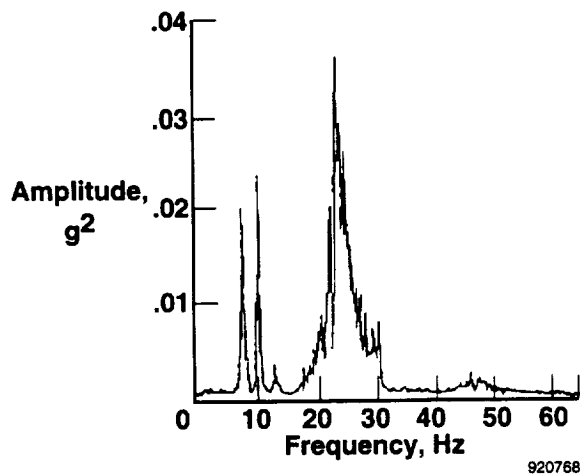

(a) Exciter sweep.

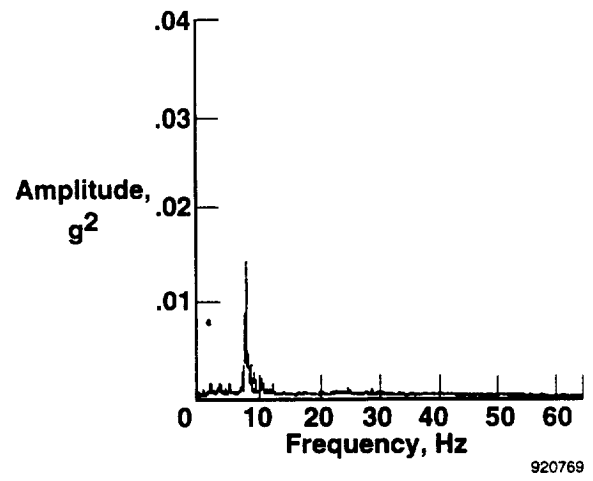

(b) Random turbulence.

Figure 7. Comparison of excitation of the left-wing aft accelerometer at Mach 0.9 and 30,000 ft (ref. 26).

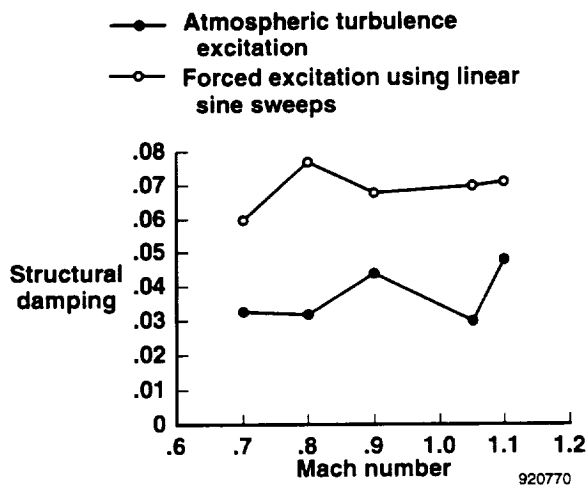

(a) Symmetric.

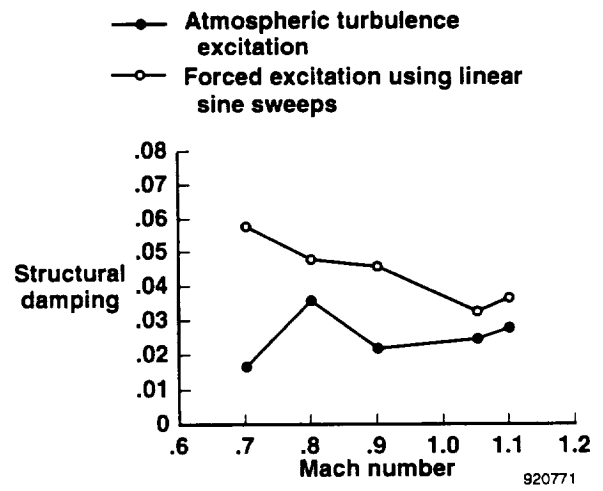

(b) Antisymmetric.

Figure 8. Structural damping values for wing bending modes (ref. 26).

Measurement

The most commonly used transducers to measure the excited response of a structure have been the accelerometer and strain-gage bridge. The selection of the device to use often depends on the ease with which installation can be accomplished, although today the more commonly used device is the accelerometer.

Accelerometers used in the early 1940's were large and heavy. As an example, the accelerometers were about 3 in. high, 2 in. wide, and weighed about 1 lb. Subminiature accelerometers were developed later and these were lighter but still were large (1/2-in. high, and 1-in. wide).

The calibration of these devices drifted during operation mainly because of the electronics in use then.

The accelerometers used for the B-58 flutter testing in the 1950's were of the strain-gage type. These were fluid damped devices. To minimize the effects of the outside air temperature on the damping, these units had built-in electric heaters to maintain a constant temperature of 165° F (ref. 17).

Piezoelectric accelerometers have been developed such that miniature units today weigh less than one-tenth of an ounce, operate in a temperature range of -65 to 200° F, have high sensitivity, have a linear frequency range of 1 to 10,000 Hz, and have amplitude linearity from 1 to 500 g.

Typically the dimensions are as small as 0.25 in. wide and 0.15 in. high. Today's accelerometers accurately measure the structural response in almost any kind of environment.

Subminiature instrumentation has also been developed as self-contained peel and stick devices (ref. 29). Each unit contains a battery, sensor, antenna, processor, and transmitter. These devices do not require any wiring and the signals may be transmitted either to a receiver located on board the airplane or directly to a receiver located on the ground within a small flight radius of the transmitter. Advances such as this will significantly reduce the cost associated with flutter testing.

Telemetry and Recording

Recording equipment was not adequate during the 1930's and was cited as a possible reason that the Germans lost several airplanes during flutter testing (ref. 4) in that decade. In the 1930's, a Junker JU86 airplane underwent flight flutter testing to identify the effects of balance weights on rudder stability. The recording system used was a thin wire attached to the rudder, which mechanically actuated a recorder installed in the observer's seat of the airplane (ref. 4).

During the 1940's, the accelerometer responses were recorded on photographic oscillographs mounted in the cockpit or airplane cabin. These devices required a developing time for the paper; the time history responses could not be viewed immediately as a result.

In the 1950's, data were commonly FM/FM telemetered to the ground, recorded on magnetic tape, and then displayed on strip chart recorders. The telemetry systems during this period were small and typically only 8 to 12 channels of data could be telemetered to the ground (refs. 30, 31, and 32). As a result, on-board tape recorders captured all of the flight data while the recorders on the ground captured only the data that could be sent down from the airplane. The ground tapes were typically noisier than the onboard tapes mainly because of data-transmission problems.

Pulse code modulation (PCM) or digital telemetry was initiated in the 1960's, although FM/FM telemetry was still widely used for flutter testing because of the frequency bandwidth required. The PCM telemetry significantly increases the number of parameters that can be transmitted to the ground but requires a filter to prevent frequency aliasing of the analog response signal during digital sampling on board the airplane.

The frequency bandwidth of PCM systems had increased significantly by the 1980's. A frequency

bandwidth of 200 Hz is easily attainable and sufficient for most flutter applications. As a result, PCM telemetry is now usually preferred for most flight flutter testing.

Today the available portable digital recorders are compact and can acquire data from flight instrumentation for storage within the unit's computer memory. Direct storage of the data eliminates the need for expensive equipment associated with PCM systems. Although these units can acquire a limited amount of data, they have been used for low-cost flutter testing (for example, the Pond Racer airplane). The data from the unit's computer memory are downloaded after each flight into a digital computer for analysis.

Displays

Computers were used to manipulate and display data to some extent during the 1950's. Analog computers were sometimes used to add, subtract, multiply, integrate, and filter the data signals telemetered (ref. 30) and then to display these signals on strip charts for the flutter engineer.

Sometimes the pilot had a small cathode ray tube oscilloscope in the cockpit to display the decay trace of a single, selected accelerometer (ref. 33). The pilot was briefed before each flight by the flutter engineer on the anticipated response amplitudes and safe operating limits.

In the 1950's, data were primarily displayed on strip charts in the control room for analysis by the flutter engineer. Strip chart capabilities have greatly increased, and today strip charts continue to be the primary device to display real-time accelerometer and strain-gage response time histories.

In the 1970's, computer technology had advanced to the point that it became feasible to use a computer to perform online stability analysis of the flight flutter test data. Computers were also used to provide discretized and alphanumeric data in the control room. Many basic airplane parameters, such as Mach number, airspeed, angles of attack and sideslip, and fuel quantities, could now be displayed on cathode-ray tubes. This display provided the flutter engineer with the ability to more closely monitor the flight test conditions of the airplane.

In the 1980's, it became possible to provide the pilot a real-time guidance system for maintaining flight conditions. With this system the pilot flies the airplane to minimize the computed differences between the desired and actual flight condition (Mach number and altitude). The computed differences are telemetered to the airplane from a ground-based computer. The pilot then uses a cockpit display as an aid to reach and hold desired test conditions;

this has resulted in exceptionally accurate stabilized flight test conditions (ref. 34).

Figure 9 shows how aircraft instrumentation, data recording, and real-time support in the ground station have changed since the 1940's. In summary, removing the flutter engineer from the airplane during the test, having increasingly reliable and accurate instrumentation, and having ground stations with highly specialized test capabilities has significantly reduced the hazard of flight flutter testing.

DATA REDUCTION METHODS

The next component of flight flutter testing methodology is the analysis of the response signal. The response signal can consist of random response caused by atmospheric turbulence or exciter input, transient responses caused by either impulse input or exciter frequency dwell-quick stops, or steady-state responses caused by exciter frequency sweeps. The accurate and timely evaluation of

this data to determine stability is critical to the overall safety of the flight flutter test program.

In the 1930's and 1940's, the methods used consisted of measuring the response amplitude caused by a frequency sweep or determining the damping from a response caused by a control surface pulse. These data were recorded on an oscillograph recorder. All of this analysis was usually done by hand between flights, because no computers with sophisticated identification algorithms were available. The damping estimation consisted of using the log decrement method on the decay portion of a time history response. Occasionally, in lieu of telemetry, the flutter engineer was on board the airplane to do these analyses (ref. 4).

As telemetry became more available in the 1950's, the data analysis methods just described were still used, but the analysis was generally conducted on the ground. It became more common to excite the airplane at stabilized test points, analyze the response for stability, and then clear the airplane to the next higher airspeed (refs. 17, 22, and 24).

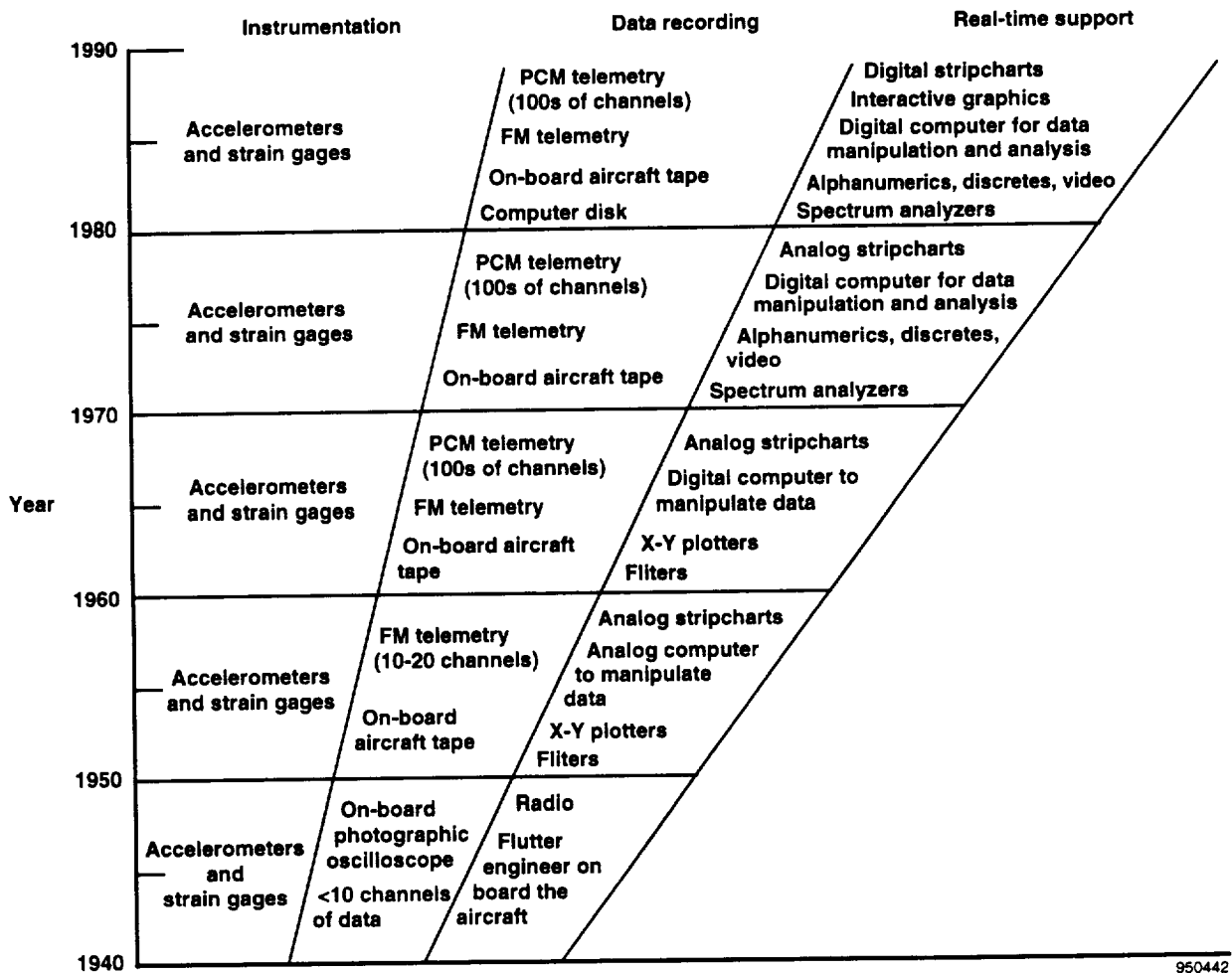

Figure 9. Evolution of instrumentation, data recording and real-time support requirements.

Data transmission problems usually added noise to the telemetered data. Filtering of the response data was common to reduce the scatter in the damping estimates. Data were often passed through a filter to reduce the data to a single-degree-of-freedom response. Closely spaced modes, however, proved to be difficult to separate for damping estimation using these analysis techniques.

Another method for enhancing the data analysis was to add and subtract time history signals. The symmetric and antisymmetric modes could then be separated, reducing the modal density of the response signal (ref. 32).

In the 1950's, vector plotting (ref. 31) and spectral analysis (ref. 14) were also used to determine stability. Modal damping was not estimated from the spectral analysis technique. This analysis only provided the frequencies and amplitudes of the response signal being analyzed.

These manual or analog analysis techniques continued to be used until the 1970's. Using tracking filters during an exciter frequency sweep improved the data quality obtained. Such a technique was used in the 1960's (ref. 19) to filter data provided to an analyzer to produce a real-time plot of frequency and amplitude. Even so, no phase or damping information was available from this approach.

By 1970, digital computer systems could be used for interactive analysis of flight data. During the early 1970's, the fast Fourier transform was implemented on the computer, providing the capability to obtain frequency content of acquired signals in less than a second. The speed of computers then allowed parameter identification algorithms to be programmed for estimation of damping from the response signals.

The F-14 and F-15 aircraft programs were among the first to take advantage of this advance in technology. For the F-14, an equation error identification technique was used to estimate frequency and damping information (ref. 37). The F-15 program used an analysis technique to predict the flutter boundary based on frequency and damping data acquired at subcritical speeds (ref. 38). Other programs, that used the random decrement technique, such as the YF-16 (ref. 28), also took advantage of the increased capabilities of the digital computer to increase the efficiency and safety of flight flutter testing.

Since the 1970's, many identification algorithms have been developed to estimate frequency and damping from flight flutter data. References 39 and 40 are excellent reports on modal parameter estimation and provide numerous references for the many different approaches taken.

CONCLUDING REMARKS

Current State-of-the-Art

Today, the typical approach to flight flutter testing is to fly the aircraft at several stabilized test points arranged in increasing order of dynamic pressure and Mach number. Data are analyzed at these points only. The number of stabilized test points required to clear the flutter envelope of an airplane is typically high and consequently requires many flights to accomplish them. For example, the F-14 required 489 shaker sweeps to clear the basic airplane flight envelope; 177 shaker sweeps were required for the Gulfstream III; and 264 shaker sweeps were required for the Gulfstream II ER airplane (ref. 37). The F-15 required 132 shaker sweeps and 156 frequency dwells to clear the basic airplane flight envelope (ref. 41).

The data obtained at each stabilized test point establish a damping trend as a function of airspeed. Information is then extrapolated to predict the stability of the next planned test point. This practice is questionable because actual damping trends can be nonlinear. The most critical part of expanding the flutter envelope is the acceleration from one test point to the next. During this phase, response data are not being quantitatively analyzed. Instead, engineers, relying on intuition and experience, are limited to real-time monitoring of sensor responses on strip charts.

An examination of several flight flutter test programs shows the effectiveness of the techniques used today to warn of the onset of flutter. Figure 10 shows the frequency and damping trend information obtained, in near-real-time, during the flutter testing of the KC-135 airplane

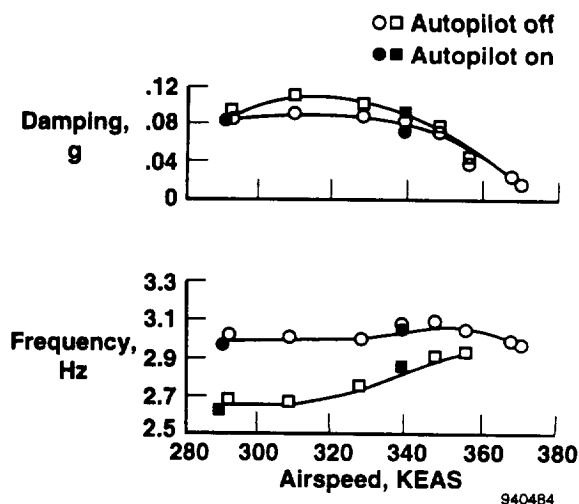

Figure 10. Frequency and damping trends established from flight data.

configured with winglets (ref. 42). The aircraft structure was excited by pilot-induced control surface pulses and damping was estimated using an FFT algorithm (ref. 15). The subcritical damping trend for a 2.6-Hz and 3.0-Hz mode indicated that as airspeed was increased, these two modes coupled and caused a decrease in the damping level. The damping level decreased with increasing airspeed until it was no longer safe to continue the test. In this instance, the techniques used provided a sufficient and adequate warning of the onset of flutter mainly because the decrease in damping was gradual.

Figure 11 shows the damping trend obtained in near-real time for an F-16 airplane configured with AIM-9J missiles, GBU-8 stores, and 370-gal external fuel tanks (ref. 15). Flight of the airplane with this store configuration is characterized by an LCO. Decay traces were obtained by using the flaperons to excite the structure with frequency dwells—quick stops. The damping was estimated using FFT algorithms. This set of data provided a unique opportunity to validate the accuracy of this algorithm because this configuration could be safely flown to a condition of zero damping. A linear extrapolation of the data trend provided an instability airspeed prediction that agreed closely with the actual instability onset airspeed encountered.

Although today's techniques appear adequate to warn of the on-set of flutter for gradual decreases in damping, it is doubtful that sudden changes in damping, which may occur between flutter test points, can be predicted with the accuracy and timeliness required to avoid flutter.

Future of Flight Flutter Testing

The future of flight flutter testing has been defined at several times. The flutter testing symposia held in 1958 and 1975 identified future directions and needs (refs. 43

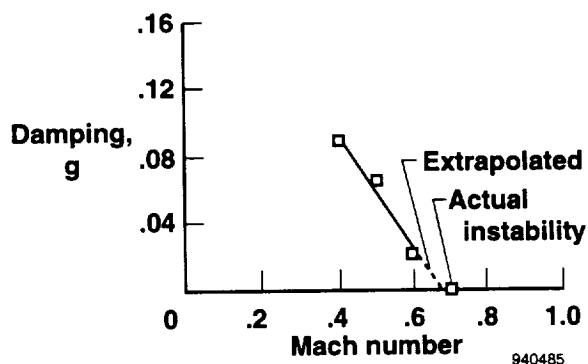

Figure 11. Damping trend for a limited amplitude instability.

and 44). These symposia proceedings will be reviewed to confirm the progress made toward those needs. Our future needs will then be presented.

1958 Flight Flutter Test Symposium

The final sentence in reference 4, which was presented at the 1958 flight flutter test symposium, was, "It is hoped that improvements in test techniques will eventually result in flight flutter tests that will give all the information wanted and will be considerably less hazardous than they are today." Reference 17 stated that improvements needed were to shorten the time required to obtain data and to provide complete and higher quality data. The way to fulfill this need was to automate the data-reduction equipment. Reference 22 stated the need for completely automatic excitation, data-recording and data-reduction systems.

1975 Flutter Testing Techniques Symposium

The 1975 symposium contained several papers describing the application of techniques that used computers to estimate frequency and damping from flight flutter test data. Two future needs identified from the papers presented at the symposium were (1) to further develop parameter estimation algorithms that would provide better estimates from noisy data and closely spaced modes (ref. 28), and (2) to develop effective noise reduction and transfer function enhancement (ref. 45). The high-speed computer was identified as the tool for developing advanced data analysis methods that would more fully satisfy the desired objectives of flight flutter testing (ref. 46). Most agreed that the current (i.e., 1975) techniques were faster and, more accurate, increased safety, and reduced flight test time when compared with previous methods of flight flutter testing.

The future needs expressed in the 1958 symposium were partially met at the time of the 1975 symposium. Flight flutter testing was, more automated, and the data were complete and of higher quality. The time required to acquire the data was not significantly less because most of the flight test organizations were conducting sine sweeps at stabilized test points. Testing was less hazardous in 1975 than in the 1950's, although reference 47 warned that the current techniques may still not predict flutter for explosive flutter cases. Reference 48 recommended that frequency and damping estimates for clearance to the next flutter test point be made between flights.

Recommendations for Future Research and Development

Online, real-time monitoring of aeroelastic stability during flight testing needs to be developed and implemented.

Techniques such as modal filtering (refs. 49 and 50) can uncouple response measurements to produce simplified, single-degree-of-freedom responses. These responses could then be accurately analyzed with less sophisticated algorithms that are more able to run in real time. The ideal display would show predicted frequency and damping values being compared with flight test values in real time.

Real-time monitoring of stability eliminates the most hazardous part of flight flutter testing, which is the acceleration from one test point to the next. Such monitoring also eliminates the need for stabilized test points, which is extremely time consuming.

Broad-band excitation techniques also need to be developed so that a response signal of sufficient amplitude over the entire frequency range of interest is continually provided for real-time analysis.

New methods should be researched to permit a reliable determination of flutter speed at a speed that is well below the actual one. The technique proposed by Nissim (ref. 51), which is based on identifying the coefficients of the equations of motion followed by solving of these equations to determine the flutter speed, may be one approach. The whole process of flight flutter testing needs to be fully automated so flight flutter testing can be done much faster but more safely.

REFERENCES

- ¹Von Schlippe, B., "The Question of Spontaneous Wing Oscillations (Determination of Critical Velocity Through Flight-Oscillation Tests)," NACA TM-806, October 1936 (translation).
- ²Lancaster, F.W., "Torsional Vibrations of the Tail of an Aeroplane," Reports and Memoranda, no. 276, July 1916, in "AIAA Selected Reprint Series, Volume V, Aerodynamic Flutter," I. E. Garrick, ed., March 1969, pp. 12-15.
- ³Collar, A.R., "The First Fifty Years of Aeroelasticity," *Aerospace*, vol. 5, no. 2, (Royal Aeronautical Society), February 1978, pp. 12-20.
- ⁴Tolve, L.A., "History of Flight Flutter Testing," in "Proceedings of the 1958 Flight Flutter Testing Symposium," NASA SP-385, 1958, pp. 159-166.
- ⁵Garrick, I.E., and Reed, W.H., III, "Historical Development of Aircraft Flutter," AIAA 81-0491, J. Aircraft, vol. 18, no. 11, November 1981, pp. 897-912.
- ⁶NACA Subcommittee on Vibration and Flutter, "A Survey and Evaluation of Flutter Research and Engineering," NACA RM-56I12, October 1956.
- ⁷French, M., Noll, T., Cooley, D., Moore, R., and Zapata, F., "Flutter Investigations Involving a Free Floating Aileron," AIAA Paper no. 87-0909, April 1987.
- ⁸Champion, L.S., and Cabrera, E.A., "F-16C/D Block 40 With Advanced Medium-Range Air-to-Air Missile (AMRAAM) Flutter Flight Test Evaluation," AFFTC TR-92-19, December 1992.
- ⁹Norton, W.J., "Limit Cycle Oscillation and Flight Flutter Testing," in "Proceedings, Society of Flight Test Engineers, 21st Annual Symposium," August 1990, pp. 3.4-1-3.4-12.
- ¹⁰Farley, H.C., Jr., and Abrams, R., "F-117A Flight Test Program," in "Proceedings of the 34th Society of Experimental Test Pilots Symposium," September 1990, pp. 141-167.
- ¹¹Borst, R.G., and Strome, R.W., "E-6 Flutter Investigation and Experience," AIAA-92-4601-CP, AIAA Guidance, Navigation, and Control Conference, Hilton Head, South Carolina, August 1992.
- ¹²Schwartz, M.D., and Wisley, D.L., "Final Report on the Investigation of Flight Flutter Testing Techniques for the Bureau of Aeronautics, U. S. Navy," Aeroelastic and Structures Research Laboratory, Massachusetts Institute of Technology, December 1950.
- ¹³Rosenbaum, R., "Survey of Aircraft Subcritical Flight Flutter Testing Methods," NASA CR-132479, August 1974.
- ¹⁴Kachadourian, G., Goldman, R.L., and Roha, D.M., "Flight Flutter Testing of the P6M," in "Proceedings of the 1958 Flight Flutter Testing Symposium," NASA SP-385, 1958, pp. 91-96.
- ¹⁵Kehoe, M.W., "Aircraft Flight Flutter Testing at the NASA Ames-Dryden Flight Research Facility," NASA TM-100417, May 1988.
- ¹⁶Goldman, A., Rider, C.D., and Piperias, P., "Flutter Investigations on a Transavia PL12/T-400 Aircraft," Aeronautical Research Laboratories, Melbourne, Australia, Aircraft Structures Technical Memorandum 515, July 1989.
- ¹⁷Mahaffey, P.T., "Flight Flutter Testing the B-58 Airplane," in "Proceedings of the 1958 Flight Flutter Testing Symposium," NASA SP-385, 1958, pp. 121-125.

¹⁸Stringham, R.H., Jr., and Lenk, E.J., "Flight Flutter Testing Using Pulse Techniques," in "Proceedings of the 1958 Flight Flutter Testing Symposium," NASA SP-385, 1958, pp. 69-72.

¹⁹Meany, J.J., "The Evolution of Flutter Excitation at McDonnell Aircraft," in "14th Annual Symposium Proceedings," Society of Flight Test Engineers, August 1983, pp. 4.6-1-4.6-11.

²⁰Hodson, C.H., Dobbs, S.K., Brosnan, M.J., and Chen, J.B., "X-31A Flight Flutter Test Excitation by Control Surfaces," AIAA-93-1538-CP, 34th AIAA Structures, Structural Dynamics and Materials Conference, La Jolla, California, April 1993.

²¹Laure, P., Millet, M., and Piazzoli, G., "Pyrotechnic Bonkers for Structural Tests in Flight," ONERA TP no. 1389 E, 1974.

²²Dublin, M., and Peller, R., "Flight Flutter Testing of Supersonic Interceptors," in "Proceedings of the 1958 Flight Flutter Testing Symposium," NASA SP-385, 1958, pp. 111-120.

²³Dobbs, S.K., and Hodson, C.H., "Determination of Subcritical Frequency and Damping From B-1 Flight Flutter Test Data," NASA CR-3152, June 1979.

²⁴Bartley, J., "Flight Flutter Testing of Multi-Jet Aircraft," in "Proceedings of the 1958 Flight Flutter Testing Symposium," NASA SP-385, 1958, pp. 103-110.

²⁵Reed, W.H., III, "A New Flight Flutter Excitation System," in "19th Annual Symposium Proceedings," Society of Flight Test Engineers, Arlington, Texas, August 14-18, 1988, pp. V-1.1-V-1.7.

²⁶Vernon, L., "In-Flight Investigation of a Rotating Cylinder-Based Structural Excitation System for Flutter Testing," NASA TM-4512, 1993.

²⁷Norton, W.J., "Random Air Turbulence as a Flutter Test Excitation Source," in "Proceedings, Society of Flight Test Engineers, 20th Annual Symposium," Reno, Nevada, September 18-21, 1989.

²⁸Brignac, W.J., Ness, H.B., Johnson, M.K., and Smith, L.M., "YF-16 Flight Flutter Test Procedures," in "Flutter Testing Techniques: A conference held at Dryden Flight Research Center, October 9-10, 1975," NASA SP-415, 1976, pp. 433-456.

²⁹Nordwall, B.D., "Mobile Communications to Capture Consumer Market," *Aviation Week & Space Technology*, May 31, 1993, pp. 41-42.

³⁰Baird, E.F., Sinder, R.B., and Wittman, R.B., "Stabilizer Flutter Investigated by Flight Test," in "Proceedings of the 1958 Flight Flutter Testing Symposium," NASA SP-385, 1958, pp. 73-81.

³¹Reed, W.H., III, "A Flight Investigation of Oscillating Air Forces: Equipment and Technique," in "Proceedings of the 1958 Flight Flutter Testing Symposium," NASA SP-385, 1958, pp. 41-50.

³²Philbrick, J., "Douglas Experience in Flight Flutter Testing," in "Proceedings of the 1958 Flight Flutter Testing Symposium," NASA SP-385, 1958, pp. 127-132.

³³Laidlaw, W.R., and Beals, V.L., "The Application of Pulse Excitation to Ground and Flight Vibration Tests," in "Proceedings of the 1958 Flight Flutter Testing Symposium," NASA SP-385, 1958, pp. 133-142.

³⁴Meyer, R.R., Jr., and Schneider, E.T., "Real-Time Pilot Guidance System for Improved Flight Test Maneuvers," AIAA-83-2747, November 1983.

³⁵Rhea, D.C., and Moore, A.L., "Development of a Mobile Research Flight Test Support Capability," in "Proceedings of the 4th AIAA Flight Test Conference," San Diego, California 1988.

³⁶Sefic, W.J., and Maxwell, C.M., "X-29A Technology Demonstrator Flight Test Program Overview," NASA TM-86809, May 1986.

³⁷Perangelo, H.J., and Waisanen, P.R., "Flight Flutter Test Methodology at Grumman," in "Flight Testing Technology: A State-of-the-Art Review," Society of Flight Test Engineers, 13th Annual Symposium, New York, September 19-22, 1982, pp. 91-ff.

³⁸Katz, H., Foppe, F.G., and Grossman, D.T., "F-15 Flight Flutter Test Program," in "Flutter Testing Techniques: A conference held at Dryden Flight Research Center," NASA SP-415, 1976, pp. 413-431.

³⁹Allemang, R.J., and Brown, D.L., "Experimental Modal Analysis and Dynamic Component Synthesis," AFWAL-TR-87-3069, vol. I, Flight Dynamics Laboratory, Wright-Patterson Air Force Base, Ohio, December 1987.

⁴⁰Cooper, J.E., "Modal Parameter Identification Techniques for Flight Flutter Testing," in Aeronautical Engineering Group, Aeronautical Report no. 9105, University of Manchester, Manchester U.K., 1991.

⁴¹Nash, D.E., Katz, H., and Moody, W.C., "F-15 Flight Flutter Testing: Aircraft Systems and Test Operations," AIAA Paper no. 75-1031, AIAA 1975 Aircraft Systems and Technology Meeting, Los Angeles, California, 1975.

⁴²Kehoe, M.W., "KC-135 Winglet Flight Flutter Test Program," AFFTC TR-81-4, Air Force Flight Test Center, Edwards Air Force Base, California, June 1981.

⁴³NASA Langley Research Center, *Proceedings of the 1958 Flight Flutter Testing Symposium*, NASA SP-385, May 1958.

⁴⁴National Aeronautics and Space Administration, *Flutter Testing Techniques*, NASA SP-415, October 1975.

⁴⁵Lenz, R.W., and McKeever, B., "Time Series Analysis in Flight Flutter Testing at the Air Force Flight Test Center: Concepts and Results," in "Flutter Testing Techniques: A conference held at Dryden Flight Research Center," NASA SP-415, 1976, pp. 287-317.

⁴⁶Hurley, S.R., "The Application of Digital Computers to Near-Real-Time Processing of Flutter Test Data," in "Flutter Testing Techniques: A conference held at Dryden Flight Research Center," NASA SP-415, 1976, pp. 377-394.

⁴⁷Foughner, J.T., Jr., "Some Experience Using Subcritical Response Methods in Wind-Tunnel Flutter Model Studies," in "Flutter Testing Techniques: A conference held at Dryden Flight Research Center," NASA SP-415, 1976, pp. 181-191.

⁴⁸Wright, J.R., "Introduction to Flutter of Winged Aircraft," von Karman Institute for Fluid Dynamics, Lecture Series 1992-01, December 1991.

⁴⁹Shelley, S.J., Freudinger, L.C., and Allemang, R.J., "Development of an On-line Parameter Estimation System Using the Discrete Modal Filter," in "Proceedings of the 10th International Modal Analysis Conference," San Diego, California, February 3-7, 1992, pp. 173-183.

⁵⁰Shelley, S.J., Freudinger, L.C., and Allemang, R.J., "Development of an On-line Modal State Monitor," in "Proceedings of the 11th International Modal Analysis Conference," Kissimmee, Florida, February 1-4, 1993.

⁵¹Nissim, E., and Gilyard, G.B., "Method for Experimental Determination of Flutter Speed by Parameter Identification," NASA TP-2923, 1989.

REPORT DOCUMENTATION PAGE

Form Approved
OMB No. 0704-0188

Public reporting burden for this collection of information is estimated to average 1 hour per response, including the time for reviewing instructions, searching existing data sources, gathering and maintaining the data needed, and completing and reviewing the collection of information. Send comments regarding this burden estimate or any other aspect of this collection of information, including suggestions for reducing this burden, to Washington Headquarters Services, Directorate for Information Operations and Reports, 1215 Jefferson Davis Highway, Suite 1204, Arlington, VA 22202-4302, and to the Office of Management and Budget, Paperwork Reduction Project (0704-0188), Washington, DC 20503.

1. AGENCY USE ONLY (Leave blank)	2. REPORT DATE October 1995	3. REPORT TYPE AND DATES COVERED Technical Memorandum	
4. TITLE AND SUBTITLE A Historical Overview of Flight Flutter Testing		5. FUNDING NUMBERS WU 505-63-50	
6. AUTHOR(S) Michael W. Kehoe		7. PERFORMING ORGANIZATION NAME(S) AND ADDRESS(ES) NASA Dryden Flight Research Center P.O. Box 273 Edwards, California 93523-0273	
8. PERFORMING ORGANIZATION REPORT NUMBER H-2077		9. SPONSORING/MONITORING AGENCY NAME(S) AND ADDRESS(ES) National Aeronautics and Space Administration Washington, DC 20546-0001	
10. SPONSORING/MONITORING AGENCY REPORT NUMBER NASA TM-4720		11. SUPPLEMENTARY NOTES Previously presented at the AGARD Structures and Materials Panel Meeting, Rotterdam, Netherlands, May 8-10, 1995.	
12a. DISTRIBUTION/AVAILABILITY STATEMENT Unclassified—Unlimited Subject Category 05		12b. DISTRIBUTION CODE	
13. ABSTRACT (Maximum 200 words) This paper reviews the test techniques developed over the last several decades for flight flutter testing of aircraft. Structural excitation systems, instrumentation systems, digital data preprocessing, and parameter identification algorithms (for frequency and damping estimates from the response data) are described. Practical experiences and example test programs illustrate the combined, integrated effectiveness of the various approaches used. Finally, comments regarding the direction of future developments and needs are presented.			
14. SUBJECT TERMS Aeroelasticity; Aircraft vibration; Flight flutter testing; Flutter test history; Flutter test procedures			15. NUMBER OF PAGES 19
			16. PRICE CODE AO3
17. SECURITY CLASSIFICATION OF REPORT Unclassified	18. SECURITY CLASSIFICATION OF THIS PAGE Unclassified	19. SECURITY CLASSIFICATION OF ABSTRACT Unclassified	20. LIMITATION OF ABSTRACT Unlimited