

NASA Technical Memorandum 4732

# Laser-Heated Floating Zone Production of Single-Crystal Fibers

Frank Ritzert and Leonard Westfall

JANUARY 1996



National Aeronautics and  
Space Administration

NASA Technical Memorandum 4732

# Laser-Heated Floating Zone Production of Single-Crystal Fibers

Frank Ritzert and Leonard Westfall  
*Lewis Research Center*  
*Cleveland, Ohio*



National Aeronautics and  
Space Administration

**Office of Management**

Scientific and Technical  
Information Program

**1996**

**Trade names or manufacturers' names are used in this report for identification only. This usage does not constitute an official endorsement, either expressed or implied, by the National Aeronautics and Space Administration.**

# Laser-Heated Floating Zone Production of Single-Crystal Fibers

Frank Ritzert and Leonard Westfall  
National Aeronautics and Space Administration  
Lewis Research Center  
Cleveland, Ohio 44135

## Summary

This report describes how a laser-heated floating zone apparatus can be used to investigate single-crystal fibers of various compositions. A feedrod with a stoichiometric composition of high-purity powders was connected to a pedestal and fed into a laser scan where it combined with a single-crystal fiber seed. A molten zone was formed at this junction. As the feedrod was continuously fed into the laser scan, a single-crystal fiber of a prescribed orientation was withdrawn from the melt. The resultant fibers, whose diameters ranged from 100 to 250  $\mu\text{m}$ , could then be evaluated on the basis of their growth behavior, physical properties, mechanical properties, and fiber perfection.

## Introduction

Future civil aircraft propulsion systems will require greatly increased fuel economy, improved reliability, extended life, and reduced operating costs. To meet these goals, materials must be developed that can be used at significantly higher operating temperatures and strength-to-weight ratios than those of materials currently available. Fiber-reinforced metal and intermetallic matrix composites are candidate materials for these applications because of their potential high-temperature strength and specific stiffness, oxidation resistance, and low density (refs. 1 to 3). The objective of the metal matrix composites (MMC)/intermetallic matrix composites (IMC) portion of NASA's Advanced High Temperature Engine Materials Technology Program (HITEMP) is to develop enabling technologies for these materials for aeropropulsion applications in the 425 to 1260  $^{\circ}\text{C}$  range (ref. 3).

A key factor in developing MMC's and IMC's is obtaining advanced fibers that can effectively reinforce these composite systems for long lives at elevated temperatures (refs. 2 and 3). These fibers must meet the goals of high coefficients of thermal expansion (CTE) to match those of the matrices, fiber/matrix chemical compatibility, low density, and high-temperature strength and modulus. The fibers also should be flexible to allow composite fabrication (ref. 1). A major effort is underway to develop advanced fibers and fiber coatings for high-

temperature MMC and IMC applications. Promising fiber candidates are being identified by thermodynamic compatibility with the matrix, diffusion couple studies, and material property literature surveys. Where ideal thermomechanical and thermochemical matches between the fiber and matrix are absent, fiber compliant layers and chemically compatible coatings are being investigated.

The goal of the laser float zone (LFZ) work is to grow useful compositions and selected orientations of high-integrity, high-purity fibers with small, uniform diameters. For this work, single-crystal fibers are preferred to their polycrystalline counterparts for several reasons:

(1) The defect structures of polycrystalline fibers are much more complex than those of single-crystal fibers because of grain boundaries. Grain boundaries act as a bed for inhomogeneities, impurities, and dislocations that adversely affect high-temperature behavior. Defects are minimized in smaller diameter, single-crystal fibers because the fiber walls act as boundaries and defect size cannot exceed the fiber diameter. In fact, reducing the diameter of a single crystal just after seeding and then widening it to the desired diameter may even yield a dislocation-free material (ref. 4).

(2) Defects that arise from several growth-related factors, as well as from processing or mishandling after growth, can significantly curtail final fiber strength and integrity (ref. 5). This is evidenced by the fact that single-crystal fibers produced with high crystalline perfection have a tensile strength that is closer to their theoretical maximum (ref. 4). In the single-crystal, fiber chemical segregation is minimized and grain boundaries are eliminated, decreasing dislocation densities.

(3) Single crystals optimize properties by controlling fiber-axis orientations. It is well understood that certain orientations give single crystals better strength properties because resolved shear stresses on the active slip systems are minimized (ref. 6).

Our strategy is to take advantage of the benefits of single crystals and to improve the strength, stiffness, fracture toughness, and creep potential of composite systems by developing single-crystal fibers with the right blend of fiber perfection, crystal structures, alloying additives, and stress-axis orientation (ref. 5).

Several authors (refs. 2, 4, 5, and 7 to 12) have contributed to the literature with regard to the laser-heated fiber growth process. This report presents the current LFZ technique used to produce experimental lengths of single-crystal fibers from extruded feedrods made of high-purity powders.

## Making Feedrods

Feedrods are the starting material from which single-crystal fibers are grown in the LFZ method. Dopants, impurities, density, and stoichiometry are all process variables (ref. 7). Although the composition of the feedrod is one of the factors governing the composition of the final crystal, the compositions of the feedrod and resulting single-crystal fiber are not necessarily the same. In some cases, a difference between the feedrod and fiber results from uneven vapor loss that occurs in the melt. It is crucial that feedrod compositions be formulated to compensate for any preferential losses (ref. 5).

In feedrod production, a mixture of either metallic or ceramic powders is mixed with an organic binder and extruded to produce a thin rod that is suitable for growing single-crystal

fibers by the LFZ process. Production begins with the preparation of high-purity powders, where our standard practice specifies a purity of at least 99.9 percent and a mesh size of  $-325$ . The powders are measured according to their densities and molecular weight to achieve the proper stoichiometric mole fraction mixture. The total batch weight is usually about 5 g, which produces about 15 feedrods of uniform diameter. The two powders are combined in a rotating plastic container, where they are mixed for 2 to 3 hr to completely blend and break up any clumps.

Of the many organic binders that facilitate the extrusion of powders, Methocel (Dow Chemical, Midland, Michigan) has been the most successful binder used in our experiments. Methocel is a water-soluble cellulose ether product that is easy to work with and clean up. Only a very small amount (about 1/30 by weight) is required to produce the proper extrusion properties. It leaves no residue when used in air and only a small residue when used in an inert gas atmosphere. Methocel powder is combined with a small portion of boiling deionized water and mixed with a plastic stirring rod until it is dissolved to form a gel binder. The blended powders are then added to the dissolved Methocel binder in a metal cup that is heated on a hot

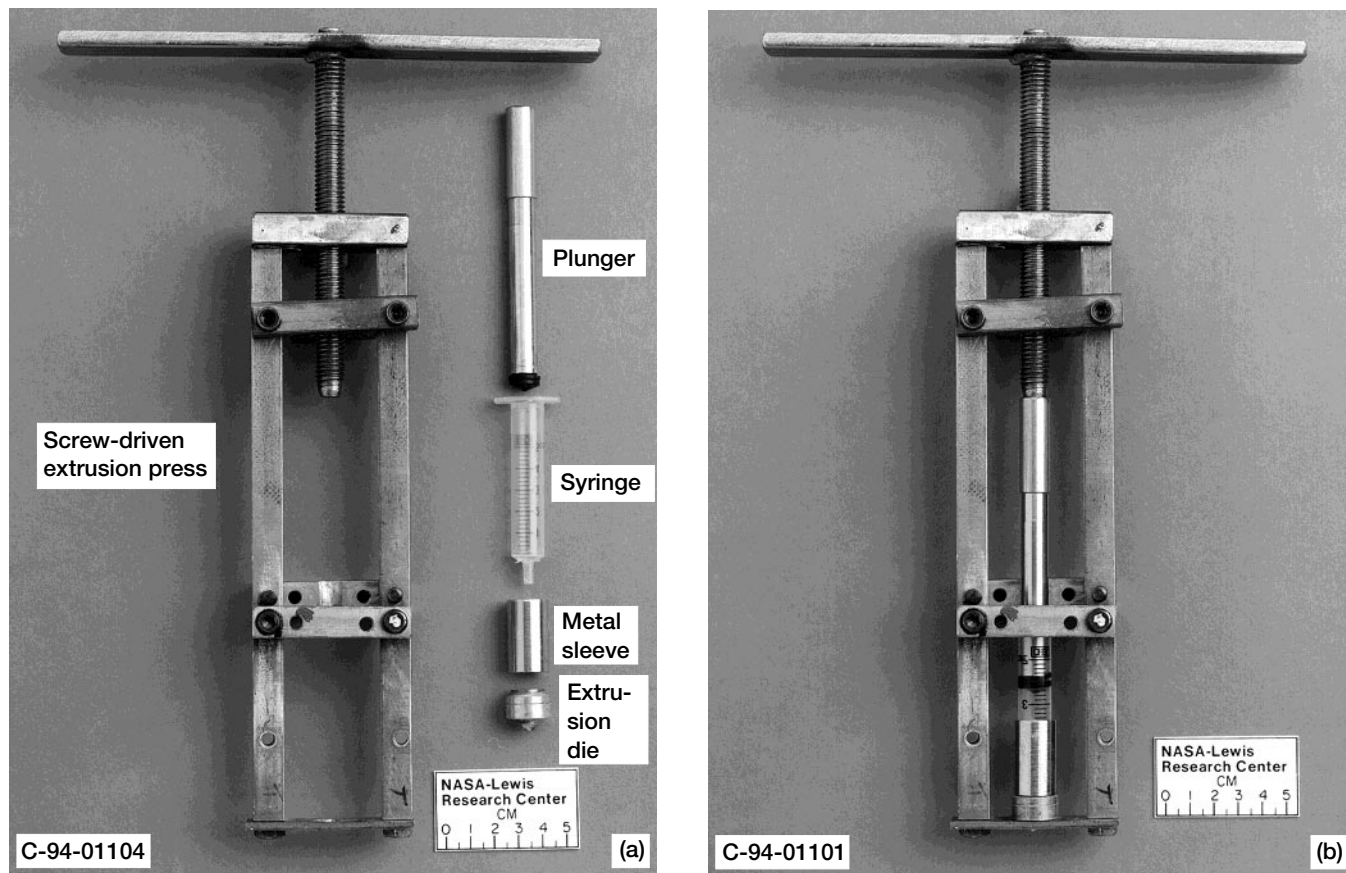

Figure 1.—Screw-driven feedrod fabrication apparatus. (a) Prior to assembly. Components and their relative placement for extrusion. (b) After assembly. Screw drives the plunger to extrude the binder/powder mixture through the die.

plate. As the mixture boils, it is stirred until enough water evaporates so that a soft, dough-like binder/powder mixture remains. Then, the metal cup is removed from the hot plate, and the binder/powder mixture is allowed to cool. Once cooled, the binder/powder compact is gathered with a stirring rod, spread out in the metal cup, and heated again to drive off additional water. This process is repeated several times.

When the binder/powder mass is as dry as possible, but still workable as determined from experimentation, it is shaped into a “bullet” to use in the extrusion apparatus. Before extrusion, this bullet may be subjected to a vacuum to remove any small, trapped air pockets. We have found that the highest density and strongest feedrods are produced by extruding the firmest binder/powder compact.

The extrusion equipment (fig. 1) consists of a small disposable plastic syringe that is inserted into a fitted metal sleeve to reinforce the syringe walls. A rubber cap is placed on the tip of a metal push rod, which serves as a plunger, to fit snugly into the syringe. In turn, the tip of the syringe is placed into a tight-fitting metal cap that acts as a die to extrude the final feedrod to the specified diameter. We limit the use of metallic objects during fabrication to avoid contaminating the powders or the powder slurry. However, we believe that the metal die does not contaminate the feedrod because of the high plasticity of the binder/powder mixture. Assembly of these components begins with placing the binder/powder bullet compact into the syringe. Then, the plunger assembly is inserted to press the compact toward the exit orifice. With the reinforcing metal sleeve and the metal cap already in place, this subunit is placed in a screw-driven apparatus (fig. 1). When the screw is turned, it pushes the plunger, and the binder/powder compact extrudes through the die at a controlled rate into feedrod form (fig. 2). After several extrusions, fiber lengths of 17 cm are placed one at a time onto a heated, clean, flat metal surface where they are heated to about 120 °C and rolled by another thin, flat metal sheet for about 20 sec. This final heating removes any residual moisture, thermally sets the binder, and stiffens the feedrods so that they are perfectly straight. Then, the feedrods are removed from the heat and allowed to cool.

We have found that multiple extrusions of the same feed stock give more homogeneous distributions of the powder particles in the final feedrods, especially when the mixture contains powders that vary greatly in density. To demonstrate this, we mixed metallic and ceramic powders that were dissimilar in appearance and subjected them to various numbers of extrusions. Then, the resulting mixtures were examined by optical microscopy. Qualitative results of the ceramic powder distribution with the metallic powders revealed that two or more extrusions enhance uniform mixing because the shearing forces break up agglomerations. Binder/powder bullets were reformed prior to each additional extrusion of the bulk material. Three to four extrusions were usually done before the final feedrod lengths were formed and cured by heating.

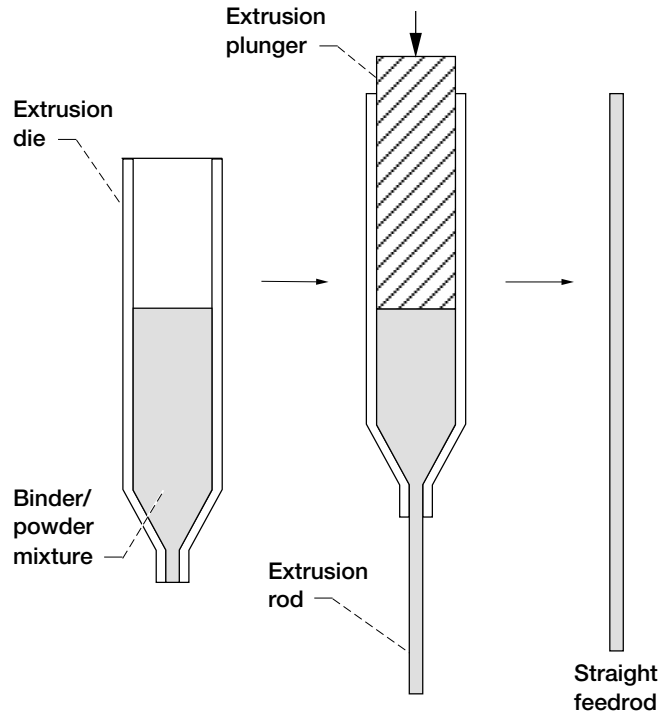

Figure 2.—Extrusion of feedrods through the die. Final usable lengths are obtained after the hotplate burns off the final traces of moisture.

Although 17-cm lengths have been the most convenient for our experiments, continuous feedrod production will eventually be necessary. For continuous feedrod production, a plasticizer such as glycerin would be added to the mixture to produce a flexible feedrod that can be extruded continuously and coiled for storage. Hundreds of feet of continuous feedrod have already been produced by this technique with the use of a larger extrusion press (W. Penn, 1993, Peachtree Scientific, Inc., Dahlonega, GA, personal communication).

## Laser-Heated Floating Zone

Figure 3 describes the three primary components of the area involved in LFZ crystal formation—the feedrod, the molten zone, and the solidified crystal—and figure 4 is a photograph of these components. The feedrod and crystal are joined with the impinging laser, creating a “floating” molten zone. It is essential that the laser power be balanced and focused so that the molten zone is uniform. Crystals are grown by a mass-in/mass-out principle. Independent control of the driving rates of the upper and lower pullheads enables the fibers to be attenuated (see the Discontinuous Drive Setup section). Specifically, if the growth direction is “up” (fig. 3(b)), setting the upper pullhead rate faster than that of the lower pullhead yields a crystal that is smaller in diameter than the original feedrod. This is usually

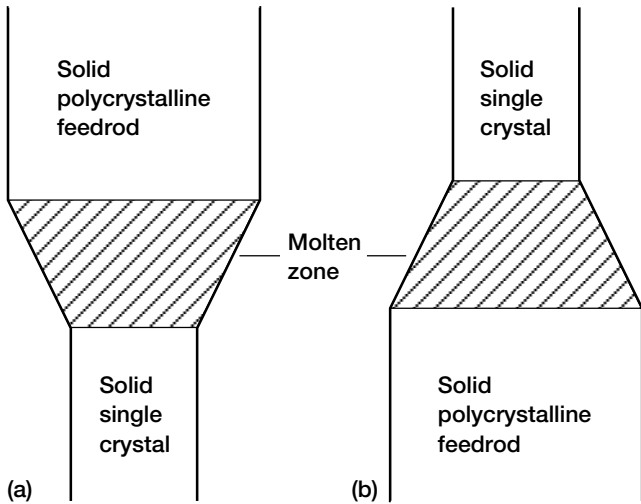

Figure 3.—The laser creates a molten zone at the junction between the feedrod and the single crystal. The feedrod is fed into the melt while the crystal is drawn out of it. (a) Downward growth. (b) Upward growth.

done with speed ratios such as 2:1, 3:1, et cetera. Changing the growth direction to “down” by inverting the pullhead speed ratio produces growth like that shown in figure 3(a). It also is possible to obtain crystals that are larger in diameter than the starting feed stock, but this has been experimentally unnecessary up to this time. High attenuation is more difficult when the speed of growth is greater than 12 in./hr (ref. 13).

## Laser-Heated Floating Zone Apparatus

Figures 5 and 6 show the apparatus used to grow single-crystal fibers by the LFZ process. The schematic drawing of the equipment (fig. 5) shows the 600-W CO<sub>2</sub> laser on the left and the LFZ workstation on the right. The CO<sub>2</sub> laser is more than sufficient to handle high melting point materials and, with the proper use of filters, can be operated as low as 5 W while maintaining a stable condition (ref. 2). One laser beam is generated and then split. These two beams are then focused and channeled so that they are perfectly directed towards each other and intersect at the center of the chamber (figs. 6 and 7). These opposing beams are converted into opposing laser line scans by the melt modulation device described next.

### Melt Modulation

Melt modulation refers to the high-frequency vibration of the molten zone caused by the opposing laser line scans. The line scans are produced by reflecting the focused laser beam off of a rotating cam (fig. 8). Two cams, shown by the arrows in figure 7, are necessary to maintain stability and symmetry in the

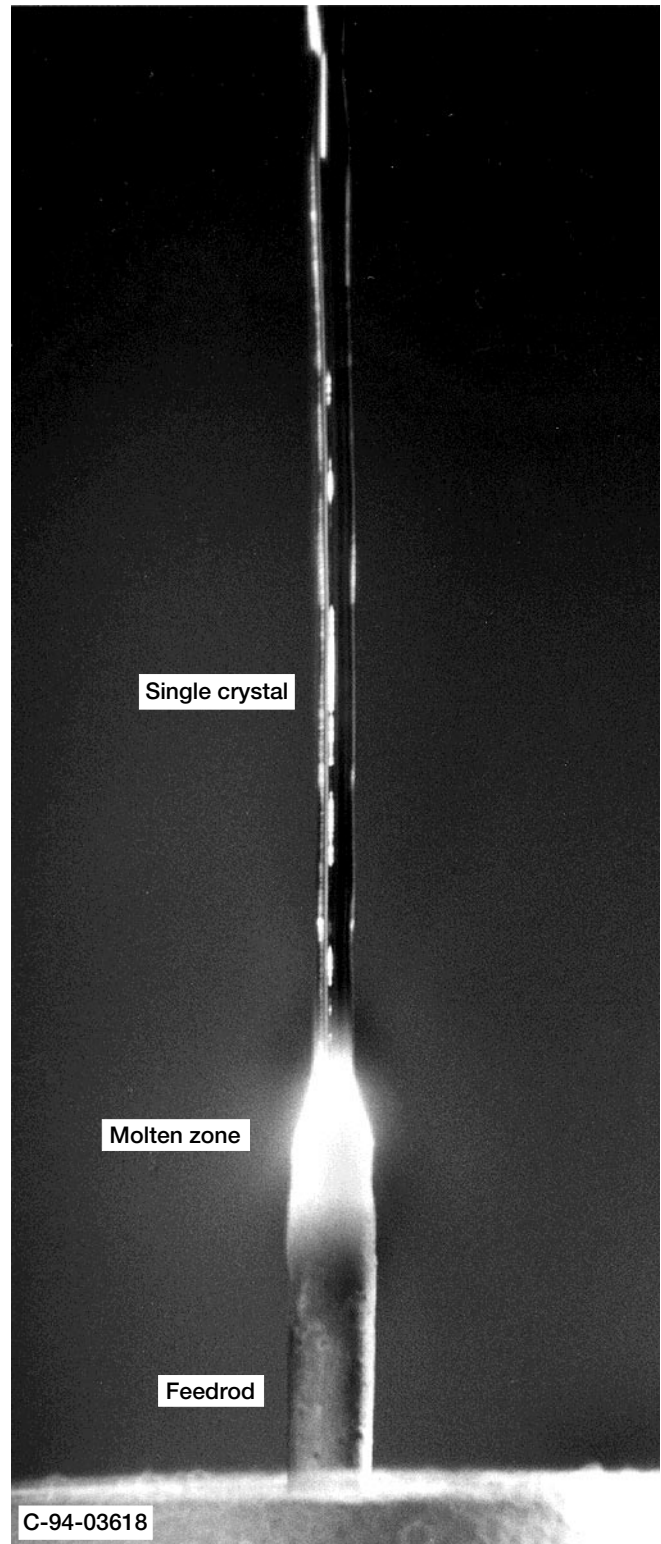

Figure 4.—Sapphire fiber growing from the molten zone. Fiber and feedrod are moving upward while the molten zone remains stationary.

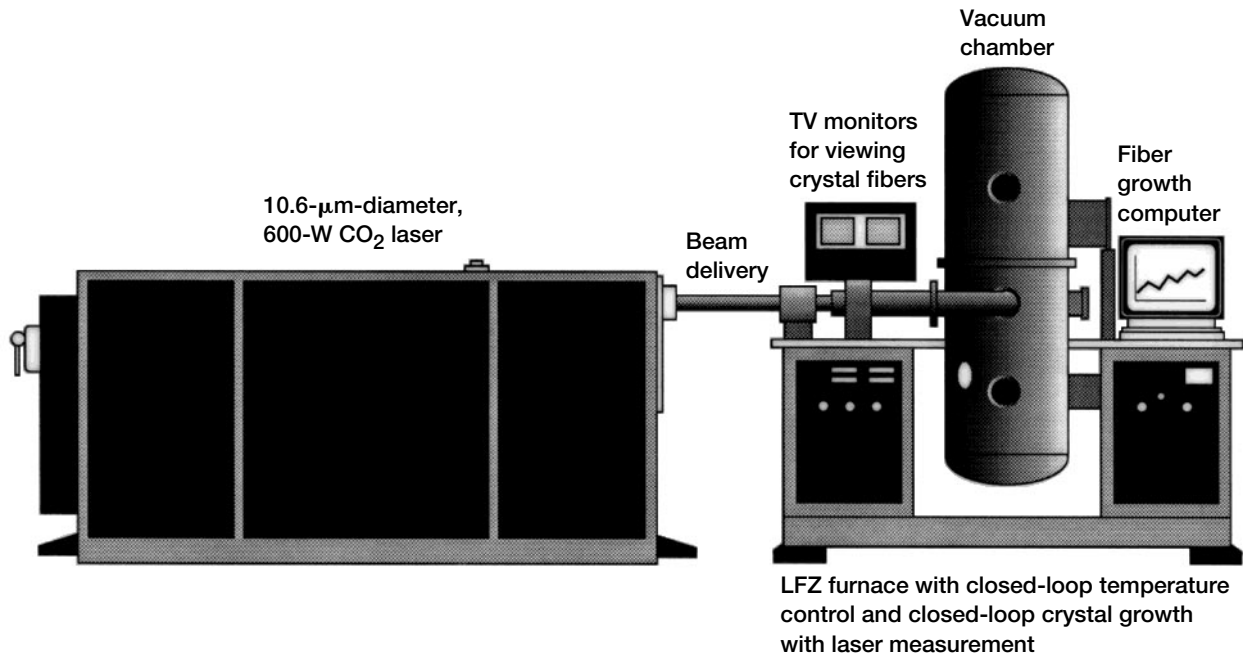

Figure 5.—Laser float zone (LFZ) fiber growth facility.

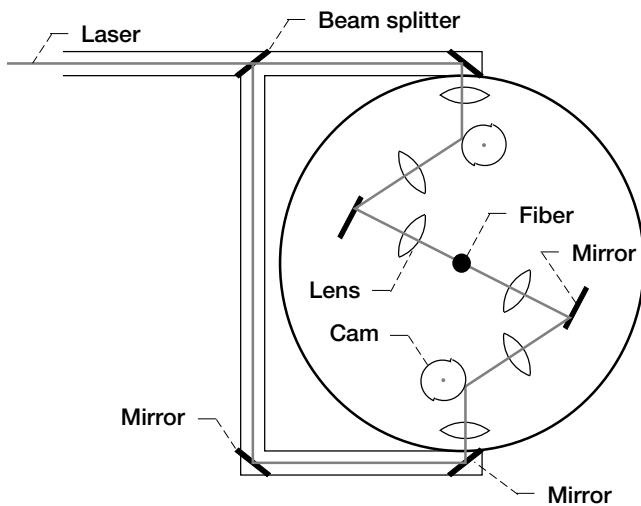

Figure 6.—Laser path in the laser float zone (LFZ) system. The laser is split in two by a 50/50 beam splitter and then focused onto the fiber by a series of lenses and mirrors. The cams create even heating by producing linear laser scans.

molten zone. In the current system, the incoming laser beam is focused by a lens onto the surface of the gold-plated cam (fig. 8). As the cam rotates, the reflection of the laser beam moves to the side as the radius increases until the step where the laser beam instantly returns to the starting position (fig. 8). The size of the cam step determines the length of the line scan, and the rotation of the cam determines the frequency of the line

scan. Because the frequency is adjustable, deviations in melt stability can be eliminated during operation. The line scans, which must be adjusted so that the feedrod is in the center of the scan, are positioned by small adjustments of the final deflecting mirror after the laser beam leaves the rotating cam (fig. 6). This positioning is done from both sides to produce focused, opposing line scans that cause the molten zone to oscillate. The high-frequency oscillation produces a very stable and controllable molten zone with an increased thermal agitation that results in increased mixing and a more uniform temperature distribution in the melt.

### Discontinuous Drive Setup

Two different process setups are used to achieve two different objectives. The discontinuous setup is used to grow experimental lengths of single-crystal fibers for evaluation, and the continuous setup is used for spooled fiber production. Because there are only subtle differences between the two, only the discontinuous process is discussed here.

The discontinuous pullhead design (fig. 9) is used to grow experimental lengths of fiber. It requires shorter feedrods to make lengths of single-crystal fiber for evaluation. The effectiveness of the LFZ process relies on smooth pullhead motion. A computer-controlled dc motor drive with a 200 counts per revolution encoder is directly coupled to the drive roller. Fastened to the motor is a 48 000-to-1 reducing gear mechanism, resulting in an output to the computer of 96 million counts per drive roller revolution. Because the drive roller is 28 mm in



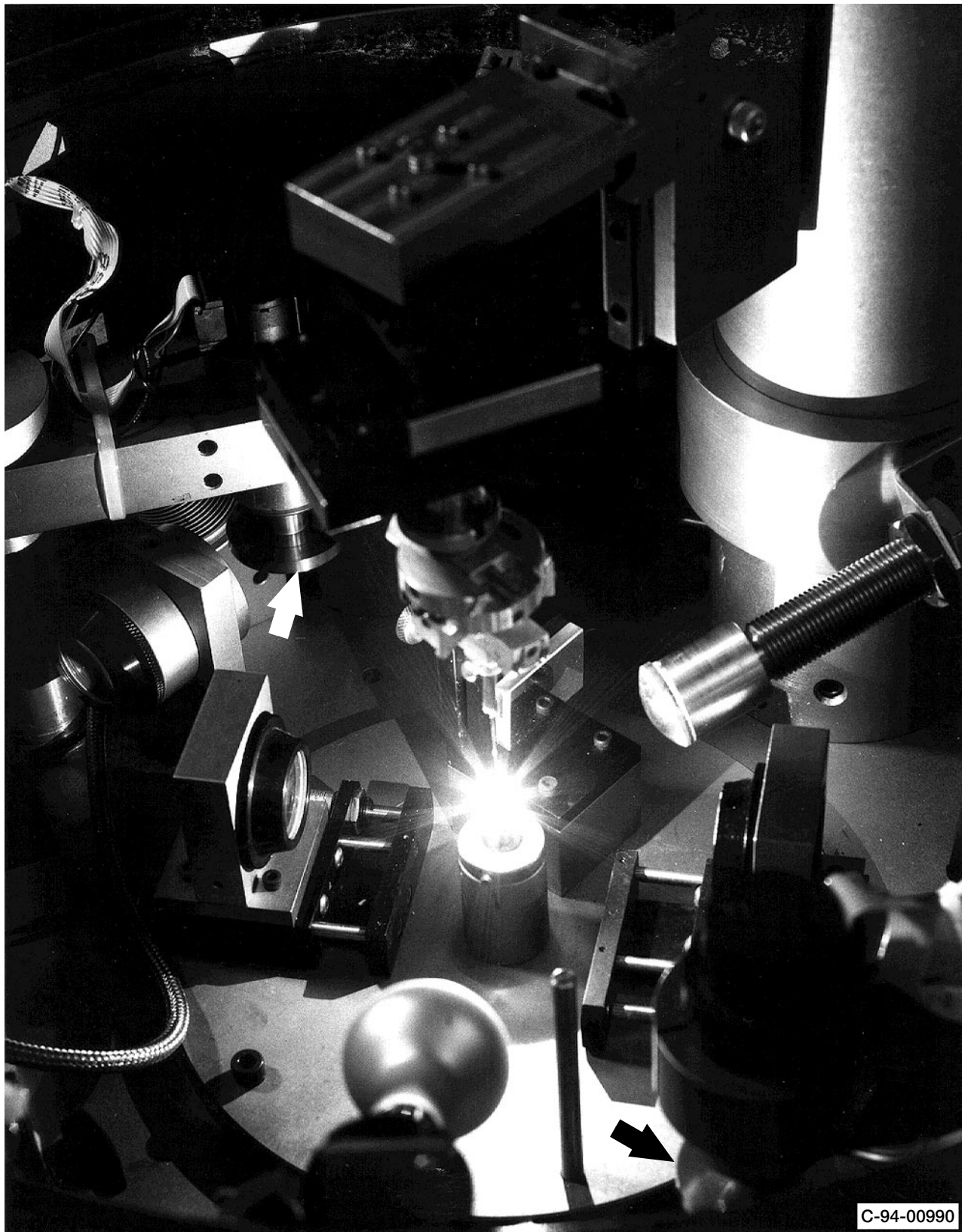

Figure 7.—Fiber growth. Arrows point out the cams that provide even heating of the molten zone.

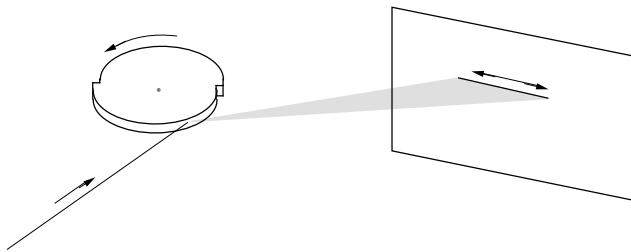

Figure 8.—The laser beam is transformed into a linear laser scan as it impinges on the rotating cam. The scan is the result of the increasing radius of the cam and its high frequency of rotations per second.

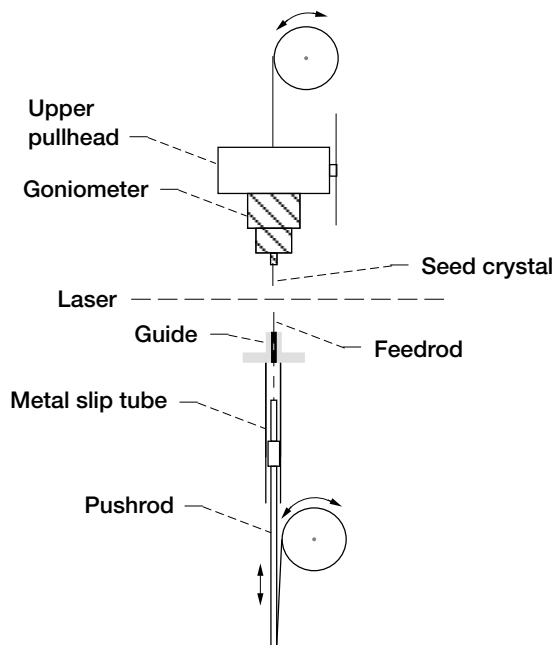

Figure 9.—Laser float zone (LFZ) pullhead assembly. The feedrod is moved through a close-fitting guide into the laser scan where it joins with a seed crystal with a preferred orientation. Two direct-drive motors provide independent motion of the seed crystal and feedrod.

diameter, the resulting computer control is  $10^{-6}$  mm per computer count. This degree of computer control gives the drive roller a smooth, controlled motion that is transferred to the pullhead by a strong 0.127-mm tungsten wire. One end of the wire is fastened to the pullhead and the other end is wrapped several times around the smooth drive roller (fig. 10). As the wire is extended from the roller or retracted onto it, the upper pullhead moves. Growth speeds range from 0.5 to 50 cm/hr. Figure 11 shows where these rollers are located in the system.

The bottom pullhead works in a similar way. The roller with the wrapped wire is above the bottom of the pushrod where the end of the wire is connected (fig. 9). The pushrod passes up

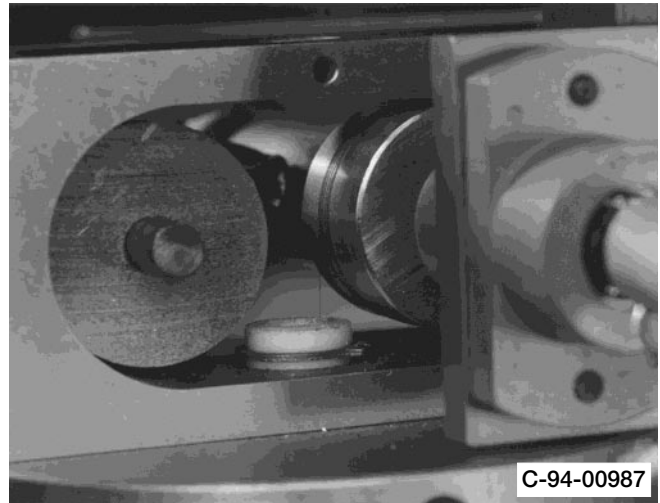

Figure 10.—Upper roller drive. Wire winds onto and off of the roller by remote control. Wire is attached so that it smoothly translates the seed crystal as shown in figures 7 and 10.

through a close-tolerance metal slip tube that is securely fastened to the feedrod guide mechanism. In turn, the feedrod is attached to the top of the pushrod so that the lower pullhead assembly moves the pushrod and feedrod up through the metal slip tube, causing the feedrod to pass through the close-fitting guide mechanism and into the laser beam focal point. To work properly, the feedrod must be stiff and straight. The pushrod and feedrod move vertically as the wire is wound onto or off of the roller. This type of moving assembly produces the very smooth, uniform motion required for crystal growth.

The single-crystal seed in the upper pullhead is positioned by a goniometer that is beneath a remote-controlled X–Y positioning stage (fig. 11). The goniometer rotates the seed fiber for crystallographic orientation, and the X–Y stage allows the seed fiber to be positioned directly above the laser focal point by external remote control. This is done by using two orthogonal television images of the molten zone. These orthogonal images are obtained by using front surface mirrors to pass the molten zone image through a window, onto external television cameras, and finally to the two TV receivers. The upper pullhead is aligned when the seed fiber is perfectly positioned above the feedrod in both images.

Other features of the LFZ system include a long-range microscope on the right side of the workstation that is used to view the molten zone at high magnification and at  $90^\circ$  to the focused laser beams. The  $90^\circ$  image is necessary to balance the heat input from the opposing laser beams, maintain symmetry in the molten zone, and produce a flat interface between the growing crystal and the liquid. This higher magnification view can also be transmitted to one of the TV receivers to observe the dynamic growth process. A He-Ne laser, which is used to measure the fiber diameter, scans a line approximately 2-cm wide that intercepts the fiber at a selected height. The line scan

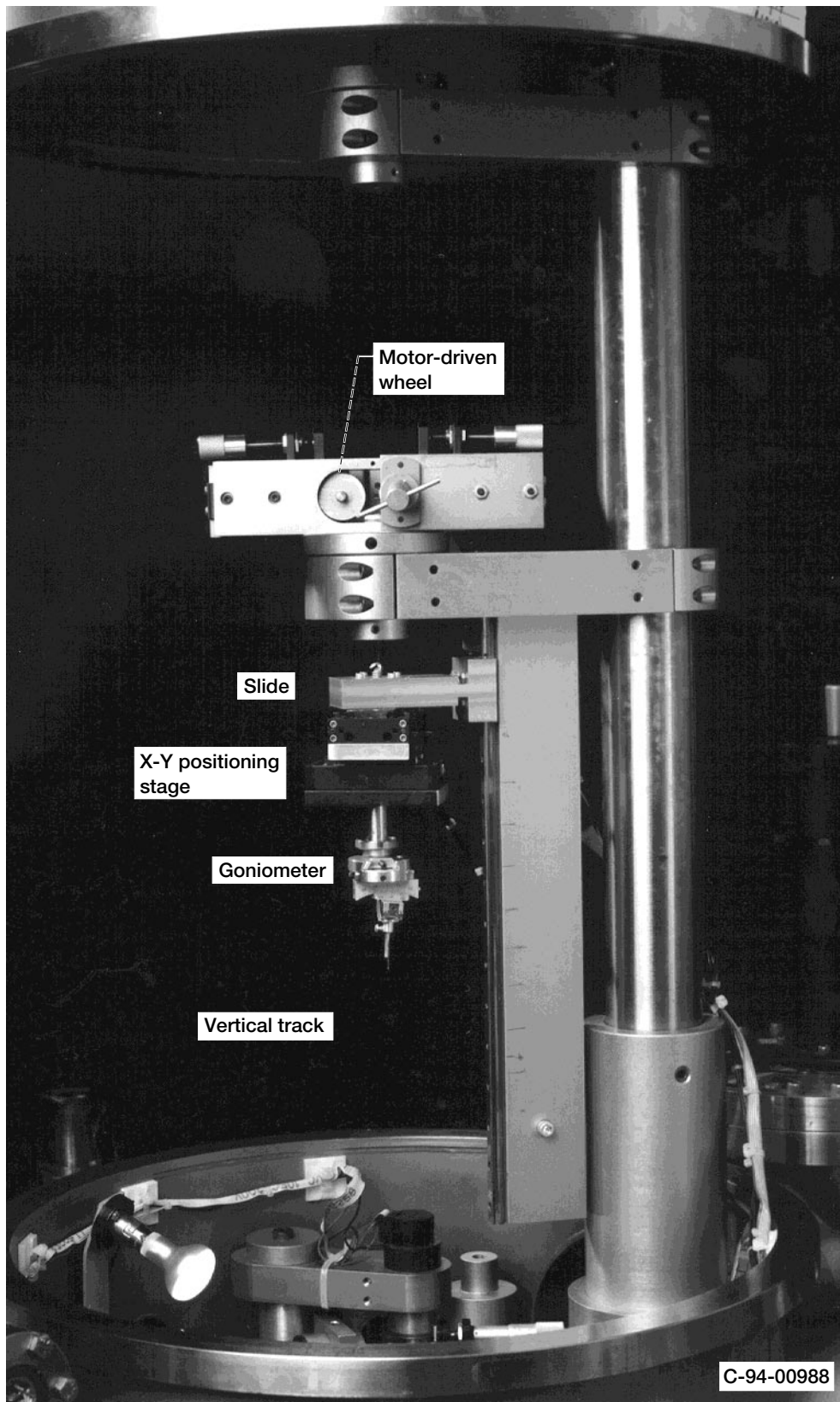

Figure 11.—Components of the upper drive mechanism. The motorized wheel controls the motion of the seed crystal by moving the slide on the vertical track. An X-Y positioning stage allows the seed to be placed directly above the feedrod at the laser scan.

and the shadow of the fiber are focused onto a receiver in front of the workstation. This receiver converts the shadow of the fiber into a dimension that is read by a computer. The computer can increase or decrease the speed of the top pullhead, thereby controlling the fiber diameter. The temperature of the molten zone is recorded by an infrared optical pyrometer that is connected to the main power supply through a computer controller, and the controller sets the temperature of the molten zone and maintains it at the desired value. A magnified image of the molten zone is monitored on an external viewing screen during fiber growth with the positions of the upper and lower interfaces of the molten zone marked on the screen and kept there by external control.

The workstation is equipped with a vacuum chamber for growing materials prone to oxidation. For all nonoxide experiments, ultrapure argon gettered to 1 ppm oxygen is used to backfill the chamber to atmospheric pressure. A mechanical roughing pump and a high-speed turbopump can supply a vacuum of  $4 \times 10^{-5}$  torr.

## Growing Crystals

### Preliminary Evaluations

To minimize the number of materials to be investigated as potential high-temperature composite reinforcements, we first evaluate the constituents of the candidate fibers. This exercise weeds out many systems that would have only a small chance for success. Critical information includes crystal structure, vaporization rate, potential strength, density, thermal conductivity, coefficient of thermal expansion, and growth feasibility as estimated by phase diagram inspection.

Physical property data and phase diagrams are indispensable tools in the LFZ process. They suggest the starting compositions of the feedrods and give useful information. Phase diagram inspection facilitates experimental tailoring to specific circumstances. The most desirable feedrod materials from a crystal-growth viewpoint are congruently melting materials, such as simple compounds like  $\text{Al}_2\text{O}_3$ ; line compounds; and eutectics, like  $\text{Al}_2\text{O}_3$ - $\text{Y}_2\text{O}_3$  eutectic (ref. 14).

Paper studies in and of themselves, however, are not sufficient to identify promising fiber systems. The LFZ system can quickly evaluate fiber materials—up to two compositions in an 8-hr day.

### Sintering Prior to Growth

We have found that prior to final crystal growth, it is advantageous to sinter the extruded powder feedrod in situ in the LFZ system. The resultant higher density feedrods provide much greater control of the diameter of the fiber coming out of the molten zone and better surface finish since there are no collapsing air pockets to cause the molten zone to vacillate.

Fiber tensile strength also improves because the internal and external voids that promote crack initiation (ref. 15) are eliminated. The sintering process involves moving the feedrod through the laser area at about 0.8 of the fiber material's melting temperature.

### Seeding a Crystal

The seeding of a single crystal—joining a feedrod to a crystal via a molten zone (figs. 12 and 13)—may produce a crystal with the same orientation as the seed. Single-crystal seeds are seated in a goniometer (fig. 12) and then oriented by x-ray diffraction techniques to produce the optimum orientation for strength (ref. 16). Once oriented, the goniometer is affixed to one of the pullheads, and the feedrod is affixed to the other (figs. 9 and 12). The seed and feedrod are slowly and simultaneously brought together into the scanned laser beams until the molten tips on both touch and wet each other to form a stable molten zone (figs. 14). Once the equilibrium molten zone with its uniform temperature profile is established, crystal growth with a flat molten-solid interface at the seed can begin. To maintain a constant volume, it is necessary to keep the speed with which the seed is withdrawn from the molten zone and the rate at which the feedrod is introduced into the molten zone at a fixed ratio (ref. 16). Even partial solidification of the molten zone during growth causes the final crystal to deviate from the desired orientation.

It may be necessary to obtain a single crystal from a polycrystalline feedrod when no seed is available. This is done by attenuating the molten zone and producing such a small-diameter crystal that only one grain can pass through at a time. After this condition has equilibrated, the molten zone can be increased with a subsequent increase in fiber diameter. With this method, the orientation of the single crystal is not controlled. The single crystal must be x-rayed and oriented to control the seeding of the fibers.

### Growth Conditions

Growing a crystal by the LFZ technique is a dynamic process that is currently more of an art than a science. Adjustments must be continually made while paying attention to several key parameters. Process variables include growth atmosphere, direction of growth, crystallographic orientation, attenuation ratio (which affects the melt-surface-area to melt-volume ratio), growth rate, energy density, angle of beams relative to the molten zone, and multiple melts (ref. 7). The most significant of these parameters is the melt-height to crystal-diameter (HTCD) ratio (fig. 14). This ratio changes as the volumetric flow rate, the attenuation ratio, or the melt temperature changes. However, once a steady-state condition is reached, it may be perpetuated by maintaining the HTCD ratio. We have determined empirically that adjusting laser power to maintain a constant HTCD ratio between 1 and 1.5 helps to control fiber

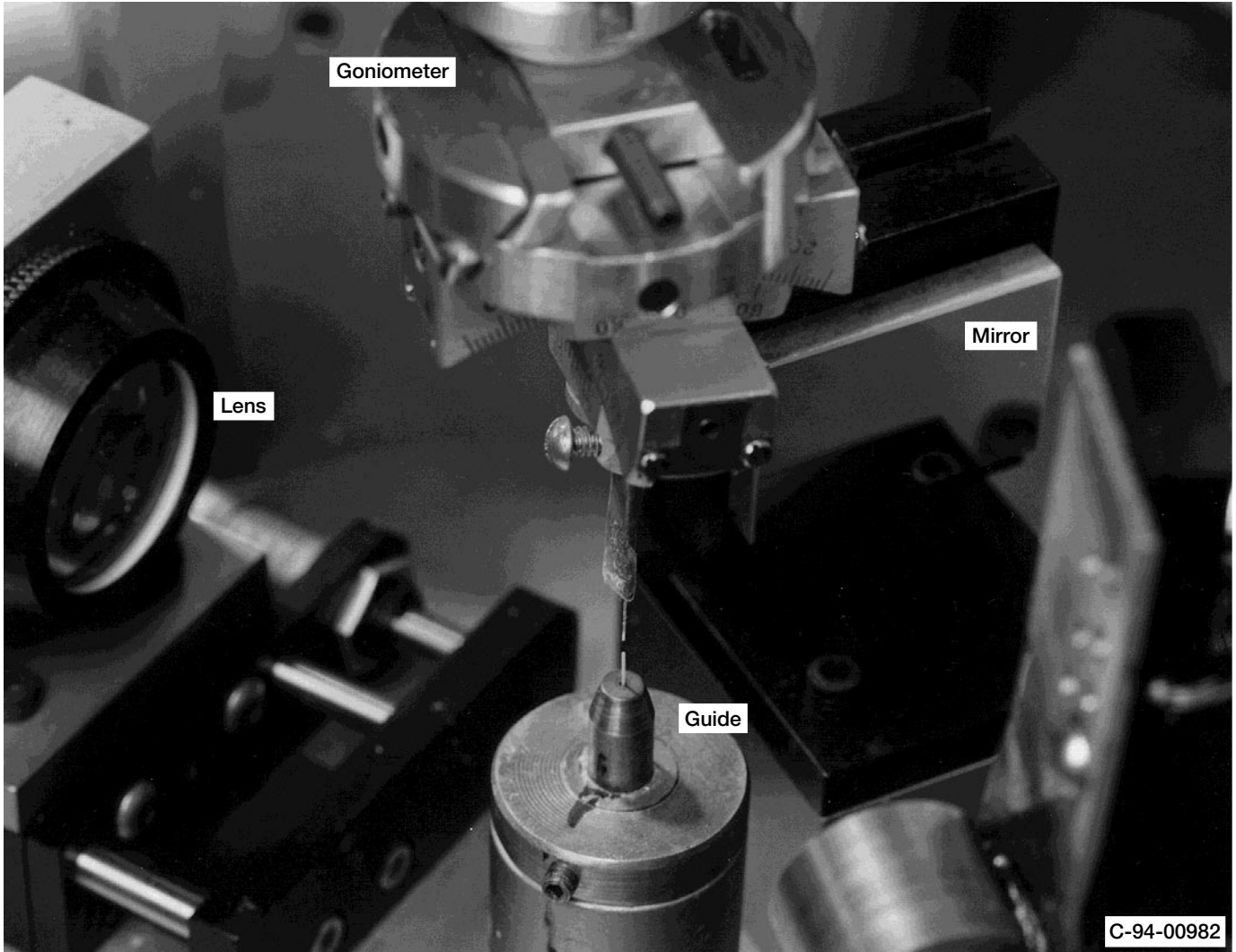

Figure 12.—The seed crystal is perfectly oriented using the goniometer. The feedrod is fed through the close tolerance guide. Also shown are a mirror and a lens that help focus the laser.

uniformity (fig. 4). During fiber growth, surface tension forces are exerted on the molten zone by both the feedrod and the fiber, with the feedrod forces dominating because of the feedrod's larger diameter. An HTCD of 1.5 appears to optimally balance these forces, causing all of the interfaces bounding the melt to be straight. This minimizes inflections in the melt and improves the fiber surface quality and, thus, mechanical properties. Monitoring the top and bottom melt interfaces to keep them flat also helps control the molten zone temperature.

The growth speed and thermal conductivity of the material control the temperature gradient in the feedrod and crystal as growth occurs. Conductivity through the solidified fiber flattens out the solid/liquid interface and usually produces a more perfect crystal. If the thermal gradient is shallow because of lower material conductivity, the crystal is instantaneously "quenched" as it leaves the molten zone, causing higher residual stresses. A different effect occurs in the feedrod. As the

feedrod decreases in temperature away from the melt, the powders change from highly sintered solids to loosely bonded powders, and eventually to loose powders that are hot enough to drive off the binder material but not hot enough to be sintered. This weak area, which contains unsintered powders without any binder, is a likely site where the feedrod may fail. In this regard, materials with high thermal conductivities have larger weak areas and are more difficult to work with than materials with low thermal conductivities. Fast growth is advantageous because the time that a material is in the molten zone is shortened and vaporization is minimized. Obviously, there are optimum experimental conditions that give the best results for each specific system.

The stability of the molten zone is a critical factor in the quality of the fiber surface. As was discussed earlier, the laser beams impinge on the fiber from opposite sides and have linear line scans that are made possible by the laser reflection from

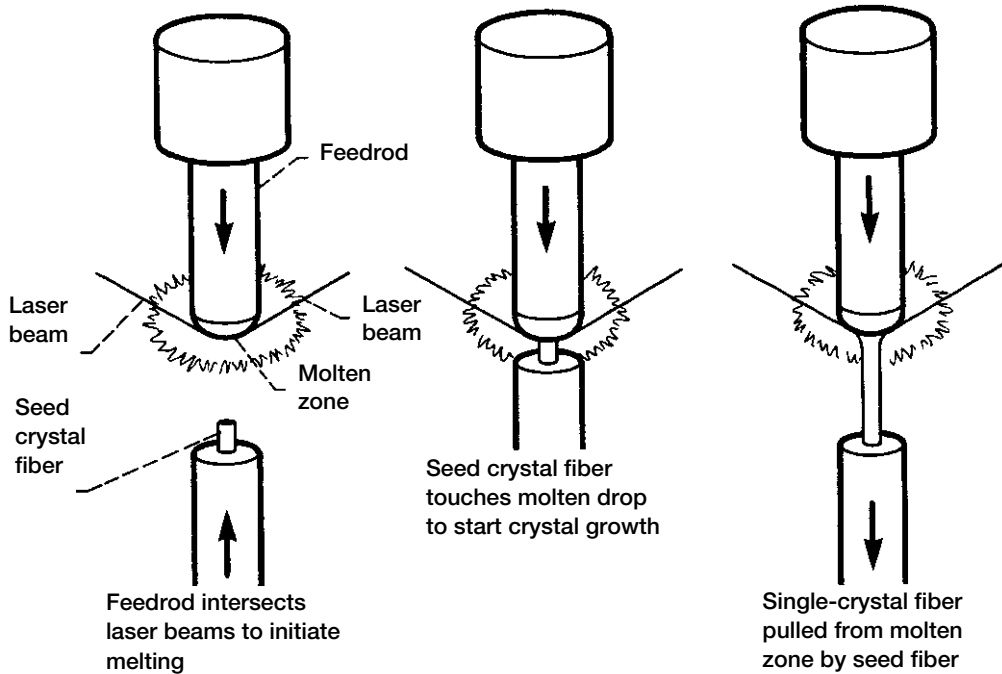

Figure 13.—Crystal seeding process.

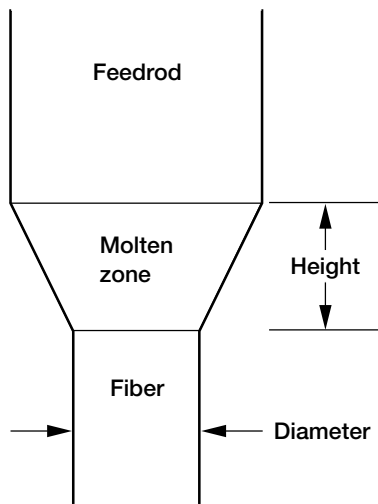

Figure 14.—Because the motion of the two motors is controlled independently, the fibers can be attenuated from the larger feedrod diameter by using motor speed ratios such as 2:1 or 3:1. The height to diameter ratio is defined as the height of the molten zone to the diameter of the fiber.

the cams modulating the melt (fig. 8). The frequency of the scan directly affects the stability of the molten zone by introducing even heating. Changing this frequency usually remedies fluctuations in this zone and crystal vibrations. Lower frequencies tend to eliminate voids more efficiently but at the expense of a stable zone. However, there is an optimum scan frequency to ameliorate both problems, usually around 30 to 50 cycles/sec.

The alternative to modulating the melt is to use fixed laser beams, which produce localized superheating in the molten zone. The cooler areas between the localized hot spots allow bubbles to follow the low-temperature paths described by arrows in figure 15. The bubbles are carried along with the material flowing upward from the feedrod to the crystal. In addition, growing crystals in the downward direction forces the bubbles to concentrate at the feedrod/molten zone interface, especially when static laser beams are used (ref. 5).

The line-scan frequency shakes out and eliminates bubbles in the molten zone (fig. 16). Figure 16 shows an actual feedrod/molten zone/fiber progression that was frozen in place by spontaneously removing the laser power. Figure 16(a), which was created using opposing static beams, shows that the void pockets (or bubbles) that are prevalent in the feedrod portion coalesce into one large void. When this void breaks through the melt wall, it disturbs uniform fiber growth. As shown in figure 16(b), melt modulation significantly helps to eliminate voids in the molten zone. The number of voids is reduced by a uniform temperature within the melt, which is produced by balanced thermal mixing, and a wide heat-affected zone caused by melt modulation (ref. 13).



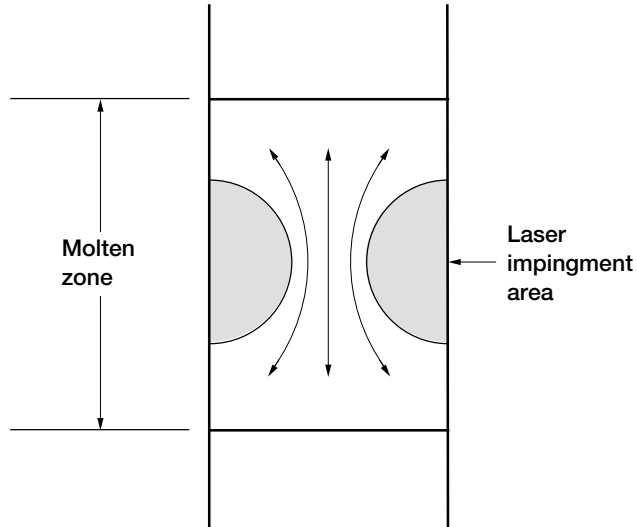

Figure 15.—Enlarged representation of the molten zone when opposing fixed laser beams are used to create the melt. This condition gives unequal heating and allows bubbles to exist and move along the paths indicated by the arrows.

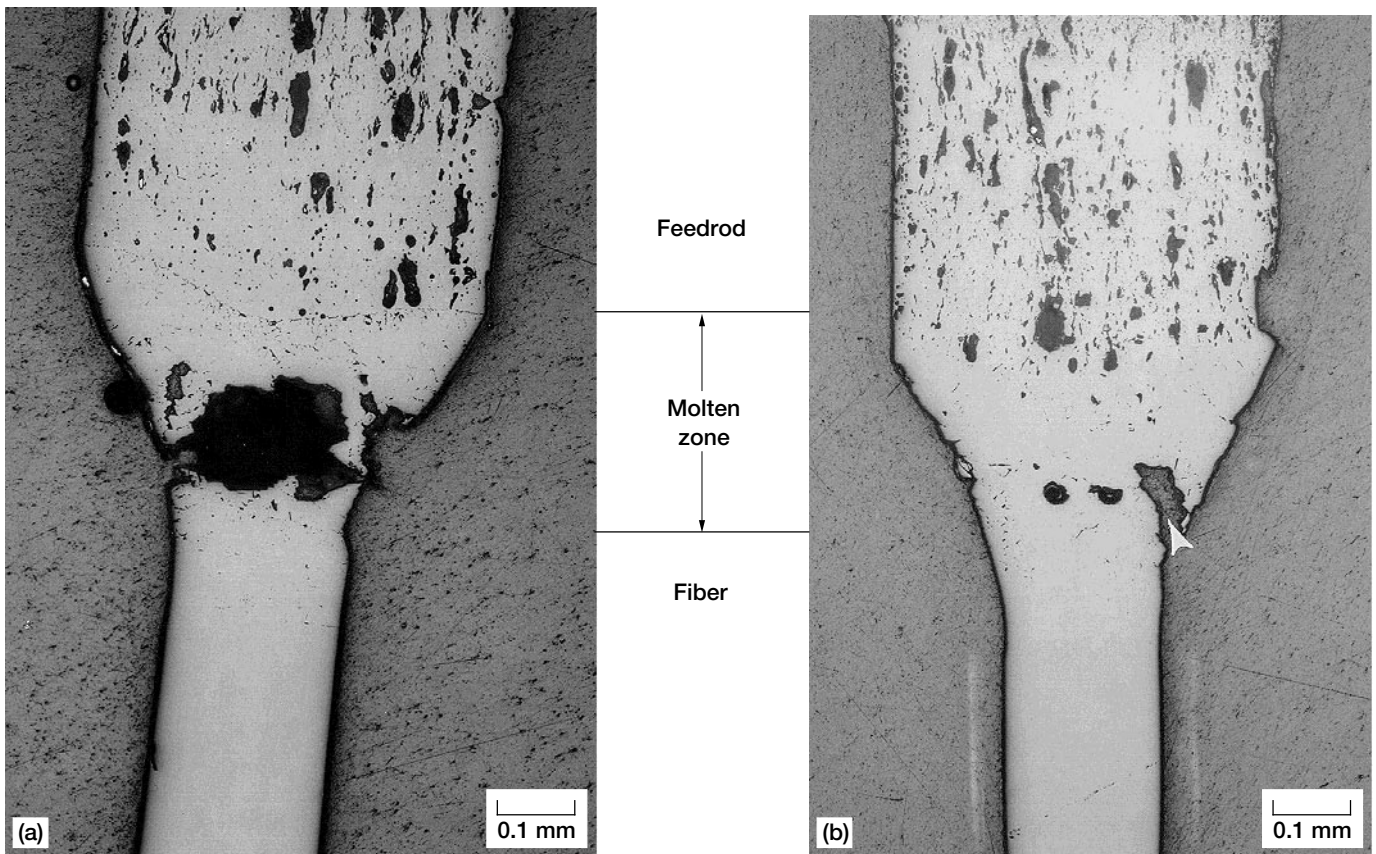

Figure 16.—Cross section of a feedrod/molten zone/fiber that was frozen into place during growth. (a) The molten zone was created by static laser beams that allowed voids in the feedrod to coalesce into a large void. (b) Melt modulation virtually eliminated the voids at the feedrod/molten zone interface. The arrow indicates a gap created during metallographic preparation; this is not a void.

Another problem is excess liquid in the molten zone. This can occur when the laser power increases. As the volume of liquid increases, the surface tension increases and surpasses a critical value that can balance the adhesion to the single crystal. When this happens, the growth no longer remains constant and a break occurs at the weakest liquid-solid interface, which usually is the single crystal. This is referred to as “balling up”

because a large amount of liquid begins to “wick” up the fiber until the melt breaks off and forms a ball-like shape on top of the feedrod (fig. 17).

Another dynamic surface effect occurs from a change in the molten zone shape during crystal growth. Figure 18 shows how power fluctuations and changes in the volume of the melt may cause surface imperfections (ref. 16). These perturbations,

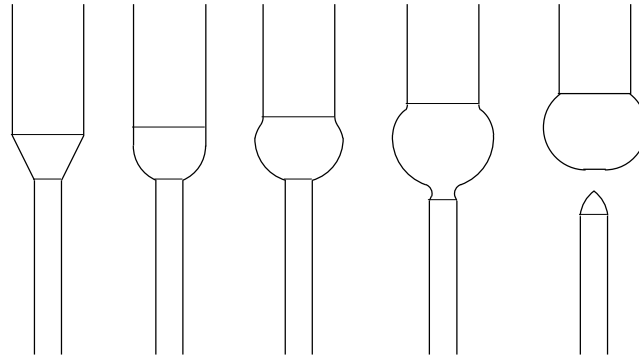

Figure 17.—As the superheating in the molten zone increases and the molten-zone-height to crystal-diameter ratio exceeds 1.5, the edge of the melt bends and surface tension causes it to “break.”

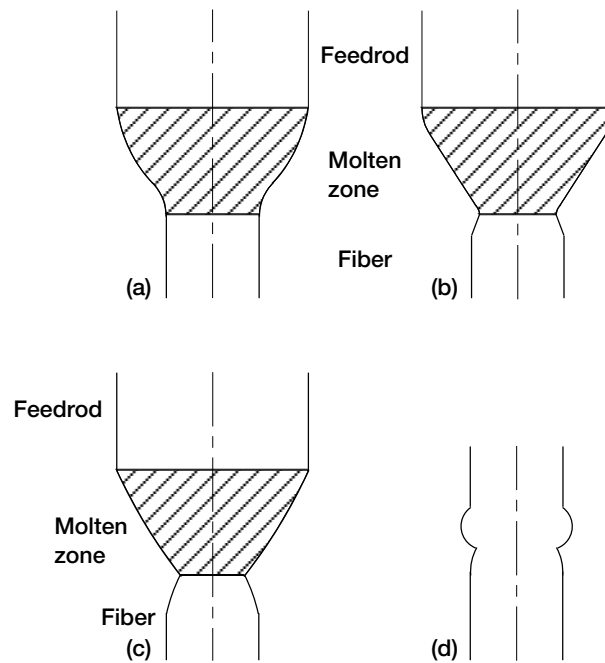

Figure 18.—Any fluctuation in the molten zone during growth translates into an imperfection in the fiber that is drawn out, as exhibited in the progression from (a) to (d).



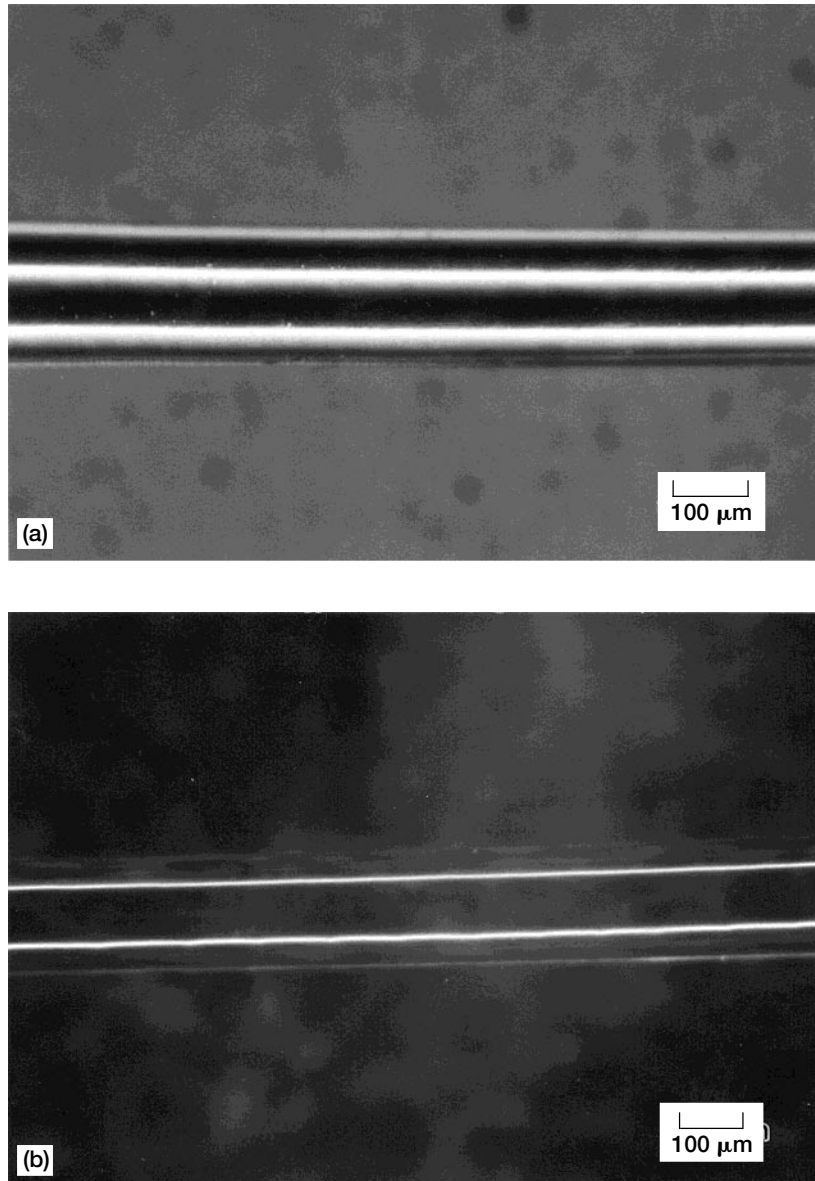

Figure 19.—Representative micrographs of fibers that are considered to have good surface quality. (a)  $\text{CrB}_2$  metallic fiber. (b)  $\text{ZrO}_2\text{-Y}_2\text{O}_3$  ceramic fiber.

however, tend to damp out rapidly if the molten zone height remains constant (ref. 2). Figure 19 shows examples of the desired fiber finish.

## Conclusions

The laser float zone (LFZ) process for growing single-crystal fibers has matured over the last several years. The development of extruded powder feedrod in lengths of about 17 cm has resulted

in the timely investigation of many fiber compositions—up to two compositions in an 8-hr day. In this regard, the LFZ process has been developed into a quick, extremely useful laboratory process to investigate the feasibility of using candidate materials for high-temperature, single-crystal fibers. Currently, strong fibers are being grown under very stable, promising conditions. Continued success in this area will produce oriented, small-diameter crystals that meet the requirements for high-temperature applications in today's advanced matrices.

## References

1. Stacey, M.H.: Production and Characterization of Fibers for Metal Matrix Composites. *Mater. Sci. T.*, vol. 4, no. 3, Mar. 1988.
2. Haggerty, J.S.; and Menashi, W.P.: Production of Oxide Fibers by a Floating Zone Fiber Drawing Technique. NASA CR-72811, 1971.
3. Stephens, J.R.: Composites Boost 21st-Century Aircraft Engines. *Adv. Mater. Process.*, vol. 137, Apr. 1990, pp. 35–38.
4. Feigelson, R.S.: Growth of Single Crystal Fibers. *MRS Bulletin*, Oct. 1988.
5. Haggerty, J.S.; and Wills, K.C.; and Sheehan, J.E.: Growth and Properties of Single Crystal Oxide Fibers. Proceedings of the 15th Annual Conference on Composites and Advanced Ceramic Materials, *Ceram. Eng. Sci. Proc.*, vol. 12, 1991, pp. 1785–1801.
6. Schmid, E.: Beiträge Zur Physik Und Metallographie Des Magnesiums. *Ztschr. Elektrochem.*, vol. 37, 1931, p. 447.
7. Haggerty, J.S.: Production of Fibers by a Floating Zone Fiber Drawing Technique. NASA CR-120948, 1972.
8. Sayir, H.; Sayir, A.; and Lagerlof, K.P.D.: Temperature Dependent Brittle Fracture of Undoped and Impurity Doped Sapphire Fibers. *Ceram. Eng. Sci. Proc.*, 1993, pp. 581–590.
9. McClellan, K.J., et al.: High-Strength, Creep-Resistant  $Y_2O_3$ -Stabilized Cubic  $ZrO_2$  Single Crystal Fibers. *Ceram. Eng. Sci. Proc.*, 1993, pp. 651–660.
10. Farmer, S.C.; Sayir, A.; and Dickerson, P.O.: Mechanical and Microstructural Characterization of Directionally Solidified Alumina-Zirconia Eutectic Fibers. Symposium Proceedings of In-Situ Composites Science and Technology, Minerals, Metals & Materials Society, Warrendale, PA, 1993, pp. 167–182.
11. Feigelson, R.S.: Pulling Optical Fibers. *J. Cryst. Growth*, vol. 79, no. 1–3, Dec. 1986, pp. 669–680.
12. Elwell, D.; Kway, W.L.; and Feigelson, R.S.: Crystal Growth of a New Tetragonal Phase of  $ScTaO_4$ . *J. Cryst. Growth*, vol. 71, Jan.-Feb. 1985, pp. 237–239.
13. Penn, W.: Improvements to the Laser Float Zone Process. Fifth Quarter Report. Contract NAS3-25944, Penn Laboratories, Cartersville, GA, June 1991.
14. Levin, E.M.; Robbins, C.R.; and McMurdie, H.F.: Phase Diagrams for Ceramists. M.K. Reser, ed., The American Ceramic Society, Columbus, OH, 1964.
15. Griffith, A.A.: The Phenomena of Rupture and Flow in Solids. *Roy. Soc., Phil. Trans.*, 1920, pp. 163–198.
16. Hohn, F.J., et al.: Fabrication and Testing of Single-Crystal Lanthanum Hexaboride Rod Cathodes. *J. Appl. Phys.*, vol. 53, no. 3, Mar. 1982.

**REPORT DOCUMENTATION PAGE**Form Approved  
OMB No. 0704-0188

Public reporting burden for this collection of information is estimated to average 1 hour per response, including the time for reviewing instructions, searching existing data sources, gathering and maintaining the data needed, and completing and reviewing the collection of information. Send comments regarding this burden estimate or any other aspect of this collection of information, including suggestions for reducing this burden, to Washington Headquarters Services, Directorate for Information Operations and Reports, 1215 Jefferson Davis Highway, Suite 1204, Arlington, VA 22202-4302, and to the Office of Management and Budget, Paperwork Reduction Project (0704-0188), Washington, DC 20503.

<b>1. AGENCY USE ONLY (Leave blank)</b>		<b>2. REPORT DATE</b> January 1996	<b>3. REPORT TYPE AND DATES COVERED</b> Technical Memorandum	
<b>4. TITLE AND SUBTITLE</b>  Laser-Heated Floating Zone Production of Single-Crystal Fibers			<b>5. FUNDING NUMBERS</b>  WU-505-63-12	
<b>6. AUTHOR(S)</b>  Frank Ritzert and Leonard Westfall				
<b>7. PERFORMING ORGANIZATION NAME(S) AND ADDRESS(ES)</b>  National Aeronautics and Space Administration Lewis Research Center Cleveland, Ohio 44135-3191			<b>8. PERFORMING ORGANIZATION REPORT NUMBER</b>  E-9832	
<b>9. SPONSORING/MONITORING AGENCY NAME(S) AND ADDRESS(ES)</b>  National Aeronautics and Space Administration Washington, D.C. 20546-0001			<b>10. SPONSORING/MONITORING AGENCY REPORT NUMBER</b>  NASA TM-4732	
<b>11. SUPPLEMENTARY NOTES</b>  Responsible person, Frank Ritzert, organization code 5120, (216) 433-8199.				
<b>12a. DISTRIBUTION/AVAILABILITY STATEMENT</b>  Unclassified - Unlimited Subject Category 26  This publication is available from the NASA Center for Aerospace Information, (301) 621-0390.			<b>12b. DISTRIBUTION CODE</b>	
<b>13. ABSTRACT (Maximum 200 words)</b>  This report describes how a laser-heated floating zone apparatus can be used to investigate single-crystal fibers of various compositions. A feedrod with a stoichiometric composition of high-purity powders was connected to a pedestal and fed into a laser scan where it combined with a single-crystal fiber seed. A molten zone was formed at this junction. As the feedrod was continuously fed into the laser scan, a single-crystal fiber of a prescribed orientation was withdrawn from the melt. The resultant fibers, whose diameters ranged from 100 to 250 $\mu\text{m}$ , could then be evaluated on the basis of their growth behavior, physical properties, mechanical properties, and fiber perfection.				
<b>14. SUBJECT TERMS</b>  Fabrication; Fibers; Crystal growth			<b>15. NUMBER OF PAGES</b> 18	
			<b>16. PRICE CODE</b> A03	
<b>17. SECURITY CLASSIFICATION OF REPORT</b> Unclassified	<b>18. SECURITY CLASSIFICATION OF THIS PAGE</b> Unclassified	<b>19. SECURITY CLASSIFICATION OF ABSTRACT</b> Unclassified	<b>20. LIMITATION OF ABSTRACT</b>	