

CR-51132

12-95/06-5087-03-7821-000  
Contract # NAS8-39383

FINAL  
11-32-  
2000  
60677

**EMERGENCY VEHICLE  
ALERT SYSTEM (EVAS)**

**FINAL REPORT**

**Prepared for:  
ATTN: Ms. Phyllis Smith  
NASA/MSFC**

**Prepared by:  
SAIC  
Roger Crump  
Warren Harper  
Krishna Myneni  
Bill Reed**

**December 31, 1995**



**Science Applications International Corporation**  
6725 Odyssey Drive, Huntsville, AL 35806-3301 • (205) 971-6400

**EMERGENCY VEHICLE  
ALERT SYSTEM (EVAS)**

**FINAL REPORT**

**Prepared for:  
ATTN: Ms. Phyllis Smith  
NASA/MSFC**

**Prepared by:  
SAIC  
Roger Crump  
Warren Harper  
Krishna Myneni  
Bill Reed**

**December 31, 1995**

## TABLE OF CONTENTS

<u>SECTION NO.</u>		<u>PAGE NO.</u>
1.0	INTRODUCTION.....	1
2.0	SUMMARY OF EVAS PROGRAM.....	1
3.0	MICROCONTROLLER DEVELOPMENT, ANTENNA REFINEMENTS AND PACKAGING (SOW TASK 4).....	2
3.1	Microcontroller for Personal Vehicle.....	4
3.2	Antenna Power Upgrade for Transmitter (EV).....	4
3.3	Re-packaging of Receiver Electronics and Antenna .....	8
3.4	Re-packaging of Transmitter Electronics and Antenna .....	11
4.0	RE-DIRECTION OF EVAS PROGRAM.....	11
4.1	Spread Spectrum Modem Selection and Analysis.....	13
4.2	Laboratory Testing and System Evaluation .....	14
4.3	Software for System Tests.....	18
4.4	System Testing .....	19
5.0	CONCLUSIONS .....	25
	REFERENCES .....	26

## LIST OF FIGURES

<u>FIGURE NO.</u>	<u>PAGE NO.</u>
3.0-1	EVAS System Phase 4 Concepts for PV and EV.....3
3.1-1	EVAS Real-Time Display.....5
3.1-2	EVAS Receiver Schematic.....6
3.1-3	EVAS Receiver PCB Layout.....7
3.2-1	EVAS Transmitter PCB Layout.....9
3.2-2	Tx Antenna Power Upgrade.....10
3.4-1	EVAS Transmitter Schematic.....12
4.2-1	Byte Error Rate vs. Input Power.....15
4.2-2	Data Transmission Test site .....15
4.2-3	Open Field Test Site on Redstone Arsenal.....16
4.2-4	Research Park Test Route .....16
4.2-5	Received Bytes/Sec in Research Park Test.....17
4.3-1	EVAS Display Emblems.....18
4.4-1	Approximate AGC Level Calibration Based on Data Provided by GRE America.....20
4.4-2	Test #1, Tx Colocated.....21
4.4-3	Composite Record of Signal Strength vs. Time for EVAS Test #1.....22
4.4-4	Test #2, EV Transmitters Separated .....23
4.4-5	Signal Strength Record for EVAS Test #2 .....24

## LIST OF TABLES

<u>TABLE NO.</u>	<u>PAGE NO.</u>
3.1-1	Range Indicator LEDs.....4
4.1-1	STI SD5510/V Modem Specifications.....13
4.3-1	Transmitter Message Format .....18

## 1.0 INTRODUCTION

The Emergency Vehicle Alert System (EVAS) program is sponsored by the NASA/MSFC Technology Utilization (TU) office. The program was conceived to support the needs of hearing impaired drivers. Gallaudet Research Institute is responsible for bringing the problem to the attention of NASA. The objective of the program is to develop a low-cost, small device which can be located in a personal vehicle and warn the driver, via a visual means, of the approach of an emergency vehicle. Many different technologies might be developed for this purpose and each has its own advantages and drawbacks.

A device which detects the sound of the siren from an emergency vehicle is attractive because it only requires a system in the personal vehicle, i.e. there are no modifications needed for the emergency vehicle. The requirements for an acoustic detection system, however, appear to be pretty stringent and may not allow the development of a reliable, low-cost device in the near future. The problems include variations in the sirens between various types of emergency vehicles, distortions due to wind and surrounding objects, competing background noise, sophisticated signal processing requirements, and omni-directional coverage requirements.

Another approach is to use a Radio Frequency (RF) signal between the Emergency Vehicle (EV) and the Personal Vehicle (PV). This approach requires a transmitter on each EV and a receiver in each PV, however it is virtually assured that a system can be developed which works. With this approach, the real technology issue is how to make a system work as inexpensively as possible. MSFC directed the use of RF during this development.

The EVAS program has been funded in four major program increments. These phases can be briefly described as follows:

- Phase 1: Concept Development, Analysis, Preliminary Design
- Phase 2: Development of Coded Antenna Approach, Lab Hardware Development
- Phase 3: Prototype Hardware Development, Field Testing
- Phase 4: PV Microcontroller Development, System Upgrades and Packaging

This report gives a brief summary of the EVAS program from its inception and concentrates on describing the activities that occurred during Phase 4. References 1-3 describe activities under Phases 1-3.

## 2.0 SUMMARY OF EVAS PROGRAM

The key requirements under which the EVAS program was developed are:

1. Detect an EV out to one-half a mile distance desired and one-fourth mile required.
2. Determine the location of the EV with respect to the PV within 90 degrees (Ahead, Behind, Left, Right).

The EVAS receiver system was also expected to operate without interference in the presence of multiple EVs and PVs, be physically small, easy to install, simple to understand and inexpensive. The EVAS transmitter also needs to be as simple, inexpensive and easy to install as possible.

The earliest recommendation for an RF system was to have in both the EV and the PV a microcontroller, compass and velocity readings and to broadcast the EV data, along with an ID tag, for any PV to receive. Each EV would be associated with a unique tag and a momentary time slice for transmission of data. With this paucity of data, it is impossible to know the direction of the EV from the PV. Both may be headed North, as indicated by the compass reading of each, however you do not know if the EV is in front of or behind the PV. Attempts to deal with these ambiguities were evaluated, including such schemes as noting the velocity reading of each vehicle, and the RF signal strengths and evaluating whether or not distances were closing or increasing to determine the relative vehicle locations. Because of the uncertainties associated with the RF signal strength measurements it was decided that compass headings, velocity readings, and signal strengths alone would not be reliable enough to determine relative vehicle locations.

In the second and third phase of the program a scheme using a coded antenna beam was developed for the EV. The purpose of the coded beam antenna is to provide unambiguous reference antenna patterns from which the EV can be located with respect to the PV. The idea was to transmit a signal from the EV which would be unique in a particular direction around the vehicle in a roughly circular fashion (0 to 360 degrees). This was done using a three element antenna, with the specific phasing requirements to generate a unique antenna pattern at roughly 60 degree increments around the EV. The PV then matched the received signal against a set of stored waveforms. The stored waveforms correspond to the unique EV direction being transmitted. The PV upon receipt of the EV signal would then be able to determine the direction by correct interpretation of the encoded received signal. This concept is straightforward and worked well except in the case of an indirect line of sight between the EV and the PV. This approach was developed and tested in the lab and with prototype hardware in field tests. As expected, the system worked very well under line of sight conditions and experienced some problems otherwise. The results of the lab and field tests are documented in References 2 and 3.

In the fourth phase of the program, the major effort to be expended was in development of the microcontroller system for the PV, refinement of some system elements and packaging for demonstration purposes. Up until this time, a laptop computer was used in the PV in place of the microcontroller. During the course of the Phase 4 effort, a review of the system status occurred and a decision was made to drop the direction determination part of the system. This decision was made because it was felt that a simple alert was adequate without a determination of direction. The device, it was also felt, may have broad appeal to the general public and it made sense to make it as cost effective and simple as possible. A revised Scope of Work (SOW) was received which re-directed the phase 4 efforts to drop the direction determination requirement and demonstrate a system with off the shelf hardware. An EVAS system was developed and demonstrated which used standard spread spectrum modems with minor modifications.

### **3.0 MICROCONTROLLER DEVELOPMENT, ANTENNA REFINEMENTS AND PACKAGING (SOW TASK 4)**

This section of the report documents the SOW Task 4 work which was performed before the EVAS task was re-directed. The Task 4 work consists of the development of a microcontroller for the PV, an upgrade to the Transmitter antenna power, and a re-packaging of the receiver electronics and antenna and transmitter electronics and antenna. One of the goals of the phase 4 effort was to develop a complete demonstration system consisting of the EVAS Receiver and the EVAS Transmitter. Figure 3.0-1 depicts conceptually what the

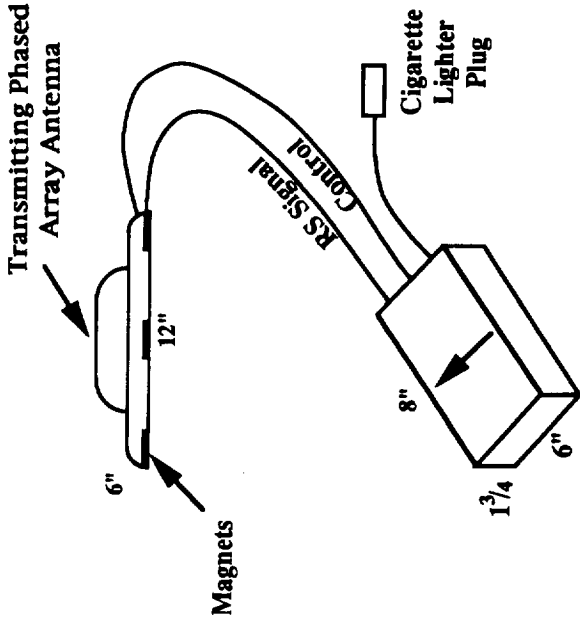

**TRANSMITTER IN  
EMERGENCY VEHICLE (EV)**

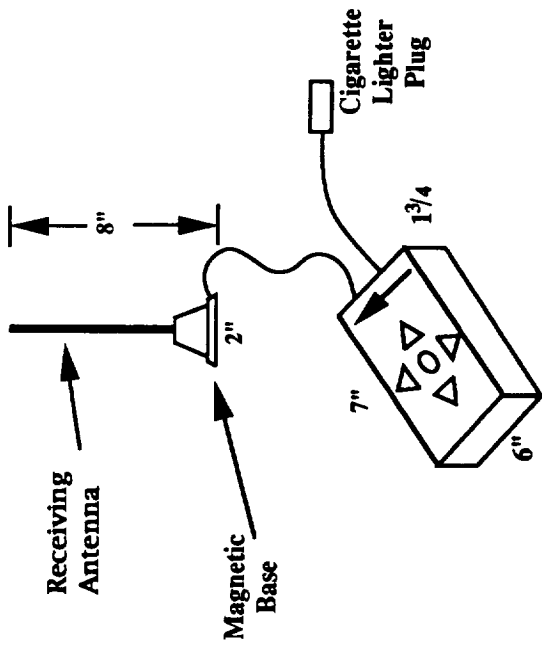

**RECEIVER IN  
PERSONAL VEHICLE (PV)**

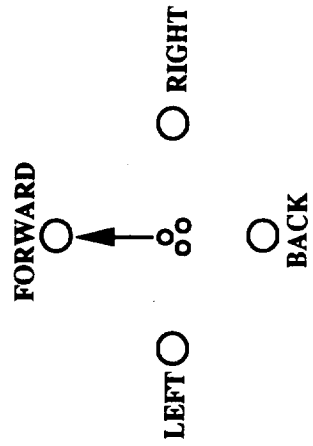

**PV DISPLAY**

final system might look like. The EVAS receiver and transmitter were both envisioned to be contained in relatively small packages with each having connections for antennas and power externally. The receiver, in addition, would have the desired display with warning lights.

### **3.1 MICROCONTROLLER FOR PERSONAL VEHICLE**

#### **Microcontroller**

A microcontroller design and schematic for the personal vehicle was developed under the Phase 4 task. The design combines the microcontroller circuit and spread spectrum receiver, designed under a previous phase, onto a single PC board. The microcontroller initializes the spread spectrum ASIC, reads the antenna patterns, signal level, and compass heading, and calculates and displays the emergency vehicle position. The design includes an LED user display and interface for a compass.

The microcontroller design was based on the Intel 87C196KD microcontroller. It contains 1 KB of internal RAM and 32 KB of internal one time programmable ROM (OTPROM). It also has five 8-bit I/O ports, a full duplex serial port, an internal watchdog timer, and a 10-bit A/D converter with sample and hold. The controller may be programmed using assembly language or C.

The display consists of four LEDs for direction display and a cluster of three LEDs for range display. The direction LEDs will light to show direction to the emergency vehicle. A center cluster of three different color LEDs will indicate the range to the EV, as shown in Table 3.1 -1. Figure 3.1-1 depicts the proposed arrangement of the LED display system to be used on the EVAS receiver.

**Table 3.1-1 Range Indicator LEDs**

Color	Range
Green	Far
Yellow	Near
Red	Very Near

A compass would interface to the microcontroller over the RS232 interface. The compass is a KVH model C100 provided by MSFC. Heading data from the compass will be used in EV direction determination. Figure 3.1-2 is the electrical schematic for the EVAS Receiver which contains the microcontroller and other related components. Figure 3.1-3 is the printed circuit board (PCB) layout for the EVAS receiver.

### **3.2 ANTENNA POWER UPGRADE FOR TRANSMITTER (EV)**

#### **Antenna Modifications**

##### **One Watt Power Amplifier**

The output power of the EVAS transmitter used in Phase 3 was limited by 250 mW amplifier modules. Part 15 of the FCC regulation allows up to 1 Watt of output power. At that time 1 Watt modules of reasonable cost were not available, while the 1/4 Watt modules



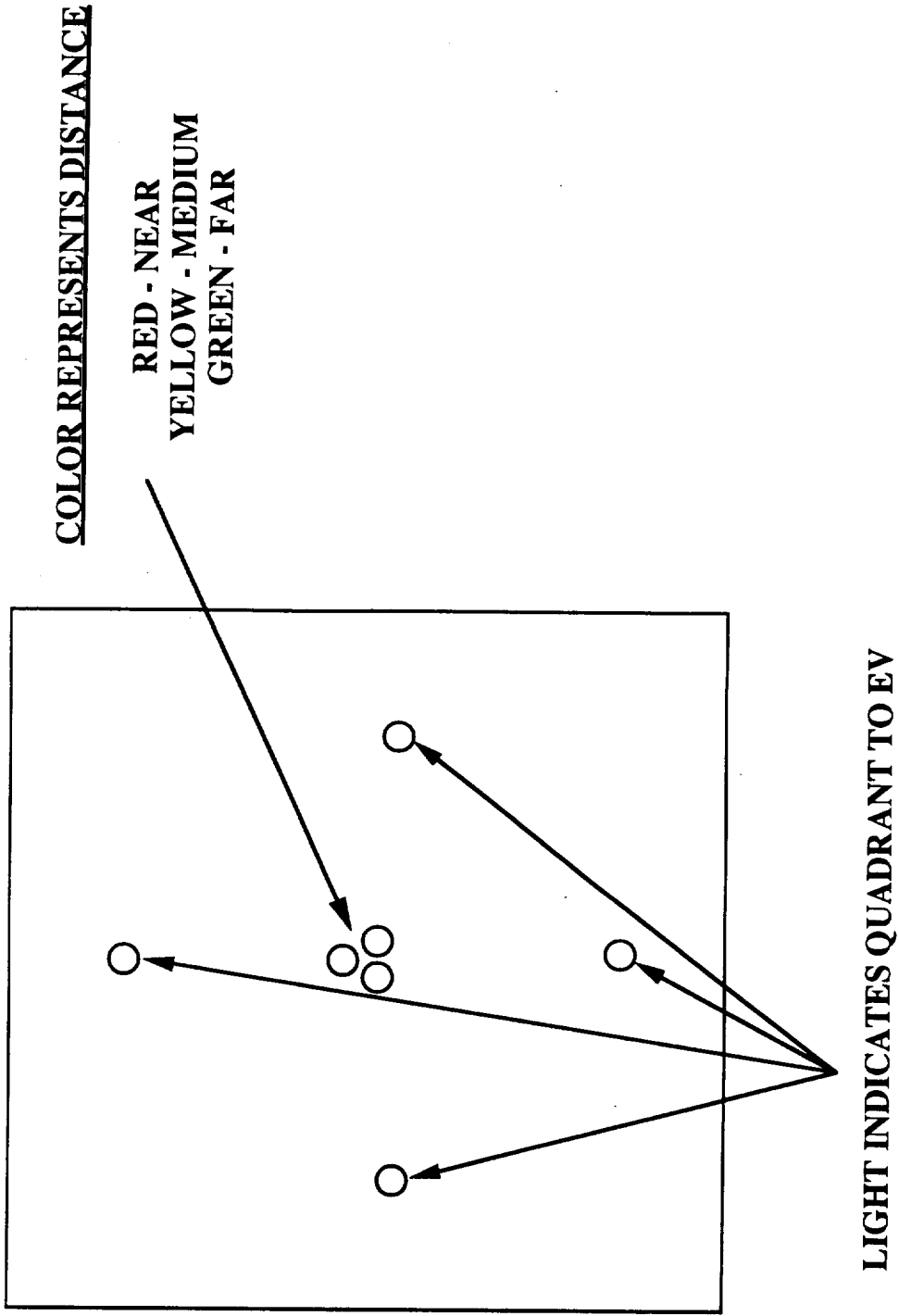

Figure 3.1-1 EVAS Real-Time Display

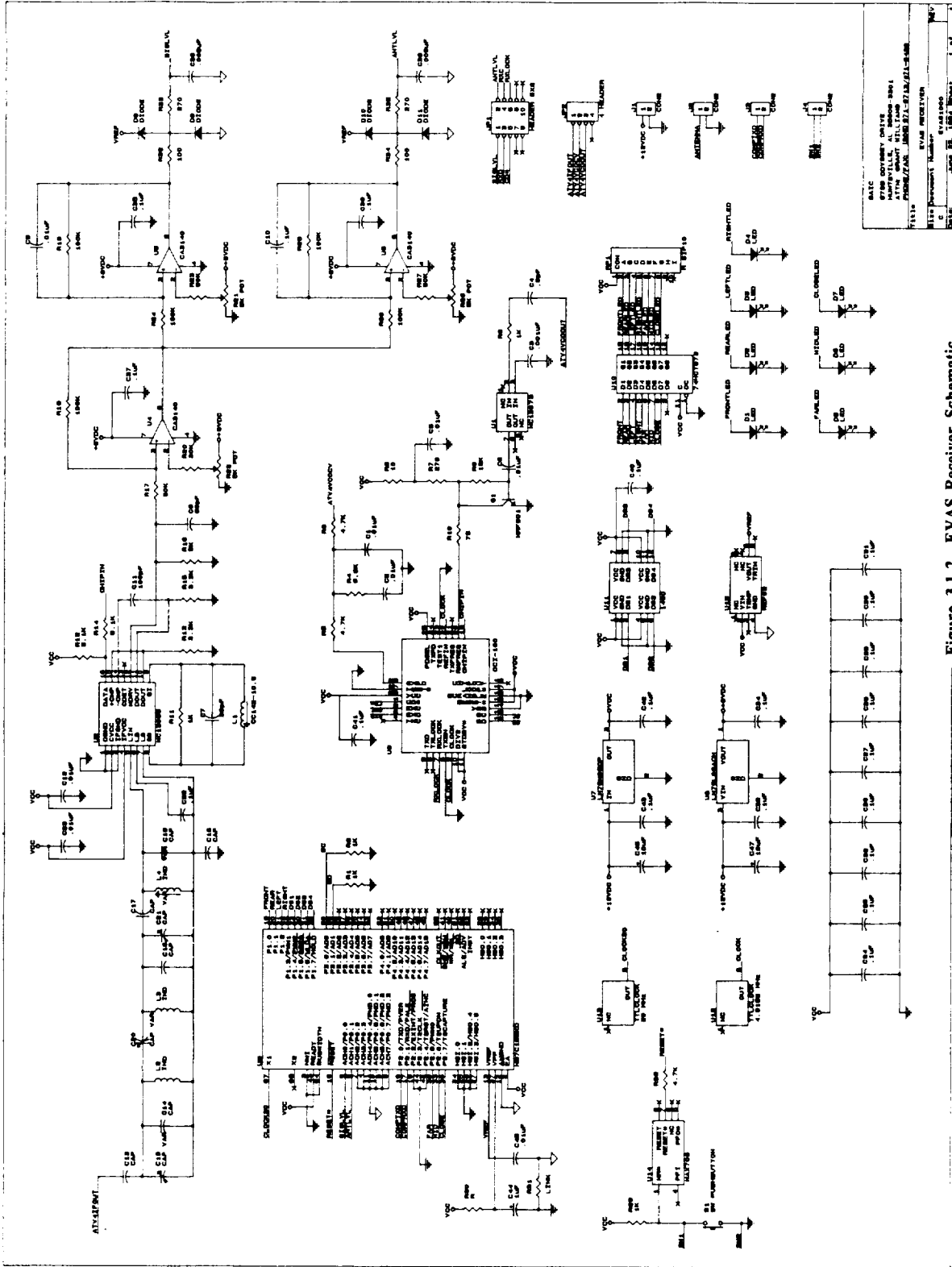
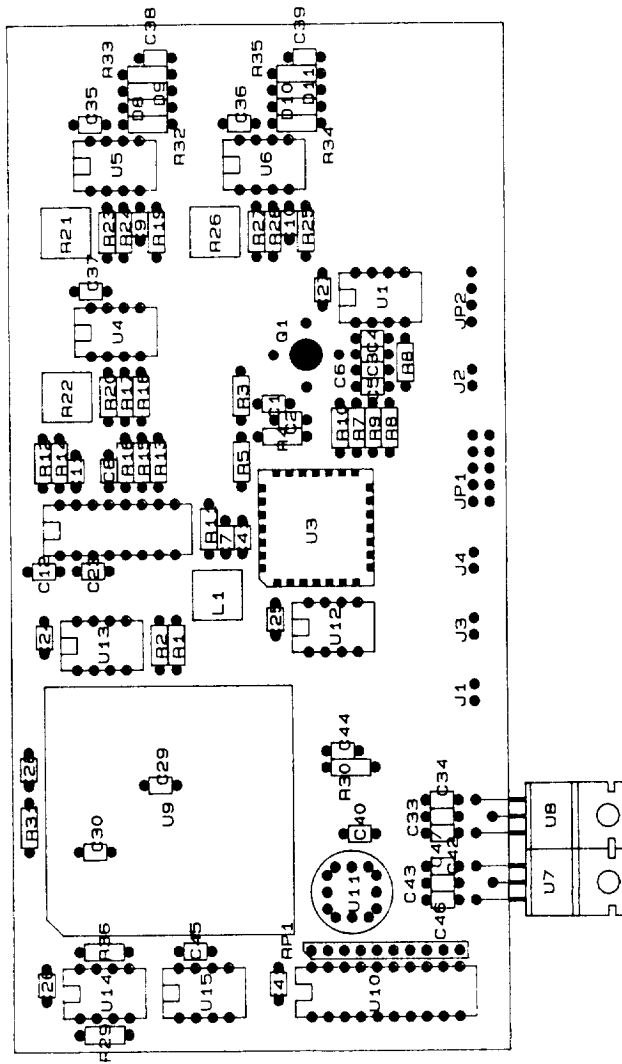

Figure 3.1-2 EVAS Receiver Schematic

6.2



3

SAIC 6725 ODYSSEY DRIVE HUNTSVILLE, AL 35806-3301 ATTN: GRANT WILLIAMS PHONE/FAX: (205) 971-6713/971-6428	
Title	EVAS RECEIVER LAYOUT
Size	Document Number
A	EVAS1005
Date	September 23, 1995
Sheet	of
REV	

Figure 3.1-3 EVAS Receiver PCB Layout

were available off-the-shelf at low cost --- therefore the 1/4 Watt modules were selected for use, at the expense of 6 dB in system performance. Since the Phase 3 task, there has been a proliferation of new modules to support the many FCC part 15 wireless devices that have come onto the market. There exist now several sources of readily available, low cost 1 Watt amplifiers. One part of the EVAS Phase 4 task was to upgrade the transmitter output to 1 Watt.

The Mitsubishi MGF7140 900 MHz Band Gallium Arsenide (GaAs) Power Amplifier Integrated Circuit was selected for evaluation since its physical and electrical characteristics would make it easy to incorporate into the transmitter amplifier. The power amplifier of the transmitter is fabricated on the printed circuit board of the Transmitting Assembly as shown in Figure 3.2-1 (EVAS Transmitter PCB layout). Figure 3.2-2a shows a block diagram of the present amplifier with an AMP0500 1/4 Watt amplifier as the output stage. In Figure 3.2-2b the AMP0520 has been replaced by the 1 Watt MGF7140.

Other additions include the LM317 regulator and MAX852 to produce 5.8 VDC and -2.5 VDC, and an 8.4 dB attenuator to account for the differences in output powers and amplifier gains. The modifications can be accomplished very easily since the physical dimensions of the MGF7140 will allow it to be placed in the same location as the AMP0520 when it is removed. A demonstration board with an MGF7140 was loaned to SAIC for test and evaluation. Testing with this board showed that the MGF7140 will meet our requirements with margin. Five power amplifiers, one for each dipole plus two spares, were procured and incorporated into the transmitter assembly.

### **3.3 RE-PACKAGING OF RECEIVER ELECTRONICS AND ANTENNA**

A microcontroller based system was envisioned for the PV from the inception of the program, however no prototype was built through the first three phases of the program. During testing and development, a portable computer was used to interface to a custom receiver. The portable computer was used to provide an interface to the receiver, and to process and display the emergency vehicle warnings. During this phase (4), a prototype microcontroller was to be developed and integrated into a complete EVAS receiver package. A single PC board was envisioned containing the microcontroller and receiver initially. The available compass (a KVH Model C100) was already on a PC board and would be placed in the same enclosure. During the development a small PC board mount compass became available. Some samples of this compass system was ordered for evaluation and potential integration into the EVAS receiver. The new PCB mount compass was designed into the circuit board, however evaluation was not complete at the time the task was re-directed.

Several different methods for implementation and display of the EV signal were considered. The information to be conveyed consisted of the detection of an EV, and the direction of location of the EV from the PV. Other information considered was relative data on how close an EV was to the PV (i.e. close, far or medium distance) and type of EV (fire, ambulance, police). There were also considerations given to the type of display to be used. Consideration was given to Liquid Crystal Displays (LCDs) and to Light Emitting Diodes (LEDs), ranging from alphanumeric to dot addressable graphics types. In the end, it was felt that simplicity would be the best approach for the prototype and an LED display was chosen which contained lights oriented in the compass directions (North, South, East, West) to indicate direction, and a separate set of lights to indicate distance to the EV. Figure 3.1-1 showed the LED configuration chosen for the EVAS receiver.

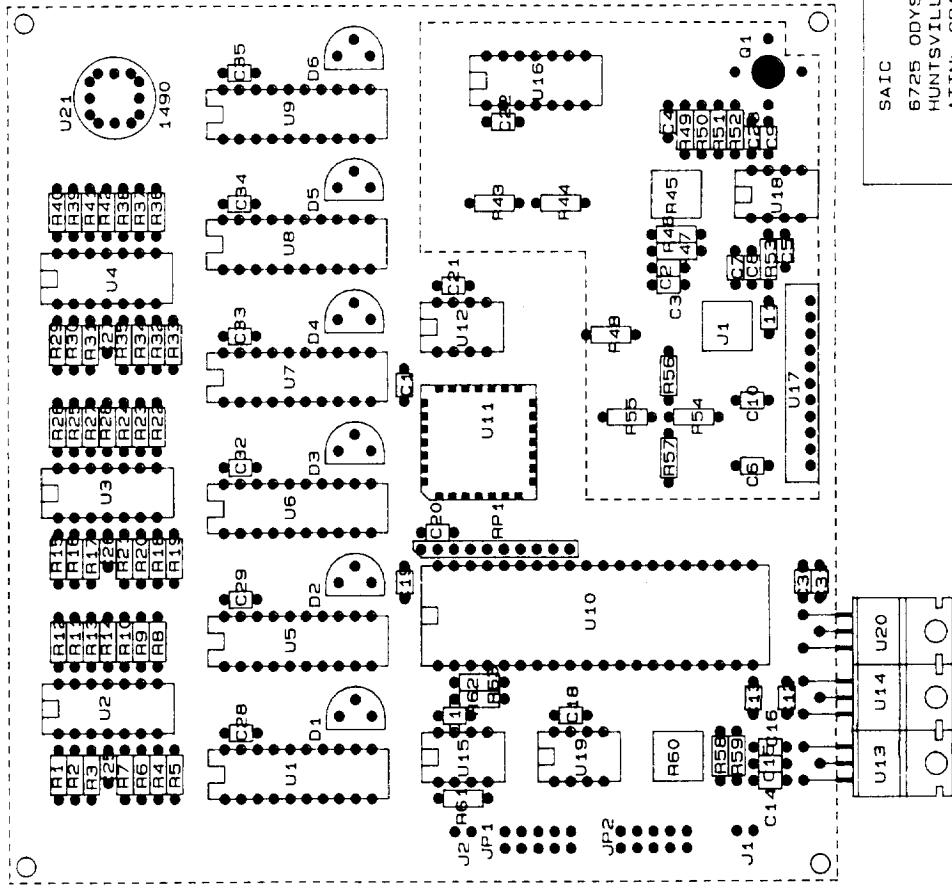

SAIC 6725 ODYSSEY DRIVE HUNTSVILLE, AL 35806-3301 ATTN: GRANT WILLIAMS PHONE/FAX: (205)971-6713/971-6428	
Title	EVAS TRANSMITTER LAYOUT
Size	Document Number
A	EVAS1045
Date	September 23, 1995
Sheet	of
	REV

Figure 3.2-1 EVAS Transmitter PCB Layout

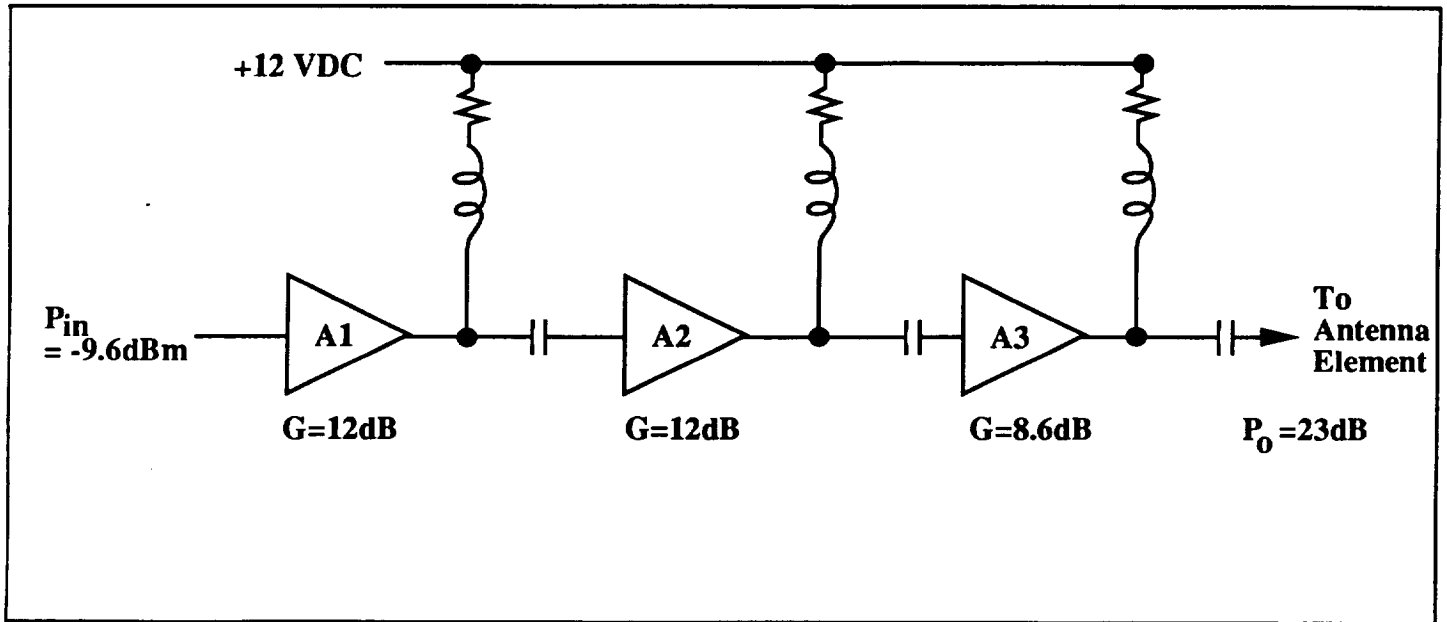

a. Present Amplifier Using a AMPO523 for A3, the Output Stage

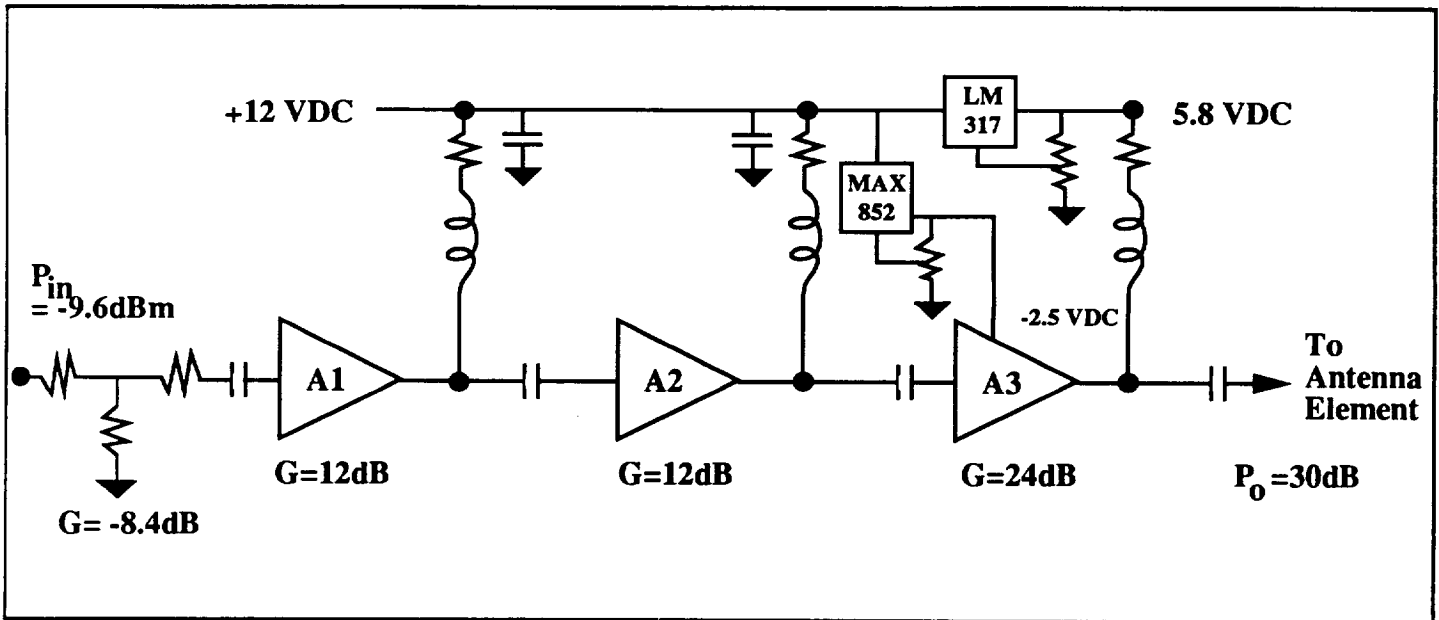

b. Modified Amplifier Using a MGF7140 for A3, the Output Stage

Figure 3.2-2 Tx Antenna Power Upgrade

The original EVAS receiver antenna used in phases 1-3 was a simple, omni directional dipole which was fabricated in the lab. During Phase 4, a review of the best approach for a new antenna for the receiver was undertaken. While a custom antenna could be built and packaged, it seemed most prudent to purchase an antenna for this frequency. The license-free frequency band around 915 Mhz has seen a broad development of various RF devices and a number of antennas are available for purchase. Several models from different manufacturers were tested. A model from Centurion was selected for the EVAS receiver antenna. The Centurion antenna contains a magnetic base making it convenient for EVAS purposes. The suitability of the Centurion antenna was tested at our operating frequency and it was found to be adequate.

The EVAS receiver design was essentially complete at the time of the re-direction. A final check and selection of the enclosure remained to be done.

### **3.4 RE-PACKAGING OF TRANSMITTER ELECTRONICS AND ANTENNA**

A design and schematic was developed to repackage the spread spectrum transmitter and antenna controller onto a single PCB. The design also allows the transmitter's microcontroller to read the compass heading along with vehicle identification and transmit these through the spread spectrum transmitter. The EV transmitter PCB will be housed with the directional antenna in a self contained unit with a connection for power. Previous design included the antenna control as part of the antenna to be mounted externally. For final demonstration purposes, the decision was made to combine as much of the electronics as was feasible into a single enclosure inside the vehicle. This unit would contain the connections for input power and for antenna control. Figure 3.4-1 is the schematic for the EVAS transmitter.

The EVAS phased array antenna developed in Phases 2 and 3 was planned to be repackaged into a smaller and more rugged enclosure. The EVAS antenna consists principally of a ground plane, the power and phasing circuits mounted on a printed circuit board, and the antenna elements. All of the existing antenna components were planned to be reused. The antenna PCB could be made smaller by removal of excess board space. The entire antenna was planned to be mounted in an RF transmitting enclosure, such as molded plastic, to be both weather resistant and allow securing to the top of a vehicle. Magnetic mounts were anticipated to hold the antenna to the vehicle. This concept is depicted in Figure 3.0-1. The EVAS Transmitting antenna was expected to be about a twelve inch diameter package approximately six inches tall.

## **4.0 RE-DIRECTION OF EVAS PROGRAM**

In July of 1994, a program status review was conducted at NASA/MSFC. During this presentation, questions relating to the direction determination part of the system were raised. These questions included the cost, the size and the benefits of the direction determination part of the system. It was decided at a later date to modify the existing SOW to remove the requirement for direction determination and to demonstrate through a visual display that several EVs could be detected at once without any interference or conflict issues. This served to greatly simplify the system, allowing for simplification of the transmitter, receiver and transmitting antenna. The transmitter and transmitting antenna now become as simple in concept as the receiver and can be implemented in a very small package. It is also reasonable to pursue the idea that the receiving antenna for the personal vehicle (PV) may be incorporated inside the enclosure, as is done with a garage door opener, for example. The concept became so simple that it was almost feasible to demonstrate the system with off the

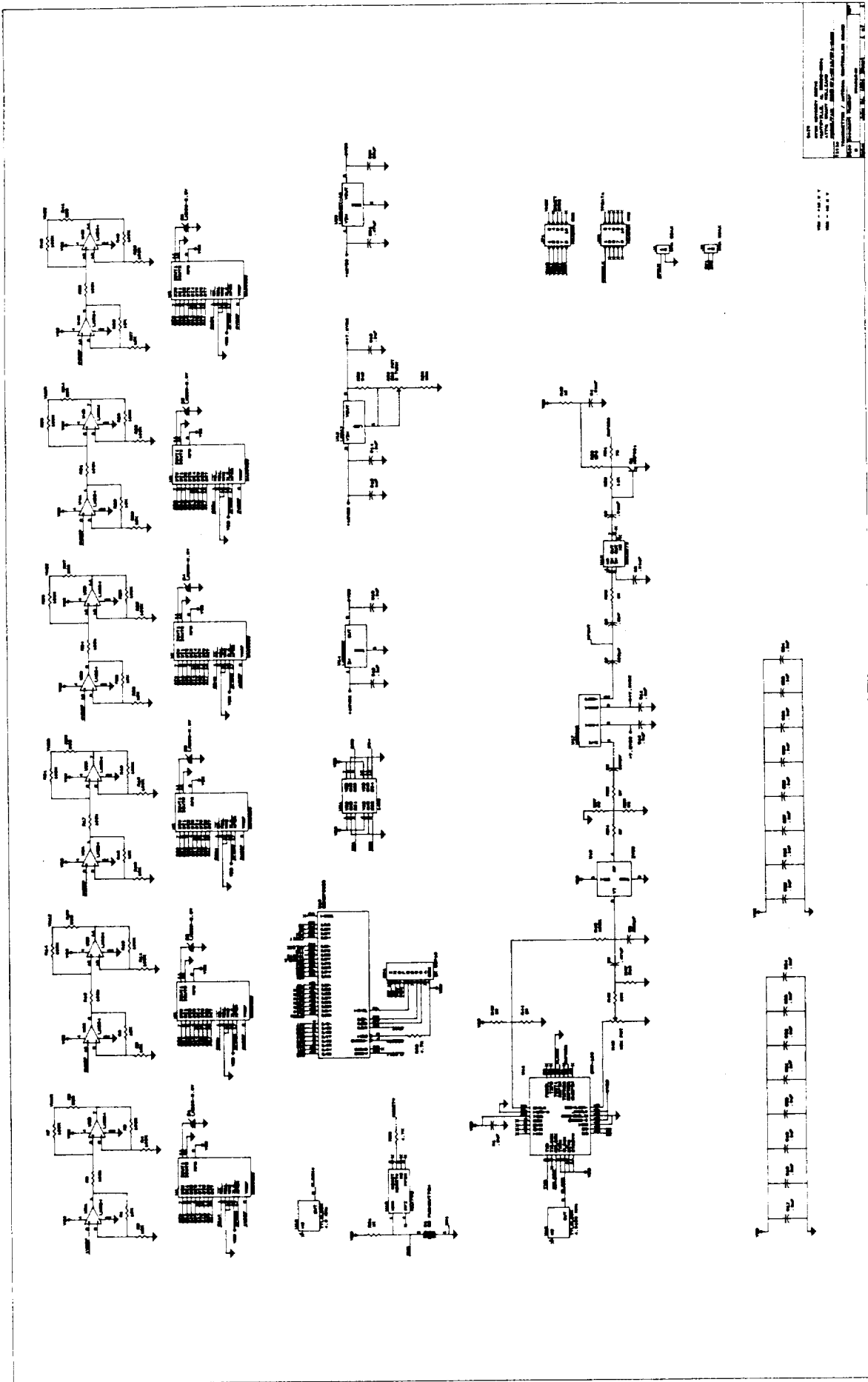

Figure 3.4-1 EVAS Transmitter Schematic



shelf components. Two issues remained to be resolved. First, a means to determine distance is needed and second a system that works in the presence of multiple EVs is required.

#### 4.1 SPREAD SPECTRUM MODEM SELECTION AND ANALYSIS

Since the original EVAS design used spread spectrum integrated circuits designed for the 915 Mhz license-free band, a search was conducted for existing products which used this same general approach. A number of products were located and several vendors were contacted. One of the criteria for selection of a spread spectrum modem was the ability to measure the received signal strength. None of the modems on the market had this desired feature, however by discussing the problem with each vendor we were able to locate a vendor which promised to help address the problem. Another prime consideration given to the modem selection was available RF power and after comparison of several units, spread spectrum modems manufactured by GRE America and sold by STI were selected. The specifications for this modem is given in Table 4.1-1. Each modem is, in fact, a transceiver and connects directly to a computer or microcontroller via an RS232 port. GRE America agreed to modify one of the units to provide a measure of received signal strength. Three modems were purchased for test and evaluation. Two modems would be used as EV transmitters and one as a PV receiver.

**Table 4.1-1 STI SD5510/V Modem Specifications**

Baud Rate	9600
Duplex	Half
Communication Mode	Broadcast, Transparent
<b>Transmitter</b>	
Output Power	+30 dBm Max
Modulation	BPSK
Output Frequency Range	903-927 MHz
Output Frequency Step	1 MHz
PN Rate	2 MHz
PN Code Length	7 stage 127 chip
<b>Receiver</b>	
Dynamic Range	-103 to -30 dBm
Bit Error Rate	$10^{-6}$ @ -95 dBm Input
Signal Acquisition Time	8 msec

## **4.2 LABORATORY TESTING AND SYSTEM EVALUATION**

Each spread spectrum modem was tested when received. One of the items noted was that the antennas received with each unit did not particularly have a good impedance match and the connectors on one failed immediately. We decided to design and fabricate the antennas to be used during system testing. The fabricated antennas had Voltage Standing Wave Ratios (VSWR) of at least 1.2:1 or better.

One issue that was a concern was what happens when two or more EVs are transmitting at the same time. Would a single receiver lock onto one of the signals to the exclusion of other strong signals, alternate between the two transmitting signals randomly, or simply not lock to either due to interference. Tests both in the lab and out on the road confirmed that the receiving set simply locked onto either of the transmitters randomly. Therefore, in general, the receiving set (PV) will receive all transmitters (EV) and be able to identify each by the proper decode. This turns out to be the case due to the spread spectrum nature of the transmission and reception of the signal. No interference occurs because the signal is spread broadly throughout the spectrum. The receiver is searching throughout the spectrum for a signal to lock to in a predefined pseudo-random sequence and therefore it locates and locks to whichever transmitting set happens to be tuned in phase with the receiver. The transmitter broadcasts for a brief period of time. It is possible for a system such as this to saturate with too many transmitters in a given area, however the limit is not expected to be a practical concern.

The range of the system was tested in a couple of different ways. First, the receiver sensitivity was tested by using an "RF screened" room. To perform this test the transmitting set is located outside the screen room and the receiving set is located inside the screen room. An RF screen room blocks all RF transmission into or out of the room, thereby effectively isolating the unit under test. The transmitting and receiving unit are then connected directly via coaxial cable. The input power to the receiving set is varied by using attenuators until the receiving set can no longer receive a signal. This input power is measured by tapping off the RF input into the receiver. The receiver sensitivity was measured to be very good down to about -95 dBm and the signal was lost completely at about -89 dBm. Figure 4.2-1 is a plot of the measured byte error rate versus input power for a transmitter receiver pair.

A transmitter receiver pair was also tested outside on the roads near Research Park West and in an open field on Redstone Arsenal near the Rideout Road exit. In each case the objective was simply to verify operation in a relatively open area and to verify the minimum range requirements for the system (1/4 mile). In both cases, the system performed very well, much in excess of the 1/4 mile minimum range. The open field test on Redstone Arsenal included varying elevations as well as trees which obscured the line of sight between transmitter and receiver. The maximum range tested was less than a mile during these tests however it was more than 1/4 mile. A plot of the error-free bytes/sec versus time elapsed is given in Figure 4.2-2. Figure 4.2-3 is a rough sketch of the open field test site. A similar test was performed on the roads near the SAIC building in Research Park West. The transmitter was parked at the end of Explorer drive near the Adtran Building and the receiver was driven from that location back along Explorer North to U.S. 72. From U.S. 72, the transmitter was driven east connecting to Rideout Road and then returning South along Rideout. From Rideout the route taken was Bradford West to Explorer and the South back to the starting location. This route is depicted graphically in Figure 4.2-4 and at the maximum range is more than a mile. Figure 4.2-5 is a plot of the bytes/sec received versus time during the round trip test. Major points along the route are annotated. It can be seen that the system works well beyond the required or even desired range, however, as expected there are problems when line of sight is not obtained. In general, the RF system appeared to work well and was of about the correct signal level for an Emergency Vehicle Alert System.

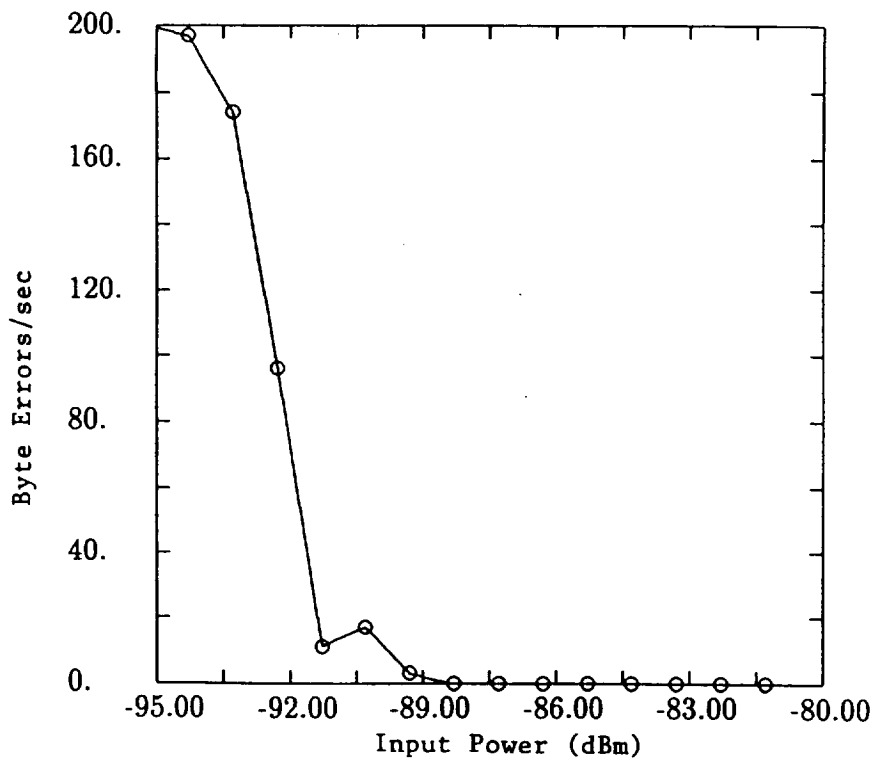

**Figure 4.2-1 Byte Error Rate vs Input Power**

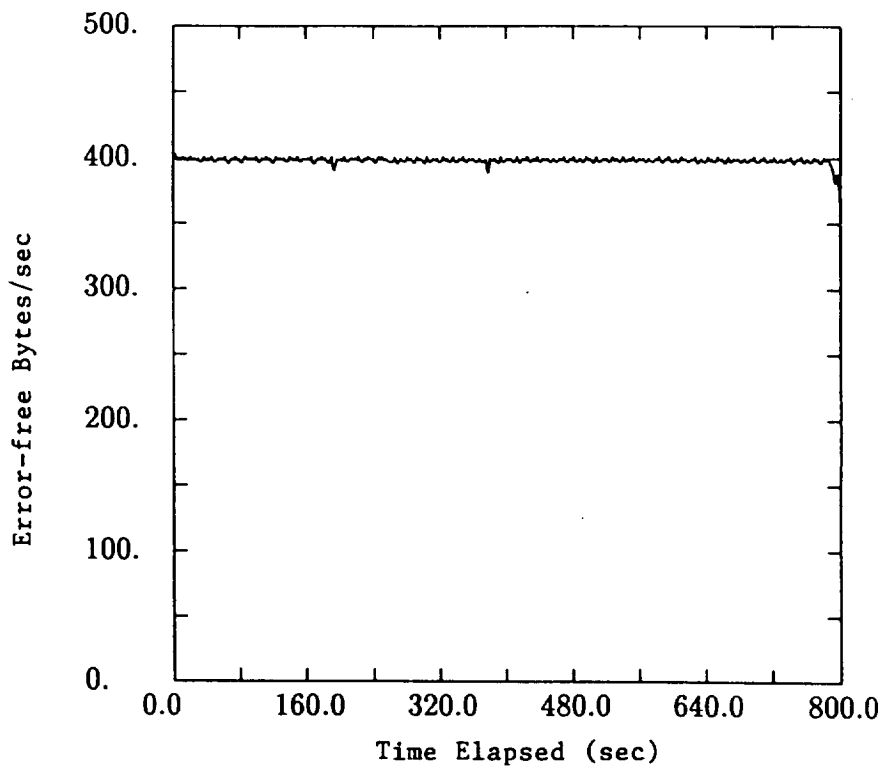

**Figure 4.2-2 Data Transmission Test, site: Open Field Test Area on Redstone Arsenal (roads, woods)**

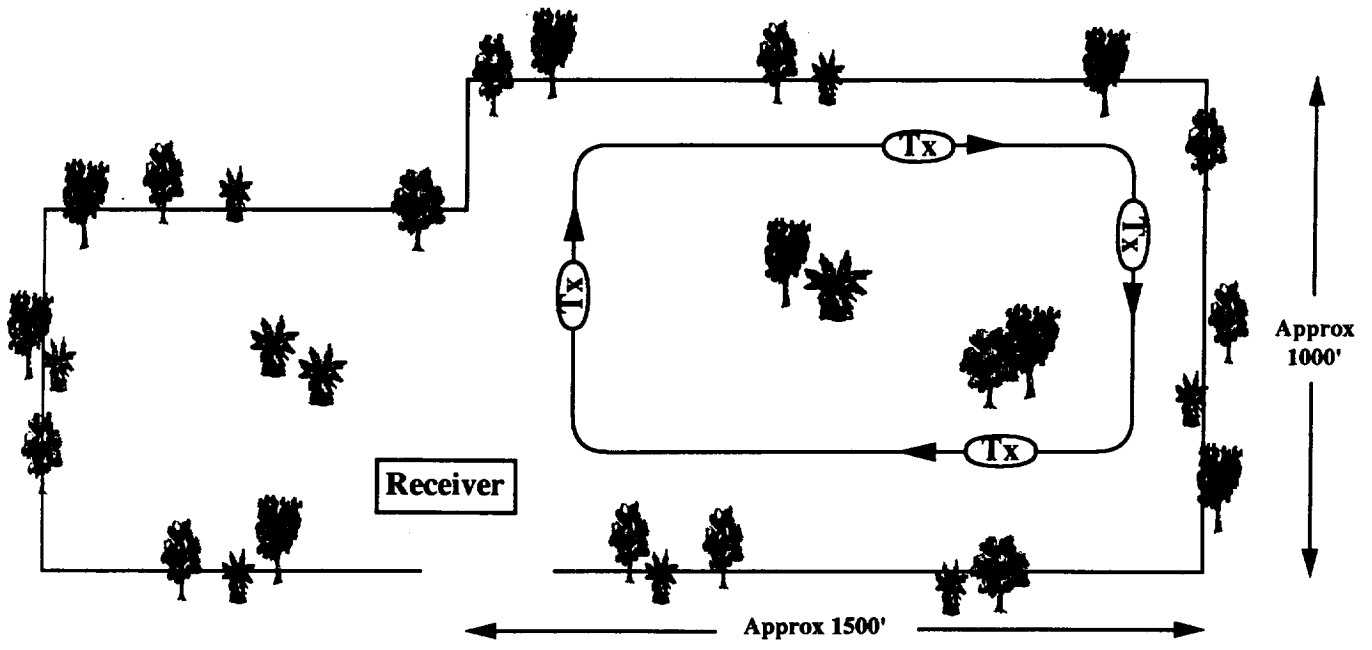

Figure 4.2-3 Open Field Test Site on Redstone Arsenal

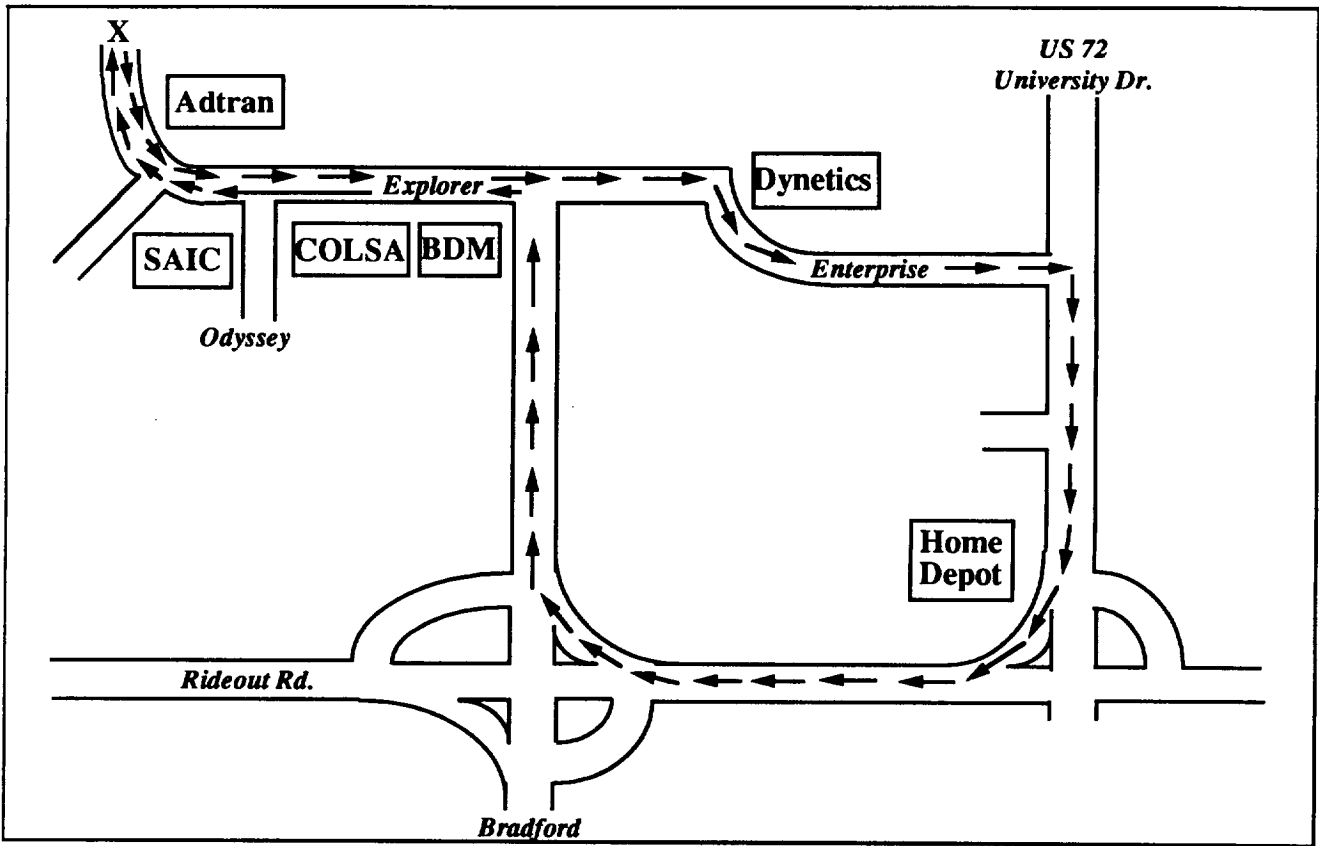

Figure 4.2-4 Research Park Test Route

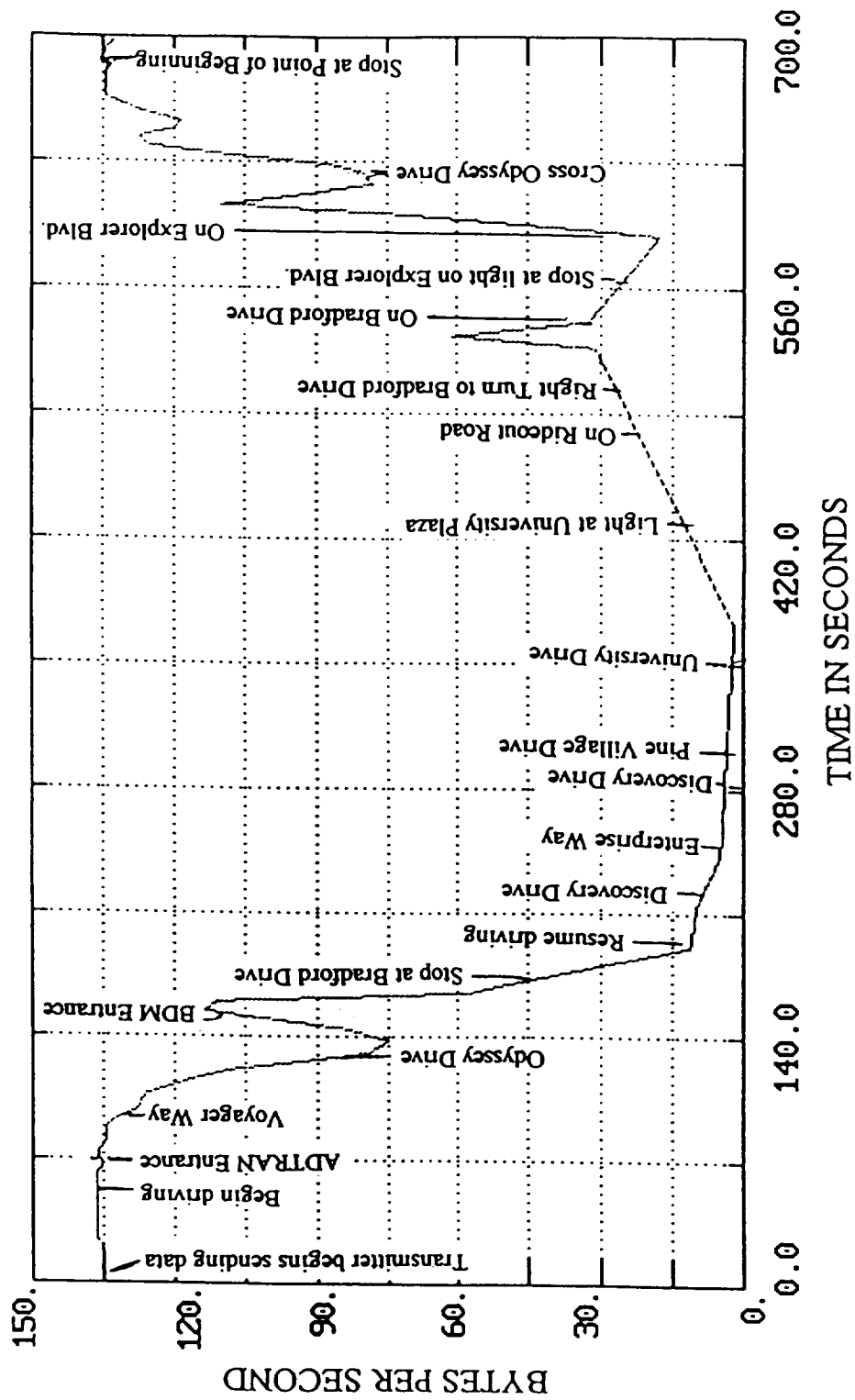

Figure 4.2-5 Received Bytes/Sec in Research Park Test

### 4.3 SOFTWARE FOR SYSTEM TESTS

One of the main tasks in the revised Phase 4 statement of work was to develop software to receive transmitted EV messages and provide a visual display indicating the type of emergency vehicle (fire, police, or ambulance). The software must also be capable of recognizing and displaying multiple vehicles which may or may not be of the same type. Since the display was to be demonstrated on a PC rather than a microcontroller, the receiver software was developed for the Microsoft Windows 3.1 operating system. Windows provides a graphical environment with built-in functions for communicating through the RS-232 ports, and for displaying bitmap images which represent the emergency vehicles. Figure 4.3-1 depicts the displays used during development and testing to represent the various Emergency Vehicles.

The transmitted message format was chosen to convey the minimum amount of information necessary to identify the type of the vehicle and also distinguish two different vehicles of the same type. The message format, given in Table 4.3-1 is also flexible to allow other data fields to be transmitted without requiring changes to the receiver code.

**Table 4.3-1 Transmitter Message Format**

<u>Byte(s)</u>	<u>Meaning</u>
0	Preamble character (hex 0A)
1	Vehicle type code
2	Vehicle ID number
3	Length of additional data

The first message byte signals the receiver software that an EV message is being received. The second identifies the vehicle type: 0=fire, 1=police, 2=ambulance. The third byte contains a unique ID number for the vehicle (0-255) to enable the receiver to distinguish between two vehicles of the same type. The fourth byte specifies the length in bytes of any additional data, such as heading, speed, etc., transmitted as part of the message. The receiver software will read the additional message data but not do anything with the information. For our tests the length field was set to zero, so the total message length was four bytes. Typical message rates used in testing were 3 to 4 messages per second. These rates were found to be more than adequate for a quick response time, even under multiple EV conditions.



**Figure 4.3-1 EVAS Display Emblems**

Due to finite message transmission rates, occasional message dropouts, or competition for reception in the case of multiple EV messages; a message persistence time was defined in the receiver software. The program maintains a list of vehicles detected and their last message time. Upon reception of a message from a vehicle not already in the list, a new emblem is displayed in the receiver window. The emblem persists in the window for the predefined time. If another message is not received from that vehicle within the persistence time, the vehicle is removed from the list and its emblem is removed from the window. The persistence time is configurable by the user without modifying the code.

Additional features were added to the receiver software to support data acquisition and logging for the system test, described in the next section. The signal strength (AGC) output from the PV modem was digitized by a National Instruments Lab PC+ multifunction card in the PC. The measured AGC value was read by the receiver software and presented on the display as a bar graph below the emblem of each detected EV. Each message received was time stamped by the system. The time, vehicle type code, vehicle ID, and signal strength measurement for each message was logged to a file during the test to provide data on system performance and sensitivity.

Software for the transmitting modems was extremely simple, since the transmitting unit was only required to put out a fixed series of 4 bytes at regular intervals. Software to operate the transmitters was written on the PC, under Windows. However for the actual system test we used a Tandy 102 computer, powered by 4 AA batteries, to drive one transmitter and a Domino microcontroller, powered by a 9 V transistor battery, to operate the second transmitter. The programs on these were only 5 to 6 lines of code. One unit transmitted a fire EV message, and the other an ambulance EV message.

#### **4.4 SYSTEM TESTING**

The EVAS system test and evaluation plan called for an evaluation under typical city driving conditions. The purpose of this test was to try the system out in realistic conditions, while driving, to see if a warning signal was received to alert the driver. The downtown area of Huntsville was selected as typical of most city driving. There are a number of buildings to block or reflect a signal and also some nearby major elevated roadways. The software required to operate the system transmitters was very simple. The transmitted message contained a preamble character, a vehicle type code and a vehicle identification number. Two EV transmitters were simulated. One PV receiver was simulated. The PV receiver was connected to a portable computer and the computer screen was used to provide detection messages. During testing, audio was recorded which described the test route and the received signal strength was also recorded. A twelve bit A/D converter was used to record the signal strength (or receiver AGC signal voltage) and the voltage output was scaled from 0 to 10 volts for recording. Zero counts represented the maximum possible signal (at 0 volts) while 4095 counts represented the minimum possible signal (at 10 volts). The AGC voltage can be related to a dBm signal level through calibration of the unit. A rough calibration for the SD 5510/V modem was requested and supplied by GRE America. This calibration is given in Figure 4.4-1. It can be seen that this calibration agrees roughly with the data taken in the RF screened room and presented in Figure 4.2-1.

<u>Input RF Power (dBm)</u>	<u>AGC voltage (volts)</u>
-96.	5.62
-94.	5.31
-92.	4.99
-90.	4.64
-88.	4.31
-86.	4.02
-84.	3.79
-82.	3.61
-80.	3.45
-78.	3.34
-76.	3.25
-74.	3.17
-72.	3.11
-70.	3.05
-68.	3.01
-66.	2.98

**Figure 4.4-1 Approximate AGC Level Calibration Based on Data Provided by GRE America**

Two different "city" tests were performed in the same basic city block areas. The first test was to demonstrate that the system could receive an emergency signal from two different EVs which were basically in the same location. This test would serve to demonstrate the range of the system as well as the ability to receive from more than one EV without interference. Figure 4.4-2 depicts the route taken by the PV and shows roughly the range of the EV signals received by the PV. The PV started at Transmitter #1 location and proceeded in the direction of the arrows to end up at the starting point. In both tests, the EVs remained stationary while the PV traversed the test route. For Test #1, both EVs were parked near Lewter's Hardware, EV #0 was at the corner of Washington and Monroe (shown as a yellow dot on figure), while EV #2 was at the corner of Monroe and Meridian (shown as a blue dot on figure). The test route began and ended at Lewter's Hardware and is shown in the figure as a red line with arrows indicating direction. During the test route if a signal was received from the blue transmitter then that part of the route is colored blue and if a signal was received from the yellow transmitter then that part of the route is colored yellow. When a signal was received from both EV transmitters then both colors were used, resulting in a green color. It can be seen that the signal was received nearly all of the time over this route. In two distinct spots the signal was lost from both EV transmitters, both occurring easily more than a mile from the location of the transmitters. A composite record of the signal strength received from both transmitters versus time is shown in Figure 4.4-3. The signal strength is strongest near the Tx and drops below the noise threshold at several points during the test.

In Test #2, the same basic area of the city was used, however in this case the two EV transmitters were separated to opposite ends of the test route. The blue transmitter (#2) remained at the corner of Monroe and Meridian while the yellow transmitter (#0) was relocated to Gates Street midway between Franklin and Madison. The test route was initiated





Figure 4.4-2 Test #1, Tx Colocated

TEST1BP:2

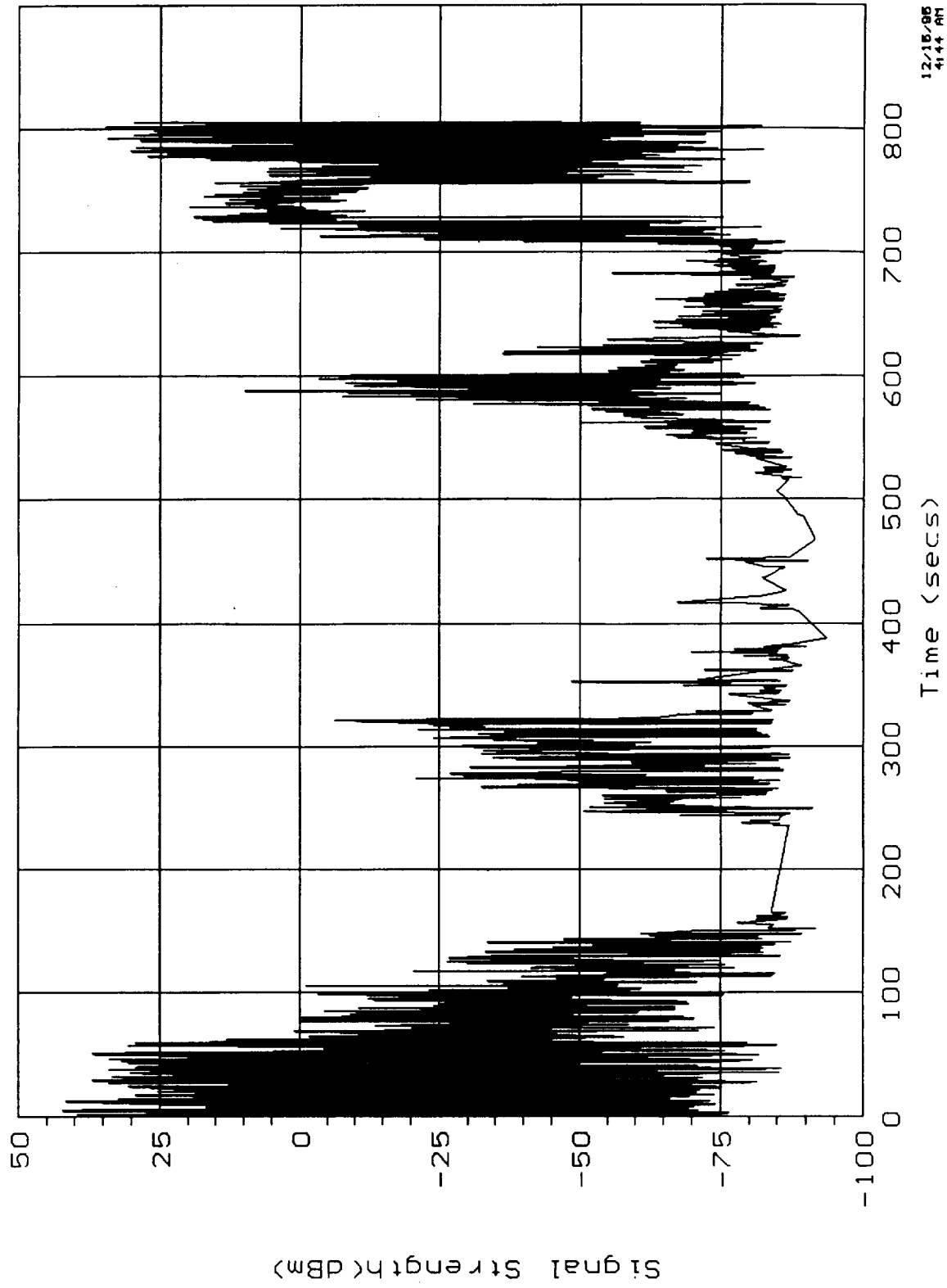

Figure 4.4-3 Composite Record of Signal Strength vs Time for EVAS Test #1

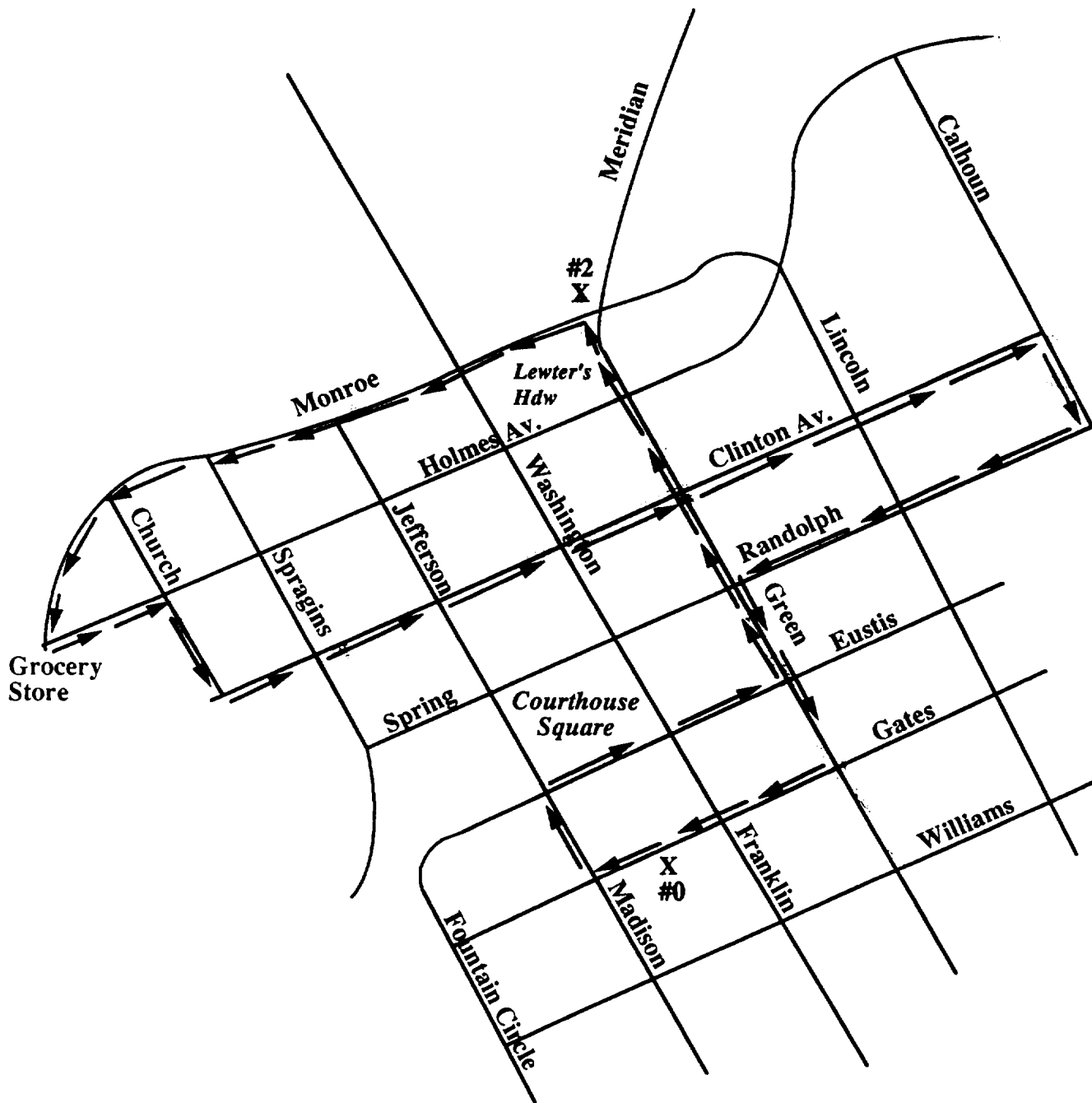
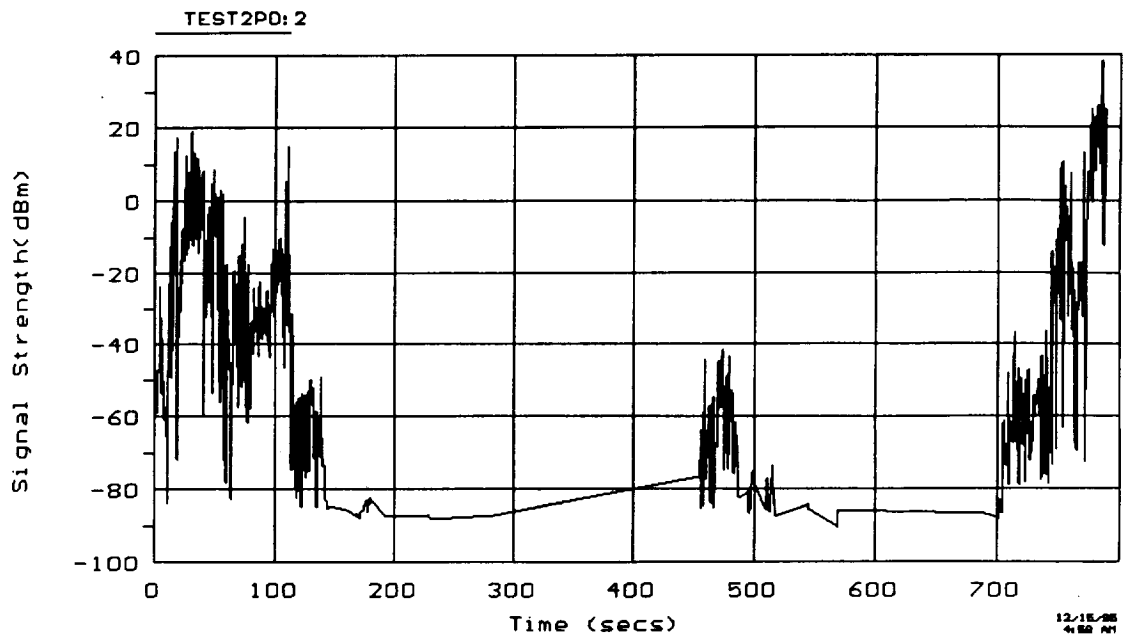
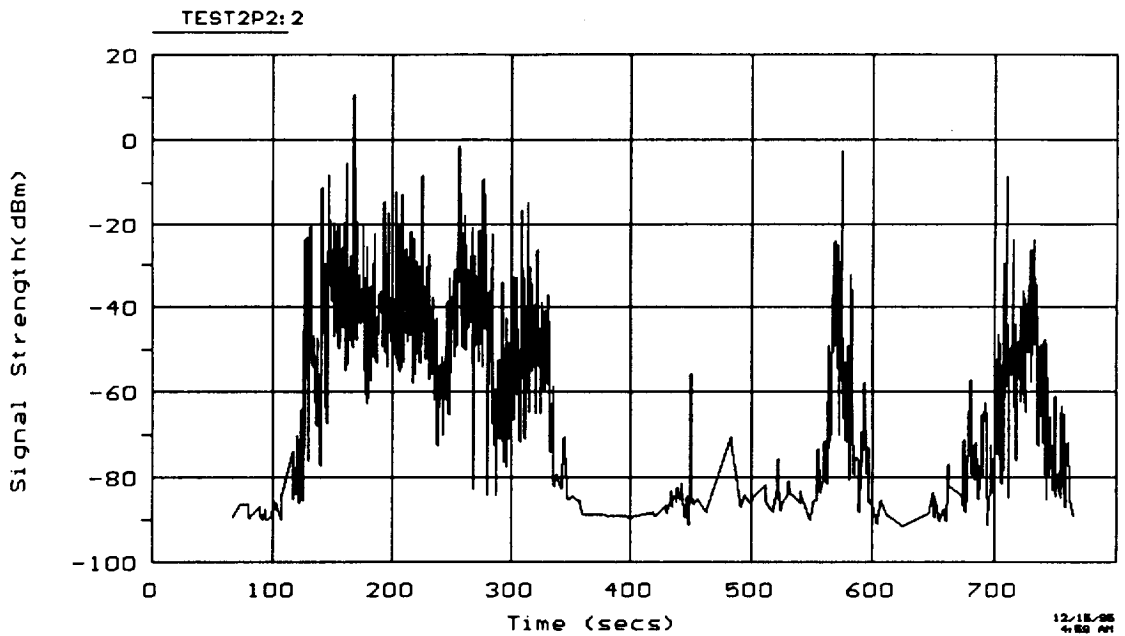

Figure 4.4-4 Test #2, EV Transmitters Separated



a) Blue Transmitter



b) Yellow Transmitter

Figure 4.4-5 Signal Strength Record for EVAS Test #2

and ended at the location of Ev transmitter #0 (yellow). Figure 4.4-4 depicts the test route and the results of Test #2. As expected, the received signals are best near each transmitter with overlap from each at other points of the route. Transmitter #0 was parked on the street just South of a series of buildings. Even so, the signal was clearly received within a significant radius around the transmitter, easily more than a quarter mile. Figure 4.4-5 shows the signal strength record for EVAS Test #2. Two different plots are shown in this figure and they represent transmitter #0 (test2p0:2) and transmitter #2 (test2p2:2). The curves show significant dropout from each transmitter far from each transmitter location. In general, it can be seen during this test that each transmitter is received well when nearby and drops out as the distance increases beyond several blocks.

## 5.0 CONCLUSIONS

The EVAS program has been successful in demonstrating that a system can be developed and demonstrated to warn hearing impaired drivers of an emergency vehicle. During the course of the program development, it became apparent that other uses of a system of this type may be appropriate. For example, it was clear that perhaps any driver of a modern vehicle might be able to use a warning device to alert him or her of the proximity of an emergency vehicle. With extensive use of soundproofing and high output stereo systems, many drivers are unaware of emergency vehicles. Other uses of a warning system were also considered. For example, trains, school buses, and construction hazards all represent warnings which can probably be appreciated by the average driver. The technology to provide this alert is available now. To implement an RF system of the type described in this report, a common hardware and software architecture should be developed for the various applications and low cost transmitters must be produced. The cost of such a system can be very competitive with the proliferation of RF hardware which is available at the 915 Mhz "license-free" band. It is expected that the PV receivers would be comparable in price to a radar detector while the EV transmitters may be somewhat more expensive. It is anticipated that warning or information systems of this type will be available in personal vehicles in the next 5 to 10 years.

## REFERENCES

1. "Emergency Vehicle Alert System (EVAS) Phase I Final Report", TVA Contract # W-17703, T. Barr, W. Harper, B. Reed, D. Wallace, ARI/92-R-004Z, Jan 1992.
2. "Emergency Vehicle Alert System (EVAS) Phase II Final Report", NAS8-39383, T. Barr, W. Harper, B. Reed, D. Wallace, ARI/92-R-050, Jan 1993.
3. "Emergency Vehicle Alert System (EVAS) Phase III Final Report", NAS8-39383, T. Barr, W. Harper, B. Reed, D. Wallace, ARI/93-R-069Z, Nov 1993.

