

DEVELOPMENT OF A LARGE SCALE, HIGH SPEED WHEEL TEST FACILITY

**Anthony Kondoleon & Donald Seltzer
C. S. Draper Laboratory**

&

**Richard Thornton & Marc Thompson
Massachusetts Institute of Technology
Cambridge, MA 02139**

ABSTRACT

Draper Laboratory, with its internal research and development budget, has for the past two years been funding a joint effort with the Massachusetts Institute of Technology (MIT) for the development of a large scale, high speed wheel test facility. This facility was developed to perform experiments and carry out evaluations on levitation and propulsion designs for MagLev systems currently under consideration. The facility was developed to rotate a large (2 meter) wheel which could operate with peripheral speeds of greater than 100 meters/second. The rim of the wheel was constructed of a non-magnetic, non-conductive composite material to avoid the generation of errors from spurious forces. A sensor package containing a multi-axis force and torque sensor mounted to the base of the station, provides a signal of the lift and drag forces on the package being tested. Position tables mounted on the station allow for the introduction of errors in real time. A computer controlled data acquisition system was developed around a Macintosh IIfx to record the test data and control the speed of the wheel.

This paper describes the development of this test facility. A detailed description of the major components is presented. Recently completed tests carried out on a novel Electrodynamic (EDS) suspension system, developed by MIT as part of this joint effort are described and presented. Adaptation of this facility for linear motor and other propulsion and levitation testing is described.

BACKGROUND

Magnetically levitated high speed ground transportation technology (MagLev) was experiencing an increased interest in the United States in the early 1990's as a potential solution to increasing highway and air corridor congestion. The Intermodal Surface Transportation Efficiency Act of 1991 (ISTEA) had mandated the development of a prototype MagLev demonstration system in the United States. During the period of 1991 and 1992, Draper Laboratory was involved in study contracts from the Department of Transportation (DOT) in the high speed ground transport area. One study (1) was in the area of aerodynamic forces on MagLev vehicles. This study produced a low drag nose profile, the relationship of width to length ratio on passenger energy, the effect of lift and drag due to wing surfaces on the vehicle body, and the effect of wing surfaces on ride quality. A second contract (2) carried out a comparison of EDS and Electromagnetic (EMS) levitation concepts.

In 1991, Draper Laboratory and MIT joined the Bechtel team for one of four System Concept Definition contracts awarded by the DOT. Other members of our team included G. M. Electromotor Division and Hughes Ground System Group (3). Our team concept was an EDS system which used a novel configuration of vehicle mounted, flux canceling magnets. The vehicle contained six sets of eight superconducting magnets per side which straddled a concrete box-beam

guideway. The interaction of the vehicle magnets and the guideway sidewall, which contained a laminated aluminum ladder design, generated lift. A similar interaction with guideway mounted null-flux coils provided the guidance. The vehicle's propulsion was generated by a Linear Synchronous Motor (LSM) whose windings were also attached to the guideway sidewalls. Centrally controlled wayside stations provided the required variable-frequency, variable-voltage power for the LSM drive. The team's vehicle consisted of a single car with an inner tilting shell. It was designed to use aerodynamic control surfaces to augment the magnetic guidance forces. The guideway consisted of a post-tensioned concrete box girder. The switch was to be a bendable beam constructed from fiber reinforced plastic (FRP).

PROBLEM AREA

The Bechtel team concept for the MagLev vehicle was based on a EDS system for levitation and guidance using superconducting magnetics on the vehicle and an arrangement of electrical conductors on the guideway. The magnetic suspension system was the most important, but least understood part of our proposed EDS MagLev system. Thorough understanding of such systems, with verified analytical design techniques, were essential to formulating improved designs for successful full scale systems. While the EDS technology has many positive features, the ability to operate with large gaps for one, major questions are unanswered. A major question has to do with the particular aspect of the interaction between the superconducting magnets on the vehicle and the conductors on the guideway.

The technological cornerstone of the claimed superiority of the EDS MagLev system is the superconducting magnet. One of the critical issues affecting the potential viability of such systems is that of the magnitude and effects of AC losses in the superconducting coils which provide the levitation and guidance for the vehicles (while superconductors have zero losses for DC currents, losses do occur for AC currents). These losses, caused by the AC magnetic fields resulting from the variations of the electrical currents in the guideway which provides the levitation and guidance forces, have at least two effects that are significant for EDS MagLev systems. First, they increase the thermal load on the cryogenic refrigeration system, either reducing the safety margin, or requiring the use of more powerful (larger, more expensive, higher power) refrigeration systems. Second, and potentially more serious, they may result in the decrease of the magnet current over time; and if sufficiently rapid, cause touchdown during motion.

We felt that it was important to establish early on the nature and extent of such AC losses in superconducting coils used for MagLev levitation, and guidance, so that their implications for the design and operation of EDS MagLev systems could be understood and addressed.

SOLUTION PLAN

In 1992, Draper with its Internal Research and Development budget undertook a multi-year project to formulate a series of experiments to provide some needed quantitative information on AC losses in superconducting coils for EDS MagLev systems. The initial approach was to examine the use of Draper's centrifuge for near full size testing of MagLev suspension and propulsion designs (4). The centrifuge with its long arm (35 ft.) and high G (200), and high load (7500 lbs) capacity was found suitable for use. Unfortunately, neither a firm design or firm outside funds were available to pursue this facility further. Draper and MIT in 1993 chose to develop a facility which would be more cost effective to construct while being large enough in size to avoid many problems involved with sub-scale testing.

MAGNETIC SCALING PROBLEM

Scale model experiments involving magnetic structures face a fundamental difficulty due to dimension scaling problems. If all dimensions are increased by a factor d , the forces and power loss scale in different ways with efficiency improving as size increases. For example, an induction generator has an efficiency that decreases as the size decreases until for a sufficiently small machine the power loss exceeds the power generated and no net power generation is possible! In contrast, a 1 Megawatt version of this same machine can generate power with an efficiency of 98%. Dealing with these scaling problems is a fundamental issue that must be addressed in the design. We do not know of any other test facility that has dealt with the magnetic scaling laws in a satisfactory way.

The objective is to design a facility that has high enough performance that we can operate on the high speed side of the drag peak. The drag force (D) for virtually all EDS systems has the form:

$$D = abu/(b+u)^2$$

where a and b are design parameters and u is the vehicle speed. Parameter a has dimensions of force and is proportional to the square of the vehicle coil current. This constant increases with size, but the scaling laws are simple so we can extrapolate from measurements of small forces. Parameter b is the speed at which the drag reaches its maximum value and it scales inversely with size. Hence a 1/5 scale model will have its drag peak at 5 times the speed of the drag peak for a full size system. The full size version of our SCD suspension had an estimated drag peak of 20m/s. A 1/5 scale model would have this peak at 100m/s. For meaningful test data, it is important to operate to the high side of the drag peak, hence a maximum speed above 100 m/s would be the goal for a 1/5 size test facility.

FACILITY DEVELOPMENT

The joint Draper, MIT effort was to design and build a high speed wheel test facility which would operate above the drag peak of the proposed 1/5 scale EDS suspension systems. This wheel facility was designed to assure that the characteristics necessary for successful execution of a test program were realized. Requirements for the facility included the following:

1. Protection/containment provisions as necessary to ensure safe operation of the apparatus. This is essential due to the high surface speed of the wheel.
2. Peripheral speed of the order of 100 meters/second.
3. The wheel rim, where the simulated guideway conductors would be mounted, would be non-magnetic and non-conductive material to avoid generation of spurious forces and power losses.
4. Provisions for mounting an instrumented sensor package for measurement of forces and torques on the simulated vehicle.
5. Flexible design for accommodating a wide range of suspension/propulsion systems concepts as practical. Capability for testing both EMS systems and EDS systems.
6. Provisions for introducing errors and movement to the vehicle while the wheel is rotating. Position errors in the X, Y, Z and ϕ axis.

All the above requirements were met with the design of the system (Figure 1). The drive system for the wheel is a variable speed 10 Hp motor with a brake system which has driven the wheel assembly up to 1200 RPMs, > 115 m/s. The main shaft of the wheel is 8 feet long and 3 inches in diameter. One end contains the belt drive system attached to the motor drive system. The second side contains a four foot diameter, 1 inch thick aluminum disk which holds the test rim being rotated. The maximum diameter of the test rim is 68 inches to accommodate the width of the test pit where the facility is located (Figure 2). The static part of the test article is mounted to a multi-axis force sensor assembly. This sensor can read in real time the three components of the force and 3 components of torque being exerted on the assembly during test. Located in this base package are proximity sensors for magnetic air gap measurements and linear and rotary tables for error introduction in real time.

The Test Data Acquisition System is a computerized station for real time acquisition, processing, display, and storage of sensor data during tests in the facility. The system is comprised of a Macintosh IIfx, data acquisition computer, electronics console, motor controllers, specialized software and external sensors. Key parameters are monitored during tests in the facility. Summary data is recorded in the form of plots and spreadsheet compatible data files. Sensors include the multi-axis force sensor to measure forces and torques acting upon the test article, gap sensors to measure the magnetic air gap, rotation sensors to measure wheel speed, and temperature sensors to measure shaft bearing temperature. Figure 3 shows the system interconnections. The data acquisition and control computer contains 8M RAM and a 20M hard drive, a National Instruments NB-MIO-16 analog/digital interface card with 16 multiplexed channels of analog input, 8 bits of digital I/O, and 3 counter/timers. Four analog channels are used to acquire gap and temperature sensor data, eight channels have been allocated for coil current measurement and two of the counters for measuring wheel speed. The computer also has two serial ports. One of these is used for communicating with the digital interface of the multi-axis force sensor using RS-232 protocol, while the other port is connected to the main motor controller.

The data acquisition computer software was developed in HyperCard, which is a combined development and run-time programming environment. The data acquisition software is organized as sixteen cards, grouped into six backgrounds. Some of the cards are specifically designed as high-level operator screens. The others are means of grouping similar intermediate procedures and tables. Status information for numerical data, such as sensor readings, is shown in a text field. Status data can also be displayed as an icon attached to a button. The displayed icon can be switched either by hiding or showing the button, changing the highlight of the button, or by changing the icon assigned to the button. Other information is presented in graphical form. This includes input sensor data from the six axis force sensor. The processed data are plotted together against time on the "Plot" screen.

Actions of the systems are initiated by the operator clicking on a command button. This includes starting or stopping data recording, changing an operating mode, or switching operator screens. The operator may also enter or change parameters in certain text fields by first selecting the parameter and then typing the new value. The HyperCard environment automatically saves its state when the program terminates. Upon restarting, most data and operating modes will be retained. For permanent storage of data, there are command buttons for saving data as ASCII text fields with tab elimination of fields, which can be directly imported into a spreadsheet program.

Figure 4 shows the Main Menu screen. On this screen, the operator can run tests in which all of the sensors are periodically sampled. Sensor signal readings are displayed, along with the average value, minimum value, and maximum value recorded during the test run. Each sensor reading is also checked against previously set minimum and maximum limits. Sampling can be halted at any time, and later resumed. The results of a test run can also be stored to a disk file.

Figure 5 shows the Plot Screen. This screen provides an alternative data collection method to the Main Menu screen. The New Data button triggers a 5 second period during which force data is collected at 19 Hz. Any combination of the six force and torque components can be plotted versus time on the screen. The resulting plots can be printed, or the numerical data saved to a disk file in spreadsheet format.

SUSPENSION DEVELOPMENT

The suspension design for testing in the facility was developed by MIT under a two year Draper IR&D grant. This design would replace the two separate coil circuits required for the original SCD study with one for both guidance and levitation. This suspension design is based on the use of high temperature superconducting coils in a flux-canceling arrangement. One side of one section of this design is shown in Figure 6. The guideway is composed of multiple conductive aluminum coils. When the train is in the vertical null position (Figure 6a) at $z = z_0$ and traveling in the +y direction, there is no net time-varying magnetic flux through the levitating coils, and no net current induced around the loop. However, if the train's vertical position deviates from equilibrium (Figure 6b), the net changing flux through the coil loop induces currents in the loop. The resulting Lorentz force is a restoring force in this structure, and for small deviations from the null position, the train behaves like a mass and linear spring (Figure 6c). Eddy currents and circulating currents create a drag force acting on the train in the -y direction. This drag force must be overcome by the propulsion system in an actual MagLev system. There is also a sideways force (+x) generated by this suspension. In the full size MagLev train, there will be another octapole on the other side of the train, and the sideways force will be used to center the train in the guideway.

The original guideway design of this suspension was to be four layers of .050 thick aluminum with alternative patterns from layer to layer (Figure 7a). The structure built was two layers with each layer being .090 thick aluminum of one alternating pattern. The resulting pattern would form a closed conductive circuit when the pattern was passed through the magnetic field of the coils. The linear pattern was changed to a circular pattern for testing on the wheel. This pattern is shown in Figure 7b. The challenge of mounting this circular structure to the wheel was accomplished by imbedding the structure inside the composite rim. This eliminated the need for costly assembly procedures and costly hardware. The mounting hardware would need to have been non-magnetic as well as non-conductive. The original choice was to be number 8 or 10 titanium bolts and inserts numbering in the hundreds. The process chosen eliminated these components. The design also produces a smooth surface on the rim, thereby lowering the aerodynamic forces which would be generated by the wheel motion. Before being inserted into the rim, an insulation layer between the cutouts of the two layers was installed to prevent shorting of the top layer to the bottom except at the edges where it was desired. The two layers were riveted and spot welded together to form the contact necessary for the suspension to work. The vehicle coils were spaced at the pole pitch of .126 meters for the linear model and then curved to match the circular pattern of the suspension. The resulting vehicle coil assembly, with copper coils, and proximity sensors are shown in Figure 8.

PHASE I TEST PROGRAM

The objective of the Phase I Test Program was to verify the workings of the facility and the basic concept of the novel suspension. Both of these goals were met. The basic suspension was to utilize high temperature superconductor coils, but for this first phase program, standard copper coils would suffice.

The tests were carried out with a nominal magnetic air gap of .5 inches. The physical air gap between the face of the coils and the rim surface was approximately .050 inches. The tests were carried out by first setting the magnetic air gap and the elevation of the coil assembly to the

base. The elevation settings were altered in .5 inch increments from 0 to 2.5 inches. The speed would be increased to the desired level with the no coil current. Data would be taken with the coils not energized, in order to generate a baseline database of aerodynamic forces vs. wheel peripheral speed. Data would then be taken for 5 seconds as the coil was energized. This procedure was carried out for speeds up to 1100 rpms (108 m/s), past the design goal of 1000 rpms. The data showed the lift force changed as the null position was approached and changed sign as it was passed through. The maximum lift force occurred between the offset values of .75 and 1.25 inches from null. Above the 1.25 value, the lift force decreased. The drag force increases for these offsets as does the lateral or guidance forces which confirms the working of the system. Figure 9 shows sample data.

PHASE II TESTING

A cryostat and liquid nitrogen delivery system has been designed, constructed and tested, which will allow operation of the magnet assembly in a liquid nitrogen bath (Figure 10). Phase II testing will consist of testing the copper magnet in a bath of liquid nitrogen. The resistance of the copper coils at liquid nitrogen temperature will be significantly lower than at room temperature, therefore, more current and hence more magnetic field and forces may be generated without damaging the coils.

The existing magnet assembly retro-fitted with high temperature superconducting coils, and a one degree of freedom flexure will be installed so that movement will be allowed in the vertical direction. System dynamics and superconducting coil losses will be monitored under test conditions that would mimic actual train operating conditions. The viability of replacing a mechanical secondary suspension with an active magnetic suspension for the full-scale MagLev vehicle will be investigated. The mechanical flexure which allow movement in the vertical direction have been constructed and is currently under test.

PHASE III TESTING

High temperature superconducting (HTSC) coils are currently under construction. After successful completion of Phase II testing, the copper magnets will be retro-fitted with the HTSC coils, and Phase III testing will begin. The fixture will be used to characterize the behavior of a control system for a HTSC magnetic suspension, which is not well understood.

CONCLUSIONS

The multi-year effort to design and fabricate a large scale wheel test facility and test a proposed EDS MagLev suspension design has successfully been completed. A maximum wheel speed of 1100 rpm (108 m/s) surpassed the goal of 1000 rpms. Force and torque data were recorded for various offsets from the null position for coil currents up to 7 amps per coil.

The design of a cryostat bath for first testing the coil assembly at superconducting temperatures has been completed. The next two phases will carry out tests at these temperatures.

The facility can also be retro-fitted for linear propulsion testing. The addition of a generator to the drive system, for loading, and a slip ring assembly to the wheel for power is all that is required. Currently discussions are under way to utilize this facility for this type of testing.

Maglev Wheel Test Station

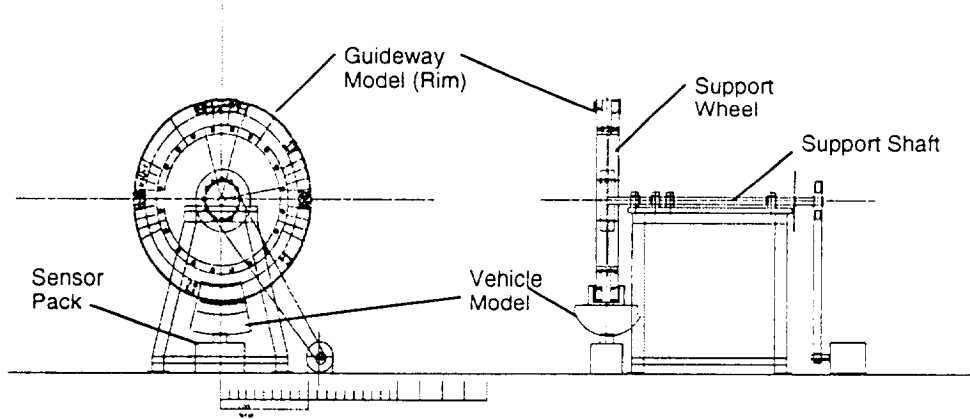

FIGURE 1

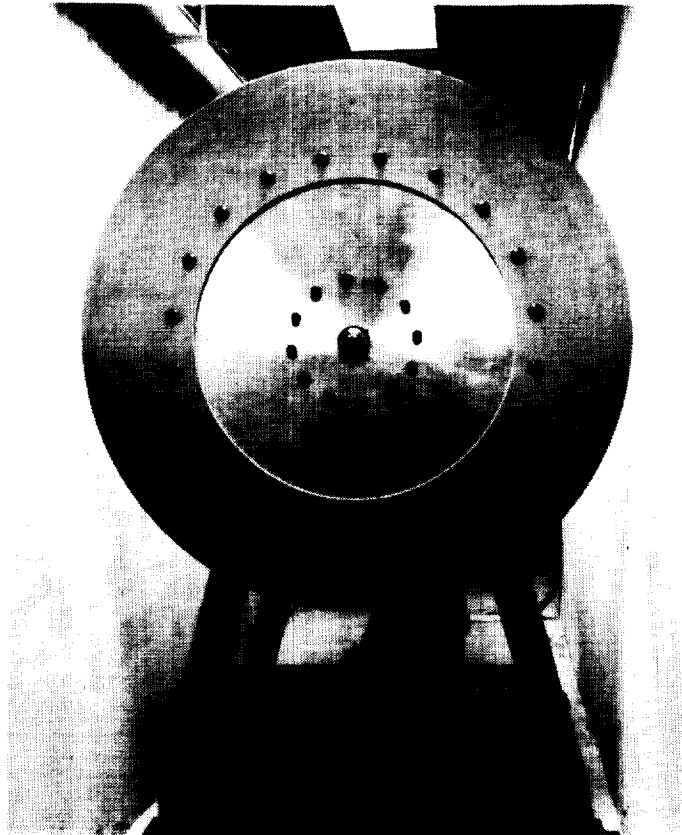

FIGURE 2

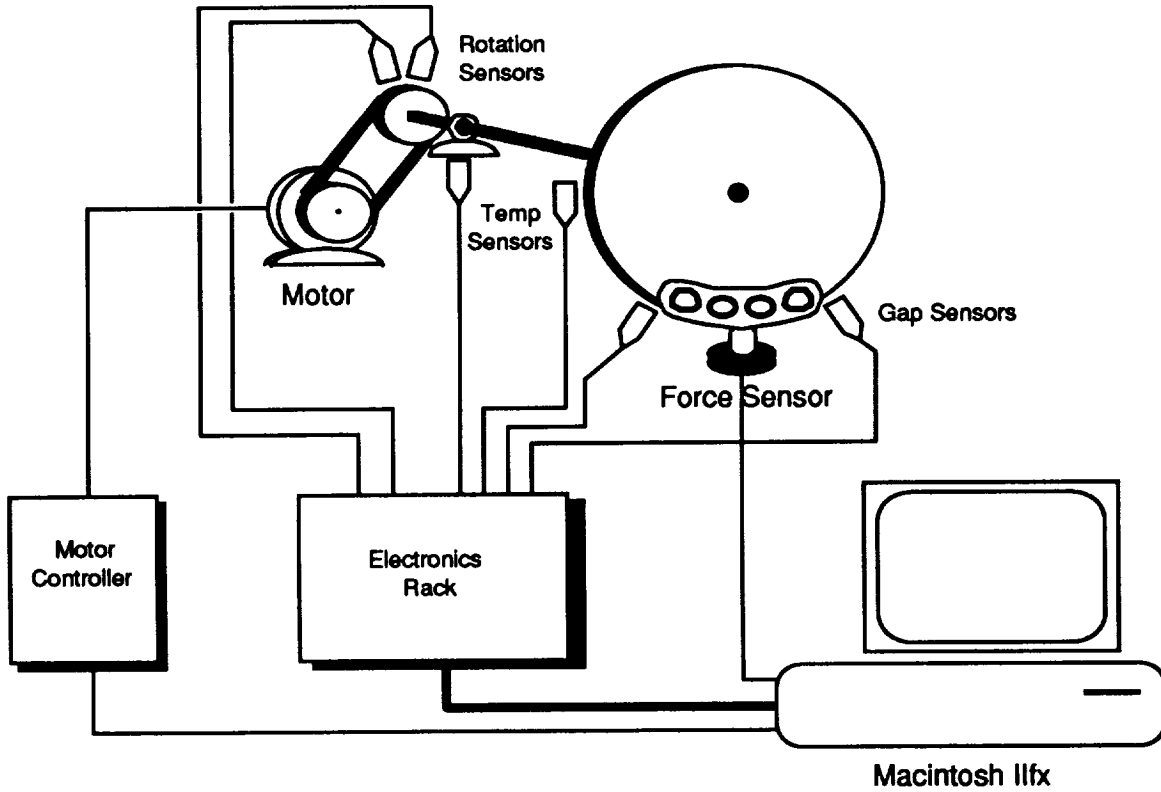

FIGURE 3

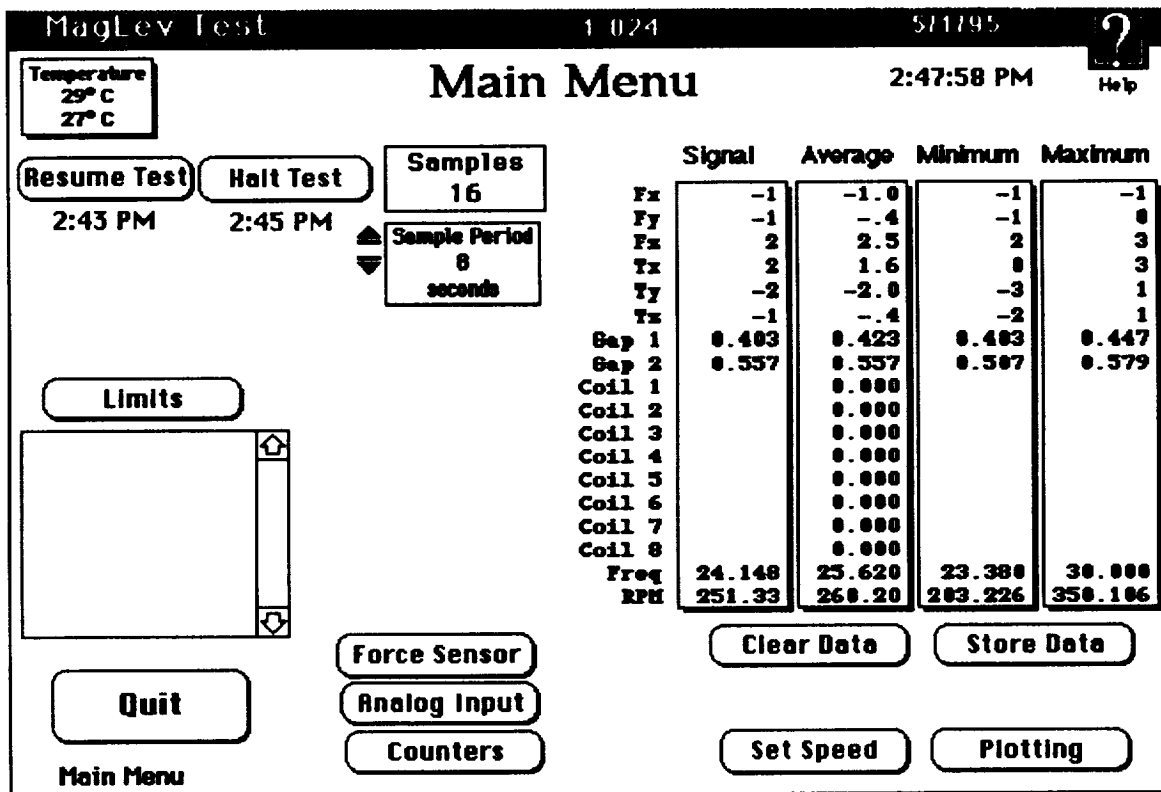

FIGURE 4

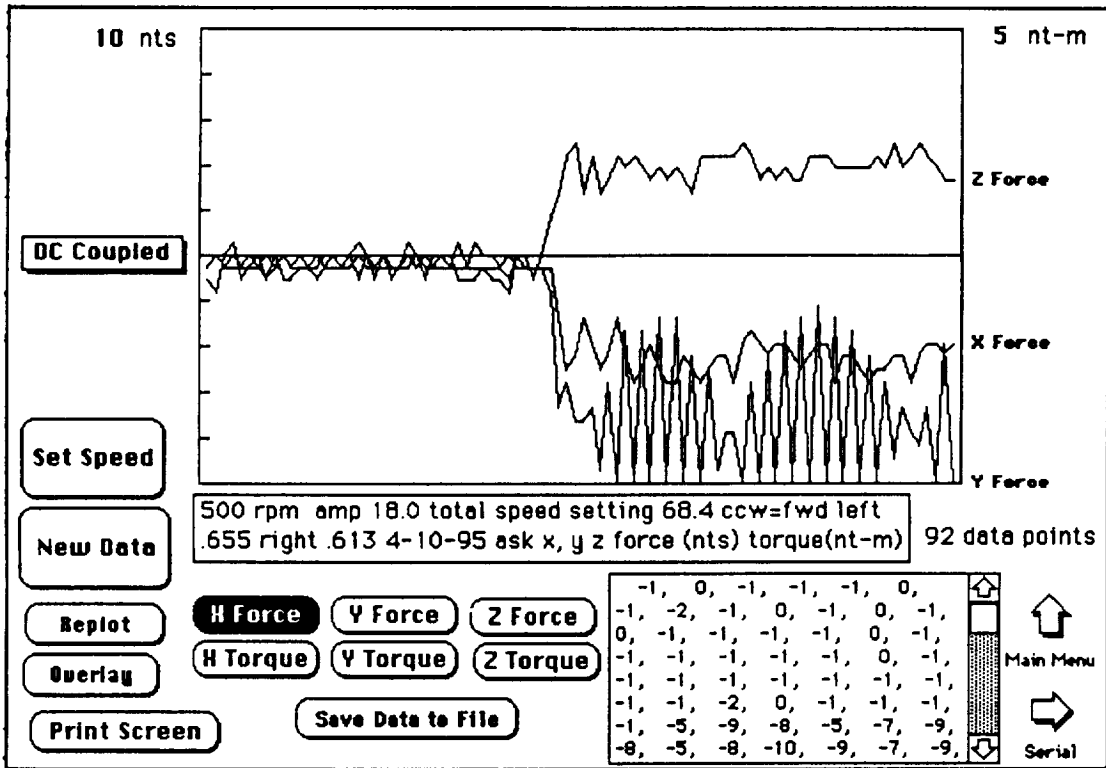

FIGURE 5

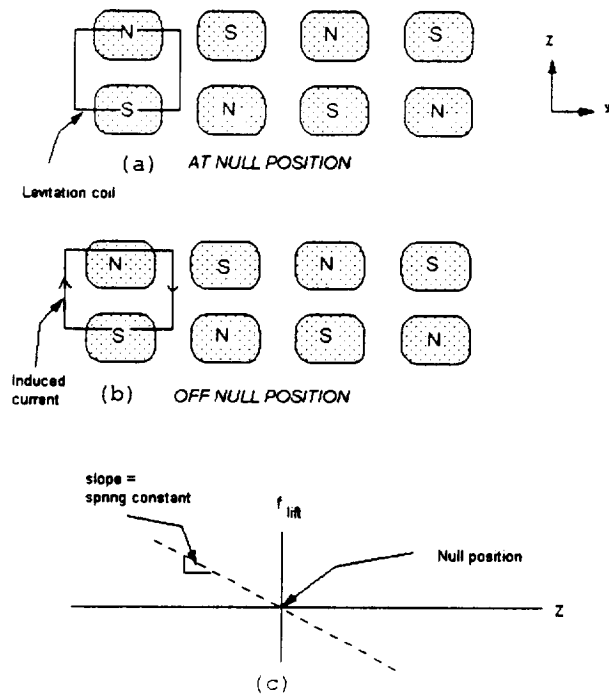

FIGURE 6

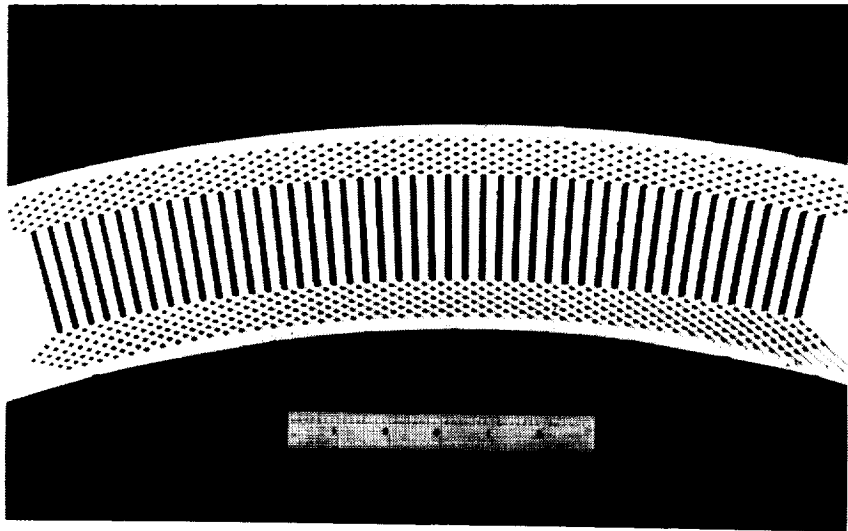
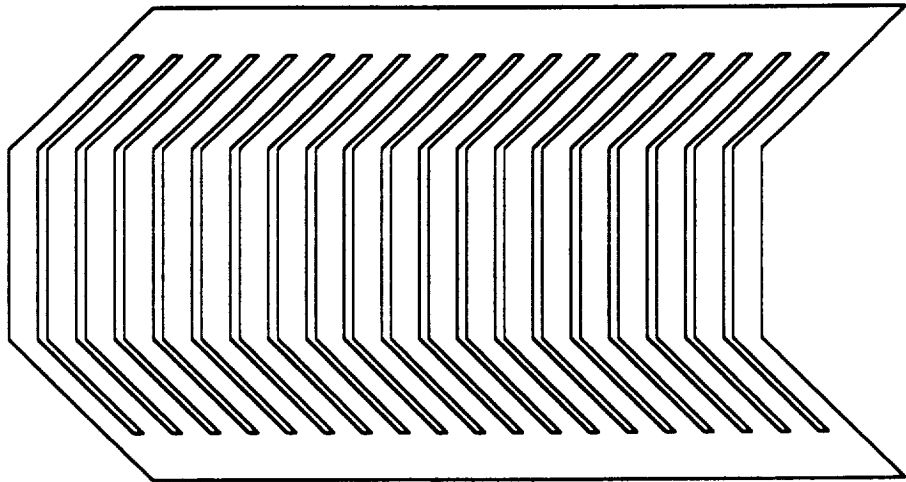
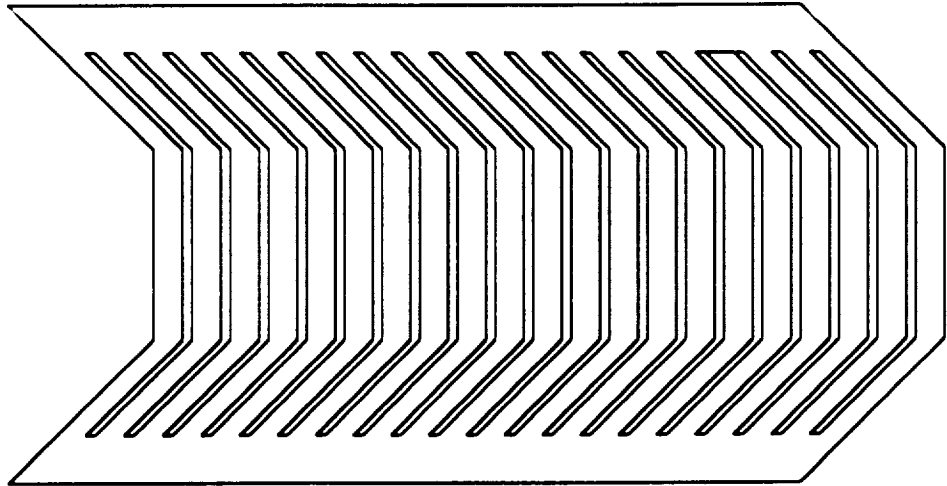

FIGURE 7

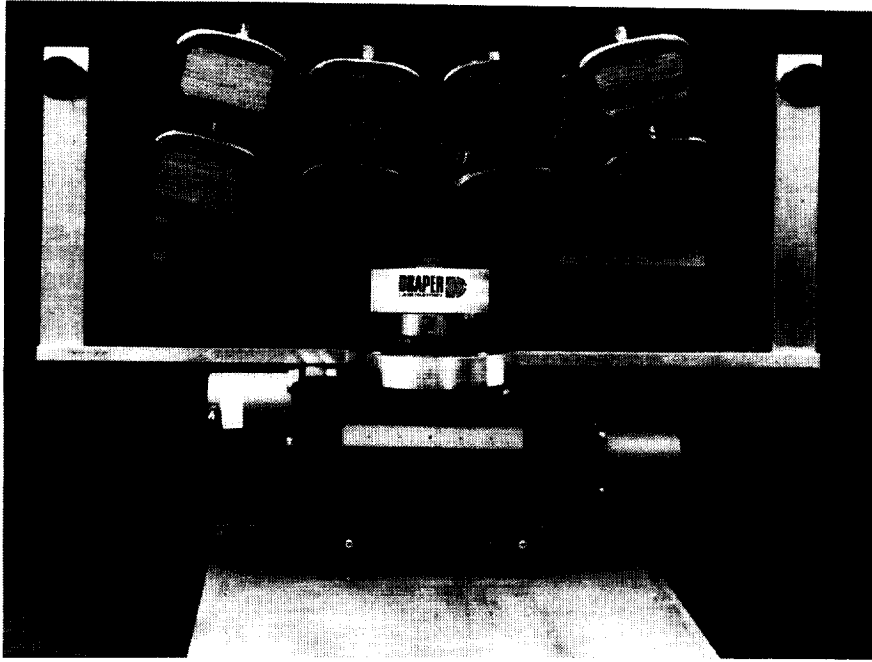

FIGURE 8

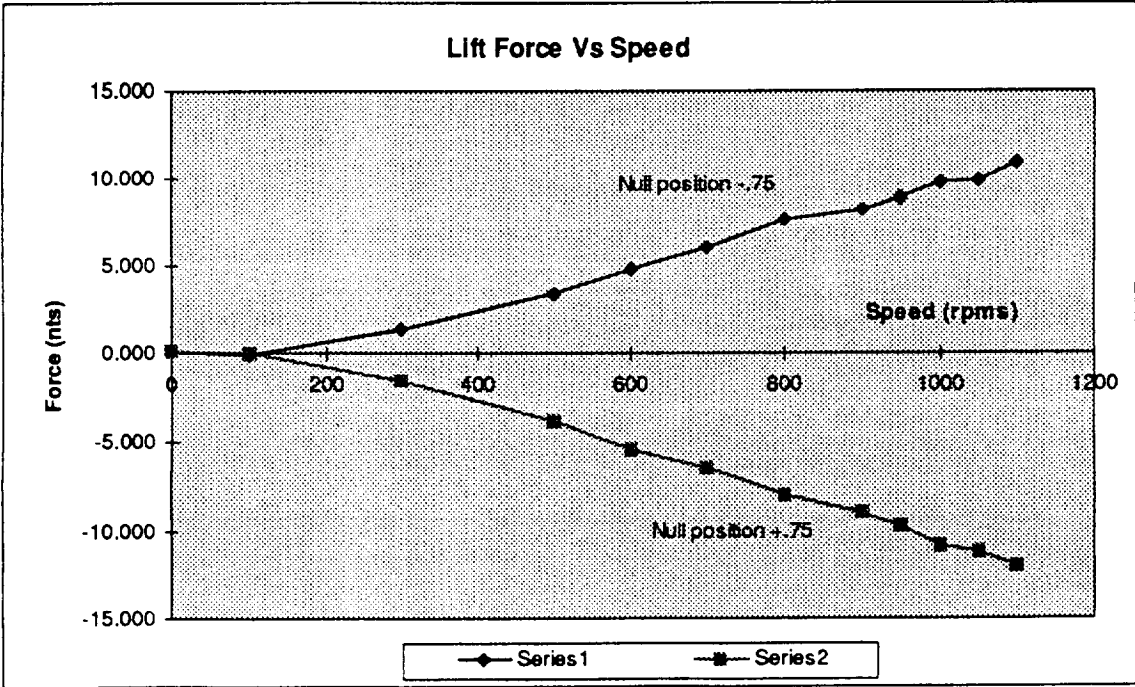

FIGURE 9

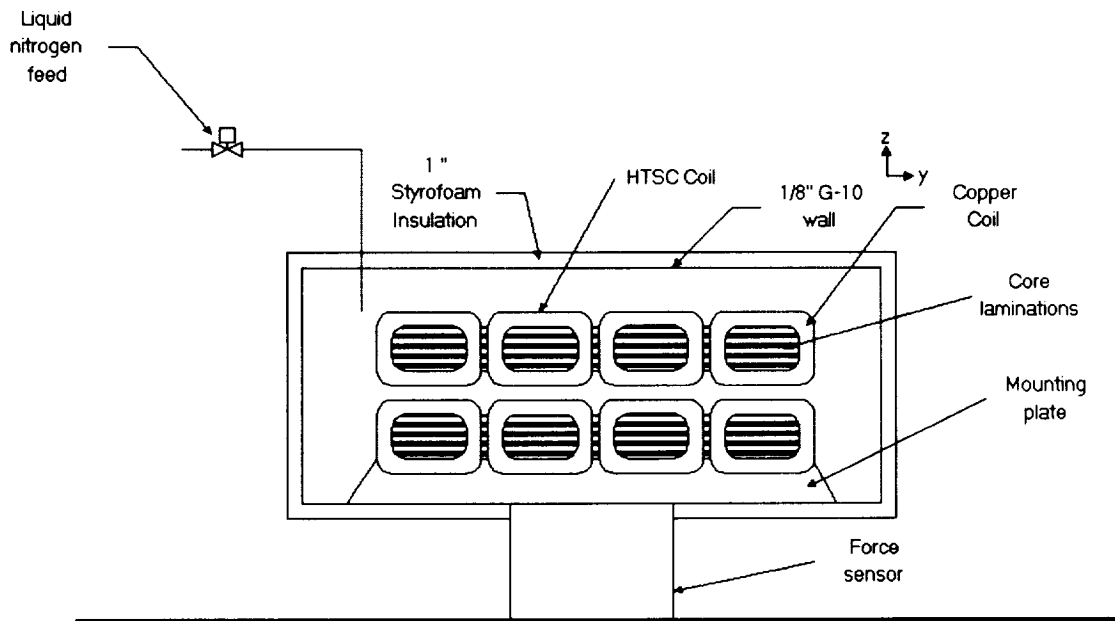

FIGURE 10

REFERENCES

1. Barrows, T.; McCallum, D.; Mark, S.; and Castellino, R.: "Aerodynamic Forces on MagLev Vehicle", DOT/FRA/NMI-92/21; December 1992.
2. Brown, W.; Dauwalter, C.; Heger, F.; and Weinberg, M.: "Comparison of Major Parameters in Electrodynamic and Electromagnetic Levitation Transport Systems, DOT/FRA/NMI-92/15, September 1992.
3. Final Report on National MagLev Initiative, September 1993.
4. Dauwalter, C.: "Loss and Guideway Interaction Force Measurements on a Superconducting Magnet for MagLev Applications", 12th International Conference on Magnetically Levitated Systems and Linear Drives, Argonne National Laboratory, May 1993.