



AIAA-95-1062

The Suitport's Progress

**M. Cohen
NASA Ames Research Center
Moffett Field, CA**

**Life Sciences and Space
Medicine Conference
April 3-5, 1995 / Houston, TX**

THE SUITPORT'S PROGRESS

Marc M. Cohen*
NASA-Ames Research Center
Moffett Field, California

Abstract

NASA-Ames Research Center developed the Suitport as an advanced space suit airlock to support a Space Station suit, based on the AX-5 hard suit. Several third parties proposed their own variations the Suitport on the moon and Mars. The Suitport recently found its first practical use as a terrestrial application in the NASA-Ames Hazmat vehicle for the clean-up of hazardous and toxic materials. In the Hazmat application, the Suitport offers substantial improvements over conventional hazard suits, by eliminating the necessity to decontaminate before doffing the suit.

Definitions

AX-5	Ames Experimental Suit 5
CCPS	Command/Control Pressure Suit
EMU	Extra-Vehicular Mobility Unit
EVA	Extra-Vehicular Activity
ft ³	cubic feet
Hazmat	Hazardous materials
IVA	Intra-Vehicular Activity
m ³	cubic meters
PLSS	Portable Life Support System
psi	pounds per square inch
SSF	Space Station Freedom
STS	Space Transportation System (Space Shuttle)
Suitport	An airlock design to allow rapid donning & doffing of a protective suit through a rear hatch.
V.E.R.	Volumetric Efficiency Ratio

*Architect, Advanced Projects Branch, Space Projects Division, Senior Member AIAA

Copyright © 1995 by the American Institute of Aeronautics and Astronautics, Inc. No copyright is asserted in the United States under Title 17, U.S. Code. The U.S. Government has a royalty-free license to exercise all rights under the copyright claimed herein for government purposes. All other rights are reserved to the copyright owner.

Origins of the Suitport

The Suitport Extravehicular Access Facility originated during the early phase of the Space Station Advanced Development Program. It grew from a recognition that the construction and operation of Space Station Freedom (SSF) would require several thousand hours of EVA time (This finding has not changed much for the new design for "Space Station Alpha." To make the best use of SSF crew time, it will become necessary to make the entire space suit donning and doffing, and airlock egress/ingress as safe, rapid, and efficient as possible.

The Space Shuttle EMU suit and airlock systems pose several potential disadvantages for frequent and routine Space Station operations. The shuttle airlock would not be large enough to accommodate two crew members suiting up into the hard, rear-entry AX-5 as it is fairly tight even for the soft, pull-on EMUs. However, the solution for Space Station was clearly not to build a bigger airlock because that would only increase atmosphere loss, pump-down time, power, and cooling.

All Space Shuttle EMU suit maintenance occurs on the ground. Perhaps the most important departure from this practice is, that the SSF suit must be maintainable, resizable, and repairable *on orbit*. This requirement suggested a radical departure from the traditional "dumb can" airlock design. It would involve automated servicing, and the ability to conserve atmosphere and other consumables much more efficiently than the EMU airlock system. Thus the problem definition for the Suitport involved considering strategies for conserving consumables. Secondarily, it involved additional considerations such as potential for protection against outside contaminants.

Strategies for Atmosphere Loss - The loss of atmosphere varies directly with the volume of the airlock. There are two strategies to handle this situation: to

“sacrifice the atmosphere” from the airlock to vacuum and to save on power, cooling and crew time OR to “save the atmosphere” and pay the cost in power, cooling, time, and complexity. Under either strategy, reducing the total volume of the airlock atmosphere contributes to savings on all the metrics, except perhaps complexity. The use of void fillers can be a fairly inexpensive way to reduce this pumpdown volume. Figure 1 illustrates dramatically the inverse relationship between electrical power for airlock pump down and the time required to pump down various airlock volumes from 1 atmosphere into a storage tank on a 10 to 1 compression ratio. This graph shows that to achieve rapid pump down under the *save the atmosphere* approach for a large airlock demands very large amounts of electrical power, compared to the then-anticipated SSF total capacity of 50 to 75 kW. For example, to pump down a 300 ft³ airlock in ten minutes would require about 25kW continuous during that period. It may also be possible to pump the airlock down to the SSF cabin atmosphere. However, pumping to the cabin would pose potential hazards of introducing external contamination into the station proper, because it would depend upon filtration rather than upon physical separation.

Comparative Analysis – The first step was to prepare comparative analyses of candidate airlock systems to support AX-5 suit operations.¹ The four airlock design concepts that received the closest attention were:

- A. An **STS-Type Airlock** enlarged to accommodate the rigid AX-5 suit.
- B. A **Transit Airlock**, as an adaptation of the STS airlock reduced by removing the suit servicing and don/doffing and placing it inside the station.
- C. The **Suitport EVA Access Facility** in which the AX-5 rear entry disconnect mounts to the airlock hatch, creating an extremely small pump down volume in the interstitial space between the suit rear hatch and the airlock hatch.
- D. The **Crewlock** developed by William Haynes of the Aerospace Corp., which uses conformal void fillers to minimize the pump down volume around the space-suited crew member.

The Suitport seeks to resolve the dilemma of pumpdown time versus power by saving on all the variables. By reducing the pump down volume by more than two orders of magnitude, it saves substantially on power, cooling, and pump down time. The volume of air in the interstitial volume between the space suit hatch and the airlock hatch is so small that it may become economical to sacrifice it to vacuum without pumping it down. Table 1 shows a comparison of the Suitport pump down volume against six other candidate airlock designs. These metrics show the potential order of magnitude improvements that the Suitport promises.²

Table 1. EVA Access Facility
Volumetric Efficiency Ratio (V.E.R.)

Suited Crew Volume = 0.22m³ (8.0 ft³)
for one crew member

$$V.E.R. = \frac{\text{Suited Crew Volume}}{\text{Pump-Down Volume}}$$

	AIRLOCK OPTION	PUMP DOWN VOLUME m ³ (ft ³)	V.E. R.
A	STS-Type Airlock (enlarged)	3.63 (129)	.062
A'	STS Existing Airlock	2.59 (92)	.087
B	Transit Airlock	1.86 (66)	.120
C	Suitport w/ PLSS Seal	.014 (0.5)	16.0
C'	Suitport No PLSS Seal	2.28 (81)	.098
D	Crewlock w/ Void Filler	.056 (2.0)	4.00
D'	Crewlock No Void Filler	1.49 (53)	.150

Strategies to Control Contamination – Two strategies exist for donning and doffing a protective suit without exposing the wearer to external contamination. These two strategies are “decontaminate before doffing” and “exit to a safe atmosphere.” In the *decontaminate before doffing* approach, decontamination must occur while the crew member is still in the suit, before opening its protective envelope. Current protective suits for hazardous material

cleanup follow this approach, as would the current NASA Space Shuttle EMU suit (should decontamination become necessary). In the *exit to a safe atmosphere* approach, the crew member can exit the suit to a safe environment without decontaminating first. The Suitport takes the exit to a safe atmosphere approach to an integrated systems level for both space operations and terrestrial applications.

Figure 2 illustrates a storyboard showing the operational scenario of how a crew member would prepare the suit before routine operations, don (enter) the suit, separate the suit from the Suitport and egress the station airlock. The Suitport offers a substantial improvement over the conventional airlock technology. The crew member enters the rear-entry hatch of the space suit through the Suitport. Closing the nesting suit rear hatch and Suitport hatch together, it is necessary only to pump down or vent off the very small amount of air in the interstitial volume between the two hatches, less than .035 m³ (1 ft³). Thus, the Suitport promises substantial savings in spacecraft atmosphere loss, crew time, electrical power, and pump cooling. The way the Suitport seals the suit to the habitable "shirtsleeve" atmosphere offers the additional advantages for contaminant isolation and control.

Suitport Design – A patent for a **Suitport Extravehicular Access Facility** describes the design idea in detail.³ Figure 3 shows a cross section through a dedicated Extravehicular Access module with a Suitport in it. Note the berthed connection to the SSF on the left and the "porch" on the right. Figure 4 shows a detail of an AX-5 type suit mated to the Suitport. This cross section identifies the interstitial volume requiring pump down as "43".

Space Station "Transition Technology" – In the later phases of the Space Station Advanced Development Program, it appeared that the schedule-driven design process might require a rudimentary STS-type airlock before it would be possible to build an advanced system. Jimmy Cawthorn included an "EVA Access Facility" in this "transition technology" phase.⁴ He proposed:

- (1) to develop enhancements to the Space Station IVA and EVA systems

that support productivity and safety in EVA operations,
(2) to develop advanced EVA airlock and servicing support system mock-ups for high-pressure hard space suits such as the AX-5

Cawthorn described "expected products":

- (1) an advanced EVA access facility combined airlock and servicing systems,
- (2) an EVA suit servicing, donning and doffing, egress and ingress computer simulation

This advanced airlock initiative came to a halt when NASA eliminated the Space Station suit from the budget. Instead, station planners proposed to stage EVAs out of the shuttle airlock to build the station, a scheme that proved inadequate and unworkable. Since that time, there is a space station airlock to support the space shuttle-type EMU, but not an advanced suit. Without an advanced station suit, there was no demand for an advanced Space Station airlock.

Third Party Adaptations

Since the Space Station Advanced Development Program, a number of third parties evaluated the Suitport and proposed applications for it. These ideas apply to space exploration, seeking to exploit the characteristics that would make the Suitport advantageous for Space Station and the NASA-Ames Hazmat program.

Boeing Lunar Airlock Analysis – The Boeing Defense and Space Group in Huntsville AL conducted an evaluation of several lunar airlock concepts on a variety of criteria. Initially, they compared six candidate airlock designs, including the Suitport.⁵ In their final assessment, they compared four design options: an STS-Type airlock, SSF "Crewlock," Suitport, and a "Doorlock" that they claim as their own. Although they prefer their own "Doorlock" for a Lunar surface application, still, they rated the Suitport highest for dust mitigation and consumables resupply.⁶

It is important to avoid semantic confusion here. The "SSF Crewlock" is an entirely different design idea than Hayne's Crewlock. Ironically, the Boeing Doorlock derives almost directly from Hayne's side-entry

Crewlock with void fillers. Table 1 presents Case and Capps' summary of their findings.

This Boeing study is the most thorough analysis of advanced airlock options to date. It is fascinating for a multitude of reasons. The Boeing assessment of the Suitport and the other airlock options is quite prescient, except for the few points noted below. They are correct that complexity is probably the biggest single challenge for designing a Suitport. Complexity affects suit maintenance as well. Launch packaging is more difficult to assess, as it depends upon one's presuppositions of what should comprise a launch package. The Boeing analysis evokes the following observations:

Table 2. Boeing Comparative Analysis of Four Airlock Options for the First Lunar Outpost

Airlock Options & Mass	Comparison Factor								
	Mass	Off-the-Shelfness	Complexity	Consumables Resupply	Volume	Launch Packaging	Suit Maintenance	Hyperbarics	Dust Mitigation
Modified STS 1,749 kg	O	√	√	O	O	O	O	X	O
SSF Crewlock* 2,843 kg	X	O	X	O	X	X	O	√	O
Suitport 1,904 kg	O	X	X	√	√	X	X	X	√
Doorlock 1,368 kg	√	O	√	O	√	√	O	X	O

Legend for Table 2.

√ = Good O = Fair X = Poor

Boeing's Comparison Factors - The nine "comparison factors" represent unweighted evaluation criteria. Yet for long term EVA operations, some criteria must receive more weight than others. From the perspective of lifetime operating cost, surely minimizing

consumables resupply should rate much higher than initial mass to orbit. The Boeing estimated difference between the Doorlock at 1,368 kg and the Suitport at 1,904 kg is only 536 kg, or about 39% of the smaller option. Table 1 suggests that the difference in lifetime consumables resupply on Space Station or a Lunar Base for the Suitport over the Doorlock will amount to hundreds of percent. For either the Suitport or the Doorlock over the STS or SSF type airlocks, the savings in consumables resupply will amount to thousands of percent. Therefore, the consumables resupply criteria must weigh much more heavily than initial mass to orbit.

Dust Mitigation - On the Lunar or Martian surface, dust mitigation and control will be one of the most critical factors for safe and efficient operations. All the non-Suitport options require decontamination before the suited crew member can enter the airlock. In a contingency situation this delay could be dangerous, and in an emergency, it could be fatal. Only the Suitport allows the crew member to doff the suit and escape to a safe atmosphere without undergoing decontamination first.

Hyperbarics - The Suitport patent provides for a hyperbaric capability.⁷ (). However, Boeing seemed to miss this provision in equating the Suitport to the Modified STS and Doorlock, which provide no hyperbarics.

"Off-the-Shelfness" - The purpose of the Suitport was to achieve order of magnitude improvements in airlock performance. It is axiomatic that it could not attain this goal by using "off-the-shelf" hardware (of which little in fact exists).

New Comparison - If one adjusts the comparison table to account for the preceding comments — hyperbarics, "off-the-shelfness," consumables resupply and dust mitigation — the results look substantially different. Table 3 shows this comparison revised to take into account the foregoing observations. Other than correcting the one omission under Hyperbarics, it does not alter any of Boeing's scoring. The outcome of this revision shows the Suitport in a dead heat with the Doorlock. This new comparison brings the Suitport into parity with the Doorlock. This result recalls the result of a 1986 assessment that found the William Haynes Crewlock (Boeing Doorlock) best for an

EMU-type suit and the Suitport best for a suit with a rear entry hatch.⁸

Ethan Clifton: "The Indigenous Architecture of Exploration," – As a subcontractor to Martin Marietta Space Systems for Mars exploration studies, Clifton proposed mounting a pair of Suitports directly into the pressure wall of a Mars habitat. He approached this application of the Suitport from the perspective of a Habitat designer, with a focus upon what made the most sense for habitat design and operation. Figure 5 shows a sketch of the "Operational Plan" for this Mars Habitat. Clifton hangs the suits completely outside the habitat, which might expose the suits to excess "weathering."⁹

Table 3. Modified and Weighted Analysis of Four Airlock Options Derived from the Boeing Analysis in Table 2.

Airlock Options & Mass	Comparison Factor w/ Weighting								Inferred Raw Score
	Mass	Complexity	Consumables Resupply X2	Volume	Launch Packaging	Suit Maintenance	Hyperbarics	Dust Mitigation X2	
Modified STS 1,749 kg	O	√	O	O	O	O	X	O	10
SSF Crewlock* 2,843 kg	X	X	O	X	X	O	√	O	7
Suitport 1,904 kg	O	X	√	√	X	X	√	√	13
Doorlock 1,368 kg	√	√	O	√	√	O	X	O	13

Table 3 Legend

√ = 2 O = 1 X = 0

Griffin Design Lunar Surface Suit – Brand Griffin of Griffin Design, developed a prototype rear-entry space suit and airlock interface on the Suitport principle. Griffin

developed his Command/Control Pressure Suit (CCPS) as a complete integrated, architectural system for lunar EVA, including helmet and visor design, backpack modularity, controls and displays, and maintenance support. Figure 6 shows two views of the CCPS suit, including the rear plane disconnect and backpack which would interlock with a Suitport. Griffin explains his adaptation of the Suitport primarily in terms of dust control:

"A major feature of the CCPS is a dust-resistant design. All displays are internal avoiding problems of dust buildup and except for the backpack, all pressure joints remain intact until servicing, minimizing exposure to dust. . . . Another feature which holds promise is a seal which mates directly to the module exterior allowing direct entry/exit without an airlock. This approach would not eliminate the airlock, but for routine operation, would avoid dust contamination."¹⁰

Griffin built a test suit flew it on the NASA-JSC KC-135 aircraft, in a simulated lunar gravity test. A photograph of the Griffin Design suit demonstrator on the KC-135 appears in Figure 7. Aviation Week and Space Technology described this test:

"The unit could plug into other vehicles, such as lunar rovers, and in effect become the cockpit or cab of the vehicle. The elimination of ingress/egress requirements for vehicles could become a huge advantage on the Moon where highly abrasive dust is expected to present a major challenge to surface operations. The life support system backpack of the Griffin Design suit would be on a door at the rear of the torso structure that would open to one side for ingress and egress."¹¹

NASA-Langley / Department of Energy Lunar Rover – M.D. Williams led a team at NASA-Langley and the DOE's Pacific Northwest Labs (Battelle) who proposed a lunar rover that included two Suitports mounted on the rear bulkhead. Although their illustration does not show the Suitport, Williams et. al. describe their specific adaptation of the Suitport to a Lunar Rover.

"The Suitport concept places AX-5-type hard suits outside the pressurized interior volume, attached directly to life support charging and checkout systems. Entry is through a backpack door on the suit that locks tight against the pressurized bulkhead. The suit itself can be shielded by a form-fitting cover that closes over it. This Suitport has the highest volumetric efficiency of any type tested so far, meaning minimal loss of interior atmosphere during pump down for entry and exit. It also prevents contamination of the interior by lunar dust that adheres to the suits. . . .

The two Suitports proposed for this rover could be housed in the aft end of the lab space. The area adjacent to the Suitport could house a receiving station for surface materials on one side and an enclosed hygiene facility on the other

Within the 2.4-m interior diameter of the lab cylinder, two Suitports could be positioned side by side, leading to an exterior "porch" on the aft of the rover." ¹²

A view of this lunar rover appears in Figure 8 This figure shows the rear "porch" recalling the EVA Access Facility module, with a robotic manipulator arm at the aft work station. Williams et al also provide a protective cover for the suit when not in use.

The NASA-Ames Hazmat Vehicle

The merits of the Suitport for keeping out contamination made it desirable as a design solution for a hazardous materials clean-up vehicle. Like the NASA Langley-DOE idea, the NASA-Ames Hazmat vehicle mounts two Suitports in the rear bulkhead. In 1994, Ames took delivery of an M577A3 armored personnel carrier on loan from FMC corporation. Philip E. Culbertson, Jr., the lead designer for the Hazmat vehicle, is making progress in adapting the Suitport to it. The two Suitports will provide direct, rapid don/doff access to two protective suits. In the ideal concept, a crew member will enter the suit through the rear entry, seal the two nested hatches behind him, decouple the

suit from the Suitport and go to work. When reentering the Hazmat vehicle, the crew member backs his suit against the Suitport and secures it to the hatch. He opens the hatches and backs out of the suit without exposing himself or the vehicle interior to the contamination on the outside. However, in the prototype, a tender does the latching and unlatching, not the person in the suit. To assist the suited person the Hazmat vehicle may have special hand rails or a rear "porch" in the manner of the NASA-Langley DOE Lunar Rover. Figure 9 shows an artist's sketch of an early concept for the Hazmat vehicle using its front-mounted robotic arm to stop a toxic leak from an overturned railroad tank car.

The Hazmat vehicle modifications will seal the interior cabin to protect it from contaminants in the external environment. It will have its own air-conditioning system. The circular hatches through which the driver and crew members can project their heads, will be covered and sealed with clear polycarbonate domes. Although Popular Mechanics referred to the Hazmat Vehicle as "the Chernobyl-Mobile," the entire effort so far focuses on chemical hazards and does not address radiation.¹³

This Hazmat vehicle promises several improvements over current hazardous materials cleanup procedures. It offers an improved level of safety for the crew both in the vehicle and wearing protective suits. It gives the crew members the ability to spend much longer periods of time in the "hot zone" without needing to retreat to rest or decontaminate. The crew members may return to the vehicle for a break or to eat lunch. A future version of the Hazmat vehicle may support a liquid cooling garment system inside the suit, decreasing the heat stress on the crew member and increasing the time he can work. The availability of the Ames Hazmat technology will enable faster emergency response to hazardous material accidents, and help the evaluation and cleanup proceed more quickly and safely. If the NASA-Ames prototype proves successful, many agencies will want one, including federal, state, and regional response teams, and perhaps some fire departments also. The Suitport in the Hazmat vehicle exemplifies the reinvestment of advanced space technology to benefit people on earth.

Conclusion

The Suitport derives from the application of a simple physical principle – minimizing the pump down volume – to achieve an improvement in airlock performance. In this respect, it is analogous to the economic payoff of weight savings. Several significant benefits follow from this innovation, especially the advantages for contaminant control that Boeing, Griffin, NASA-Langley/DOE, and the Ames Hazmat vehicle hope to realize. The next step in the Suitport's progress should be to build a full scale, pressurized proof of concept demonstrator.

References

- 1 Cohen, Marc M., & Bussolari, Steven, (1987, April) Human Factors in Space Station Architecture II – EVA Access Facility: A Comparative Analysis of Four Concepts for On-Orbit Space Suit Servicing, NASA TM 86856.
- 2 Cohen, Marc M., (1985, December 3-6) "Introduction: Ames Space Station Architectural Research," in Cohen, Eichold & Heers, eds, Space Station Human Factors Research Review, Vol. III, NASA CP 2426. pp. 44-58.
- 3 Cohen, Marc M., US Patent 4,842,224, (1989, June 27) Suitport Extra-Vehicular Access Facility.
- 4 Cawthorn, Jimmy M., (1986, July 7) "Space Station Transition Technology Recommendations," Space Station Program Office — Advanced Development Office, NASA-JSC, p. 12.
- 5 Case, C., Capps, S., Ruff, T., McGhee, J., Roberson, R., (1992, August) "'Doorlock' Single-Crew Conformal Airlock for First Lunar Outpost Application," presentation by Boeing Advanced Civil Space Systems Group, Huntsville, AL.
- 6 Capps, S., & Case, C., (1993, Feb 16-19) A New Approach for a Lunar Airlock Structure, AIAA 93-0994, Aerospace Design Conference, Irvine, CA
- 7 Cohen, (1989) op. cit., Figure 18D.
- 8 Cohen, Marc M., (1986, October 21) "EVA Access Facility Presentation to Space Station Advanced Development Review" at NASA-Johnson Space Center.
- 9 Clifton, Ethan W., (1993, October 12) "The Indigenous Architecture of Exploration," announcement of lecture, PG&E Architectural Series.
- 10 Griffin, Brand N. (1990, Sept. 25-28) A Space Suit Designed for Lunar Construction and Exploration, AIAA 90-3885, AIAA Space Programs and Technologies Conference, Huntsville, AL, p. 2.
- 11 Aviation Week & Space Technology, (1994, April 25) Vol. 140, No.17, "NASA tests new suit design at equivalent of lunar gravity," p 61.
- 12 Williams, M. D., De Young, R. J., Schuster, G. L., Choi, S. H., Dagle, J. E., Coomes, E. P., Antoniak, Z. I., Bamberger, J. A., Bates, J. M., Chiu, M. A., Dodge, R. E., and Wise, J. A., (1993, Nov.) Power Transmission by Laser Beam from Lunar-Synchronous Satellite, NASA TM 4496, pp. 19-20.
- 13 11. Popular Mechanics, (1994, Feb.) "Send in the Cherno-Mobile," p. 16.

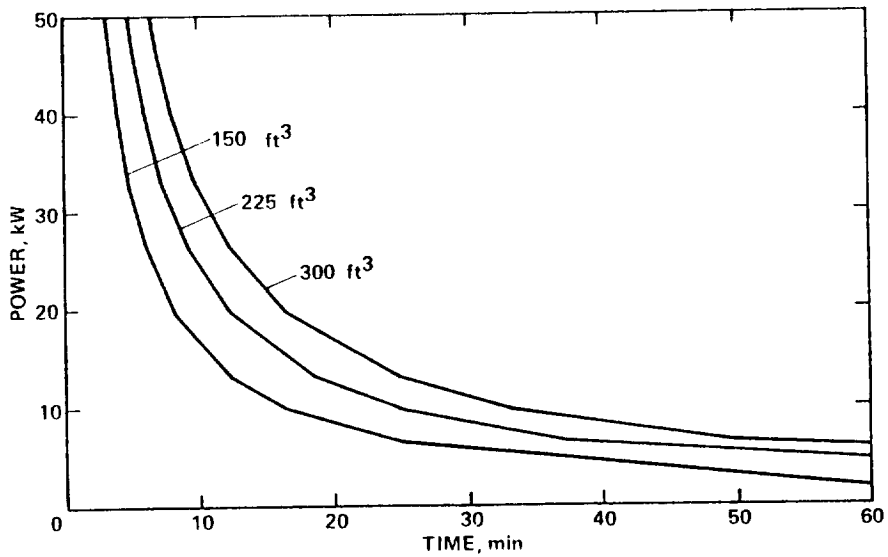

Figure 1. EVA Access Facility Power versus Time for three airlock volumes, showing pumpdown from one atmosphere to a pressure vessel at 150 psi on a 10 to 1 compression ratio, analysis by Bernadette Squire Luna.

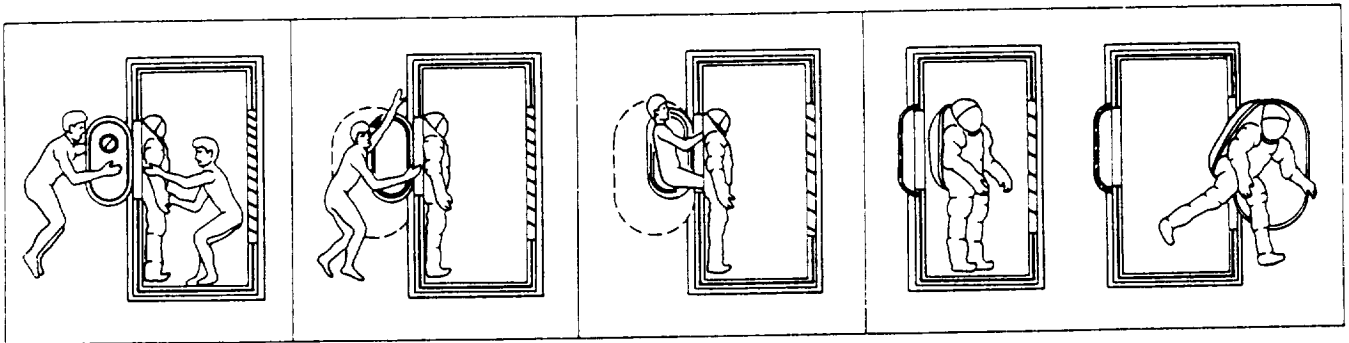

Figure 2 EVA Access procedures using the Suitport, adapted from NASA TM-86856.

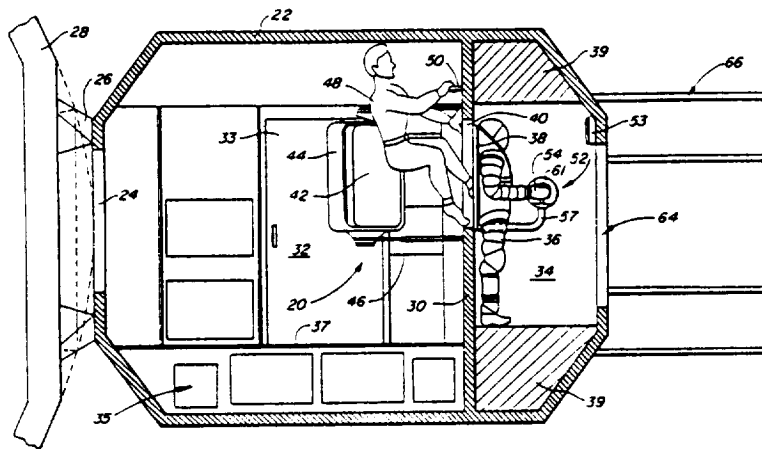

Figure 3. Suitport in a dedicated module, from US Patent 4,842,224

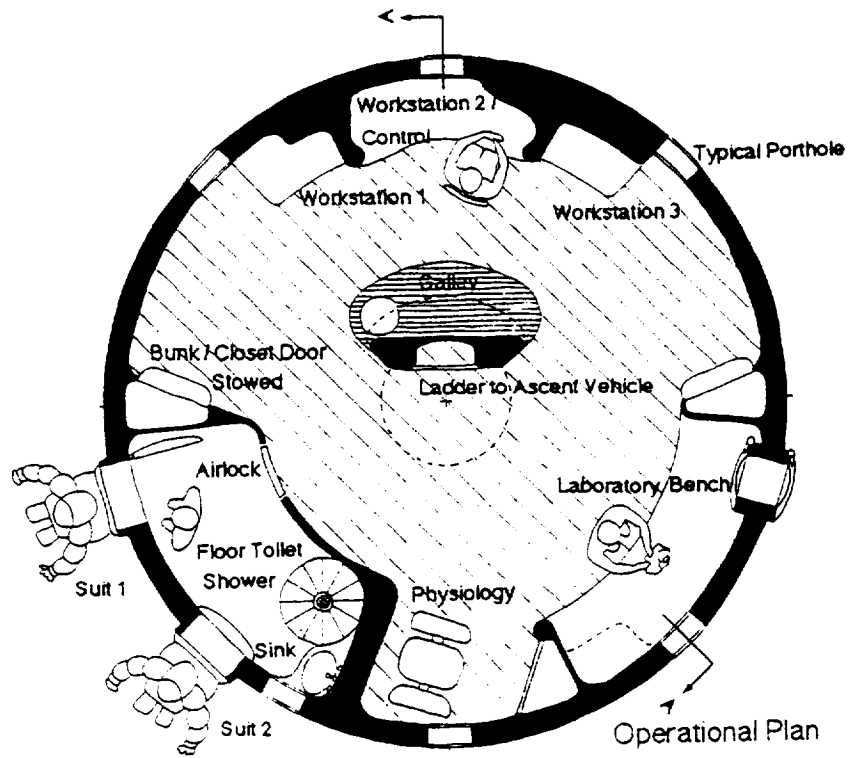

Figure 5. Plan view of 2 Suitports mounted in Ethan Clifton's Mars Habitat. Drawing courtesy of Ethan Clifton, Architect.

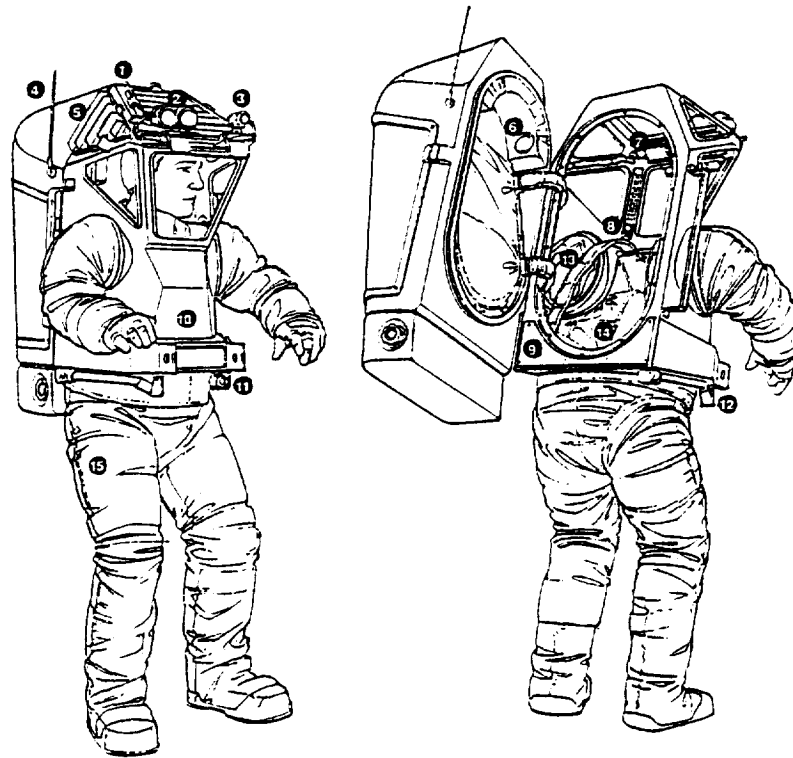

Figure 6. Two views of Brand Griffin's CCPS, showing the rear entry disconnect (9) between the backpack and the suit's hard upper torso. Drawing courtesy of Griffin Design.

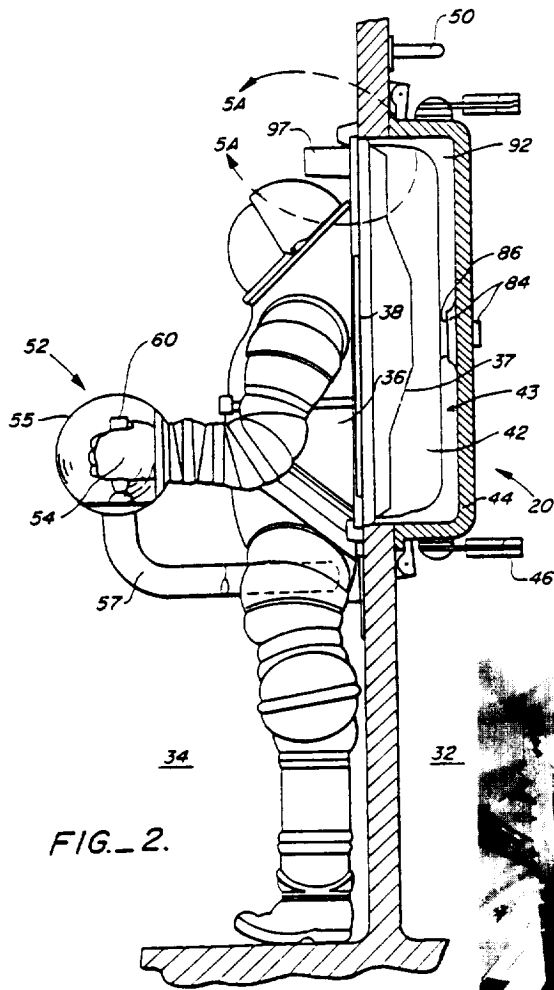

FIG. 2.

Figure 4. Detail of Suitport showing rear plane disconnect for both the AX-5 space suit's PLSS backpack and the Suitport inner hatch, from US Patent 4,842,224.

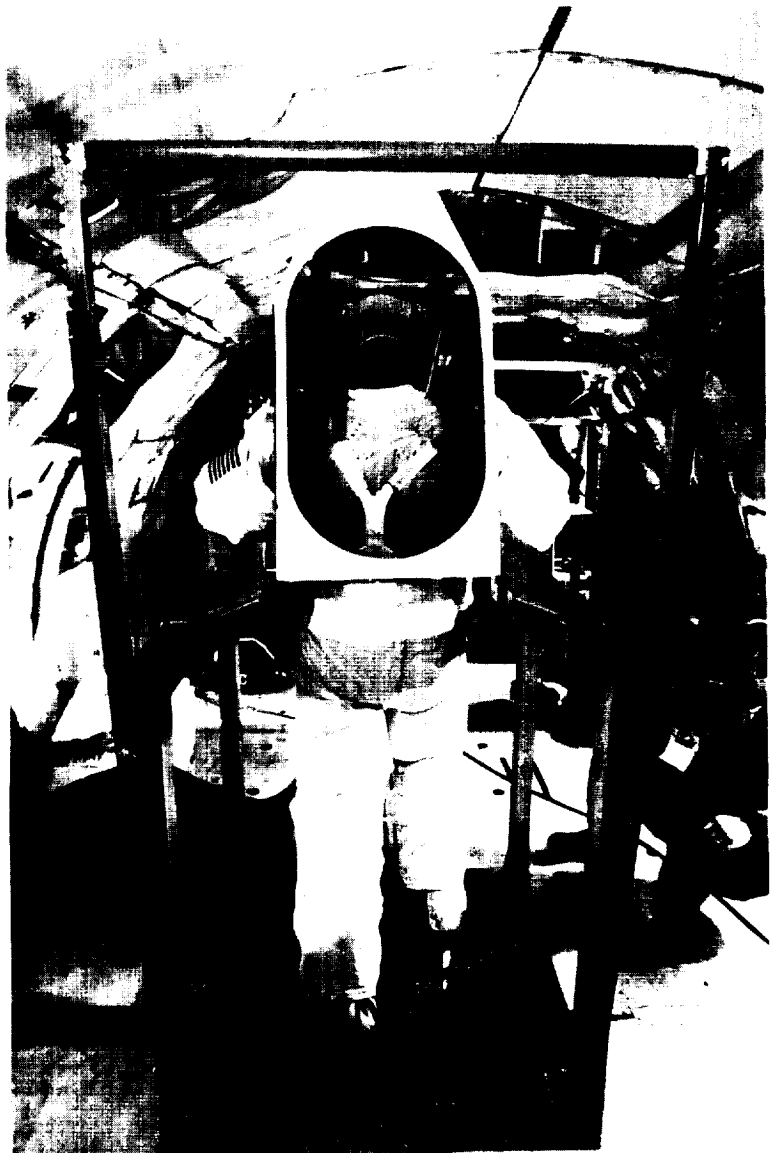

Figure 7. Simulated lunar gravity flight test of the Griffin Design CCPS suit on the NASA-Johnson Space Center's KC-135 aircraft. photo courtesy of Griffin Design.

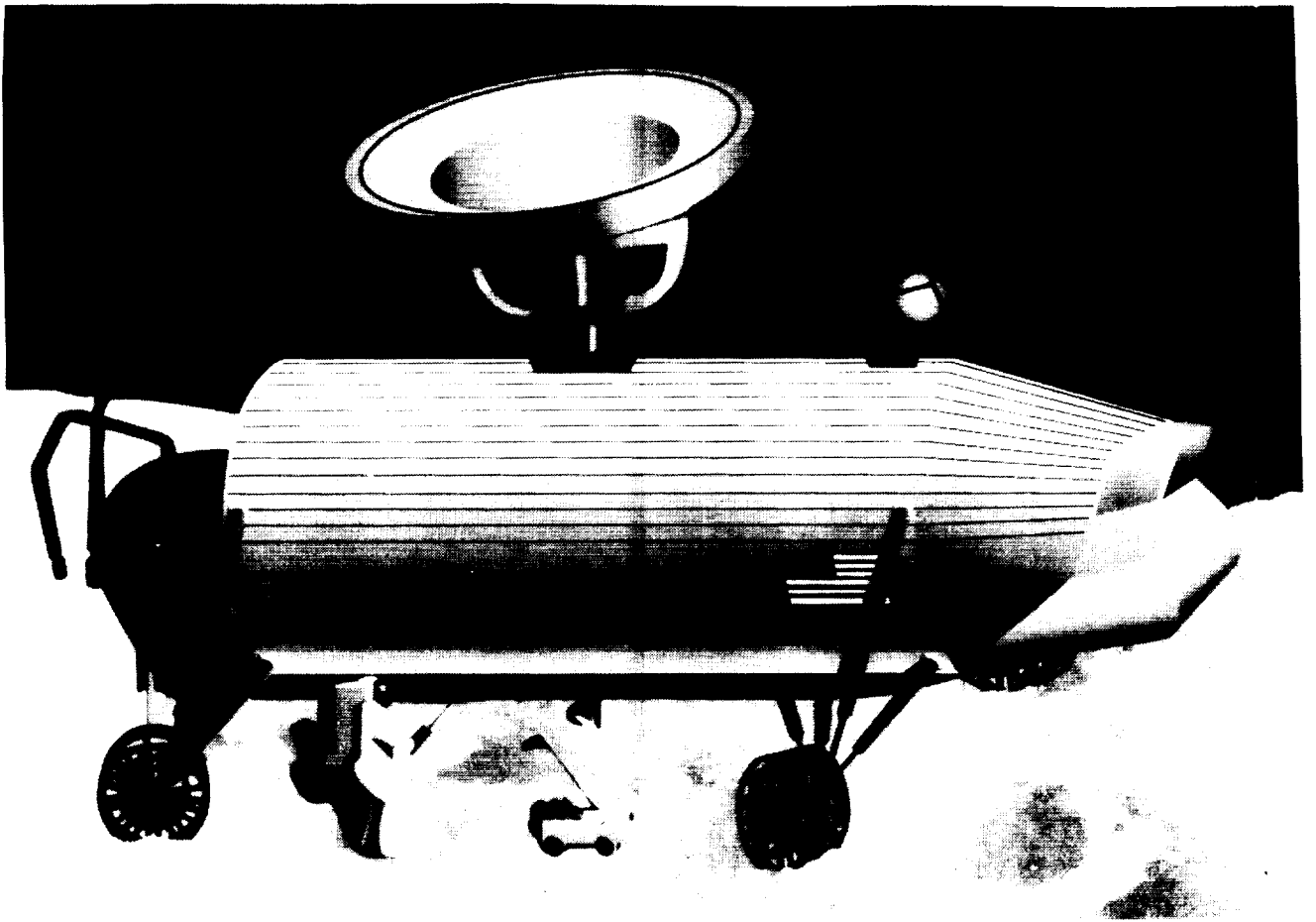

Figure 8. Side view of the proposed NASA-Langley/DOE Lunar Rover, mounting two Suitports in the aft bulkhead, from NASA TM-4496.

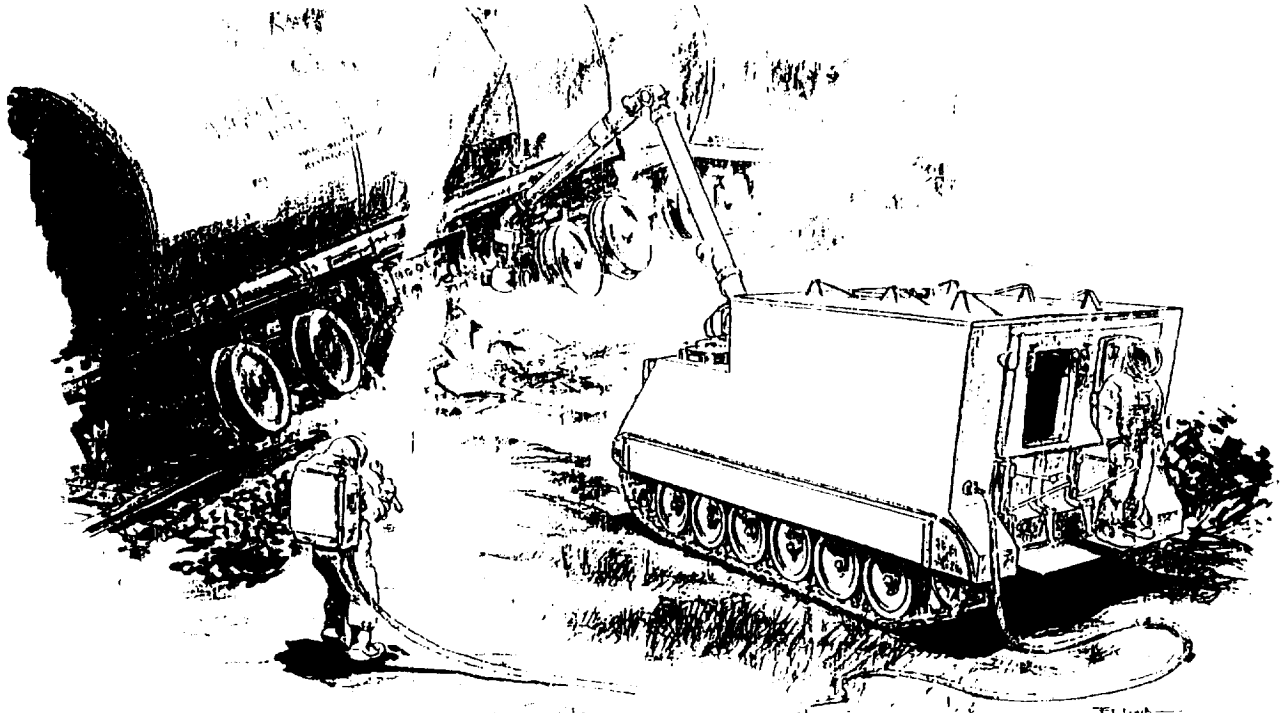

Figure 9. Artist's rendering of the NASA-Ames Hazmat vehicle design, with two Suitports in the aft bulkhead, courtesy of Douglas Smith, NASA-Ames.