

1N-13
0-8913

NASA Technical Memorandum 107352

Attitude Control Subsystem for the Advanced Communications Technology Satellite

Alan W. Hewston
Lewis Research Center
Cleveland, Ohio

Kent A. Mitchell
Lockheed Martin Missiles and Space
East Windsor, New Jersey

and

Jerzy T. Sawicki
Cleveland State University
Cleveland, Ohio

November 1996



National Aeronautics and
Space Administration

ATTITUDE CONTROL SUBSYSTEM FOR THE ADVANCED COMMUNICATIONS TECHNOLOGY SATELLITE

Alan W. Hewston
National Aeronautics and Space Administration
Lewis Research Center
Cleveland, Ohio 44135

Kent A. Mitchell
Lockheed Martin Missiles and Space
East Windsor, New Jersey 08593

and

Jerzy T. Sawicki
Mechanical Engineering Department
Cleveland State University
Cleveland, Ohio 44115

SUMMARY

This paper provides an overview of the on-orbit operation of the Attitude Control Subsystem (ACS) for the Advanced Communications Technology Satellite (ACTS). The three ACTS control axes are defined, including the means for sensing attitude and determining the pointing errors. The desired pointing requirements for various modes of control as well as the disturbance torques that oppose the control are identified. Finally, the hardware actuators and control loops utilized to reduce the attitude error are described.

INTRODUCTION

The Advanced Communications Technology Satellite (ACTS) has been referred to as both a "Blueprint for Future Telecommunications," and a "Switchboard in the Sky." The ACTS Project is funded by the National Aeronautics and Space Administration (NASA), and is managed by the Lewis Research Center under the Office of Space Science and Applications at NASA Headquarters. ACTS is a key to reaching NASA's goal of developing high-risk, advanced telecommunications technology to support our nation's future communications needs (ref. 1).

ACTS users and experimenters come from NASA, private industry, the armed forces, banking and commerce, science and education, hospitals, and other government agencies. The ACTS primary RF (Radio Frequency) communication link operates in the Ka Band frequency, with a 30 GHz uplink and a 20 GHz downlink. The advanced communications technology introduced by ACTS and tested by its users will not be mentioned here.

ACTS was launched in September 1993 and is expected to provide a useful platform for communications experiments until its hydrazine propellant supply runs out (current estimate June 1998). Figure 1 shows the ACTS spacecraft in its on-orbit, deployed configuration.

ATTITUDE CONTROL SUBSYSTEM FUNCTIONAL REQUIREMENTS

All communication experimentation takes place during the operational phase of the ACTS mission. During its operational phase, ACTS is a geosynchronous communication satellite maintaining an equatorial orbit stationed at 100.0° West Longitude. The ACTS pre-operational phase is described in appendix A.

The success of the ACTS mission relies on the proper function of all of the ACTS ground and flight systems including that of the Attitude Control Subsystem (ACS). The primary function of the ACS is to provide a stable spacecraft for communication experiments, so that the various downlink communications are sent in tight focussed beams to their proper ground locations.

Specific operational functions include:

- Provide attitude sensing necessary for: (1) closed-loop three-axis attitude control, (2) automatic active nutation damping, and (3) two-axis (pitch and roll) attitude determination on the ground.
- Provide closed-loop pitch axis control through the exchange of momentum between the spacecraft and the momentum-bias wheel.
- Provide closed-loop roll/yaw axes control by magnetic torquing.
- Damp spacecraft nutation.
- Offset point the spacecraft independently in pitch and roll.
- Provide control for propulsive torquing utilizing thrusters to: (1) adjust system momentum, (2) apply controllable torques about the spacecraft yaw, roll and pitch axes for added control, and (3) perform stationkeeping maneuvers.
- Provide telemetry signals of required flight system variables, including those required to effect three-axis attitude control from the ground.

ACTS GEOMETRY AND CONTROL AXES DEFINITIONS

ACTS is a three-axis stabilized, geosynchronous communications satellite that views the same surface of the Earth for its entire 24 hr orbit. Figure 2 shows the ACTS spacecraft control axes, which are defined as follows:

- The positive X direction, called the Yaw axis, points to the Zenith (directly opposite the Earth's surface). The spacecraft Apogee Kick Motor (AKM) Panel is perpendicular to the positive X axis.
- The negative X direction points to the Nadir, or subsatellite location on the Earth. The spacecraft Antenna Panel is perpendicular to the negative X axis. Thus, the antennas are always facing the ground.
- The positive Y direction, called the Roll axis, points due East along the orbital flight path vector. The spacecraft East Panel is perpendicular to the positive Y axis.
- The negative Y direction points due West, opposite the orbital flight path vector. The spacecraft West Panel is perpendicular to the negative Y axis.
- The positive Z direction, called the Pitch axis, points due North, perpendicular to the orbital plane. The spacecraft North Panel is perpendicular to the positive Z axis.
- The negative Z direction points due South, perpendicular to the orbital plane. The spacecraft South Panel is perpendicular to the negative Z axis.

The spacecraft axis convention follows the right-hand rule. The structural bus of the ACTS spacecraft is a cube comprising the six panels mentioned above. Each spacecraft panel is aligned parallel to two of the spacecraft axes and perpendicular to the third.

ATTITUDE DETERMINATION

In order for the spacecraft axes to be controlled, the attitude (or pointing) of each spacecraft axis must be known or determined. Onboard sensing devices provide raw attitude data to the Attitude System Processor (ASP). In addition to storing the most recent sensor data, the ASP also contains the majority of all ACTS attitude control logic firmware and control parameters. The ASP firmware determines both the attitude errors and the control necessary to reduce them.

Pitch and Roll Axis Attitude References

Earth Sensor Assembly.—The most widely used attitude reference for a geosynchronous spacecraft is the Earth. The ACTS spacecraft, as well as most three-axis stabilized, geosynchronous communications satellites, use Earth sensing devices to provide the attitude reference for both their pitch and roll axes. The horizon and/or surface of the Earth is viewed from the spacecraft in its geosynchronous orbit.

Each ACTS Earth Sensor Assembly (ESA) is mounted external to the spacecraft's Antenna Panel because this is the only S/C surface that views the Earth continuously throughout the orbit (day). The ESA is mounted so that its sensing axis is aligned with the spacecraft negative X (Yaw) axis. ACTS has two ESAs, a primary and a redundant unit, at least one of which is always powered on. Nominally both are powered on. The ESA detects only radiation in the carbon dioxide band of the infrared region (14 μm wavelength). This radiation is fairly uniform across the Earth's surface, and is not affected by daylight, darkness, or the day/night terminator. The ESA makes two independent scans during each 8 Hz cycle. One scan sweeps across the Northern hemisphere in a plane that is inclined 6.07° above (North of) the ACTS pitch-yaw plane. The other scan sweeps across the Southern hemisphere in a plane that is inclined 6.07° below (South of) the ACTS pitch-yaw plane. From the geosynchronous altitude, a 6.07° scan angle corresponds to 45° of Earth latitude. The scans are made with the same frequency and at a uniform speed. Figure 3 shows the ESA scan geometry.

Because at least one unit is always powered on, ESA data is always available. The ESA data can become unreliable if the Sun or Moon is present in the field-of-view of either scan. The Sun and Moon both emit infrared radiation that can corrupt the ESA sensing. When ground calculations predict the presence of the Sun or Moon in a scan, that scan (North or South) is inhibited by a command from the ground. While one scan is inhibited, the data from the available scan, together with the standard reference chord is used to determine the pitch and roll attitudes. It is geometrically impossible for the Sun to be in one field-of-view and the Moon in the other. Therefore, valid data is always available in at least one of the scans. Spacecraft analysts are responsible for generating and maintaining accurate position data regarding the Sun and Moon.

The ESA is a practical sensing device because it has a wide field-of-view ($\pm 15^\circ$ along the scan direction) and can remain powered on at all times. The ESA's data becomes invalid if the Earth is outside of the sensor field-of-view.

The Attitude Determination Process for the ESA.—The pitch and roll attitude determination process is relatively straightforward for the ESA because its sensing axis is aligned with the spacecraft yaw axis. Any movement of the S/C yaw axis, either a roll and/or pitch rotation, would be observed directly as if the Earth was moving within the ESA field-of-view.

The ESA scan: Either ESA scan across its field-of-view will observe the following order of events. Deep space, having no radiation signature; followed by an abrupt increase in radiance (the Sky/Earth horizon); followed by a sustained period of viewing the Earth (at nearly constant radiation); followed by an abrupt drop off in radiation (the Earth/Sky horizon); followed again by deep space having no radiation signature. The scan begins at the edge of the field-of-view and sweeps across to the other edge of the field-of-view. The scan has a width of 1.65° .

Pitch: The pitch attitude is measured by using the average of two scan cycles. On each scan, an encoder measures the angle between the sensed Sky/Earth horizon crossing and the scan reference pulse. The scan reference pulse is in the dead center of the ESA scan (East to West). Likewise, the encoder measures the angle between the scan reference pulse and the sensed Earth/Sky horizon. Pitch attitude is then digitally computed as half of the difference between these two angles.

Roll: The roll attitude is also measured by using the average of two scan cycles. The difference in the horizon crossing angles corresponds to the chord length of the Earth. The chord length is larger or smaller depending upon the Earth's latitude along that scan. If the chord length is small, the latitude is farther from the equator. If the chord length is long, the latitude is closer to the equator. The scan latitude corresponds to the angular rotation of the spacecraft roll axis. Given the scan geometry, the ratio of the difference in chord lengths (between the North and South scans) to the roll error is four to one.

When one of the ESA scans is inhibited (not available due to Sun or Moon interference), the remaining chord is compared only to the standard chord. The standard chord at 0.0° error is equivalent to that of 45° (North or South) latitude. Pitch and roll accuracy is decreased when one scan is inhibited.

If the yaw error is zero, the North and South scans are parallel to the equator, which lies in the center of the scan. If the yaw, pitch, and roll errors are all zero simultaneously, the ACTS pitch axis would be parallel to the Earth's spin axis, the roll axis would be parallel to the equatorial plane, and the Yaw axis (and ESA boresight) would point to the center of the Earth. All ESA calculations are made with the assumption that there is little or no yaw error present. With a yaw error present, the ESA scan would not be parallel to the equator, but at an angle equivalent to the yaw error. The ESA cannot properly account for a nonzero yaw error.

Finally, the data provided by the ESA tends to be somewhat noisy and does not have the high degree of accuracy desired during ACTS experimentation. For this reason, the Autotrack Receiver System, a more accurate pitch and roll axis sensor, is used. The ESA nominally functions as the backup pitch/roll attitude reference.

Autotrack Receiver System.—The primary pitch/roll attitude reference is the Autotrack Receiver System or autotrack. The autotrack system uses a new and improved sensing technique when compared with the ESA. The autotrack system has a smaller field-of-view, but provides higher pointing resolution and with much less noise than the ESA. Because of its smaller field-of-view, autotrack can only be used when the spacecraft is pointed within 0.25° of the Cleveland reference signal. The Cleveland reference signal is a microwave signal at 29.975 GHz generated by the ACTS Master Control Station (MCS), at the NASA Lewis Research Center. The autotrack receiver is used to lock onto the ACTS MCS by monitoring the phasing of the components of the reference signal. A wave guide feed-horn and coupler are used to break the signal into different RF modes and to process the data through the receiver into discrete azimuth and elevation error signals proportional to the angular offset. The Autotrack feed horn is integrated into the Cleveland receive beam of the antenna system.

The Attitude Determination Process for the Autotrack.—The autotrack discrete azimuth and elevation signals are converted by the autotrack electronics into binary “counts.” The counts are sent to the ASP, where they are converted into degrees pitch and roll. The ASP converts these counts via a polynomial curve fit for each axis.

If the ESA sensed attitude error exceeds $\pm 0.25^\circ$ (the limit of the autotrack field-of-view), or if the autotrack sensor data is not updated for more than two consecutive data samples, the autotrack is no longer considered a valid attitude reference. If this occurs, the ASP automatically commands a switch to the ESA as the active pitch/roll attitude reference. Ground operators may also command a switch of the active attitude reference from ESA to autotrack or from autotrack to ESA at any time. Note that the ACTS spacecraft only uses one attitude reference for active control at a time. This one reference (either the ESA or autotrack) provides the attitude data for both the pitch and roll axes. The pitch and roll axis telemetry for both the ESA and autotrack is available at all times that they are powered on.

Switching the Pitch and Roll Axis Attitude References

The S/C design permits a ground commanded change in the Pitch and Roll axis attitude reference. This feature is used twice daily during the geostationary eclipse season—near the Vernal and Autumnal equinoxes. During the eclipse, little or no power is generated by the spacecraft solar arrays since they are shadowed either partially or completely from the Sun. Thus, spacecraft electrical power is only available from the onboard batteries. The battery power is limited as the size of the batteries was (by design) reduced to decrease launch weight. To reduce the strain on the power budget, most or all of the ACTS payload, including autotrack is not operated during eclipse. While powered off, the autotrack is not available as an attitude reference.

Prior to each eclipse, the spacecraft is routinely commanded to switch the Pitch/Roll attitude reference to that of the ESA. After the eclipse is over, the autotrack can be powered up, and shortly thereafter can again be used as the Pitch/Roll attitude reference.

Every time that the pitch/roll attitude reference is switched, there exists the potential for an attitude error discontinuity. A discontinuity can be caused by thermal gradients that effect both the sensor operation and mechanical alignment. The attitude sensors behave nonlinearly when exposed to large thermal gradients. Likewise, their mechanical alignment can be affected by temperature change. The thermal effects are the result of variations in the seasonal and diurnal shadowing on the sensors and mounting structure. These temperature changes are not extreme, but are large enough to yield a difference in the attitude measurement of the sensors.

If a sensor switch occurs when the sensors (ESA and autotrack) are not in agreement then the ASP will see a jump in magnitude of the sensed pitch and/or roll attitude errors. This could result in greater than normal control torques, which could rotate the spacecraft faster than desirable for the ACTS communications experiments. The primary function of the ACTS Attitude Control Subsystem is to provide a stable platform for the communication experiments.

Pitch and Roll Axis Attitude Biasing

A feature of the ACTS Attitude Control Subsystem that can be used to minimize the effects of changing the attitude reference is attitude biasing. Nominally, the attitude control loops will attempt to reduce the attitude error so that the spacecraft points to the zero of the attitude reference. When using a nonzero attitude bias, the spacecraft will attempt to point to an offset angle relative to the zero of the attitude reference. The offset angle has the same magnitude, but the opposite polarity to the bias.

Prior to the attitude determination process, the pitch and roll bias angles are added to the sensed attitude. If it is desired to point ACTS with a North and East offset, a negative pitch bias and a negative roll bias would be used. Table I shows the range and resolution of the ACTS attitude biasing capability.

To reduce the potential for an attitude discontinuity, the ESA pitch and roll biases are often changed prior to the switching of the attitude reference. These biases (angles) minimize the current difference between the ESA and autotrack attitudes. In daily operation the spacecraft attitude analyst determines the appropriate ESA pitch and/or roll biases.

Yaw Axis Attitude Reference

Sun Sensor Assemblies.—The ACTS Sun Sensor Assemblies are the sole attitude reference for the ACTS yaw axis control. Like the Earth, the Sun can only be used as an attitude reference when it is in the sensor field-of-view. Unlike the Earth, the Sun (appears to) moves around the spacecraft exactly once per day. To get the best utilization of the Sun sensors, they should be mounted on external surfaces of the spacecraft that view the Sun for significant portions of the day. The spacecraft East and West Panels were the best locations to mount the sun sensors because each has minimal or no field-of-view problems to overcome, and each surface views the Sun at a different (non-overlapping) time of day.

ACTS has four Sun sensor assemblies, each with a $\pm 31.5^\circ$ half-cone field-of-view (fig. 4). Two sensors are mounted on both the East and West Panels. One sensor on each panel is active during daily operational life. The other is a backup unit. The East Panel Sun sensors are mounted perpendicular to that panel, aligned with the positive roll axis. The West Panel Sun sensors are mounted 15° from the perpendicular of that panel. The 15° cant angle, relative to the negative roll axis, is necessary to prevent the ACTS Receive Antenna from blocking or reducing the Sun sensor's field-of-view. This 15° cant angle results in a one hour shift (later) in the West Sun sensing window as described later.

The Sun sensors only detect direct or reflected Sunlight. Most stray light sources, such as from the stars, or the Earth's or Moon's albedo are insufficient to effect the sensors. To prevent reflected sunlight from entering the field-of-view, all Sun sensors are shielded with baffles and nearby spacecraft components are covered or coated with a very low reflectivity material.

The Attitude Determination Process for the Sun Sensor.—Whenever Sunlight is observed by the Sun sensors, an angular measurement is provided to the Attitude System Processor. Only the yaw component of the sensor data is used by the ASP in the yaw attitude determination process. The attitude determination process for the yaw axis is more complex than that of pitch and roll because the yaw attitude reference, the Sun, moves continuously in the sensor field-of-view.

There are two factors that complicate this motion:

(1) From the spacecraft's point of view, the Sun appears to be moving around the spacecraft, once per day. This rate is of course the same as the spacecraft's orbital and rotational rates which match the Earth's rotational (spin) rate.

(2) The yaw attitude reference motion occurs usually in more than one S/C axis. The Sun moves in the Ecliptic (Earth-Sun) plane. The ACTS geosynchronous orbit lies in the Earth's equatorial plane, which is inclined 23.44° with respect to the ecliptic plane (fig. 5). In this orbit, the Sun appears to move sinusoidally (up and down) relative to the yaw axis, up to $\pm 23.44^\circ$ throughout each day. This daily sinusoidal motion also changes throughout the year, as the Earth's equatorial plane remains fixed, yet the Earth revolves around the Sun.

The attitude determination process must continuously compensate for this relative motion between the spacecraft and the Sun. Precise information about the spacecraft orbit, and time of year Sun-Earth geometries are used to predict the Sun's actual position relative to the S/C. The difference between the predicted and sensed Sun vector is the yaw attitude error.

Yaw Ephemeris Data.—The ACTS yaw ephemeris data provides the predicted Sun vector throughout the day. The ephemeris prediction is provided to the yaw attitude determination algorithm every control cycle (30 sec). The ephemeris data must be current, and accurate for the yaw attitude error calculation to be "determined" properly.

The attitude analyst generates the ephemeris data with specialized ground software. The inputs include: the position versus time throughout each orbit and season of both the S/C and the Earth (relative to the Sun); and any known

biases to S/C control axes. The ephemeris tables provide precise angular information (azimuth and elevation) to determine the actual position of the Sun relative to the S/C throughout each orbit. The ephemeris data contains the opening and closing times of all Sun sensing windows (described later), and all clock and timing functions used by the yaw control loop.

The ephemeris table is generated once per week and is reviewed by the spacecraft analyst. The data (tables) are typically uploaded to the spacecraft on the same day every week. The data tables are loaded and stored in 2 separate locations of ASP RAM. One location stores the older ephemeris table (actively being used by the Yaw attitude determination algorithm). The other location stores the new ephemeris tables (future). Once stored, the data is then echoed back to the ground computers via telemetry (ASP RAM data dump). The ACTS ground software verifies that every bit stored in the ASP is identical to that on the ground. If a mismatch exists, the entire loading process must be checked and repeated.

The ephemeris table is valid for a period of eight days, which provides a one day overlap between the old and new data. This allows for greater operational flexibility as well as yet another source of data verification. The existing ephemeris data for day eight can be compared to the newly loaded ephemeris data for day one. These should match or be nearly identical since they represent the same day. After all of these checks are made, the ASP can then be commanded to switch to the newly loaded ephemeris table.

Some specific parameters that significantly impact the ephemeris predictions include: The Sun declination varying up to $\pm 23.44^\circ$ throughout the day/year, the Earth's eccentric orbit about the Sun (yielding a change in the Sun's position up to 1.9°), the S/C position within the orbit changes (ideally 100.0° West Longitude). In addition to the weekly update, the ephemeris must be reloaded whenever the attitude bias to any axis is changed more than 0.03° or a stationkeeping maneuver (described later) is performed.

Sun Sensing Windows.—The Sun sensors can only provide yaw attitude when the Sun is within their field-of-view, also known as the Sun sensing windows. There are two Sun sensing windows in each 24-hr orbit, one for the East Panel Sun sensors and one for the West Panel Sun sensors. Each Sun sensing window becomes “open” when both, (1) the sun presence bit indicates the presence of the Sun, and (2) the ephemeris data predicts the Sun to be in the sensor field-of-view. If one of these conditions is not met, the Sun sensing window is considered “closed.” When the Sun sensing window is “open”, the actual yaw attitude can be “determined” and thus used by the yaw control loop. When the Sun sensing window is “closed,” the yaw attitude error is unknown, but the yaw estimation algorithm can provide a “predicted” yaw attitude.

Nominally, each Sun sensor has a 31.5° half-cone field-of-view which can provide up to 4 hr and 8 min of Sun coverage. The East Panel Sun sensing window is centered about 6:00 A.M. S/C local time. The West Panel Sun sensing window is centered about 5:00 P.M. S/C local time.

East windows nominally open at 03:56 S/C local time
East windows nominally close at 08:04 S/C local time
West windows nominally open at 14:56 S/C local time
West windows nominally close at 19:04 S/C local time

The seasonal variation in the Earth-Sun geometry can reduce the sensing window duration as much as 16 min.

ACTS ATTITUDE CONTROL POINTING REQUIREMENTS

In order to support the ACTS primary mission of utilizing advanced communications technology, the communications platform must provide a high pointing accuracy during nominal operations. The fine pointing requirements for nominal operations are driven by the use of 0.3° spot beams. ACTS operations are considered nominal at all times other than when housekeeping maneuvers are being performed. The attitude control pointing requirements for each spacecraft axis are shown in table II.

DISTURBANCE TORQUES

The continuous presence of disturbance torques corrupt the pointing of one or more axes. Disturbance torques are caused by forces present in the ACTS orbital environment, acting about the spacecraft center of mass. In

decreasing order of significance, the ACTS disturbance torques are caused by solar radiation (pressure), gravity gradient, Radio Frequency (RF) power output, and residual magnetic dipole. The magnitude and direction of these disturbance torques vary diurnally, seasonally, and over the lifetime of the spacecraft. Figures 6 to 8 (ref. 2) show the pre-launch (predicted) ACTS composite environmental disturbance torques for Winter Solstice, Equinox and Summer solstice respectfully. Individual disturbance torques (described later) often have components acting in each of the three spacecraft axes. Additional information on S/C disturbance torques can be found in Wertz (ref. 3).

Solar Radiation (Pressure) Torques

Solar radiation incident on the spacecraft's surface produces a force which results in a torque about the spacecraft's center of mass. The magnitude of the solar radiation pressure varies as an inverse square of the distance traveled. Therefore all Earth orbiting spacecraft will see the same (uniform) solar radiation intensity except during solar storms, or when eclipsed by the Moon or Earth.

The spacecraft's surface is subjected to radiation pressure, or force per unit area equal to the vector difference between the incident and reflected momentum flux. The momentum flux varies with the optical properties of each surface. The solar torque imparted on each surface is the radiation pressure of that surface multiplied by its moment arm from the spacecraft center of mass. The net spacecraft solar torque is the sum over all spacecraft surfaces.

Factors affecting the ACTS solar radiation torque are:

- spacecraft geometrical asymmetry,
- pitch axis (daily) rotation,
- shadowing and eclipse of the spacecraft,
- Earth albedo reflections on the spacecraft,
- solar storm activity,
- the time of year variation in Sun declination, and
- significant changes in the spacecraft mass properties,

The solar radiation torques have a larger diurnal variation (in magnitude and direction) than all other ACTS environmental disturbance torques. The pitch axis solar radiation torque also accounts for nearly all of the secular torque components. Secular torques are those having a net accumulation over time.

Gravity Gradient Torque

Because the ACTS spacecraft does not have a symmetrical mass distribution, it is subject to gravity gradient torque. Gravity gradient torque results from the Earth's inverse-square gravitational force field. The ACTS gravity gradient torque oscillates in direction and is relatively small in magnitude compared with solar pressure torques.

Radio Frequency Power Output Torques

The ACTS payload nominally utilizes two or three RF transmitters operating nominally at 48 W each. Except during eclipse, the RF transmitters are continuously powered on, radiating through the large transmit antenna dish mounted near the West side of the spacecraft. The RF power output produces a secular pitch axis torque. This torque is smaller in magnitude than the solar radiation torques, but because it has the opposite polarity, it helps to reduce the pitch axis secular torques (ref. 2).

Residual Magnetic Dipole Torques

Magnetic disturbance torques result from the interaction between the spacecraft's residual magnetic field and the geomagnetic field. The primary sources of magnetic torques are spacecraft magnetic moments, eddy current, and

magnetic hysteresis. The ACTS spacecraft design minimizes these sources. Once again, such torques are in the noise level compared with solar pressure torques.

Internal Spacecraft Torques

In addition to the environmental disturbance torques, a spacecraft can cause its own torques - most often caused by internal moving parts. Because ACTS does not have many internal moving parts, the only torques that need to be considered are:

- Motion of the ACTS Steerable Antenna - by command.
- Propellant tank sloshing - only a factor shortly after stationkeeping maneuvers.
- Solar Array and antenna flexible motion.

ATTITUDE SYSTEM PROCESSOR

As previously mentioned, all attitude sensor data are provided to the Attitude System Processor. The ASP uses the sensor data to determine the attitude errors and then commands the attitude control actuators to reduce the errors. The ASP RAM stores the values of all control loop gains, variables, and coefficients as well as all ephemeris data. All of the data stored in the ASP RAM can be sent to the ground via a telemetry RAM dump. The ASP also continuously echoes all sensor data to the ground every two seconds via telemetry. Some critical data points are sent via telemetry at 8 Hz.

The ASP ROM contains the logic (firmware) for nearly all attitude control loops. This logic commands the selection of attitude control actuators, their duration, magnitude, and polarity. Figure 9 provides an operational mode functional block diagram of the ACS. The connections between the attitude sensors, the ASP and the attitude actuators are shown.

ATTITUDE CONTROL ACTUATORS (HARDWARE)

Momentum Wheel Assembly

ACTS has both a primary and a backup Momentum Wheel Assembly (MWA). Each MWA is comprised of a momentum-bias wheel and an electronics package that regulates the wheel speed. The MWAs are mounted next to each other on the interior of the spacecraft's Southwest Panel and are aligned with the momentum wheel axis, parallel to that of the spacecraft pitch axis (local North). The spacecraft's pitch axis has gyroscopic stiffness from both the rotating spacecraft and the momentum-bias wheel.

One MWA is active and electrically powered at all times providing for pitch axis stability and attitude control. The S/C design precludes any practical application for using both MWAs simultaneously. The control of the pitch axis is provided by transferring angular momentum from the rotating wheel to the spacecraft and vice versa. The angular momentum is proportional to the wheel speed. The sum of the angular momentum in the system (MWA plus spacecraft) is a constant. Therefore an increase (decrease) in the wheel speed, will result in a proportional decrease (increase) in the spacecraft's pitch axis rotational rate.

Electrical power is continuously provided to the MWA Electronics to manage all command and data functions. The MWA electronics contain the wheel speed circuitry (logic) that controls the voltage drop across the MWA motor. This is part of the pitch control loop. The rotational rate of the momentum wheel has a limited operational range from 5400 to 6600 rpm. The MWA tachometer provides wheel speed data (feedback) directly to the control circuitry in the electronics.

Magnetic Torquer Assemblies

ACTS has two Magnetic Torquer Assemblies (MTAs), used to both damp out spacecraft nutation and to minimize the attitude errors in the roll and yaw axes. The MTAs consist of a solid iron/nickel alloy torque rod, wrapped with

two isolated (redundant) copper wires. 'Upon activation of a voltage of appropriate polarity, the MTA, by interaction with the Earth's magnetic field, will provide the necessary torques to reduce the effects of spacecraft disturbances' (ref. 4).

The roll axis MTA is mounted on the AKM Panel (aligned with the roll axis), and provides a yaw dipole moment (control torque). The yaw axis MTA is mounted internal to the spacecraft near the center bulkhead (aligned with the yaw axis), and provides a roll dipole moment (control torque). Upon activation, the torquer coil is provided a constant magnitude electric field which interacts with the Earth's magnetic field to produce a mechanical torque. The torque is created by taking the cross product of the torquer magnetic field with the existing Earth magnetic field. Thus the roll axis MTA provides a yaw control torque, and the yaw axis MTA provides a roll control torque.

At the geosynchronous altitude of an equatorial orbit, the local Earth magnetic field is roughly parallel to the Earth's North/South axis. The Earth's magnetic field is typically within 8° of the spacecraft pitch axis. The magnetic field strength varies around the Earth due to the constant push of the solar wind. Slight deviations in the direction and strength of the local magnetic field can also be caused by the extra terrestrial environment such as solar storms.

Rocket Engine Assemblies (Thrusters)

ACTS utilizes three sizes of Rocket Engine Assemblies (REAs) providing thrusts of 0.2, 0.5 and 1.0 pound-force respectively. The REAs, or thrusters, expel a hydrazine propellant to impart linear and/or angular momentum to the spacecraft. The hydrazine propellant is stored within the four propellant tanks located near the center of the spacecraft mass. Valves and plumbing connect the propellant tanks with each of the spacecraft's 16 thrusters. The thrusters are mounted on various spacecraft panels as shown on figure 10. Some of the thrusters are canted at angles from the surface of the spacecraft.

The thrusters were used mainly during the ACTS pre-operational mode. During the operational mode, the thrusters are nominally used only for momentum unloading and stationkeeping maneuvers. The thrusters can be selected in various combinations to provide specific spacecraft maneuvering capabilities. Although many of the useable combinations result in similar thrust capabilities, this is necessary to provide for system redundancy. A failure of either redundant pair of thrusters would not prevent the spacecraft from accomplishing its mission.

ATTITUDE CONTROL LOOPS

Pitch Axis Control Loop

The pitch control loop reduces the pitch axis pointing error by varying the speed of the MWA. Figure 11 is a simplified functional block diagram of the Pitch control loop. The pitch axis control loop functions as follows:

- The pitch axis attitude data is provided to the ASP at 4 Hz by both the ESA and autotrack sensors.
- The ASP converts the autotrack attitude data into degrees.
- The ASP subtracts any pitch offset bias terms from the sensed attitude to yield the actual attitude error.
- The error is then multiplied by the appropriate gains to compute the desired momentum wheel speed "demand."
- The ASP wheel speed "demand" (RPM) is sent to the MWA electronics at 2 Hz.
- The ASP wheel speed "demand" is added to the residual wheel speed demand (remainder from the last control cycle) to get the current wheel speed demand.
 - The current wheel speed demand is quantized into a commanded demand (the maximum allowed). The remainder is the new residual wheel speed demand.
 - The commanded wheel speed demand is equivalent to a voltage (Δ), which is added to the existing voltage drop across the motor. This changes the wheel speed, which changes the MWA angular momentum, which changes the spacecraft angular momentum, which changes the spacecraft pitch axis rotation rate, reducing the pitch axis attitude error.
 - The residual wheel speed demand (being less than the minimal voltage drop), is saved, and added to the next control cycle.
 - The MWA electronics control loop also compares the commanded wheel speed to that seen by the tachometer.

Roll/Yaw Control Loop

The roll/yaw control loop reduces the roll and yaw axis pointing errors by magnetic torquing. Figure 12 is a simplified functional block diagram of the roll and yaw control loops.

The ACTS roll/yaw control loop has a 30 sec operational control cycle. During the cycle, each magnetic torquer (one roll, one yaw) is either energized (at a constant voltage drop) from 3 to 30 sec, or inactive. The polarity of the control torque is changed by reversing the voltage drop across the torque rod.

Roll Axis Control Loop.—functions as follows:

- The roll axis attitude data is provided to the ASP at 4 Hz by both the ESA and autotrack sensors.
- The ASP converts the autotrack attitude data into degrees.
- The ASP subtracts any roll offset bias terms from the sensed attitude to yield the actual attitude error.
- At the beginning of a control cycle, the error is multiplied by the appropriate gains to determine the yaw MTA on-time, and polarity needed.
- The ASP commands the desired on-time and polarity to energize the yaw MTA, causing the interaction with the Earth's magnetic field, generating a roll axis control torque.

Yaw Axis Control Loop.—functions as follows:

- The roll axis attitude data is also provided to the yaw attitude determination algorithm.
- The Sun sensor data (when available) is provided to the yaw attitude determination algorithm. The algorithm then compares the data with any yaw offset bias terms and the yaw ephemeris to compute the current yaw attitude error.
- The yaw estimator (observer) algorithm receives the current roll and yaw (when available) attitude errors, and the most recent yaw torquer polarity and on-time demand. The algorithm uses this data to continuously update a 4th order polynomial used for yaw error estimation. The polynomial predicts the yaw error throughout the entire orbit, but the prediction is only used for control when Sun sensor data is unavailable.
- At the beginning of a control cycle, the yaw error (estimated/actual) is multiplied by the appropriate gains to determine the roll MTA on-time, and polarity needed.
- The ASP commands the desired on-time and polarity to energize the roll MTA, causing the interaction with the Earth's magnetic field, generating a yaw axis control torque.

Yaw Modes of Control.—The yaw control loop has three primary control modes, Normal, Standby, and Stationkeeping, and one optional control mode, Monitor mode. The Stationkeeping mode is only used during house-keeping maneuvers. The Standby mode is used when the yaw estimation algorithm has not converged. The Normal mode is the nominal mode of control. The Monitor control mode option can be invoked while using Normal or Standby Mode.

In the Normal mode, the sensed yaw attitude (error) is used both to update the yaw estimation algorithm and to provide (independent) yaw axis control. The Normal mode is considered to be independent (of roll) because the yaw control torque is based upon the yaw attitude error.

In the Standby mode, the independent yaw control loop continues to be active, but now the yaw control torque is based upon the roll attitude error. This works with some degree of success because the yaw and roll control are coupled through the yaw/roll gyro-compassing action of the pitch bias-momentum spacecraft. Each time the roll axis control loop calculates the yaw MTA on-time demand, this is scaled down and used for the roll MTA on-time demand as well. The polarity of the roll MTA matches that of the yaw MTA.

In the Stationkeeping mode, the MTAs are disabled and roll and yaw control torques (if needed) are provided by the RCA thrusters.

An optional mode, the Monitor mode, can be invoked while already in the Normal or Standby modes. In the Monitor mode, the attitude determination algorithm provides the yaw attitude error for telemetry purposes only. In other words, the error is "monitored," but is not passed on to the control loop. The monitor mode is most often utilized after a stationkeeping maneuver. The yaw Estimator algorithm continues to propagate, but also without using the "sensor determined" attitude update.

HOUSEKEEPING TASKS

Orbit Determination

In order to determine the need for performing a stationkeeping maneuver, the orbital parameters need to be determined. The orbit determination process begins with the collection of ranging files over several locations in the orbit. Each ranging file establishes the spacecraft speed and location (relative to the Cleveland beacon) at some position in the orbit. The ranging data collection process is routinely performed every hour, taking approximately five minutes per file. When ranging files are combined for several orbital locations, the orbital parameters can be determined. The more ranging files, and the greater the distribution over the orbit, the more accurate the orbit can be determined.

With knowledge of the current orbital parameters, the orbit analyst usually plans a stationkeeping maneuver that can minimize the propellant expenditure. After the maneuver has been completed, the orbit analyst will once again collect ranging files to assess the performance of the maneuver and to determine the parameters of the new orbit.

Stationkeeping Maneuvers

ACTS Orbit and Station Box.—All geosynchronous spacecraft must be maintained in their orbit within a specified station box. The ACTS orbital station at 100.0° W Longitude has a box that is $\pm 0.05^\circ$ in both longitude and latitude.

Spacecraft orbits are perturbed by asymmetric gravitational forces, such as the Earth's nonuniform density and the positions of the Moon and the Sun relative to the spacecraft orbit. Stationkeeping (S/K) maneuvers must be performed before the orbit degrades to the edge of the spacecraft station box. S/K maneuvers consist of the firing of thrusters to correct the orbit and return it to near the leading edge of the station box. The leading edge is opposite the side of the station box toward which the spacecraft was drifting. North/South S/K reduces the inclination error to maintain the proper latitude. East/West S/W corrects the position error to maintain the proper longitude. S/K maneuvers are required every two to four weeks.

Rate Measuring Assemblies.—During S/K maneuvers, additional thrusters are required to minimize the spacecraft rotational rates and maintain the pointing attitude. The ACTS Rate Measuring Assemblies (RMAs) provide this rotational rate information. ACTS has three (RMAs), mounted inside the spacecraft bus, one for each of the three spacecraft axes. Each RMA houses a primary and redundant set of electronics components and gyroscopes. After each gyroscope is spun-up to its operational speed, the (offset) angle relative to the spacecraft axis is measured. This initial offset angle is used as the basis for comparison of attitude errors and rotational rates during the S/K maneuver. All RMA outputs are provided to the ASP to augment the ESA attitude data. The ASP S/K control logic commands the firing of thrusters to counteract excessive rotational rates. Figure 10 shows the location and size of all thrusters.

The thrusters are operated in the following modes:

- On (fired continuously),
- On-pulsed (fired only for a selected pulse width)
- Off-pulsed (fired continuously except for a selected off pulse width)

Proper thruster activity can be summarized as follows:

- Spacecraft analysts determine the need for the maneuver or thruster use.
- Maneuver plans include the thruster selection, start time and duration of the thrusting, and pulsing mode.
- Ground commands activate the thruster cat-bed heaters, and Rate Measuring Assemblies (RMAs) one-half hour prior to thruster activation. The cat-bed heaters are necessary to warm the catalytic material in the propellant.
- Ground commands select the valve configuration.
- Ground commands activate the proper modes and parameters in the control loop(s).
- Ground commands activate electrical relays - initiating thruster activity in the REAs.

New Ephemeris Load.—When a stationkeeping maneuver is planned, the “expected” new orbit is used to generate the new ephemeris tables. If the stationkeeping maneuver is completed successfully, the new ephemeris tables will probably be acceptable to use. Prior to using the new ephemeris table for the attitude determination process and active yaw control, the yaw “monitor” mode is used. The yaw monitor mode allows the attitude analyst to verify that the new ephemeris matches the new orbit. If the maneuver was not properly completed, then a new ephemeris table must be loaded before leaving the yaw monitor mode. Regardless, a new set of ephemeris is always generated based upon the new orbit determination. This set is usually uploaded, as it will be more accurate than the set calculated prior to the maneuver.

Momentum Unloading

Momentum unloading is a housekeeping task that is required every three to five days to counteract the pitch axis secular torque buildup (from solar radiation pressure). As previously mentioned, the pitch axis torque is controlled by varying the momentum wheel speed. A decrease in the wheel speed causes angular momentum to be transferred (increased) to the spacecraft pitch axis, thus counteracting the pitch disturbance. Before the wheel speed reaches its lower operational limit of 5400 rpm, it must be reset. The MWA wheel speed is reset during the momentum unloading task.

Automatic Pitch Error Momentum Adjustment Control.—The Automatic Pitch Error Momentum Adjustment Control (APEMAC) is utilized during the momentum unloading task. The roll/yaw control loops are placed into their respective S/K modes and the pitch control loop is disabled in favor of the APEMAC. The RMAs provide attitude rate information to the APEMAC. The momentum wheel speed can then be reset (near the maximum), while the thrusters provide the necessary pitch torque to maintain pitch axis pointing.

CONCLUSION

The Attitude Control Subsystem for the ACTS spacecraft is typical of most geosynchronous communications satellites. At the time of this writing, 2-1/2 years into the life of the mission, the ACTS ACS has performed well, and continues to meet all functional requirements. The pitch and roll axis pointing performance has benefitted by the high resolution provided by the Autotrack Receiver System. The use of Sun sensors permits an independent yaw control loop to provide not only improved yaw axis pointing, but also knowledge (via telemetry to the ACTS experimenters) of what the actual yaw errors are.

Further areas of study could be to describe the ACS pre-operational function and operations, interpretation of attitude parameters observed in telemetry, pointing performance using the independent yaw control loop, and increasing the operational lifetime by operating in an inclined orbit.

APPENDIX A

ACTS PRE-OPERATIONAL PHASE

On September 12, 1993, ACTS was launched from the NASA Kennedy Space Center (KSC), launch complex 39B as the primary payload of mission STS-51 - Discovery. The Space Transportation System (STS) - Shuttle Discovery achieved a typical STS parking orbit, inclined 28.45° (same as the NASA KSC latitude) from the equator.

Prior to the launch, the ACTS spacecraft was mated to the Martin Marietta/Orbital Sciences Corporation - Transfer Orbital Stage (TOS). The combined ACTS/TOS payload was deployed by the STS-51 crew while in the STS parking orbit.

Once deployed from the STS Discovery, thrusters on the TOS upper stage were used to spin-up the ACTS/TOS spacecraft about the axis aligned with both the TOS motor and ACTS Apogee Kick Motor (AKM). A laser inertial navigation system was used to reorient the TOS spin axis to its proper firing attitude. Forty-five minutes later the TOS ignited its solid propellant rocket motor for a second impulsive burn, 120 sec in duration. The TOS burn both reduced the orbital inclination, and placed the combined ACTS/TOS spacecraft into a geosynchronous transfer orbit. At the designated time in the geosynchronous transfer orbit, the TOS commanded the ACTS and TOS to separate.

Once separated from TOS, the ACTS spacecraft provided its own means for attitude determination and control. The ACTS Horizon Sensor Assembly (HSA) was used to determine the relative angle between the Earth and the AKM spin axis. The HSA function is nearly identical to that of the ESA on-orbit, only the spacecraft is rotating very quickly. When HSA measurements are made several times throughout the transfer orbit, two-axis attitude determination is possible.

ACTS thrusters were used to increase the spin rate and to provide stability about the spin axis. The thrusters were also used to realign (precess) the spin axis. Spacecraft telemetry provided the ground analysts the necessary attitude data for making all spacecraft pre-operational decisions for orbit and attitude purposes. The spin axis was finally reoriented in the optimal attitude for the firing of the solid propellant AKM. When fired at the optimal time, near the apogee of the geosynchronous transfer orbit, the AKM both circularized the orbit, and reduced the orbital inclination to near zero. The spent AKM (housing) remains attached to the spacecraft for the remainder of the mission.

The post AKM orbit is referred to as the "drift" orbit, because the spacecraft drifts toward its final orbit and station position. The "drift" orbit is nearly circular, and close to that of a geosynchronous orbit. During the "drift" orbit the spacecraft performed the Sun-Earth Acquisition Sequence (SEAS), whereby it orients itself from a minor axis spinner to three-axis stabilized spacecraft. During the SEAS, the spacecraft performs the following attitude control sequence:

- search for and capture of the Sun in the yaw axis,
- deploy solar arrays,
- search for and capture of the Earth in the pitch axis,
- capture the Earth in the roll axis,
- energize the momentum wheel,
- activate pitch control,

During the SEAS, all ACTS appendages were deployed to their on-orbit configuration seen in figure 1. Having completed the SEAS, the spacecraft operates under three-axis control for the remainder of its mission. The spacecraft then began the ACTS operational phase.

APPENDIX B
ACTS ACRONYMS

ACTS	Advanced Communications Technology Satellite
AKM	Apogee Kick Motor
APEMAC	Automatic Pitch Error Momentum Adjustment Control
ASP	Attitude System Processor
ESA	Earth Sensor Assembly
GHz	Giga Hertz
KA	K Above (20 - 30 GHz radio frequency)
KSC	Kennedy Space Center
MCS	Master Control Station
MTA	Magnetic Torquer Assembly
MWA	Momentum Wheel Assembly
RAM	Random Access Memory
REA	Rocket Engine Assemblies
RF	Radio Frequency
RMA	Rate Measuring Assembly
ROM	Read Only Memory
RPM	Revolutions Per Minute
S/C	Spacecraft
S/K	Stationkeeping
SEAS	Sun Earth Acquisition Sequence
STS	Space Transportation System
TOS	Transfer Orbit Stage

REFERENCES

1. Advanced Communications Technology Satellite—Experiments Applications Guide. National Aeronautics and Space Administration TM-100265, July 1988.
2. Rajaram, S.: Updated ACTS Environmental Disturbance Analysis. Internal LMAS memo, NASA/ACTS-AC-221, August 13, 1990.
3. Wertz, J.: Spacecraft Attitude Determination and Control. Reidel Publishing Company, Boston, 1986
4. Performance Specification 1000 ATM² Magnetic Torquer Assembly. PS-2617604, RCA Corporation Astro-Electronics Division, Princeton, New Jersey, 1987.

TABLE I.—ACTS PITCH AND ROLL AXIS
BIASING CAPABILITIES

Type of offset	Range, deg	Resolution, deg
ESA pitch bias	6.000	0.010
Variable ESA pitch	0.500	0.010
Variable ESA roll	0.500	0.010
Autotrack pitch bias	0.250	0.005
Autotrack roll bias	2.500	0.005

TABLE II.—ACTS MAXIMUM ALLOWABLE
POINTING ERROR (DEGREES)

Axis	Nominal operations		Thrusters, ^a
	Autotrack	Earth sensor	Earth sensor
Pitch	0.025	0.100	0.150
Roll	.025	.100	.150
Yaw	.150	.250	.250

^aThe pointing budget includes thruster operation because some experimentation can be successfully performed even during housekeeping and stationkeeping maneuvers.

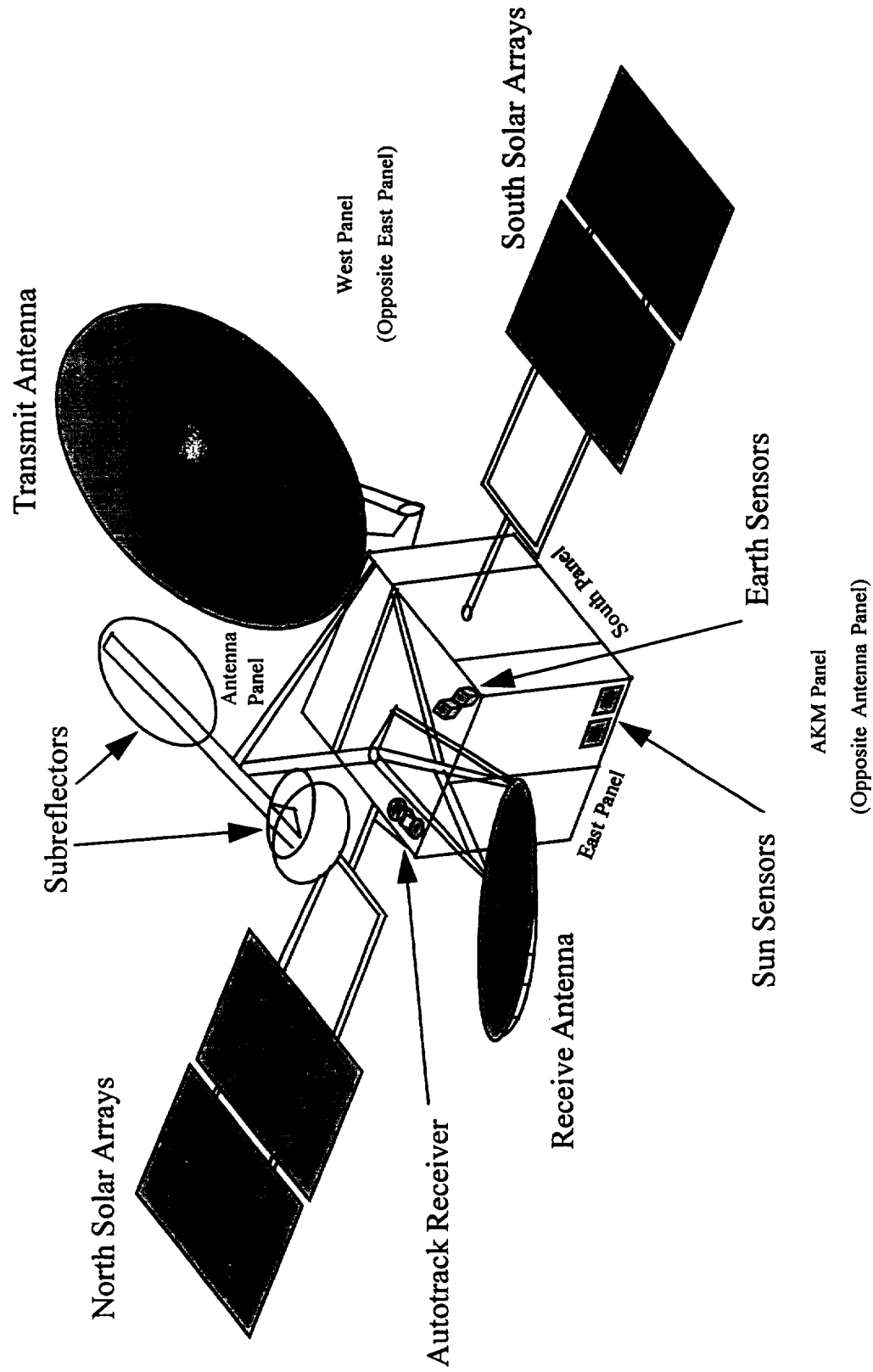

Figure 1. ACTS On-Orbit Deployed Configuration

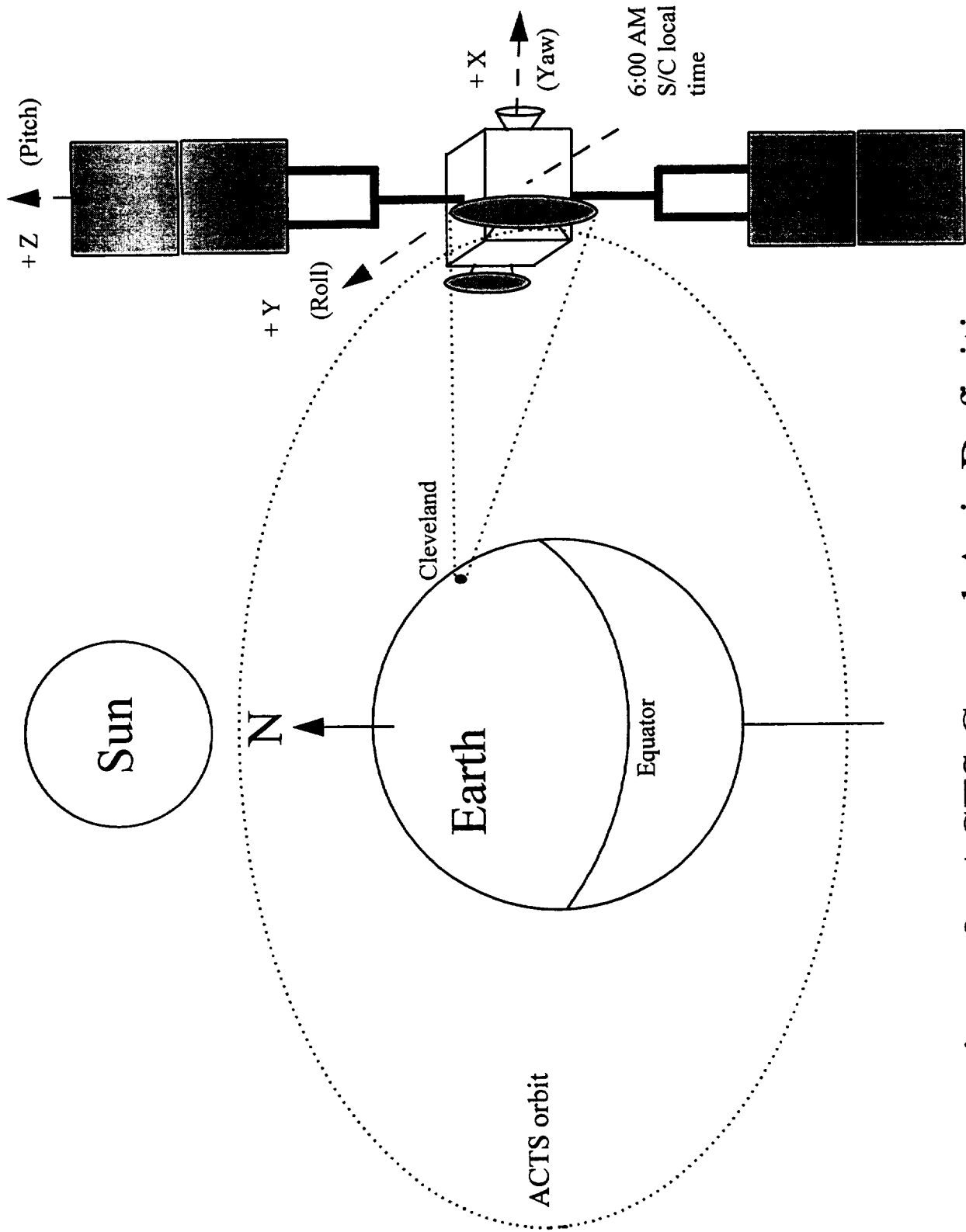

Figure 2. ACTS Control Axis Definitions

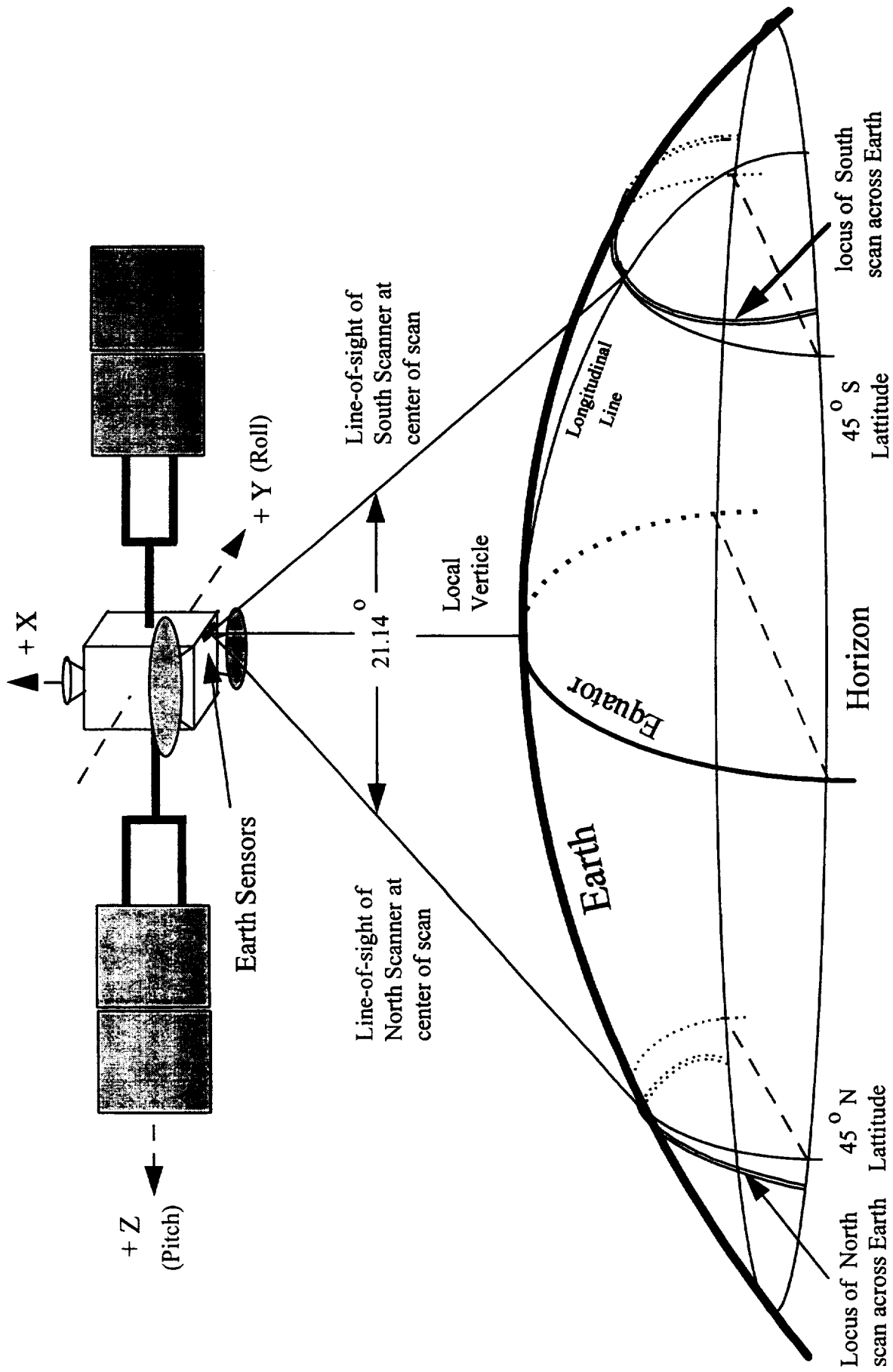
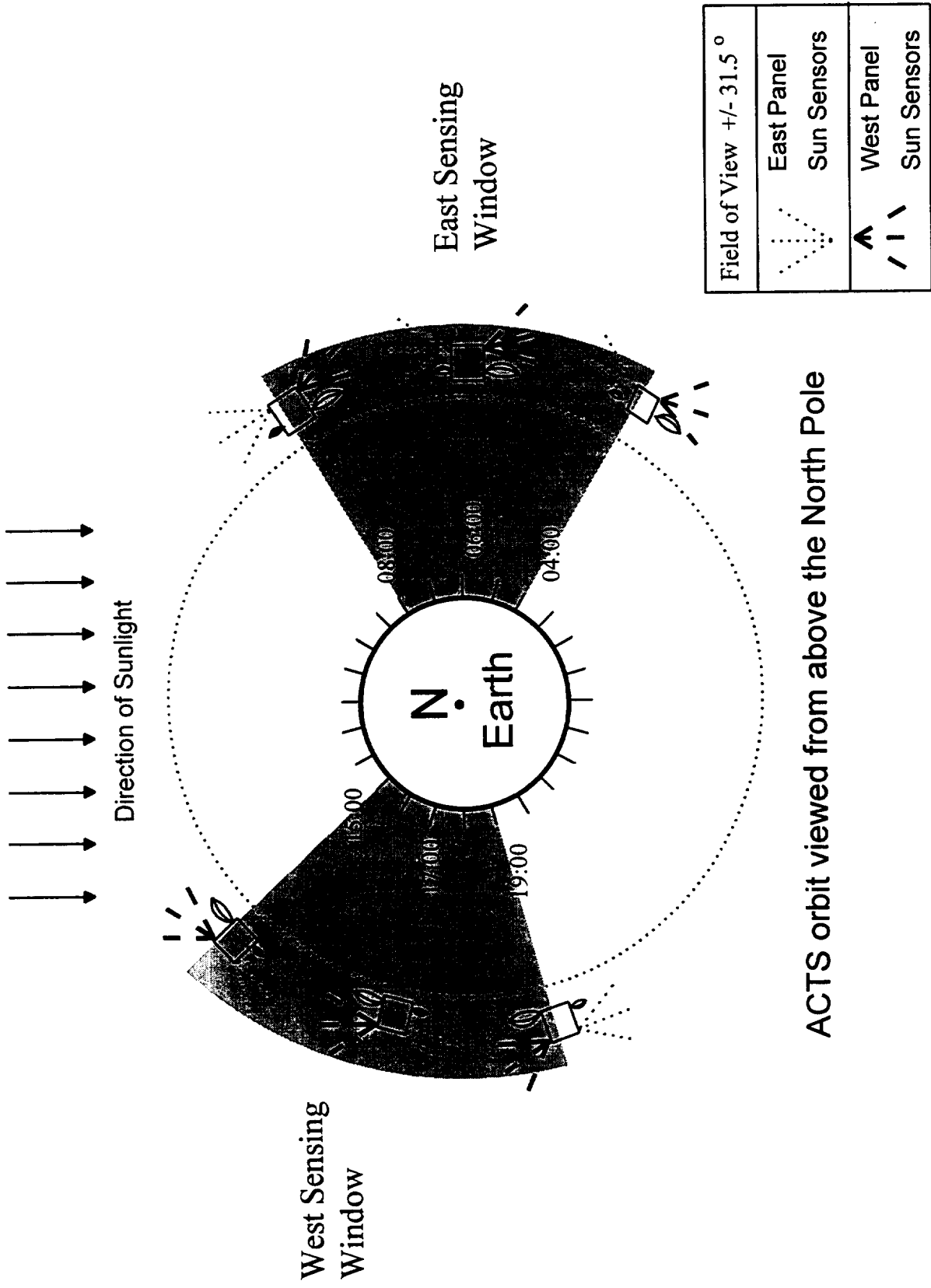

Figure 3. Earth Sensor Assembly Scan Geometry



ACTS orbit viewed from above the North Pole

Figure 4. ACTS Sun Sensing Windows and Geometry

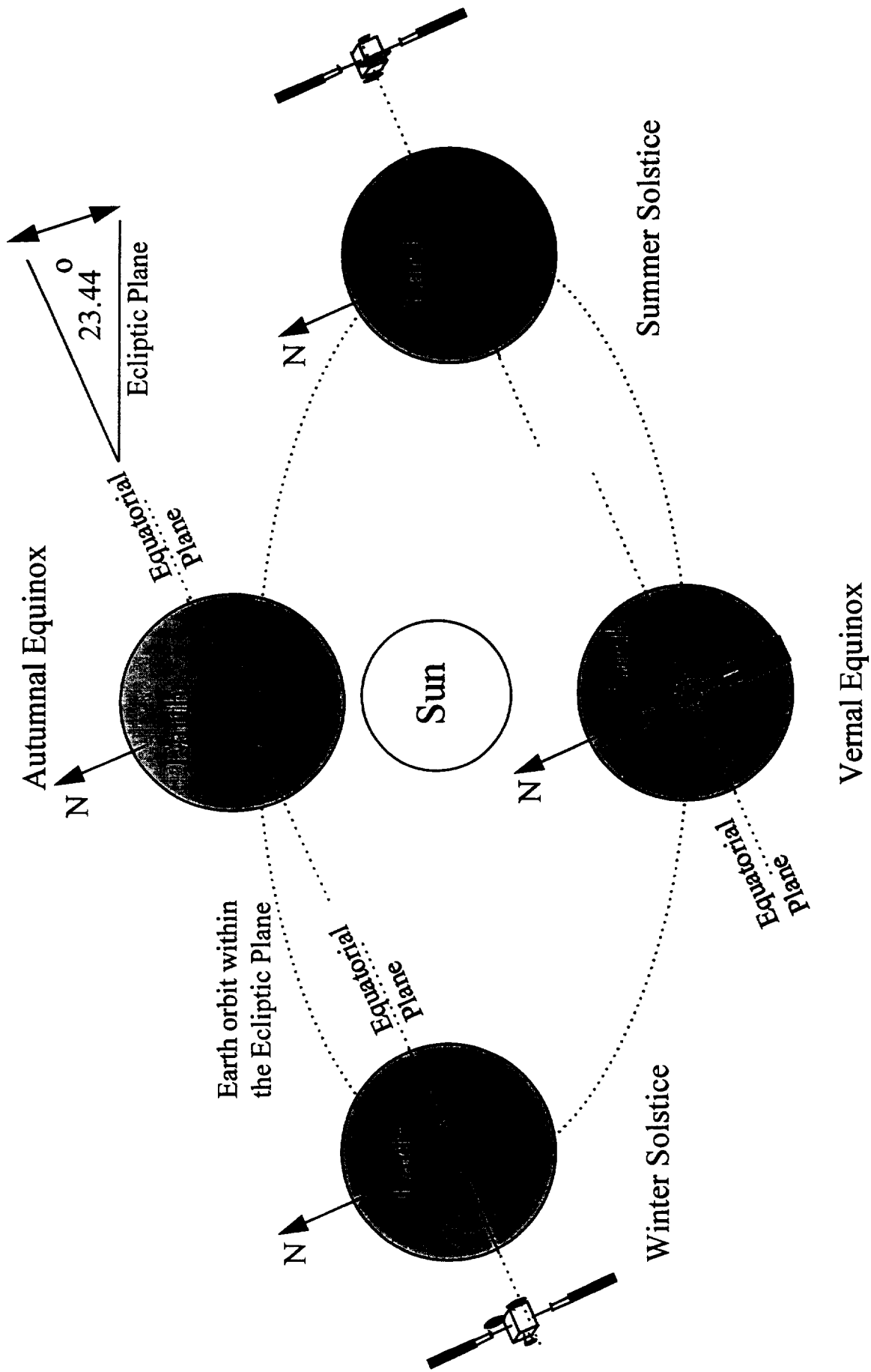

Figure 5. Ecliptic Plane and Seasons

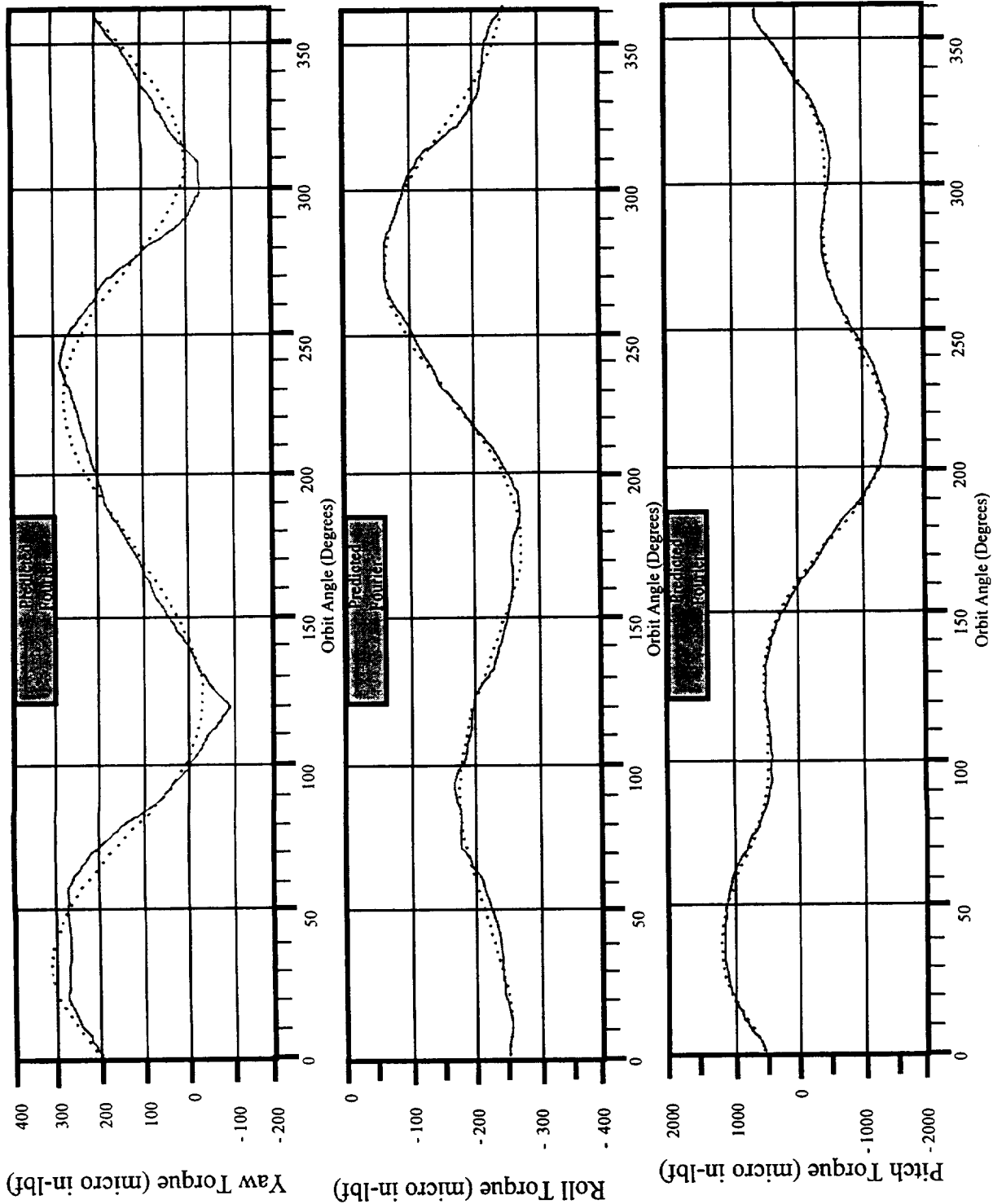

Figure 6. ACTS Environmental Disturbances - Summer Solstice

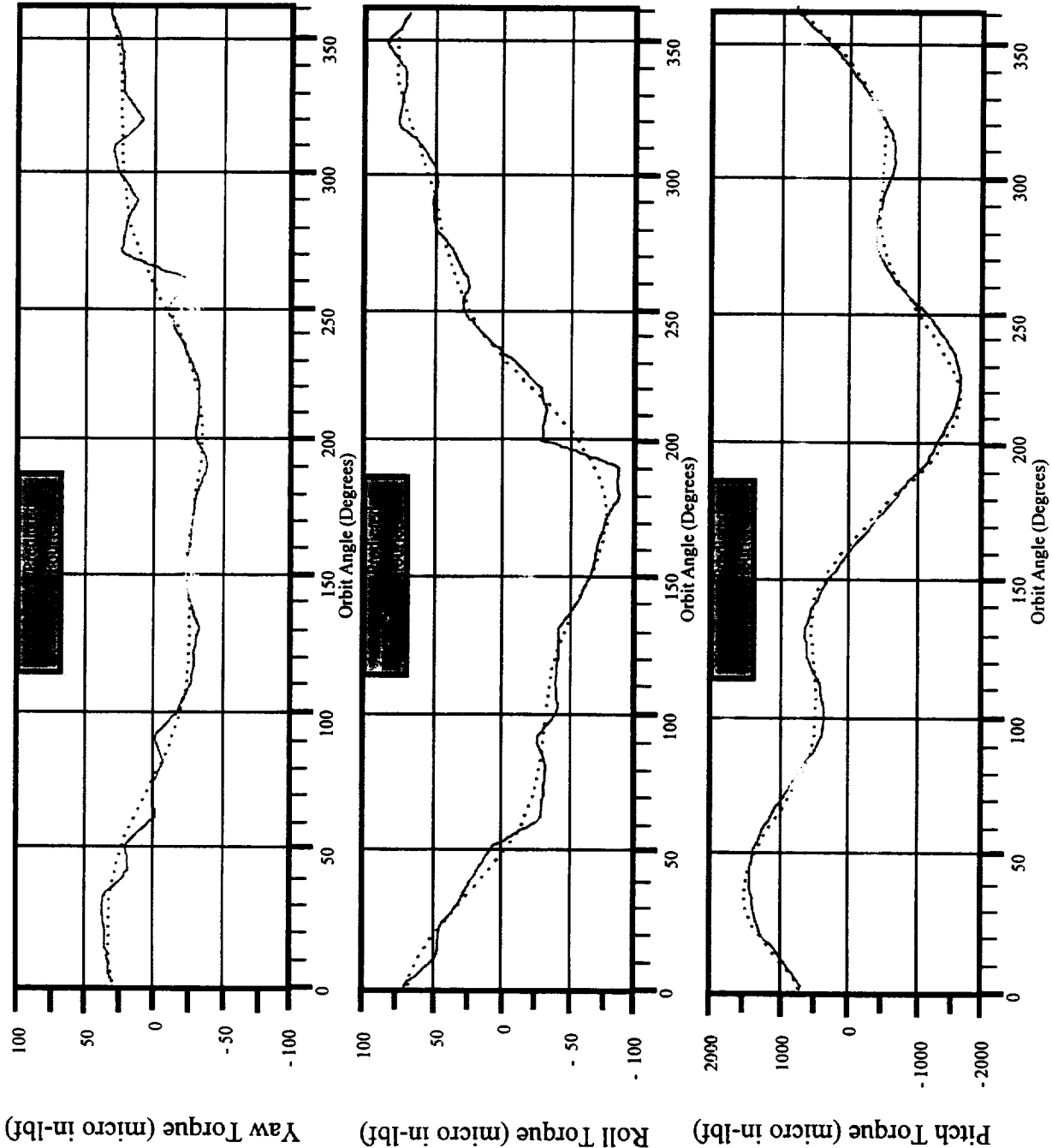

Figure 7. ACTS Environmental Disturbances - Equinox

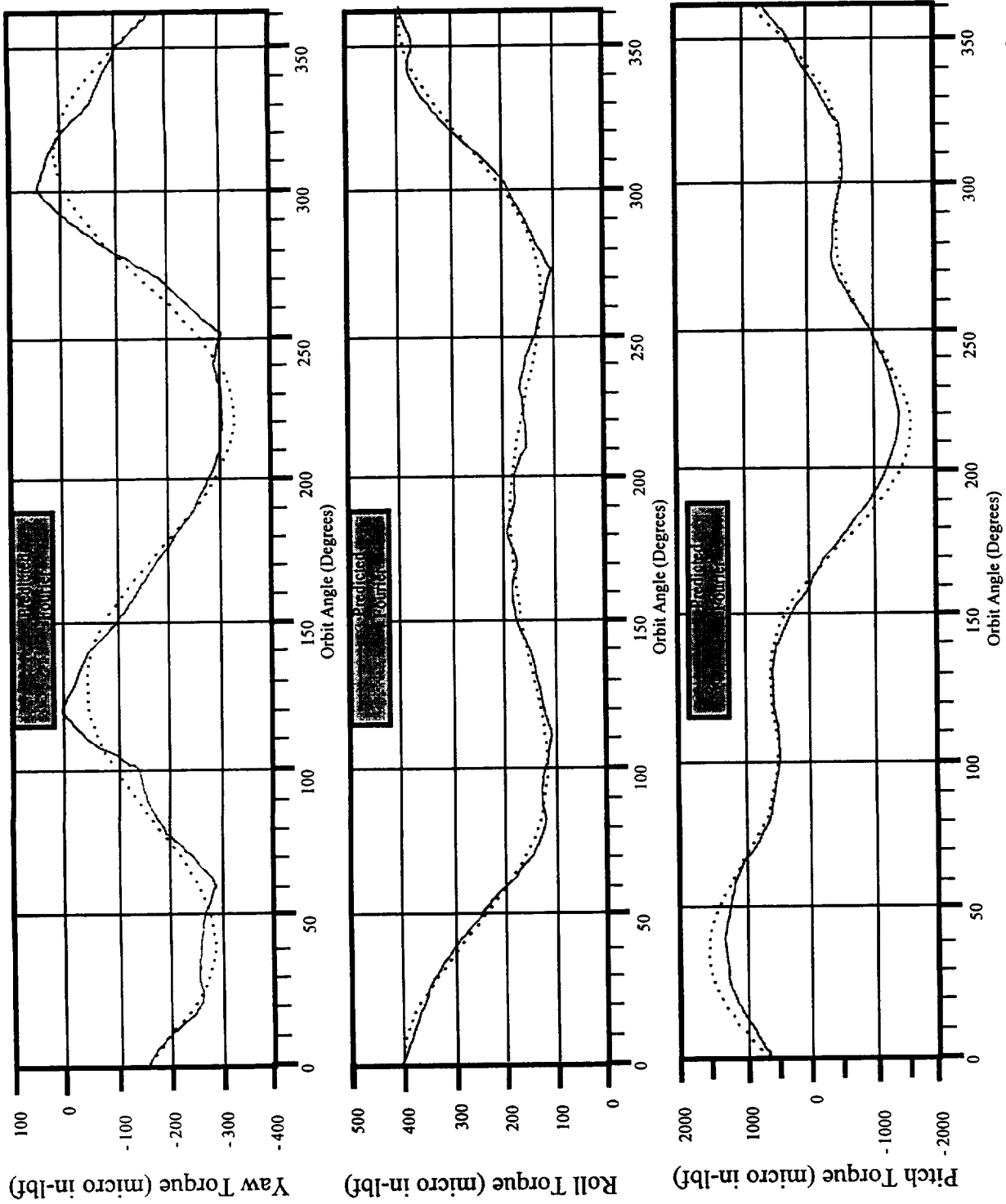

Figure 8. ACTS Environmental Disturbances - Winter Solstice

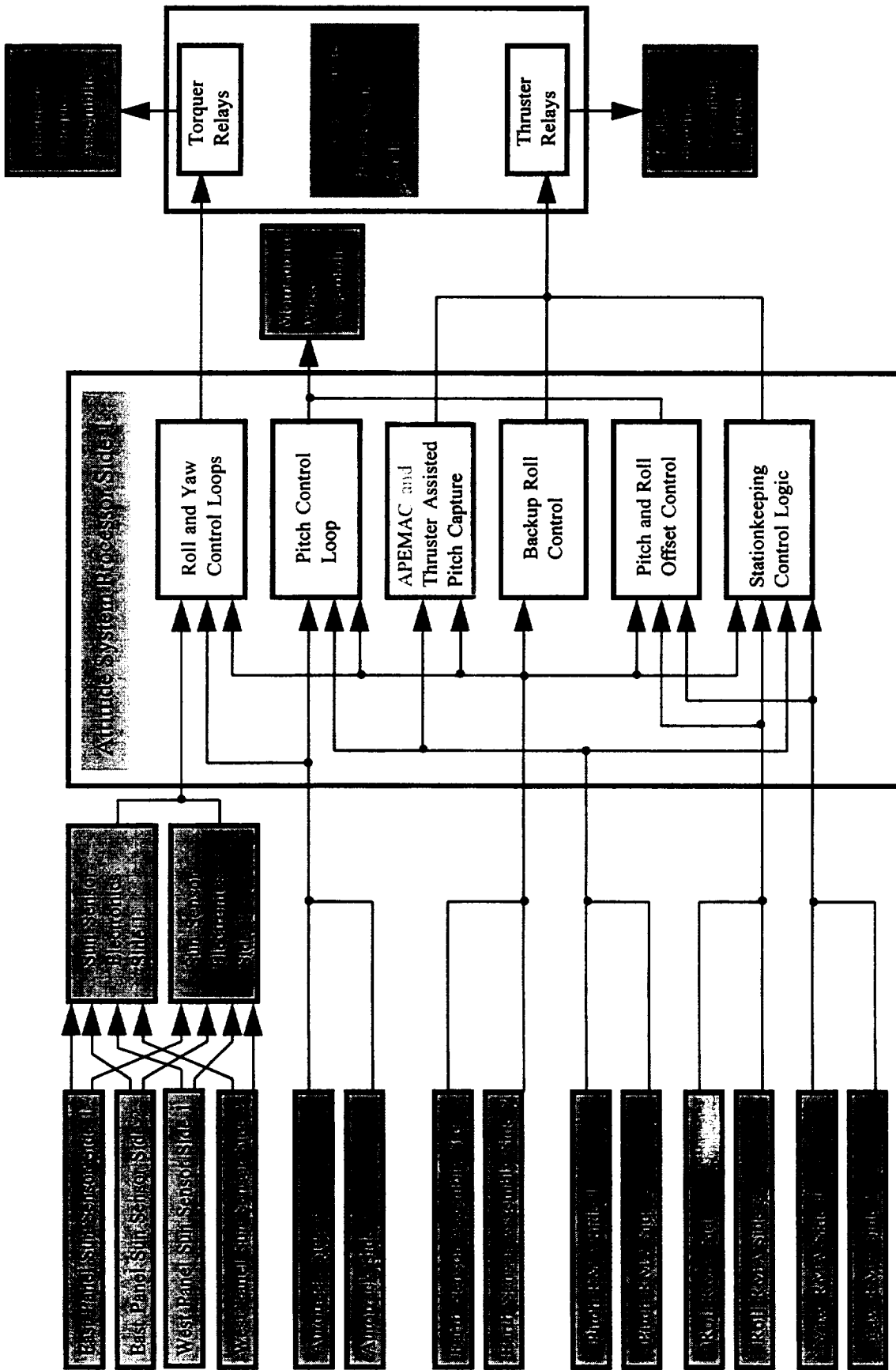

Figure 9. ACS Operational Mode Functional Block Diagram

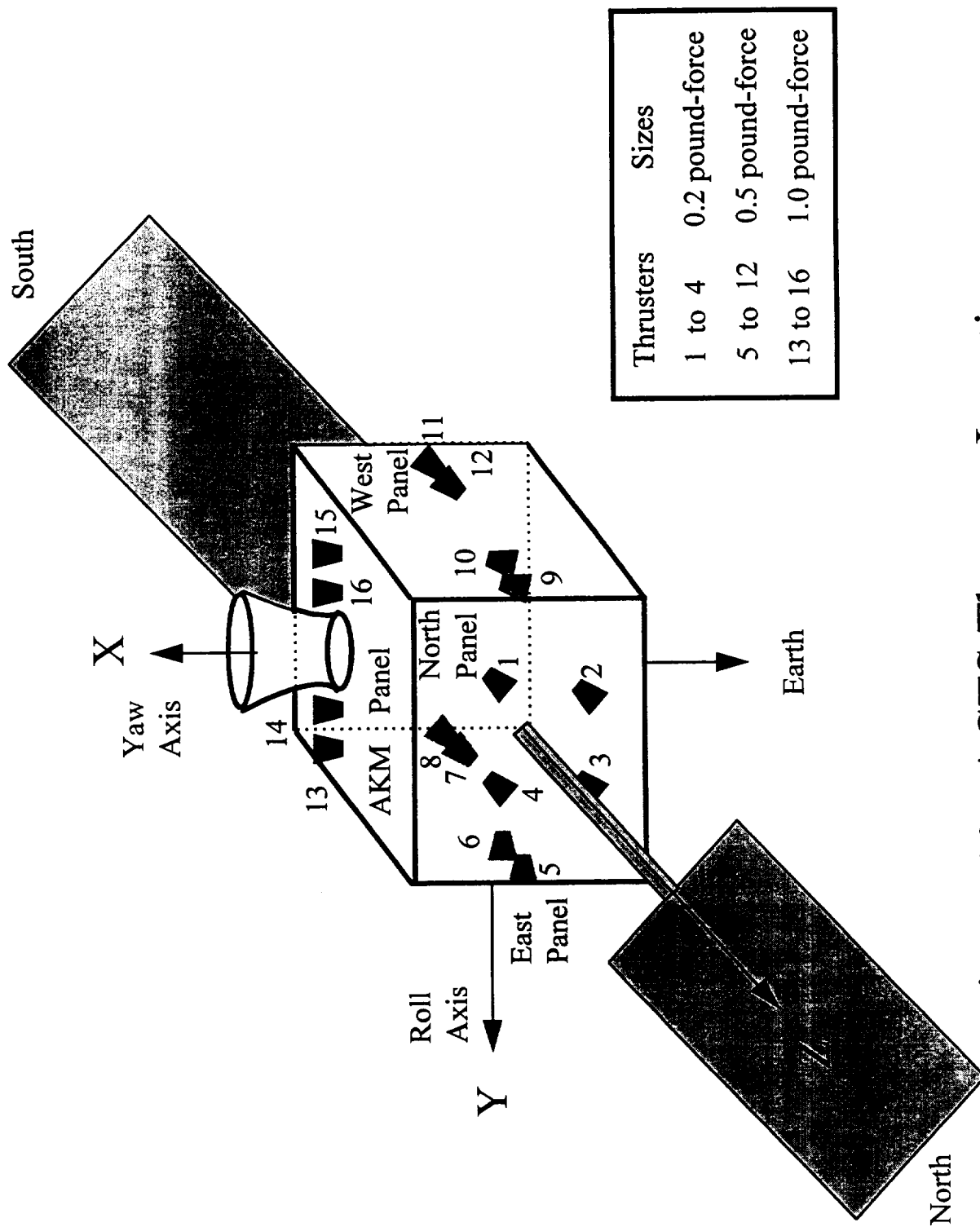

Figure 10. ACTS Thruster Locations

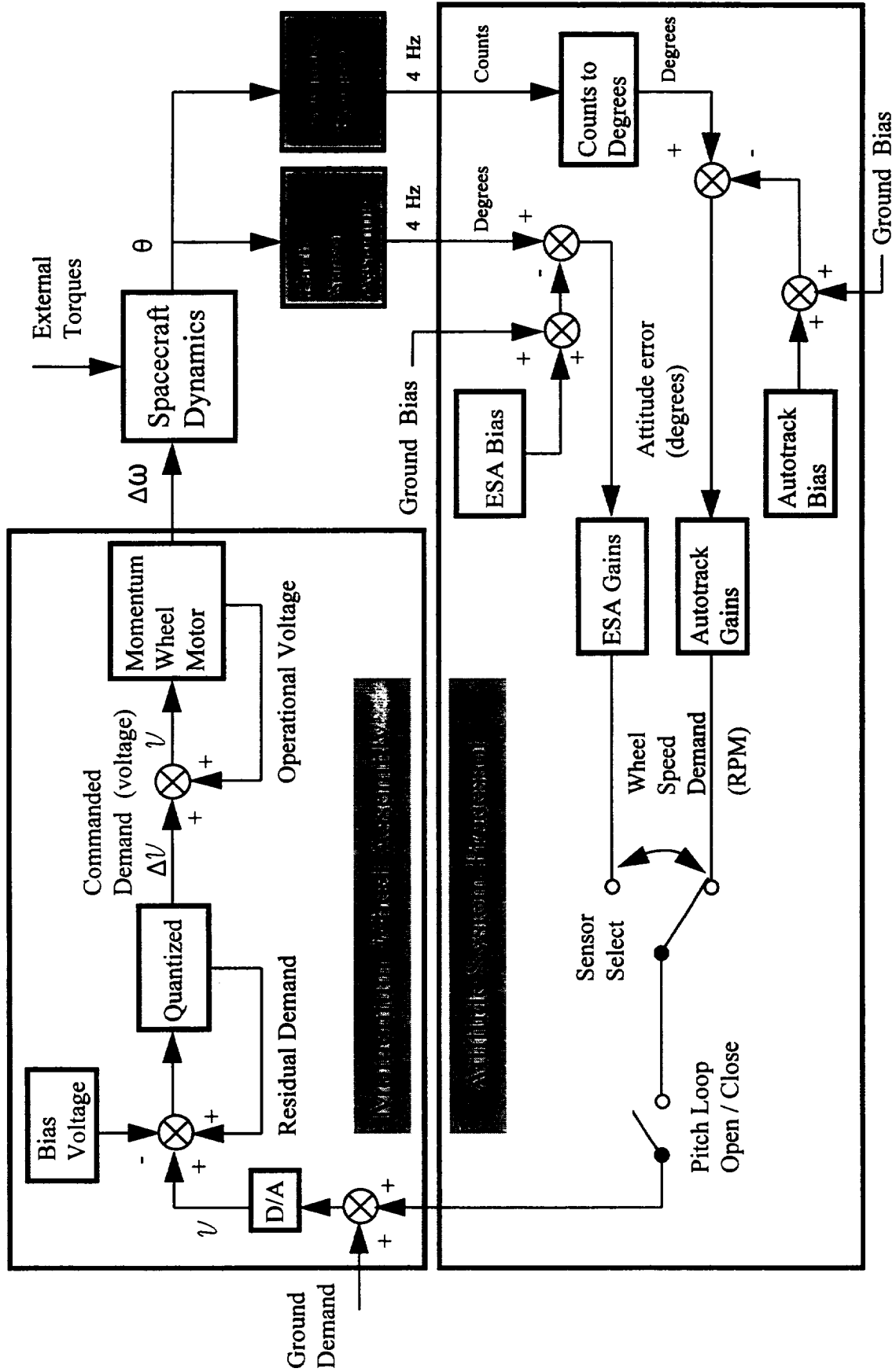

Figure 11. ACTS Pitch Control Loop - Simplified

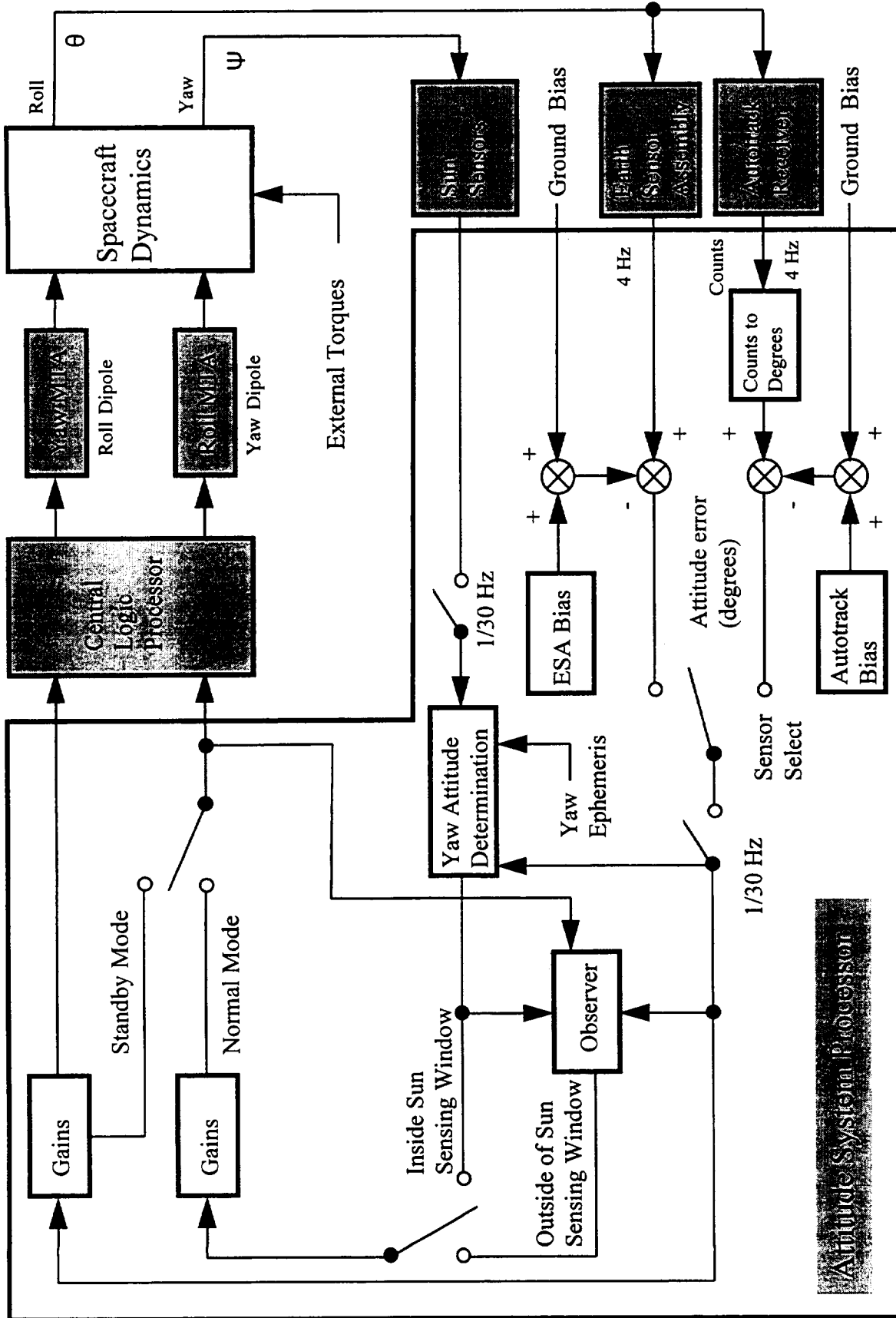

Figure 12. ACTS Roll & Yaw Control Loops - Simplified

REPORT DOCUMENTATION PAGE

Form Approved
OMB No. 0704-0188

Public reporting burden for this collection of information is estimated to average 1 hour per response, including the time for reviewing instructions, searching existing data sources, gathering and maintaining the data needed, and completing and reviewing the collection of information. Send comments regarding this burden estimate or any other aspect of this collection of information, including suggestions for reducing this burden, to Washington Headquarters Services, Directorate for Information Operations and Reports, 1215 Jefferson Davis Highway, Suite 1204, Arlington, VA 22202-4302, and to the Office of Management and Budget, Paperwork Reduction Project (0704-0188), Washington, DC 20503.

1. AGENCY USE ONLY (Leave blank)	2. REPORT DATE November 1996	3. REPORT TYPE AND DATES COVERED Technical Memorandum	
4. TITLE AND SUBTITLE Attitude Control Subsystem for the Advanced Communications Technology Satellite		5. FUNDING NUMBERS WU-233-5B-5F	
6. AUTHOR(S) Alan W. Hewston, Kent A. Mitchell, and Jerzy T. Sawicki		8. PERFORMING ORGANIZATION REPORT NUMBER E-10505	
7. PERFORMING ORGANIZATION NAME(S) AND ADDRESS(ES) National Aeronautics and Space Administration Lewis Research Center Cleveland, Ohio 44135-3191		10. SPONSORING/MONITORING AGENCY REPORT NUMBER NASA TM-107352	
9. SPONSORING/MONITORING AGENCY NAME(S) AND ADDRESS(ES) National Aeronautics and Space Administration Washington, D.C. 20546-0001		11. SUPPLEMENTARY NOTES Alan W. Hewston, NASA Lewis Research Center; Kent A. Mitchell, Lockheed Martin Missiles and Space, East Windsor, New Jersey 08593; and Jerzy T. Sawicki, Cleveland State University, Mechanical Engineering Department, Cleveland, Ohio 44115. Responsible person, Alan W. Hewston, organization code 4110, (216) 433-3556.	
12a. DISTRIBUTION/AVAILABILITY STATEMENT Unclassified - Unlimited Subject Categories 13 and 17 This publication is available from the NASA Center for AeroSpace Information, (301) 621-0390.		12b. DISTRIBUTION CODE	
13. ABSTRACT (Maximum 200 words) This paper provides an overview of the on-orbit operation of the Attitude Control Subsystem (ACS) for the Advanced Communications Technology Satellite (ACTS). The three ACTS control axes are defined, including the means for sensing attitude and determining the pointing errors. The desired pointing requirements for various modes of control as well as the disturbance torques that oppose the control are identified. Finally, the hardware actuators and control loops utilized to reduce the attitude error are described.			
14. SUBJECT TERMS Attitude; ACTS; Control		15. NUMBER OF PAGES 29	
		16. PRICE CODE A03	
17. SECURITY CLASSIFICATION OF REPORT Unclassified	18. SECURITY CLASSIFICATION OF THIS PAGE Unclassified	19. SECURITY CLASSIFICATION OF ABSTRACT Unclassified	20. LIMITATION OF ABSTRACT