A Numerical Method for Incompressible Flow with Heat Transfer

Jong-Youb Sa, Yeungnam University, Gyongsan, Korea
Dochan Kwak, Ames Research Center, Moffett Field, California

April 1997



National Aeronautics and
Space Administration

Ames Research Center
Moffett Field, California 94035-1000

A Numerical Method for Incompressible Flow with Heat Transfer

JONG-YOUB SA* AND DOCHAN KWAK

Ames Research Center

Summary

A numerical method for the convective heat transfer problem is developed for low speed flow at mild temperatures. A simplified energy equation is added to the incompressible Navier-Stokes formulation by using Boussinesq approximation to account for the buoyancy force. A pseudocompressibility method is used to solve the resulting set of equations for steady-state solutions in conjunction with an approximate factorization scheme. A Neumann-type pressure boundary condition is devised to account for the interaction between pressure and temperature terms, especially near a heated or cooled solid boundary. It is shown that the present method is capable of predicting the temperature field in an incompressible flow.

Introduction

Heat transfer in viscous incompressible flow is of interest in many industrial applications. For example, in a liquid rocket engine, the liquid fuel and oxidizer are used as coolant in various components such as the bearing in the oxidizer and fuel turbopump. Also, the flow in an autoclave for curing aerospace parts can be analyzed using an incompressible flow assumption. For a complete analysis of heat transfer in a wide range of temperature, one must include radiation effects as well as boiling heat transfer. However, of current interest are the problems dominated by convective heat transfer. Therefore, in the present study, the internal energy generated by viscous dissipation and the thermal radiation effects are neglected. The fluid is assumed to be incompressible with constant physical properties except for the buoyancy effect due to density variations. When the temperature of the flow field is not high, the thermally driven velocity is small relative to sonic speed. Thus a Boussinesq approximation can be applied to the incompressible Navier-Stokes equations to represent the temperature field. The purpose of the present study is to develop a computational capability for simulating viscous incompressible flows with temperature variations. Since the method is intended for application

to three-dimensional problems, a primitive variable formulation is chosen based on a structured-grid approach. To use one of the primitive variable solvers (refs. 1–5), a simplified energy equation is added to the incompressible Navier-Stokes equations. In the present study, the first incompressible Navier-Stokes solver developed at Ames Research Center, the INS3D code (ref. 1), is selected to test the feasibility of using the present formulation in predicting the temperature field in an incompressible medium.

To validate the flow solver, a simple channel flow is computed where an analytical solution exists. Then, two-dimensional flow problems are computed and compared with other numerical and experimental results. In all these problems, natural, mixed, and forced convection problems are examined. Finally, computed results in three dimensions are compared with experiments. The simulation capability related to thermal effects has been demonstrated.

Solution Methods

Boussinesq Approximation

Neglecting the adiabatic temperature increase due to friction, the equations governing the flow of an incompressible fluid with constant properties can be written as

$$\frac{\partial u_i}{\partial x_i} = 0 \quad (1)$$

$$\frac{\partial u_i}{\partial t} + \frac{\partial u_i u_j}{\partial x_j} = \frac{\partial p}{\partial x_i} + \frac{\partial \tau_{ij}}{\partial x_j} + \bar{g} \frac{\rho - \rho_0}{\rho_0} \quad (2)$$

$$\frac{\partial T}{\partial t} + \frac{\partial u_j T}{\partial x_j} = \alpha \frac{\partial^2 T}{\partial x_j \partial x_j} \quad (3)$$

where x_i is the Cartesian coordinates, u_i the corresponding velocity components, p the pressure, t the time, τ_{ij} the viscous-stress tensor, \bar{g} the vector of gravitational acceleration, ρ the density, T the temperature, and α the thermal diffusivity. The viscous stress tensor can be written as

*NRC Research Associate. Present address: Department of Mechanical Engineering, Yeungnam University, Gyongsan 632, Korea.

$$\tau_{ij} = 2\nu S_{ij} - R_{ij} \quad (4)$$

$$S_{ij} = \frac{1}{2} \left(\frac{\partial u_i}{\partial x_j} + \frac{\partial u_j}{\partial x_i} \right) \quad (5)$$

where ν is the kinematic viscosity, S_{ij} the strain-rate tensor, and R_{ij} the Reynolds stresses. Various levels of closure models for R_{ij} are possible. In the present study, turbulence is simulated by an eddy viscosity model using a constitutive equation of the following form:

$$R_{ij} = \frac{1}{3} R_{kk} \delta_{ij} - 2\nu_t S_{ij} \quad (6)$$

where ν_t is the turbulent eddy viscosity. By including the normal stress, R_{kk} , in the pressure, ν in equation (4) can be replaced by $(\nu + \nu_t)$ as follows:

$$\tau_{ij} = 2(\nu + \nu_t) S_{ij} = 2\nu_t S_{ij} \quad (7)$$

In the remainder of this report, the total viscosity, ν_T , will be represented simply by ν . The present formulations allow for a spatially varying viscosity.

The buoyancy force term is simplified through the Boussinesq approximation where the density in the buoyancy term is represented by a linear variation of the temperature,

$$\rho = \rho_0 \{1 - \tilde{\beta}(T - T_0)\} \quad (8)$$

where $\tilde{\beta}$ is the coefficient of thermal expansion. The buoyancy term based on this approximation is included in the momentum equation (2) resulting in

$$\frac{\partial u_i}{\partial t} + \frac{\partial u_i u_j}{\partial x_j} = -\frac{\partial p}{\partial x_i} + \frac{\partial \tau_{ij}}{\partial x_j} - \tilde{g} \tilde{\beta} (T - T_0) \quad (2')$$

The above governing equations can be nondimensionalized by introducing the following dimensionless quantities:

$$x' = \frac{x}{L}, \quad T' = \frac{T - T_0}{T_1 - T_0}$$

for natural convection,

$$t' = \frac{t}{L^2/\alpha}, \quad u' = \frac{u}{L^2/\alpha}, \quad p' = \frac{p}{\rho_0(\alpha/L)^2}$$

for forced/mixed convection,

$$t' = \frac{t}{L/u_0}, \quad u' = \frac{u}{L/u_0}, \quad p' = \frac{p}{\rho_0 u_0^2}$$

Here, u_0 is the reference velocity, L the reference length, and $T_1 - T_0$ the reference temperature difference. By omitting the prime in the nondimensional variables, the governing equations with Boussinesq approximation can be written as the following dimensionless form:

$$\frac{\partial u_i}{\partial x_i} = 0 \quad (9)$$

$$\frac{\partial u_i}{\partial t} + \frac{\partial u_i u_j}{\partial x_j} = -\frac{\partial p}{\partial x_i} + C_M \frac{\partial \tau_{ij}}{\partial x_j} - \tilde{e}_g C_B T \quad (10)$$

$$\frac{\partial T}{\partial t} + \frac{\partial u_j T}{\partial x_j} = C_E \frac{\partial^2 T}{\partial x_j \partial x_j} \quad (11)$$

Where, \tilde{e}_g is the unit vector for gravitational acceleration. Depending on the flow regime, the reference quantities vary and the coefficients are defined accordingly:

for natural convection,

$$C_M = \frac{1}{Re}, \quad C_B = \frac{Gr}{Re^2}, \quad C_E = \frac{1}{Re Pr} \quad (12a)$$

for forced/mixed convection,

$$C_M = Pr, \quad C_B = Ra Pr, \quad C_E = 1 \quad (12b)$$

Here, the nondimensional numbers are defined as

$$\text{Reynolds number: } Re = \frac{u_0 L}{\nu}$$

$$\text{Prandtl number: } Pr = \frac{\nu}{\alpha}$$

$$\text{Grashof number: } Gr = \frac{g \tilde{\beta} L^3 (T_1 - T_0)}{\nu^2} \quad (13)$$

$$\text{Rayleigh number: } Ra = \frac{g \tilde{\beta} L^3 (T_1 - T_0)}{\nu \alpha}$$

$$\text{Richardson number: } Ri = \frac{Gr}{Re^2}$$

Pseudocompressibility Formulation in Generalized Coordinates

The pseudocompressibility is introduced after the governing equations (9)–(11) are transformed into general curvilinear coordinates, (ξ, η, ζ) , which results in

$$\frac{\partial}{\partial t} \hat{D} = -\frac{\partial}{\partial \xi_i} (\hat{E}_i - \hat{E}_{vi}) + \hat{S} \quad (14)$$

where

$$\hat{D} = \frac{D}{J} = \frac{1}{J} \begin{bmatrix} p \\ u \\ v \\ w \\ T \end{bmatrix}, \quad \hat{S} = -\frac{C_B T}{J} \begin{bmatrix} 0 \\ \lambda_1 \\ \lambda_2 \\ \lambda_3 \\ 0 \end{bmatrix},$$

$$\hat{E}_i = \frac{1}{J} \begin{bmatrix} \beta(U_i) \\ (\xi_i)_x p + u(U_i + (\xi_i)_t) \\ (\xi_i)_y p + v(U_i + (\xi_i)_t) \\ (\xi_i)_z p + w(U_i + (\xi_i)_t) \\ TU \end{bmatrix},$$

$$\hat{E}_{v_i} = \frac{1}{J} \begin{bmatrix} 0 \\ C_M \nabla \xi_i \cdot \left(\nabla \xi_l \frac{\partial u}{\partial \xi_l} \right) \\ C_M \nabla \xi_i \cdot \left(\nabla \xi_l \frac{\partial v}{\partial \xi_l} \right) \\ C_M \nabla \xi_i \cdot \left(\nabla \xi_l \frac{\partial w}{\partial \xi_l} \right) \\ C_M \nabla \xi_i \cdot \left(\nabla \xi_l \frac{\partial T}{\partial \xi_l} \right) \end{bmatrix}$$

$$U_i = (\xi_i)_x u + (\xi_i)_y v + (\xi_i)_z w$$

$$\xi_i = \xi, \eta, \text{ or } \zeta \quad \text{for } i = 1, 2, \text{ or } 3$$

J = Jacobian of the transformation

β = pseudocompressibility parameter

Here, λ_1 , λ_2 , and λ_3 are components of the unit tensor \bar{e}_g in the x, y, and z directions, respectively.

Numerical Method

An unfactored implicit scheme can be obtained by linearizing the flux vectors with respect to the previous time step and dropping terms of the second and higher order, which results in the following equations in delta form:

$$\begin{aligned} & \left[I + \alpha \Delta \tau J \left(\delta \xi_i \left(\hat{A}_i^n - \Gamma_i \right) - \hat{H} \right) \right] \left(D^{n+1} - D^n \right) \\ & = -\Delta \tau J \left[\delta \xi_i \left(\hat{E}_i - \hat{E}_{v_i} \right)^n - \hat{S} \right] \end{aligned} \quad (15)$$

where

\hat{A}_i = Jacobian matrices of \hat{E}_i

$$= \frac{1}{J} \begin{bmatrix} 0 & (\xi_i)_x \beta & (\xi_i)_y \beta & (\xi_i)_z \beta & 0 \\ (\xi_i)_x & (\xi_i)_x u + U_i & (\xi_i)_y u & (\xi_i)_z u & 0 \\ (\xi_i)_y & (\xi_i)_x v & (\xi_i)_y v + U_i & (\xi_i)_z v & 0 \\ (\xi_i)_z & (\xi_i)_x w & (\xi_i)_y w & (\xi_i)_z w + U_i & 0 \\ 0 & (\xi_i)_x T & (\xi_i)_y T & (\xi_i)_z T & U_i \end{bmatrix}$$

\hat{H} = Jacobian matrix of the source term \hat{S}

$$\Gamma_1 D^{n+1} = \left(\frac{v}{J} \right) \nabla \xi \cdot \left(\nabla \xi_i \frac{\partial}{\partial \xi_i} \right) I_m \frac{\partial D}{\partial \xi}$$

(Γ_2 and Γ_3 are similarly defined)

$\delta \xi$ = finite difference form of $\frac{\partial}{\partial \xi}$

$\alpha = 1/2$ for trapezoidal, or 1 for Euler

$$I_m = \text{diag}[0, 1, 1, 1]$$

This equation is iterated in pseudotime until the solution converges to steady state, at which time the original incompressible Navier-Stokes equations are satisfied. A direct inversion of equation (15) would become a Newton iteration for a steady-state solution. In three dimensions, however, direct inversion of a large block banded matrix of the unfactored scheme would be impractical. Numerous iterative schemes can be implemented to solve these equations (see ref. 6 for a review). In the present study, an approximate factorization scheme by Beam and Warming (ref. 7) is used.

Buoyancy Effect on Pressure

The buoyancy effect in a thermally convective flow needs to be assessed relative to the pressure wave propagation and the boundary layer development. For the pseudocompressibility formulation, the pressure wave propagates at a finite speed, the magnitude of which depends on the pseudocompressibility parameter. When the thermal effect is the dominant driving force such as in natural convection, a pressure gradient is created by the temperature variations. Thus the pressure boundary condition should include temperature effect. A full account of buoyancy effect on pseudocompressibility will be given in a later report.

Computed Results

A Vertical Channel with Temperature Gradient

A two-dimensional vertical channel flow is considered as a first test case of the present formulation. As shown in figure 1(a), one wall of the channel is heated to T_w and the other is cooled down to $-T_w$. For an infinitely long channel, an analytic solution exists in the following form:

$$v = 6V_0 \frac{x}{h} \left(1 - \frac{x}{h}\right) + \frac{g\beta h^2}{3\nu} T_w \frac{x}{h} \left(\frac{1}{2} - \frac{x}{h}\right) \left(1 - \frac{x}{h}\right)$$

$$T = T_w \left(1 - 2\frac{x}{h}\right)$$

where v is the vertical velocity, h the channel width, and V_0 an average velocity.

The computation was performed using a long channel with $L = 100h$. At the inlet, a uniform temperature $T = 0$ and a constant velocity $v = V_0$ are specified, while at the outlet a Neumann condition is imposed. In a forced convection mode, the flow becomes a two-dimensional Poiseuille flow. In the case of natural convection, which has the zero streamwise pressure gradient, the flow is generated by the buoyancy force, whereas in mixed convection the flow develops not only by the buoyancy force but also by the streamwise pressure gradient. All three modes of heat transfer problems are computed by selecting nondimensional parameters to represent respective flow fields. In figures 1(b)–1(d), computed temperature, vorticity, and velocity profiles at $y/h = 50$ are compared with the analytic solutions. Computations essentially reproduced the analytic solutions.

Flow around a Heated Circular Cylinder

The external flow test case consisted of a circular cylinder under the influence of a uniform upwardly moving fluid. In two dimensions, the stream function–vorticity formulation has been used in numerous numerical studies (for example, see ref. 8). Since detailed measurements of the flow field involving heat transfer are rare, the results of the present incompressible Navier-Stokes computation are compared to those of stream function–vorticity approach by Sa (ref. 8). In the figure, INS and SV represent the results obtained using incompressible Navier-Stokes and stream function–vorticity formulations, respectively. Since the stream function–vorticity formulation satisfies the divergence free velocity condition, this comparison can also be used to show that the present pseudocompressible formulation results in incompressible solutions.

In figures 2 and 3, computed results for forced, mixed, and natural convection cases are presented. The incompressible Navier-Stokes results are shown on the left half of each figure and results of the stream function–vorticity are shown on the right half (see fig. 2). The forced convection case was computed at Reynolds numbers ranging from 5 to 40. However, in the present paper, only the results for $Re = 20$ are reported. The mixed convection for the heated or cooled cylinder was computed at the Richardson number, which is defined in equation (13), from -1 to 4 with $Re = 20$. When the Richardson number is negative, the cylinder is cooled, and the fluid in the boundary layer and in the wake region is decelerated by the cooling. As the Richardson number increases, the flow is accelerated and the separation of the boundary layer is suppressed. The streamlines in figure 2(b) indicate that there is no separation at $Ri = 4$. The natural convection case was computed at the Rayleigh number up to 10^5 . The dimensionless heat transfer coefficient, the Nusselt number, is compared with experiments and other computations as shown in figure 3 for the forced, mixed, and natural convection cases. As the Reynolds number increases or the cylinder is heated, the stronger velocity near a surface makes the Nusselt number increase. Overall, the present results agree well with numerical and experimental data reported in references 9–14.

Thermally Driven Bifurcation in a Rectangular Cavity

Thermal instability is investigated next for a rectangular cavity with an aspect ratio of 1 or 2, which has a hot bottom wall and a cold top wall. For an aspect ratio of 1.0 at $Ra = 10^5$, there exists a unique solution with a single vortex as shown in figure 4(a). The INS (left) and the SV (right) show excellent agreement. On the other hand, the cavity with an aspect ratio of 2.0 at $Ra = 10^5$ may have two types of solutions: a double vortex as shown in figure 4(b) or a single vortex in the middle of the cavity as shown in figure 4(c). The bifurcation depends on the external disturbances and the initial and boundary conditions. In figure 4(b), the result of the INS (left) is a little different from that of the SV (right), since the grid is too coarse near the center line (the same grid number of 21×21 was used for both aspect ratios). However, in general it is shown that the present method is adequate to simulate the thermal instability.

Three-Dimensional Cavity

Most three-dimensional experiments are focused on the investigation of heat transfer coefficients at surfaces for practical applications. However, Morrison and Tran (ref. 14) experimentally investigated the flow structure in a natural convection mode generated by heated walls

in a vertical rectangular cavity shown in figure 5. The temperature difference between the heat transfer plates was fixed at 10°C and the plate separation distance at $L = 40$ mm ($Ra = 5 \times 10^5$). The cavity aspect ratio was 5 in both the horizontal and vertical planes (H/L and B/L). Morrison and Tran measured the velocity components by using Laser-Doppler anemometry. The nondimensional z-component velocity is compared between the present results and Morrison and Tran's experimental data in figures 6 and 7. Good agreement is observed, indicating that the Boussinesq approximation is adequate for this type of flow.

Concluding Remarks

In the present study, it is shown that the Boussinesq approximation is valid for the analysis of heat transfer in an incompressible medium with mild temperature variations where radiation or boiling heat transfer can be neglected. The resulting formulation is validated using a version of the INS3D code. Computed results show that forced, mixed, and natural convection problems can be accurately predicted using the Boussinesq approximation, even at $Ra = 5 \times 10^5$ in the case of Morrison's experiment (ref. 15). This indicates that the interaction between pseudocompressibility and buoyancy force is properly accounted for by the present method. Overall, the cost of computing attributed to the temperature equation has been increased less than 5 percent.

References

1. Kwak, D.; Chang, J. L. C.; Shanks, S. P.; and Chakravarthy, S.: A Three-Dimensional Incompressible Navier-Stokes Flow Solver Using Primitive Variables. *AIAA J.*, vol. 24, no. 3, Mar. 1986, pp. 390–396.
2. Rogers, S. E.; Kwak, D.; and Kiris, C.: Steady and Unsteady Solutions of the Incompressible Navier-Stokes Equations. *AIAA J.*, vol. 29, no. 4, Apr. 1991, pp. 603–610.
3. Yoon, S.; and Kwak, D.: Three-Dimensional Navier-Stokes Solver Using Lower-Upper Symmetric-Gauss-Seidel Algorithm. *AIAA J.*, vol. 29, no. 6, June 1991, pp. 874–875.
4. Rosenfeld, M.; Kwak, D.; and Vinokur, M.: A Fractional Step Solution Method for the Unsteady Incompressible Navier-Stokes Equations in Generalized Coordinate Systems. *J. Comp. Phys.*, vol. 94, no. 1, May 1991, pp. 102–137.
5. Kiris, C.; and Kwak, D.: Numerical Solution of Incompressible Navier-Stokes Equations Using a Fractional-Step Approach. *AIAA Paper 96-2089*, AIAA 27th Fluid Dynamics New Orleans, La., June 17–20, 1996.
6. Kwak, D.: *Computation of Viscous Incompressible Flows*. von Karman Institute for Fluid Dynamics, Lecture Series 1989-04. (Also NASA TM-101090, Mar. 1989.)
7. Beam, R. M.; and Warming, R. F.: An Implicit Factored Scheme for the Compressible Navier-Stokes Equations. *AIAA J.*, vol. 16, 1978, pp. 393–402.
8. Sa, J-Y: Numerical Study of Laminar Wake of a Circular Cylinder. Ph.D. Thesis, Department of Mechanical Engineering, Korea Advanced Institute of Science and Technology, Korea, Apr. 1988.
9. Badr, H. M.: Laminar Combined Convection from a Horizontal Cylinder—Parallel and Contra Flow Regimes. *Int. J. Heat Mass Transfer*, vol. 27, 1984, pp. 15–27.
10. Keuhn, T. H.; and Goldstein, R. J.: Numerical Solution to the Navier-Stokes Equations for Laminar Natural Convection about a Horizontal Isothermal Circular Cylinder. *Int. J. Heat Mass Transfer*, vol. 23, 1980, pp. 971–979.
11. Tsubouchi, T.; and Masuda, A. H.: Rep. no. 191, Inst. of High Speed Mechanics, Tohoku University, Japan, 1966.
12. Collis, D. C.; and Williams, M. J.: Two-Dimensional Convection from Heated Wires at Low Reynolds Numbers. *J. Fluid Mech.*, vol. 6, 1959, pp. 357–384.
13. Hatton, A. P.; James, D. D.; and Swire, H. W.: Combined Forced and Natural Convection with Low Speed Air Flow over Horizontal Cylinders. *J. Fluid Mech.*, vol. 42, 1970, pp. 17–31.
14. Mikheyev, M.: *Fundamentals of Heat Transfer*. Peace Publishers, Moscow, 1956.
15. Morrison, G. L.; and Tran, V. Q.: Laminar Flow Structure in Vertical Free Convective Cavities. *Int. J. Heat Mass Transfer*, vol. 21, 1978, pp. 203–213.

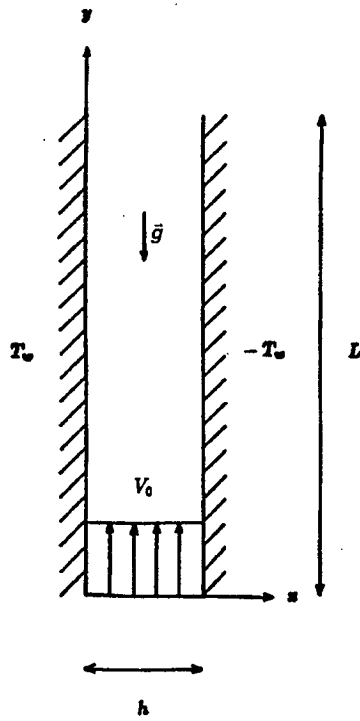

(a) Geometry

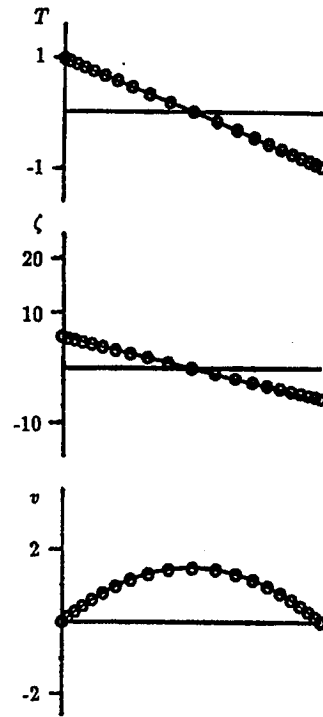

(b) Forced convection; $V_0 = 0, \frac{g\beta h^2 T_w}{\nu} = 0$

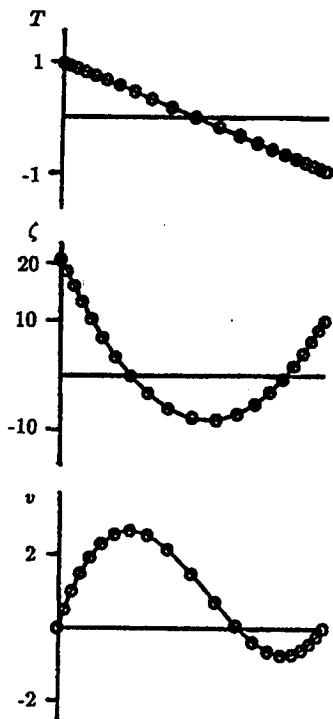

(c) Mixed convection; $V_0 = 1, \frac{g\beta h^2 T_w}{\nu} = 100$

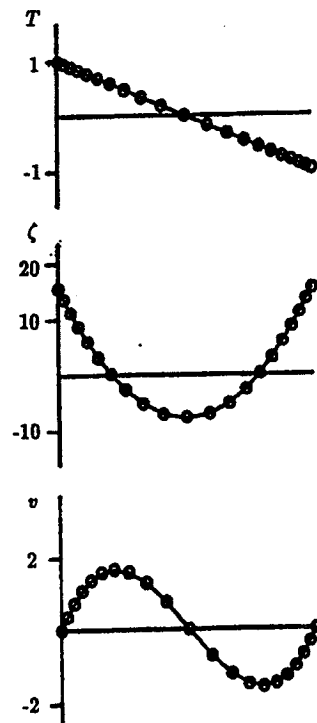

(d) Natural convection; $V_0 = 0, \frac{g\beta h^2 T_w}{\nu} = 100$

Figure 1. Vertical channel with temperature gradient: \circ , computed result; —, analytic solution.

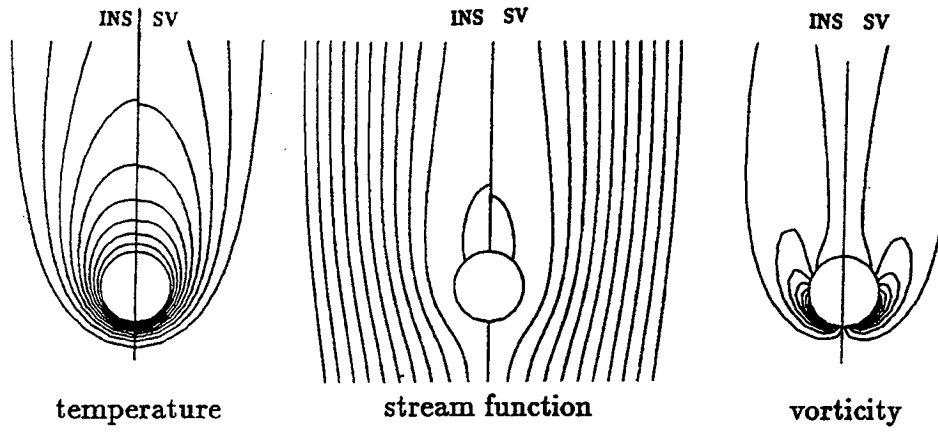

(a) Forced convection ($Re = 20$, $Gr = 0$)

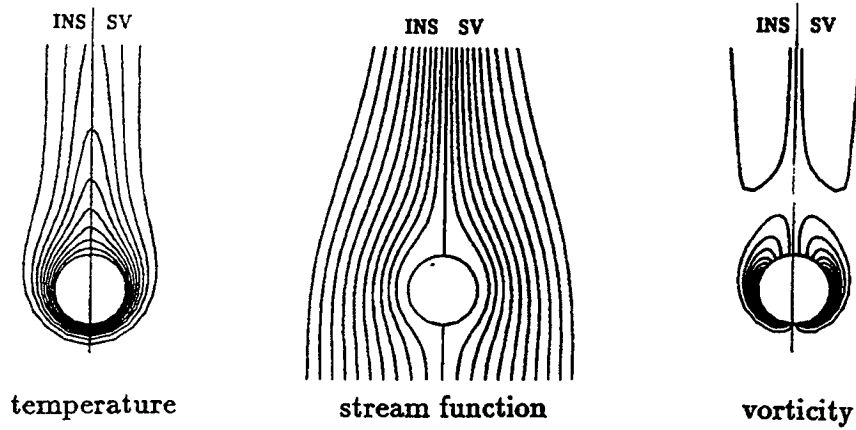

(b) Mixed convection ($Re = 20$, $Gr = 1600$)

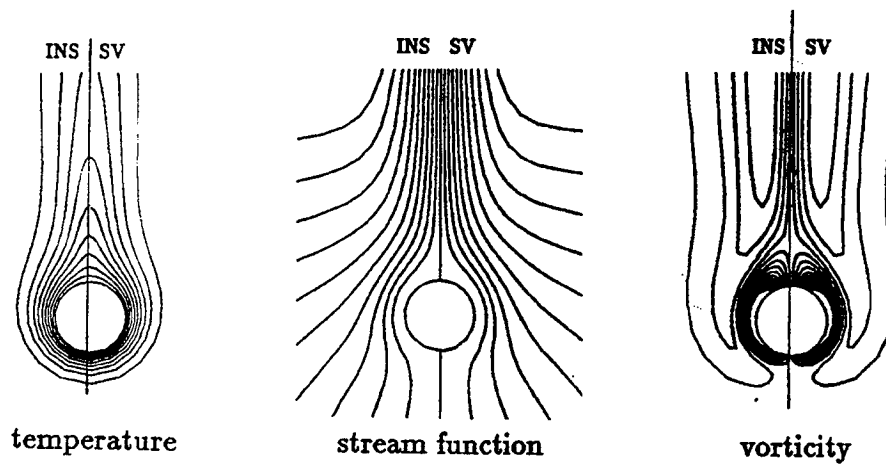

(c) Natural convection ($Ra = 10^3$)

Figure 2. Flow around a heated circular cylinder: Comparison of incompressible Navier-Stokes (INS) and stream function-vorticity (SV) computations.

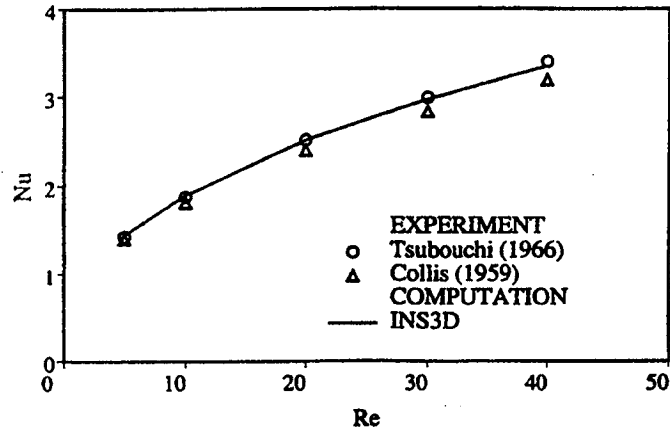

(a) Forced convection

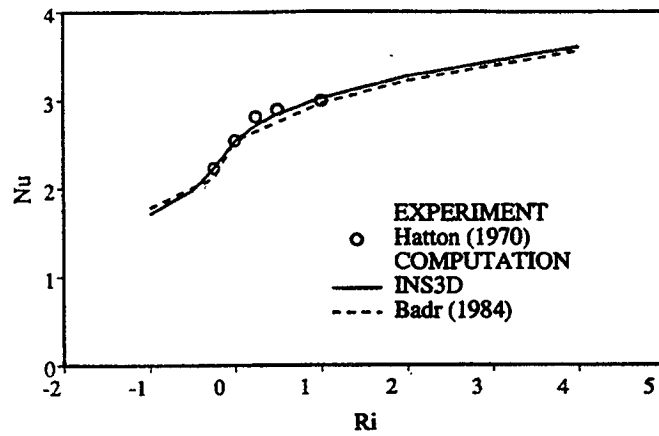

(b) Mixed convection

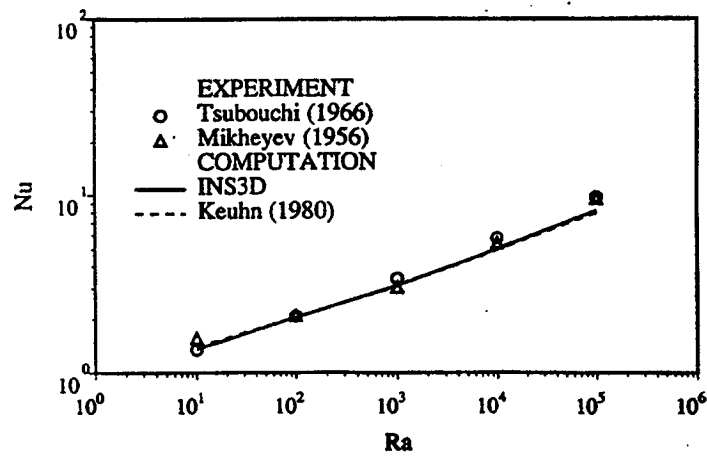

(c) Natural convection

Figure 3. Heat transfer coefficient for flow around a heated circular cylinder: Comparison of computed results and experimental data.

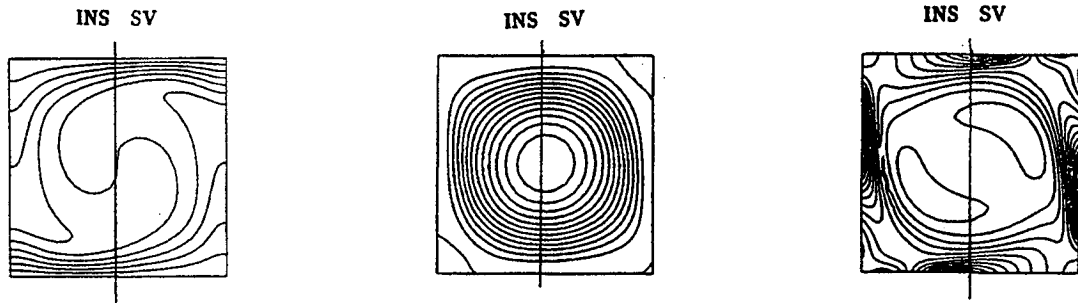

(a) Aspect ratio of 1.0 ($Ra = 10^5$)

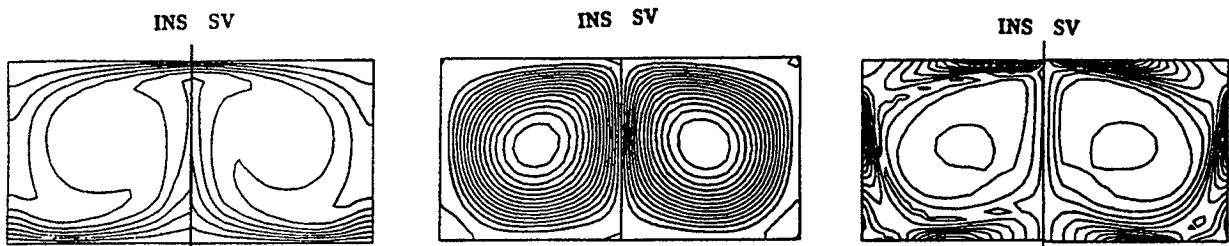

(b) Aspect ratio of 2.0 ($Ra = 10^5$: type A of bifurcation flow)

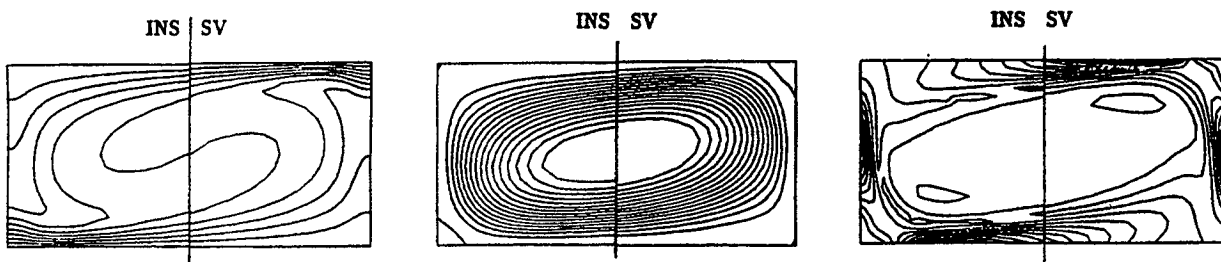

(c) Aspect ratio of 2.0 ($Ra = 10^5$: type B of bifurcation flow)

Figure 4. Thermally driven bifurcation in two-dimensional rectangular cavity: Contour plot of the temperature, the stream function, and the vorticity.

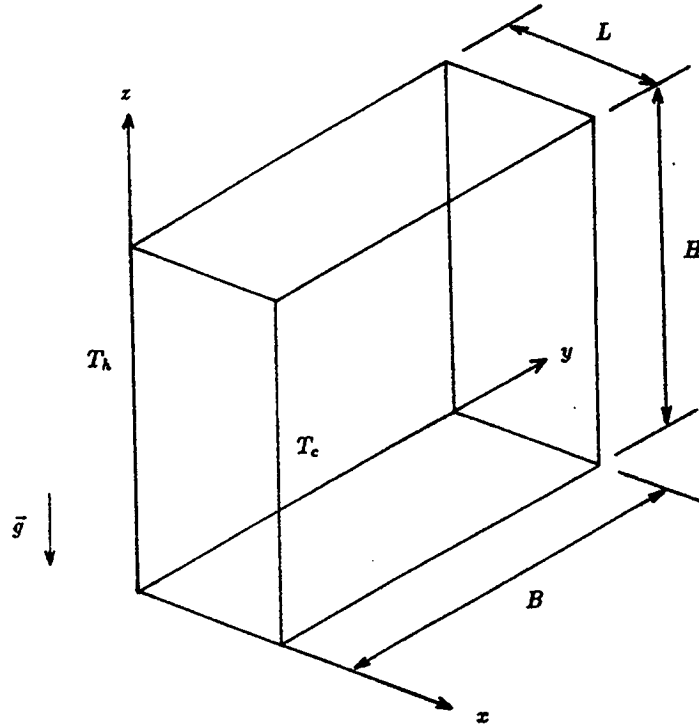

Figure 5. Geometry for a 3-D cavity flow: $T_h - T_c = 10^\circ\text{C}$, $Ra = 10^5$.

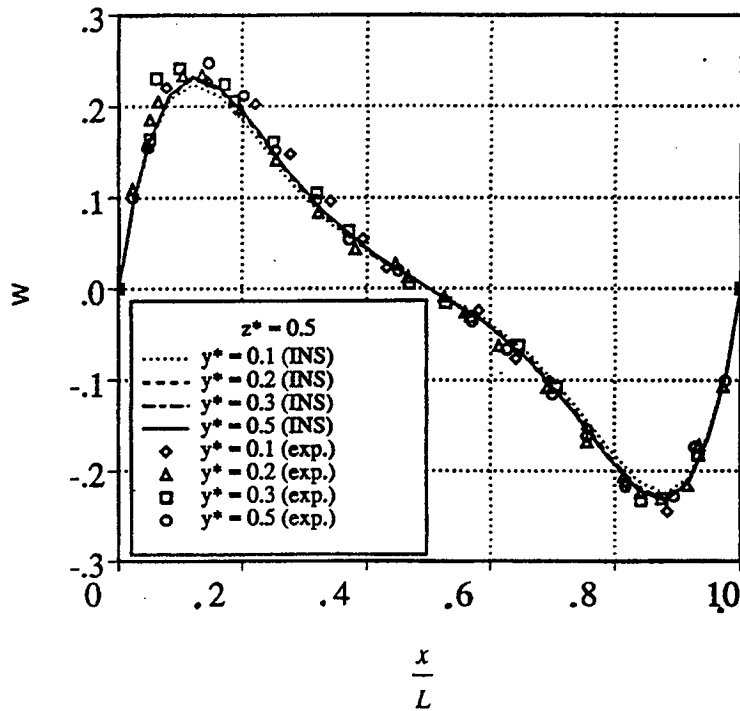

Figure 6. Vertical velocity component, w , at $z/H = 0.5$ for natural convection problem in a 3-D cavity: $T_h - T_c = 10^\circ\text{C}$, $Ra = 10^5$, $y^* = y/B$.

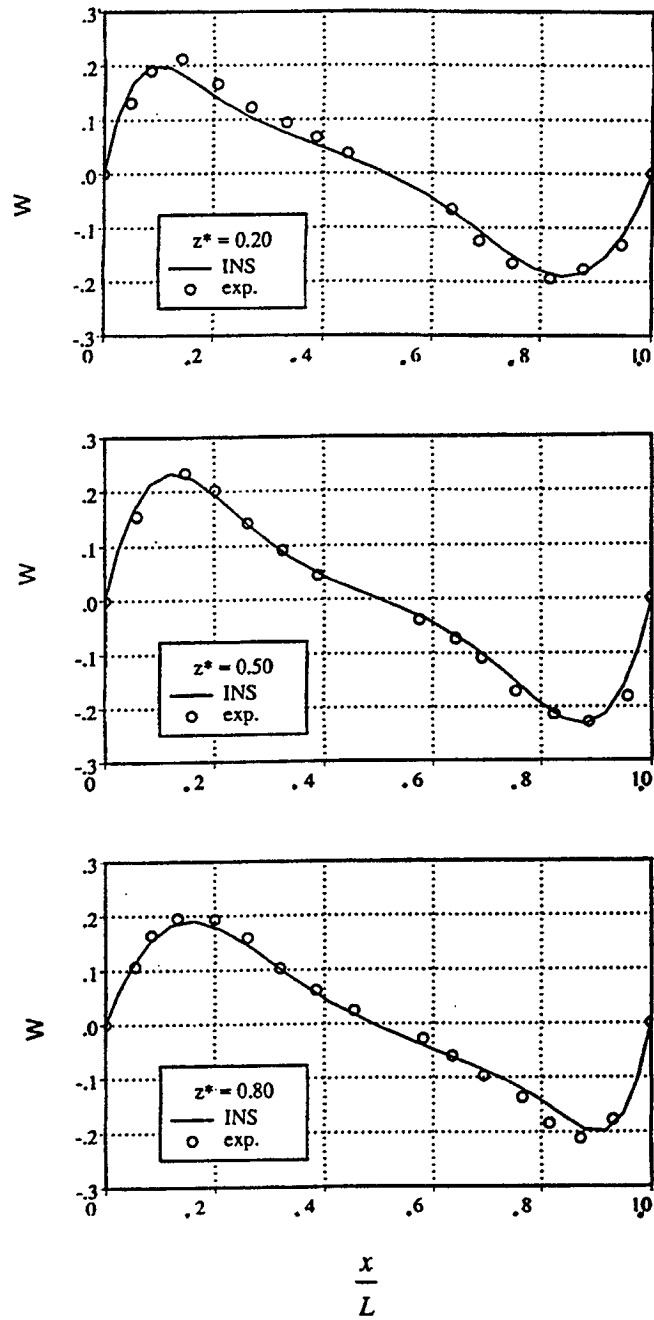

Figure 7. Vertical velocity component, w , at $y/H = 0.5$ for natural convection problem in a 3-D cavity: $T_h - T_c = 10^\circ\text{C}$, $Ra = 10^5$, $z^* = z/H$.

REPORT DOCUMENTATION PAGE

Form Approved
OMB No. 0704-0188

Public reporting burden for this collection of information is estimated to average 1 hour per response, including the time for reviewing instructions, searching existing data sources, gathering and maintaining the data needed, and completing and reviewing the collection of information. Send comments regarding this burden estimate or any other aspect of this collection of information, including suggestions for reducing this burden, to Washington Headquarters Services, Directorate for Information Operations and Reports, 1215 Jefferson Davis Highway, Suite 1204, Arlington, VA 22202-4302, and to the Office of Management and Budget, Paperwork Reduction Project (0704-0188), Washington, DC 20503.

1. AGENCY USE ONLY (Leave blank)	2. REPORT DATE April 1997	3. REPORT TYPE AND DATES COVERED Technical Memorandum	
4. TITLE AND SUBTITLE A Numerical Method for Incompressible Flow with Heat Transfer		5. FUNDING NUMBERS 522-31-12	
6. AUTHOR(S) Jong-Youb Sa* and Dochan Kwak			
7. PERFORMING ORGANIZATION NAME(S) AND ADDRESS(ES) Ames Research Center Moffett Field, CA 94035-1000		8. PERFORMING ORGANIZATION REPORT NUMBER A-976254	
9. SPONSORING/MONITORING AGENCY NAME(S) AND ADDRESS(ES) National Aeronautics and Space Administration Washington, DC 20546-0001		10. SPONSORING/MONITORING AGENCY REPORT NUMBER NASA TM-110444	
11. SUPPLEMENTARY NOTES Point of Contact: Dochan Kwak, Ames Research Center, MS T27B-1, Moffett Field, CA 94035-1000 (415) 604-6743 *NRC Research Associate. Present address: Dept. of Mechanical Engineering, Yeungnam University, Gyongsan 632, Korea			
12a. DISTRIBUTION/AVAILABILITY STATEMENT Unclassified — Unlimited Subject Category 34		12b. DISTRIBUTION CODE	
13. ABSTRACT (Maximum 200 words) A numerical method for the convective heat transfer problem is developed for low speed flow at mild temperatures. A simplified energy equation is added to the incompressible Navier-Stokes formulation by using Boussinesq approximation to account for the buoyancy force. A pseudocompressibility method is used to solve the resulting set of equations for steady-state solutions in conjunction with an approximate factorization scheme. A Neumann-type pressure boundary condition is devised to account for the interaction between pressure and temperature terms, especially near a heated or cooled solid boundary. It is shown that the present method is capable of predicting the temperature field in an incompressible flow.			
14. SUBJECT TERMS Computational fluid dynamics, CFD, Heat transfer, Incompressible flow		15. NUMBER OF PAGES 14	
		16. PRICE CODE A03	
17. SECURITY CLASSIFICATION OF REPORT Unclassified	18. SECURITY CLASSIFICATION OF THIS PAGE Unclassified	19. SECURITY CLASSIFICATION OF ABSTRACT	20. LIMITATION OF ABSTRACT