

Development of an Automatic Grid Generator for Multi-Element High-Lift Wings

Final Report
NASA Joint Interchange NCC2-5152

by

Scott Eberhardt, Associate Professor
Pratomo Wibowo, Research Assistant
Department of Aeronautics and Astronautics
University of Washington
Seattle, WA 98195

With

Eugene Tu
MS 258-1
NASA Ames Research Center
Moffett Field, CA 94035

Handwritten notes:
1.1
1.2
O.C.T.
1.3

Abstract

The procedure to generate the grid around a complex wing configuration is presented in this report. The automatic grid generation utilizes the Modified Advancing Front Method as a predictor and an elliptic scheme as a corrector. The scheme will advance the surface grid one cell outward and the newly obtained grid is corrected using the Laplace equation. The predictor-corrector step ensures that the grid produced will be smooth for every configuration. The predictor-corrector scheme is extended for a complex wing configuration. A new technique is developed to deal with the grid generation in the wing-gaps and on the flaps. It will create the grids that fill the gap on the wing surface and the gap created by the flaps. The scheme recognizes these configurations automatically so that minimal user input is required. By utilizing an appropriate sequence in advancing the grid points on a wing surface, the automatic grid generation for complex wing configurations is achieved.

Table Of Contents

| | |
|--|-----------|
| List of Figures | ii |
| Chapter 1 Introduction | 1 |
| Chapter 2 Advancing Scheme | 3 |
| 2.1. Predictor Step | 3 |
| 2.2. Corrector Step | 7 |
| Chapter 3 Overall Advancement Procedure | 18 |
| 3.1. Concave Blocks | 18 |
| 3.1.1. Wing Gap | 19 |
| 3.1.2. Guided Front | 19 |
| 3.2. Offset Blocks | 21 |
| 3.3. Outer Blocks | 22 |
| Chapter 4 Applications | 30 |
| 4.1. Wing with Split Flap Configuration | 30 |
| 4.2. Wing with Finite-Thickness Split Flap Configuration | 31 |
| Chapter 5 Conclusions | 45 |
| Bibliography | 46 |
| Appendix A Input Parameters | 47 |

List of Figures

| | | |
|-------------|---|----|
| Figure 2-1 | Difference between grid block and fronts | 10 |
| Figure 2-2 | Modification to a block so that it has one-to-one connectivity property with adjacent fronts | 10 |
| Figure 2-3 | Calculation of normal vector for three-dimensional front | 10 |
| Figure 2-4 | Degree of Guidedness = 1 : (a) Initial grid blocks with angle between two fronts of 100 degree, (b) Grid after two advancements, (c) Final result of the grid advancement | 11 |
| Figure 2-5 | Degree of Guidedness = 0 : (a) Initial grid blocks with angle between two fronts of 200 degree, (b) Result after three grid advancements, (c) Final result of the grid advancement | 12 |
| Figure 2-6 | Degree of Guidedness = - 1 : (a) Initial grid blocks with angle between two fronts of 300 degree, (b) Advancement of the grid for the first front, (c) Final result of the grid advancement | 13 |
| Figure 2-7 | Degree of Guidedness = - 2 : (a) Initial grid blocks with angle between two fronts of 330 degree, (b) Each grid front advance independently, (c) Final result of the grid advancement | 14 |
| Figure 2-8 | Degree of Guidedness = - 3 : (a) Initial grid front without any grid blocks connected to its sides, (b) Result after five grid advancements | 15 |
| Figure 2-9 | Imposing the Degree of Guidedness value other than the default value : (a) Initial grid with angle between two fronts of 300 degree, (b) Result of the grid advancement using the default value (DOG = -1), (c) Result of the grid advancement using the imposed value (DOG = 0) | 16 |
| Figure 2-10 | Result of Predictor-Corrector scheme on a concave front : (a) Initial grid with angle of 120 degree, (b) Result after four advancement | 17 |

| | | |
|-------------|--|----|
| Figure 3-1 | Example of a gap on the trailing edge of a wing | 23 |
| Figure 3-2 | Creating a bridging front | 23 |
| Figure 3-3 | Advancing the bridging front guided by three other fronts | 24 |
| Figure 3-4 | Final result of the advancement and the gap is filled with the grid ... | 24 |
| Figure 3-5 | Initial grid blocks with angle between two fronts of 30 degree (Degree of Guidedness = 2) | 25 |
| Figure 3-6 | Creating a new bridging front | 25 |
| Figure 3-7 | Advancing the new front guided by initial fronts | 26 |
| Figure 3-8 | Final result of the grid advancement | 26 |
| Figure 3-9 | Initial grid blocks that have two irregularities | 27 |
| Figure 3-10 | Result of grid advancement by filling the cavity on the initial grid surface | 27 |
| Figure 3-11 | Result of grid advancement by growing the guided front | 28 |
| Figure 3-12 | Example of offset block advancement : (a) Advancing the first front as many cells as the number specified by the user, (b) Advancing the subsequent front for the same number of cells, (c) Final result of the offset grid advancement process | 29 |
| Figure 4-1 | Initial grid of a P-51 Mustang wing with split flaps | 33 |
| Figure 4-2 | Fill the gap on the left part of the wing | 33 |
| Figure 4-3 | Fill the gap on the right part of the wing | 34 |
| Figure 4-4 | Advance the grid to fill the gap between the wing surface and the split flap on the right part of the wing | 34 |
| Figure 4-5 | Advance the grid to fill the gap between the wing surface and the split flap on the left part of the wing | 35 |
| Figure 4-6 | Generate the grids of the fronts between two split flap | 35 |
| Figure 4-7 | Advancing the front that has guided side on the right wing | 36 |
| Figure 4-8 | Advancing the front that has guided side on the left wing. The grid after completed the concave block advancement | 36 |
| Figure 4-9 | Advancement of the first front (lower and upper wing surface) | 37 |

| | |
|--|----|
| Figure 4-10 Advancement of the second front (left wingtip surface) | 37 |
| Figure 4-11 Advancement of the third front (right wingtip surface) | 38 |
| Figure 4-12 Final Grid after all advancement stages is completed | 38 |
| Figure 4-13 Initial grid of a P-51 Mustang wing with finite-thickness split flaps . | 39 |
| Figure 4-14 Fill the gap on the left part of the wing | 39 |
| Figure 4-15 Fill the gap on the right part of the wing | 40 |
| Figure 4-16 Advance the grid to fill the gap between the wing surface and the finite-thickness split flap on the right wing | 40 |
| Figure 4-17 Advance the grid to fill the gap between the wing surface and the finite-thickness split flap on the left wing | 41 |
| Figure 4-18 Generate the grids of the fronts between two split flaps | 41 |
| Figure 4-19 Advancing the front that has guided side on the right wing | 42 |
| Figure 4-20 Advancing the front that has guided side on the left wing. The grid after completed the concave block advancement | 42 |
| Figure 4-21 Advancement of the first front (lower and upper wing surface) | 43 |
| Figure 4-22 Advancement of the second front (left wingtip surface) | 43 |
| Figure 4-23 Advancement of the third front (right wingtip surface) | 44 |
| Figure 4-24 Final Grid after all advancement stages are completed | 44 |

Chapter 1

Introduction

Grid generation is very crucial to computational fluid dynamics applications. The numerical approximation of partial differential equations requires the discretization of the entire flow field. The accuracy and efficiency of numerical solutions are highly dependent on the grids that discretize the domain. The grid generation process is still the labor-intensive and time-consuming part in computing the flow field around a complex three-dimensional configuration. Robust grid generation codes are needed to reduce the user interference to a minimum and to increase the capabilities to generate the grids around a complex configuration. Therefore, an automatic grid generation is highly desired.

The present research extends the method previously developed by Kim¹. The method combines a hyperbolic-type predictor and an elliptic-type corrector. The predictor utilizes the Modified Advancing Front Method and the Laplace equation is used as the corrector. The Modified Advancing Front Method generates the grid by advancing a layer of a quadrilateral grid cell. The predictor uses the geometric information of the initial grid of the interested body. The corrector step prevents the grids from skewing and overlapping in highly curved configurations. The method reduces the amount of user input required for on the grid generation process.

The automatic grid generation is extended so that it can generate the grid around a complex flapped wing configuration with minimal user input. The predictor-corrector method is used as the basic rule of the grids advancement, however several modifications are introduced so that the current grid generation scheme can accommodate the more complex wing configuration. New techniques are introduced to handle the irregularities that exist on an initial grid. A cut on a wing surface and a gap

between the wing surface and flaps can be considered as irregularities. The procedure used in the grid generation process is also established in the research. The procedure includes a scheme which recognizes irregularities, fixes them and then determines the sequence of advancements. These efforts are done to automate the grid generation process so that the cost to generate the grid can be reduced.

In Chapter 2, the three-dimension Modified Advancing Front Method is explained. This method is the basic scheme to advance the grids of a body surface. Two new procedures to generate the grids are discussed in Chapter 3. These procedures are automated the process of grid generation around the wing-flap configuration. In chapter 4, the two examples of complex wing configuration are presented. Finally, the conclusions of the present research and suggestions for future research are given on Chapter 5.

Chapter 2

Advancing Scheme

In this chapter, the advancing scheme is discussed. It is based on a hyperbolic-type predictor with an elliptic-type corrector. The predictor uses the Modified Advancing Front Method and Laplace's equation is used as a corrector. A 3-layer grid system is established for the scheme. The first layer is the grid before the advancement and the second layer consists of the grid generated by the predictor step. Finally, the third layer is created by mirroring the first grid layer with respect to the middle, or second grid. Then the corrector step is applied to the 3-layer grid system and the resultant grid becomes the next grid advancement. The predictor-corrector step is done repeatedly to generate the grid on the entire domain of interest.

2.1. Predictor Step

The first step of the scheme is the predictor step. It uses a marching scheme similar to those used in the hyperbolic grid generation. It advances the grids outward with the distance that is specified by the user. The idea of Advancing Front Method (AFM) was originally used to generate unstructured triangular meshes³. It was then modified to generate quadrilateral grids for two-dimensions by Kim². Then the new scheme was applied to three-dimensions¹.

Some terminology is used in the grid generation scheme and they will appear throughout the chapters.

1. A Block is a collection of grid points. A block can represent one of the wing parts. For example : wingtip, upper or lower wing surface, flap and so on.

2. A Multi-block is a collection of several grid blocks that will become a front. The default rule in forming a front is that the two adjacent blocks have to be connected smoothly
3. Degree of Guidedness (DOG) is a parameter for the connectivity between the host and donor front. The host front is the front of interest while the donor fronts are the fronts that are connected to the host front.

An illustration of a grid block and multi-block front is shown in figure 2.1.

The advancement of each front is solely driven by the relation with its neighboring fronts. Each front is required to have one-to-one connectivity to the adjacent front. This means that each corner of a front meets with a corner of the other front. This property is maintained throughout the process of generating the grids. If, in some circumstances, a particular corner does not meet other corners, the front is modified so that the one-to-one connectivity is preserved. The illustration of this process is presented in figure 2.2.

After the connectivity is established, the advancing vector and advancing distance have to be calculated for each point on the front of interest. The direction of the advancement is determined by a simple “right hand rule,” that is, the direction of grid generation is the result of the cross product of i-vector and j-vector on the body surface. In order to obtain an advancing vector, the normal vector is calculated using the geometric information of the surface and the formula used is :

$$\vec{v}_{normal} = \frac{1}{I} \sum_{i=1}^I \frac{\vec{v}_i \times \vec{v}_{i+1}}{|\vec{v}_i| |\vec{v}_{i+1}|}$$

$$\text{with } \vec{v}_{I+1} = \vec{v}_1$$

where I is the number of surrounding points and \vec{v}_i is the vector from the point of interest to surrounding points. Figure 2.3. shows the schematic of the calculation of normal vector. An advancing vector can be calculated by adjusting the normal vector based on the vector at each corner of a particular front. The corner vector is calculated based on the Degree of Guidedness value of a side of the front. Depending on the

value of Degree of Guidedness, the advancing distance is determined from the user's input parameters or the adjacent fronts. Different Degree of Guidedness values will give different corner vectors and advancing distances, as will be discussed later.

Since the grid advancement is solely driven by the geometry of the body surface, the Degree of Guidedness is crucial to provide the geometric information. It determines the advancement of the grid block and the value is determined from the angle between the host and donor front and the number of donor fronts that are connected to the host front. The angle is calculated by averaging the angle at each grid point along a connected side. The Degree of Guidedness parameter is used to form the multi-block front and to determine the priority advancement of each multi-block front. There are five values of degree of guidedness.

A side that has degree of guidedness equal to one is categorized as guided advancement since this advancement is done by using the neighboring grid block as a guiding front. This type of advancement does not need user's input since all necessary parameters are obtained from the guide front. These parameters are number of advancement, advancing distance and direction of the grid.

Degree of guidedness = 1 is assigned to a side that has angle greater or equal than forty-five degrees and less than 135 degrees. An initial grid is illustrated in figure 2-4(a). The advancement process is started by determining the active front. An active front is a front that will advance using the other front as a guide. The advancing vectors and advancing distances are obtained from the adjacent guided front. The first two grid advancements are shown on figure 2-4(b). This advancement continues until the guide front is covered with new quadrilateral cells as presented on figure 2-4(c)

Degree of guidedness values of 0, -1, -2 and -3 are known as free advancement. The free advancement requires user input through the input file mapbg.inp, which is explained in appendix A. In this case, an adjusted normal direction is taken as the advancing direction and the advancing distance is supplied by the user.

Degree of guidedness of zero is assigned to a side that is connected to a side of neighboring grid block smoothly and has an angle greater than or equal to 135 degrees and less than or equal to 225 degrees. The initial grids are shown in figure 2-5(a). Since these blocks are smoothly connected, they become one front and will advance simultaneously. The advancing distance and the number of advancement are given by the user through the input file. The process of the grid advancement for this value of degree of guidedness is illustrated on figure 2-5(b) and (c).

Degree of guidedness = -1 is assigned to a side that has an angle greater than 225 degrees and less than or equal to 315 degrees. Two initial block grids are shown in figure 2-6(a). For this value of degree of guidedness, there are two fronts in the initial grid block. The process is initiated by advancing the grid on one of the fronts as many steps as specified in the input file and the advancing distance is given by the user. This first step is illustrated on figure 2-6(b). Then the next step is to combine the grid on the other front with its adjacent block that is created as a result of the first front advancement. These two fronts will advance simultaneously similar to the grid blocks that have degree of guidedness of zero. The number of advancement and its distance is also specified by the user. The final grid is shown on figure 2-6(c).

Degree of Guidedness (DOG) = -2 is assigned to the side that has an angle greater than 315 degrees and less than 360 degrees. The initial grid is shown on figure 2-7(a). Since these blocks are not connected in a smooth sense, each block becomes a front. Then, each front grows independently using the parameters specified by the user. As the result of these two grid advancements, a third front is created and is shown on figure 2-7(b). The next step is to advance this newly formed front with the number and distance that is specified by the user. The grid generated by this type of process is illustrated on figure 2-7(c).

The last value of degree of guidedness is -3. This value is assigned to a side that does not have a grid block connected to it. This free advancement uses the normal

vector as the advancing vector and the advancing distance is specified by the user. The process of the grid generation is given on figure 2-8(a) and (b).

The criteria above are used to decide the default value of degree of guidedness between grid blocks; however, if necessary, other value can be assigned to the side of the block. This value is changed through an input file called uicall.inp and the input file is explained in appendix A. Figure 2-9(a) shows two grid blocks that have angle of 300 degrees. According to the default criteria, this connection has the degree of guidedness equals to -1. The grid resulted from the default value of degree of guidedness is illustrated on figure 2-9(b). However, by using the input file, a value zero can be assigned to the connected side. The result is that the two blocks will become one front and advance simultaneously as shown in figure 2-9(c). It can be seen that totally different grids are generated by the two different values; however, in some cases, it is impossible to generate a grid using the assigned value of degree of guidedness. The feature to specify the degree of guidedness will enable the user to modify the grid generation so that the grid produced is suitable for the problem of interest.

Thus, the grid produced becomes the second layer of 3-layer grid system. The grid produced may contain some non-smooth surfaces that can be magnified as the grids grow further. This is where the corrector step plays an important role in correcting this problem.

2.2. Corrector Step

The elliptic grid generation scheme is used as the corrector step. The Laplace's equations are used as the elliptic equation by following Cordova's approach³. It is used to smooth any irregularities that exist on the original front which is the first layer grid on the 3-layer grid system.

The 3-D Laplace's equations are written as

$$\begin{aligned}\xi_{xx} + \xi_{yy} + \xi_{zz} &= 0 \\ \eta_{xx} + \eta_{yy} + \eta_{zz} &= 0 \\ \varsigma_{xx} + \varsigma_{yy} + \varsigma_{zz} &= 0\end{aligned}$$

where (x,y,z) are the coordinates in the physical domain and (ξ,η,ς) are the coordinates in the computational domain. Then the 3-D Laplace's equations are transformed by applying the transformation

$$\begin{aligned}\xi &= \xi(x, y, z) \\ \eta &= \eta(x, y, z) \\ \varsigma &= \varsigma(x, y, z)\end{aligned}$$

to get the following equations.

$$a\vec{X}_{\xi\xi} + b\vec{X}_{\eta\eta} + c\vec{X}_{\varsigma\varsigma} + d\vec{X}_{\xi\eta} + e\vec{X}_{\eta\varsigma} + f\vec{X}_{\xi\varsigma} = 0$$

where \vec{X} is a position vector i.e. $\vec{X}=[x,y,z]^T$ and the coefficients are

$$\begin{aligned}a &= (z_\varsigma y_\eta - y_\varsigma z_\eta)^2 + (z_\varsigma x_\eta - x_\varsigma z_\eta)^2 + (y_\varsigma x_\eta - x_\varsigma y_\eta)^2 \\ b &= (z_\varsigma y_\xi - y_\varsigma z_\xi)^2 + (z_\varsigma x_\xi - x_\varsigma z_\xi)^2 + (y_\varsigma x_\xi - x_\varsigma y_\xi)^2 \\ c &= (z_\eta y_\xi - y_\eta z_\xi)^2 + (z_\eta x_\xi - x_\eta z_\xi)^2 + (y_\eta x_\xi - x_\eta y_\xi)^2 \\ d &= 2\{(y_\varsigma z_\eta - z_\varsigma y_\eta)(z_\varsigma y_\xi - y_\varsigma z_\xi) + (z_\varsigma x_\eta - x_\varsigma z_\eta)(x_\varsigma z_\xi - z_\varsigma x_\xi) \\ &\quad + (y_\varsigma x_\eta - x_\varsigma y_\eta)(x_\varsigma y_\xi - y_\varsigma x_\xi)\} \\ e &= 2\{(z_\varsigma y_\xi - y_\varsigma z_\xi)(y_\eta z_\xi - z_\eta y_\xi) + (z_\varsigma x_\xi - x_\varsigma z_\xi)(x_\eta z_\xi - z_\eta x_\xi) \\ &\quad + (y_\varsigma x_\xi - x_\varsigma y_\xi)(x_\eta y_\xi - y_\eta x_\xi)\} \\ f &= 2\{(y_\varsigma z_\eta - z_\varsigma y_\eta)(y_\eta z_\xi - z_\eta y_\xi) + (x_\varsigma z_\eta - z_\varsigma x_\eta)(x_\eta z_\xi - z_\eta x_\xi) \\ &\quad + (x_\varsigma y_\eta - y_\varsigma x_\eta)(x_\eta y_\xi - y_\eta x_\xi)\}\end{aligned}$$

The Laplace equations are used to smooth the grid produced by the predictor step. In order to solve the equations, boundary conditions are required. Therefore, the third layer on the 3-layer grid system is introduced as the boundary conditions. It is

generated by mirroring the first grid layer with respect to the second grid layer i.e. the predicted grid. Then the transformed elliptic equations are solved iteratively by the successive over-relaxation (SOR) method until the solution converges to the specified convergence criteria. The solution of the Laplace equations become the new smoother grid distribution and becomes the next grid advancement.

Figure 2-10(a) illustrates an initial grid with an angle of 120 degrees. The grid will be advanced four steps and the result is shown in figure 2-10(b). It can be seen that the final grid is smooth unlike the curved surface of the initial grid. This unique feature of the corrector scheme is to smooth the predicted grids even for highly curved surface.

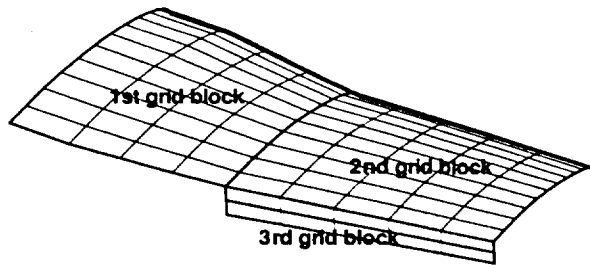

The 1st and 2nd block can be combined to form a front

Figure 2-1 Difference between grid blocks and front.

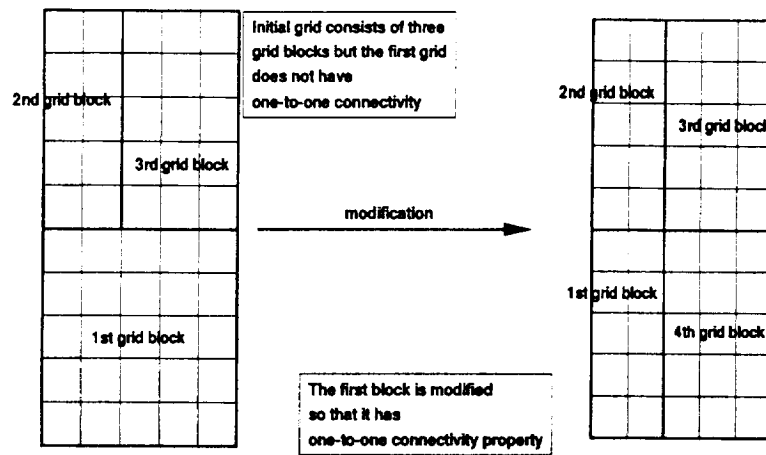

Figure 2-2 Modification to a block so that it has one-to-one connectivity property with adjacent fronts.

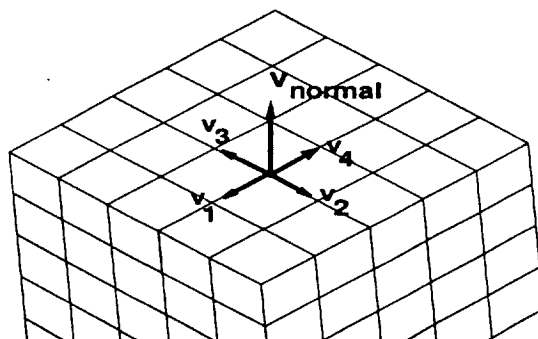

Figure 2-3 Calculation of a normal vector for three dimensional front.

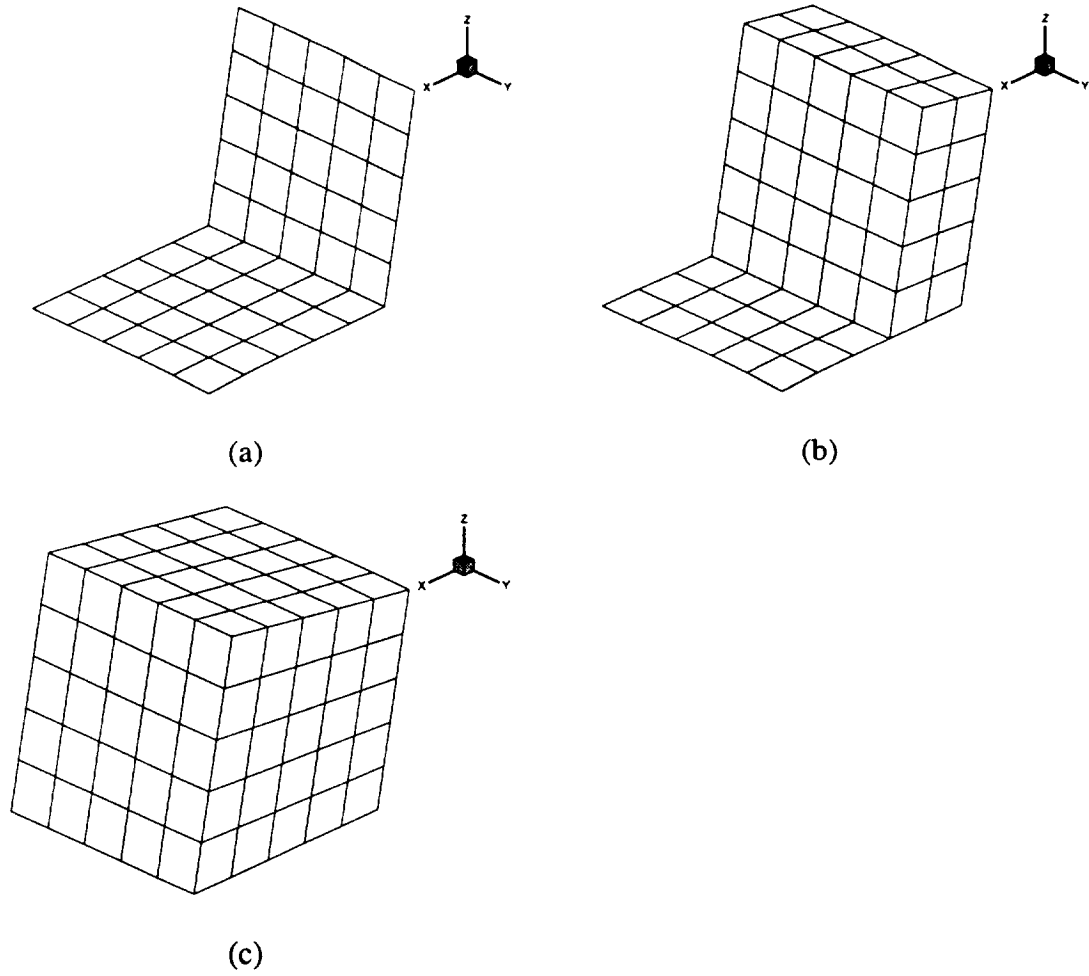

Figure 2-4 Degree of Guidedness = 1 : (a) Initial grid blocks with angle between two fronts of 100 degree, (b) Grid after two advancements, (c) Final result of the grid advancement.

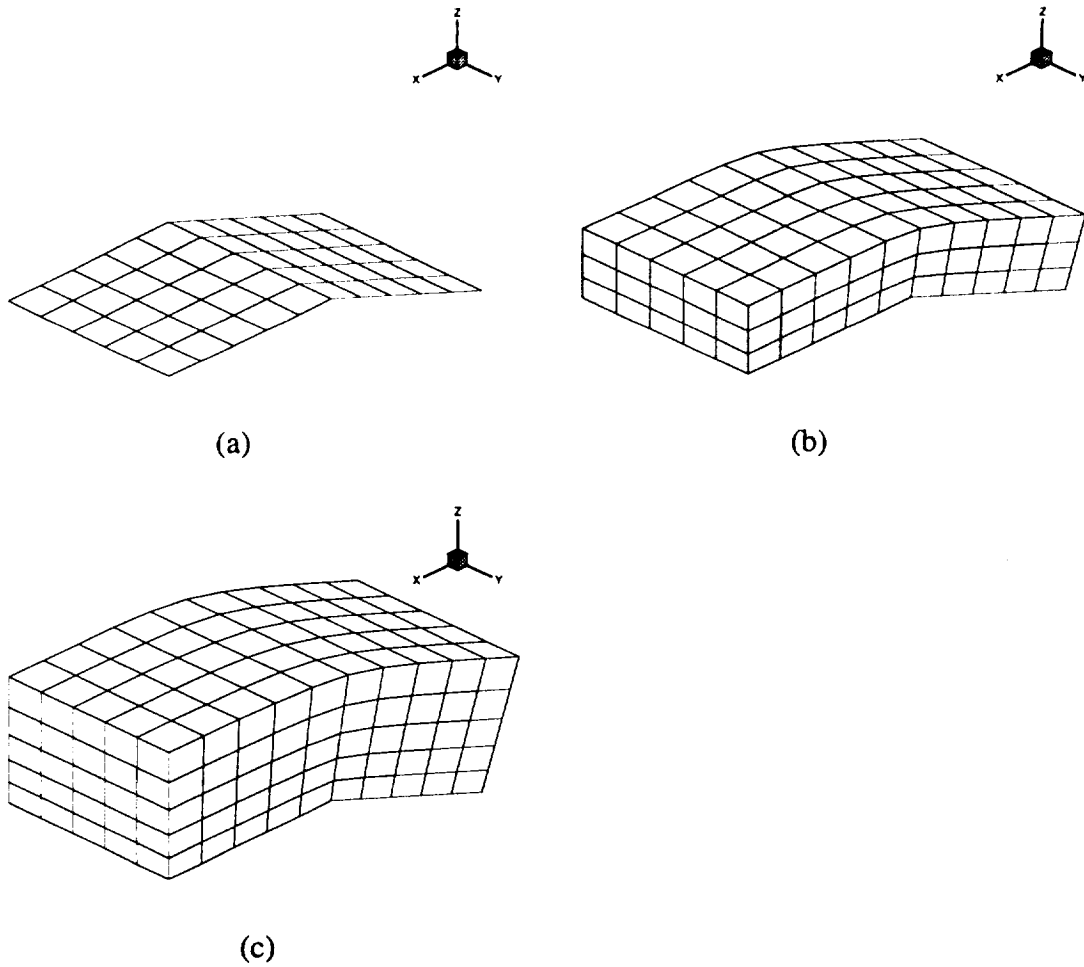

Figure 2-5 Degree of Guidedness = 0 : (a) Initial grid blocks with angle between two fronts of 200 degree, (b) Result after three grid advancements, (c) Final result of the grid advancement.

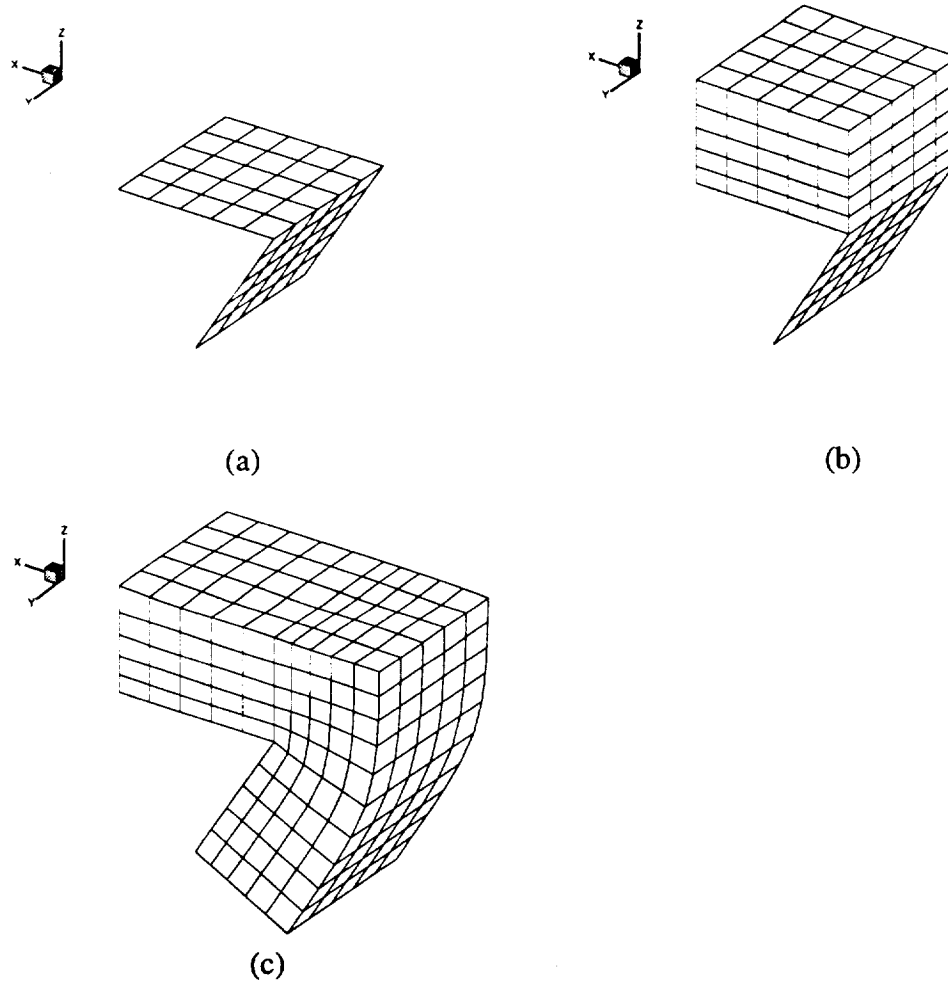

Figure 2-6 Degree of Guidedness = -1 : (a) Initial grid blocks with angle between two fronts of 300 degree, (b) Advancement of the grid for the first front, (c) Final result of the grid advancement.

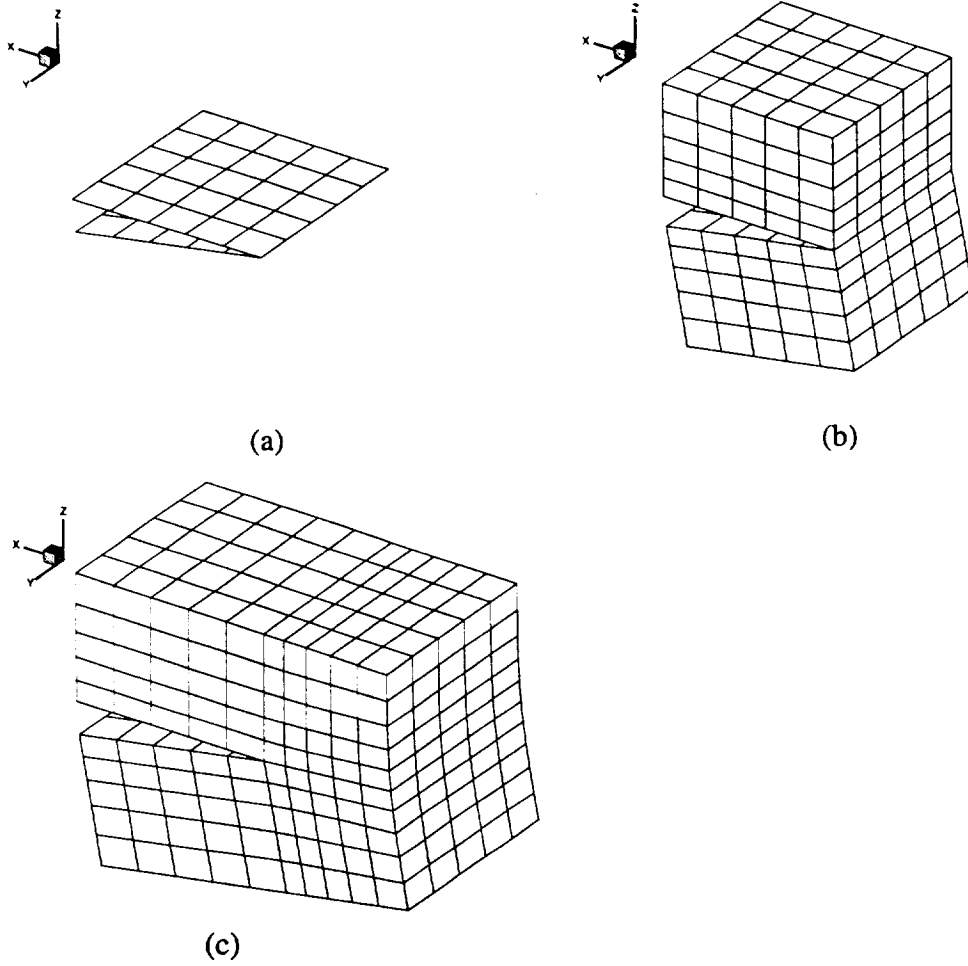

Figure 2-7 Degree of Guidedness = - 2 : (a) Initial grid blocks with angle between two fronts of 330 degree, (b) Each grid front advances independently, (c) Final result of the grid advancement.

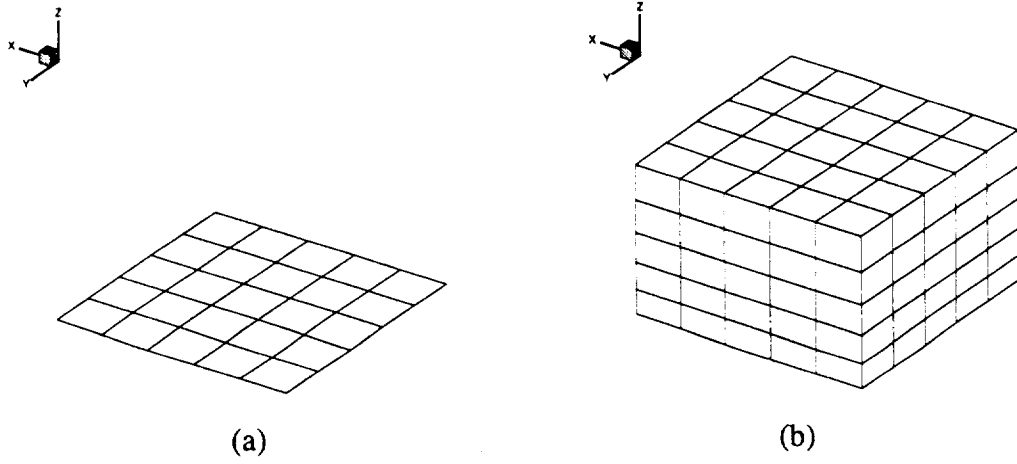

Figure 2-8 Degree of Guidedness = - 3 : (a) Initial grid front without any grid blocks connected to its sides, (b) Result of the grid after five advancements.

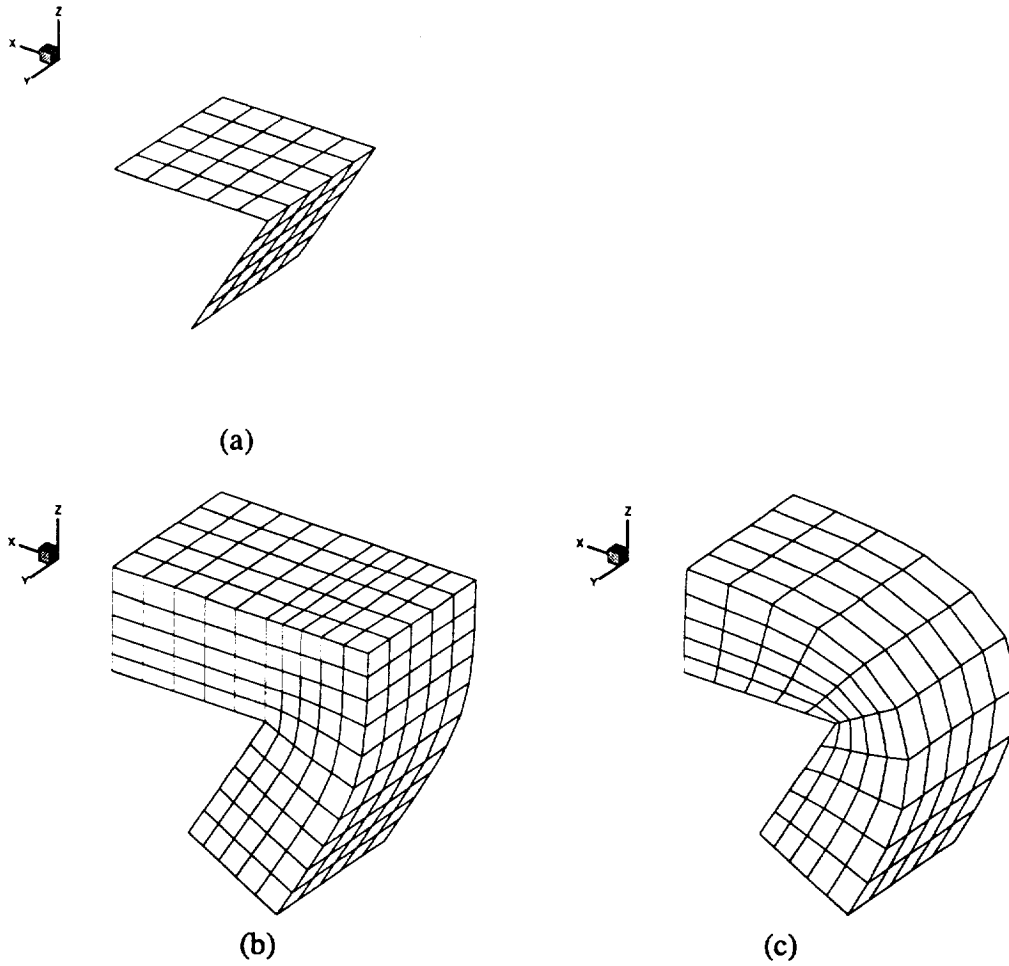

Figure 2-9 Imposing the Degree of Guidedness value other than the default value : (a) Initial grid with angle between two fronts of 300 degree, (b) Result of the grid advancement using the default value (DOG = -1), (c) Result of the grid advancement using the imposed value (DOG = 0).

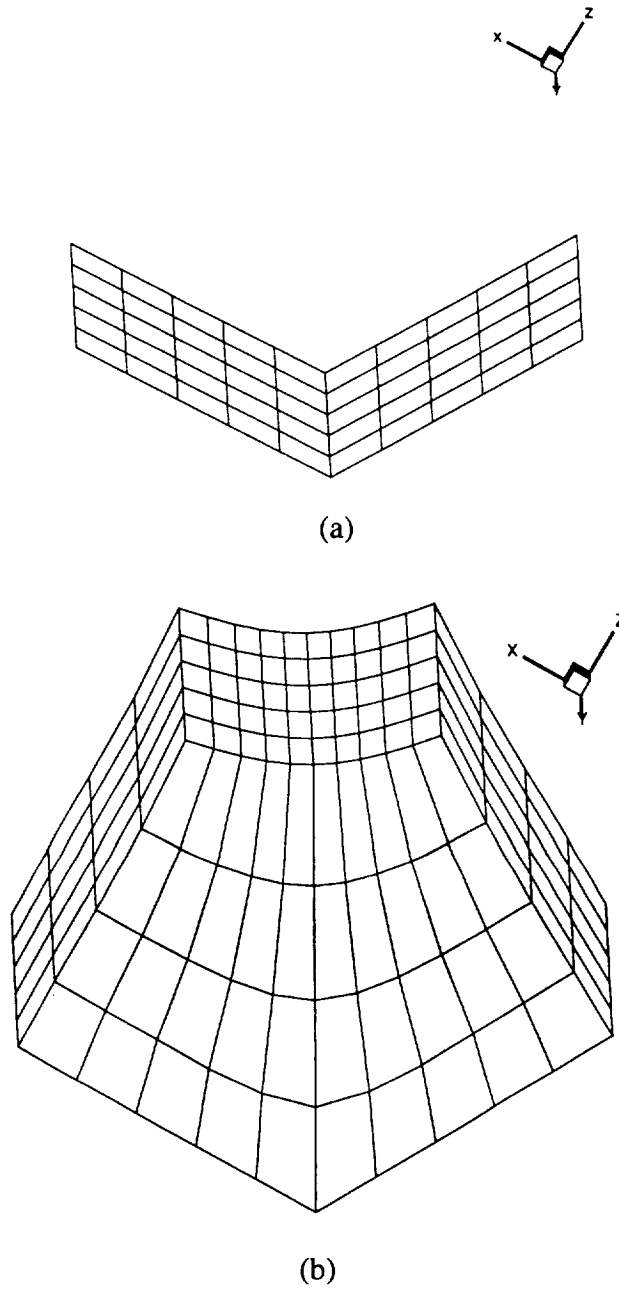

Figure 2-10 Result of Predictor-Corrector scheme on a concave front : (a) Initial grid with angle of 120 degree, (b) Result after four front advancements.

Chapter 3

Overall Advancement Procedure

This chapter explains the strategy of front advancements. The advancement is done sequentially according to the priority that is assigned to each front. There are three stages of advancement : concave block, offset block and outer block advancement. Each stage has its own strategy of front advancement. The advancement of the front that has higher priority is done on the concave block stage. Then the rest of the advancement is done on the offset and outer block stage.

The surface grids are composed of several blocks, especially for a complex configuration. Each block represents a part of a particular configuration. In the wing surface, for example, a block can represent an upper surface, a flap, a wingtip or other part of the wing. Then the degree of guidedness of each block is determined. From these values, a front can be created. A front consists of several grid blocks that are connected smoothly. The scheme advances each front depending on the geometric information of the surrounded blocks. Therefore, each front has its own characteristics such as a number of guiding fronts or blocks that surrounded that particular front. These characteristics are utilized to set the priority of advancement of each front.

3.1. Concave Blocks

The grid generation of the concave blocks is the first step of the overall procedure. The purpose of this stage is to fix any irregularities that exist on the initial grid surface. A cavity or a cut on the body surface can be considered as irregularities. The fix is needed in order to advance the initial fronts further outward. The grid front advancement is done automatically and does not need the input parameters. The

advancing vectors and advancing distances are determined from the neighboring fronts. In the concave advancement, the identification process of the irregularities is very crucial since each type requires a unique procedure. After all irregularities on the body surface are eliminated, the concave block advancement is completed.

3.1.1. Wing Gap

The wing gap is any cut or gap that exist on the wing surface. This irregularity is the highest priority for the grid advancement. It has to be fixed before any front can advance. Figure 3-1 shows a close-up of a cut on the trailing edge of a wing where the flap would be. The grid has to be generated to fill the cavity exist when the flap is deployed. First, some information about the edge of the gap needs to be collected. The number of grid point along each side of the fronts is determined. Based on these numbers, a front is created to bridge the sides. The result of the generated front is presented in figure 3-2. Then the newly generated front is set as an active front. This means that this front will advance with the guidance of three fronts that surrounded it. The advancing distances and advancing vectors can be determined from those guide fronts. The predictor-corrector step is applied to the front and the result of the first advancement is shown in figure 3-3. The front continues to advance using the predictor-corrector step until it fills the whole gap. It can be seen that the cut on the wing surface has been fixed using the procedure described above. The result of the grid advancement is shown in figure 3-4.

3.1.2. Guided Front

The next priority is given to a front that is connected to other fronts with its angle between adjacent fronts less than forty-five degrees and greater than zero. A degree of guidedness of two is assigned to a side of the front that has these

characteristics. Figure 3-5 shows the sample of initial grid blocks for this degree of guidedness value. The grid advancement is unique from other degree of guidedness values because it will create a ray of grid lines that originated from the singular end. The number of lines is determined from the size of the angle. A new front is created to bridge the two original fronts as shown in figure 3-6. The newly created front becomes an active front that will advance with the guidance of two original fronts. The advancement distance is determined by the grid spacing of the initial fronts and the advancing vectors follow the grid of the initial fronts. The predictor-corrector scheme is used and the first few advancement is shown in figure 3-7. This advancement continues until the area between the initial fronts is filled. The final result of the grid development for this degree of guidedness is illustrated in figure 3-8. This type of advancement will ensure that the grid has minimal skewness.

The lowest priority is given to fronts that have a degree of guidedness value equal to one on any of its sides. This means that a particular front will advance with the guidance of the surrounded fronts. The number of guided fronts that are connected to the font of interest needs to be determined. The front that has the most guided fronts advances first followed by other fronts that have fewer guiding fronts. An initial grid block is presented in figure 3-9. After determining the degree of guidedness of every side of every grid block, it can be seen that there are two fronts that are guided fronts. One front is surrounded by guided fronts and forms a cavity on the body surface. This particular front has four connected guided fronts. The other front has one guided front attached to it. The sequence of the advancement is determined from the number of guided fronts; therefore, the first front advances to fill the cavity and the result are shown in figure 3-10. Then the next front advances and the illustration of this advancement is presented in figure 3-11.

3.2. Offset Block

The next step of the overall advancement of the procedure is done on the offset block. This advancement can be customized according to the user input. The offset block advancement is very crucial in determining the success of the grid generation. It generates the first few grid points closest to the body surface so it becomes the foundation of the grid generation for the rest of the domain. Also, the quality of the grid in this stage has significant influence on the solution of the entire flow field.

The basic rule to advance the front on the offset block is to advance one front the number of steps that is specified by the user with the "nadvoffset" parameter in the mapbg.inp input file that is described in appendix A. After the current advancement is completed, the next front will be advanced. The procedure is repeated until all fronts on the surface grid are advanced. Figure 3-12(a) shows an initial grid surface that consists of six blocks. Since none of the blocks is connected smoothly, there are six fronts on the surface grid. One front is chosen as an active front. The front can be chosen by the user or by the scheme. Then the front advances a number of cells outward as specified by the user as illustrated in figure 3-12(b). After the first advancement is completed, the second front advances in a similar manner to the first one. Figure 3-12(c) shows the front advancing upward. This step is repeated until the advancements of the rest of the front are completed. The final grid result is presented in figure 3-12(c).

The sequence of the front that will be advanced can be determined in two ways. The first method is to use the default sequence. Using this method, front number one advances first and is followed by number two and so on until the last front is reached. Sequential front advancement may not work in some cases. For example, the wingtip cannot be advanced before the wing surface is already advanced. Therefore, the second method is preferred. The user specifies the sequence of the front advancement by specifying the front number in offset.inp input file that is described on

appendix A. By this method, the wing surface advances before the wingtip does. The grid generation of a surface grid can be customized to the user's preference.

3.3. Outer Block

The last stage of the grid advancement is the outer block advancement. The procedure in the outer block is similar to offset block procedure except, in this stage, each front advances one layer outward until the advancement of every front is completed. This step is repeated until the number of advancement specified by the user is satisfied. The number is "nadvmax" in the mapbg.inp input file.

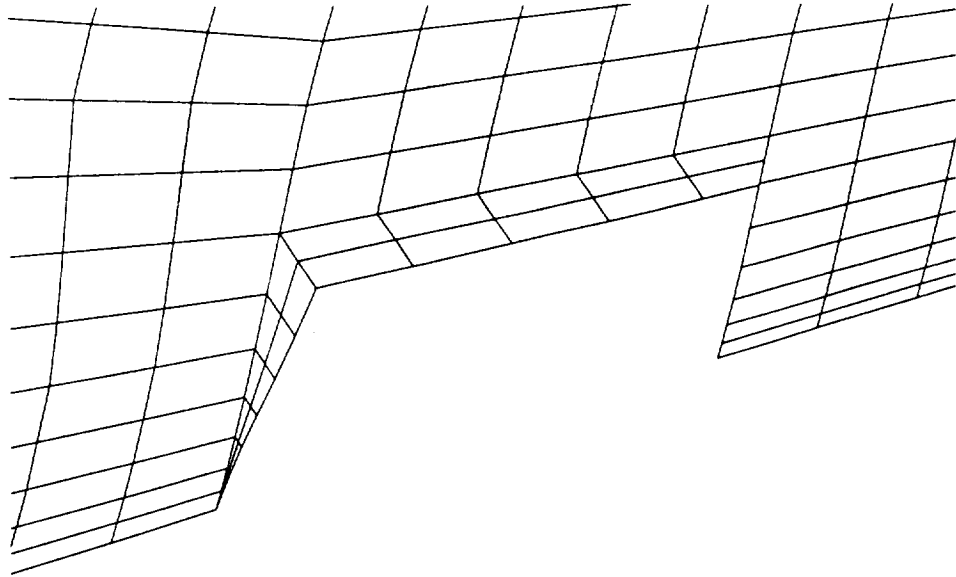

Figure 3-1 Example of a gap on the trailing edge of a wing.

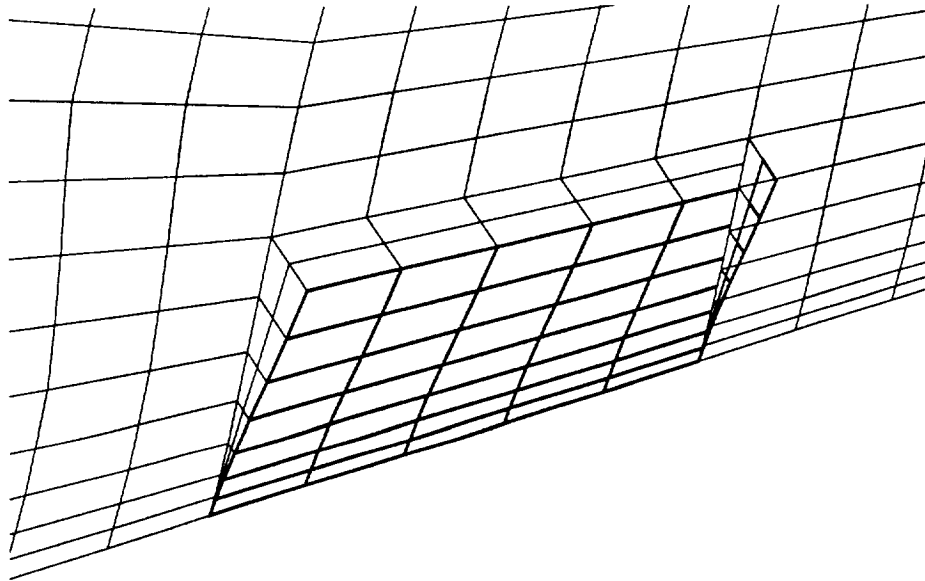

Figure 3-2 Creating a bridging front.

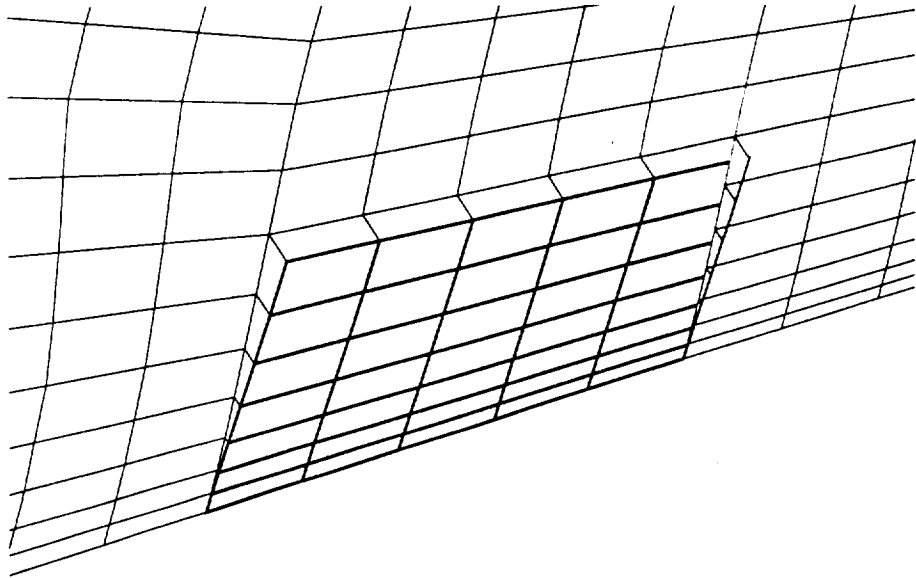

Figure 3-3 Advancing the bridging front guided by three other fronts.

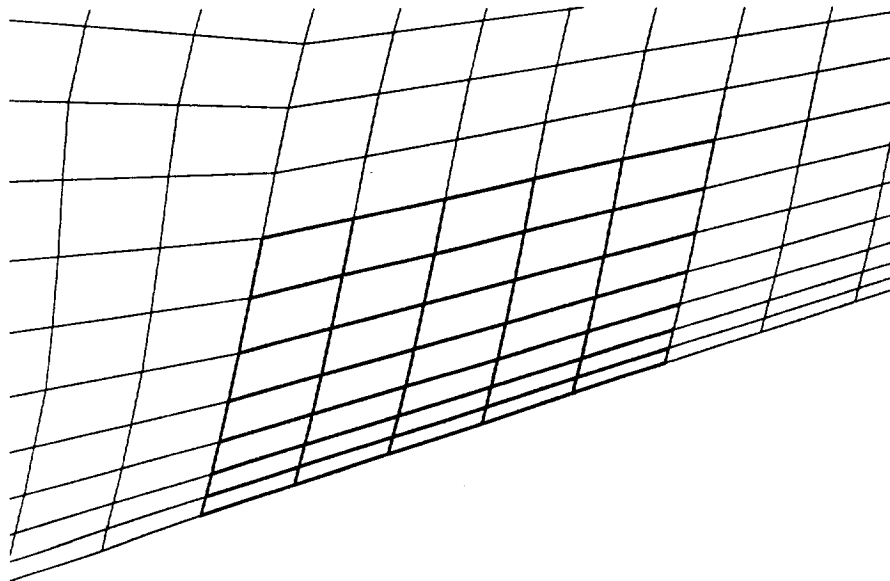

Figure 3-4 Final result of the advancement and the gap filled with the grid.

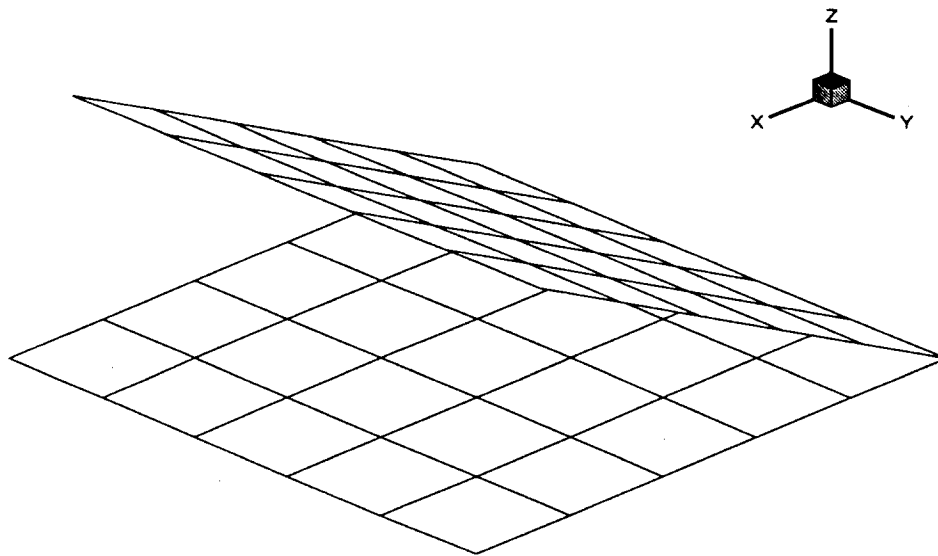

Figure 3-5 Initial grid blocks with angle between two fronts of 30 degree (Degree of Guidedness = 2).

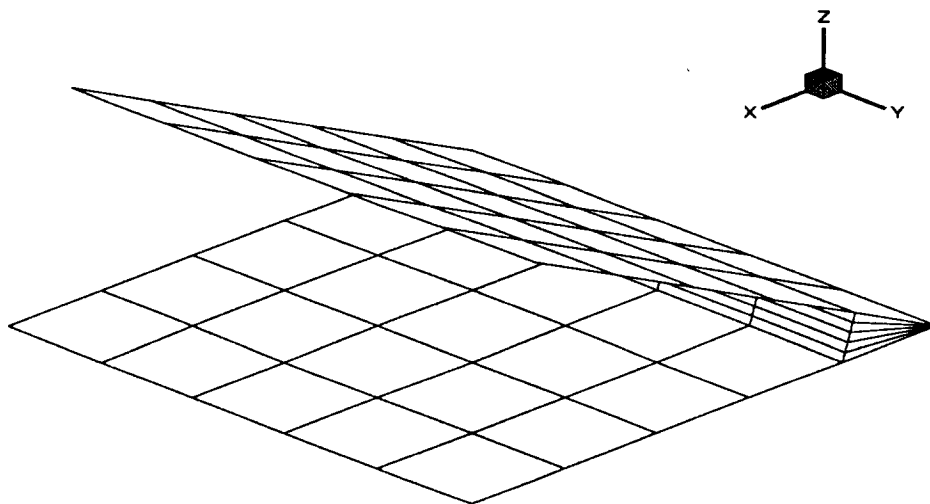

Figure 3-6 Creating a new bridging front.

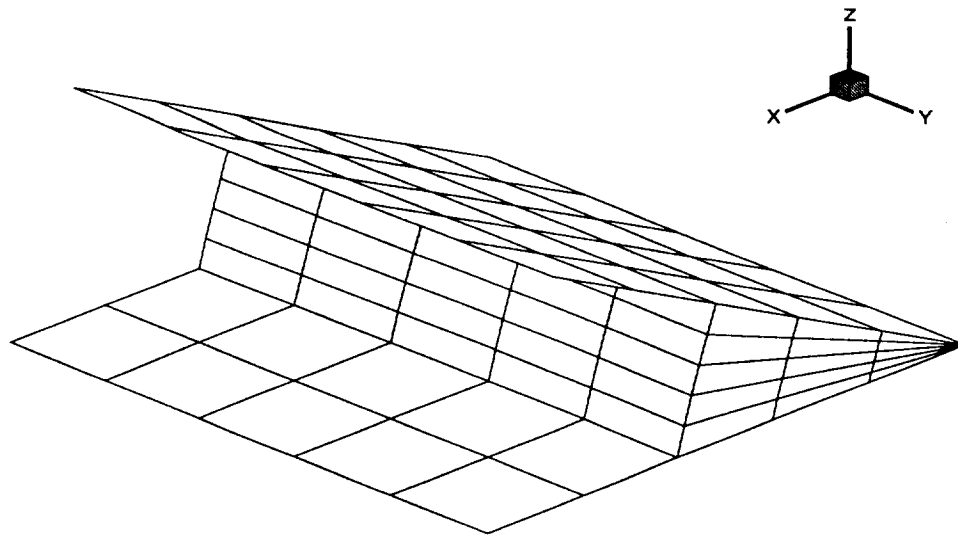

Figure 3-7 Advancing the new front guided by initial fronts.

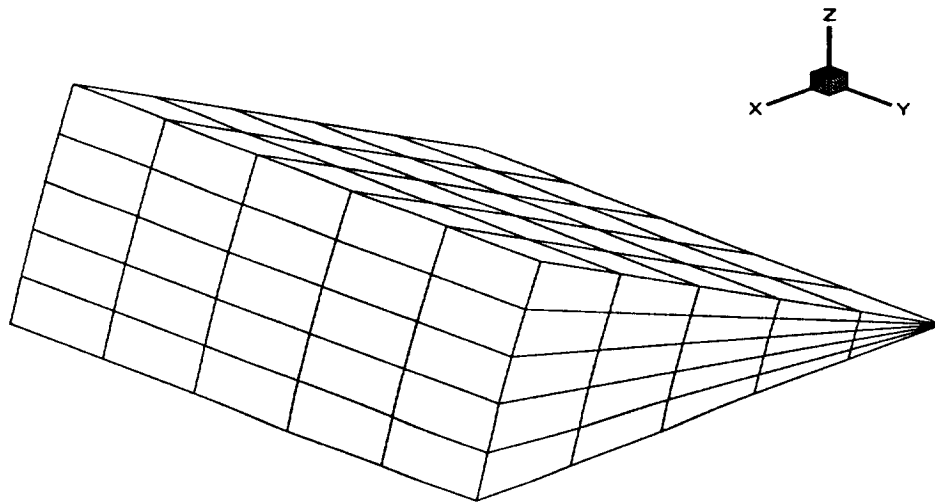

Figure 3-8 Final result of the grid advancement.

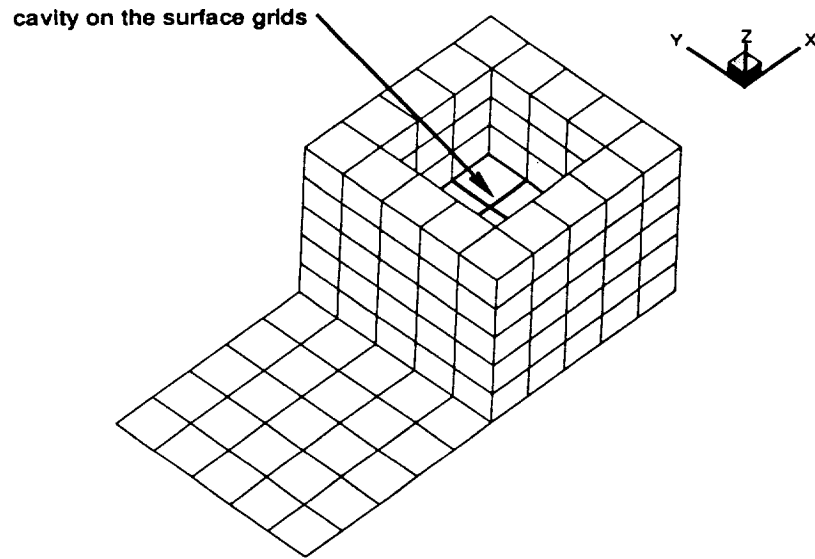

Figure 3-9 Initial grid blocks that have two irregularities.

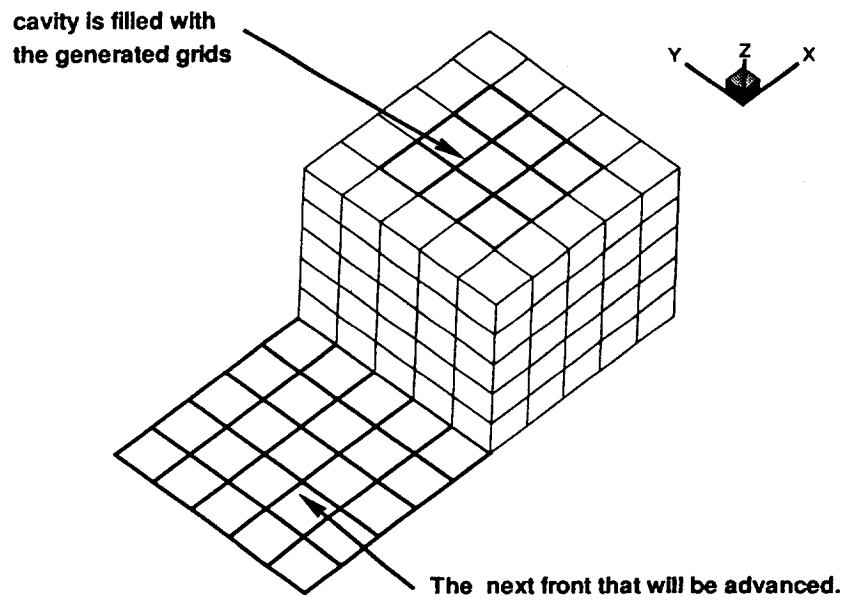

Figure 3-10 Result the grid advancement by filling the cavity on the initial grid surface.

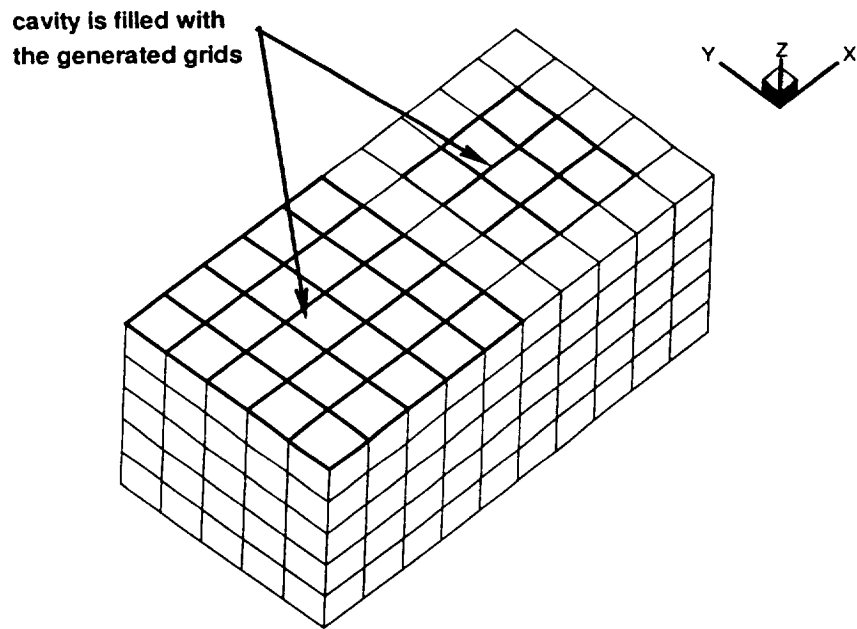

Figure 3-11 Result of the grid advancement by growing the guided front.

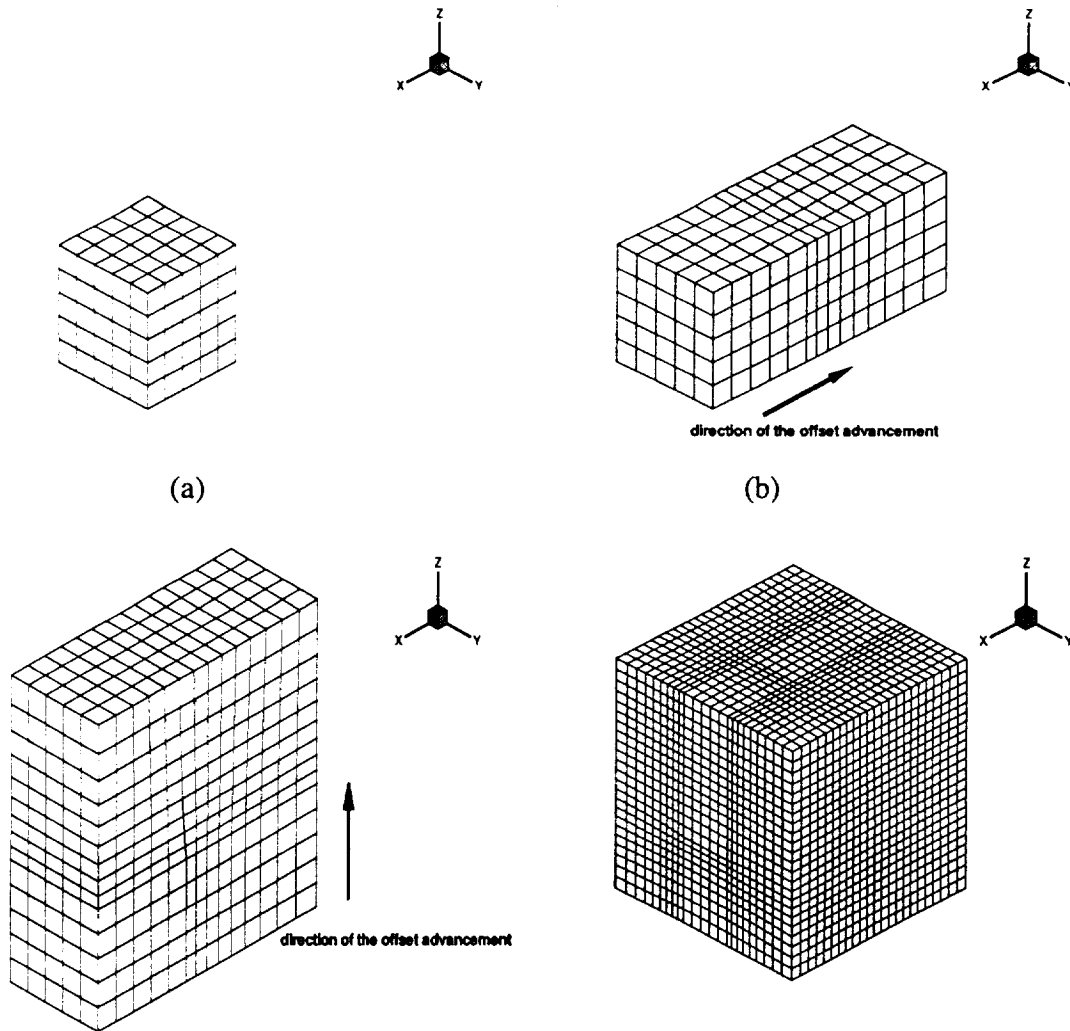

Figure 3-12 Example of offset block advancement : (a) Initial grid that consists of six blocks, (b) Advancing the first front as many cells as the number specified by the user, (c) Advancing the subsequent front for the same number of cells, (d) Final result of the offset grid advancement process.

Chapter 4

Applications

The grid generation for a complex wing configuration using the predictor-corrector scheme is discussed in this chapter. The grids of two different configurations are generated. The first configuration is a wing with a split flap and the second one is a wing with a finite-thickness split flap deflected 30 degrees.

4.1. Wing with Split Flap Configuration

A wing with split flaps is shown in figure 4-1. The configuration has 40 grid blocks with each block represents a small part of the wing. First, the direction of the grid advancement needs to be determined. The direction is decided by “right hand rule”; therefore, the grid point is ordered in the consistent manner. Special care must be given to a split flap. Since the split flap is infinitesimally small, it advances in the upward and downward direction and two similar grid blocks are created with a reversed order of the grid points. The initial grids are checked for one-to-one connectivity property, and if necessary, a modification will be made to the grid blocks. The necessary input files are also written for this particular grid surface.

The next step is to calculate the degree of guidedness of each grid block. Fronts are formed for the grid blocks that are connected smoothly with neighboring blocks. Also the priority of advancement is given to each front. Two gaps on the wing surface are identified. Since those gaps have the highest priority, they advance first. Figure 4-2 shows the generated grids to fill the gap on left wing. Then the gap in the left wing is also filled and it is shown in figure 4-3.

The next grid advancement is given to any guided front. A guided front is found on the wing surface. The split flap and the lower surface of the wing form a gap. The gap consists of two fronts that form a small angle between them so a degree of guidedness value of two is assigned. Figure 4-4 illustrates the grids that fill the gap on right wing. The same procedure is done on the left wing and it is shown in figure 4-5. As the result of the previous advancements, fronts that have surrounded the guided front are formed. The front between the two split flaps on the lower wing surface is chosen for the next advancement. The result of the advancement is presented in figure 4-6. It can be seen that there are still guided fronts on both sides of the wing. The guided fronts on the right and left wing are advanced. The advancement of these fronts is shown in figure 4-7. The final grid as the result of the concave block advancement is presented in figure 4-8. This stage of advancement is completed because there is no guided fronts or gaps that exist on the wing configuration.

The next stage is the offset block advancement. Several new fronts are created in this step. The sequence of advancements is determined by the user input. The first front consists of all blocks that represent the upper and lower surface of the wing. The result of the first advancement is shown in figure 4-9. Then, both wingtips will be advanced. The advancements of these wingtips are shown in figures 4-10 and 4-11. After these advancements are completed, the front at the back of the wing is advanced. The final grid is presented in figure 4-12. The offset block advancement is completed since there are only four fronts created on the configuration.

4.2. Wing with Finite-Thickness Split Flap Configuration

The next example is a wing with finite-thickness split flap deflected 30 degrees and it is shown in figure 4-13. First, the grid is checked so that the desired direction of advancement is established. Then, the degree of guidedness of each block is calculated. The cuts on the wing surface are recognized and they will be filled

immediately. Figure 4-14 shows the complete advancement to fill the cut on the right wing. Then, the cut on the left wing is also filled and it is illustrated in figure 4-15.

The next task is to fill the gap between the upper part of the flap and the lower surface of the newly generated surface. The grids are generated to fill these irregularities and the result is shown in figures 4-16 and 4-17. Then, there are three fronts that will be advanced. The first front is located between both flaps. It is generated using the guide of the side front of both split flaps. The generated grid is shown in figure 4-18. Then there is a front on the left and the right wing that have a guided front on its side. The result of grid advancement on the right wing is shown in figure 4-19. Then the front on the left wing advances and the grid result is illustrated in figure 4-20. This advancement completes the process on concave blocks.

After the concave blocks are completed, the offset block grid generation is started. The fronts are created from the newly generated grid. The first front that will be advanced consists of upper wing surface and lower wing surface. The result of this advancement is shown in figure 4-21. The next step is to advance both wing tip surfaces as specified by the user. Figure 4-22 shows the result of the advancement of left wing tip and the grid results of right wing is shown in figure 4-23. The final step is to advance the trailing edge surface of the newly generated grids. The final result of the advancement of a wing with finite-thickness split flap is presented in figure 4-24.

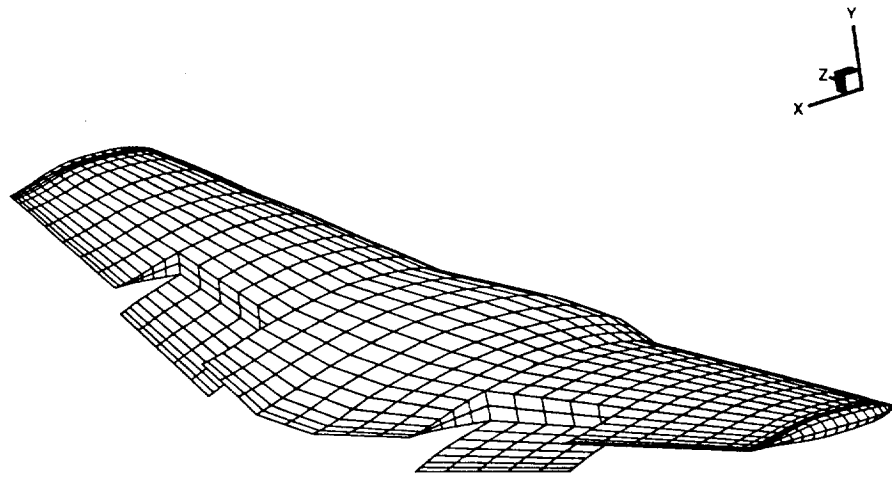

Figure 4-1 Initial grid of a P-51 Mustang wing with a split flap.

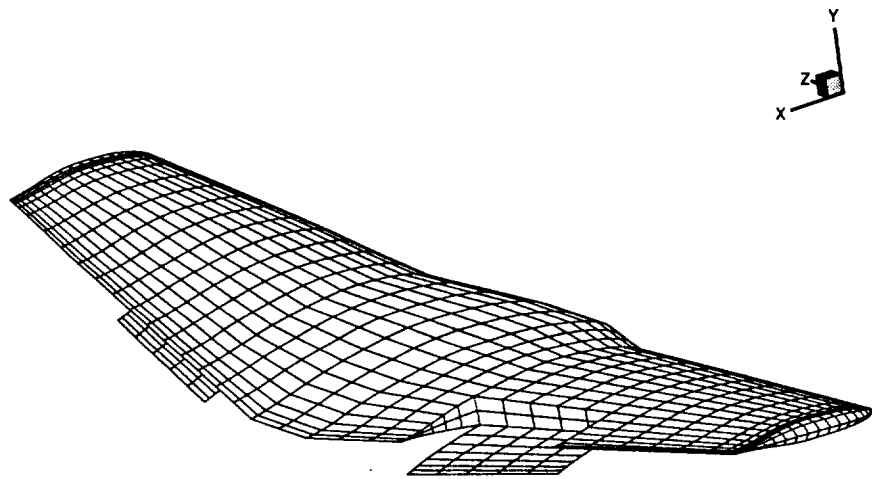

Figure 4-2 Fill the gap on the left part of the wing.

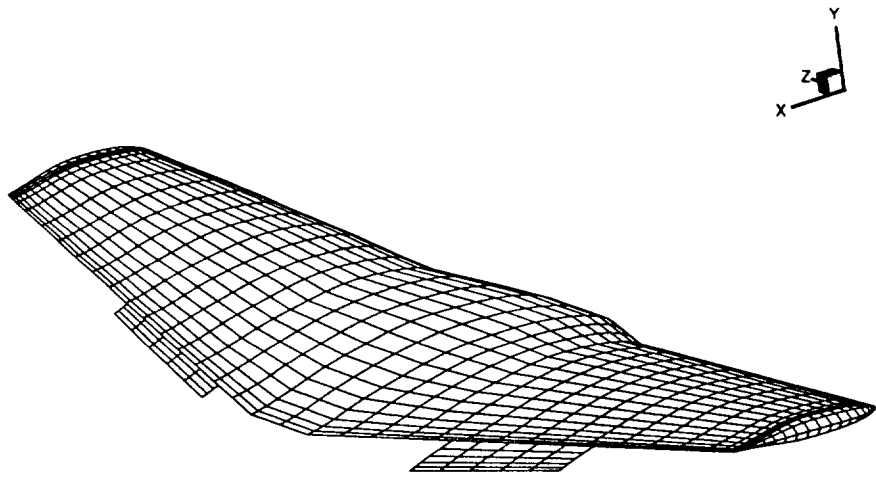

Figure 4-3 Fill the gap on the right part of the wing.

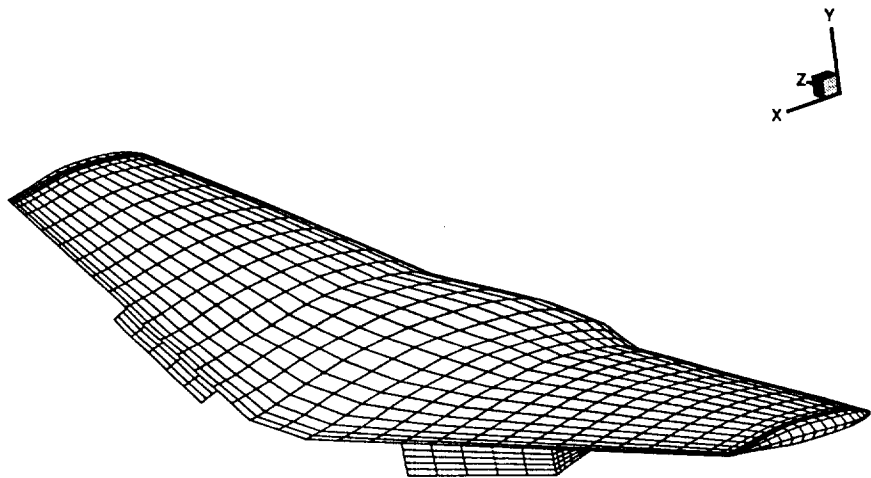

Figure 4-4 Advance the grid to fill the gap between the wing surface and the splitflap on the right part of the wing.

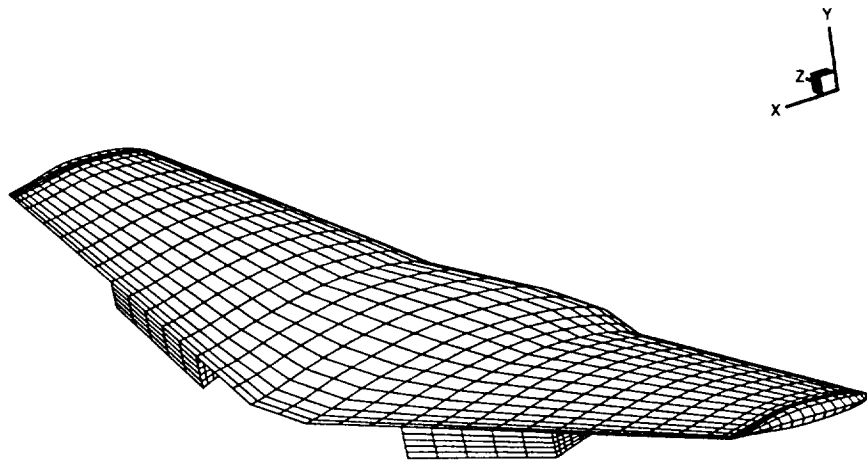

Figure 4-5 Advance the grid to fill the gap between the wing surface and the split flap on the left part of the wing.

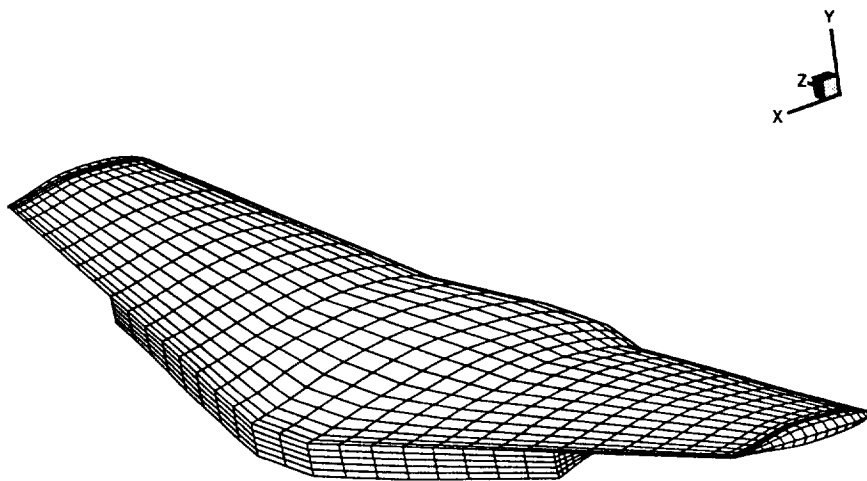

Figure 4-6 Generate the grids of the fronts between two split flaps.

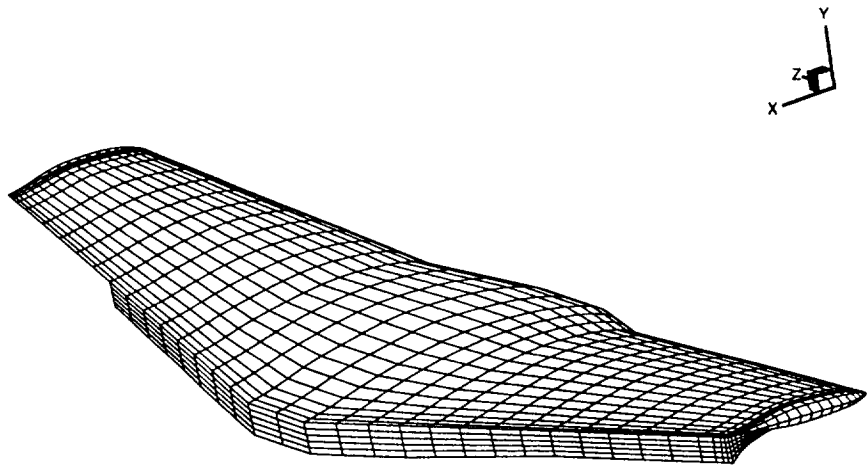

Figure 4-7 Advancing the front that has guided side on the right wing.

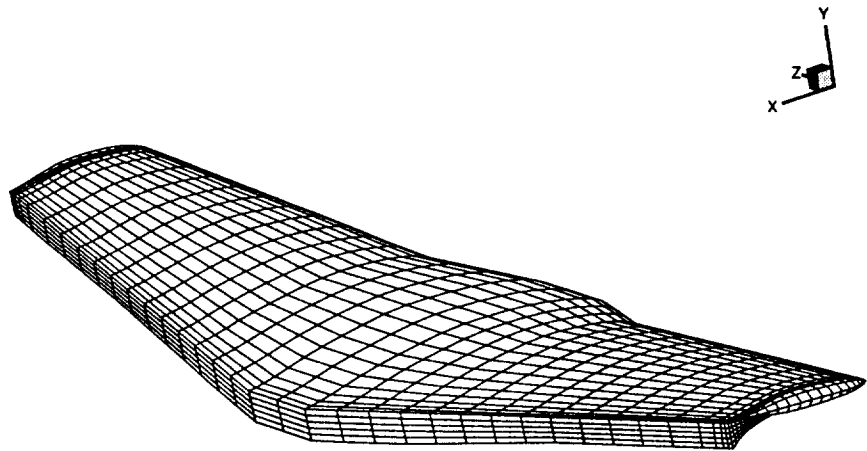

Figure 4-8 Advancing the front that has guided side on the left wing. The grid after completed the concave block advancement.

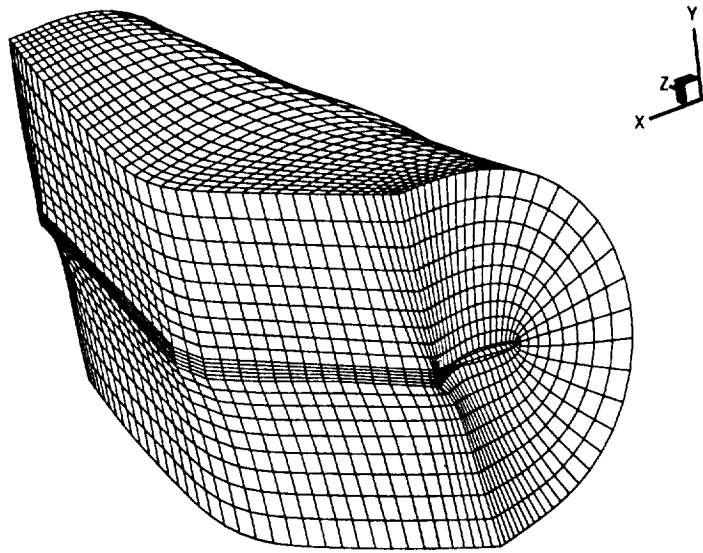

Figure 4-9 Generate the grids of the first front on the offset block advancement.

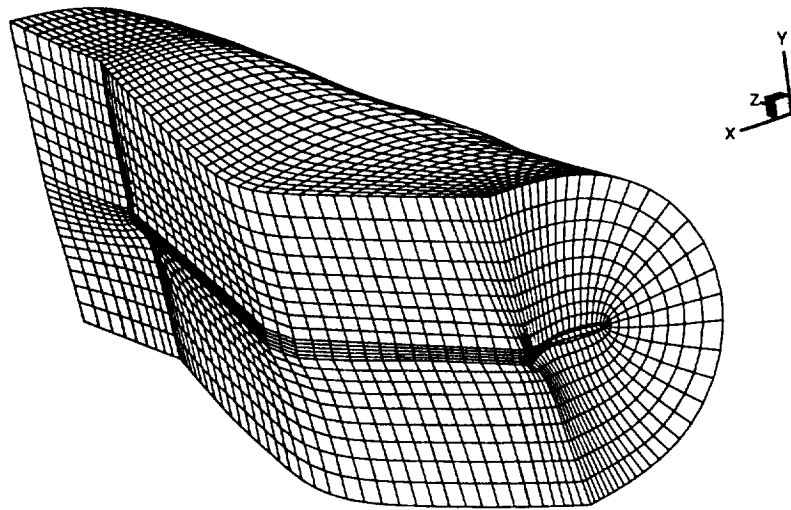

Figure 4-10 Generate the grids of the second front on the offset block advancement.

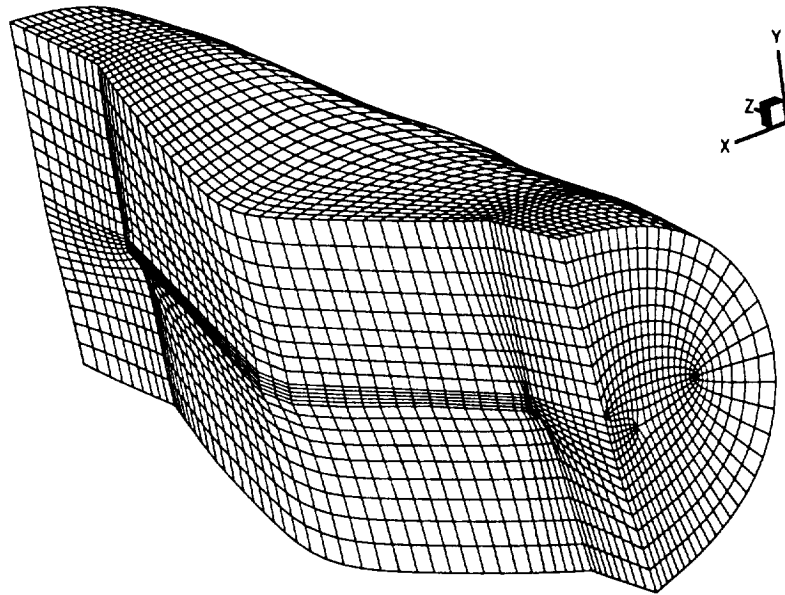

Figure 4-11 Generate the grids of the third front on the offset block advancement.

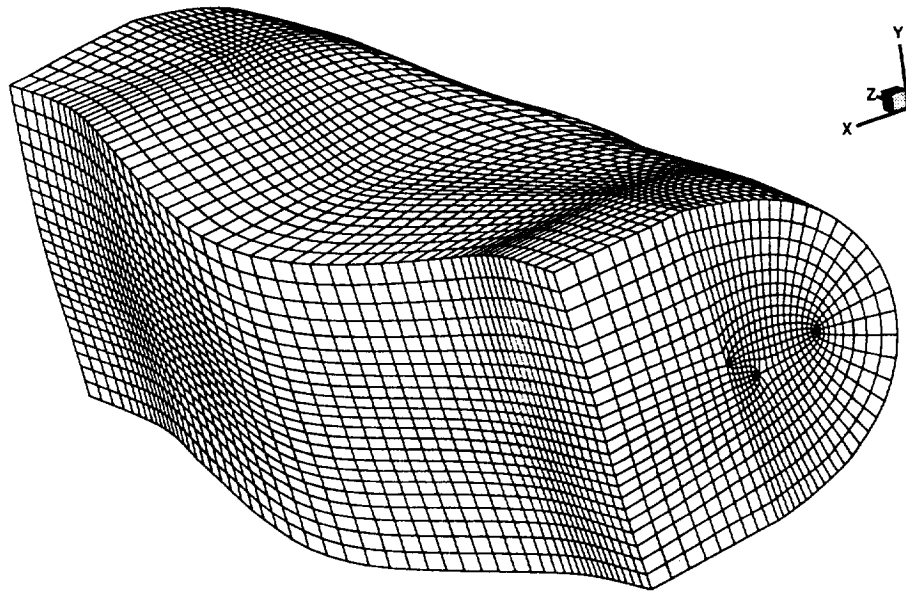

Figure 4-12 Final result of the grid advancement.

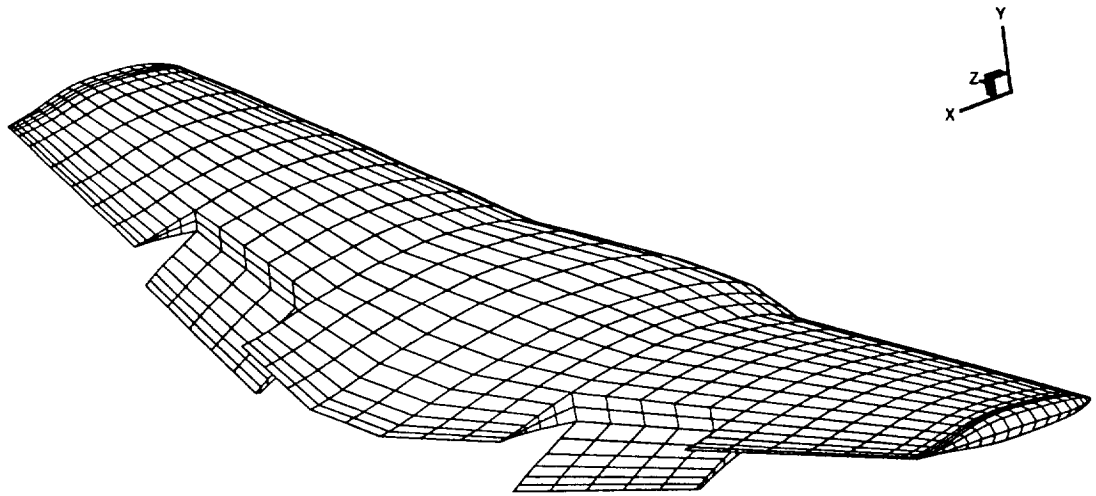

Figure 4-13 Initial grid of a P-51 Mustang wing with finite-thickness split flaps

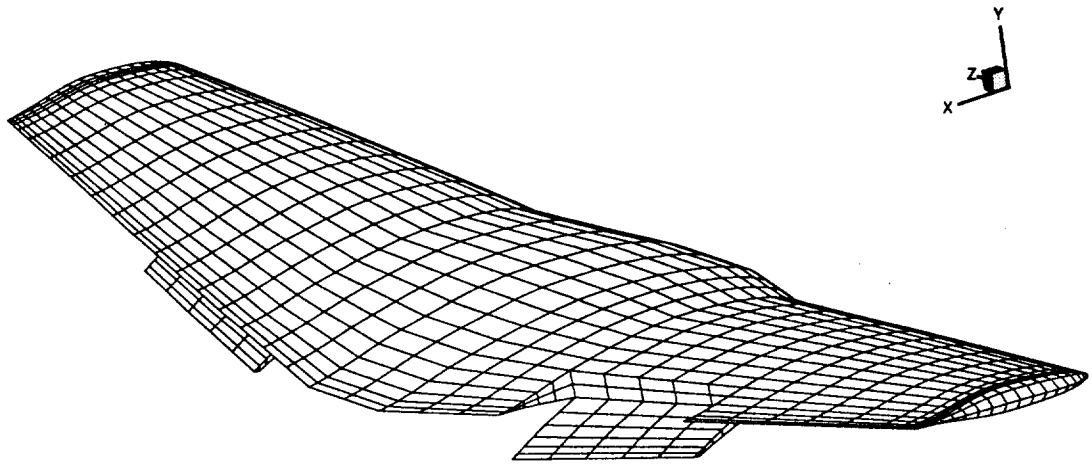

Figure 4-14 Fill the gap on the left part of the wing

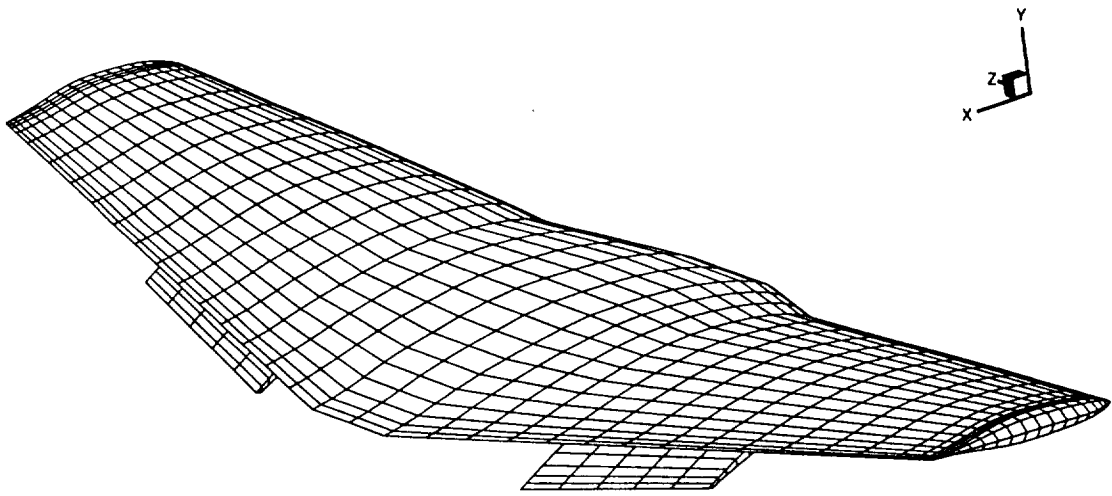

Figure 4-15 Fill the gap on the right part of the wing

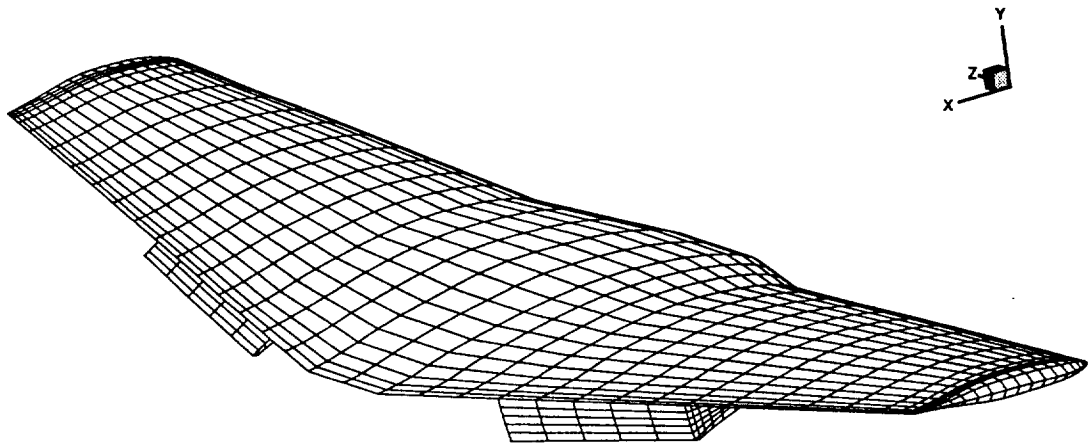

Figure 4-16 Advance the grid to fill the gap between the wing surface and the finite-thickness split flap on the right wing

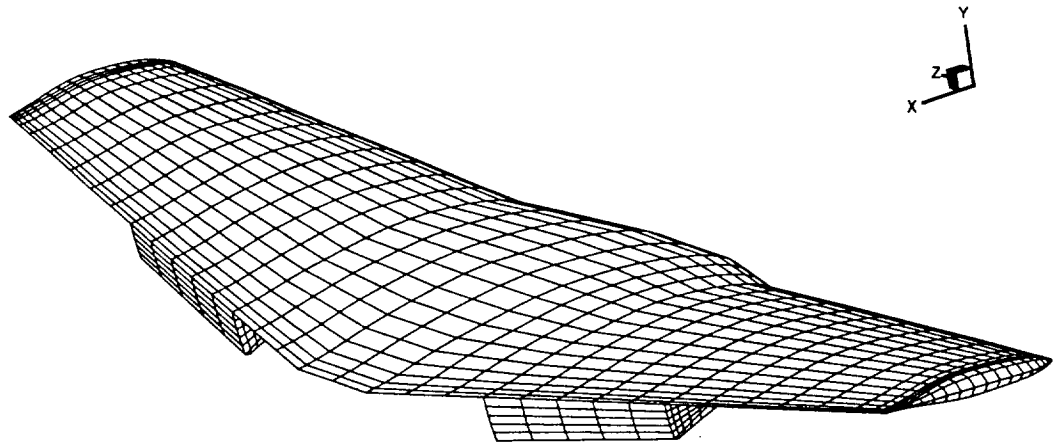

Figure 4-17 Advance the grid to fill the gap between the wing surface and the finite-thickness split flap on the left wing

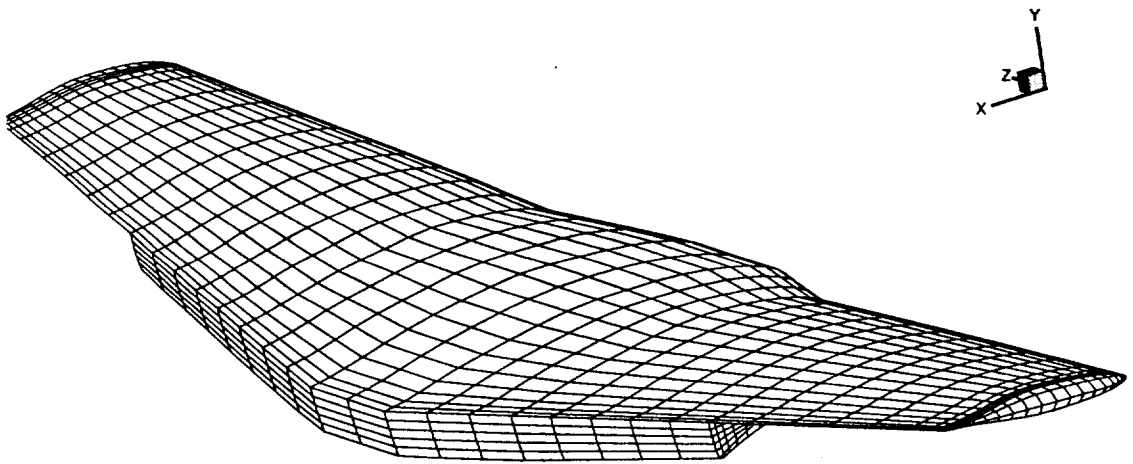

Figure 4-18 Generate the grids of the fronts between two split flaps

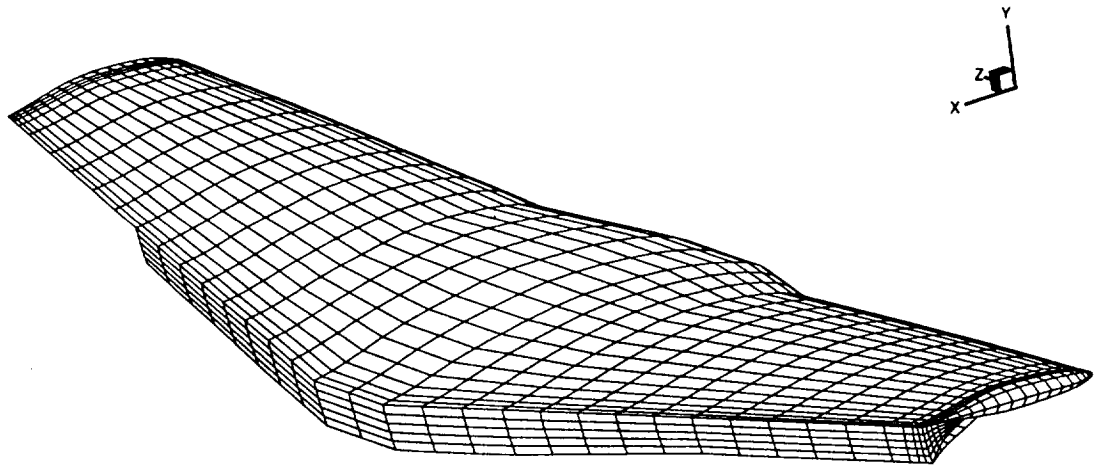

Figure 4-19 Advancing the front that has guided side on the right wing.

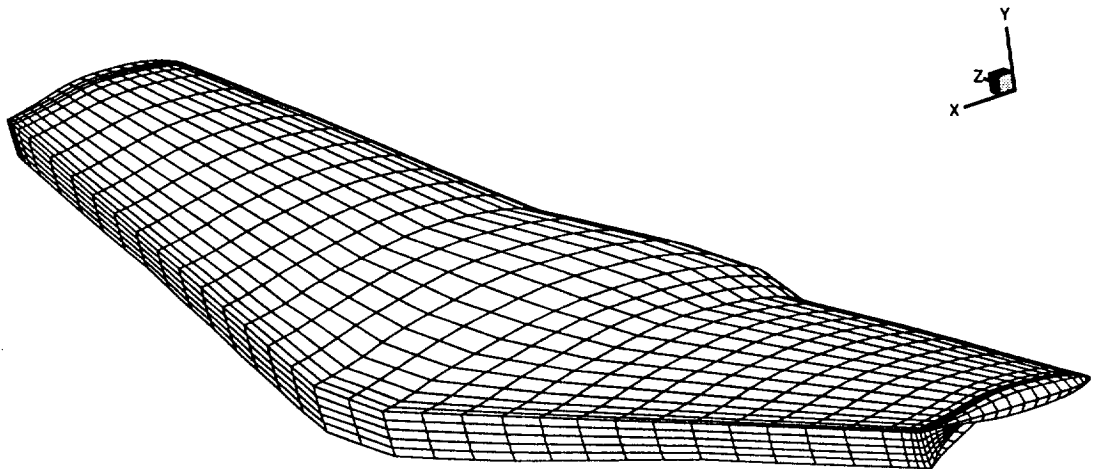

Figure 4-20 Advancing the front that has guided side on the left wing. The grid after completed the concave block advancement.

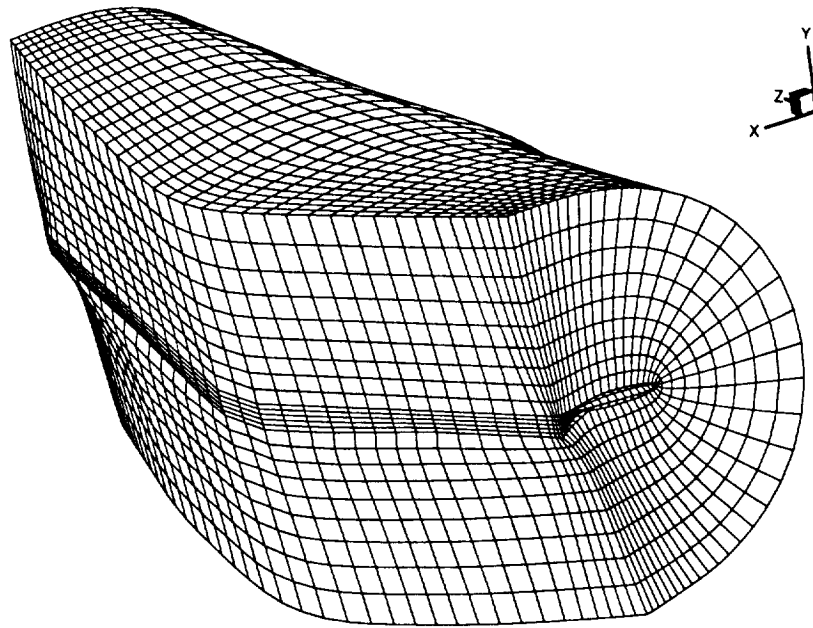

Figure 4-21 Advancement of the first front (lower and upper wing surfaces).

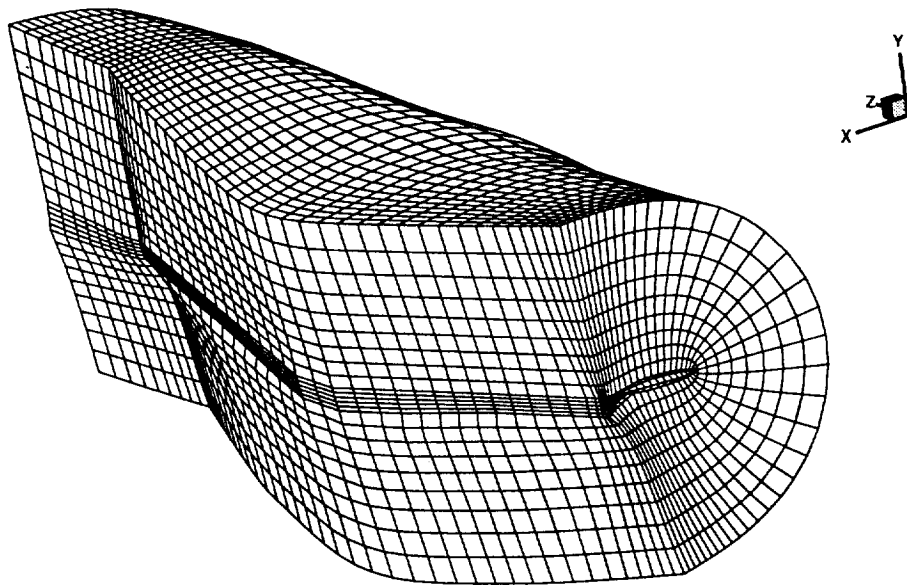

Figure 4-22 Advancement of the second front (left wingtip surface).

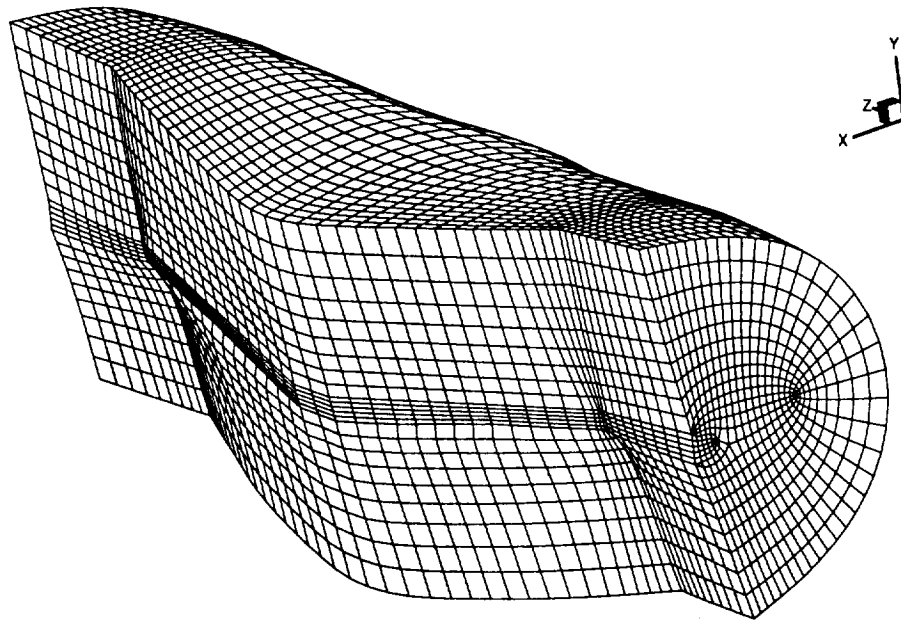

Figure 4-23 Advancement of the third front (right wingtip surface).

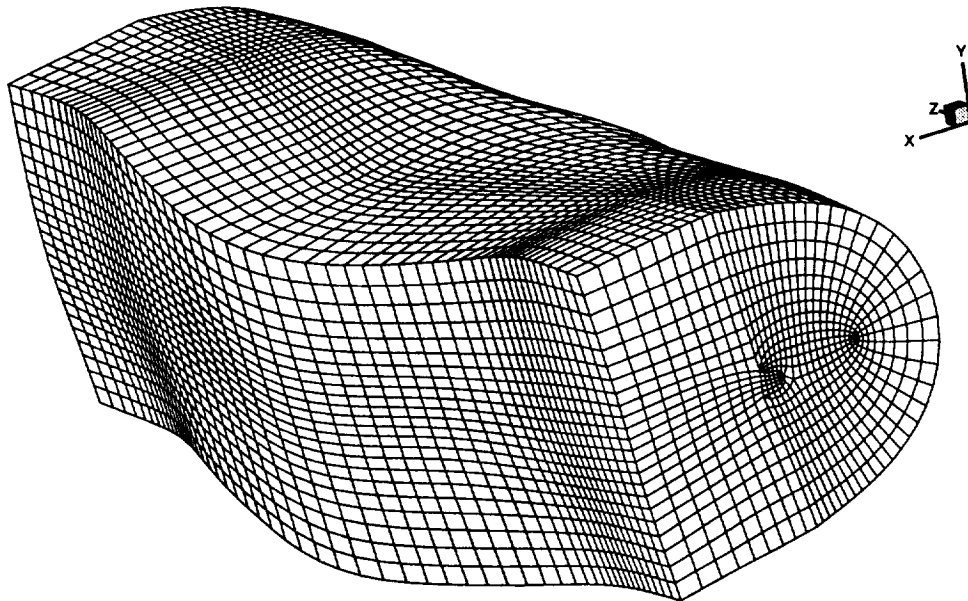

Figure 4-24 Final grid after all advancement stages are completed

Chapter 5

Conclusions

The automatic grid generation for a complex wing-flap configuration is presented. The Modified Advancing Front Method as a predictor and an elliptic scheme as a corrector is utilized. The predictor step is similar to the hyperbolic grid generation in marching the grids outward. The purpose of the elliptic scheme is to smooth the grid produced by the predictor step. Several new techniques of grid advancement are developed to handle the gaps and flaps on wing surfaces. By defining the correct sequence of grid advancements, such irregularities can be solved. Using the geometric information obtained from the initial grid surface, the code has the capability to recognize those irregularities automatically. The geometric information of the body is also used to drive the grid advancement. The user input consists of the initial grid, the advancement distance and the number of advancements. However, the user still has control over the generation process so the final grids can be customized for the needs of the flow field. The grids for two different wing configurations are generated to prove the capabilities of this grid generation method. This automatic process can reduce the load of the user and increase the efficiency of the flow field simulations.

Several suggestions for future research to improve this method are to explore a new technique to handle more complex wing configuration. A realistic wing configuration with all of its complexity becomes the ultimate goal of this automatic grid generation. To add more capabilities to handle the complexity of a real wing, the codes may need to be rewritten so that it runs more efficiently. Also, a graphical user interface (GUI) is necessary to simplify the process to generate the grids.

Bibliography

1. Kim, B., and Eberhardt, D. S. "Automatic Multi-Block Grid Generation for High Lift Configurations Wing," NASA CP-3291, NASA Workshop on Surface Modeling, Grid Generation and Related Issues in CFD Solutions, Cleveland, Ohio, May, 1995
2. Kim, B., Automatic Multi-Block Grid Generation about Complex Geometries, Ph.D. Dissertation, University of Washington, 1994
3. Cordova, J.Q., "Advances in Hyperbolic Grid Generation," 4th International Symposium on Computational Fluid Dynamics, Davis, CA, September 1991
4. Thompson, J.F., "A Reflection on Grid Generation in 90s : Trends, Needs and Influences," Proceedings of the 5th International Conference on Numerical Grid Generation in Computational Field Simulations, Mississippi State University, 1996
5. Peyret, R., Handbook of Computational Fluid Mechanics, San Diego, 1995

Appendix A

Input Parameters

The input parameters are provided by the user. These parameters are divided into three files. The definition of each parameter is described below.

1. mapbg.inp : this file is required for the grid generation process.

1.1. input_control

front_file : filename that contains the initial grid of the body surface.

front_format : format of the grid file.

1.2. advance_control

dzaw : distance of the grid advancement.

dzratio : ratio of distance between the current advancement and the previous one.

nadvoffset : number of offset block advancements.

nadvmax : number of maximum number of advancements including the offset block advancements.

1.3. scheme_control

ialgell : type of scheme to control the interpolation of the advancing vectors.

0 : for algebraic only.

1 : for algebraic/elliptic scheme.

2 : for weighted-averaging of algebraic/elliptic scheme.

iplsor : type of successive over-relaxation (SOR) scheme in the corrector step.

0 : for point SOR.

1 : for line SOR.

itsmooth : number of iteration in smoothing process in the corrector step.

The suggested number is between 50 and 100

uic_file : filename of the user defined degree of guidedness.

The default filename is uicall.inp.

1.4. output_control

ivbout : volume block output on vbout.doc.

1 : print the output file.

0 : do not print the output file.

ivbedge : volume block edge output on vbout.doc.

1 : print the output file.

0 : do not print the output file.

ivbound : volume block boundary output on vbound.doc.

1 : print the output file .

0 : do not print the output file.

idoc : information on the parameters on each advancement.

1 : print the output file .

0 : do not print the output file.

1.5. misc_control

interf : graphical user interface option.

clevel : information on advancement printed on the screen.

sortnode : option to sort the nodes.

2. uicall.inp : optional file that specified the degree of guidedness on any particular side of a front. The format of the file is :

dog nf ns

where : dog : degree of guidedness value. (2, 1, 0, -1, -2, -3)

nf : grid block number.

ns : side number of the nf

3. Offset.inp : optional file that specify the sequence of the front that will be advanced on the offset block advancement.