

Memo

*FINAL
11-10-97
0017
100200*

To: Cynthia J. Barnes Acquisitions Specialist

From: Alfonso Barrientos

CC: Chrissa Hall

Date: 11/13/97

Re: Final and Inventory Report

Dear Ms Barnes,

This memo is in response to your communication dated on October 30, 1997. As I clarified to you in our telephone conversation the grant NASA/OMU NAG8-1085 was extended and finally it expired on July 17, 1997. At that time, I submitted a final report to my college Dr. Marcus Vlasse at the MSFC and he send a copy to Chrissa Hall.

I am submitting to your office a copy of this final report of the project titled "Single Crystal Synthesis and STM Studies of High Temperature Superconductors".

I am sorry by the inconvenience. If you need any additional information please let me know.

FINAL REPORT

INTRODUCTION

This is a final report for the work initiated in September of 1994 under the grant NAG8-1085 - NASA/OMU, on the fabrication of bulk and single crystal synthesis, specific heat measuring and STM studies of high temperature superconductors.

Efforts were made to fabricate bulk and single crystals of mercury based superconducting material. A systematic thermal analysis on the precursors for the corresponding oxides and carbonates were carried out to synthesized bulk samples. Bulk material was used as seed in an attempt to grow single crystals by a two-step self flux process.

On the other hand bulk samples were characterized by x-ray diffraction, electrical resistivity and magnetic susceptibility, We studied the specific heat behavior in the range from 80 to 300 K. Some preliminary attempts were made to study the atomic morphology of our samples.

As part of our efforts we built an ac susceptibility apparatus for measuring the transition temperature of our sintered samples

EXPERIMENT AND RESULTS

Bulk

Thermogravimetric (TGA) and differential thermal analyses (DTA) techniques were used to monitor the thermal behavior of the raw oxides and carbonates to determine the optimal conditions for sample preparation. We used the matrix Ba-Ca-Cu-O that is common for many superconducting compounds. We weighed high purity BaCO_3 , CaCO_3 , and CuO powders, weighed in the stoichiometric ratio 2:2:3. The weighed powders were dispersed in isopropyl alcohol, ball milled dried and grounded. Powder of this mixture was used to obtain TGA and DTA data. Figs 1, 2 and 3 show a DTA and TGA data and overlapping of them for the precursor. Two endothermic peaks at 725°C and 825°C evidence the decomposition of CaCO_3 in CaO-CO_2 and BaCO_3 in Ba-CO_3 respectively. This information is in agreement with the weight lost showed in the TGA plot. Two additional exothermic peaks at 925°C have been reported elsewhere as the formation of Ba-Ca-Cu-O.

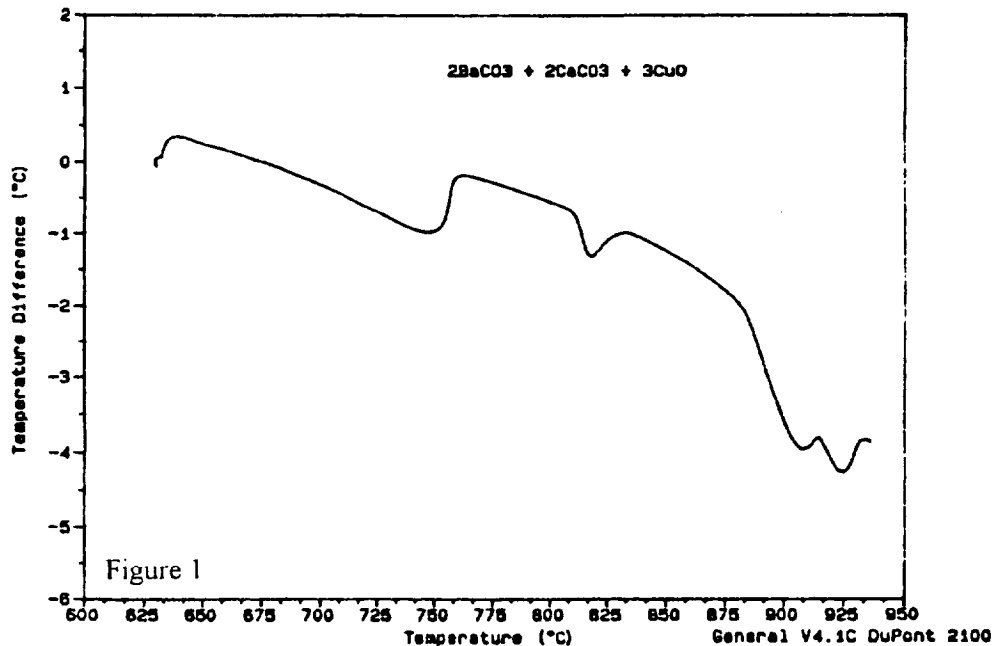

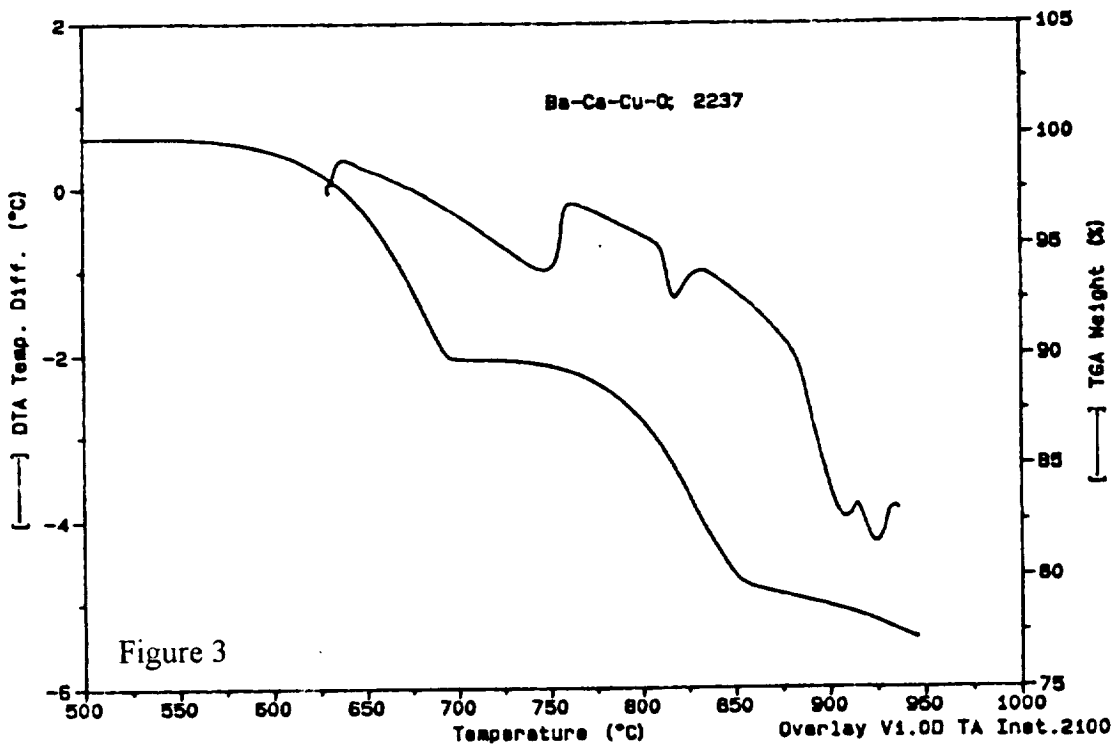
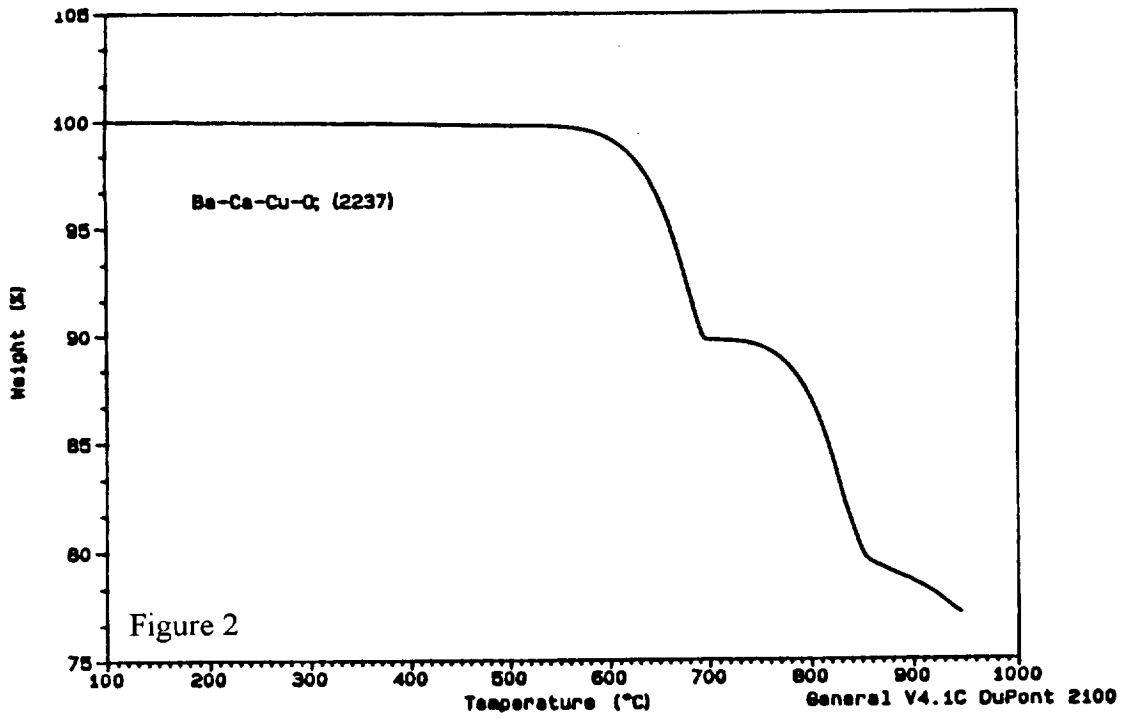

From the previous data we calcined the powder mixture for 48 hours at 930°C. The resulting material was ground to a fine grain and X-ray diffraction data revealed that the majority of the peaks corresponded to Ba-Ca-Cu-O phase, with some impurities that were not identified. The X-ray diffraction data are shown in fig 4.

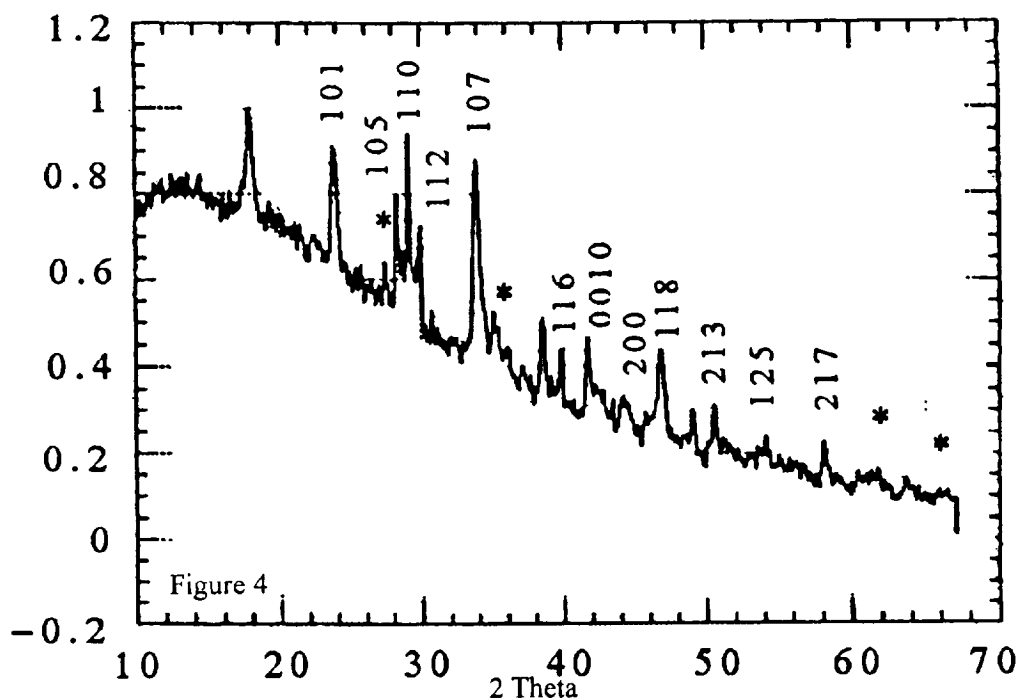

The above precursor was mixed with HgO and PbO dispersed with isopropyl alcohol, ball milled, dried and ground again. A new set of DTA and TGA measurements was obtained from this new raw mixture. Figs 5, and 6 are showing the behavior for the Hg based compound. DTA data shows a very broad exothermic peak indicating that mercury oxide starts to decompose very early (around 150°C) in the heating process. The other peak, localized at 470°C is associated with the boiling point of Hg. The above behavior of this Hg mixture is supported by the TGA. Fig 7 shows the

overlapping of these two plots. It is important to note that at 470°C there are only 60 % of the original weight. This is indication that much of the mercury diffuses out of the sample. The high volatility of mercury is well known.

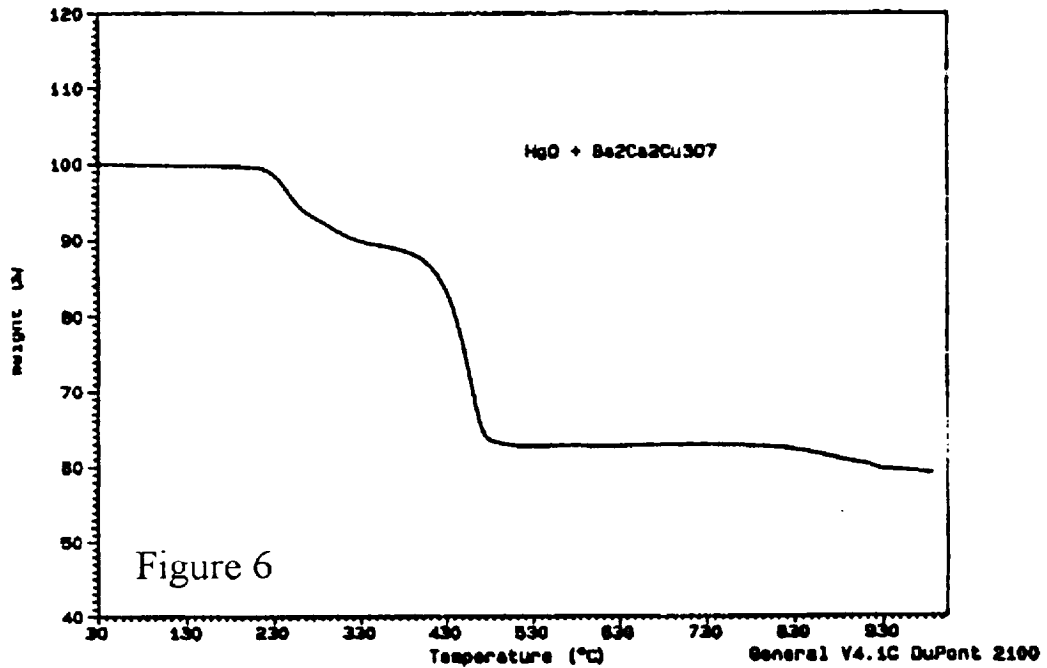
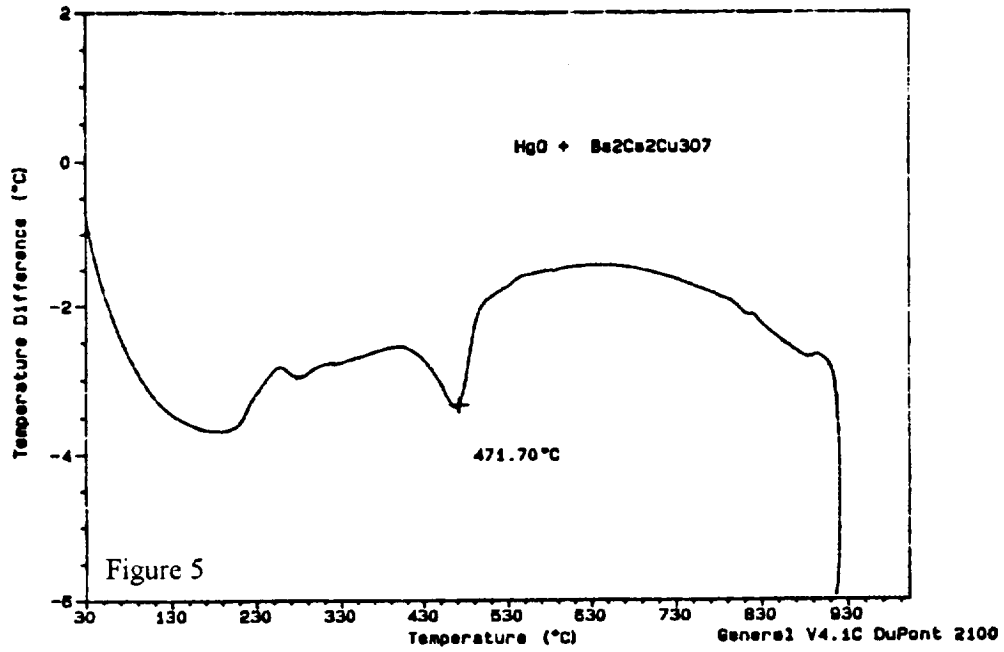

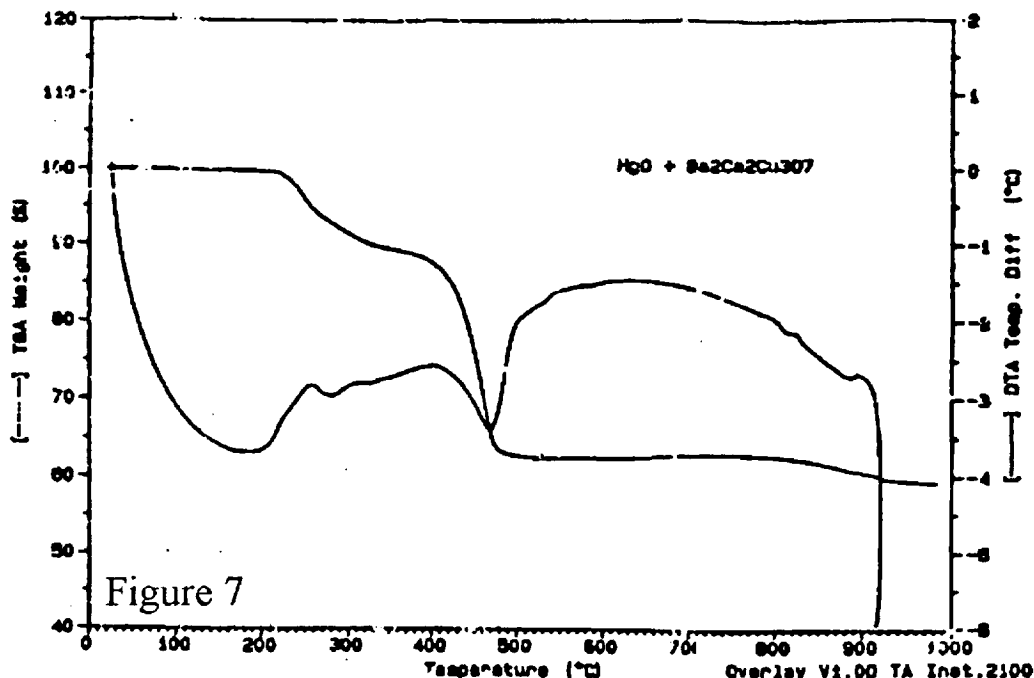

Many attempts to avoid the loss of mercury were carried out. Finally sealed alumina crucibles were used. They were sealed with ceramic adhesive from “Cotronics Corp” and then coated with a glass ceramic base paint to seal the porosity of the alumina crucibles.

Stoichiometric amounts of $\text{Ba}_2\text{Ca}_2\text{Cu}_3\text{O}$, HgO , and PbO were mixed and ground in a glove box under helium atmosphere and pressed into pellets. This care was taken to minimize the exposure of the mixture to air, in order to avoid absorption of moisture and CO_2 . The pellets were placed in the crucible, and then sealed as described above. A slow heated process to 800°C was carried out. The pellets were held at this temperature for 8 hours and then furnace cooled to room temperature. The crucibles were broken and the material was weighed. Very small weight difference between the raw and the sintered material was found. The resulting material was analyzed.

Samples were characterized by X-ray diffraction, ac susceptibility, and specific heat measurements. The specific heat data shows a peak at 131. This anomaly corresponds to the critical temperature. The real and imaginary part of the AC susceptibility data splits at the transition in good agreement with specific heat data. The X-ray diffraction data are shown in fig 8. Fig 9 and fig 10 show the curves for the AC susceptibility measurements and specific heat data.

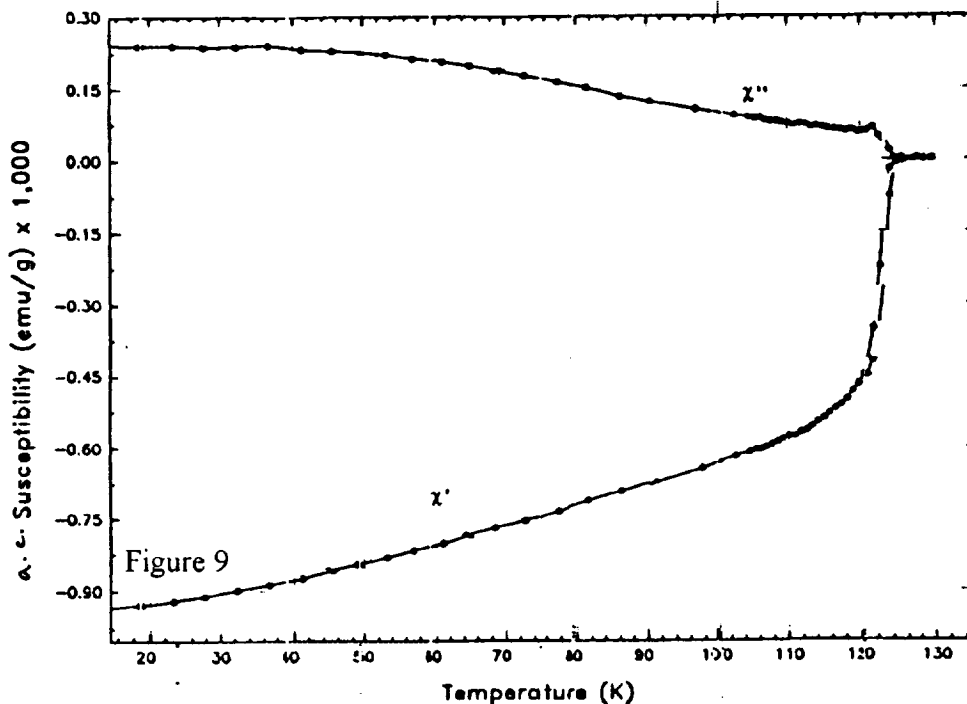
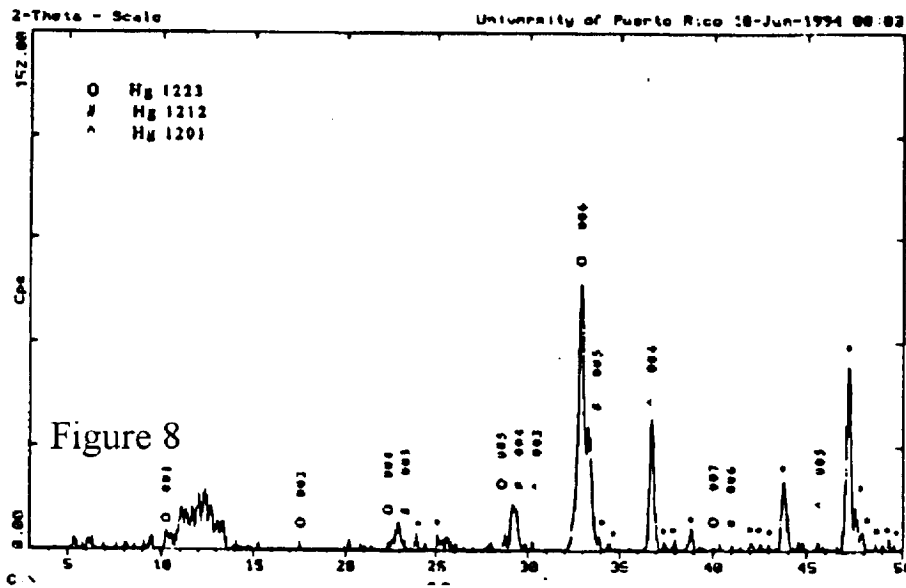

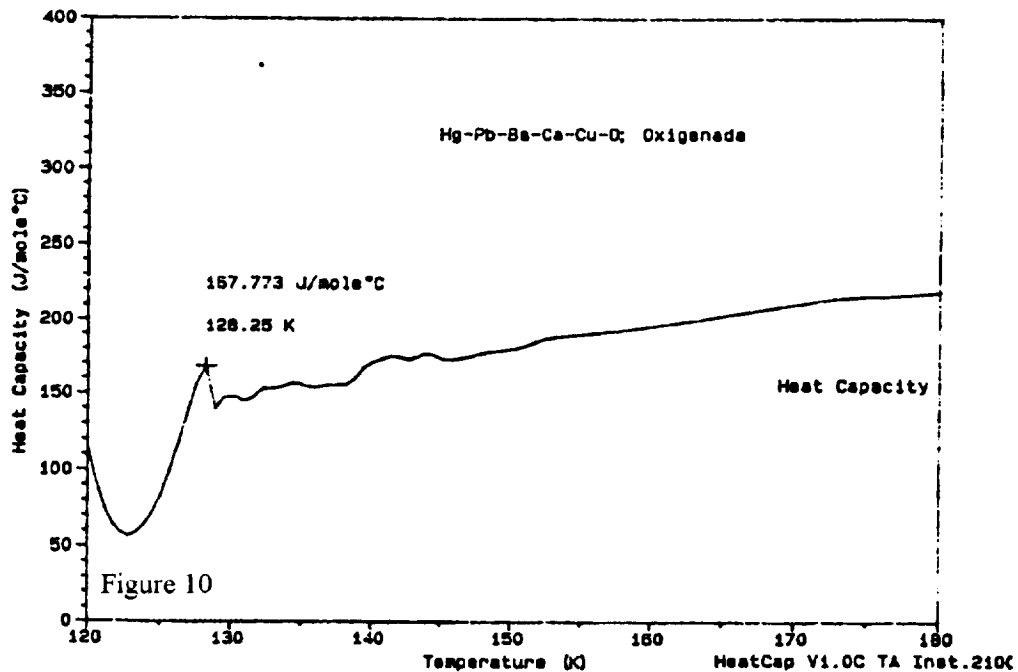

We used the specific heat data in order to determine the electronic contribution to the specific heat $C_e = \gamma T$. Here γ is the Sommerfield constant. This parameter is quite important because it gives information about the electronic density of states. Its numerical value is related to the volume fraction of the amount of superconducting material present in the sample and it may shed light on the strength of the interaction whichever they are.

It is quite difficult to separate from the lattice specific heat contribution. The electronic contribution represent a very small value to the total specific heat and this is more critical in the vicinity of the transition temperature where the cooperative effect will take place.

Adopting a very simple model the electronic contribution must be the difference between the superconducting specific heat and the specific heat in the normal state. So this difference must be equal to γT .

$$\Delta C = C_s - C_n = \gamma T$$

Specific heat experimental measurement were fitted to a quadratic polynomial $a + bT + cT^2$. The fitting was made above critical temperature and then extrapolated back below the transition temperature. From this result then ΔC was determined. It is important that the fitting function is essentially irrelevant. This procedure is indicated in fig 11. The γ value was found to be 180 mJ/mol K². The value we obtained is relatively big in comparison with other reported values, which may indicates that we have a high volume ratio of superconducting contribution. This result is supported by the very clear peak in the specific heat data.

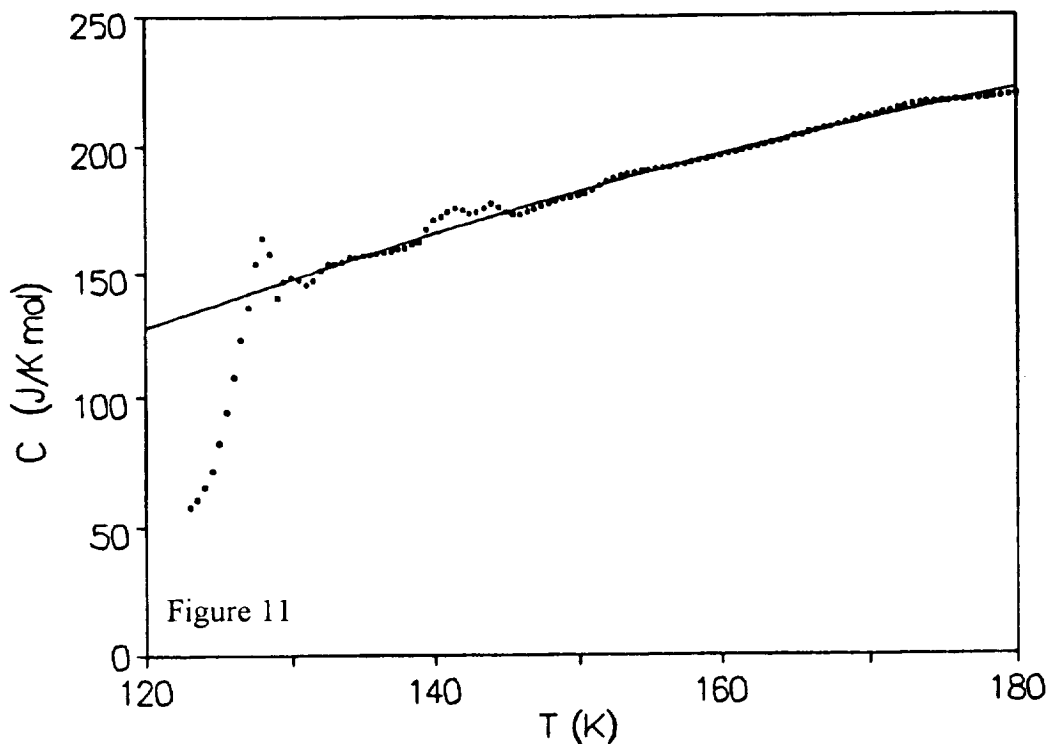

Crystals

A two-zone furnace was specially prepared and calibrated to obtain a very sharp controllable gradient. The steepest gradient that we obtained was 40°C/cm. Many configurations were used. The best results, based on X-ray diffraction, were obtained with 820 °C at the bottom of the crucible and 870 °C at the middle point of the crucible, located 13 mm above the bottom. The sample was heated at 1°C/min, kept at the above gradient for 5 hour and then slowly cooled at 5°C/hour. As before, the crucibles were broken, and weighed. No reaction between the mercury sample and alumina crucibles was found. However the material seems not to have melted. Just the surface of the material at the top of the crucible appears slightly shine, due to partial melting. The rest of the body of the sample had the same appearance of the original pellets. The sample was annealed at 300°C under flowing oxygen for 5 hours.

Temperature dependence of the electrical resistivity data was obtained as well as X-ray diffraction. The resistivity measurement plot was obtained using a closed cycle refrigerator system. Fig 12 shows the results. It shows a sharp transition beginning at about 136 K and reaching the zero threshold value at 133 K.

XRD diffraction analysis, fig 13, was carried out using a Siemens diffractometer. The set of data was smoothed and the $K\alpha_2$ lines were subtracted. The results show that the sample contains mainly Hg-1223, however there are some impurity peaks corresponding to $BaCuO_2$.

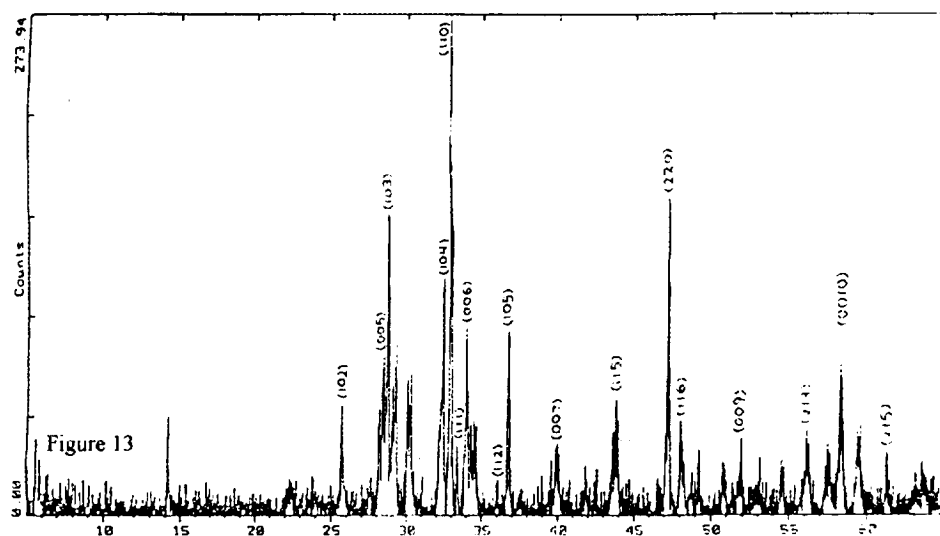
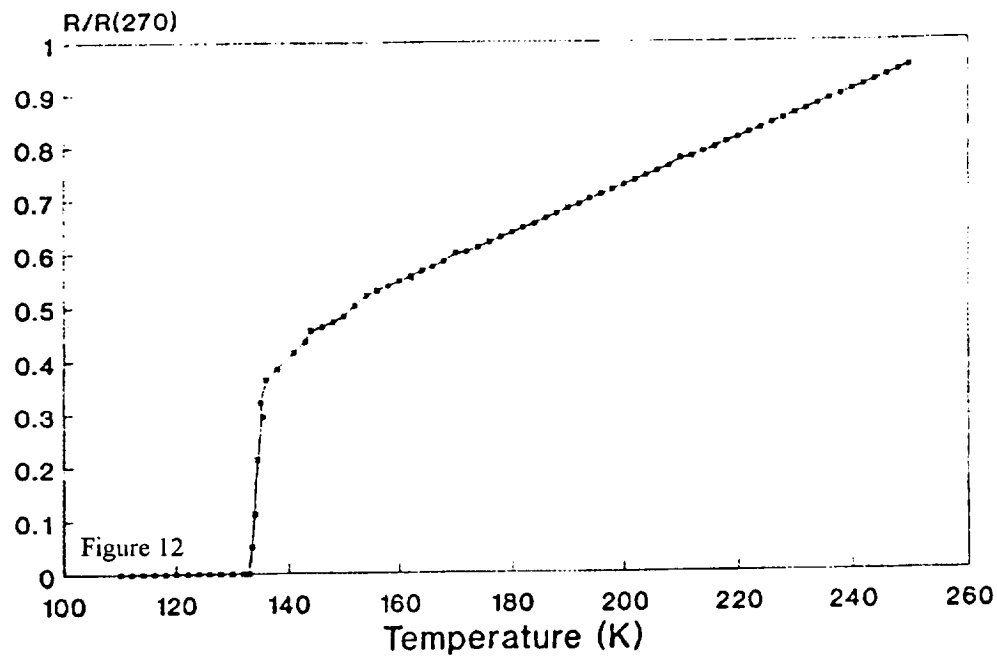

Very tiny crystals were obtained after breaking the crucible. We tried to study the morphology of these small crystals by scanning tunneling microscopy, however they did not have a handling size. We did not succeed in our attempt.

Magnetometer.

Electrical resistivity dependence on temperature for superconducting materials is straightforward technique. The four-probe procedure is the easiest in comparison with specific heat and magnetic susceptibility measurements. However it is a very cumbersome and the least reliable technique. Handling very small samples present an additional problem.

Our system is based on an apparatus previously described by Dalrymple and Prober, and combines many of the advantages that are intrinsic in magnetic susceptibility measurements. These measurements require a complete superconducting loop instead of a single superconducting path required by the resistivity measurement and therefore are more sensitive to inhomogeneities of a sample. Furthermore, magnetic measurements avoid the burden of attaching leads to the sample, which is difficult in the case of the small single crystals. Additionally, our apparatus leaves the sample virtually unaffected, and thus is a fast, reliable and convenient method for characterization of our superconducting samples.

Fig 14 shows the schematic diagram of our detector. The resonant circuit is formed by the inductor L and the capacitor C , and is driven by a RF generator (General Radio Company-1003 Standard Signal) which has a very stable output in both, frequency and voltage.

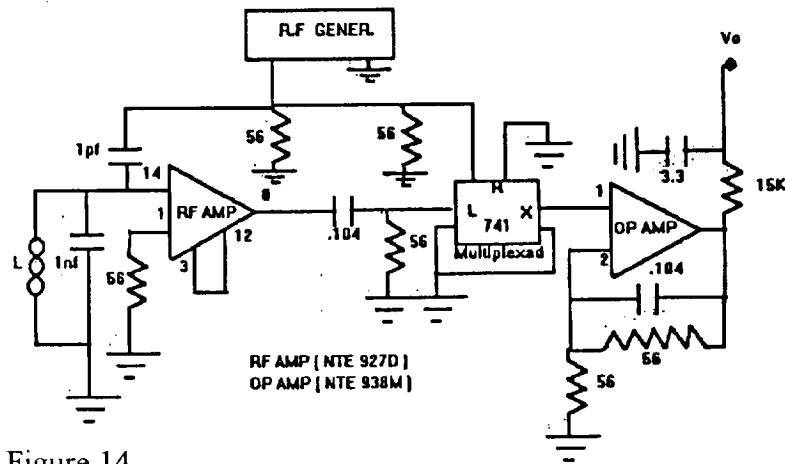
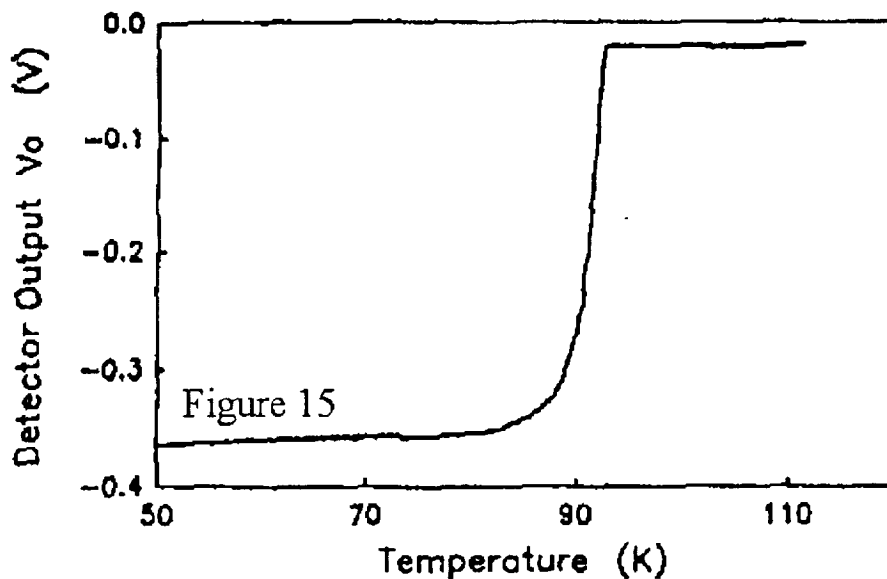

Figure 14

The apparatus is based on a very simple LC parallel circuit. The sample is placed in the coil and we measure the shift in the resonance frequency as the magnetic properties of the sample changes as function of temperature (changes in the core magnetic permeability of the coil). Essentially the apparatus consist of a transfer function that produces a DC output voltage that is proportional to the frequency of the LC parallel circuit. Fig 15 is a typical output that was obtained with a YbaCuO sample.



CONCLUSION.

Bulk superconducting samples of Hg-1223, has been successfully prepared. We produced as a first step Ba-Ca-Cu-O as a precursor. Adding Hg and Pb to the precursor and encapsulating to mixture in a vacuum-sealed ceramic crucible we minimized the lost of mercury. Alumina crucibles have the advantage that does not react with Hg based material.

Several attempts to fabricated single crystals were made. A two-zone furnace with a gradient of $40^{\circ}\text{C}/\text{cm}$ was used to accomplish this. However the size of the crystals we obtained were not big enough to be handled to obtain the nanomorphology of them.

ADDITIONAL COMMENTS.

Two graduate students, Victor Orbegoso and Will Gomez, were involved in this research project and they finished their master program in December 1994.

A new graduate student Alberto Quijano was involved also in this project. He was working in the fabrication of a magnetic susceptometer based in an RCL circuit system. The work was completed successfully. The susceptometer now is going to be calibrated.

Two undergraduate students, Luis Fernando Toledo and Orlando Perez just finished their undergraduate research under my supervision. They were working setting up and calibrating the furnace. They produce several data set for different gradient values and they prepare several superconducting samples.