

NASA/TM-1998-206552



Using Engine Thrust for Emergency Flight Control: MD-11 and B-747 Results

*Frank W. Burcham, Jr., Trindel A. Maine,
and John J. Burken
Dryden Flight Research Center
Edwards, California*

*John Bull
CAELUM Research Corporation
NASA Ames Research Center
Moffett Field, California*

National Aeronautics and
Space Administration

Dryden Flight Research Center
Edwards, California 93523-0273

May 1998

NOTICE

Use of trade names or names of manufacturers in this document does not constitute an official endorsement of such products or manufacturers, either expressed or implied, by the National Aeronautics and Space Administration.

Available from the following:

NASA Center for AeroSpace Information (CASI)
7121 Standard Drive
Hanover, MD 21076-1320
(301) 621-0390

National Technical Information Service (NTIS)
5285 Port Royal Road
Springfield, VA 22161-2171
(703) 487-4650

ABSTRACT

With modern digital control systems, using engine thrust for emergency flight control to supplement or replace failed aircraft normal flight controls has become a practical consideration. The NASA Dryden Flight Research Center has developed a propulsion-controlled aircraft (PCA) system in which computer-controlled engine thrust provides emergency flight control. An F-15 and an MD-11 airplane have been landed without using any flight control surfaces. Preliminary studies have also been conducted that show that engines on only one wing can provide some flight control capability if the lateral center of gravity can be shifted toward the side of the airplane that has the operating engine(s). Simulator tests of several airplanes with no flight control surfaces operating and all engines out on the left wing have all shown positive control capability within the available range of lateral center-of-gravity offset. Propulsion-controlled aircraft systems that can operate without modifications to engine control systems, thus allowing PCA technology to be installed on less capable airplanes or at low cost, are also desirable. Further studies have examined simplified "PCA Lite" and "PCA Ultralite" concepts in which thrust control is provided by existing systems such as autothrottles or a combination of existing systems and manual pilot control.

NOMENCLATURE

AGL	above ground level (radar altitude)
CG	center of gravity
CGX	longitudinal center of gravity, percent of mean aerodynamic chord
CGY	lateral center of gravity, distance from fuselage centerline, in.
CGZ	vertical center of gravity, distance from fuselage centerline, in.
EPR	engine pressure ratio
FADEC	full-authority digital engine control
FPA	flightpath angle, deg
FDS	Flight Deck Simulator
ILS	instrument landing system

PCA	propulsion-controlled aircraft
TOC	thrust-only control

INTRODUCTION

In the past 25 years, more than 10 aircraft, including B-747, L-1011, DC-10, B-52, and C-5A aircraft, experienced major flight control system failures, and the crews tried to use engine thrust for emergency flight control. In most cases, a crash resulted; the B-747, DC-10, and C-5A crashes claimed more than 1200 lives. A summary of these accidents has previously been published.¹

With the advent of digital engine control systems, considering the use of engine thrust for emergency flight control became feasible. To investigate this possibility, NASA, the United States Department of Defense, industry, and university researchers have been conducting flight, ground simulator, and analytical studies. One objective is to determine the degree of control available with manual manipulation of engine throttles for various classes of airplanes. Simulation tests have included B-720, B-747-400, B-727, MD-11, MD-90, C-402, C-17, SR-71, F-18, and F-15 airplanes. Flight tests have included B-747-100, B-777, MD-11, T-39, Lear 24, F-18, F-15, T-38, and PA-30 airplanes.

The pilots use differential throttle control to generate sideslip that, through the dihedral effect, results in roll. Symmetric throttle inputs are also used to control flightpath. For all tested airplanes, these tests have shown sufficient control capability to maintain gross control; both flightpath and track angle may be controlled to within 2° to 4°. These studies have also shown that making a safe runway landing is exceedingly difficult using only manual thrust-only control (TOC)² because of the difficulty in controlling the phugoid and dutch roll modes, slow engine response, and weak control moments.

To provide safe landing capability, NASA Dryden Flight Research Center (Edwards, California) engineers and pilots have conceived and developed a system, called propulsion-controlled aircraft (PCA), that uses only augmented engine thrust for flight control. The PCA system uses pilot flightpath inputs and airplane sensor feedback parameters to provide appropriate engine thrust commands for emergency flight control. The concept was first evaluated on a piloted B-720 simulation.³

This augmented system was evaluated in simulation and flight tests on the F-15 airplane,^{1, 4} and actual landings were made using PCA control. The PCA technology was also successfully evaluated using a simulation of a conceptual megatransport.⁵ Another major PCA simulation study has been conducted at NASA Ames Research Center (Moffett Field, California) using the advanced concepts flight simulator,⁶ an airplane that closely resembles a B-757 twin-jet airplane. More recently, a PCA system was designed and tested on the B-747-400 simulator at NASA Ames. Approaches and landings using the PCA system have been flown by more than 30 government, industry, and commercial airline pilots.⁷

With the success of the F-15 PCA flight program and the other simulation studies, The Boeing Company (formerly McDonnell Douglas Aerospace, Long Beach, California), Pratt & Whitney (West Palm Beach, Florida), Honeywell (Phoenix, Arizona), and NASA Dryden also developed and flight-tested a concept demonstration PCA system for the MD-11 transport airplane. This PCA system used only software changes to existing MD-11 digital systems. In more than 30 hr of flight testing, the PCA system exceeded the objectives, serving as a very acceptable autopilot and performing landings without using any flight control surfaces.

Later tests studied PCA operation over the full flight envelope, in upset conditions, with all hydraulic systems turned off, and coupled to an instrument landing system (ILS) for hands-off landings.⁸ Sixteen pilots flew PCA demonstration flights.⁹ Analysis of the lateral control system design and performance,¹⁰ the longitudinal control details,¹¹ and overall program results¹² have previously been published. Additional PCA studies have been conducted on a simulation of the C-17 military transport airplane, and successful landings were made using all flap configurations. Preliminary studies have been conducted on the F-18 fighter airplane.

In all of the above tests, each engine was assumed to be capable of being individually controlled over its entire thrust range with a full-authority digital control system. A simple yet effective technique could possibly take advantage of the autothrottle system currently installed on most aircraft. The autothrottle system could drive all throttles collectively to provide pitch control.¹¹ In a simpler system, known as "PCA Lite," pitch control could be provided by the autothrottles and

lateral control could be provided using the limited-authority engine trim system installed on some aircraft. For airplanes without digital engine controls, a still simpler system called "PCA Ultralite" would use the autothrottles to provide pitch control, and the flight crew would provide lateral control by differential throttle manipulation.

Studies on the B-720, MD-11, and B-747-400 simulations show the feasibility of emergency control using engine thrust and other systems, such as lateral fuel transfer, with all engines out on one side of a two-, three-, or four-engine airplane.¹³ In preliminary simulation tests, open-loop manual throttle control and closed-loop PCA control have been tested with the lateral center of gravity, *CGY*, offset.

This paper presents the principles of throttles-only flight control and summarizes the thrust-only control capability of many airplanes. For MD-11 and B-747-400 aircraft, the following PCA system results are given:

- The "full" PCA systems that require full-authority digital engine control (FADEC).
- The simplified "PCA Lite" and "PCA Ultralite" systems that use the autothrottle servo system to provide pitch control.
- The wing engine-out PCA systems that use lateral center-of-gravity offset.

PRINCIPLES OF THRUST-ONLY FLIGHT CONTROL

The principles of thrust-only flight control are given in the following section. Lateral-directional principles are discussed, including maximum TOC roll rate, lateral control with an engine out, and *CGY* offset. Longitudinal principles are also discussed, including flightpath angle (*FPA*) changes, pitching moment, phugoid, inlet position, speed effects, and surface float.

Lateral-Directional Principles

Differential thrust is effective in producing roll for all airplanes tested. Differential thrust generates yaw (sideslip) in the direction of the turn. In addition, rolling moments are developed from the dihedral effect. Swept-wing airplanes have an additional rolling

moment that is a function of twice the sweep angle and the lift. A rolling moment contribution from the vertical tail may also exist. All of these rolling moments are normally in the same direction as the yaw and result in the airplane rolling in the direction of the yaw. Proper modulation of the differential thrust allows the airplane to be rolled to a desired bank angle, which results in a turn and change in aircraft heading.

Figure 1 shows an open-loop throttle-step response for a large, three-engine transport airplane, the MD-11 airplane, at 220 kn with gear down and flaps up. The 10° throttle split results in approximately 20,000 lbf of differential thrust and a roll rate averaging 1.5 deg/sec. The engine pressure ratio (EPR) data lag the throttle by approximately 1 sec, and roll rate lags yaw rate. A lightly damped dutch roll mode is excited by this throttle step.

Differential throttle inputs on fighter aircraft such as the F-15 or F-18 airplanes produced similar results. Although the engines are located very close to the fuselage centerline, the thrust-to-weight ratio is high and a significant roll rate is available. The F-15 airplane has high dutch roll damping, and the sideslip and roll rate are less oscillatory than for the transport airplane; however, the F-18 airplane has dutch roll damping similar to the MD-11 airplane. The maximum roll rate for a full (maximum nonafterburning) differential throttle input at 200 kn is 15–18 deg/sec for F-15 and F-18 aircraft.

Summary of Maximum Thrust-Only Control Roll Rates

Figure 2 shows the maximum roll rate, developed from a full differential thrust input (no afterburning used on military jets), for several airplanes and simulations tested. Conditions included a speed of approximately 200 kn and gear and flaps retracted. The roll-rate parameter is an attempt to provide a simple way of evaluating the roll-rate response to thrust for an airplane. The numerator includes the maximum differential thrust multiplied by the moment arm, and multiplied by the sine of twice the wing sweep angle to account for sweep effects. The denominator includes weight, span, and length, which approximate the effects of the moments of inertia. This roll-rate parameter produces an approximately linear relationship with measured roll-rate data and has maximum roll-rate data points ranging from 3 to 45 deg/sec.

Lateral Control With an Engine Out and a Lateral Center-of-Gravity Offset

If an airplane without aerodynamic flight controls and without operating engine(s) on one wing has the *CGY* offset toward the side with the operating engine(s), the thrust of that engine can be modulated to develop yaw and a rolling moment to counter the moment from the *CGY* offset (fig. 3). With proper thrust modulation, providing a degree of bank angle control is possible. If thrust is reduced from a wings-level condition, the airplane will roll toward the operating engine. Conversely, if thrust is increased to greater than that needed for wings-level flight, the airplane will roll away from the operating engine. The degree of lateral offset dictates the level of thrust required for wings-level flight, which then also determines the average flightpath. Lateral center-of-gravity offset may be obtained by transferring fuel or, on military airplanes, by using an asymmetric external store configuration. A first look at this concept has previously been published.¹³

Longitudinal Principles

Longitudinal, or pitch, control caused by throttle changes is more complex than lateral-directional control because several effects occur (fig. 4). Flightpath angle changes may result from speed stability, the vertical component of thrust, the pitching-moment effects of thrust-line offset, the relative positions of engine inlets and nozzles, and the phugoid oscillatory mode.

Flightpath Angle Change Caused by Speed Stability

Stable airplanes exhibit positive speed stability. During a short period of time (approximately 10 sec), a thrust increase will cause a speed increase, which will cause a lift increase. With the lift being greater than the weight, the airplane will climb. The long-term effect is oscillatory (see the Phugoid section below). Usually, the more forward the longitudinal center of gravity (*CGX*) is, the stronger the speed stability will be.

Flightpath Angle Change Caused by the Vertical Component of Thrust

If the thrust line is inclined to the flightpath (as is commonly the case), an increase in thrust will increase

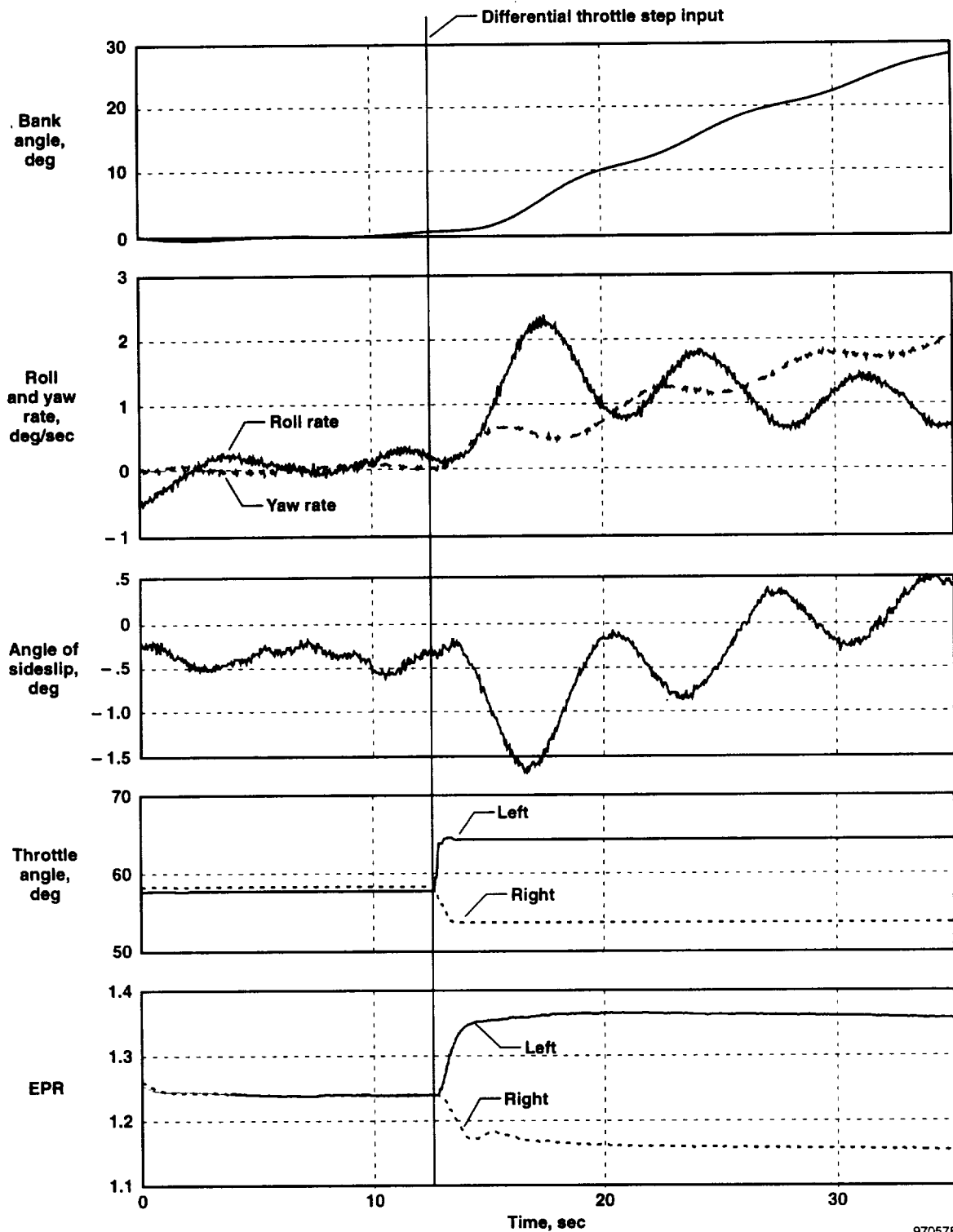

970578

Figure. 1. Differential thrust open-loop step response, MD-11 flight data, 220 kn, an altitude of 15,000 ft, flaps up, gear down, center engine idle, pitch and yaw dampers off.

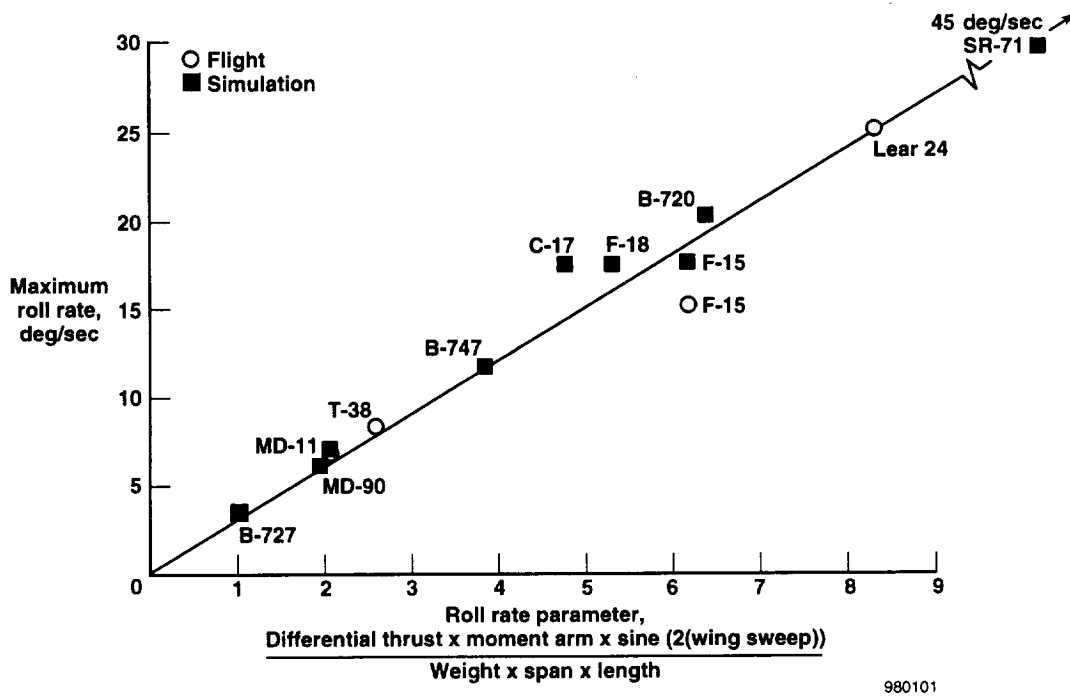

Figure 2. Maximum roll rate as a function of roll-rate parameter, approximately 200 kn, flaps up, full (nonafter-burning) differential thrust.

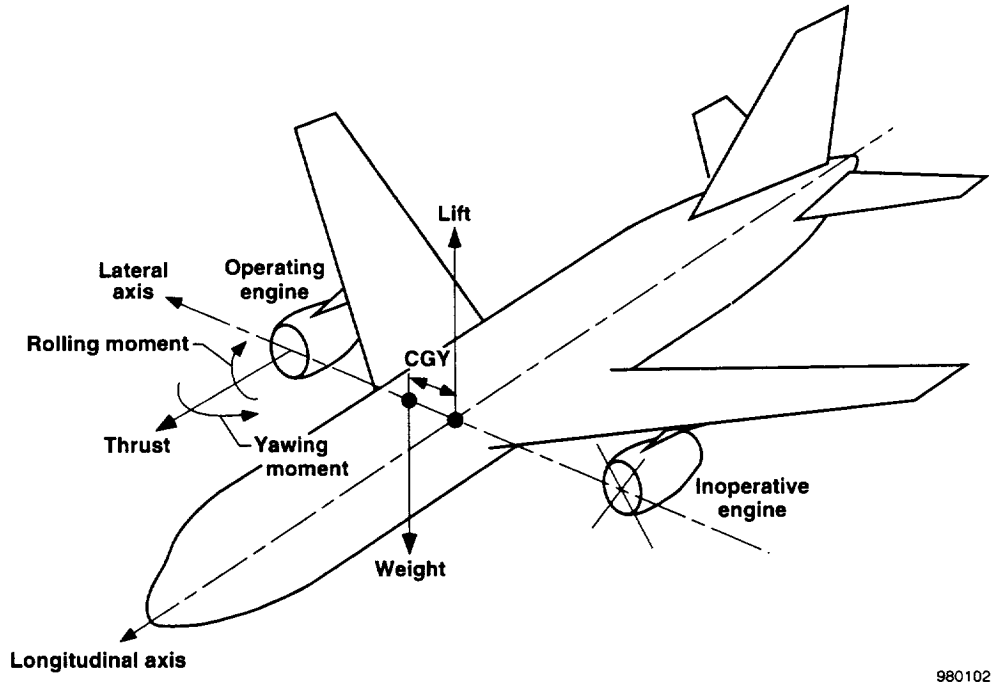

Figure 3. Forces and moments on an airplane with a wing engine inoperative and a CGY offset.

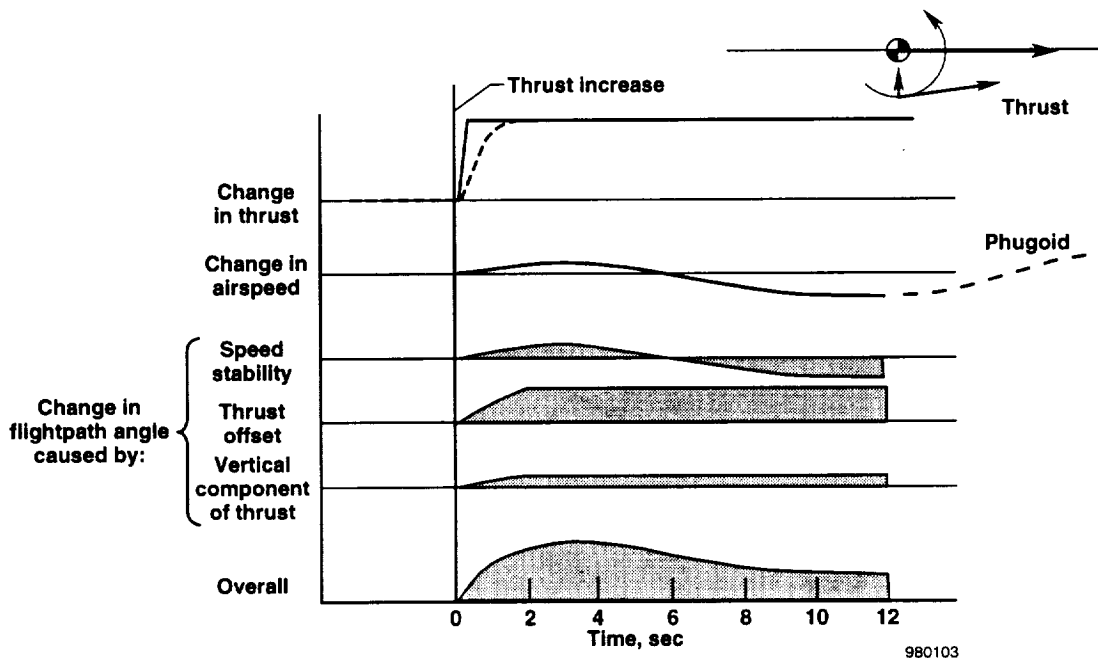

Figure 4. Longitudinal effects of a thrust increase, thrust line below the *CGZ*, flight control surfaces fixed.

the vertical component of thrust, which will cause a vertical acceleration and a resulting increase in *FPA*. For a given aircraft configuration, this effect will increase as angle of attack increases. This effect is usually small.

Pitching Moment Caused by Thrust-Line Offset

If the engine thrust line does not pass through the vertical center of gravity (*CGZ*), a pitching moment will be introduced by thrust change. The sum of these three effects is shown below.

Thrust Line Below the Vertical Center of Gravity.

For many transport aircraft with engines mounted on underwing pylons, the thrust line is below the *CGZ*, and increasing thrust results in a desirable noseup pitching moment and subsequent angle-of-attack increase. Even if speed stability is weak or nonexistent, adequate pitch control may be possible if positive pitching moment caused by thrust exists.

Thrust Line Through the Vertical Center of Gravity—

For some airplanes, including many fighter airplanes, the engine thrust line passes approximately through the *CGZ*. Little angle-of-attack change or pitching-moment effect caused by thrust exists.

Thrust Line Above the Vertical Center of Gravity—

For some airplanes, including many business jets and seaplanes, the engine thrust line is well above the *CGZ*. This trait has the undesirable effect of causing a nosedown pitching moment for a thrust increase that is opposite in direction to that desired. When speed increases sufficiently for speed stability to overcome the pitching-moment effect, the flightpath will increase, but this flightpath increase usually takes 10–20 sec from the time the thrust is increased.

Phugoid

The phugoid mode, the longitudinal long-period oscillation of an airplane, is a constant energy mode in which kinetic and potential energy (airspeed and altitude) are traded and may be excited by a pitch, thrust, or velocity change or other disturbances. For large or dense airplanes, the phugoid is usually lightly damped. Properly sized and timed throttle inputs can be used to damp unwanted phugoid oscillations. These techniques have previously been discussed.²

Relative Position of Inlet to Exhaust Nozzle

The relative positions of the inlet and the exhaust nozzle of each engine may be an important effect for

throttles-only flight control. The ram drag vector acts through the centroid of the inlet area and along the flightpath, thus rotating with respect to the airplane geometric reference system as angles of attack and sideslip change. The gross thrust vector usually acts along the engine nozzle centerline, thus maintaining its relationship to the airplane geometric reference system. This effect has previously been discussed.¹ Normal flight control system operation masks the above effects to such a degree that crews may not be aware of the effects, and simulations may neglect these effects. For fighter airplanes with highly integrated propulsion systems, these effects may be quite significant. For transport airplanes with podded engines, these inlet-nozzle effects are small.

Trim-Speed Control

When the normal flight control surfaces of an airplane are locked at a given position, the trim airspeed of most airplanes is only slightly affected by engine thrust. In general, the speed will need to be reduced to an acceptable landing speed, which requires developing noseup pitching moments. Methods for developing noseup pitching moments include moving the CGX aft, lowering flaps, increasing the thrust of low-mounted engines, decreasing the thrust of high-mounted engines, or burning off or dumping fuel. Extending the landing gear often decreases trim speed because an increase in engine thrust is required. Examples of trim-speed control for the MD-11 airplane have previously been given.¹²

Speed Effects on Propulsive Control Power

The propulsive forces (differential thrust for lateral control and collective thrust for flightpath control) tend to be relatively independent of speed, whereas the aerodynamic restoring forces that resist the propulsive forces are proportional to the dynamic pressure, which is a function of speed squared. This relationship results in the propulsive control power being approximately inversely proportional to the square of the speed.¹

Surface Float With Hydraulics Off

With the hydraulic system failed, a control surface will float to the zero hinge-moment condition. For the

rudders and elevators of many aircraft, this position is essentially the trailing position; ailerons usually float trailing-edge-up. Simulator and flight tests on the MD-11 airplane indicate that a total hydraulic failure would cause the ailerons to float trailing-edge-up; the amount depends on speed. Similar results are shown for the C-17 and B-747-400 aircraft. Rudder float would have a negligible effect on trim speed but would somewhat reduce directional stability, possibly increasing the yaw caused by differential thrust, which could be a favorable effect. Elevators are usually trimmed to near zero force; hence, elevator float would have a small effect. The stabilizer is usually moved with a jackscrew actuator that, in case of hydraulic failure, remains fixed because of friction.

AIRPLANES TESTED FOR THRUST-ONLY CONTROL

Several airplanes have been tested in simulation, in flight, or both to determine the propulsive flight control power available. Some aircraft have also had a PCA system developed and evaluated (table 1). Thrust-only control has been evaluated on these aircraft and can be generalized as follows:

- Starting from an initially trimmed condition, every airplane studied has adequate gross control capability using only engine thrust for continued flight.
- After some practice, heading *or* flightpath could be controlled to within 2° to 4°; and after more practice, heading *and* flightpath could be controlled to within 2° to 4°.
- Using manual TOC, making a safe runway landing is very difficult. The low propulsive control forces and moments, the slow engine response, and the difficulty in damping the phugoid and dutch roll oscillations create an extremely high pilot workload. Figure 5 shows a time history of an attempt to make a manual TOC landing in a B-747-400 simulator that reflects this difficulty. The pilot, a very experienced B-747 test pilot that had no TOC practice, was unable to damp the phugoid or maintain runway lineup and impacted 1 mi short of the runway at a 3500-ft/min sink rate. In other transport airplane simulations, impacting on or near the

Table 1. Summary of airplanes tested.

Airplane	Engines		TOC	TOC difficulty	PCA test
	Qty.	Type			
F-15	2	PW1128	Simulation and flight	Very high	Simulation and flight
B-720	4	JT3-C6	Simulation	High	Simulation
Megatransport	4	100,000-lbf thrust	Simulation only	Medium	Simulation
Lear 24	2	CJ510	Flight only	Very high	No
C-402	2	TSIO520	Simulation only	Medium	No
PA-30	2	IO320	Flight only	Very high	No
F-18	2	F404-GE-400	Simulation and flight	Very high	No
MD-11	3	PW4060	Simulation and flight	High	Simulation and flight
B-727	3	JT8D	Simulation only	Very high	No
B-777	2	PW4084	Flight, very brief	–	No
B-747-400	4	PW4056	Simulation and flight	Very high	Simulation only
C-17	4	PW2040	Simulation and flight	Very high	Simulation only
T-38	2	J85	Flight only	Medium	No
T-39	2	J60	Flight only	High	No
MD-90	2	V2525	Simulation only	High	No
B-757	2	PW2040	Simulation only	High	Simulation

runway was often possible, but not at a survivable sink rate or bank angle.*

The TOC characteristics varied widely from one airplane to another, partly because of the locations of the engines. Airplanes with low-mounted engines had the best pitch control, and airplanes with engines located furthest outboard had the best roll control capability. In general, the transport airplanes were easier to control using TOC than the fighter airplanes because the transport airplanes had higher levels of natural stability. The more maneuverable fighter airplanes, particularly those with electronic stability augmentation, had lower levels of stability.

Figure 6 shows the longitudinal and lateral parameters of thrust control for the airplanes evaluated and for other aircraft. The lateral parameter is the same used in

*In early F-15 and F-18 simulations, manual TOC appeared to be suitable for making safe landings. When flight data were available, however, significant discrepancies in the simulations were evident. After the simulations were upgraded, manual TOC landings became very difficult.

figure 2. The pitch control parameter is the product of the thrust increment from trim thrust to maximum thrust, multiplied by the thrust-moment arm, and divided by the airplane length and weight. In general, airplanes located toward the upper right in figure 6 should exhibit better TOC capability; however, the F-15 and MD-11 airplanes were capable of thrust-only landings when the computer-controlled thrust (PCA) system was used.

AIRPLANES TESTED WITH A PROPULSION-CONTROLLED AIRCRAFT SYSTEM

The PCA (computer-controlled thrust) systems have been developed and tested at NASA Dryden on the F-15, MD-11, C-17, and B-720 airplanes and a conceptual megatransport; and at NASA Ames on the B-757 and B-747-400 airplanes. All tests have demonstrated sufficient control for safe runway landings. The basic PCA system control logic is simple and similar for all

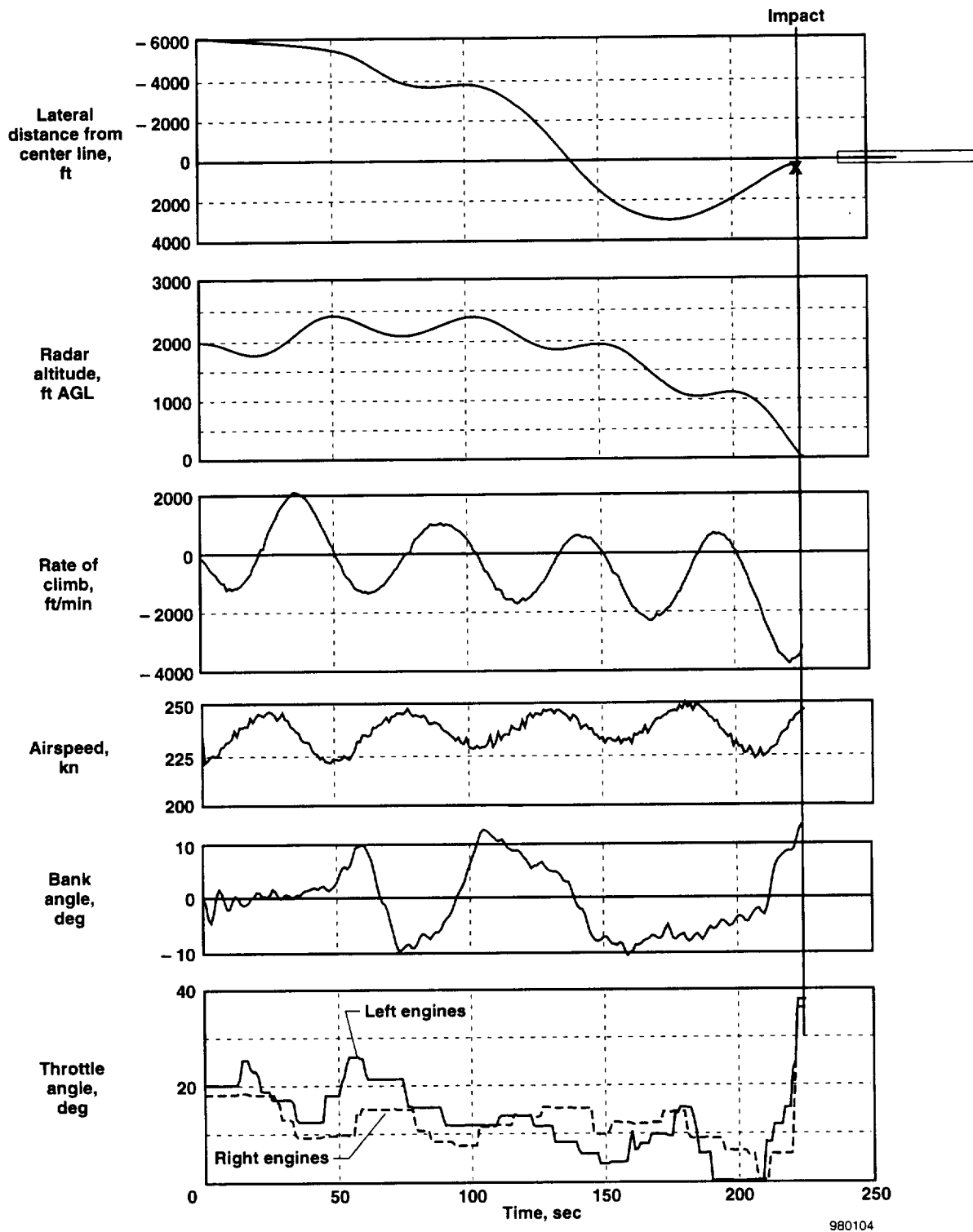

Figure 5. Manual thrust-only approach with all flight controls failed, experienced B-747 test pilot, gear down, flaps up, B-747-400 simulator.

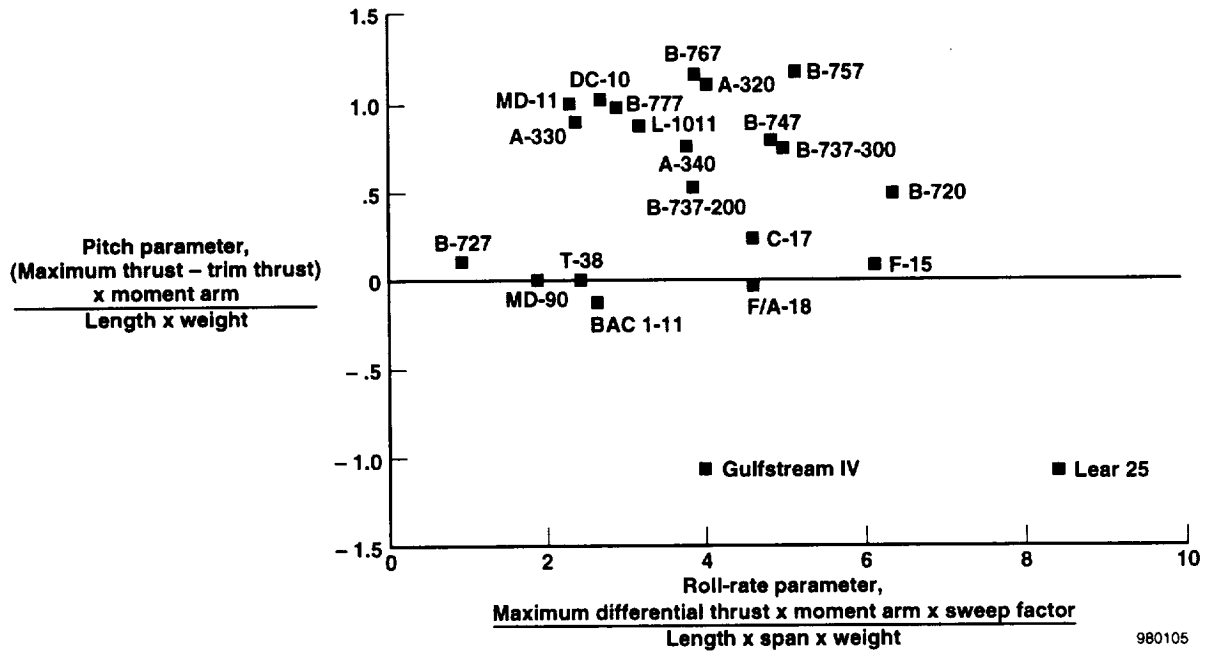

Figure 6. Thrust-only control pitch parameter and roll-rate parameters, low altitude, approximately 200 kn.

airplanes tested. Figure 7 shows a simplified schematic view of a typical PCA system. Pilot inputs in the form of flightpath and bank angle (or heading or track) commands are input into a computer. These commands are compared to measured feedback parameters, and the error signals are sent to the engines. Feedback parameters are also used to provide damping for the oscillatory phugoid and dutch roll modes.

In transport airplanes, the autopilot controllers (usually a thumbwheel for pitch control and a turn knob for lateral control) have been used for pilot inputs. In the F-15 airplane, a thumbwheel panel was added to the cockpit left console.

The most comprehensive transport airplane testing has been done on the MD-11 and B-747 airplanes, and these tests will be discussed. Tests of the PCA system were performed in the MD-11 airplane and simulation, and in the B-747-400 high fidelity simulation at NASA Ames. The airplanes and the simulations will be described briefly here.

The MD-11 Airplane

The MD-11 airplane, built by The Boeing Company (formerly McDonnell Douglas Aerospace, Long

Beach, California), is a large, long-range, wide-body transport powered by three engines. Each of the engines is in the 60,000-lbf thrust class; two are mounted on underwing pylons, and one is mounted in the base of the vertical tail (fig. 8). The wing engines are 26 ft, 10 in. out from the centerline. Maximum takeoff gross weight is 630,000 lbm, and maximum landing weight is 430,000 lbm.

The MD-11 Flight Deck Simulator (FDS) is a high-fidelity fixed-base simulation of the MD-11 airplane that contains much of the actual flight hardware. The FDS incorporates six-degree-of-freedom equations of motion, complete aerodynamic and propulsion models, analytical models of all of the MD-11 systems, and an "out-the-window" video display system. The MD-11 simulator and the test airplane flown were powered by Pratt & Whitney (East Hartford, Connecticut) PW4460 engines that have 60,000-lbf thrust each. These engines were controlled by dual-channel FADEC systems that accepted trim commands from the flight management system computer. Engine pressure ratio is the primary engine-controlled variable and ranges from approximately 0.95 at idle power to approximately 1.60 at maximum power. Thrust as a function of EPR for the PW4460 engine is a nonlinear function that has approximately 97,000 lbf/EPR at low thrust and approximately 57,000 lbf/EPR near maximum thrust.

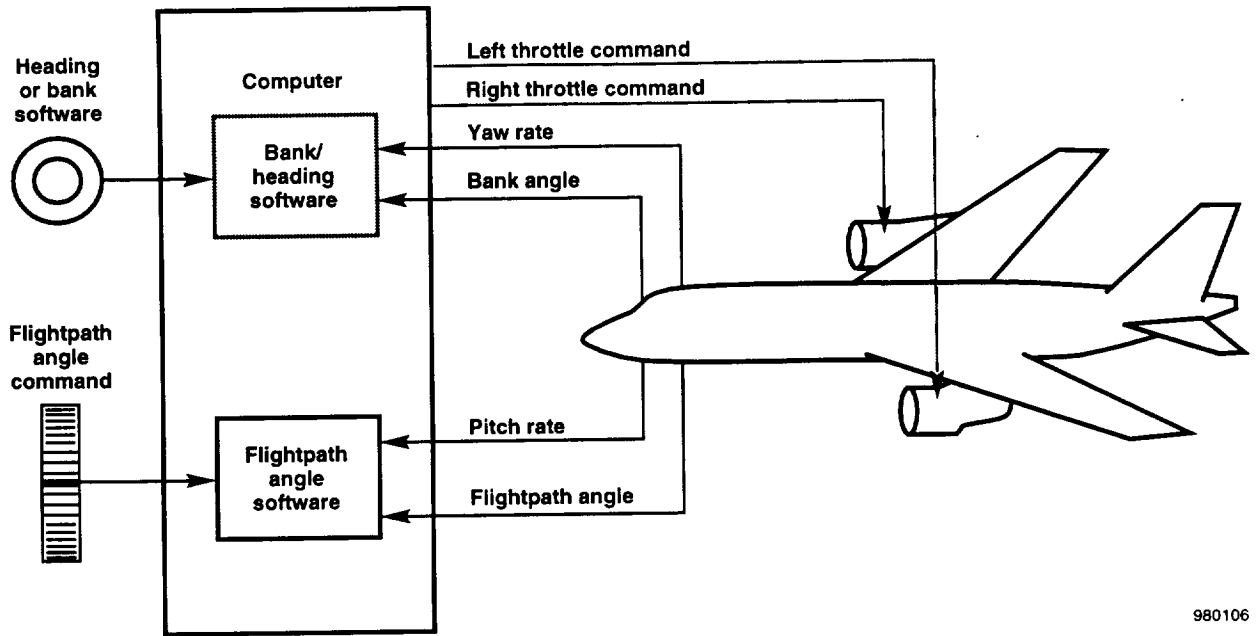

Figure 7. Simplified block diagram of a typical PCA system.

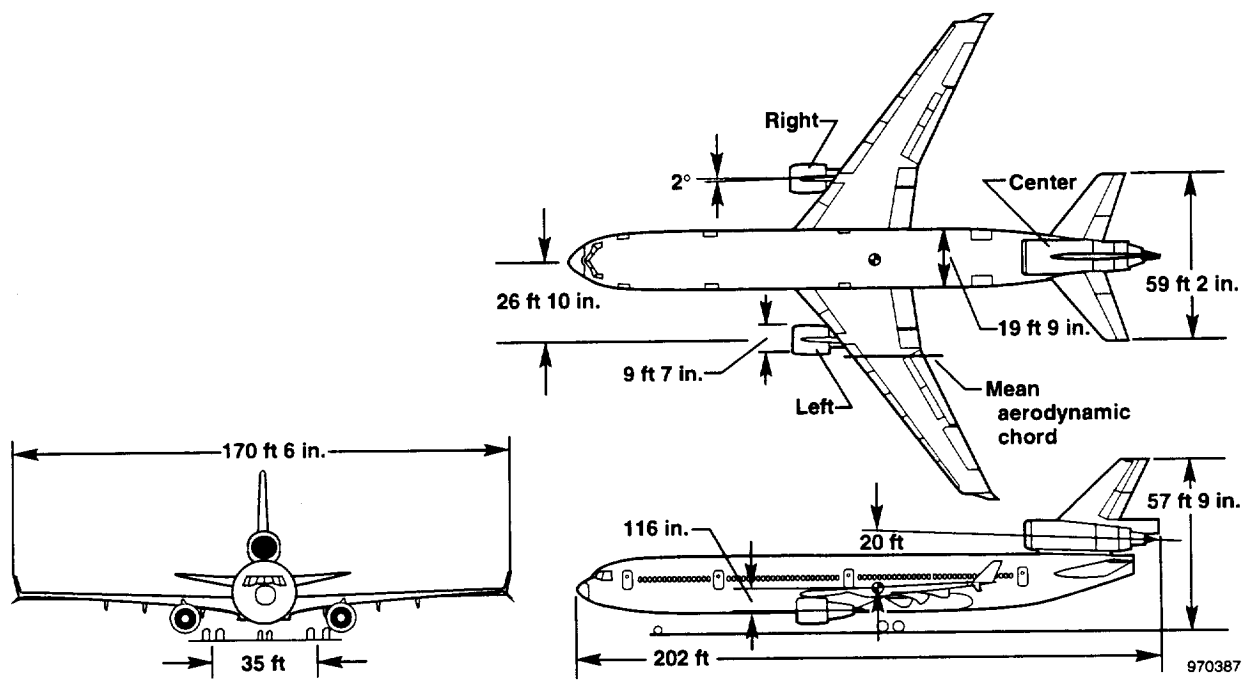
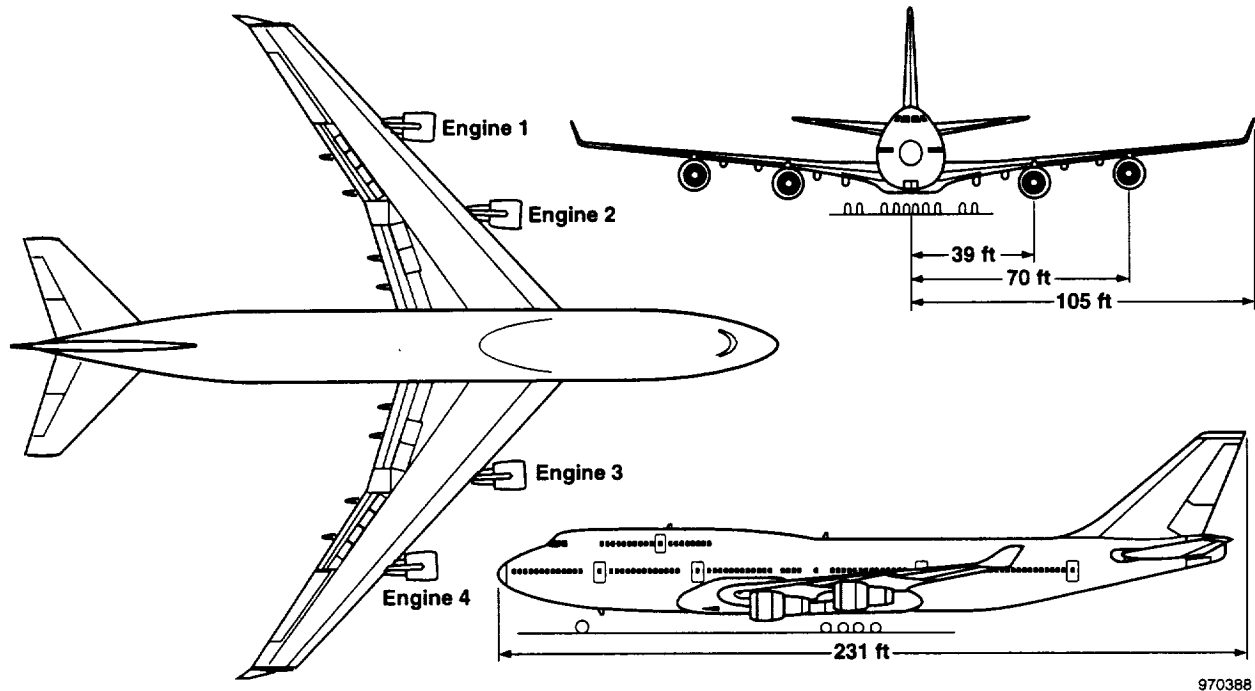

Figure 8. Three-view drawing of the MD-11 airplane.

The B-747-400 Airplane

The B-747-400 airplane (The Boeing Company, Seattle, Washington) (fig. 9) is a very large, swept-wing wide-body transport with four engines mounted

on underwing pylons. Maximum gross weight is 870,000 lbm, and maximum landing weight is 574,000 lbm. The inboard engines are 39 ft and the outboard engines are 70 ft from the centerline. Wing fuel capacity is 84,000 lbm in each inboard tank and



970388

Figure 9. Three-view drawing of the B-747-400 airplane.

30,000 lbm in each outboard tank. Additional fuel tanks are located in the center fuselage and horizontal tail, contributing to a maximum fuel weight of 386,000 lbm.

Tests have been performed on the NASA Ames B-747-400 simulator, a very-high-fidelity motion-base simulator that is certified to "level D." The simulated B-747-400 airplane is powered by Pratt & Whitney PW4056 engines that have 56,000 lbf of thrust and FADEC systems. Thrust as a function of EPR for the PW4056 engine is a nonlinear function that has approximately 90,000 lbf/EPR at low thrust and approximately 45,000 lbf/EPR near maximum thrust.

BASELINE PROPULSION-CONTROLLED AIRCRAFT SYSTEM

The baseline PCA systems were developed assuming full-authority digital control of all engines existed. Examples from the MD-11 and B-747-400 airplanes are given in the following subsections.

The MD-11 Propulsion-Controlled Aircraft System Performance

The MD-11 PCA system was implemented by changing only software in the airplane. The flight control computer contained the PCA control laws and sent commands to the FADECs over the existing ARINC 429 data bus. The FADEC logic was modified to accept full-authority (± 100 -percent) commands rather than the usual limit of ± 5 -percent changes in EPR.

The MD-11 PCA system worked very well. In up-and-away flight, the PCA system performance was comparable to the normal autopilot, holding heading and flightpath to within 0.5° command. Figure 10 shows a time history of an MD-11 PCA landing. The pilot was using the autopilot control knobs to command the PCA system for the landing at Edwards Air Force Base (California). The center engine was not actively controlled and was set near idle thrust. Weather at the time was characterized by light winds and light turbulence with occasional thermal upsets. The pilot made small track changes to maintain runway lineup and set

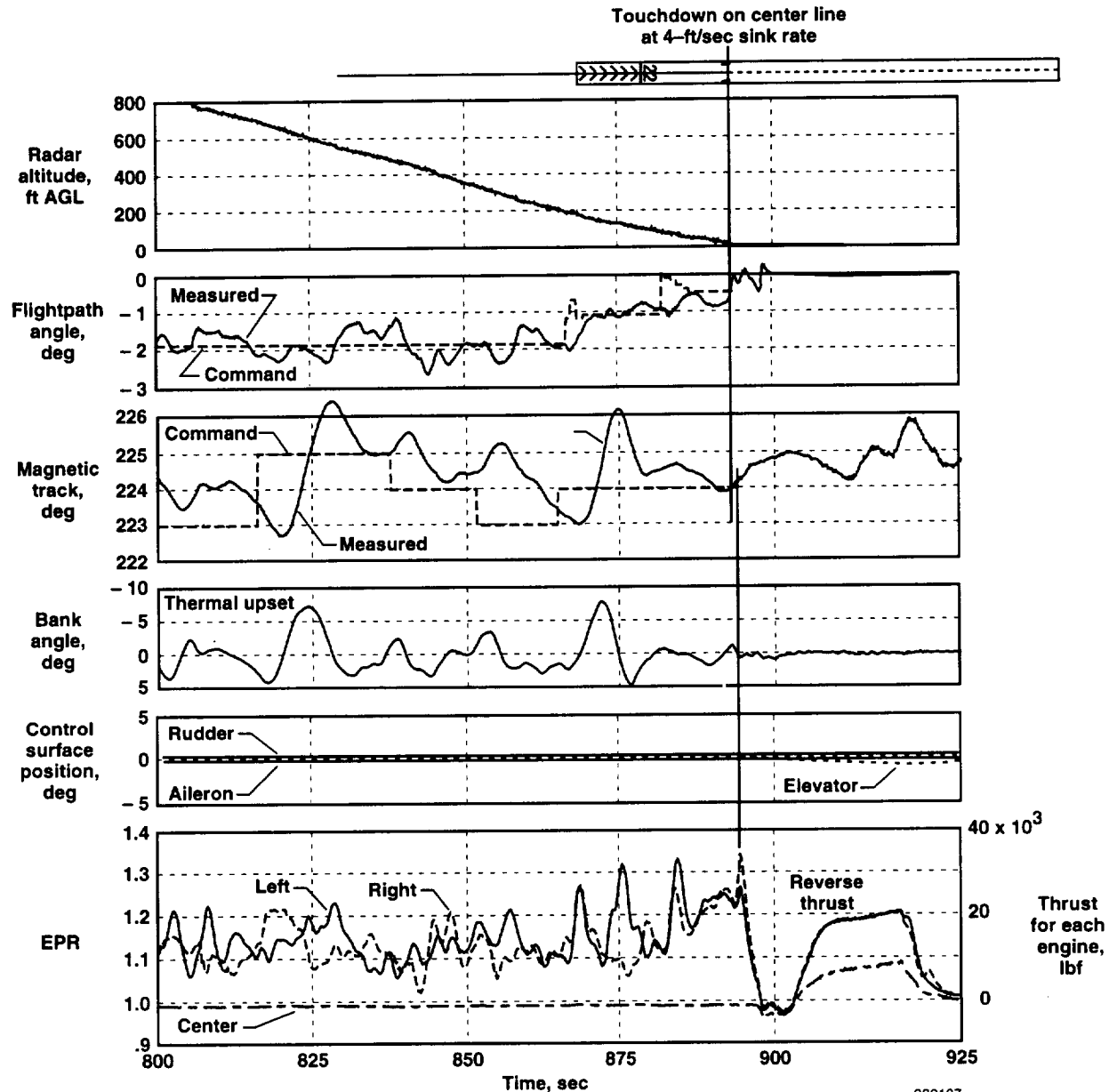
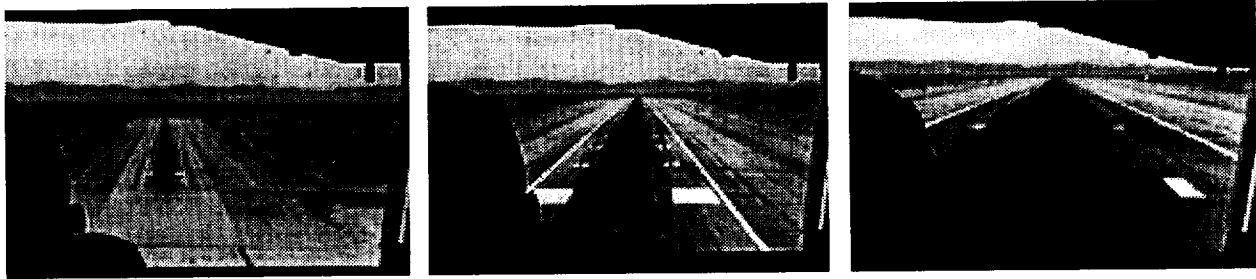

Figure 10. Time history of an MD-11 PCA landing, approach airspeed 175 kn, flaps 28, light turbulence with occasional thermals, no control surface movement.

the flightpath command at -1.9° for the initial part of the approach. Airspeed was 175 kn. At 200 ft above ground level (AGL), the pilot shallowed the flightpath to -1° and, at 100 ft AGL, to -0.5° . The airplane touched down smoothly on the center line at a 4-ft/sec sink rate 3000 ft from the threshold without either pilot making flight control inputs.

Note the upset from a thermal updraft that caused the airplane bank angle to increase to 8° at 100 ft AGL; the PCA track mode corrected this upset without requiring any pilot input. The airplane was stopped using reverse thrust and light braking but without any flight control inputs. The pilot rated the pitch control as excellent and the lateral control as adequate on this landing. Note the engine thrust changes during the approach. The majority of the thrust changes to maintain the pilot's commanded ground track are differential, although two large collective thrust pulses occurred as the flightpath was shallowed near the ground.

In smooth air, pilots could make good landings on their first try using the autopilot knob. In turbulent air, two or three approaches were needed because of the sluggish lateral control response relative to normal flight controls and the corresponding need to learn the lead needed for control corrections. Therefore, the standard MD-11 ILS-coupled system was used as an outer-loop controller in conjunction with the PCA inner-loop control laws. This pairing permitted good landings on a pilot's first attempt in turbulence levels to a maximum of the "moderate" level and reduced the pilot workload greatly.

A group of 20 pilots, representing industry, commercial airlines, the United States Department of Defense, NASA, and the Federal Aviation Administration, were invited to fly the MD-11 PCA system demonstration. Each pilot completed a brief period of using manual TOC followed by coupling the PCA system and setting up an approach to landing. Most pilots elected to fly an ILS-coupled approach, all of which were successful. Some pilots flew a PCA approach using the PCA control knobs, and most of these approaches were also successful. All pilots had high praise for the PCA system.¹²

The B-747-400 Propulsion-Controlled Aircraft System Performance

A PCA system similar to that flown on the MD-11 airplane was implemented on the B-747-400 high-fidelity

simulation at NASA Ames. The autopilot knobs were again used for pilot inputs. Control laws were located in a separate computer, and full-authority EPR trims were sent to the FADECs. An ILS-coupled capability was added, and the system was able to operate with any engine out by simply retarding the corresponding engine on the opposite side to idle power.

Performance of the B-747-400 simulation under PCA control was similar to that of the MD-11 airplane. In up-and-away flight, performance was very good. With some minor gain changes, the PCA system operated over the full flight envelope from sea level to an altitude of 35,000 ft, for the forward and far aft CGX, and in upset conditions.

For PCA landings using the autopilot knobs in smooth air, pilots had good success on the first try, similar to that for the MD-11 airplane. Similar results were observed in ILS-coupled approaches. Figure 11 shows an ILS-coupled PCA approach and landing with the right outboard engine off, light turbulence, and a 20-kn wind 30° off the nose. The PCA system retarded the left outboard engine to idle. Bank angle and flightpath were held within less than 1° of command. The pilot pulled the throttles to idle at 50 ft AGL as ground effect was entered and touched down smoothly near the runway centerline. Ten pilots flew the B-747-400 PCA simulation, including two crew members that had made the actual DC-10 throttles-only control crash-landing at Sioux City, Iowa.¹²

SIMPLIFIED PROPULSION-CONTROLLED AIRCRAFT SYSTEMS

The PCA systems flight-tested on the MD-11 and F-15 airplanes and the B-747-400 simulation used full-authority engine control implemented through digital commands sent to the digital engine controllers. In a typical transport airplane, software changes would be required to the engine control computer to accept full-authority commands from the PCA software. For easier implementation, not having to modify the engine computer software would be desirable. Approaches that would allow emergency flight control using normally available systems such as autothrottles and thrust trimming systems have been studied at NASA Dryden and NASA Ames. These simplified PCA systems, called "PCA Lite," provide somewhat reduced but possibly still adequate emergency control capability, depending

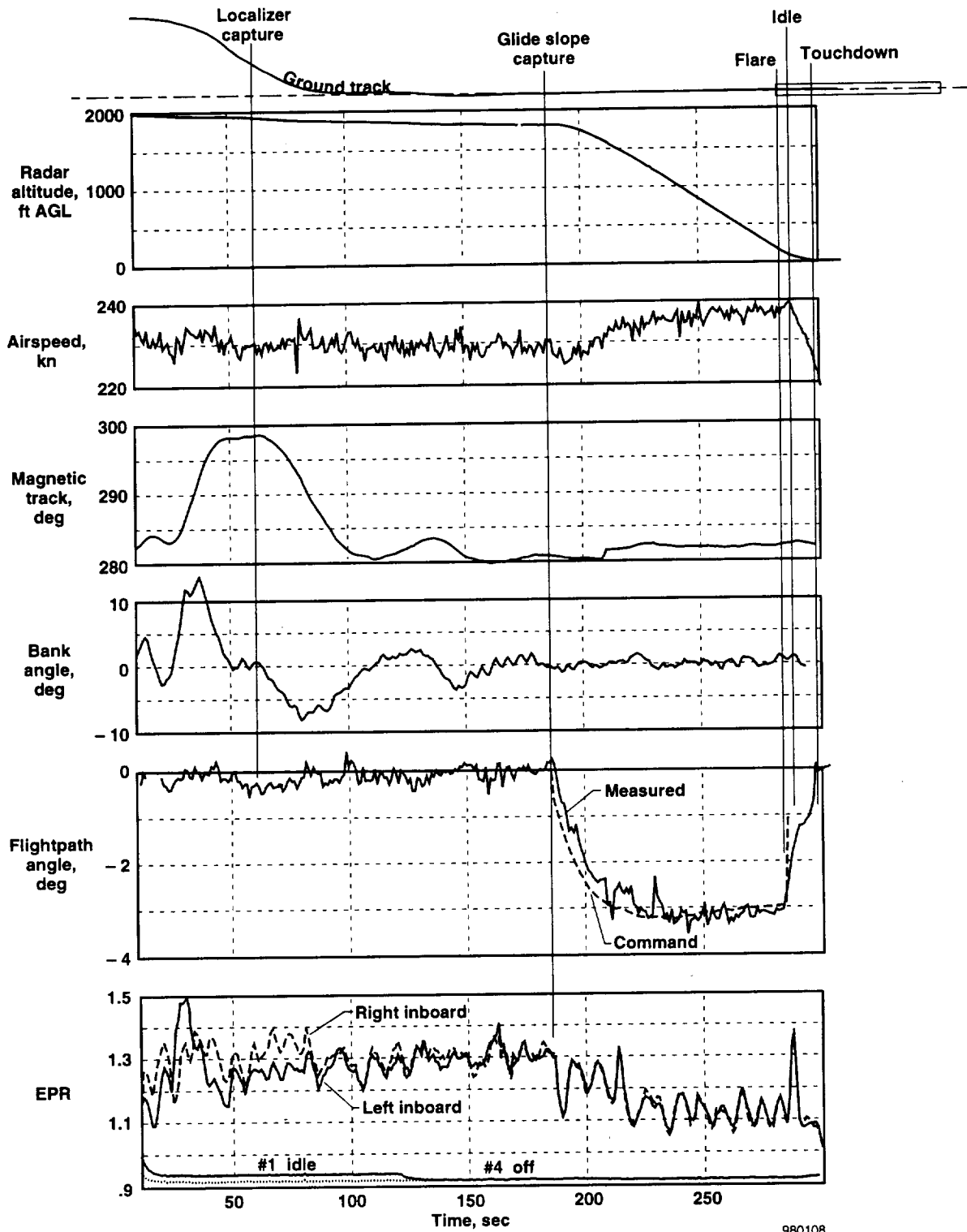

980108

Figure 11. A B-747-400 full PCA ILS-coupled landing with an engine out, all hydraulics failed, flaps up, light turbulence, wind from 310° at 20 kn, NASA Ames simulation.

on the characteristics of the airplane and the availability of approach and landing guidance.

Pitch Control

Thrust-only pitch control for many airplanes, including the B-747-400 and MD-11 airplanes, can be achieved by using the autothrottle system to symmetrically drive the throttles using control laws similar to the full PCA systems. Depending on the autothrottle servo system response, adequate pitch control capability may be provided. Pitch commands can be provided by autopilot flightpath control thumbwheel or by coupling to an ILS or other landing aid.

Lateral Control

In the absence of normal flight controls, lateral control is generally provided by differential thrust. This control may be achieved using the techniques discussed below.

Lateral Trim

Operating in the autothrottle mode for pitch control, lateral trim inputs can be manually made by the crew to provide approximately wings-level flight. The throttle stagger is maintained by the autothrottle system if the idle or maximum thrust stops are not encountered.

Manual Lateral Control

Lateral control can also be performed by manual differential throttle manipulation (TOC) by the pilot. With the longitudinal control task being done by the autothrottles, a pilot may be able to provide adequate lateral control for lineup and landing, depending on the airplane characteristics. This method of control should be available on many transport airplanes, although older transports may have analog autopilot or autothrottle systems that would require hardware modifications to perform the pitch PCA control calculations. Although full manual control is not practical (fig. 5), if the pitch control problem is handled by the PCA system, the crew may find it possible to provide lateral control. This "PCA Ultralite" concept was tested on the B-747-400 simulation. Making differential throttle inputs to throttles that were constantly being moved by

the pitch control logic was expected to be difficult; however, a significant problem was not found.

Thrust Trim Lateral Control

"PCA Lite" lateral control can also be provided using the existing thrust trim system installed on some airplanes. The authority of the thrust trim is usually limited to ± 5 percent and may be implemented in terms of EPR or fan speed. One method of commanding lateral control is to use the autopilot heading or track knob. This method of control is available on most airplanes equipped with FADECs, including the MD-11 and the B-747-400 airplanes.

"PCA Lite" Results

Simplified "PCA Lite" tests have been conducted on simulations of the MD-11 and B-747-400 airplanes. Results are described below.

The MD-11 Simulation "PCA Lite" Results

The performance of the MD-11 airplane with a pitch PCA system operating through the autothrottle servo was studied in a linear off-line simulation.¹¹ Performance was studied with all engines operating and was judged to be adequate. Performance was further improved if the center engine was shut down to provide a more favorable positive pitching moment with thrust than was provided with all engines operating.

Simplified means of achieving lateral control on the MD-11 airplane is expected to be less successful than that achieved on the B-747-400 airplane because of the further inboard location of the wing engines. Figure 2 and figure 6 show that the roll-rate parameter for the MD-11 airplane is only one-half that of the B-747-400 airplane. The lateral mode of "PCA Lite" on the MD-11 airplane was not tested; however, inspection of the differential thrust employed on the PCA landing (fig. 10) exceeds the 0.06 differential EPR that would be available using "PCA Lite."

The B-747-400 Simulation "PCA Lite" Results

The predominantly collective engine activity on the B-747-400 is primarily caused by the relatively further outboard location of the engines. This observation was the foundation for the concept of using the existing

± 5 -percent EPR trim capability instead of full-authority EPR trim. Pitch control can be obtained by driving the engine throttles with the autothrottle system. In this mode, the throttles move in the cockpit.

Tests of the "PCA Lite" system were performed and compared to the baseline full-authority PCA system (fig. 12). Figure 12(a) shows pitch control using the full-authority PCA system and using "PCA Lite" to be approximately equivalent. Figure 12(b) shows a comparison of the response to a track step command using the full-authority PCA system and using "PCA Lite." The differential EPR available is approximately one-half and does not reach the 0.06 maximum differential EPR, but adequate response is still obtained. Although less effective than the full-authority system, this "PCA Lite" system was found to be satisfactory for up-and-away maneuvering and for making ILS-coupled

approaches in turbulence levels to a maximum of "light-to-moderate." A test with a 2° rudder offset was also evaluated. The pilot was able to trim out that asymmetry with throttle stagger and completed a successful "PCA Lite" landing.

"PCA Ultralite" Results

Simplified "PCA Ultralite" tests have been conducted on high-fidelity simulations of the MD-11 and B-747-400 airplanes. Results are described below.

The MD-11 Simulation "PCA Ultralite" Results

The "PCA Ultralite" system was tested on the MD-11 FDS. Although the throttles would move in this

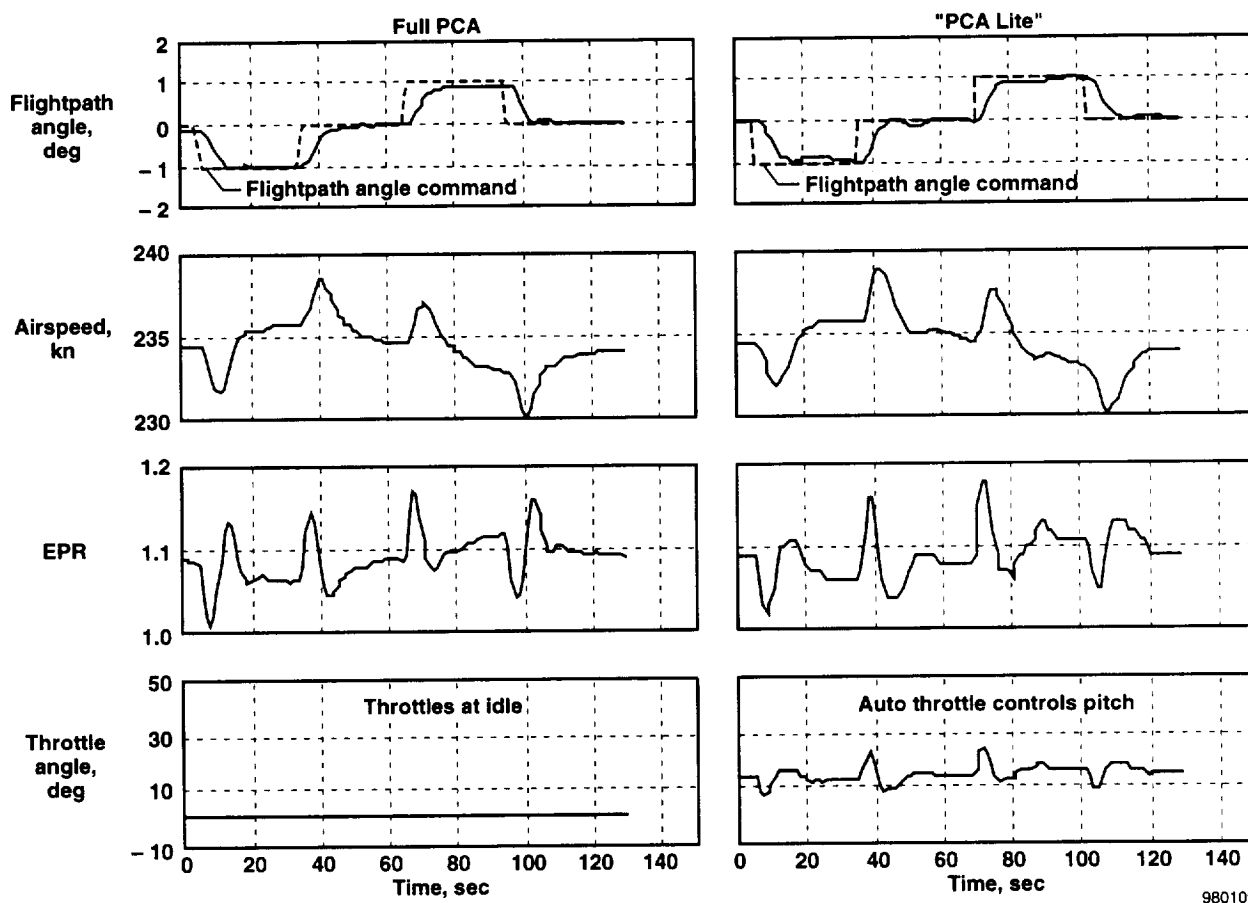

(a) Flightpath angle response.

Figure 12. Comparison of B-747-400 full PCA and simplified "PCA Lite" step response, an altitude of 2000 ft, gear down, complete hydraulic failure.

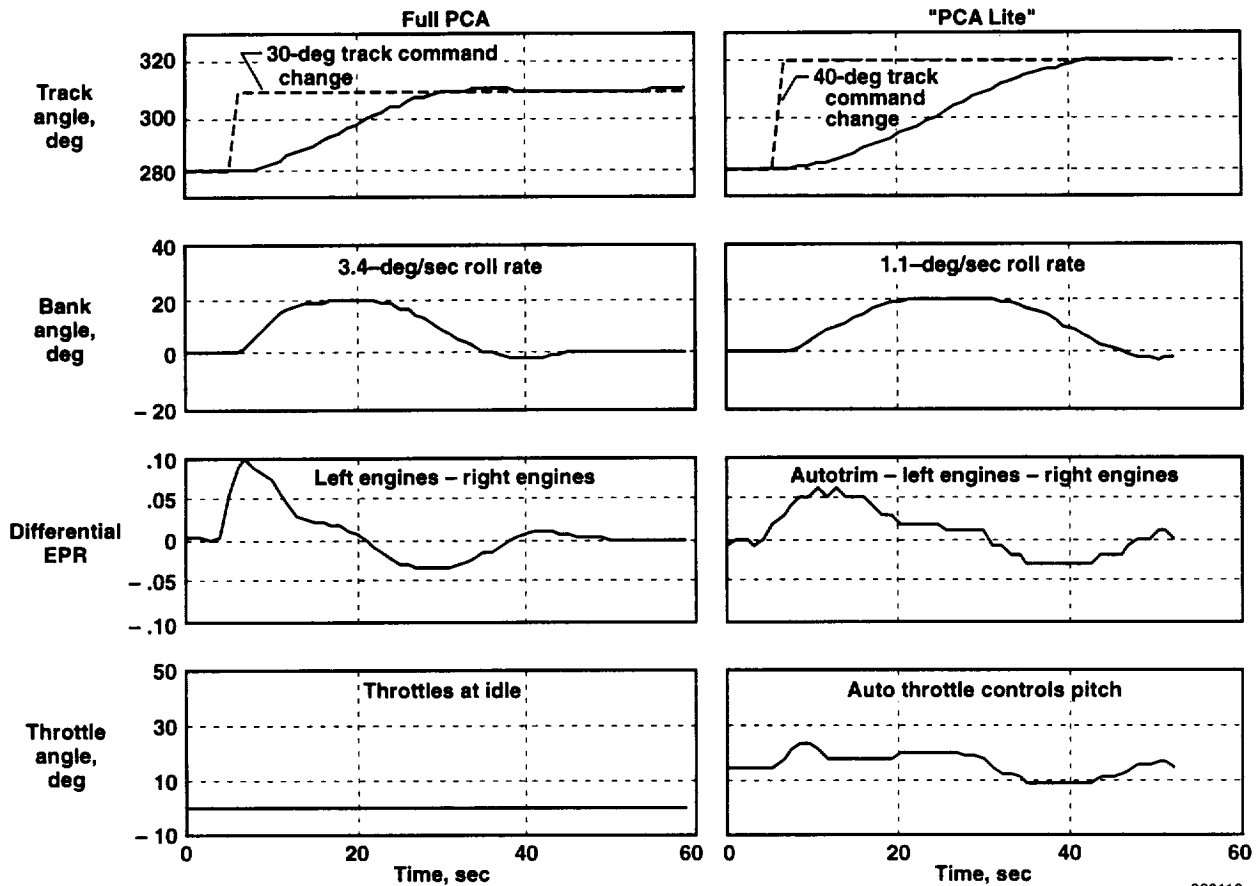

980110

(b) Track angle response, 235 kn.

Figure 12. Concluded.

mode in an actual MD-11 airplane, the throttles did not move in the FDS. The pitch control through the simulated autothrottle system was very good, but lateral control using manual throttle manipulation was sluggish and quite difficult. A strong tendency to oscillate back and forth across the localizer on approach existed even after practice. Despite these difficulties, most of the landings were on or nearly on the runway and would likely have been survivable.

Figure 13 shows a time history of a "PCA Ultralite" approach and landing. This approach was flown in smooth air with flaps at 15°. The copilot flew the pitch axis and initially selected a -2.8° flightpath. Throughout the approach, small flightpath command changes were made. Again, the autothrottle system generally maintained pitch within 0.5° of command. For lateral control, the pilot used manual differential throttle for control. Small differential thrust inputs of approximately 0.05 EPR were needed. The pilot was able to

stay relatively close to the localizer, not deviating more than 1°, but oscillated back and forth across the localizer because of the difficulty in anticipating aircraft response. Localizer oscillation was a recurring problem in most runs and is reflected in bank angle. Even when the aircraft was near the runway, bank angle drifted to slightly more than 5°, which is close to the 8° landing limit.

At approximately 160 sec, the flightpath was shallowed for landing. Touchdown occurred 30 ft right of center line with a high sink rate of 11 ft/sec and a bank angle of approximately 5°. The approach was never completely stabilized and would have been abandoned for a go-around maneuver if go-around maneuvers had been allowed for this simulation. This landing would have been survivable, but came close to exceeding limits. In other approaches, the use of only one throttle was tried with little benefit.

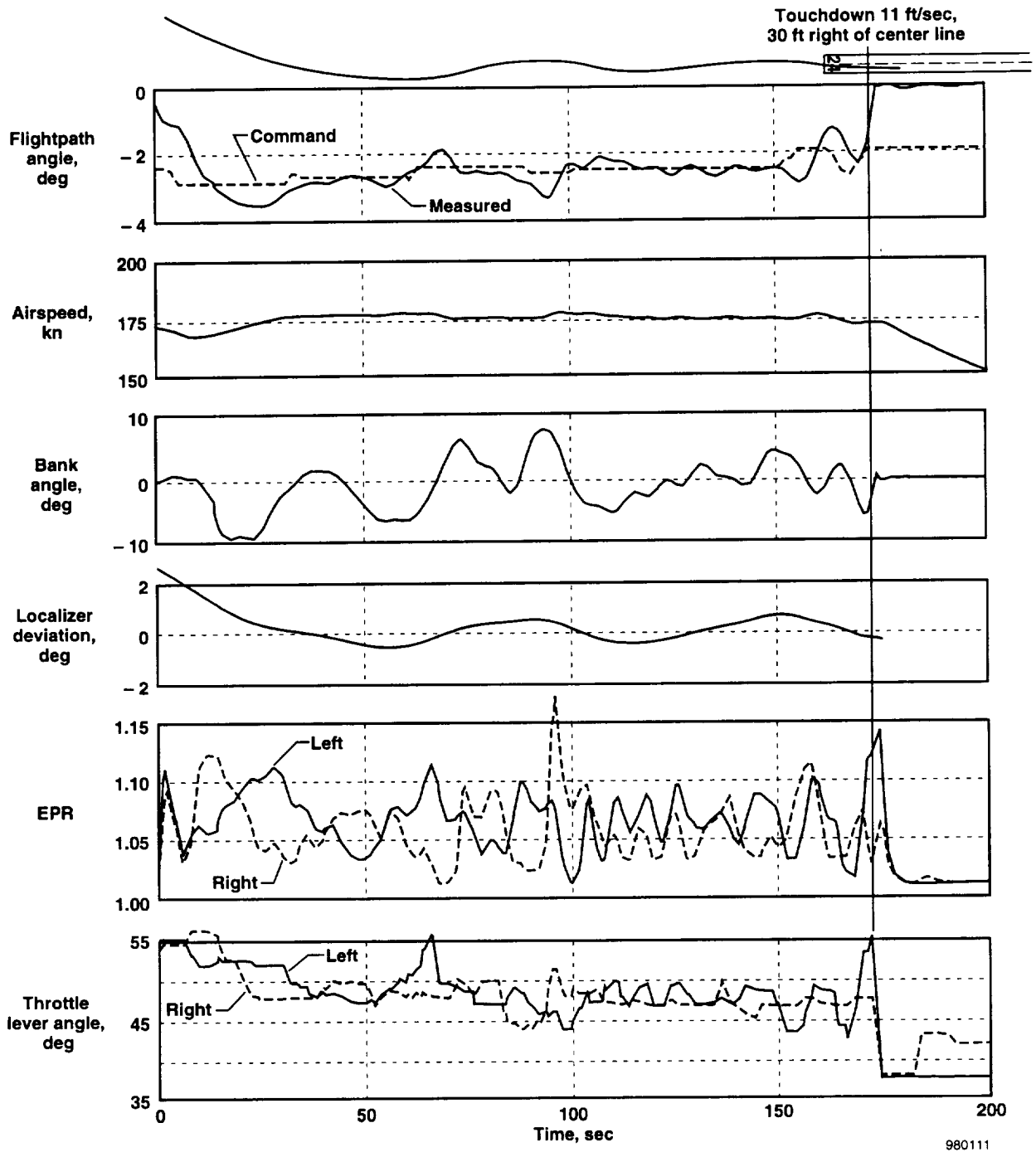

Figure 13. An MD-11 FDS "PCA Ultralite" approach, 15° flaps, no flight control movement.

Go-around maneuvers were possible at altitudes as low as 100 ft AGL for approaches that were not well-lined up. Rudder offsets to a maximum of 4° could be accommodated with flaps down, and to a maximum of 3° with flaps up, although these offsets made the

task even more difficult. For rudder offsets greater than 4°, depending on the flightpath command, running out of differential throttle authority and temporarily losing control until the *FPA* was adjusted was possible.

The B-747-400 Simulation "PCA Ultralite" Results

Several "PCA Ultralite" landings were flown in the B-747-400 simulator at NASA Ames. Initial tests by pilots familiar with PCA characteristics were generally successful. Difficulties became apparent, however, when pilots not familiar with the sluggish and poorly damped lateral control flew approaches.

Figure 14 shows the first approach by an unfamiliar pilot. As is typical of someone with little PCA experience, the pilot tended to overcontrol the throttles throughout the approach. The pilot started with an aggressive bank angle to intercept the localizer, but then lessened the angle when the airplane was within 1000 ft of the localizer. Large differential thrust inputs of approximately 0.07 EPR were often used to try to stay on the localizer. This relatively large differential thrust resulted in large bank angles and caused the aircraft to oscillate across the localizer.

Near the landing point, the aircraft was slightly off the right side of the runway. To get back on the runway, the pilot subsequently commanded differential thrust that caused a large 10° bank angle. Along the way, the aircraft hit hard, with a vertical speed of approximately 10 ft/sec, and bounced. The pilot then tried to line up with the runway by rolling the aircraft 10° in the opposite direction. Immediately before the second touchdown, the pilot made a differential thrust input to level the wings. The aircraft landed 13 sec after the first touchdown, 4500 ft down on the right edge of the runway, in a 2° bank with a vertical speed of approximately 3 ft/sec. This approach was not very well-stabilized; many large differential thrust inputs were made trying to keep the aircraft on the center line. Near the runway, this overcontrol continued, but the pilot was able to make a survivable landing.

The "PCA Ultralite" experience on the MD-11 and B-747-400 simulations indicate that more work is needed to assure safe landings. The use of some sort of cockpit display to cue the pilot's manual throttle inputs is being studied.

THRUST-ONLY CONTROL: WING ENGINES FAILED AND LATERAL CENTER-OF-GRAVITY SHIFT

As discussed earlier, the thrust from the engine(s) on only one wing can be used for flight control if a suitable

way of shifting the center of gravity, CG, toward the operating engine is available. The capability to shift the CG with fuel transfer and the TOC capability are discussed below.

Capability to Shift Lateral Center of Gravity

The fuel systems of some airplanes have been studied to determine the degree of lateral offset that may be obtained. The MD-11 airplane is typical of many transport aircraft, having most of the fuel located in the wings and center fuselage. Each wing tank holds 42,000 lbm of fuel. The remaining fuel is located in the center fuselage tanks and in a small tail tank used to provide CGX control. Fuel distribution is normally controlled by the fuel management system, which maintains a programmed CGX schedule, but fuel may also be manually transferred among tanks. After take-off, fuel is normally transferred to the tail tank to move the CGX aft. As discussed in a previous publication,¹³ the lateral CGY can be shifted a maximum 48 in. Using the unmodified fuel system, approximately 16 min would be required to complete this CGY shift.

A similar situation occurs on other airplanes studied. Four-engine transport aircraft studied include the B-747-400, the CV-990, and the C-17 airplanes. Table 2 shows the maximum CGY offsets available for these four airplanes and the CGY normalized by wingspan. All four airplanes show a similar capability of between 2.4 and 3.5 percent of total wingspan.

Table 2. CGY offsets caused by wing fuel transfer for four transport airplanes.

Airplane	Maximum differential fuel, lbm	CGY, in.	Overall wing span, ft	CGY/ Span
MD-11	42,000	48	170	0.024
B-747	114,000	85	211	0.033
C-17	90,000	66	165	0.033
CV-990	40,300	51	120	0.035

These CGY offsets are also well within the tread of the main landing gear, so no tipover tendency would exist.

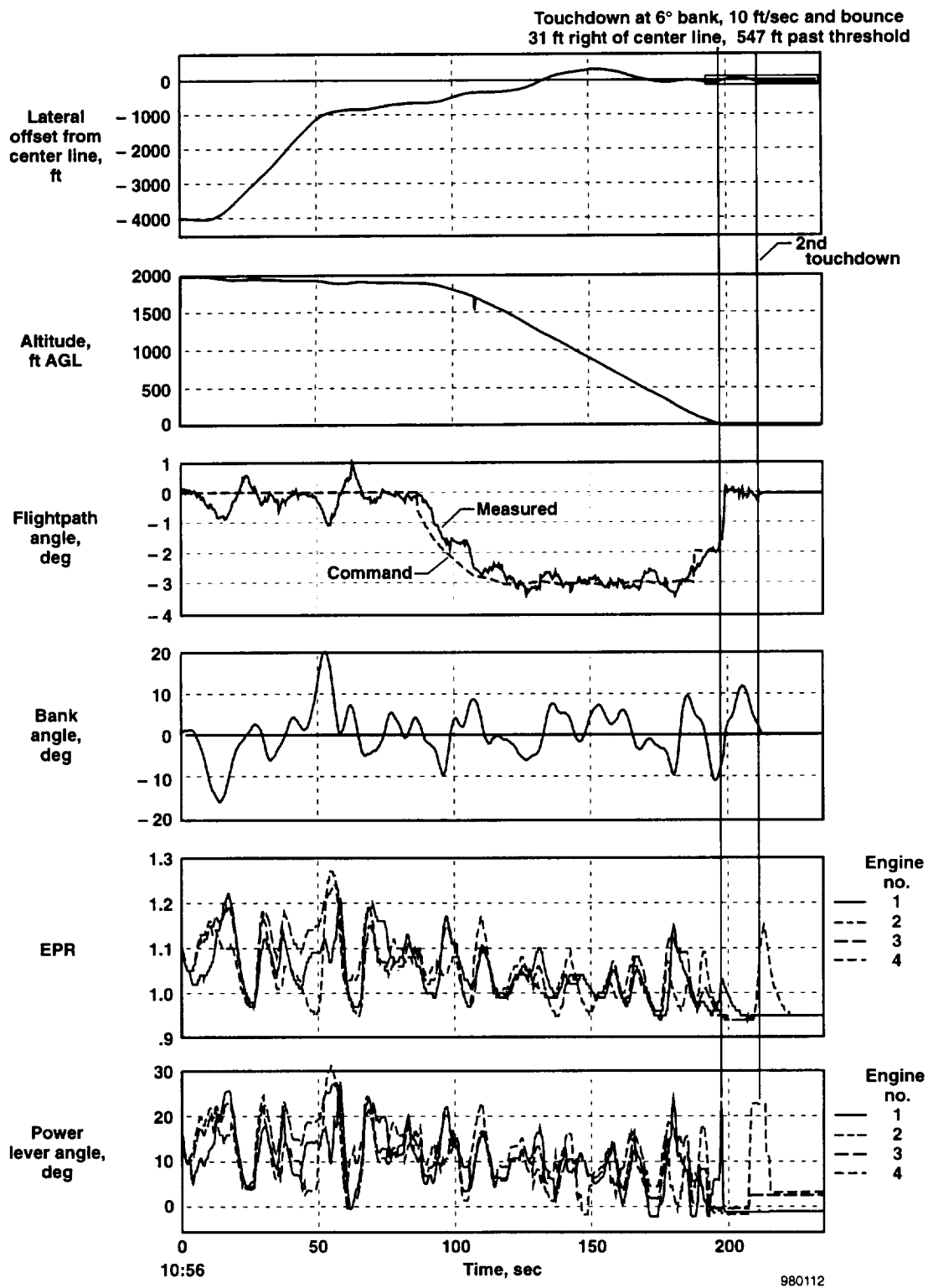

Figure 14. A B-747-400 simulator "PCA Ultralite" approach, glide slope-coupled, 240 kn, 0° flaps, light turbulence, wind 250° at 20 kn.

and flying at an altitude of 10,000 ft, essentially level flight is possible with the inboard engine at high power

become more severe than it has been if approaches are

Thrust-Only Control Capability With Lateral Center of Gravity Shifted

speeds from 200 to 300 kn, as shown. As speed increased, the *CGY* required for wings-level flight decreased because as airspeed increased, the yawing

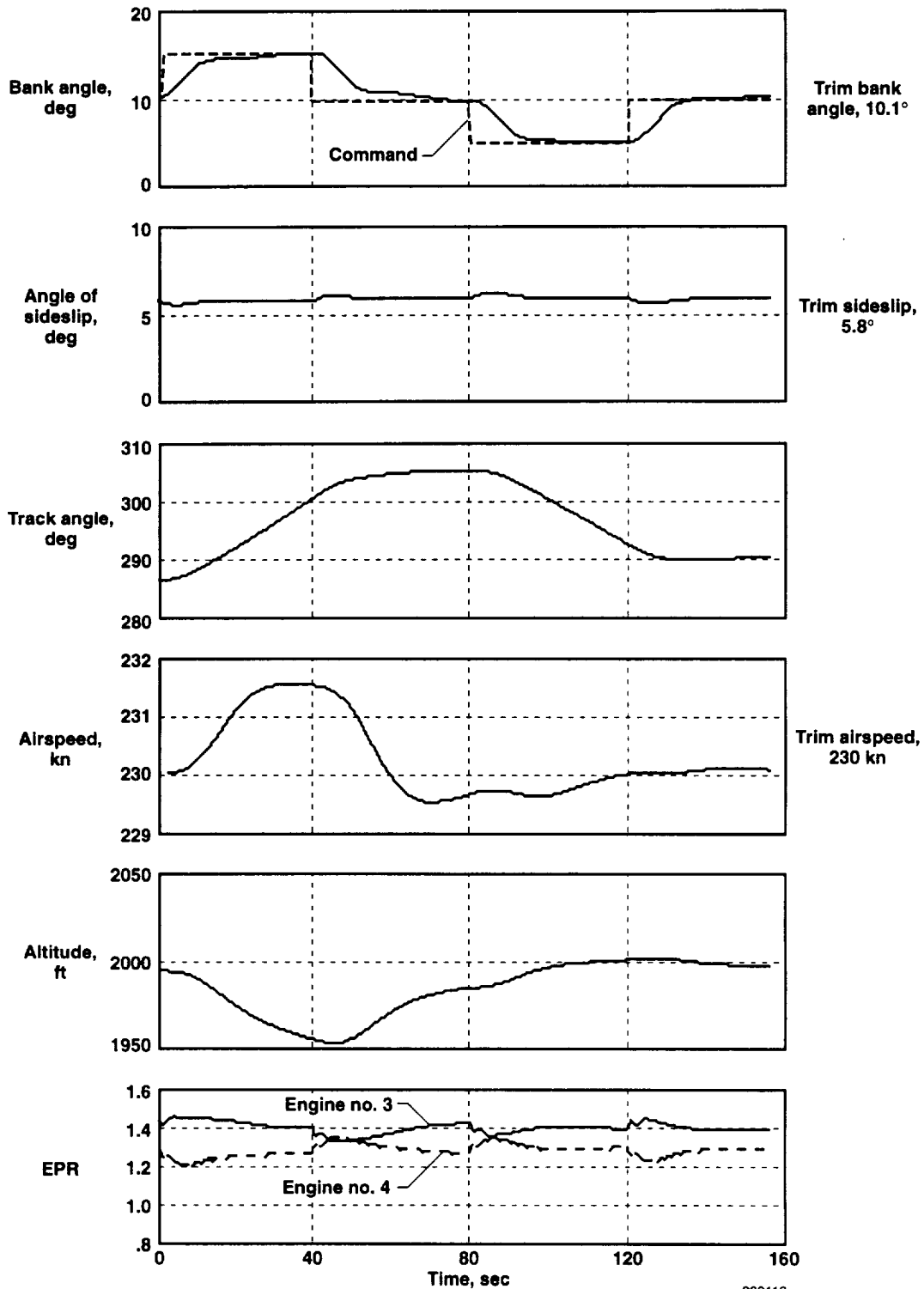

980113

(a) Bank angle step response.

Figure 16. A B-747-400 off-line simulation step response. number 1 and number 2 engines off complete hydraulic

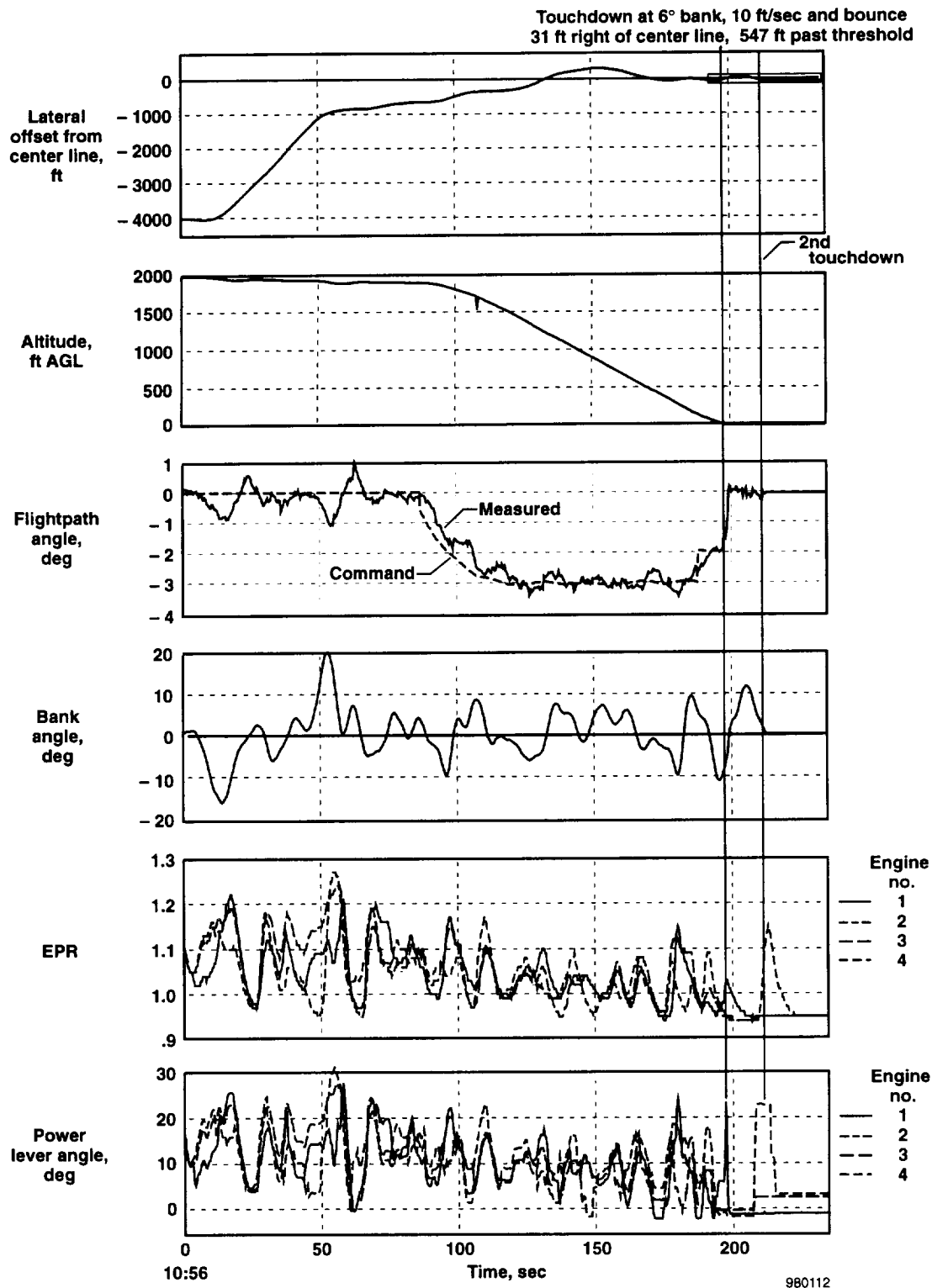

Figure 14. A B-747-400 simulator "PCA Ultralite" approach, glide slope-coupled, 240 kn, 0° flaps, light turbulence, wind 250° at 20 kn.

Thrust-Only Control Capability With Lateral Center of Gravity Shifted

The thrust-only control capability of the MD-11 and B-747-400 airplanes have been studied in high-fidelity simulators, previously described. Results are discussed below.

The MD-11 Simulation Results

Tests were performed in the FDS by turning off the yaw dampers and longitudinal stability augmentation systems and not touching the flight controls, thereby eliminating any control surface movement. Beginning from a trimmed condition, both wing engine throttles were retarded to idle and fuel transfer was begun. As *CGY* increased, the thrust required for wings-level flight gradually increased.

Figure 15 shows the EPR for the right, or number 3, engine that is required to hold wings level (with the left, or number 1, engine either at idle or off) as a function of speed at an altitude of 10,000 ft with gear and flaps up. Well within the available *CGY* offset, wings-level flight on one engine was possible over a range of

speeds from 200 to 300 kn, as shown. As speed increased, the *CGY* required for wings-level flight decreased because as airspeed increased, the yawing moment from thrust produced less sideslip and hence, less roll. At 300 kn, nearly full thrust on the number 3 engine was required to hold the wings level. If *CGY* was increased to more than approximately 30 in., enough thrust would not have existed to prevent a roll to the right. Note that a steady sideslip is required for this flight condition; therefore, a steady bank angle is required to fly a constant heading.

Figure 15 also shows a shaded band that represents a thrust value that will result in an *FPA* of 0°. Conditions above the band will result in a climb; conditions below the band will result in a descent. Note that this band is for the MD-11 airplane with the center engine at idle, which approximates a twin-jet airplane. In the MD-11 airplane, the center engine thrust could be used to provide an independent means of *FPA* control.

Open-loop throttle step tests were made. For a wings-level condition, the right engine thrust was increased, sideslip increased to an average of 3°, and the roll rate generated was -5 deg/sec. As the bank angle passed through 40°, the right engine thrust was reduced to idle,

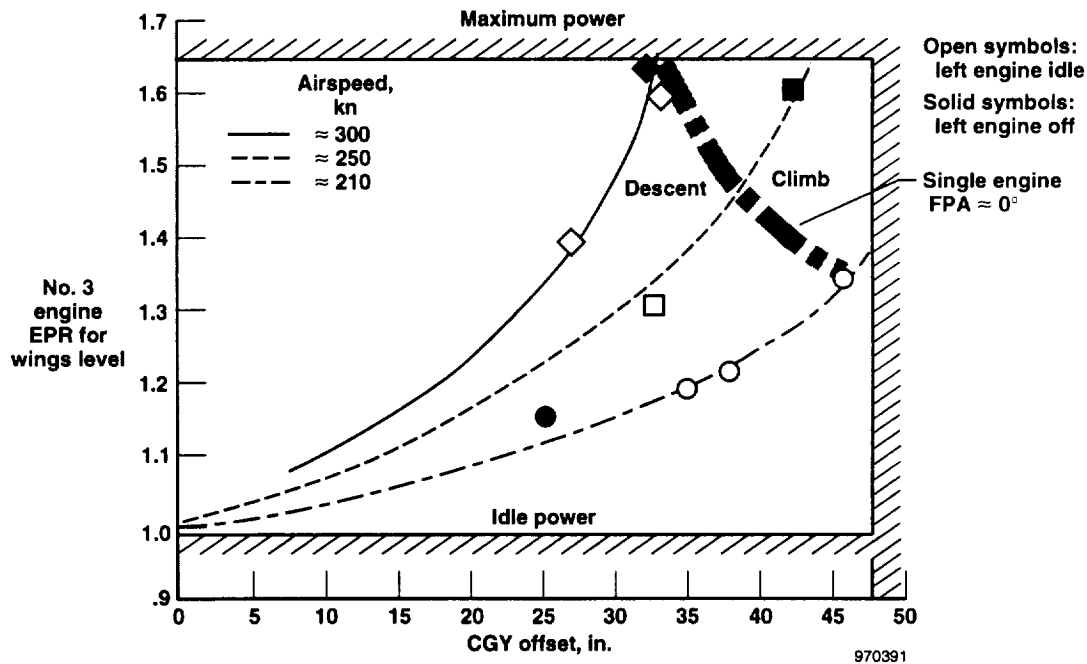

Figure 15. Effect of *CGY* offset on EPR on the number 3 engine required for wings-level flight, MD-11 FDS, flaps and slats up, gear up, an altitude of approximately 10,000 ft, gross weight approximately 400,000 lbm, center engine at idle power.

which caused the sideslip to go to 0° and the roll rate to reverse to approximately 4 deg/sec. In other tests at 300 kn, the sideslip required for wings-level flight was only 1° , but took nearly full thrust. Maximum roll rates of 4–5 deg/sec are possible, although depending on speed, the roll rates may not be equal in each direction. These rates should be adequate for runway lineup in light turbulence.

Manual throttles-only control in this configuration was, as expected, extremely difficult, but with some practice, gross control could be maintained. Control was greatly improved with the use of a closed-loop automatic control system. The control laws from the PCA system that had been flight-tested² were modified slightly, leaving only the right engine thrust being modulated to control track angle, and had feedback parameters of roll rate, yaw rate, bank angle, and track. The lateral control with gains unmodified from the standard MD-11 PCA system provided stable track control, although the control was very sluggish and had a 5° steady-state bias. A 12° commanded track change took more than 50 sec to complete. Longitudinal control using fuel transfer and the center engine had not been implemented, so pitch axis was uncontrolled, the phugoid mode produced *FPA* oscillations of approximately 2° , and damping was very light.

Later, simulated approaches to a runway were made in the MD-11 FDS. Using the "Track" command knob, runway alignment could be achieved and accurately maintained, although a bias of several degrees was required to track the extended runway center line. No closed-loop *FPA* control capability existed in this early test, but *FPA* could likely be controlled sufficiently for a survivable landing using either the center engine or by controlling *CGY*. Detailed information on the MD-11 airplane has previously been published.¹³

The B-747-400 Simulation Results

On the B-747-400 airplane, full fuel (114,000 lbm) in one wing and empty tanks in the other wing provides a *CGY* offset of approximately 83 in. In the simulator, the operator could put full fuel in the right wing tanks and empty the left wing tanks. With all dampers turned off, flight controls not used, all fuel in the right wing, and flying at an altitude of 10,000 ft, essentially level flight is possible with the inboard engine at high power and the outboard engine at low power and modulated to

maintain the desired bank angle. Manual throttles-only control (using the outboard engine primarily for roll control and the inboard primarily for pitch control) is adequate to maintain flight, but even gross control is initially very difficult. After some practice, achieving a degree of heading control is possible, but flightpath control is still extremely difficult.

A preliminary closed-loop control system for the B-747-400 airplane was devised and implemented at NASA Ames and produced stable control, although over a restricted flight envelope. Figure 16 shows the data developed for conditions including a *CGY* of 68.1 in., a speed of 230 kn, and an altitude of 2000 ft, with gear down and flaps up, all hydraulics failed, and the number 1 and number 2 engines shut down. The trim bank angle required for constant heading flight was 10° with a sideslip of 5.8° , engine number 3 at 1.4 EPR, and engine number 4 at 1.3 EPR.

Figure 16(a) shows bank angle commanded from 10° to 15° , then back to 10° , then to 5° , and then back to 10° . Engine thrust was modulated to control bank, which was held well. Figure 16(b) shows flightpath control. At time zero, the flightpath command was reduced to -1° . The thrust of the number 3 and number 4 engines was modulated to hold the commanded flightpath and maintain the commanded heading of 286° . Control was also good when the command was returned to zero. The performance of this control law is surprisingly good and could be combined with *CGY* control for control over a wide range of flightpaths. More detailed information on the B-747-400 *CGY* offset tests has previously been published.¹³

ENGINE THRUST RESPONSE AND CONTROL

The response of engines is important when considering thrust for flight control. Typical flight control surfaces respond almost instantly, whereas engine thrust response is significantly slower. In all applications studied, however, engine response has been sufficient to provide adequate control. The slow response of the high-bypass turbofan engines has not been a problem because the dynamics of large airplanes are slow relative to the engine response. The problem could become more severe than it has been if approaches are flown with no flaps. For fighter aircraft such as the F-15

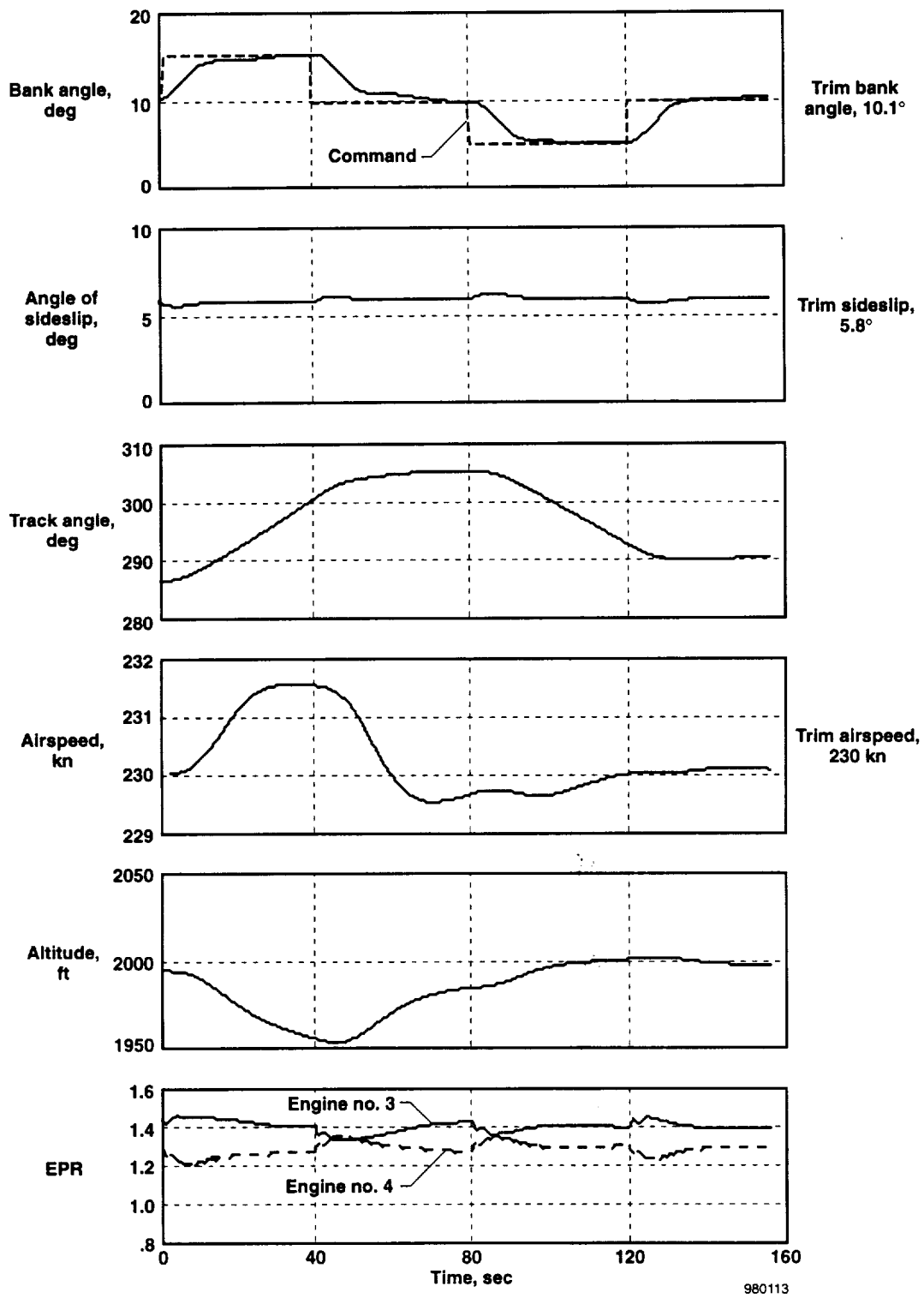

(a) Bank angle step response.

Figure 16. A B-747-400 off-line simulation step response, number 1 and number 2 engines off, complete hydraulic failure, gross weight 550,000 lbm, lateral center of gravity 68.1 in.

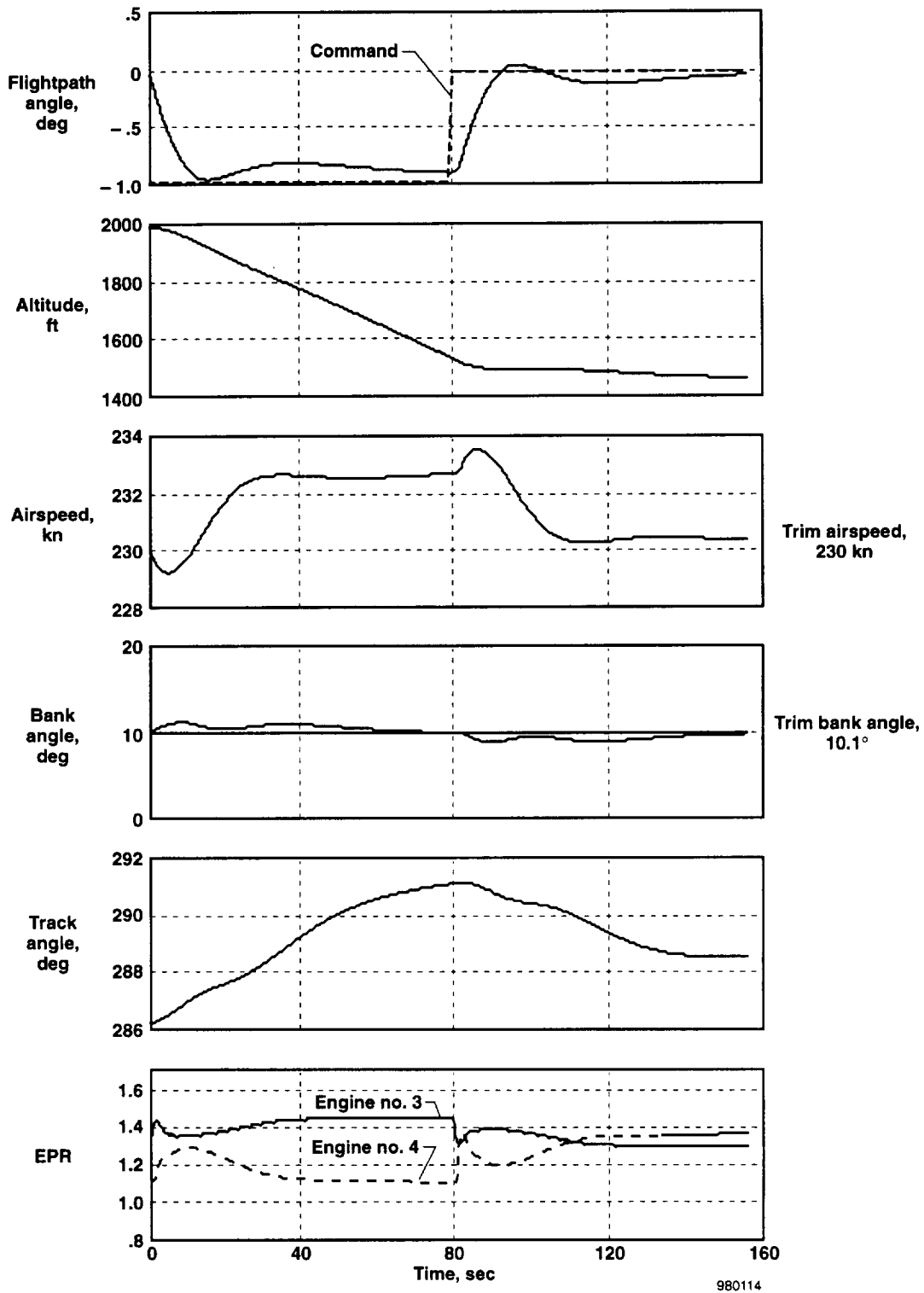

(b) Flightpath angle step response.

Figure 16. Concluded.

and F-18 airplanes, airframe dynamics have a higher frequency than transport airplanes, but the engine response is faster and control is still adequate.

Engine thrust control has also not been a problem. In the PCA flight tests, the F100 engine in the F-15 airplane and the PW4460 engines in the MD-11 airplane had excellent thrust repeatability and resolution. Sending digital commands to the engine control systems, as was done in these PCA tests, provides an almost infinite resolution, and the ability to command and get very small thrust changes has been excellent. Using the autothrottle servo motors, as was done in the "PCA Lite" tests on the B-747-400 airplane, has also been successful, indicating that precise thrust control may not be required for closed-loop systems.

CONCLUDING REMARKS

The emergency flight control capability of airplanes using only engine thrust has been studied in flight and in simulations. All airplanes tested have been found to have the capability for extended flight using engine thrust for flight control. Using throttles-only control, gross control is available and getting to an airport is often possible, but making a safe landing is not usually possible. Using computer-controlled thrust, flight control is greatly improved, and safe landings have been demonstrated in F-15 and MD-11 airplanes and in simulations of transport airplanes. Thus, a propulsion-controlled aircraft (PCA) system can be used to make a safe landing if all flight control surfaces become inoperative.

Simplified PCA systems ("PCA Lite") using autothrottle systems and engine trim systems can allow safe landings without the need to modify engine control computers. The further simplified "PCA Ultralite" system is much more difficult to use but can provide survivable landings with a minimum of airplane changes required. Simulations have shown that an airplane with all engines out on one wing can be controlled using the thrust of the other engines if the lateral center of gravity can be shifted toward the operating engines. Fuel transfer provides a suitable means of shifting the center of gravity on some airplanes. Engine thrust response and control precision has been adequate in all applications studied.

REFERENCES

1. Burcham, Frank W., Jr., Trindel A. Maine, C. Gordon Fullerton, and Lannie Dean Webb, *Development and Flight Evaluation of an Emergency Digital Flight Control System Using Only Engine Thrust on an F-15 Airplane*, NASA TP-3627, 1996.
2. Burcham, Frank W., Jr. and C. Gordon Fullerton, *Controlling Crippled Aircraft—With Throttles*, NASA TM-104238, 1991.
3. Gilyard, Glenn B., Joseph L. Conley, Jeanette Le, and Frank W. Burcham, Jr., "A Simulation Evaluation of a Four-Engine Jet Transport Using Engine Thrust Modulation for Flightpath Control," AIAA-91-2223, June 1991.
4. Powers, Sheryll Goecke, compiler, *An Electronic Workshop on the Performance Seeking Control and Propulsion Controlled Aircraft Results of the F-15 Highly Integrated Digital Electronic Control Flight Research Program: Proceedings of the Electronic Workshop*, NASA TM-104278, 1995.
5. Gerren, Donna S., *Design, Analysis, and Control of a Large Transport Aircraft Utilizing Selective Engine Thrust as a Backup System for the Primary Flight Control*, NASA CR-186035, 1995.
6. Bull, John, Robert Mah, Gloria Davis, Joe Conley, Gordon Hardy, Jim Gibson, Matthew Blake, Don Bryant, and Diane Williams, *Piloted Simulation Tests of Propulsion Control as Backup to Loss of Primary Flight Controls for a Mid-Size Jet Transport*, NASA TM-110374, 1995.
7. Bull, John, Robert Mah, Gordon Hardy, Barry Sullivan, Jerry Jones, Diane Williams, Paul Soukup, and Jose Winters, *Piloted Simulation Tests of Propulsion Control as Backup to Loss of Primary Flight Controls for a B-747-400 Jet Transport*, NASA TM-112191, 1997.
8. Burcham, Frank W., Jr., Trindel A. Maine, John J. Burken, and Drew Pappas, "Development and Flight Test of an Augmented Thrust-Only Flight Control System on an MD-11 Transport Airplane," AIAA-96-3742, 1996. Also available as NASA TM-4745, 1996.
9. Kolano, Ed, "Fly by Fire," *Flight International*, Dec. 20, 1995, pp. 26-29.

10. Burken, John J., Frank W. Burcham, Jr., Trindel A. Maine, John Feather, Steven Goldthorpe, and Jeffrey A. Kahler, "Flight Test of a Propulsion-Based Emergency Control System on the MD-11 Airplane With Emphasis on the Lateral Axis," AIAA-96-3919, July 1996.

11. Burken, John J., Trindel A. Maine, Frank W. Burcham, Jr., and Jeffrey A. Kahler, "Longitudinal Emergency Control System Using Thrust Modulation Demonstrated on an MD-11 Airplane," AIAA-96-3062, July 1996.

12. Burcham, Frank W., Jr., John J. Burken, Trindel A. Maine, and C. Gordon Fullerton, *Development and Flight Test of an Emergency Flight Control System Using Only Engine Thrust on an MD-11 Transport Airplane*, NASA TP-97-206217, 1997.

13. Burcham, Frank W., Jr., John Burken, Trindel A. Maine, and John Bull, *Emergency Flight Control Using Only Engine Thrust and Lateral Center-of-Gravity Offset: A First Look*, NASA TM-4798, 1997.

REPORT DOCUMENTATION PAGE

Form Approved
OMB No. 0704-0188

Public reporting burden for this collection of information is estimated to average 1 hour per response, including the time for reviewing instructions, searching existing data sources, gathering and maintaining the data needed, and completing and reviewing the collection of information. Send comments regarding this burden estimate or any other aspect of this collection of information, including suggestions for reducing this burden, to Washington Headquarters Services, Directorate for Information Operations and Reports, 1215 Jefferson Davis Highway, Suite 1204, Arlington, VA 22202-4302, and to the Office of Management and Budget, Paperwork Reduction Project (0704-0188), Washington, DC 20503.

1. AGENCY USE ONLY (Leave blank)	2. REPORT DATE May 1998	3. REPORT TYPE AND DATES COVERED Technical Memorandum	
4. TITLE AND SUBTITLE Using Engine Thrust for Emergency Flight Control: MD-11 and B-747 Results		5. FUNDING NUMBERS WU 522-15-34-00-39-00-IDA	
6. AUTHOR(S) Frank W. Burcham, Jr., Trindel A. Maine, John J. Burken, and John Bull			
7. PERFORMING ORGANIZATION NAME(S) AND ADDRESS(ES) NASA Dryden Flight Research Center P.O. Box 273 Edwards, California 93523-0273		8. PERFORMING ORGANIZATION REPORT NUMBER H-2232	
9. SPONSORING/MONITORING AGENCY NAME(S) AND ADDRESS(ES) National Aeronautics and Space Administration Washington, DC 20546-0001		10. SPONSORING/MONITORING AGENCY REPORT NUMBER NASA/TM-1998-206552	
11. SUPPLEMENTARY NOTES Paper presented at the Aviation Safety Issues session of the American Society of Mechanical Engineers 43rd Gas Turbine and Aeroengine Technical Congress, Exposition, and Users Symposium, June 2-5, 1998, Stockholm, Sweden			
12a. DISTRIBUTION/AVAILABILITY STATEMENT Unclassified—Unlimited Subject Category 03		12b. DISTRIBUTION CODE	
13. ABSTRACT (Maximum 200 words) With modern digital control systems, using engine thrust for emergency flight control to supplement or replace failed aircraft normal flight controls has become a practical consideration. The NASA Dryden Flight Research Center has developed a propulsion-controlled aircraft (PCA) system in which computer-controlled engine thrust provides emergency flight control. An F-15 and an MD-11 airplane have been landed without using any flight control surfaces. Preliminary studies have also been conducted that show that engines on only one wing can provide some flight control capability if the lateral center of gravity can be shifted toward the side of the airplane that has the operating engine(s). Simulator tests of several airplanes with no flight control surfaces operating and all engines out on the left wing have all shown positive control capability within the available range of lateral center-of-gravity offset. Propulsion-controlled aircraft systems that can operate without modifications to engine control systems, thus allowing PCA technology to be installed on less capable airplanes or at low cost, are also desirable. Further studies have examined simplified "PCA Lite" and "PCA Ultralite" concepts in which thrust control is provided by existing systems such as autothrottles or a combination of existing systems and manual pilot control.			
14. SUBJECT TERMS B-747, Emergency control, MD-11, Propulsion control, Throttle-only-control		15. NUMBER OF PAGES 33	
		16. PRICE CODE A03	
17. SECURITY CLASSIFICATION OF REPORT Unclassified	18. SECURITY CLASSIFICATION OF THIS PAGE Unclassified	19. SECURITY CLASSIFICATION OF ABSTRACT Unclassified	20. LIMITATION OF ABSTRACT Unlimited