

1208
23X208



Development and Flight Test of an Emergency Flight Control System Using Only Engine Thrust on an MD-11 Transport Airplane

*Frank W. Burcham, Jr., John J. Burken, Trindel A. Maine, and C. Gordon Fullerton
Dryden Flight Research Center
Edwards, California*

National Aeronautics and
Space Administration

Dryden Flight Research Center
Edwards, California 93523-0273

October 1997

NOTICE

Use of trade names or names of manufacturers in this document does not constitute an official endorsement of such products or manufacturers, either expressed or implied, by the National Aeronautics and Space Administration.

Available from:

NASA Center for AeroSpace Information
800 Elkridge Landing Road
Linthicum Heights, MD 21090-2934
Price Code: A16

National Technical Information Service
5285 Port Royal Road
Springfield, VA 22161
Price Code: A16

CONTENTS

	<u>Page</u>
ABSTRACT	1
NOMENCLATURE	1
INTRODUCTION.....	2
HISTORY OF LOSS OF FLIGHT CONTROL ACCIDENTS AND INCIDENTS.....	3
B-747, Japan.....	3
DC-10, Sioux City, Iowa.....	3
DC-10, Windsor, Ontario, Canada.....	4
DC-10, Paris, France.....	4
L-1011, San Diego, California.....	4
B-52, Dayton, Ohio.....	4
B-52, Warner Robbins AFB, Georgia.....	5
C-5A, Saigon, Vietnam.....	5
F/A-18, Indiana.....	5
F/A-18, Sea of Japan.....	5
XB-70A, Edwards AFB, California.....	5
F-14A, Long Island, New York.....	6
Vietnam War Statistics.....	6
DESCRIPTION OF THE MD-11 AIRPLANE.....	6
Flight Control Systems.....	6
Cockpit and Avionics.....	7
Engines.....	10
Fuel System.....	12
Weight and Center of Gravity.....	12
Landing Gear.....	13
Instrumentation.....	13
MD-11 Simulation.....	13
PRINCIPLES OF THROTTLES-ONLY FLIGHT CONTROL FOR THE MD-11.....	14
Lateral-Directional.....	14
Longitudinal.....	14
Flightpath Angle Change Due to Speed Stability.....	16
Pitching Moment Due to Thrust-Line Offset.....	16
Flightpath Angle Change Due to the Vertical Component of Thrust.....	16
Phugoid.....	16
Relative Positions of Inlet to Exhaust Nozzle.....	19
Trim Speed Control.....	20
Speed Effects on Propulsive Control Power.....	26
Surface Float With Hydraulic Systems Off.....	26
Wing-Engine-Out With Lateral CG Offset Control.....	26
CONTROL MODES USING ENGINE THRUST.....	26
Manual Throttles-Only Control.....	26

PCA System Control	27
Lateral PCA Control	27
Track Mode	27
Bank Angle Mode	28
Longitudinal PCA Control	29
PCA IMPLEMENTATION	31
PCA SYSTEM OPERATION	31
PCA DEVELOPMENT AND TEST	32
Test Procedure	33
PCA System Flight Tests	34
PCA System Pitch Response	38
PCA System Track Response	38
Small Track Change	38
Large Track Change	38
Runway Approaches	40
PCA System Landings	42
PCA System Envelope Expansion	46
Speed Control	46
High-Altitude Testing	50
Tests at Aft CG	50
Three-Engine Dynamic Pitch Control	53
High-Airspeed Tests	53
Recovery From Upsets	53
PCA Operation With Two of Three Hydraulic Systems Off	53
PCA System Operation in the Enhanced Mode	58
PCA System Operation With All Hydraulics Off	58
PCA System and Rudder Mode	60
Rudder With Wing Engine Failed, PCA System Control	60
Sustained PCA Operation	60
Simulation-to-Flight Comparison	60
Pilot Comments	61
Need for Coupled Approach	61
PCA-ILS Approaches	61
ILS-Coupled PCA Landings	63
Demonstration Flights	72
Pilot PCA System Interface	76
Split Piloting Tasks	76
MD-11 Speed Control Example	76
Wing Engine and Lateral CG Offset	79
Unfamiliar Crew PCA System Test	81
FUTURE APPLICATION OF A PCA SYSTEM	85
CONCLUSIONS	85
LESSONS LEARNED	86
REFERENCES	87

TABLES

1. PCA system pilots	34
2. PCA test flights of MD-11	35
3. PCA pilots and observers in MD-11	74

FIGURES

1. McDonnell Douglas MD-11 test airplane	6
2. MD-11 cockpit and avionics	8
3. Thrust-EPR relationship for the PW4460 engine	11
4. Response of a PW4460 engine in the MD-11 to a step throttle increase, flaps up, gear down, PCA not engaged	11
5. Flight (minimum) idle and approach idle throttle snap to full power, PW4460 engine, sea-level-static conditions	12
6. Gross weight, fuel weight, and longitudinal center of gravity (CG) for MD-11 ship 560 PCA flight tests	13
7. Differential thrust open-loop step response, MD-11, 220 kn, 15,000 ft, flaps up, gear down, center engine idle, and LSAS and yaw dampers off	15
8. Response to open-loop step throttle increase, MD-11, LSAS off, center engine idle, PCA off, gear down, flaps up, 15,000 ft	17
9. MD-11 phugoid oscillation	18
10. Effect of airspeed, gross weight (GW), and CG on stabilizer position, zero flaps/slats	21
11. MD-11 PCA system	27
12. Flight control panel and primary flight display showing PCA flightpath and track mode selection	28
13. MD-11 PCA bank and V/S mode selection and annunciation	29
14. MD-11 PCA longitudinal control law center-engine modes (shaded blocks are changed from two-engine mode)	30
15. Response of MD-11 to open-loop step throttle inputs, PCA off, center engine idle, LSAS off, yaw dampers off, landing gear down	36
16. MD-11 airplane and flight deck simulator response to PCA flightpath thumbwheel step commands, gear down, Flaps 28, 10,000 ft, center engine idle	39
17. MD-11 PCA small track change response; original and improved gains, 12,000 ft, airspeed = 170 kn, gear down, Flaps 28, center engine idle	40
18. Time history of MD-11 PCA track change of 80°, gear down, Flaps 28, center engine at idle	41
19. Time history of MD-11 Flight Deck Simulation PCA landing, Flaps 28, no wind or turbulence	42

20.	Time history of first PCA landing, Flaps 28, 180 kn, light turbulence, pilot A	44
21.	Time history of second PCA landing, airspeed = 175 kn, Flaps 28, light turbulence with occasional thermals, no control surface movement, pilot A	45
22.	Time history of pilot B's third PCA approach and go-around, slats extended, Flaps retracted, gear down, bank angle mode, light-to-moderate turbulence	47
23.	Time history of fourth approach by pilot B, 1.5° rudder offset, gear down, Flaps 28, track mode, light-to-moderate turbulence	48
24.	Time history of PCA approach and go-around, gear down, Flaps 28, first approach by demonstration pilot E, smooth air	49
25.	MD-11 PCA system design and flight test envelope	50
26.	Time histories of three-engine PCA speed control mode, gear and flaps up	51
27.	Time history of MD-11 flightpath steps, three-engine dynamic longitudinal mode, 17,000 ft, gear down, Flaps 28	54
28.	Time history of PCA system recovery from a 7° dive/45° bank upset condition, gear and flaps up, no flight control movement	55
29.	FDS time history of MD-11 PCA upset and recovery, 200 kn, 4800 ft AGL, gear and flaps up, center engine idle	56
30.	Time history of MD-11 PCA operation with hydraulic systems 2 and 3 off, three of four ailerons floating, 220 kn, 10,000 ft, gear up, flaps up, CG = 31 percent, speed control mode on	57
31.	Time history of MD-11 PCA operation with all hydraulic systems turned off, flaps up	59
32.	Ground track and ILS approach information for Edwards AFB and USAF Plant 42 at Palmdale	62
33.	PCA ILS-coupled approach procedure and displays. Track of 203° set up to intercept Edwards ILS localizer, flightpath level at 3800 ft MSL to be below glideslope, APPR/LAND button pushed to arm coupled approach logic	63
34.	Time history and pilot views for PCA ILS-coupled approach and landing, Flaps 28, winds 260° at 6 kn, smooth air, center engine idle, no flight control movement, pilot A	64
35.	Time history of PCA ILS-coupled approach and hands-off landing, Flaps 28	66
36.	Time history of PCA ILS-coupled approach and go-around, flaps and slats retracted, landing gear down, center engine idle, 1.5 dots below nominal glideslope, smooth air, pilot A	68
37.	Time history of ILS-coupled approach, three-engine dynamic pitch mode, Flaps 28, PCA disengaged at 50 ft AGL before normal landing, pilot A	69
38.	Overlay of three MD-11 PCA ILS-coupled final approaches. Flaps 28, gear down, light winds, no turbulence	70
39.	Time history of MD-11 flight deck simulation ILS-coupled landing, severe turbulence, wind 270° at 15 kn, two-engine pitch mode, Flaps 28	71
40.	Simulation results of MD-11 PCA ILS-coupled landing dispersion, Flaps 28, two-step autoflare at 130 and 30 ft AGL; Honeywell simulation, 100 landings	72

41. Time history of PCA demonstration pilot manual throttles-only control and PCA engagement, Flaps 28, gear down	73
42. Analytical trim speed variation with GW, CG, landing gear, and center-engine thrust setting. Initial conditions: 330 kn climb, 25 percent CG, gear and flaps up.	77
43. Analytical trim speed variation with GW, CG, landing gear, and center-engine thrust setting. MD-11 initial conditions: 285 kn high altitude cruise, 31 percent CG	78
44. MD-11 lateral CG offset compared with total fuel quantity and location	79
45. Time history of fuel transfer and lateral CG offset, MD-11 FDS. Initial wing fuel tank quantities approximately 31,000 lb	80
46. Effect of lateral CG offset on EPR on the engine 3 required for wings-level flight, flaps and slats up, gear up, altitude \approx 10,000 ft, gross weight \approx 400,000 lb, center engine idle	81
47. Time history of response to right throttle step inputs, MD-11 FDS, 205 kn, altitude = 7500 ft, gear and flaps up, dampers off, 35 in. lateral CG offset	82
48. MD-11 FDS with left engine idle, lateral CG offset 31 in. right, gear and flaps up, PCA lateral track mode active, 15,000 ft, GW = 380,000 lb	83
49. MD-11 PCA FDS with left engine at idle, lateral CG 31 in. right, PCA lateral mode engaged, no flight control inputs, all dampers off, gear and flaps up, center throttle step increase and bank angle feedback gain decrease.	84

ABSTRACT

An emergency flight control system that uses only engine thrust, called the propulsion-controlled aircraft (PCA) system, was developed and flight tested on an MD-11 airplane. The PCA system is a thrust-only control system, which augments pilot flightpath and track commands with aircraft feedback parameters to control engine thrust. The PCA system was implemented on the MD-11 airplane using only software modifications to existing computers. Results of a 25-hr flight test show that the PCA system can be used to fly to an airport and safely land a transport airplane with an inoperative flight control system. In up-and-away operation, the PCA system served as an acceptable autopilot capable of extended flight over a range of speeds, altitudes, and configurations. PCA approaches, go-arounds, and three landings without the use of any normal flight controls were demonstrated, including ILS-coupled hands-off landings. PCA operation was used to recover from an upset condition. The PCA system was also tested at altitude with all three hydraulic systems turned off. This paper reviews the principles of throttles-only flight control, a history of accidents or incidents in which some or all flight controls were lost, the MD-11 airplane and its systems, PCA system development, operation, flight testing, and pilot comments.

NOMENCLATURE

AFS	autoflight system
AGL	above ground level (radar altitude)
CG	center of gravity, percent of mean aerodynamic chord (fig. 1)
EPR	engine pressure ratio
FADEC	full-authority digital engine control
FCC	flight control computer
FCP	flight control panel on cockpit glareshield
FDS	flight deck simulator
FPA	flightpath angle
G/S	glideslope (longitudinal part of ILS command)
GW	gross weight, lb
HDG	heading (magnetic direction that the airplane points toward)
IAS	indicated airspeed, knots
IFR	instrument flight rules
ILS	instrument-landing system
LOC	localizer (lateral part of ILS command)
LSAS	longitudinal stability augmentation system
MCDU	multifunction control and display unit
MDA	McDonnell Douglas Aerospace (St. Louis, Missouri)
ND	navigation display
PCA	propulsion-controlled aircraft
PFD	primary flight display
TOGA	takeoff-go-around

TRK	track angle (magnetic heading of ground track)
V/S	vertical speed
VFR	visual flight rules

INTRODUCTION

In the past 25 years, crews of many aircraft types, including B-747, L-1011, DC-10, B-52, and C-5A, have experienced major flight control system failures, and have had to use throttles for emergency flight control. In most cases, a crash has resulted; the B-747, DC-10, and C-5A crashes claimed more than 1200 lives (ref. 1).

To investigate the use of engine thrust for emergency flight control, the National Aeronautics and Space Administration's Dryden Flight Research Center at Edwards, California, is conducting flight, ground simulator, and analytical studies. One objective is to determine how much control is available with manual manipulation of engine throttles for various classes of airplanes. Tests in simulation have included B-720, B-747, B-727, MD-11, C-402, C-17, F-18, and F-15 airplanes, and, in flight, B-747, B-777, MD-11, T-39, Lear 24, F-18, F-15, T-38, and PA-30 airplanes. The pilots use differential throttle control to generate sideslip, which through the dihedral effect results in roll. Symmetric throttle inputs also are used to control flightpath.

These tests show that sufficient control capability exists for all tested airplanes to maintain gross control; the control of both flightpath and track angle is possible to within a few degrees. For all airplanes tested, these studies also show the extreme difficulty of making a safe runway landing using only manual throttles-only control (ref. 2). This difficulty primarily results from weak control moments, slow engine response, and problems in controlling oscillatory modes in the pitch (phugoid) and lateral (dutch-roll) axes.

To provide a safe landing capability, NASA Dryden engineers and pilots conceived and developed a propulsion-controlled aircraft (PCA) system that uses only computer-controlled (augmented) engine thrust for flight control. A PCA system uses pilot flightpath and heading or bank-angle inputs and airplane sensor feedback parameters to provide appropriate engine thrust commands for emergency flight control. This augmented system was first evaluated on a B-720 transport airplane simulation (ref. 3). Later, simulation studies and flight tests were conducted on an F-15 airplane to investigate throttles-only control (ref. 4), and to investigate the in-flight performance of a PCA system (ref. 1). McDonnell Douglas Aerospace (MDA) (St. Louis, Missouri) developed and implemented the PCA system flight hardware and software. Flight testing included actual landings using PCA control (ref. 5). PCA technology was also successfully evaluated using a simulation of a conceptual megatransport (ref. 6). Another major PCA simulator study was conducted at NASA Ames using the advanced concepts flight simulator (ref. 7) and the B-747 simulator (ref. 8). More than 700 PCA approaches and landings were flown by more than 20 government, industry, and airline pilots. Simulator studies of a PCA system on a C-17 were also successfully conducted.

After the successful completion of the F-15 PCA research, MDA (Long Beach, California), Pratt & Whitney Aircraft (East Hartford, Connecticut), Honeywell, Inc. (Phoenix, Arizona), and NASA Dryden developed and tested a concept demonstration PCA system for the MD-11 transport airplane. The objectives were to develop a PCA control system, to demonstrate controlled up-and-away flight over a portion of the flight envelope from 150 to 250 kn below 15,000 ft, and to make approaches to a runway to 20 ft above ground level (AGL) that could result in a survivable landing, with a sink rate of less than 10 ft/sec and a bank angle of less than 7° and within 50 ft of runway centerline. A goal was to make actual PCA landings. To make the PCA demonstration applicable to the many transports with two wing-mounted engines, the MD-11 PCA system primarily employed only the wing-mounted engines. In addition, control modes that use the added capability of the tail-mounted engine were developed. The PCA system that was developed and tested uses only software changes to existing digital systems on the MD-11.

In more than 25 hr of testing, the PCA system exceeded the objectives, serving as an acceptable autopilot and performing landings without conventional flight controls (ref. 9). Later tests studied PCA operation over the entire flight envelope, in upset conditions, with all hydraulic systems turned off, and coupled to an instrument-landing system (ILS) for hands-off landings. Sixteen pilots flew PCA demonstration flights (ref. 10). Reference 11 gave an overview of the MD-11 PCA program. Reference 12 gave an analysis of the lateral control system design and performance, reference 13, the longitudinal control system details, and reference 14, details of the hardware architecture, software development, and testing. Reference 15 summarized comments of the project pilot.

This paper presents the following:

- A history of the MD-11 PCA project
- A summary of accidents or incidents in which engine thrust was or could have been used
- The principles of throttles-only flight control for a subsonic transport
- A description of the MD-11 airplane
- Development of the PCA system for the MD-11
- A description of the control laws
- Flight test results and pilot comments

The chronology of the development and flight test sequence is preserved to illustrate and document the process used.

HISTORY OF LOSS OF FLIGHT CONTROL ACCIDENTS AND INCIDENTS

Many accidents and incidents have resulted from major flight control failures in which the crew either did or could have used throttles for emergency flight control (ref. 1).

B-747, Japan

In 1985, a four-engine Boeing 747 aircraft, Japan Airlines flight 123, experienced a total hydraulic system loss as a result of a failure in an aft cabin pressure bulkhead. Most of the vertical fin was also lost. After the failure, the aircraft remained essentially trimmed, with persistent dutch roll and phugoid oscillations. The throttles and electrically driven flaps were the only usable devices for control. The B-747 was flown for more than 30 min using throttle control, but the crew was not able to effectively control the airplane and eventually hit a mountain (ref. 16). More than 520 lives were lost.

DC-10, Sioux City, Iowa

In July 1989, a McDonnell Douglas DC-10 trijet, United Airlines flight 232, in cruise flight suffered an uncontained tail engine failure that caused the loss of all hydraulics. After the failure, the airplane trimmed at approximately 210 kn with a significant yaw caused by damage to the center-engine nacelle. The crew learned to achieve gross control under extremely difficult circumstances using wing engine throttles for control; the right-engine thrust was required to be about twice the left-engine thrust to hold wings level. In spite of these difficulties, the crew did reach the airport at Sioux City, Iowa. Not enough control precision was available for a safe landing; the phugoid was not well damped. However, an emergency crash landing saved 181 of 296 persons on board (ref. 17).

DC-10, Windsor, Ontario, Canada

In June 1972, a potentially serious DC-10 trijet incident occurred after a cargo door failed on American Airlines flight 96. The resulting decompression damaged controls to the tail. The center engine went to idle and had no control. The rudder was jammed with an offset, control of half of the elevator was lost, and the remaining half of the elevator had severe control cable binding. Electric but not mechanical stabilizer trim control was available, but the cockpit indicator showed no movement and the crew presumed it was inoperative and did not use it. With barely sufficient pitch and full roll capability remaining, the airplane landed safely. During landing rollout, with the rudder offset and no nose wheel steering control available, differential reverse thrust was required to keep the airplane on the runway, but it ran slightly off the runway just before stopping (ref. 18).

DC-10, Paris, France

In March 1974, a DC-10 trijet, Turkish Airlines flight 981, climbing out of Paris suffered a failure of the aft cargo door. The decompression buckled the cabin floor, breaking or stretching control cables to the tail. The airplane impacted the ground at high speed in nearly level flight, killing all 346 persons on board (ref. 19). Adding thrust to the wing engines possibly would have pulled the airplane out of the dive, although the trim condition might have been at a very high speed.

L-1011, San Diego, California

In April 1977, on a Lockheed L-1011 trijet, Delta Airlines flight 1080, one of the horizontal stabilizers jammed in the full trailing edge-up position before an instrument flight rules (IFR) departure out of San Diego. This failure resulted in a large nose-up pitching and rolling moment that almost exceeded the capability of the flight controls. The airplane was just about to stall in the clouds, when the captain, using amazing insight, retarded the wing engine throttles and firewalled the center engine. This action allowed him to regain enough control to maintain flight. The crew learned rapidly, continued to use the throttles to supplement the remaining flight controls, moved passengers forward to reduce the pitchup tendency, and completed a safe landing (ref. 20). A less capable crew would likely have not been able to save this airplane.

B-52, Dayton, Ohio

In May 1974, an eight-engine U.S. Air Force Boeing B-52H lost all tail hydraulic control because of a leak in a common drain line to the separate hydraulic reservoirs. The crew still had stabilizer trim for speed control and spoilers for roll control. For pitch, they used the throttles and airbrakes. All eight engines were functioning normally. The crew split the task, with one manipulating the throttles while another handled the airbrakes. The crew made a practice approach at 10,000 ft using these controllers and were satisfied that they could land.

At that point, the gear was lowered; the upset caused them to lose 8000 ft before regaining control. In spite of these control difficulties, the crew elected to try to land at Wright-Patterson AFB (near Dayton, Ohio). The phugoid was not adequately damped, and the aircraft hit the ground on the downswing of the phugoid. The impact broke off the nose section forward of the front landing gear. Fire consumed the rest of the airplane, but all eight crewmembers survived.

After this accident, several flights were flown to determine the controllability of the B-52 with this type of failure, and procedures were developed. The procedures call for a flaps-up landing at a higher speed, which improves the pitch response to airbrakes.

B-52, Warner Robbins AFB, Georgia

In 1981, a similar failure occurred on an Air Force B-52G. The procedure that resulted from the Dayton accident was followed, and a landing was attempted at Warner Robbins AFB. The airplane hit hard enough to crack the fuselage, but there were no injuries and the airplane was repaired.

C-5A, Saigon, Vietnam

In 1973, an Air Force Lockheed C-5A four-engine military transport was carrying 300 orphans on an evacuation flight in Vietnam (ref. 21). Climbing through 23,000 ft, the rear pressure bulkhead, which is part of the cargo-loading ramp, failed, causing secondary damage to the aft fuselage and loss of all hydraulic controls for the tail. The aircraft remained roughly in trim, and all wing-mounted control surfaces and flaps were still available. Pitch was controlled with throttles. The crew practiced using this control mode for 30 min, and commented on the difficulty in achieving precise control because of the slow response of the engines.

After a practice landing at 10,000 ft, the crew then tried an approach to the runway. When the landing gear was lowered at 5000 ft, a phugoid oscillation was excited, which caused ground impact 1.5 mi short of the runway. The airplane hit very hard, broke up, and was destroyed by fire. There were no survivors. As a result of this accident, extensive simulation studies were conducted. To this day, C-5 crews do simulator throttles-only practice to prepare for loss of hydraulic controls.

F/A-18, Indiana

In 1989, over Indiana, a U.S. Navy McDonnell Douglas F/A-18 twin-engine fighter had a failure of the dam seal in the right horizontal tail actuator, which caused loss of all hydraulic fluid from both systems. All flight control surfaces were then inoperative. The airplane initially remained in trim then experienced a slow rolloff to the right. When the roll reached 90°, the pilot ejected.

F/A-18, Sea of Japan

A Navy F/A-18 fighter experienced a failure of the left horizontal tail linear variable differential transformer position feedback indicator. This failure resulted in extreme actuator inputs of random size and timing. With the airplane uncontrollable in this mode, the pilot selected the backup mechanical control system, which operated normally but is not recommended for landing. After repeated tries to reselect the digital mode, each causing wild gyrations, the pilot reselected the mechanical system, went out over the ocean, and ejected.

XB-70A, Edwards AFB, California

In 1966, the six-engine Air Force XB-70A airplane was involved in a mid-air collision, which tore off both vertical tails. The airplane slowly diverged in yaw and entered a spin. One crewmember ejected but was injured, while the other was unable to eject and was killed. A PCA system should have been able to maintain control at least until all crewmembers could safely eject.

F-14A, Long Island, New York

The number 1 Navy Grumman F-14A twin-engine fighter airplane experienced cracks in titanium hydraulic lines on its first flight. On approach, the last hydraulic fluid was lost, and control was lost. The crew ejected safely.

Vietnam War Statistics

Historical data from Southeast Asia operations in the 1970–1980 time period show that, of the more than 10,000 aircraft lost, 18 percent were lost because of flight control failure. How many of these aircraft could have been saved with a PCA system is unknown.

DESCRIPTION OF THE MD-11 AIRPLANE

The MD-11 is a large, long-range, three-engine wide-body transport. The airplane, shown in figure 1, is 202 ft long and has a span of 170.5 ft. The test airplane, ship 560, was configured for flight test and had no interior furnishings other than data analysis and recording consoles.

Flight Control Systems

The MD-11 has a mechanical flight control system, with irreversible hydraulically actuated surfaces. Three independent systems provide hydraulic power. All essential control functions can be maintained on any one of these three systems. Dual elevators provide pitch control, and a hydraulic jackscrew-actuated horizontal stabilizer provides pitch trim. Inboard and outboard ailerons supplemented by wing spoilers provide roll control. Dual rudders

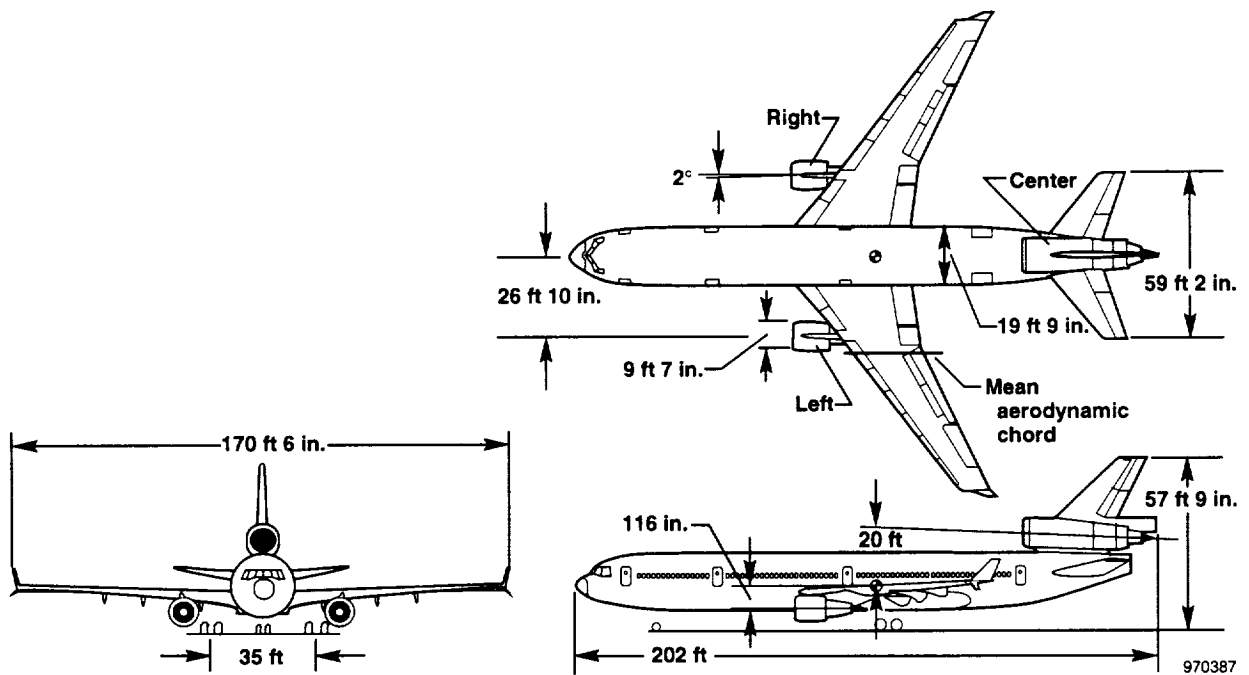

(a) Three-view.

Figure 1. McDonnell Douglas MD-11 test airplane.

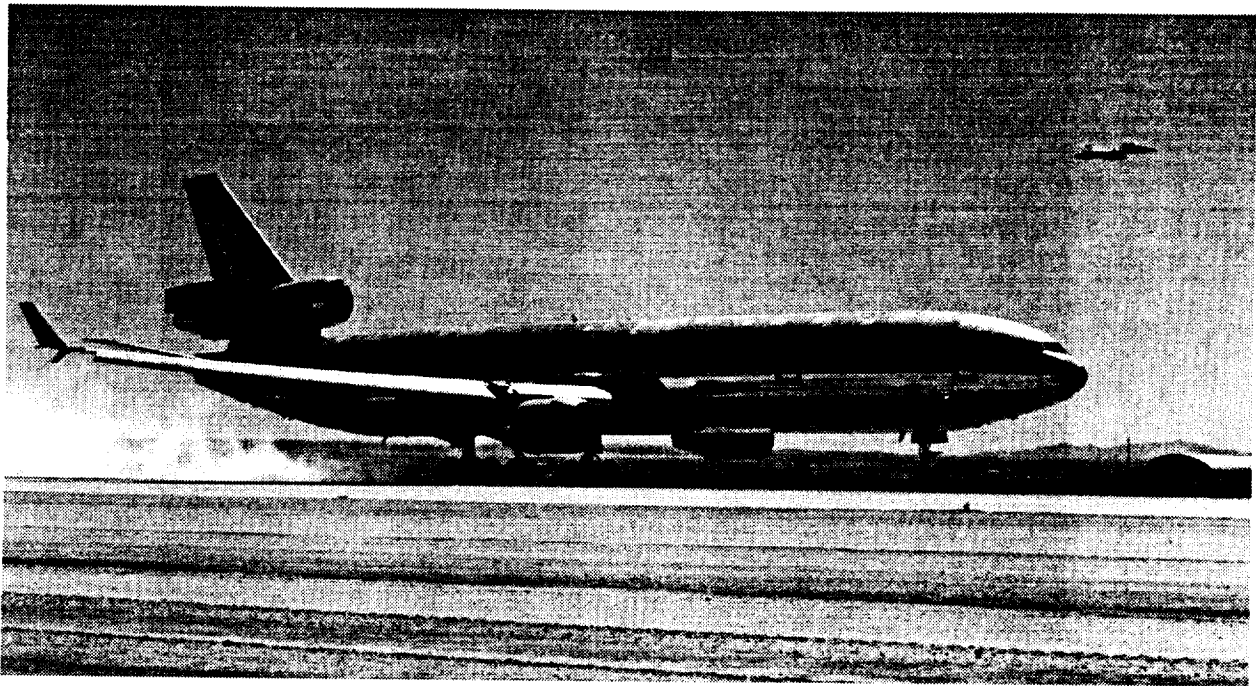

EC95 43247-04

(b) At touchdown.

Figure 1. Concluded

on a single vertical tail provide yaw control. In case of hydraulic failure, the stabilizer would effectively lock, and other surfaces would float.

The MD-11 is equipped with a hydraulically actuated wing leading and trailing edge high-lift system. Full-span slats are installed on the leading edge; these can be extended by moving the flap handle in the cockpit to the first detent. Moving the flap handle farther begins to extend the trailing edge flaps. For takeoff, flaps are in the range from 10° to 28° . For landing, maximum flap extension is 40° . In case of hydraulic failure, the leading edge slats would remain extended, the trailing edge flaps would slowly drift up.

The MD-11 incorporates an enhanced flight control mode with hydraulic fuses (shutoff valves) installed in hydraulic system number 3 so that control can be maintained in case an uncontained tail engine failure severs all three hydraulic systems in the tail. In this mode, if hydraulic systems 1 and 2 fail and the level in the system 3 reservoir drops below a preset level, the fuses close, maintaining hydraulic pressure to the wing leading edge slats, one aileron, and half of the stabilizer actuator. With this enhanced control capability, adequate control should be available for a safe landing.

Cockpit and Avionics

The standard MD-11 is equipped with an advanced, two-person cockpit. Figure 2(a) shows the electronic displays on the main panel, the glareshield flight control panel, and the automated systems management controls and displays on the overhead panel. Figure 2(b) shows more detail on the overhead panel. Of particular interest for this flight test are the MD-11 dual longitudinal stability augmentation systems (LSAS), the dual yaw dampers, the fuel system control panel, the hydraulic system control panel, and the alternate full-authority digital engine control (FADEC) switches. The autoflight system (AFS) includes autopilot, autothrottle and speed control, stall warning,

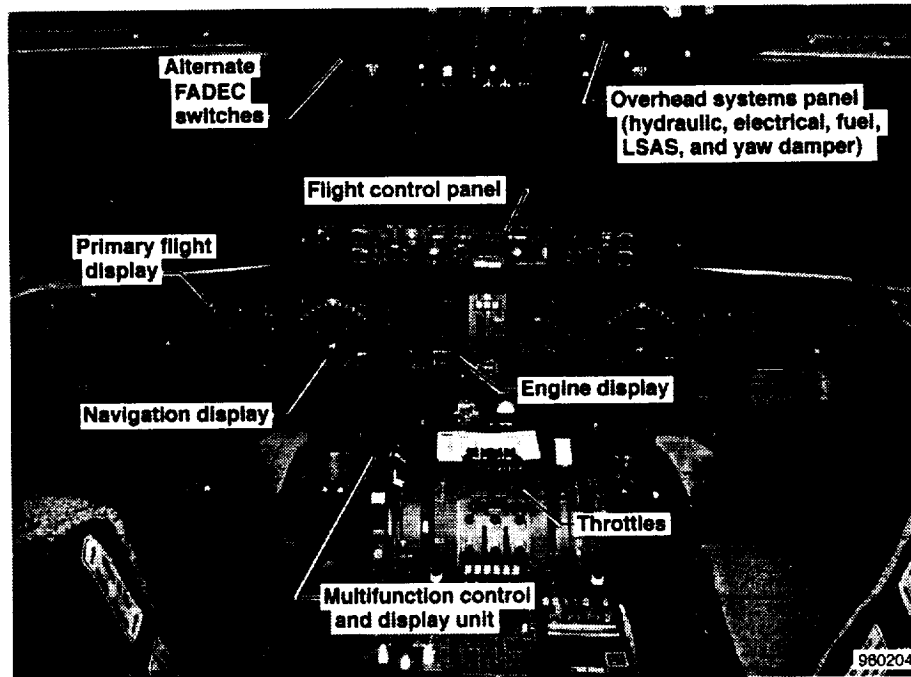

(a) Flight deck of the MD-11 flight deck simulator.

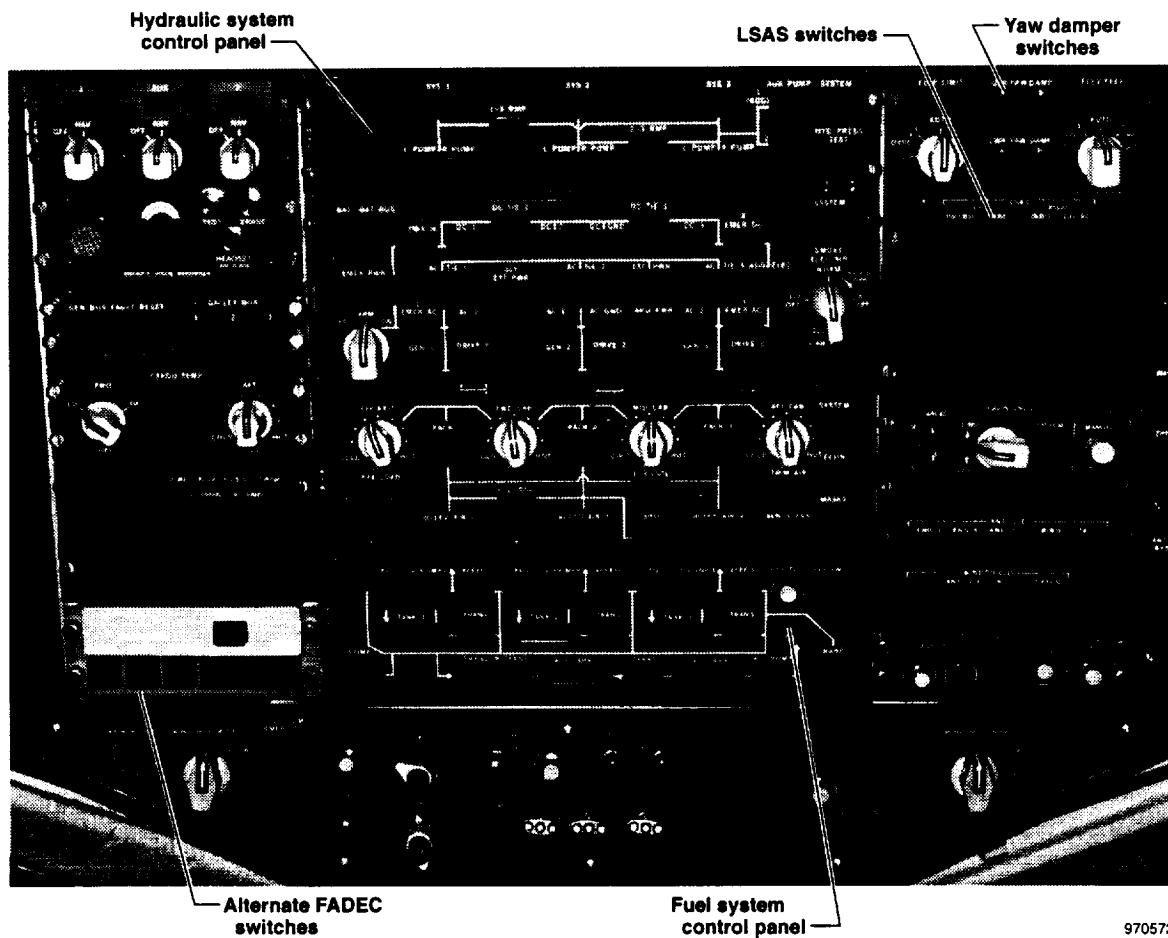

(b) MD-11 cockpit overhead panel.

Figure 2. MD-11 cockpit and avionics.

turn coordination, flap limiting, windshear detection, and other features. A flight management system integrates autopilot, autothrottle, navigation, and autoland functions. The crew communicates with the flight management system using the three multifunction control and display units (MCDUs) on the center pedestal.

Figure 2(c) shows the AFS crew interface and display. The glareshield flight control panel (FCP) is the flight crew's interface into the autoflight modes. Beginning from the top left, the figure shows a pushbutton to toggle between indicated airspeed (IAS) and Mach, and a speed select knob that normally commands the autothrottle speed or Mach hold. For lateral control, a Heading/Track (HDG/TRK) knob (selectable to integer degree values) is used to select the desired heading or track. The HDG/TRK button toggles between heading mode and track mode. Bank angle may be limited with the knob surrounding the HDG/TRK knob. In the center of the panel are the AFS override switches that allow selection of either of the two autopilots. The Autoflight button can engage the AFS. The approach and land (APPR/LAND) button can arm a coupled approach mode. The altitude capture window has a toggle switch to select feet or meters. On the right is a pitch thumbwheel for commanding flightpath angle (FPA),

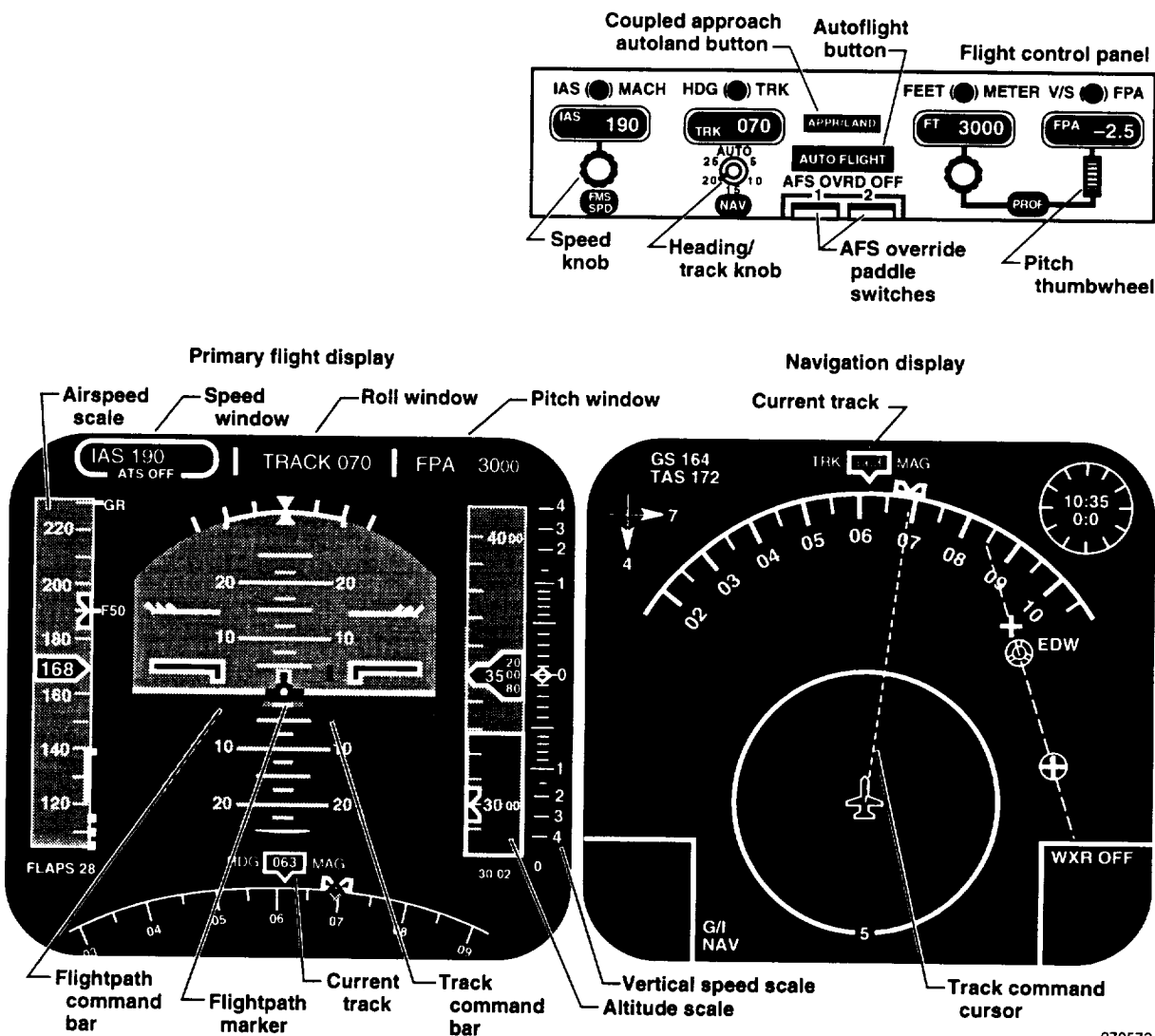

970573

(c) Autoflight system crew interface and displays, autopilot engaged in TRACK and FPA mode, autothrottle not engaged. Current track is 063°, commanded track is 070°. Current flightpath is 0°, commanded flightpath is -2.5°.

Figure 2. Concluded.

selectable to a tenth of a degree, or vertical speed (V/S), selectable to 100 ft/min. The V/S–FPA button toggles between the vertical speed mode and flightpath angle mode. The pitch thumbwheel and HDG/TRK knobs have mechanical functions that, if moved rapidly, quickly engage a higher gear ratio.

The primary flight display (PFD) includes annunciation of selected modes at the top. On the left, the Speed window indicates whether the commanded speed is in knots (IAS) or Mach; in this case, the figure shows a commanded IAS of 190 kn. In the center, the Roll window is the commanded lateral mode (showing a track of 070° in this case). On the right, the Pitch window indicates the active pitch mode (shown here as FPA) and the commanded altitude (shown at 3000 ft). On the PFD, the flightpath marker shows the current flightpath, while the flightpath command bar displays what has been commanded. If the V/S mode had been selected, the commanded V/S bug would be displayed on the V/S scale on the right of the PFD. Track command bars are also shown on the PFD, along with a bug on the compass at the bottom. The IAS command is shown as a bug on the airspeed scale on the left of the PFD.

The navigation display in figure 2(c) shows the actual and commanded track and the ground location of various navigational aids and projected flightpaths. Information displayed includes range in nautical miles, winds, ground speed, and true airspeed.

In addition, a takeoff–go-around (TOGA) button is on the center throttle. When pushed on the ground, this button advances the throttles to a predetermined takeoff thrust setting. When pushed in flight, this button levels the wings and commands a 3° climb.

Engines

The MD-11 is powered by three high-bypass-ratio turbofan engines in the 60,000-lb thrust class. As shown in figure 1, two engines are mounted in underwing pods, 116 in. below and 331 in. outboard of the nominal CG, toed in 2° and up 1.5°. The third engine is at the base of the vertical tail 178 in. above the vertical CG and inclined 2.5° nose up. The test airplane was equipped with PW4460 engines with 60,000 lb of thrust each. These engines have FADEC systems. The crew normally controls the engines with electronic throttles that command a power setting based on engine pressure ratio (EPR). At sea level, EPR varies from just below 1.0 at idle to about 1.65 at maximum power; thus, each 0.1 EPR is about 10,000 lb of thrust. Figure 3 shows thrust as a function of EPR for low-speed operation. At Mach 0.2, approach idle is an EPR of about 1.04, with a thrust of approximately 5000 lb per engine. Flight idle with an EPR of about 0.99 has a thrust of approximately 2000 lb per engine.

The FADECs normally accept small (± 5 percent) EPR trim commands from the flight management system to closely maintain engine limits or thrust settings and eliminate the need for throttle stagger to match engines to a given EPR. The alternate FADEC switches on the overhead panel select the FADEC control to backup software that does not require or accept any data bus inputs.

As is typical for high-bypass turbofan engines, thrust response near idle power is initially very slow. After reaching about 20 percent of full thrust, the thrust response improves dramatically, and in the mid-range, has a time constant of approximately 1 sec. Figure 4 shows a flight time history of a small thrust step for one engine from a throttle angle of 58° to 65°. Note that the thrust has reached about 65 percent of the step change in a second, and that the maximum rate is about 20,000 lb thrust per second. When a step throttle reduction is performed, the thrust decay shows similar nonlinear effects: rapid at the higher thrust levels, but slow near idle thrust.

An approach idle setting raises the idle speed to improve engine response when the flaps are extended more than 27°. Figure 5 shows an offline engine simulation of an engine idle to full power snap acceleration beginning from flight-idle and approach-idle power settings at sea-level-static conditions. At flight (minimum) idle

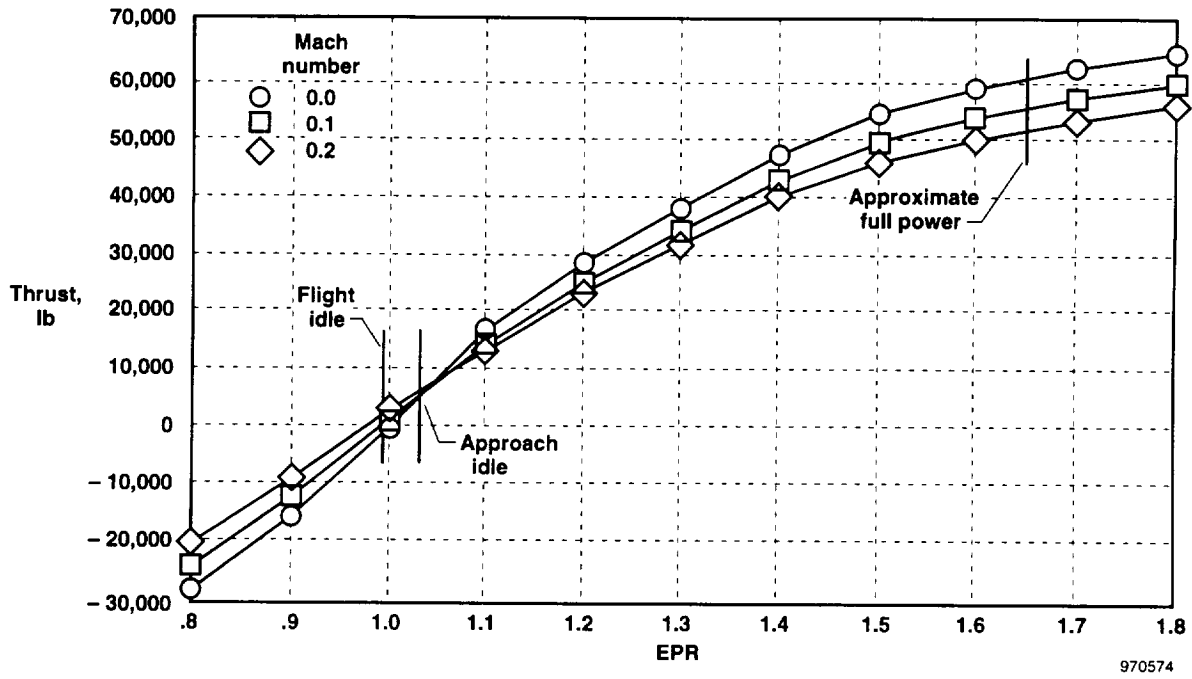

Figure 3. Thrust-EPR relationship for the PW4460 engine.

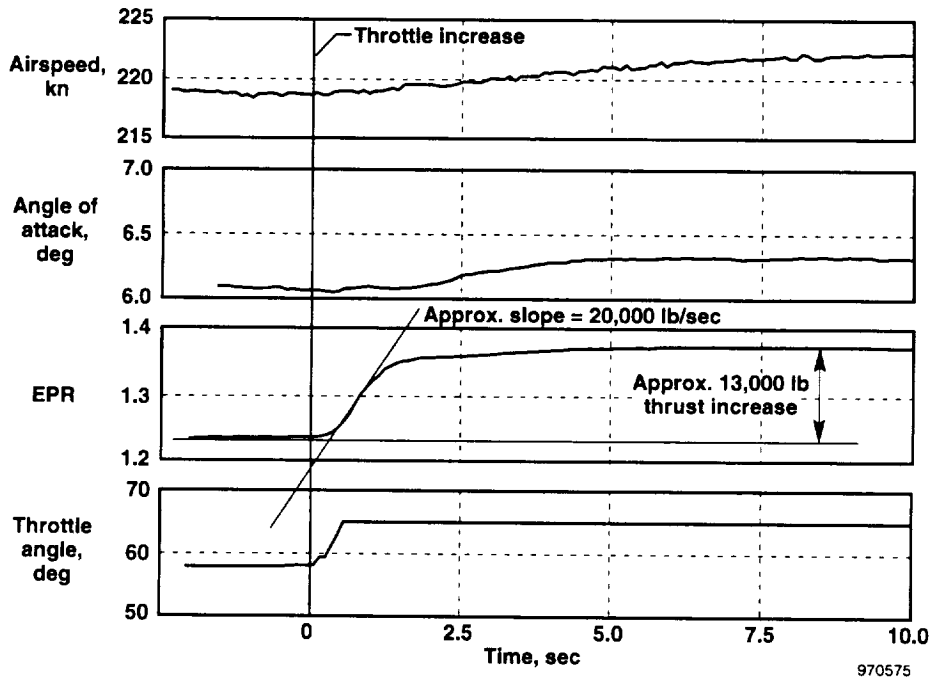

Figure 4. Response of a PW4460 engine in the MD-11 to a step throttle increase, flaps up, gear down, PCA not engaged.

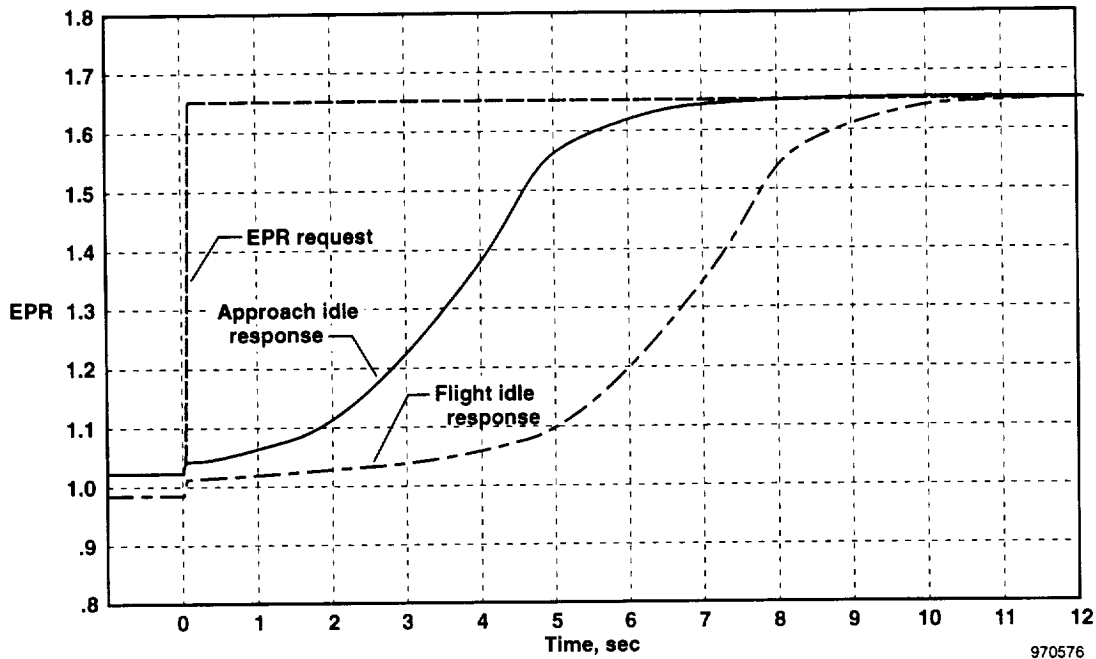

Figure 5. Flight (minimum) idle and approach idle throttle snap to full power, PW4460 engine, sea-level-static conditions.

(EPR = 0.99), 5 sec is required to reach an EPR of 1.1; while at approach idle (EPR = 1.04), the time to reach an EPR of 1.1 is less than 2 sec.

Fuel System

The MD-11 is equipped with fuel tanks in the wings, center fuselage, and horizontal tail. Maximum fuel quantity is 259,000 lb. Each wing tank holds 42,000 lb of fuel; the remaining fuel is in the center fuselage in main and auxiliary tanks and in the tail tank. The fuel management system normally controls fuel distribution. This system maintains a programmed CG schedule, but fuel may also be manually transferred among tanks. After takeoff, fuel is normally transferred to the tail tank to move the CG aft. The left- and right-wing tanks are maintained at approximately equal weights. In an emergency, fuel may be dumped overboard until a total of 40,000 lb remains. A manual fuel switch disables automatic fuel transfer and CG control, and allows fuel to be transferred manually.

Weight and Center of Gravity

The standard MD-11 with a full payload of 122,700 lb has a zero-fuel weight of 400,000 lb; maximum gross weight is 630,000 lb. Maximum landing weight is 430,000 lb.

The longitudinal CG is given in percentage of mean aerodynamic chord (fig. 1). At cruise altitude, the fuel management system transfers fuel to the tail tank that maintains the CG at an airline-selectable aft limit of approximately 32 percent. For takeoff and landing, the CG is normally in the range of 20 to 24 percent; 12 percent is the forward limit.

Figure 6 shows the weight and CG of MD-11 ship 560 for a typical flight test. Zero fuel weight plus ballast was 303,000 lb at a CG of 19.5 percent. With 149,000 lb of fuel (both wing tanks and the center fuselage main tank full),

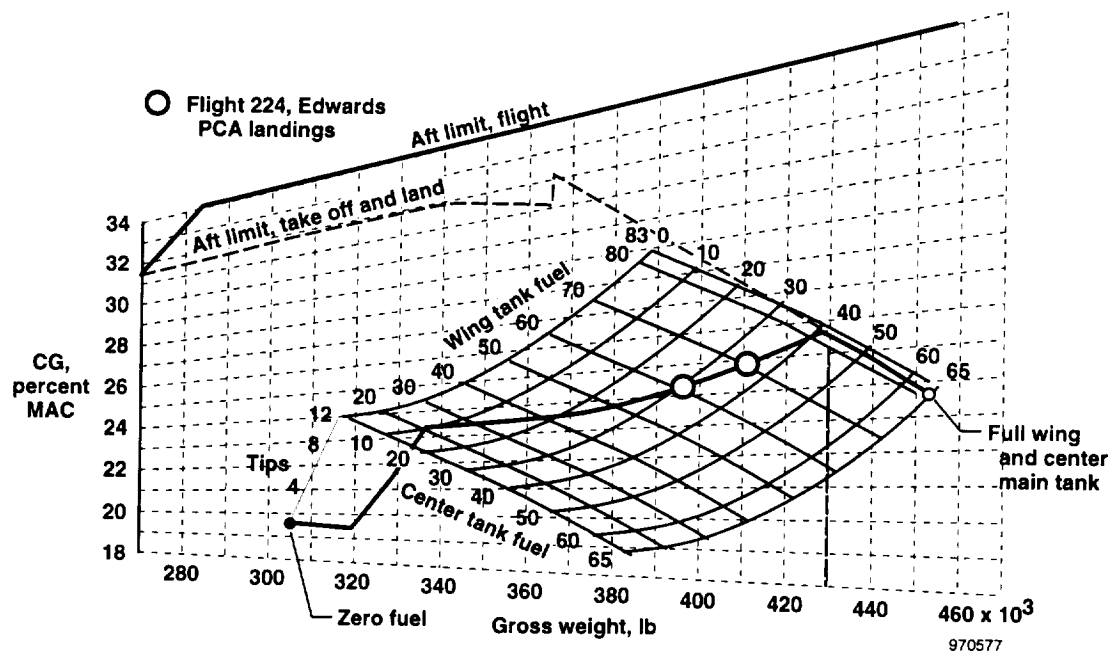

Figure 6. Gross weight, fuel weight, and longitudinal center of gravity (CG) for MD-11 ship 560 PCA flight tests.

the takeoff gross weight was 452,000 lb at a CG of 23.6 percent. Lateral CG is normally maintained near zero, but if one wing tank is full and the other is empty, the lateral CG can be displaced by approximately 4 ft.

Landing Gear

The MD-11 is equipped with a steerable nosewheel and three main landing gears. The gears are normally operated with aircraft hydraulic systems. An alternate system independent of the hydraulic system can lower the gears, leaving the gear doors down and wheel wells open. Limited braking may be obtained with inoperative hydraulic systems using brake system hydraulic accumulators. Maximum-rated tire speed is 204 kn. Maximum touchdown sink rate at maximum landing weight is 10 ft/sec.

Instrumentation

The test MD-11 was equipped with a large data acquisition system capable of displaying and recording several thousand parameters from the standard aircraft digital data buses. Parameters included all air data, engine, and inertial parameters as well as flight control system and PCA system parameters. An on-board, real-time, plotting and hardcopy capability was available. Cameras and voice recorders were installed in the cockpit to record the instrument panel view, the pilot's out-the-window view, and communications and pilot comments. Test instrumentation data consoles in the main cabin provided engineers with the ability to change, in real time, parameters that were being displayed or printed to hardcopy. Data were sampled 20 times/sec. No telemetry system was installed.

MD-11 Simulation

The MD-11 flight deck simulator (FDS), figure 2(a), used for most of the MD-11 PCA research, is a high-fidelity, fixed-base piloted simulator with actual flight hardware for many of the cockpit controls, systems, and

electronics. This simulator has a digital display projection system that can display southwestern U.S. visual scenes including Los Angeles International, Long Beach NAS, Edwards AFB, Yuma, and other airports. Data from simulator tests could be recorded for later analysis.

In addition, an IBM mainframe computer hosted a non-real-time batch version of the full MD-11 simulation. This nonlinear simulation was used for control system development and evaluation.

For flight control system and engine control system integration testing, the MD-11 bench simulation was used. The bench simulation allowed actual PCA software in FCCs and one FADEC to operate through the data buses, and used a database similar to the FDS. Pilot inputs could be simulated through a joystick interface. Linear models of the MD-11 were extracted from nonlinear simulations and used at MDA and NASA for control system design and analysis (refs. 12 and 13).

PRINCIPLES OF THROTTLES-ONLY FLIGHT CONTROL FOR THE MD-11

The following section uses examples from the MD-11 airplane to present the principles of throttles-only flight control for the MD-11. First, basic lateral-directional and longitudinal modes will be discussed. The later sections discuss airspeed control, speed effects on propulsive control power, surface float with hydraulics off, and a control concept with only one wing engine and an offset lateral CG.

Lateral-Directional

Differential thrust is effective in producing roll for most airplanes, including the MD-11. Differential thrust generates yaw (sideslip), in the direction of the turn. In addition, rolling moments are developed from the dihedral effect. Swept-wing airplanes also have an additional rolling moment that is a function of twice the wing sweep angle and the wing lift. A rolling moment may also be contributed from the vertical tail. All of these rolling moments normally are in the same direction as the yaw and result in the airplane rolling in the direction of the yaw. Proper modulation of the differential thrust allows the airplane to be rolled to a desired bank angle, which results in a turn and change in aircraft heading.

An open-loop throttle step response for the MD-11 is shown in figure 7 at 220 kn with gear down and flaps up. The commanded 10° throttle split results in about 20,000 lb of differential thrust and a roll rate averaging $1.5^\circ/\text{sec}$. The EPRs lag the throttle by about a second, and roll rate lags sideslip, which lags yaw rate. A lightly damped dutch roll mode is excited by this throttle step. Full differential thrust for the MD-11 at a speed of 150 kn yields a peak roll rate of approximately $8^\circ/\text{sec}$.

Longitudinal

Longitudinal pitch control from throttle changes is more complex, in part because more modes are being controlled. Several effects can occur:

1. Flightpath angle change due to speed stability
2. Pitching moment due to thrust-line offset
3. Flightpath angle change due to the vertical component of thrust
4. Phugoid

The following sections describe each effect in the order stated.

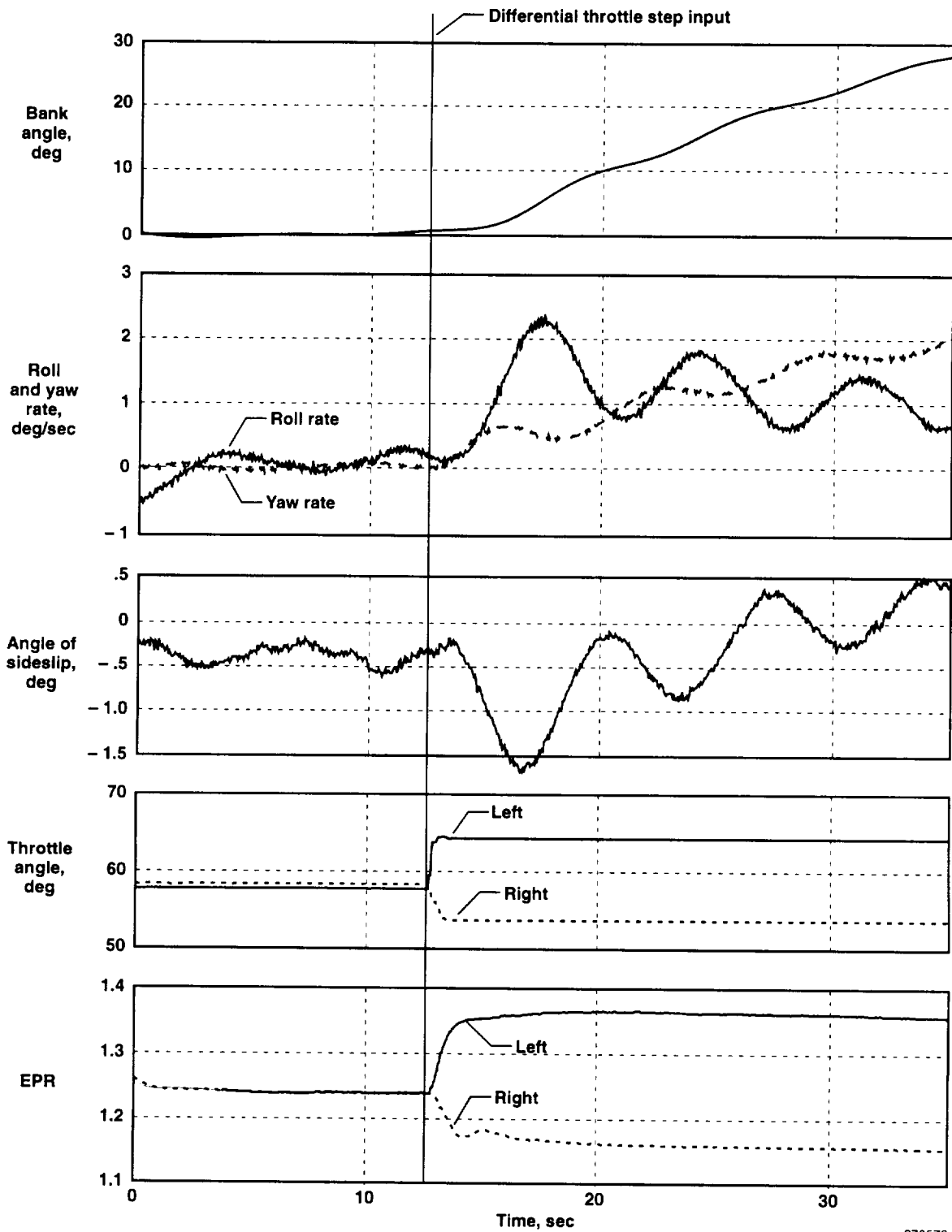

970578

Figure 7. Differential thrust open-loop step response, MD-11, 220 kn, 15,000 ft, flaps up, gear down, center engine idle, and LSAS and yaw dampers off.

Flightpath Angle Change Due to Speed Stability

Most stable airplanes, including the MD-11, exhibit positive speed stability. Over a short time (≈ 10 sec), a thrust increase causes a speed increase, which causes a lift increase. With the lift being greater than the weight, the airplane climbs. The long-term effect is oscillatory (see Phugoid section later).

Pitching Moment Due to Thrust-Line Offset

If the engine thrust line does not pass through the vertical CG, a pitching moment is introduced by thrust change. For many transport aircraft, the thrust line is below the vertical CG, and increasing thrust results in a desirable nose-up pitching moment and a subsequent angle-of-attack increase and pitch attitude increase.

For the MD-11, if all three engines are used equally, the resultant thrust line is near the vertical CG, and this effect is small. If only the wing engines are used, which are nearly 10 ft below the nominal vertical CG, the nose-up pitching moment is significant. The center engine of the MD-11 is approximately 20 ft above the vertical CG and causes a strong nose-down pitching moment with thrust increase.

Flightpath Angle Change Due to the Vertical Component of Thrust

If the thrust line is inclined to the flightpath, as is commonly the case, an increase in thrust increases the vertical component of thrust, which causes a vertical acceleration and a resulting increase in flightpath angle. For a given aircraft configuration, this effect increases as pitch attitude increases.

For the MD-11, the combined short-term effect of a thrust increase is to produce a nose-up flightpath response shown in figure 8; this figure is a time history of the step throttle increase of the wing engines at 220 kn. Thrust responds within about 1 sec. Pitch attitude and the resulting angle of attack increases about 0.3° , and airspeed increases for the first 12 sec. With the increased angle of attack, drag increases, and as pitch attitude increases, the component of weight along the flightpath becomes significant, decreasing airspeed.

When using only the wing-mounted engines for control, the pitching moment from thrust offset is the strongest component, and a throttle advance increases pitch attitude and angle of attack such that the long-term effect is an oscillatory climb at a reduced trim airspeed. The reverse is also true: A reduction in wing engine thrust causes a descent at increased airspeed.

Phugoid

The phugoid is the longitudinal long-period oscillation of an airplane. Phugoid is a motion in which kinetic and potential energy (speed and altitude) are traded; it may be excited by a pitch, thrust, or velocity change. For the MD-11, the bare airframe phugoid is lightly damped; figure 9(a) shows a flight example in light turbulence. This phugoid oscillation, with the same airplane configuration and flight conditions as in figure 4, was excited by a pullup, which results in a lightly damped oscillatory climb at constant throttle. Note that the angle of attack changes and is 180° out of phase with airspeed. With throttles fixed, a slight oscillation in EPR occurred from the changing flight conditions. The speed is low enough that Mach effects are not significant. The EPR and thrust increase with decreasing airspeed contributes to destabilizing the phugoid.

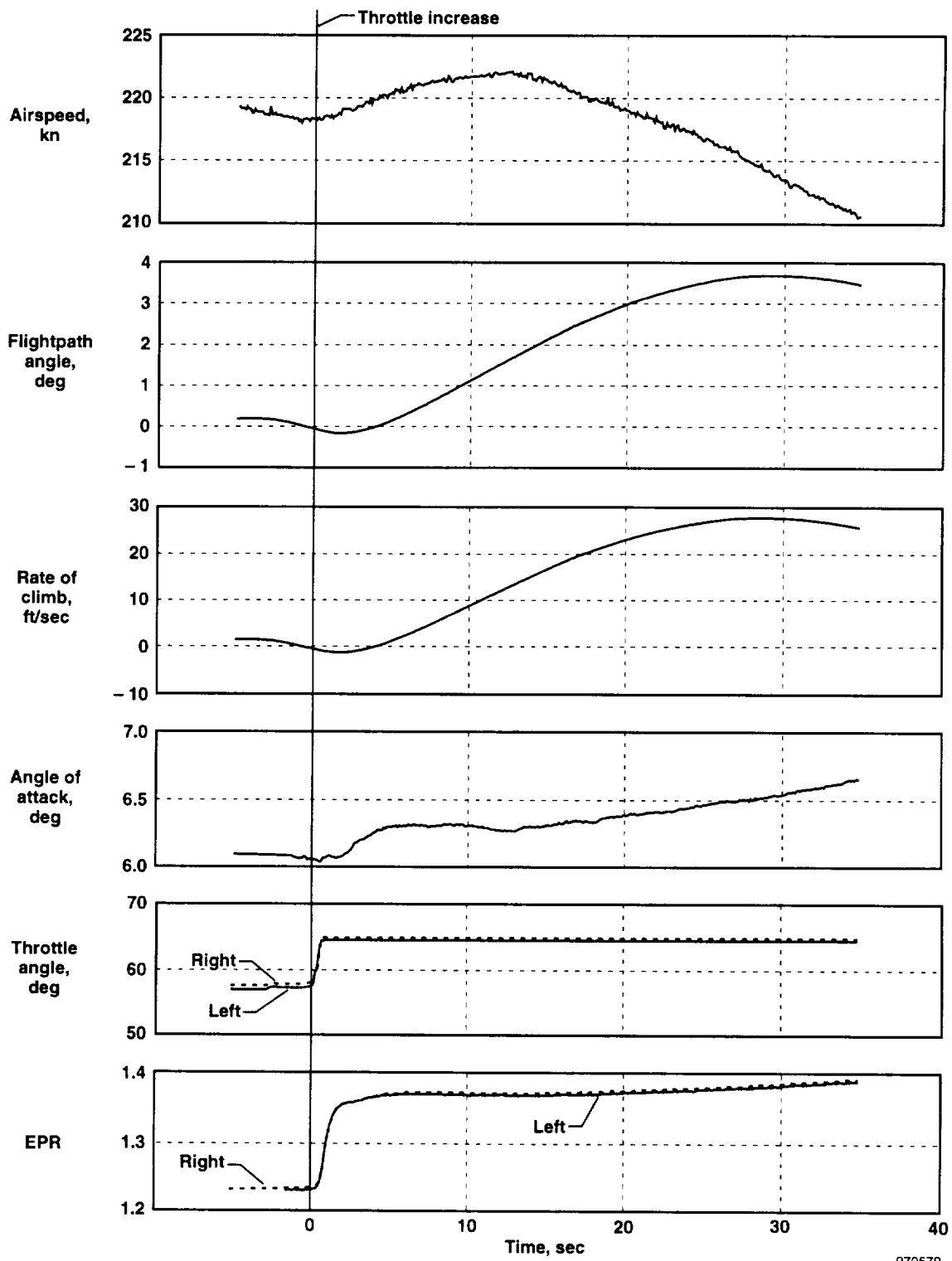

970579

Figure 8. Response to open-loop step throttle increase, MD-11, LSAS off, center engine idle, PCA off, gear down, flaps up, 15,000 ft.

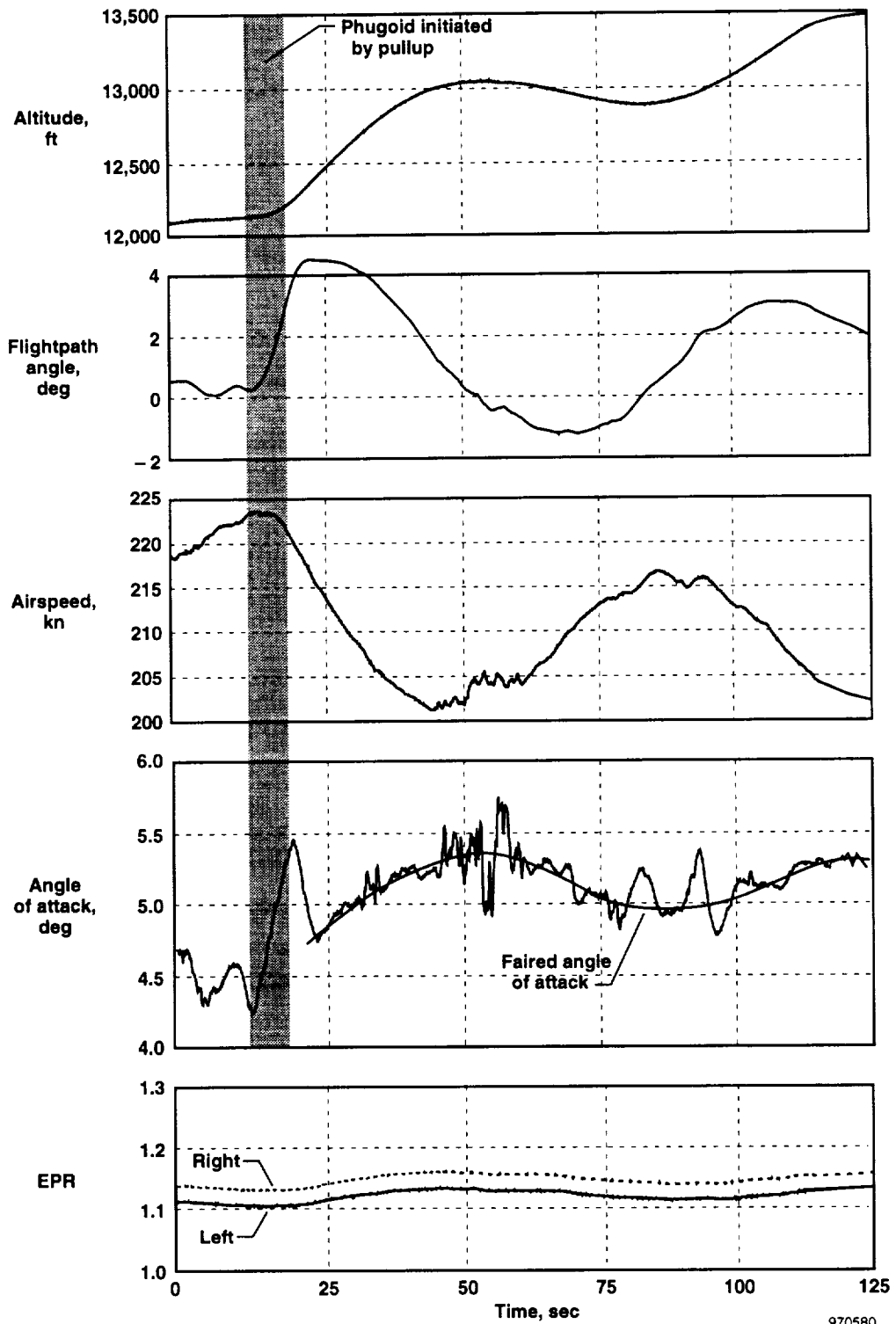

970580

(a) Time history of phugoid, LSAS off, gear down, flaps up, light turbulence, fixed throttles, center engine at idle, initiated by an elevator pullup and release.

Figure 9. MD-11 phugoid oscillation.

Figure 9(b) shows a nonlinear simulation of a phugoid at the same conditions as those of the flight data. Similar trends are shown. The angle-of-attack change is primarily from pitch rate damping. Properly sized and timed throttle inputs can damp unwanted phugoid oscillations; reference 2 discussed these techniques.

Relative Positions of Inlet to Exhaust Nozzle

The relative positions of the inlet and exhaust nozzle of each engine can affect throttles-only flight control. The ram drag vector acts through the centroid of the inlet area along the flightpath and, thus, rotates with respect to the airplane geometric reference system as angles of attack and sideslip change. The gross thrust vector usually acts along the engine nozzle centerline and thus maintains its relationship to the airplane geometric reference system. Ram drag can be a significant percentage of gross thrust, particularly at low power settings where ram drag may approach the magnitude of the gross thrust.

In the pitch axis, positioning the inlet above the engine nozzle centerline is beneficial so that an increase in throttle, which increases ram drag and gross thrust, will result in a nose-up moment. This benefit is the case for the B-2 and for center engines on the B-727 and L-1011. If the inlet is below the engine nozzle centerline, an increase

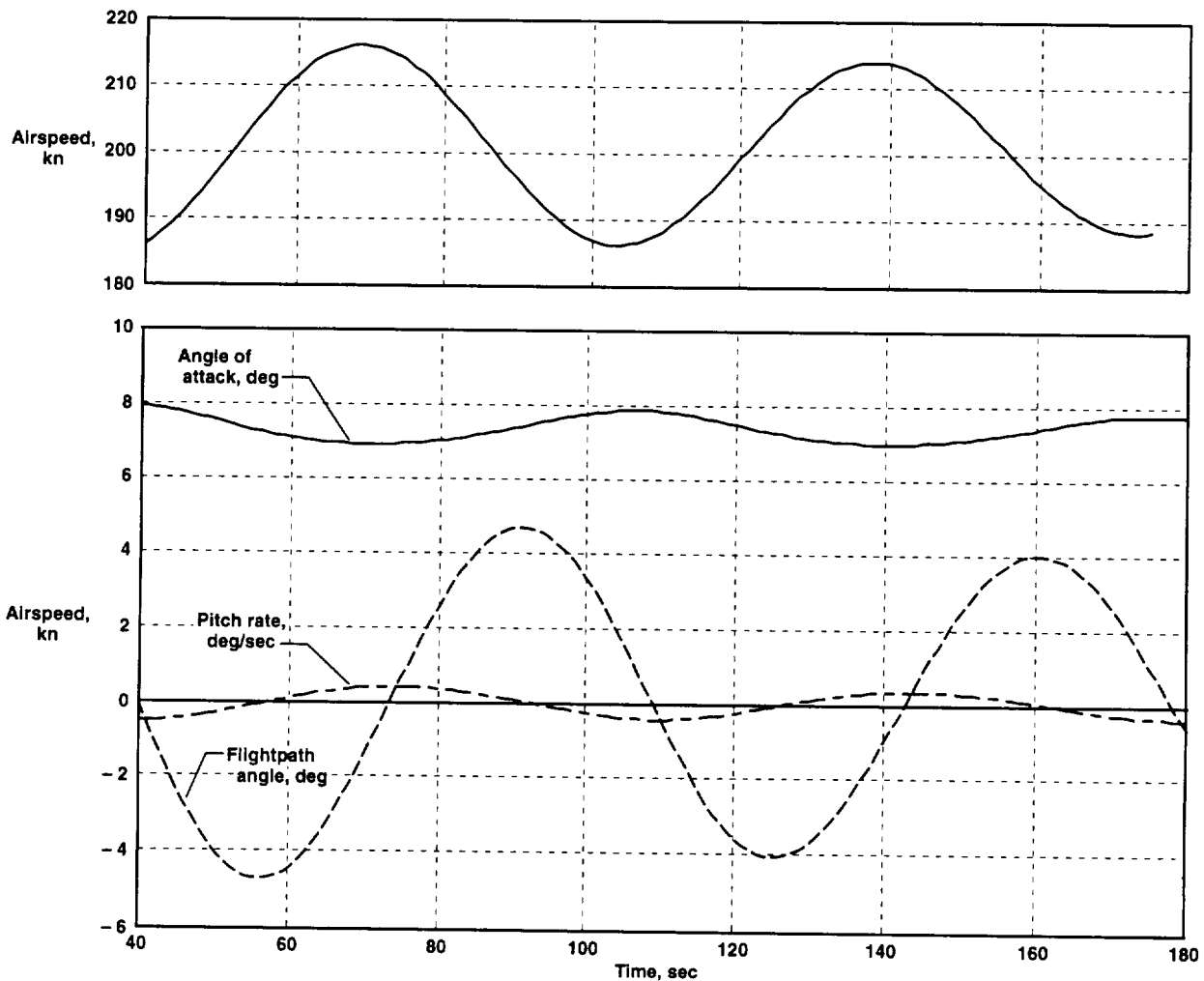

(b) MD-11 simulation, gear down, flaps up, center engine idle.
Figure 9. Concluded.

in thrust causes an undesirable nose-down moment; the F-16 and F-18 are examples of such a configuration. Podded engines typically have the inlet and nozzle closely aligned and would have a nearly neutral effect, although as angle of attack increases, this effect would become more favorable.

In the yaw axis, the principles are similar. The desirable geometry is to have the engine nozzles outboard of the inlets so that an increase in thrust results in a favorable yawing moment. Unfortunately, this geometry is not the case for many fighter airplanes with inlets outboard of the engines.

Normal flight control system operation masks the inlet-nozzle effects to such a degree that crews may be unaware of the effects. In addition, all but the highest fidelity simulations usually neglect these effects. For the F-15 PCA flight test, these effects were quite significant (ref. 1). For the MD-11 airplane, with podded engines, these inlet-nozzle effects are small.

Trim Speed Control

After the normal flight control surfaces of an airplane are locked at a given position, the trim airspeed of most airplanes is only slightly affected by engine thrust. However, speed can be changed in several ways. In general, the speed needs to be reduced to an acceptable landing speed; this requires developing nose-up pitching moments. Methods for developing nose-up pitching moments include moving the CG aft, increasing the thrust of low-mounted engines, or decreasing the thrust of high-mounted engines. Extending the landing gear often results in decreased trim speed because an increase in engine thrust is required to maintain the desired flightpath. Lowering flaps increases lift, which would tend to reduce trim speed. But flap extension often results in a nose-down pitching moment; so the overall effect is configuration dependent.

Trim speed is also affected by changes in weight. As weight is reduced (such as by burning or dumping fuel), assuming that the longitudinal CG remains constant, the lift remains constant, and the airplane tends to climb. To maintain level flight, the throttle setting must be reduced until lift and weight are again in balance.

On the MD-11, several ways to control speed are available; flaps and stabilizer trim require hydraulic power, which may not always be available in an emergency. The center engine can be used as a moment-generating device to change angle of attack, and hence to control speed; increasing center engine thrust has a strong nose-down pitch effect and increases the trim speed. Starting with all throttles equal, increasing thrust on the wing engines and decreasing thrust on the tail engine to idle thrust reduces speed by 20 to 30 kn. Lowering the landing gear with the alternate gear extension system (which leaves the wheel wells open and the landing gear doors exposed) reduces speed an additional 15 to 17 kn in part because of the increased thrust required on the wing engines (if the tail engine is not used) to maintain a desired flightpath. Weight reduction also reduces trim speed.

Figures 10(a) through 10(i) show the MD-11 trim airspeed as a function of stabilizer setting, gross weight (GW), and longitudinal CG position. These data were obtained from the nonlinear simulation. Figures 10(j) and 10(k) are crossplots for the variation in trim speed with CG at fixed GW. With these data, determining the stabilizer-fixed speed range available as a function of GW and CG is possible. Fuel transfer, either to or from the tail tank, or between the main tanks, could shift the CG as much as 10 percent, which would change speed as much as 100 kn. At the forward CGs such as 12 percent, the airplane has strong speed stability (steep slope of stabilizer vs. speed), whereas at aft CGs such as 34 percent, speed stability is reduced by at least 50 percent. Also note the effects of decreasing weight at constant CG and stabilizer position on trim speed. Flying at approximately 220 kn, trim speed is reduced by approximately 1 kn for every 3000 lb of fuel consumed (approximately every 12 to 15 min).

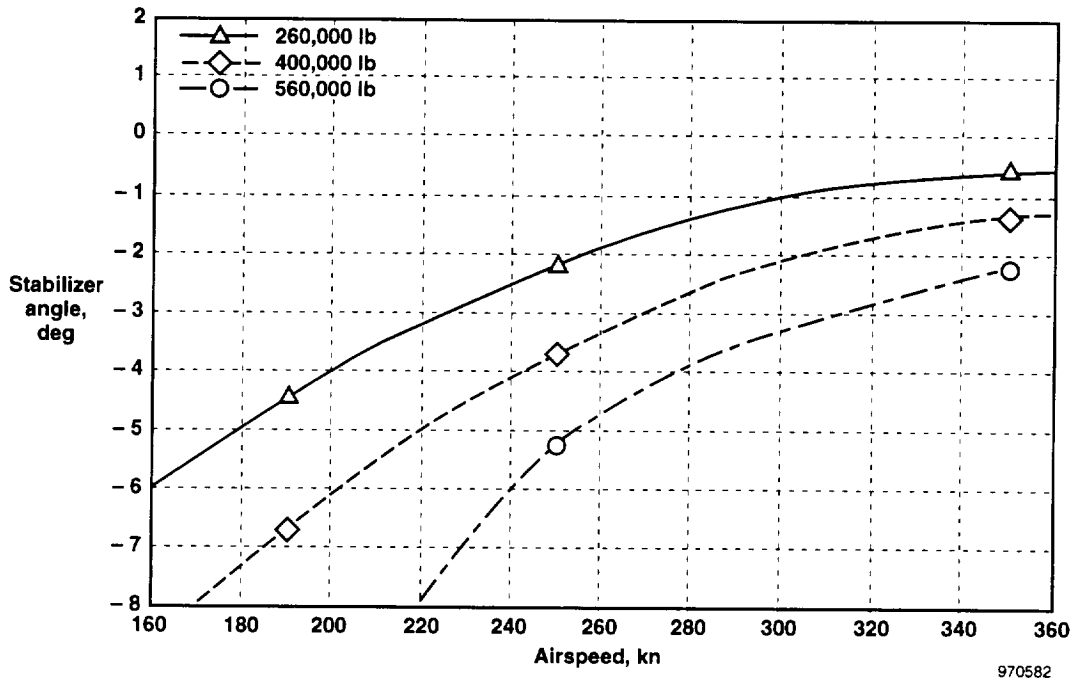

(a) CG = 12 percent, gear down, altitude = 4800 ft.

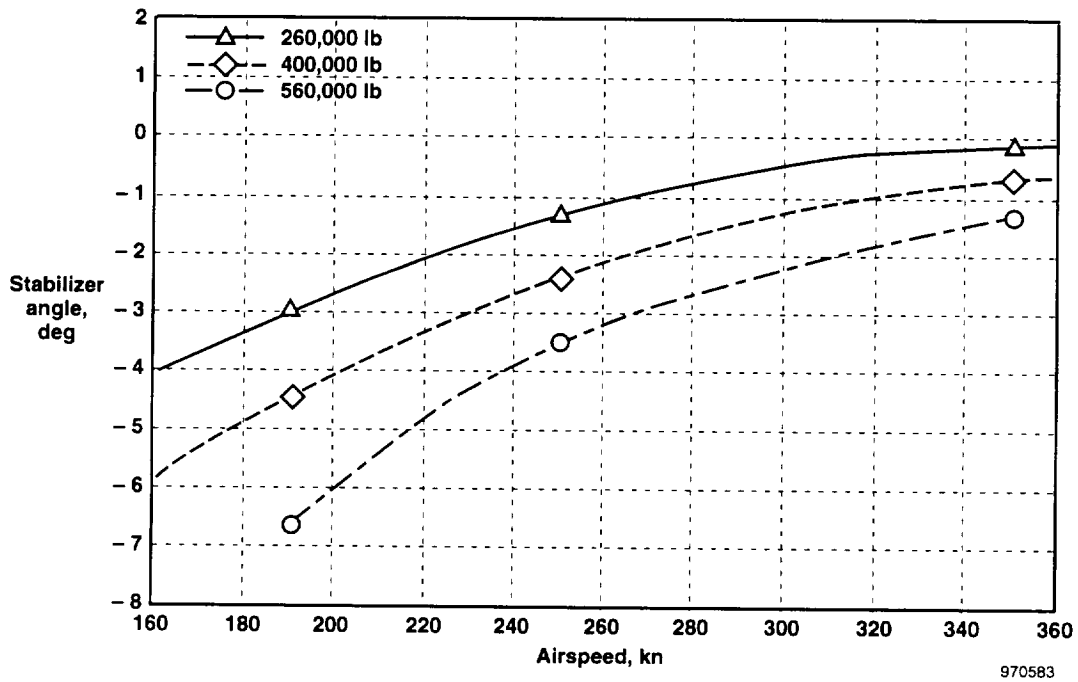

(b) CG = 21 percent, gear down, altitude = 4800 ft.

Figure 10. Effect of airspeed, gross weight (GW), and CG on stabilizer position, zero flaps/slats.

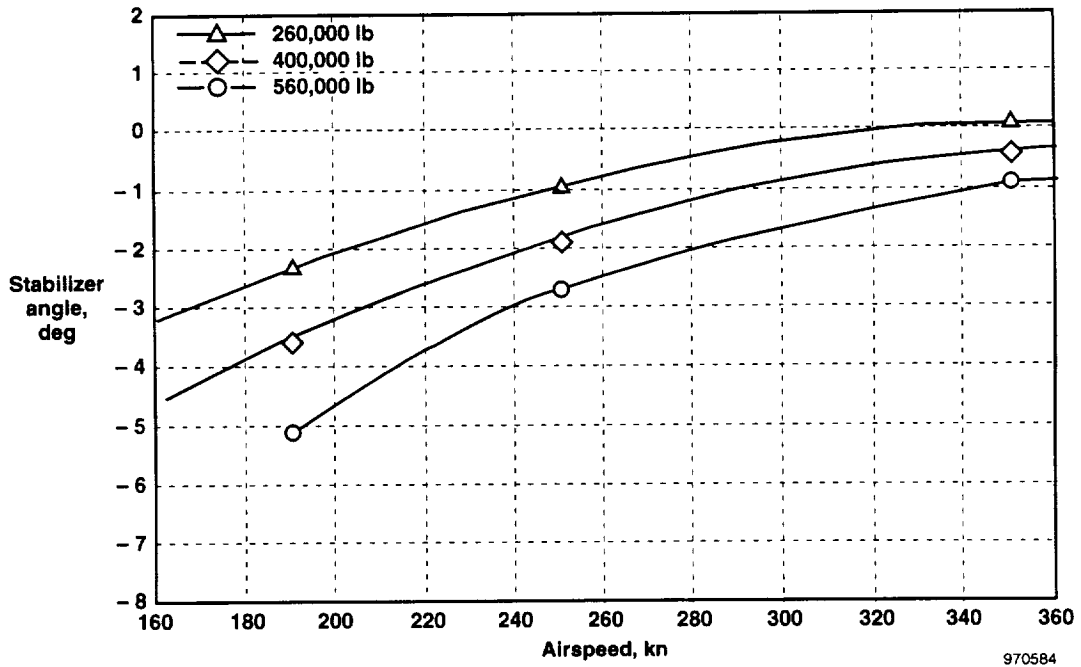

(c) CG = 25 percent, gear down, altitude = 4800 ft.

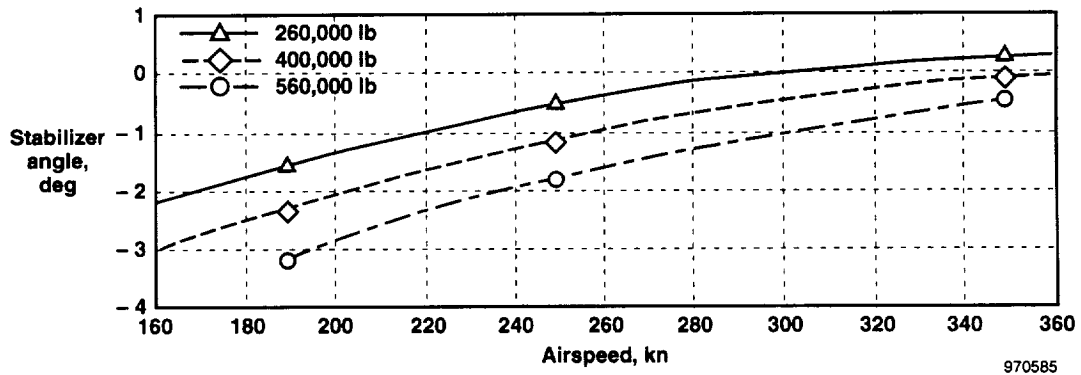

(d) CG = 30 percent, gear down, altitude = 4800 ft.

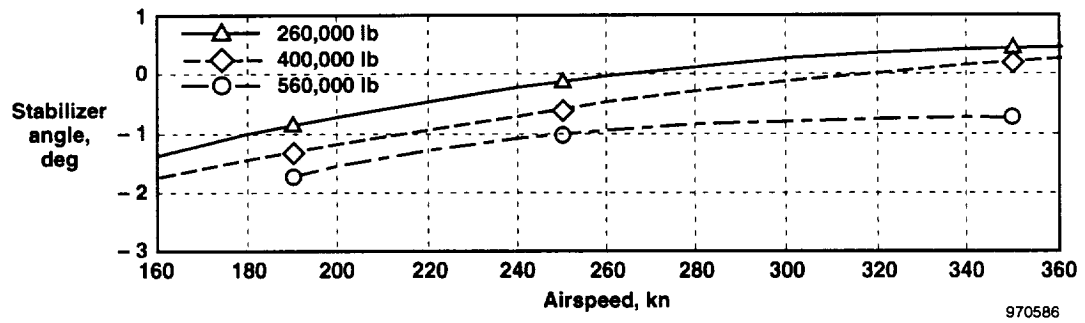

(e) CG = 34 percent, gear down, altitude = 4800 ft.

Figure 10. Continued.

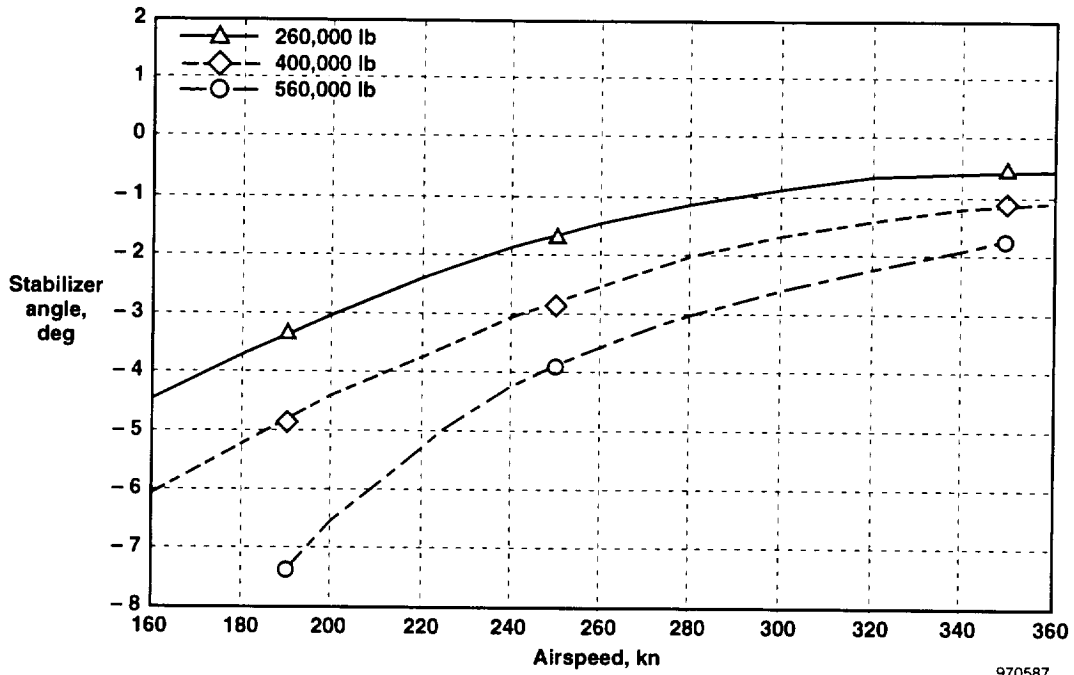

(f) CG = 21 percent, gear up, altitude = 4800 ft.

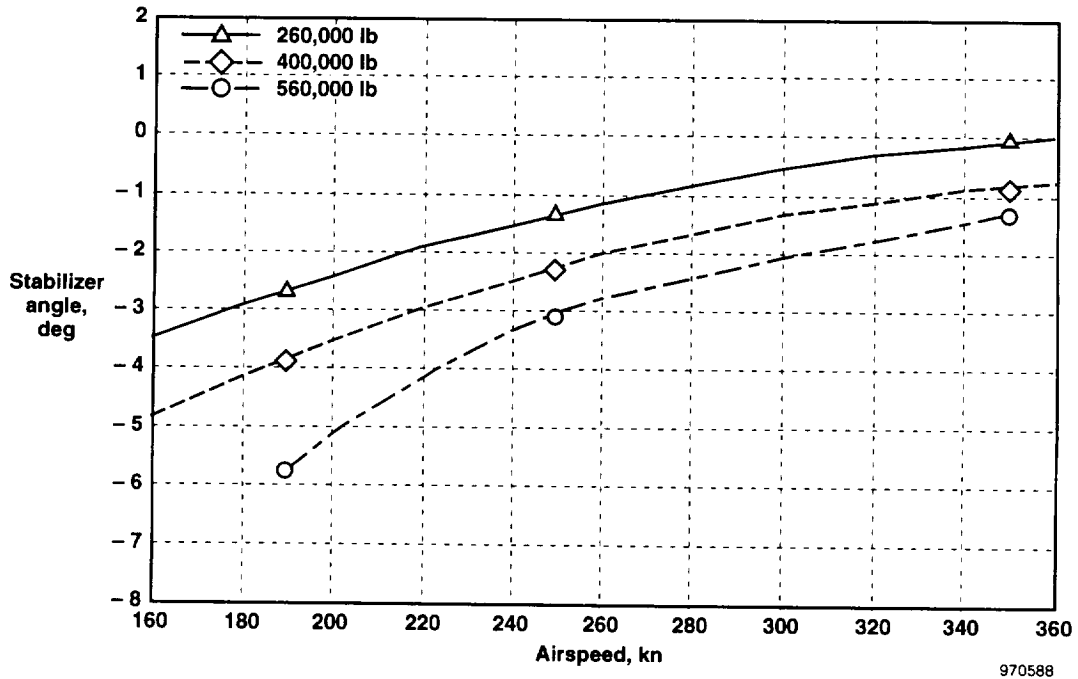

(g) CG = 25 percent, gear up, altitude = 4800 ft.

Figure 10. Continued.

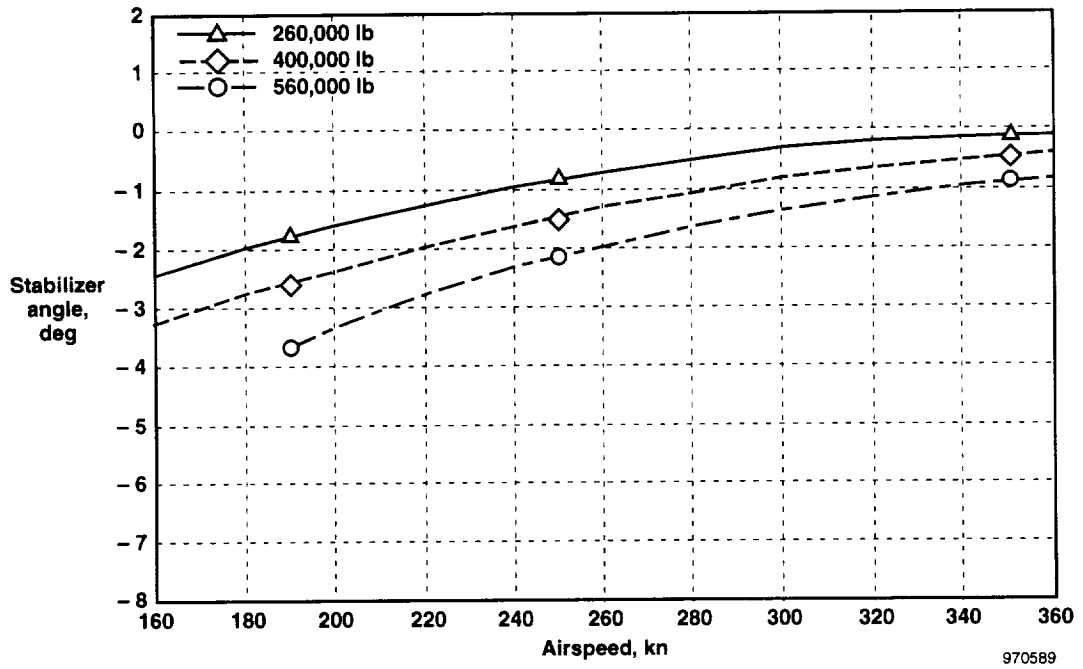

(h) CG = 30 percent, gear up, altitude = 4800 ft.

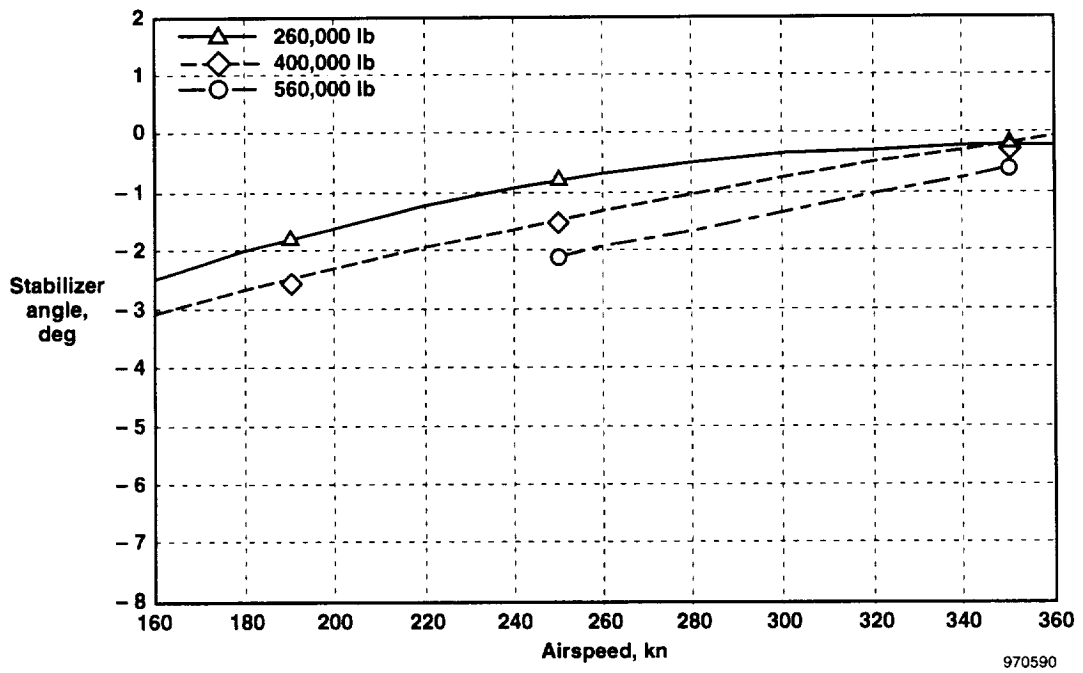

(i) CG = 30 percent, gear up, altitude = 20,000 ft.

Figure 10. Continued.

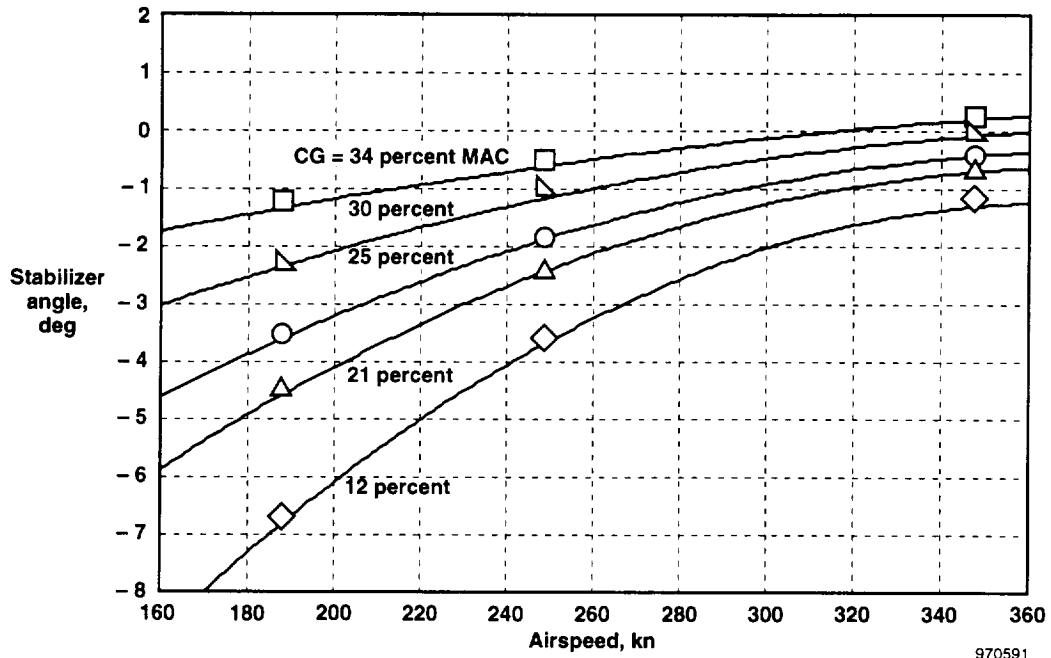

(j) Crossplot, GW = 400,000 lb.

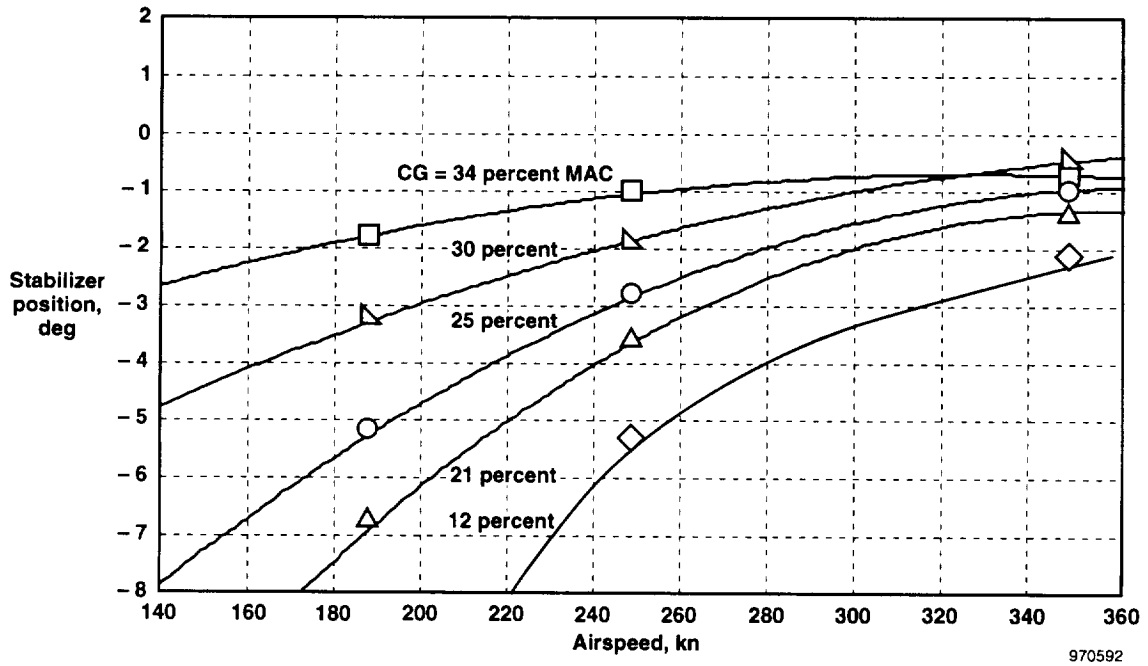

(k) Crossplot, GW = 560,000 lb.

Figure 10. Concluded.

Speed Effects on Propulsive Control Power

The propulsive forces (differential thrust for lateral control and collective thrust for flightpath control) tend to be relatively independent of speed. The aerodynamic restoring forces that resist the propulsive forces are, however, proportional to the dynamic pressure, which is a function of speed squared. This relationship would result in the propulsive control power being approximately inversely proportional to the square of the airspeed, as discussed in reference 1. On the MD-11, the slight EPR and thrust loss with increasing speed, shown earlier in figures 3 and 9, reduces this effect somewhat.

Surface Float With Hydraulic Systems Off

With the hydraulic system failed, a surface will float to the zero hinge moment condition. For the MD-11 hinge geometry, this position is essentially the trail position. Simulator studies on the MD-11 indicated that a total hydraulic system failure would cause the ailerons to float trailing edge up, the amount depending on speed, thus reducing lift and increasing trim airspeed. Rudder float would only negligibly affect trim speed but would reduce directional stability. Elevators are usually trimmed to near zero force; hence elevator float would have a small effect. The stabilizer is usually moved with a jackscrew actuator that, in case of hydraulic failure, remains fixed due to friction. Flight data shown later do not agree with the simulator predictions.

Wing-Engine-Out With Lateral CG Offset Control

If an airplane without flight controls and without any operating engine on one wing has the lateral CG offset toward the side with one or more operating engines, that engine thrust can be modulated to develop yaw and a rolling moment to counter the moment from the lateral CG offset. With proper thrust modulation, providing a degree of bank angle control is possible. If thrust is reduced from a wings-level condition, the airplane rolls toward the operating engine. Conversely, if thrust is increased above that needed for wings level, the airplane rolls away from the operating engine. The degree of lateral offset dictates the level of thrust required for wings level and, hence, the average flightpath.

CONTROL MODES USING ENGINE THRUST

With inoperative flight controls, engine thrust can generate pitching and rolling moments, as discussed earlier. The pilot can manually move the throttles or use a PCA system to send commands and feedback parameters to generate throttle commands. Tests were performed to evaluate both methods on the MD-11 airplane.

Manual Throttles-Only Control

For these tests, the crew turned off the LSAS, yaw dampers, speed protect system (by lowering the AFS override switches on the FCP), and the fuel transfer system. The crew then trimmed the airplane, released the flight controls, and used only the throttles for flight control. In this mode, the airplane behaved much like it would with a total flight control system failure. Differential thrust controlled bank angle, and collective thrust controlled pitch. Results are discussed later.

PCA System Control

In the PCA system, closed-loop control of engine thrust is provided to track pilot-commanded flightpath and ground track. Figure 11 shows simplified block diagrams of the PCA control laws. For the two-engine PCA system, the pilot uses the center engine only manually as a low-frequency speed trimmer. The control modes that used the center engine are discussed later. The lateral control system shows the track mode and a bank angle control mode which was also available.

Lateral PCA Control

Track Mode—In the lateral axis, controlled differential thrust provides precise track angle control and dutch roll damping (fig. 11(a)). The pilot uses the autopilot TRK knob command (selectable in integer degrees) to select the desired track. Track is preselected by turning the knob to the desired track, then commanded by pulling the knob. This command is compared with the sensed track angle, generating a track error. This error is converted into a bank

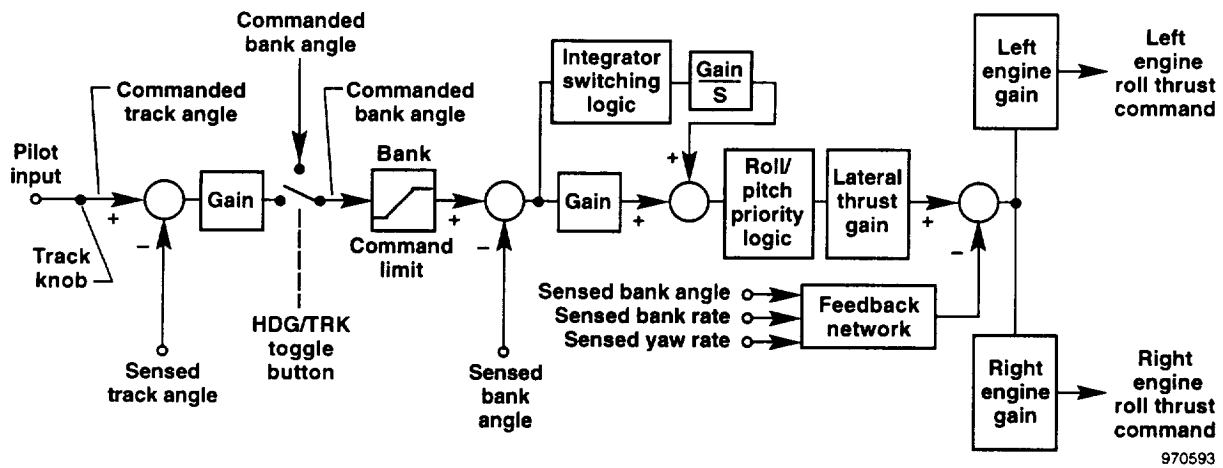

(a) PCA lateral control system (track and bank angle modes).

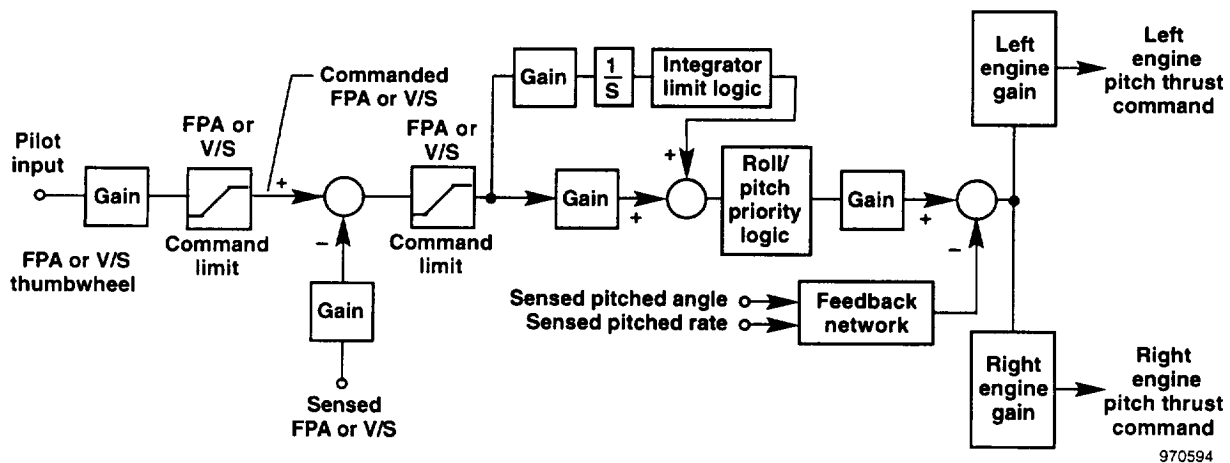

(b) PCA longitudinal control system, center engine modes not shown.

Figure 11. MD-11 PCA system.

angle command and compared with the sensed bank angle, generating a bank angle error, with the maximum bank angle command limited. Normal MD-11 bank angle limits can be selected on the outer part of the Heading/Track (HDG/TRK) knob, up to a limit of $\pm 20^\circ$. An integrator with a low gain is provided to trim out biases in the lateral axis. For stabilization and dutch roll damping, bank angle, yaw rate, and roll rate feedback are available. The resulting differential thrust commands are issued to the wing engines to obtain the commanded track. The pilot's track command is displayed by a bug on the compass and a vertical bar on the PFD (fig. 12), as well as on the navigation display cursor (fig. 2(c)).

Bank Angle Mode—The bank angle mode was an alternative to the track mode. If the crew selected HDG rather than TRK, only for this PCA implementation, the bank angle mode was activated. The HDG/TRK knob became hot (meaning it responded as turned without having to be pulled) and could command bank angles of up to $\pm 20^\circ$. When in the bank angle mode, the track command and track feedbacks, shown in figure 11(a) were zeroed. Figure 13 shows the bank angle mode readout on the FCP and on the PFD roll window, which was the commanded bank angle— 000° to 020° for right banks and 340° to 000° for left banks. While obviously not a suitable annunciation for a production application, this served well for a flight test.

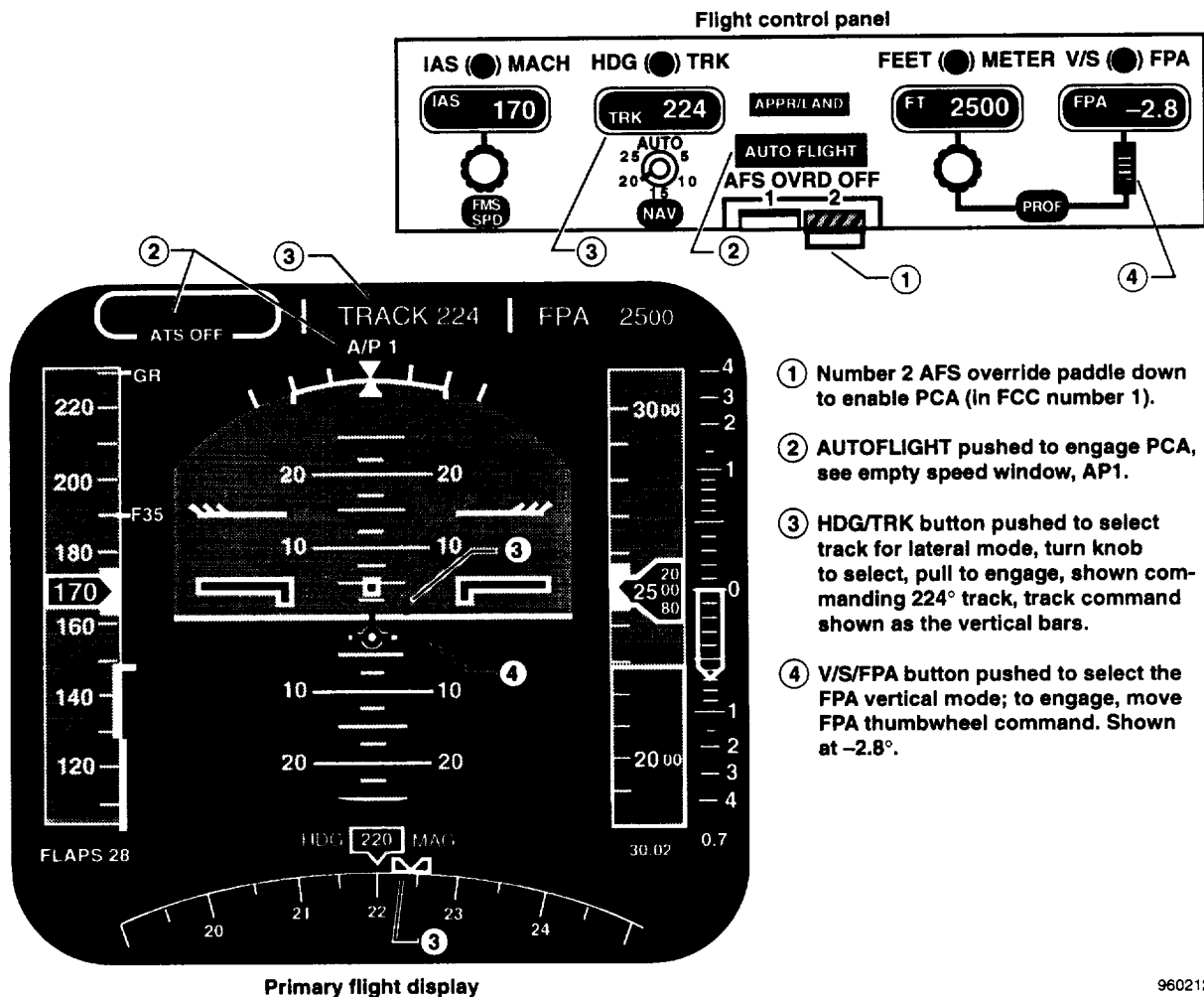

Figure 12. Flight control panel and primary flight display showing PCA flightpath and track mode selection.

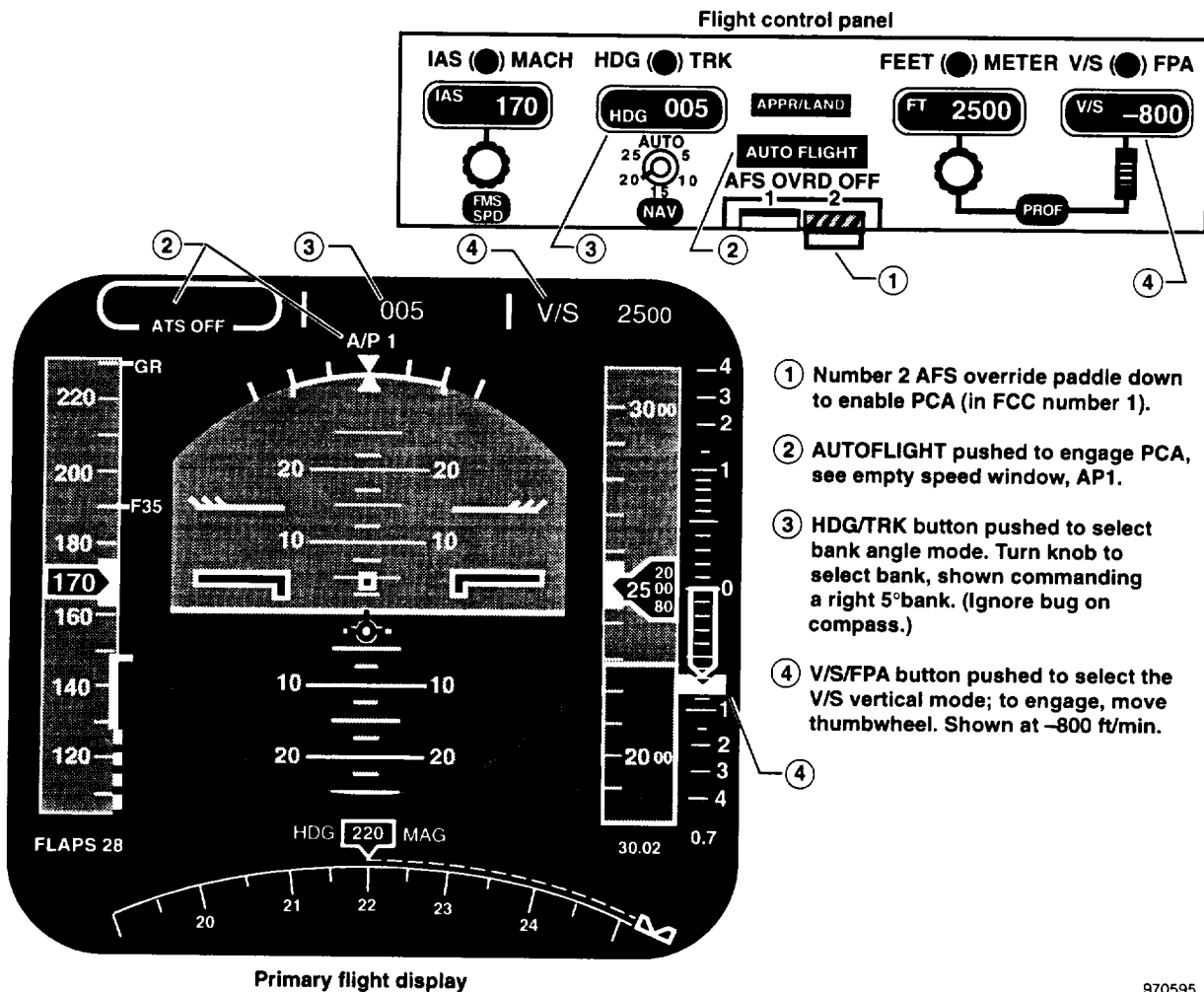

Figure 13. MD-11 PCA bank and V/S mode selection and annunciation.

970595

Longitudinal PCA Control

Longitudinal control is designed to provide precise flightpath control and adequate phugoid damping. In the pitch axis, the simplest control law operates only the two wing engines on the MD-11 (fig. 11(b)). The pilot input through the autopilot thumbwheel command for flightpath angle is limited, then compared with the sensed flightpath angle, and limited again; PCA flightpath commands were limited from $+10^\circ$ to -10° , and errors to $\pm 3^\circ$. A low-gain integral path is provided in pitch to eliminate steady-state errors, and pitch rate feedback is provided to assist in phugoid damping. Collective (equal) thrust commands are sent to the wing engines to obtain the commanded flightpath. The thumbwheel flightpath command selected on the FCP is displayed to the pilot on the PFD using the existing flightpath command bar (fig. 12). In the V/S mode (fig. 13), the commanded vertical speed was shown on the FCP in the V/S window and with a bug on the vertical-speed scale on the right side of the PFD.

Figure 14 shows the control laws that include the center engine. Two modes were available. In one mode (fig. 14(a)), the center engine provided trim speed control. In the second mode (fig. 14(b)), the center engine also had a short-term, pitching moment control; the center engine received opposite-sign thrust commands for pitch control, washed out with a 4-sec time constant.

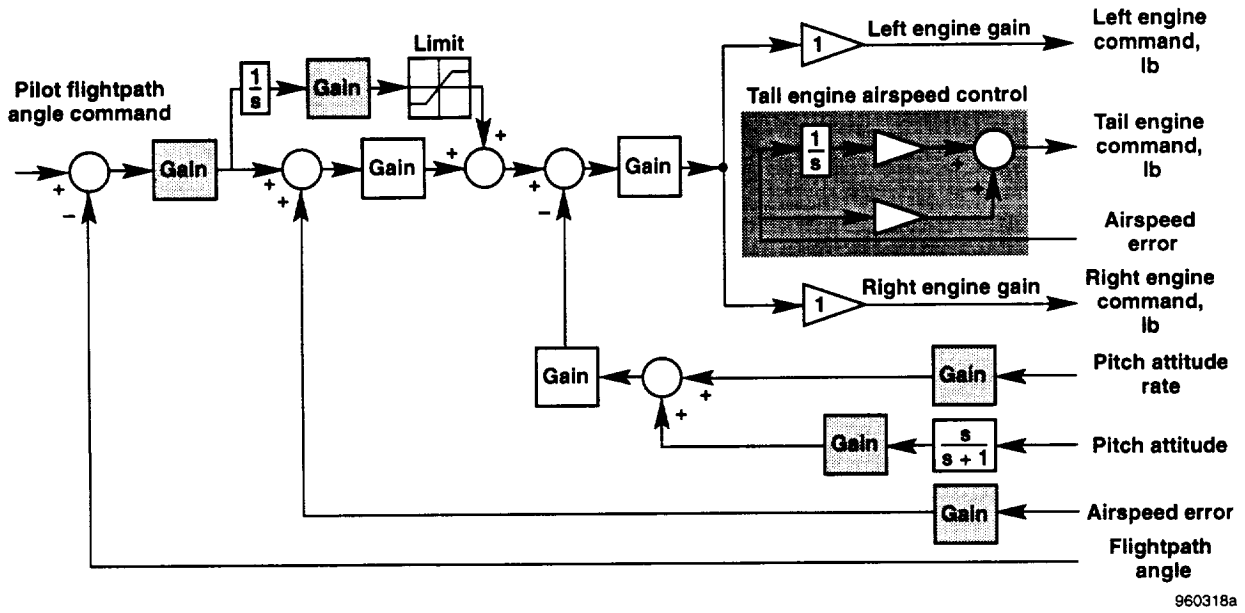

(a) Center-engine airdspeed control mode.

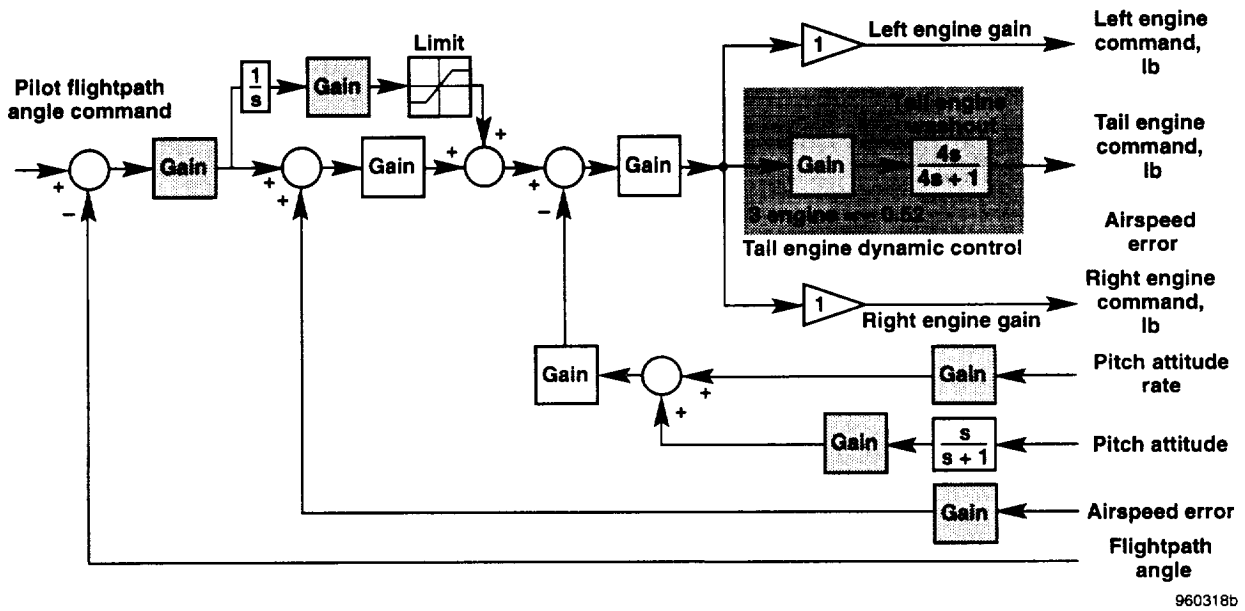

(b) Center-engine dynamic control.

Figure 14. MD-11 PCA longitudinal control law center-engine modes (shaded blocks are changed from two-engine mode).

Logic is provided to prevent the wing engines from being driven to very low power settings where the engine response is excessively slow. Integrator windup protection is also provided. A priority logic attempts to minimize saturation of pitch or roll commands. In both axes, the thrust command is converted in the PCA logic into an EPR command that is the normal engine control parameter. This strategy provides more accurate thrust control than a throttle command and allows very small thrust commands to be accurately achieved.

The go-around portion of the standard (MD-11) TOGA mode was implemented. If the TOGA button on the center throttle was pushed, the PCA system leveled the wings and commanded a 3° climb. Coupled approach modes were not implemented initially; their subsequent addition is discussed later in this paper.

The control modes were selectable by a flight test engineer using the MCDUs. Variable gains, filters, multipliers, and gain schedules were available at most points within the PCA software, providing much flexibility for testing. References 12 and 13 discussed more detailed design and analysis of the PCA control laws.

PCA IMPLEMENTATION

Reference 14 discussed the PCA system implementation in detail. PCA logic resides in one of the two flight control computers (FCCs). The FCC also provides a host of other functions including autopilot, autothrottle, navigation, stall warning, and flight management system. Honeywell developed the code for the PCA control laws and interfaced them to existing sensor signals and software that sent EPR commands to the engine FADEC computers over the existing ARINC 429 data bus. This electronic thrust command did not move the throttle levers in the cockpit. Pratt & Whitney modified the FADECs to accept a full-authority EPR command in place of the normal ± 5 percent EPR commands. For this initial flight test, a PCA disengage capability was also incorporated in case the throttles were moved more than a preselected amount (default was $\pm 2^\circ$), thus instantly giving the pilots normal throttle control if needed. The first FCC contained the PCA software; the second FCC software was unmodified.

In some instances, to reduce the cost of the flight test, features were not incorporated that would be desirable in a production system. For example, there was no way to display a PCA-engaged annunciation without relatively expensive changes to a symbol-generating computer. In the bank-angle mode, hardware changes would have been necessary to display negative bank angles for left turns. For a concept demonstration flight test, these features were not thought to be necessary.

For this flight test, the standard MD-11 altitude capture and hold feature was not needed and was not implemented. Coupled approach modes were not initially implemented in the PCA logic; their eventual implementation is discussed later.

For the PCA tests, the approach idle thrust feature was implemented for any flap or slat setting except fully retracted. In this way, for testing with the slats or flaps up, the flight idle thrust setting would be available; approach idle would be too much thrust for a no-flaps approach.

PCA SYSTEM OPERATION

The PCA system was enabled by selecting FCC 1 (which contained the PCA software) and disabling FCC 2 by lowering the AFS 2 override paddle switch. The PCA system was engaged by pushing the Autoflight button on the FCP (fig. 12). PCA system engagement was indicated by the AP 1 (autopilot 1) indication in the PFD roll window and the empty box on the PFD speed window (normally, a speed command indication was there). Longitudinal control through the thumbwheel commanded FPA. Lateral control was effected through the HDG/TRK knob. In the track mode, turning the knob preselected the track, and pulling the knob sent the command to the PCA software. In the bank-angle mode, the knob responded as soon as it was turned.

For this flight demonstration, to ensure test safety, several methods were available for disconnecting the PCA system. Any disconnect was indicated by a red, flashing, Autopilot Off box in the PFD roll window and an aurally annunciated Autopilot warning. The disconnect methods were:

1. Pressing the autopilot disconnect switch on either control wheel
2. Pressing the autothrottle disconnect switch on the throttle
3. Lowering the AFS override switch on FCC 1
4. Moving the left or right throttle more than the preselected (2°) allowable limit
5. Depressing any of the ALT FADEC switches (which disallowed any data bus inputs to the engine control logic)

The PCA system would also disengage if any of several software error flags were set or avionics unit failures occurred. When disengaged, standard normal MD-11 operation was immediately restored.

PCA DEVELOPMENT AND TEST

Throttles-only control was first investigated on the MD-11 engineering simulator in August 1991. This simulator did not properly model the lateral control available with differential thrust and gave a pessimistic impression of the controllability with thrust. Later, the higher fidelity FDS was used, and a much better lateral control capability was evident. Although the task was highly difficult at first, there was a rapid learning curve, and with some experience and a very high workload, gross control using manual throttle manipulation could be achieved. Bank angle, heading, and flightpath could be controlled to within a few degrees. Because of the low-mounted wing engines, a pilot using only the wing engines could simply increase thrust slightly to increase flightpath angle and could reduce thrust slightly to decrease flightpath angle. Phugoid damping could also be achieved using this same technique (i.e., add thrust during the descent and reduce thrust during the climb). The size and timing of these inputs, however, are critical. The center engine could be used as a trimming device to control speed; increasing center engine thrust has a strong nose-down pitch effect and increased the trim speed.

Differential thrust was effective in inducing sideslip, which resulted in the aircraft rolling. At speeds greater than 170 kn, the dutch-roll mode was adequately damped and bank angle could be controlled reasonably well. At speeds less than 170 kn, dutch-roll damping decreased, and bank angle control was more difficult. At speeds less than 150 kn, using the throttles to attempt to damp the dutch roll was very difficult, and even experienced test pilots had little success. This situation is because exact timing is required to successfully damp the dutch roll.

MDA did an in-house study of a PCA system for the MD-11 based on their work on the F-15 PCA system. This study showed that the bare airframe dutch-roll damping could be increased from 0.05 to 0.45, while the bare airframe phugoid damping could be increased from 0.02 to 0.55.

In September 1992, a manual throttles-only flight test was conducted. MD-11 ship 506 was flown out of Yuma, Arizona. For these tests, the LSAS and yaw dampers were turned off, the speed protect feature of the AFS was disabled, landing gear was lowered, and fuel transfer was selected to manual. The pilots then released the controls and flew with throttles-only control. Nearly 4 hr of small throttle step tests, phugoid damping tests, dutch-roll damping tests, and low approaches were flown. Although gross control was certainly possible and improved with practice, a manual throttles-only landing on a runway would have been very difficult. The third of four low approaches was the only one that might have been suitable for a runway landing. Data collected on this test flight were used to validate the FDS results for throttles-only control investigations.

Based on the success of the F-15 PCA development, the gross control capability of manual throttles-only-control in the FDS and in flight, and the internal MDA study results, NASA contracted with MDA to perform a study of a PCA system for the MD-11. A linear model based on the FDS was developed and used to design a PCA control law. This control law worked well on the linear simulation, but when tried on the FDS, performance was poor. The problems were primarily because of the nonlinear engine response characteristics. Later, a nonlinear model was developed for control law analysis and development. Initially, the center engine was used along with the wing engines; however, to simplify the initial control design and to demonstrate the concept for aircraft without centerline engines, only the wing engines were used.

Under NASA contract, PCA system preliminary design and development studies were conducted in 1993, with prime contractor MDA establishing subcontracts with Honeywell (manufacturer of flight control computer and software) and engine contractors, Pratt & Whitney and General Electric (Evendale, Ohio). The preliminary design was completed in the fall of 1994. The study showed that an all-software PCA implementation was feasible, and performance appeared to be adequate for the project objectives. A test airplane with Pratt & Whitney engines was selected for the demonstrations.

Final design subcontracts were let to Honeywell and Pratt & Whitney, and the final design was completed in March 1995. Pratt & Whitney modified a breadboard FADEC, tested the modified software on a test engine at sea-level static conditions, and then programmed read-only memory modules for four sets of flight-qualified FADECs. Honeywell developed the software for the PCA control laws, with gains based on the control evaluations conducted in the FDS. This PCA software was tested in an offline simulation at the Honeywell facility. After this software was operating properly, it was coded for the FCC; unneeded software modules were deleted as required to make room for the PCA code.

The flight code was then tested by Honeywell. MDA conducted integration tests in the MD-11 closed-loop bench simulation with a PCA FCC and a single test PCA FADEC to verify proper communication over the data buses as well as proper engagement, annunciation, operation, and disengagement (ref. 14). The MD-11 bench setup could not accommodate more than one FADEC. A ground test on the airplane verified end-to-end operation, including that PCA commands could be sent to the FADECs, that the engines would respond properly, and that the PCA system could be disengaged with all methods.

Test Procedure

For PCA system flight tests, the MD-11 test airplane 560 was configured as usual; LSAS and yaw dampers were turned off and speed-protect logic was inhibited by lowering the FCC paddle switch. The left-seat pilot was the PCA test pilot; the right-seat pilot was the safety pilot and did not participate in PCA system control. Table 1 shows the test pilots. The flight test engineer sat behind the center console, set up the test conditions with the pilots, verified aircraft configuration, made MCDU entries, and recorded flight notes. In the main cabin, the data system engineer verified data acquisition and coordinated with test engineers viewing data in real time at display consoles. The Flaps 28 (maximum takeoff flap) setting was used for much of the PCA system flight testing, as this would be the case right after takeoff and on approach. Also, most of the PCA system testing was performed with the gear down. This configuration was used because, in an emergency, the gear could be lowered without hydraulic pressure, and the increased drag from the gear was beneficial for PCA system operation. Tests were flown from the MDA test facility at Yuma, Arizona.

Table 1. PCA system pilots.

Pilot	Affiliation	Title	Last name
A	NASA	NASA project pilot	Fullerton
B	MDA	MD-11 PCA project pilot	Luczak
C	MDA	MDA evaluation pilot, MD-11 chief pilot	Miller
D	NASA	NASA evaluation pilot	Purifoy
E	FAA	Demonstration pilot, national resource specialist	Imrich

PCA System Flight Tests

The PCA system flight tests consisted of 21 flights flown over a 5-month period (table 2). The PCA system flights were interspersed with flights for other purposes. The first PCA flight was with a FADEC installed on only one engine for safety reasons. The test software had a switch activated by an MCDU input that permitted operation with a single FADEC. The first flight (flight 200) was flown in August 1995. Because of a software loading error, no data were obtained. On flight 201, successful PCA engagement and disengagement tests were made, followed by some small PCA commands to verify correct engine response. Then, with the PCA system off, some open-loop throttle response tests were performed. Figures 7 and 8, shown earlier, demonstrate these open-loop throttle step results with gear down and flaps up. The aircraft response to an increasing throttle step with gear down and Flaps 28, is shown in figure 15(a), while response to a throttle decrease with gear down but flaps up is shown in figure 15(b). These data were used in further comparisons with the FDS data.

On flight 202, a second PCA-equipped FADEC was installed on the other wing engine. Ground tests were successful, but in flight it was found that the PCA system could not be engaged because of what was later determined to be a timing problem. (The PCA closed-loop bench test could only incorporate one FADEC; when two FADECs were present, additional time was required to complete the initialization and data bus handshakes.) This problem was diagnosed, corrected in the FCC software, checked out, and was ready for flight test in about 2 weeks. The time for engagement was increased from 0.5 sec to an MCDU-adjustable value with a default of 2.5 sec. Following a successful ground test, flight 221 was flown. PCA system engagement tests were all successful with the 2.5-sec handshake time, which remained unchanged for the rest of the flight test.

After the disengage safety tests were completed, the PCA flight test program began by assessing the operational characteristics at 10,000 ft in smooth air. At the 10,000 ft altitude in smooth air, pitch and track control were very good. Commanded track was held within a degree. Two configurations were tested: a gear-down, flaps-up condition at about 220 kn and a takeoff configuration with Flaps 28 and gear extended at about 175 kn. Pilots A and B were impressed that PCA initially performed almost as well as the normal autopilot; the PCA controlled flightpath to a few tenths of a degree and, with a level flightpath command, held altitude to within ± 20 ft.

Table 2. PCA test flights of MD-11.

Flight	Date	Location	Objective	Remarks
200	5 Aug 95	Yuma	Single FADEC test	Software load problem, no data
201	7 Aug 95	Yuma	Single FADEC test	All tests OK, open-loop steps
202	8 Aug 95	Yuma	Two FADEC tests, PCA test	Could not engage, timing problem
221	27 Aug 95	Yuma	Two FADEC tests, PCA test	PCA pitch and roll tests good
222	27 Aug 95	Yuma	Two FADEC tests, PCA test	Turbulent air approaches
223	29 Aug 95	Yuma	PCA landings, no engage	Landed and reset FADEC faults
224	29 Aug 95	Yuma-Edwards	PCA landings	Good, light turbulence and thermals
225	29 Aug 95	Edwards	PCA landings	Good, turbulence and thermals
226	29 Aug 95	Edwards-Yuma	Edwards approach and sweeps en route	Moderate turbulence at Edwards
234	15 Sep 95	Yuma	Two hydraulics off, CG upsets, high, fast	Slats only and rudder offset, 5 hr
247	16 Nov 95	Yuma-Edwards	ILS-coupled PCA test	Boeing demonstration
248	16 Nov 95	Edwards	ILS-coupled approaches	Edwards and Palmdale, good
249	16 Nov 95	Edwards-Yuma	Return to Yuma, steps, sweeps	PCA and rudder, ILS into Yuma
252	28 Nov 95	Yuma-Edwards	Edwards, steps, enhanced, ILS land	ILS autoland at 1 ft/sec
253	28 Nov 95	Edwards	All hydraulics off tests, clean approach	Flew 25 min without hydraulics
254	29 Nov 95	Edwards	Demonstration flight	Airbus, Navy, Saudi, AA, DL
255	30 Nov 95	Edwards	Demonstration flight	USAF, JAL
256	30 Nov 95	Edwards	Demonstration flight and ILS land	Media demonstration
257	30 Nov 95	Edwards	Demonstration flight	FAA, Swissair
258	30 Nov 95	Edwards-Yuma	Return to Yuma	
266	15 Dec 95	Yuma	Throttle steps and sweeps	High gross weight

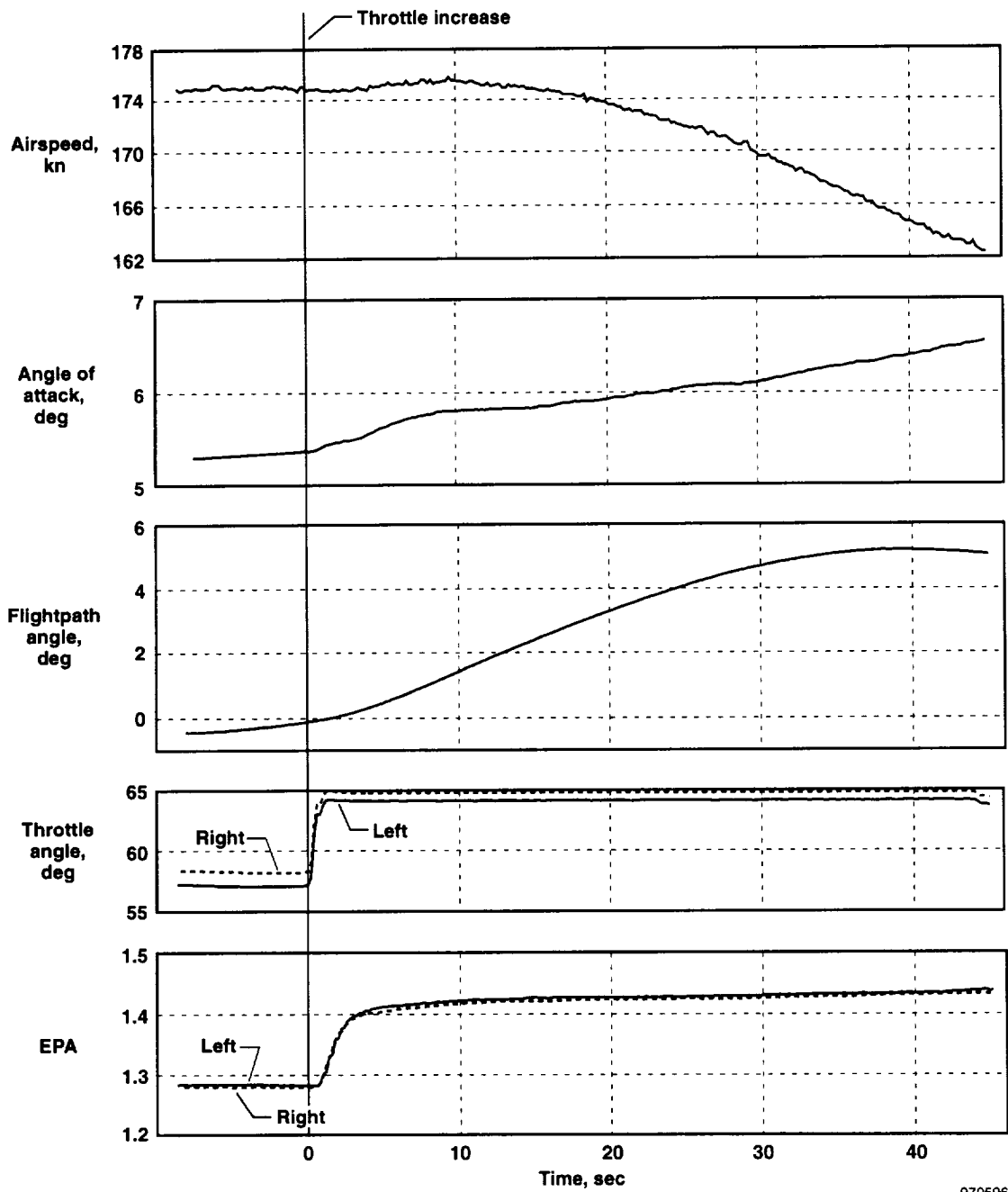

970596

(a) Throttle increase, Flaps 28.

Figure 15. Response of MD-11 to open-loop step throttle inputs, PCA off, center engine idle, LSAS off, yaw dampers off, landing gear down.

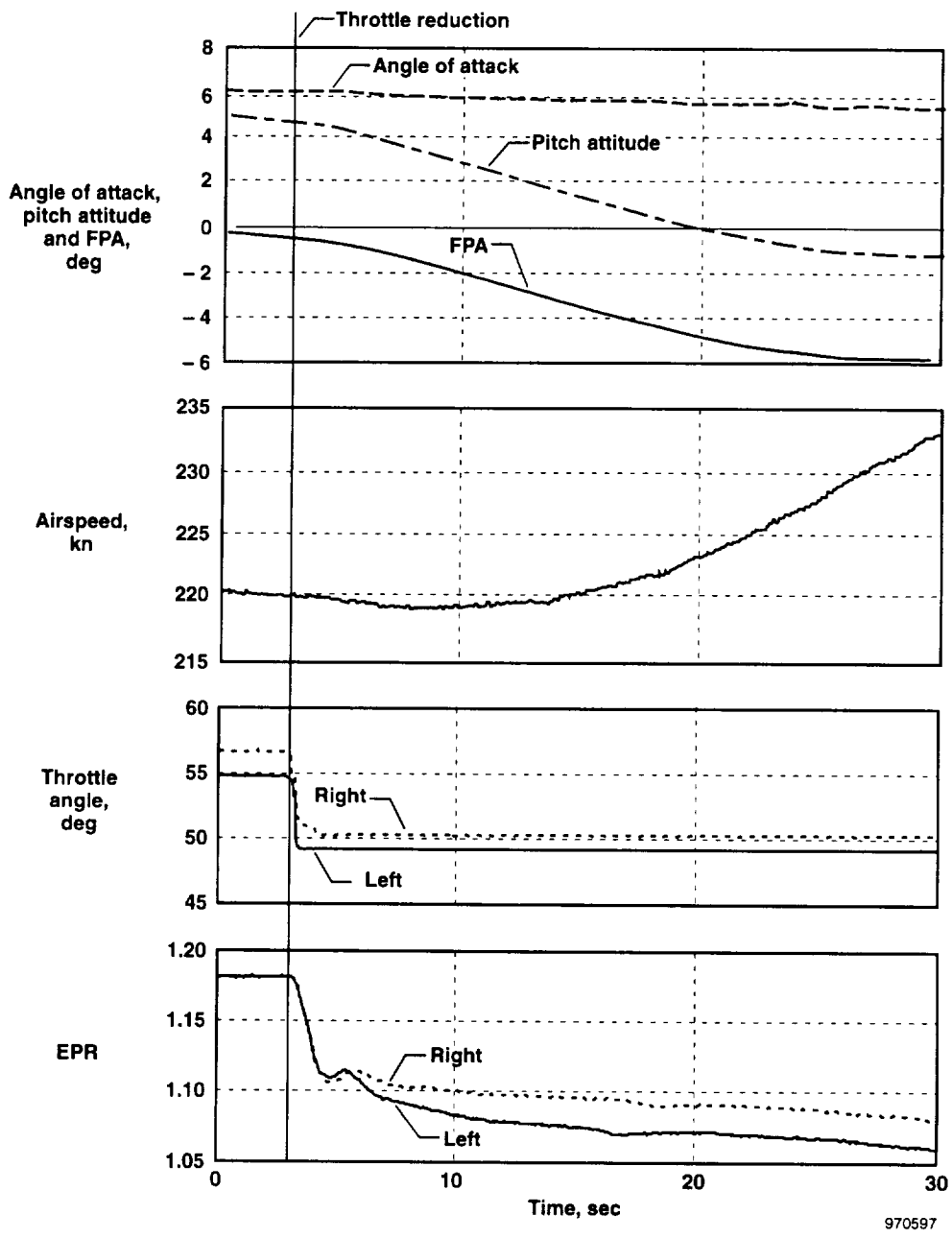

970597

(b) Throttle reduction, flaps/slats retracted.

Figure 15. Concluded.

PCA System Pitch Response

Pitch response tests with the initial gain set were performed. Figure 16 shows a flight response to a series of flightpath angle step commands and a comparison with the FDS for the two wing-engine PCA control mode. The pilot first selected a -2° flightpath step. Both engine EPRs decreased sharply because of the flightpath error, then almost immediately began to increase from the pitch rate feedback and decreasing flightpath error. The -2° command was reached in about 7 sec, then overshoot approximately 25 percent. Angle of attack followed EPR closely, and airspeed varied inversely as it did in the open-loop throttle steps. FDS data show more angle-of-attack change and less flightpath overshoot than the flight data. The overshoot was not judged objectionable by the pilots. Later pitch control law changes added velocity feedback that reduced the overshoot in the pitch response.

The speed changes (in two-engine PCA control) that result from flightpath commands result from the pitching moment change caused by changes in engine thrust. For a descent, lower thrust is required, which reduces angle of attack and thus increases trim speed. The converse is true for a climb. Care had to be taken when selecting climbs to consider the speed loss that would occur; a 5° climb could reduce speed by 15 kn. Speed on a 3° glideslope was typically 10 kn higher than the level flight trim speed. The pilot could manually advance the center-engine throttle during PCA climbouts to increase the trim speed.

PCA System Track Response

Lateral control with the initial gain set was evaluated at 10,000 ft with step inputs in track angle command. Track was controlled to within a degree, and track captures showed no overshoot; however, initial response was slow. Pitch control was also good during turns up to the bank angle limit of 20° . After completing the tests at 10,000 ft, more step responses were done at 5000 ft; performance was good in pitch but slow laterally. Following these tests, pilot A used the PCA system to make approaches to the runway. The August afternoon with surface temperatures in excess of 112° produced continuous moderate turbulence from thermal activity. Pitch control remained adequate; track control was very sluggish. On approaches it was difficult to anticipate the track commands required to maintain runway lineup because of the sluggish response.

Small Track Change

Based on linear analysis of the PCA system response, some gain changes were made (ref. 12) that improved the initial lateral control response; data in figure 17 show the original and improved track response. The time for a 5° track change was reduced from 22 to 17 sec; maximum bank angle increased from 4° to 6° . With the higher gains, the pilots could feel a distinct sideforce in the cockpit as the turn was initiated.

Large Track Change

Figure 18 shows a time history of a large track command with the improved control gains, gear down, and Flaps 28. The pilot commanded a right 80° turn from 80° to 160° ; the engine differential thrust response resulted in a maximum roll rate of $3.5^\circ/\text{sec}$, and the 20° bank limit was reached in about 10 sec. Flightpath angle dropped about 0.5° but corrected back with a loss of only 30 ft. Once stabilized in the 20° bank, the EPRs increased from 1.20 to 1.25, and airspeed increased about 7 kn to maintain the flightpath command. Turn rate averaged $2.5^\circ/\text{sec}$. In the rollout, flightpath was again well controlled with an overshoot of 0.5° .

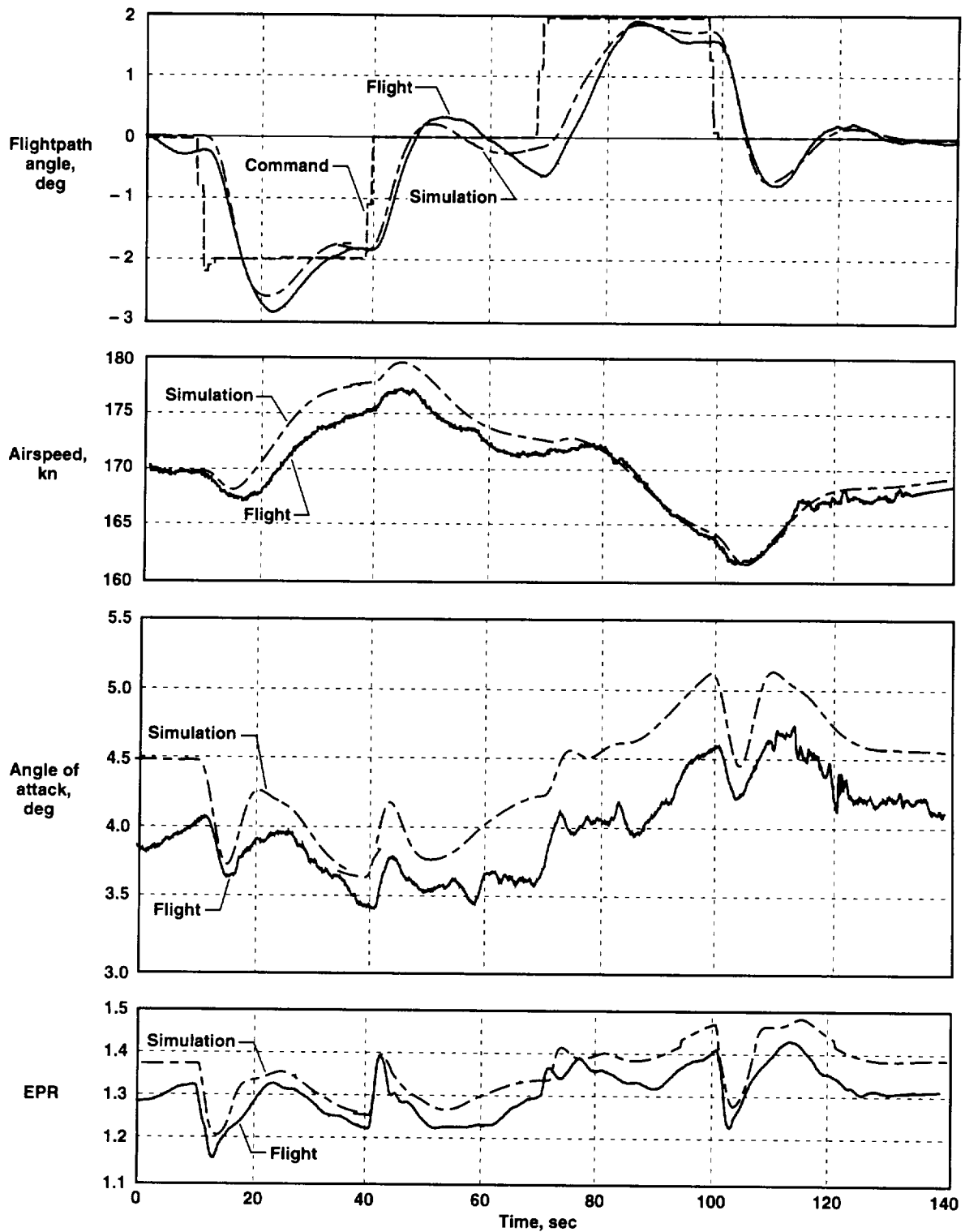

970598

Figure 16. MD-11 airplane and flight deck simulator response to PCA flightpath thumbwheel step commands, gear down, Flaps 28, 10,000 ft, center engine idle.

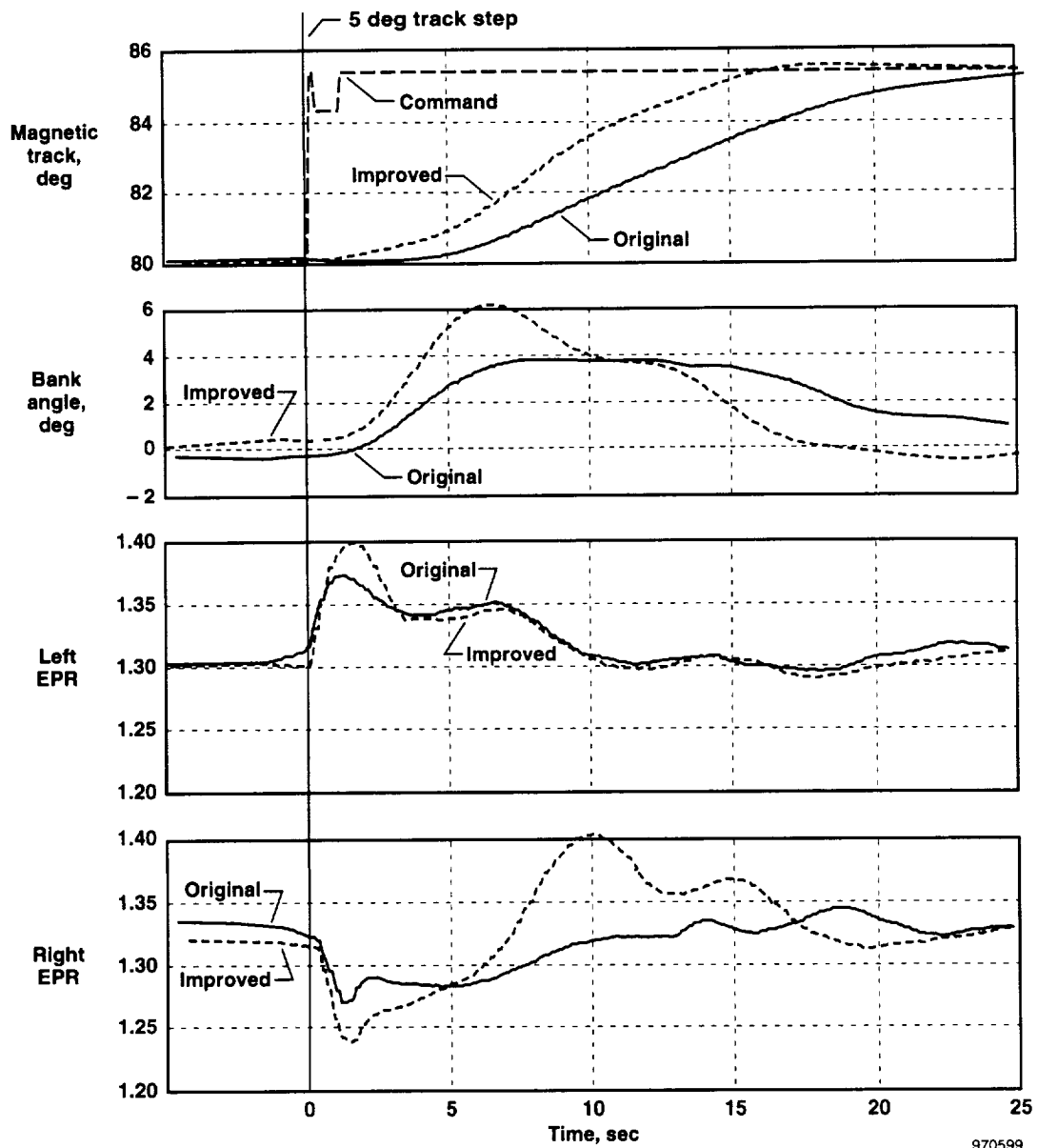

Figure 17. MD-11 PCA small track change response; original and improved gains, 12,000 ft, airspeed = 170 kn, gear down, Flaps 28, center engine idle.

Runway Approaches

Following verification of the improved track response, approaches were made to the runway. After establishing the airplane configuration with gear down, Flaps 28, and the stabilizer trimmed for an airspeed of approximately 170 kn, the flight controls were released and not touched, thus simulating a flight control failure that could occur immediately after takeoff. The PCA system was engaged. Once on final approach, the pilots usually set the PCA flightpath command to the desired glideslope, and then spent most of their attention making track corrections to achieve and maintain runway alignment. In the summer turbulence at Yuma, Arizona, it was difficult to judge on their first few approaches, the inputs required to maintain runway alignment. However, control seemed adequate to consider actual PCA landings. Sink rate is not shown on the time history plots; however, it is a function of FPA and airspeed. At 200 kn, FPA = -1° for example, is equivalent to a 5.9 ft/sec sink rate.

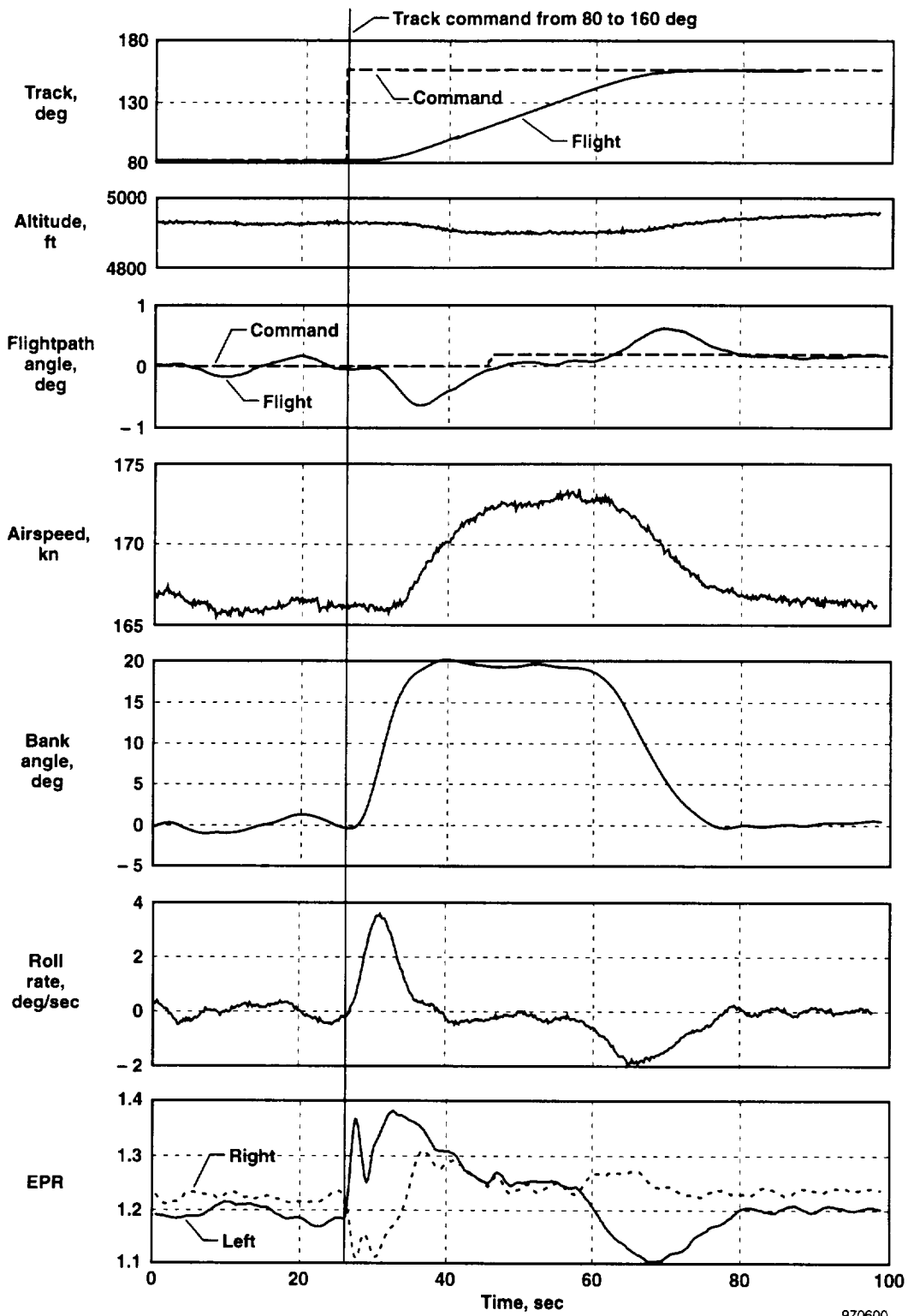
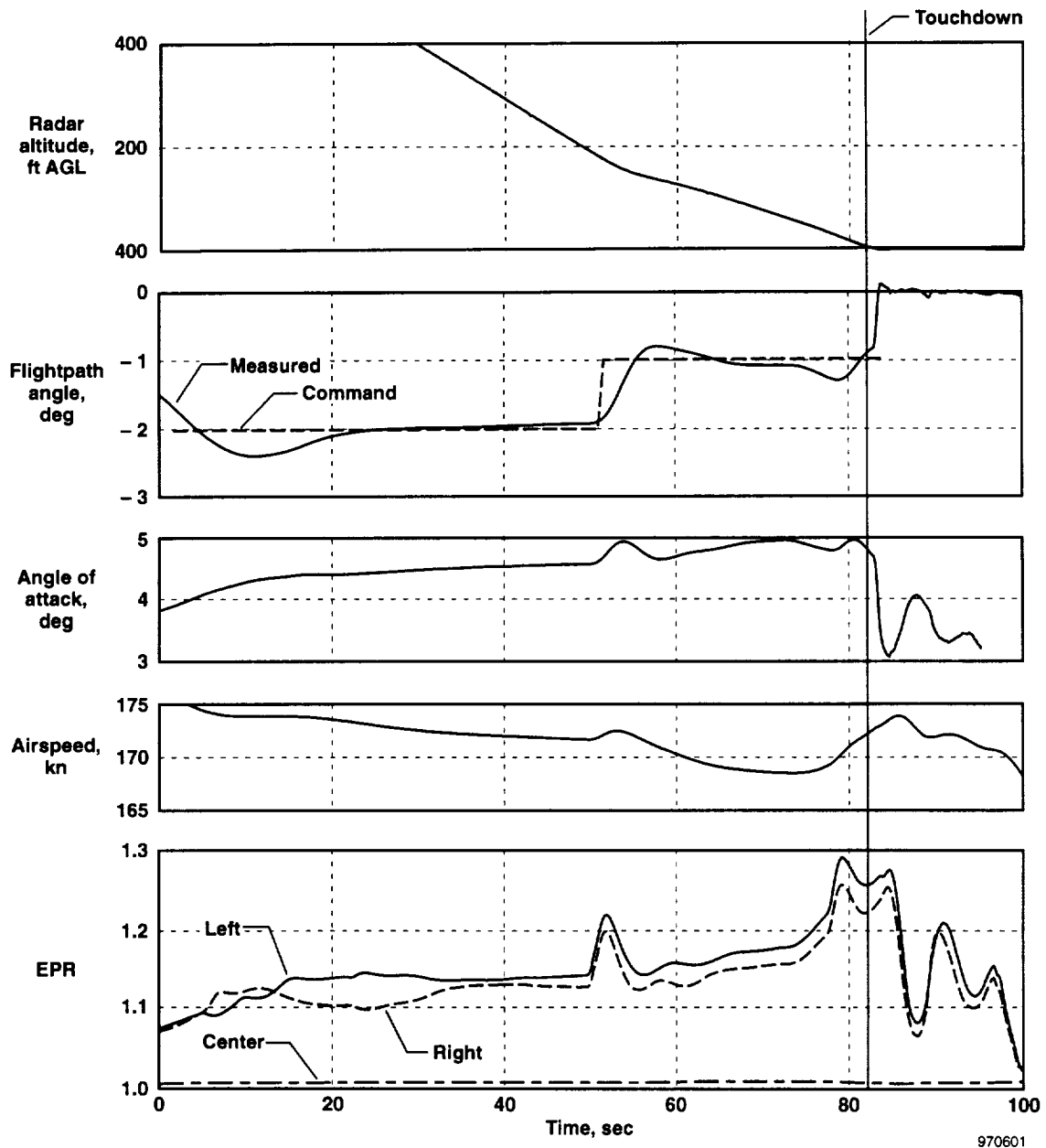

Figure 18. Time history of MD-11 PCA track change of 80°, gear down, Flaps 28, center engine at idle.

PCA System Landings

PCA system landings were practiced in the FDS using the flight FCC and flight software load. The technique was found to produce consistently safe landings (fig. 19). The simulator pilot shallowed the flightpath to -1° at 200 ft AGL. At 50 ft AGL, the ground effect caused a slight pitchdown, and the PCA system added thrust, which reduced the sink rate and resulted in a touchdown at a sink rate of 5 ft/sec. This technique was planned for the first attempts to make actual PCA landings.

The MD-11 was flown to Edwards AFB, where a 15,000-ft long, 300-ft wide runway was used for initial PCA landing attempts. Pilot A flew three PCA low approaches to gradually lower altitude PCA system go-arounds.



970601

Figure 19. Time history of MD-11 Flight Deck Simulation PCA landing, Flaps 28, no wind or turbulence.

Continuous light turbulence and occasional upsets from thermals occurred; however, PCA performance was judged adequate to proceed to PCA landings. On the first intended landing (fig. 20), initial lineup and flightpath control were good. Based on simulation experience, the pilot selected a flightpath of -1° at 140 ft AGL. The flightpath overshot to approximately -0.5° and then began to decrease back through the -1° command. At 30 ft AGL, the sink rate was increasing to 8 ft/sec, so the safety pilot, as briefed, made a small nose-up elevator input, then allowed the airplane to touch down under PCA system control. The touchdown was 25 ft left of the runway centerline, 5000 ft from the threshold at a sink rate of 4.5 ft/sec. The MD-11 was stopped using reverse thrust and brakes but no spoilers or nosewheel steering.

The second landing, shown in figure 21, was accomplished using a slightly different flightpath control technique. Pilot A made small track changes to maintain runway lineup and set the flightpath command at -1.9° for the initial part of the approach. Airspeed was 175 kn. At 200 ft AGL, based on the experience with the first landing, the pilot shallowed the flightpath to -1° , and at 100 ft to -0.5° . The airplane touched down smoothly on the centerline at a 4 ft/sec sink rate, 3000 ft from the threshold with no inputs from the safety pilot. Note the upset from a thermal updraft that caused the airplane bank angle to increase to 8° at 100 ft AGL; the PCA track mode corrected without any pilot input. The airplane was stopped using reverse thrust and light braking but no flight control inputs. Pilot A rated the pitch control as excellent and the lateral control as adequate on this landing.

From the two landings in light turbulence, it was observed that PCA generally controlled track and pitch to within $\pm 0.5^\circ$ of command (disregarding the 1° bias in the track command). EPR values on approach were approximately 1.15, and variations were normally approximately ± 0.1 ; a 0.4 EPR differential thrust was used to correct for the thermal upset. Ground effect was similar to that seen in the simulator.

Later in the day, additional Flaps 28 approaches were conducted at Edwards AFB by pilot C. By this time, the afternoon turbulence activity had increased so much that the new pilot using the PCA mode had difficulty adequately maintaining a stable approach. Next, three approaches with flaps and slats retracted were conducted with a go-around at 200 ft AGL. The first approach was at Edwards, and the last two were at Yuma. The results from all three approaches indicated that the aircraft, using PCA system control, arrived at a suitable position to land on the runway. PCA system operation was also evaluated en route from Edwards to Yuma using all the PCA modes. Testing during this period included phugoid investigation, step responses, rudder trim offsets, and frequency sweeps.

The only significant problem encountered in PCA testing to this point was the sluggish and difficult-to-predict lateral control on approaches in turbulence. Pilots found that three or four approaches were required before adequate lineup was consistently achieved.

Pilot A, the NASA project pilot, had extensive PCA simulator experience and flight experience before attempting actual landings, and thus did not represent the experience level of a pilot who might actually be making an emergency landing. However, pilot D had an opportunity to fly the PCA system on the MD-11 with only a few approaches in the simulator. The following text describes the first four approaches in the MD-11 by pilot D.

The approaches were made with a weight of 410,000 lb and a CG of 24 percent. Continuous light-to-moderate turbulence from thermals occurred, and lineup was complicated by the use of runway 03L at Yuma, which has a relatively short straight-in approach because of its proximity to the Mexican border. The first approach with Flaps 28 at 170 kn was not lined up well because the new pilot had difficulty using the track mode on an approach with a short sharp turn to final; it was aborted at 300 ft AGL, displaced 200 ft left of the runway centerline.

The second approach, made with flaps and slats retracted at 210 kn, was unsuccessful because the higher approach speed made the turn-in and lineup even more difficult. The turning radius was large, and the descent point

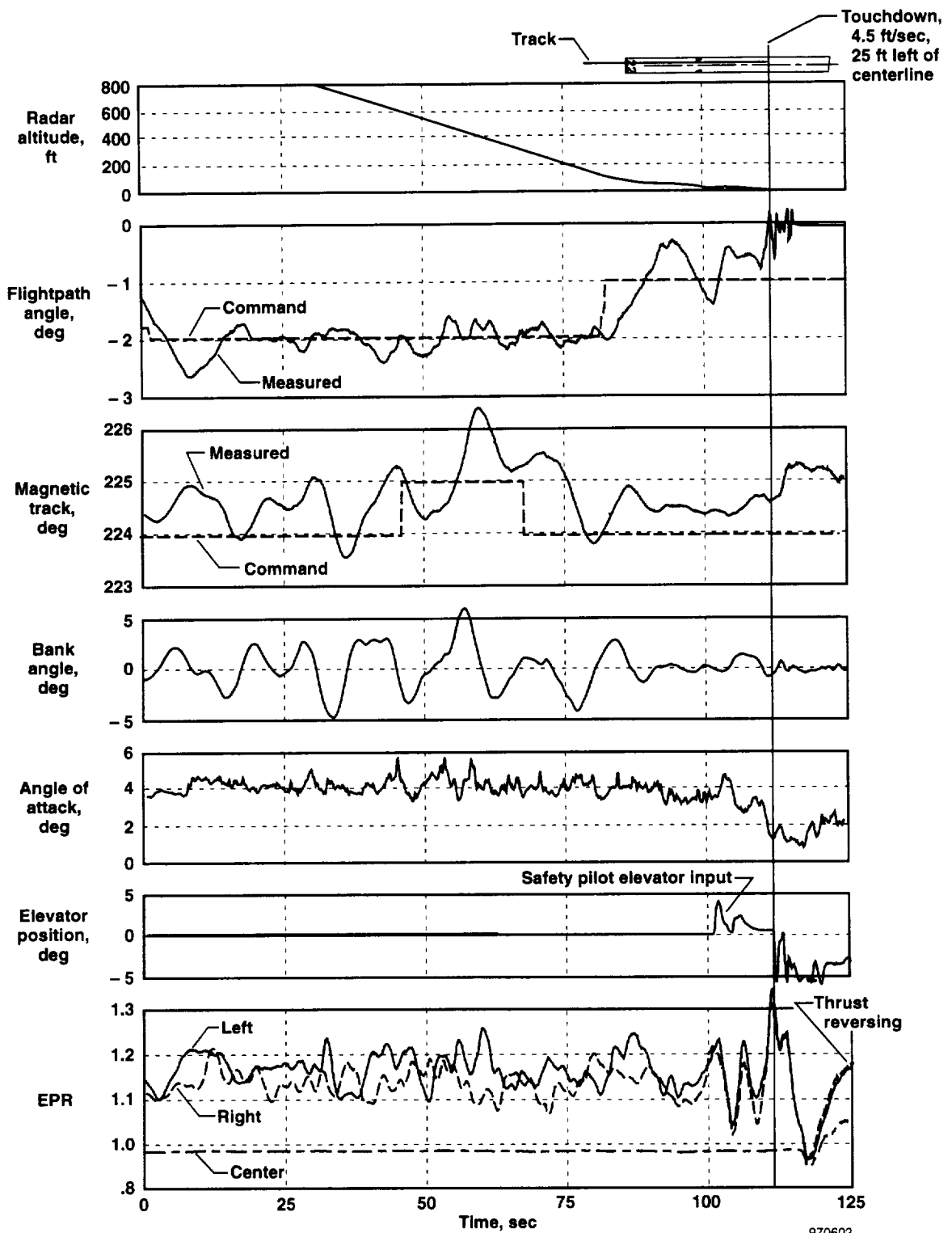

Figure 20. Time history of first PCA landing, Flaps 28, 180 kn, light turbulence, pilot A.

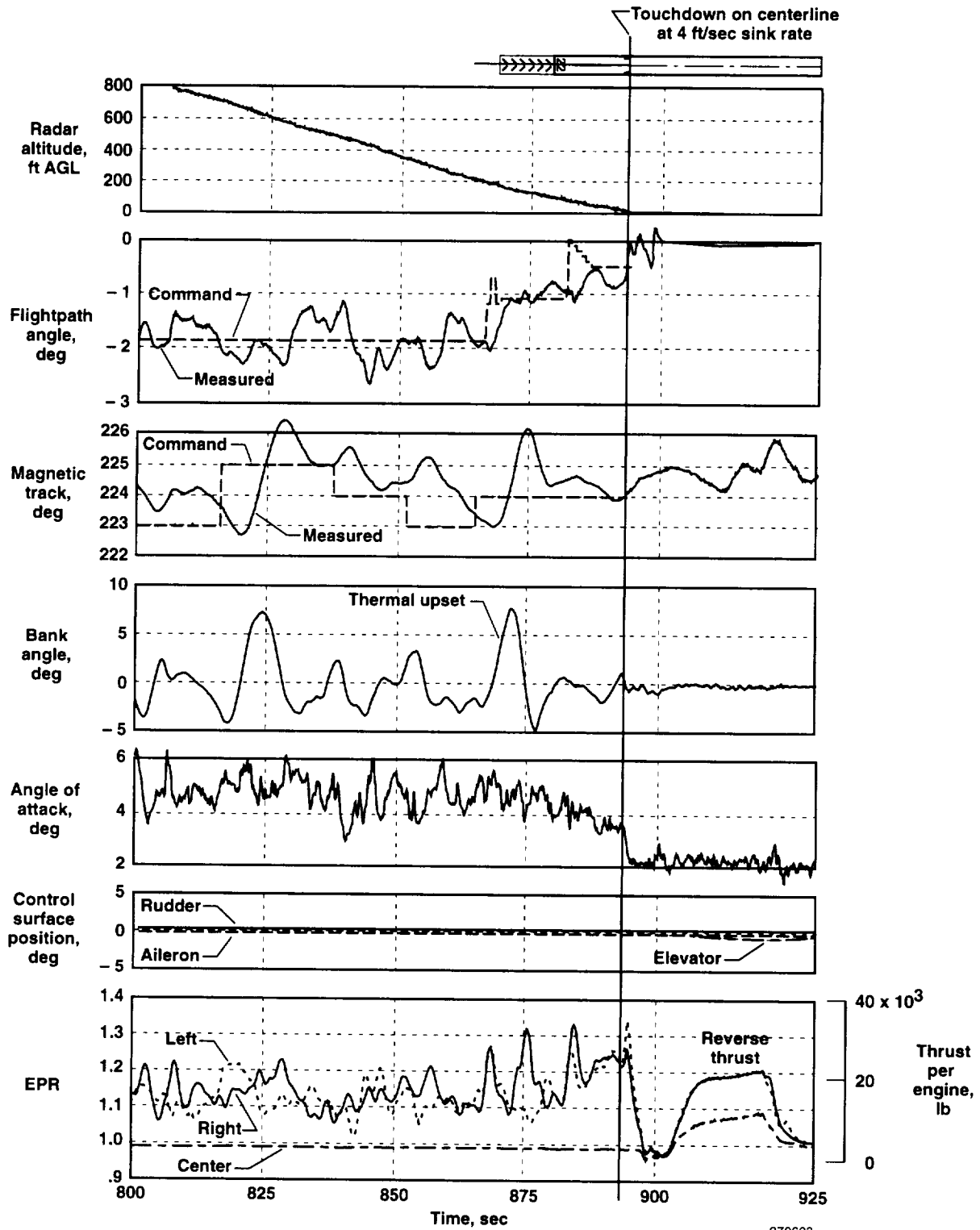

Figure 21. Time history of second PCA landing, airspeed = 175 kn, Flaps 28, light turbulence with occasional thermals, no control surface movement, pilot A.

was reached well before lineup. Once on the glideslope, the engines were near idle and lateral control was very poor. This approach crossed the runway threshold 300 ft AGL and was aborted.

The third approach by pilot D was flown with flaps up but slats extended at an airspeed of 180 kn to simulate operation in the enhanced mode discussed earlier. In this case, the pilot was to use the PCA system FPA mode for pitch and the bank angle mode for lateral control. Figure 22 shows the time history and cockpit views at four times on the approach. Turbulence is evident in the airspeed excursions of ± 2 kn. Lateral deviations were mostly held within the 200 ft width of the runway, and the airplane was near the centerline when the 200-ft go-around altitude was reached. Bank angle commands were generally within $\pm 5^\circ$, and bank angle control was sluggish but tracked well. Pilot D commented that he had a mild pilot-induced-oscillation tendency in the lateral axis as he learned to compensate for the sluggish lateral performance. EPR averaged 1.05 with the flaps retracted. A PCA go-around was made at 200 ft AGL; the airplane was near the centerline as it crossed the threshold, as shown. In this third approach, the pilot had begun to learn to compensate for the sluggish lateral control.

The fourth approach (fig. 23) was flown by pilot D with Flaps 28 and a 1.5° offset on both rudders to simulate yaw asymmetry of the United Airlines flight 232 accident situation. This approach, using the track mode, was lined up well throughout, indicating the improvement as pilot D became familiar with the lateral response. Once established on final, there was considerable engine activity because of turbulence, even though only very small pilot track changes and no flightpath changes were made. The left engine averaged about 0.1 EPR lower (about 10,000 lb thrust) than the right to counter the rudder offset. Note the ± 2 -kn airspeed changes from the turbulence, the increased average airspeed of almost 10 kn on the glideslope, and the extensive EPR activity to maintain control in the turbulence. A PCA go-around was initiated at 200 ft AGL. Go-around performance was good; approximately 60 ft was lost before achieving a positive rate of climb.

In smooth air, new pilots could make successful PCA approaches on their first try. Figure 24 shows the first approach of pilot E, one of the demonstration pilots. This pilot had a brief simulator session but no previous flight experience with the PCA system. He engaged the PCA system on the base turn, used the PCA system FPA and track modes, used 1° and 2° track changes, and reached the predetermined go-around point near the runway centerline. One other demonstration pilot had similar success in smooth air.

PCA System Envelope Expansion

In October 1995, following successful completion of the PCA landings, PCA operation was tested beyond the original design envelope, as summarized in figure 25. Based on simulation results, PCA performance was expected to degrade as altitude increased because of slower engine response and degrading dutch-roll characteristics. PCA was tested at mid and aft CGs, at altitudes from 200 to 30,000 ft MSL, at speeds from 160 to 360 kn, with a 1.5° rudder offset, with a 7° aileron offset, and with all hydraulics off. Approaches were flown with a takeoff flaps setting of 28° , with slats only, and with no flaps or slats. The center engine was used for speed control. PCA engagement in mild upset conditions was tested.

Speed Control

The third FADEC was installed on the center engine, providing the low-frequency speed control mode shown in figure 14(a). This mode worked very well; trim speed could be changed 30 kn greater and less than the initial trim speed. FPA was maintained within 1° during speed control operation. Figure 26(a) shows a time history of a speed change from 250 to 270 kn at an altitude of 10,600 ft. Starting at 247 kn, the speed command was increased to 270 kn. The center engine, which was initially at idle, increased thrust in response to the command, while the wing engines decreased thrust to maintain flightpath. After 50 sec, speed was 268 kn, and slowly increased to 270 kn.

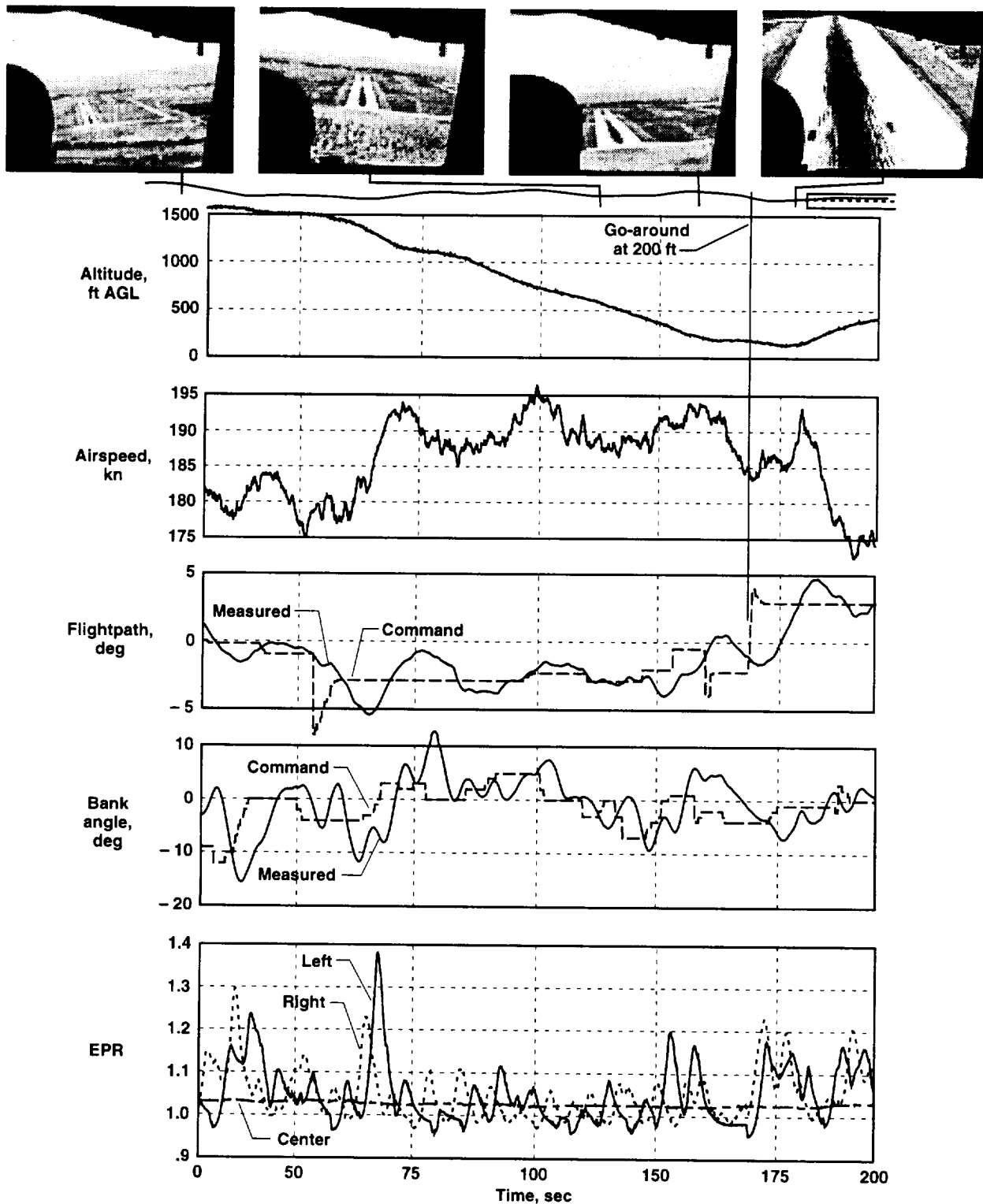
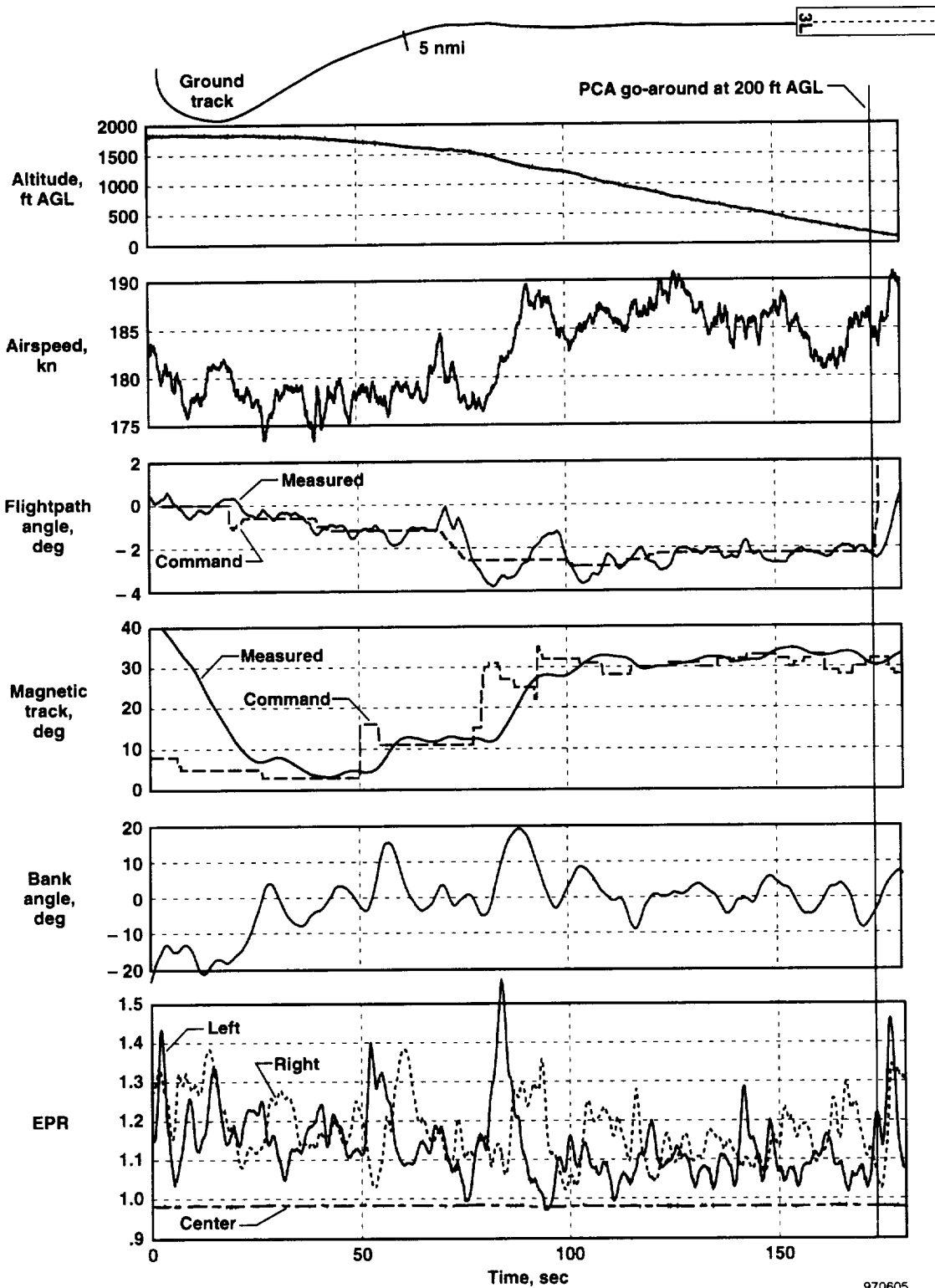
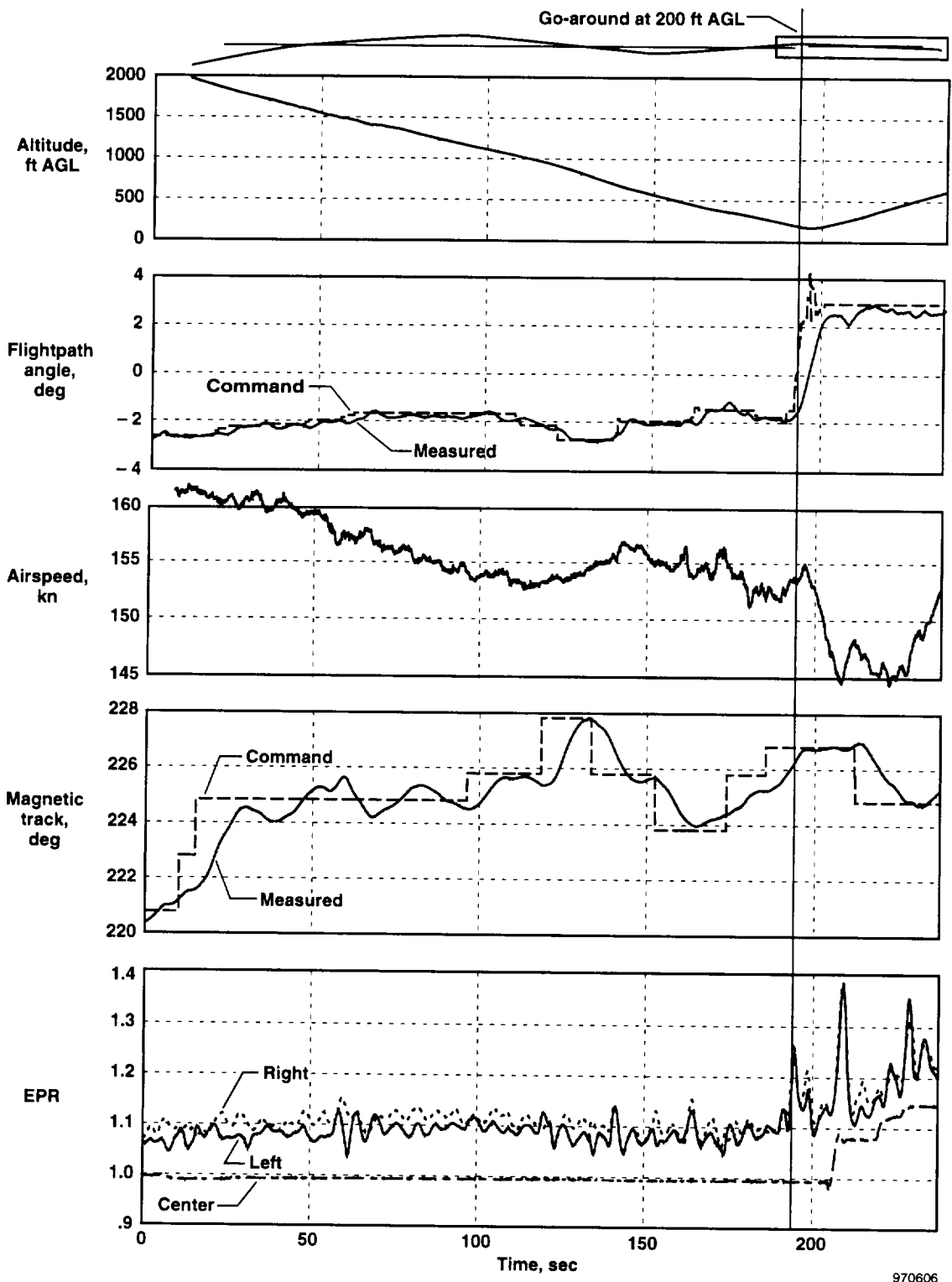

Figure 22. Time history of pilot B's third PCA approach and go-around, slats extended, flaps retracted, gear down, bank angle mode, light-to-moderate turbulence.



970605

Figure 23. Time history of fourth approach by pilot B, 1.5° rudder offset, gear down, Flaps 28, track mode, light-to-moderate turbulence.



970606

Figure 24. Time history of PCA approach and go-around, gear down, Flaps 28, first approach by demonstration pilot E, smooth air.

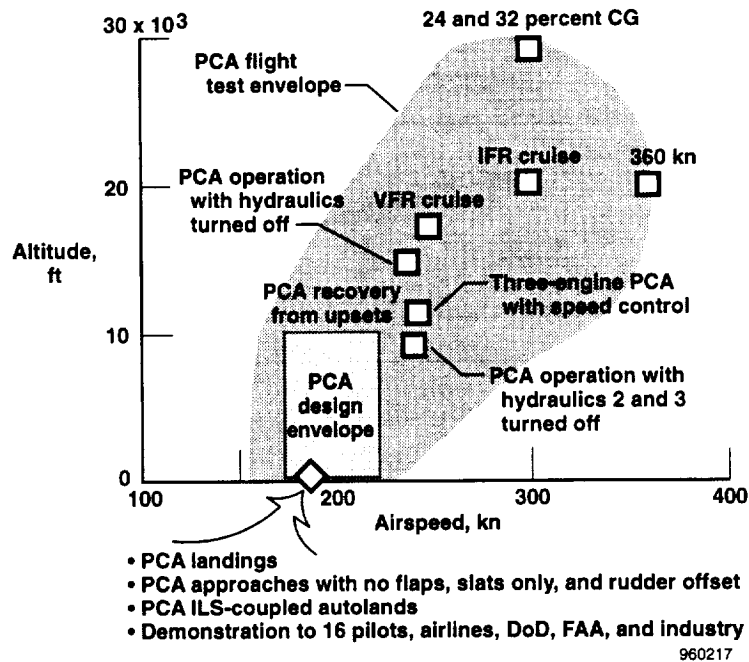

Figure 25. MD-11 PCA system design and flight test envelope.

Later, the speed command was increased to 300 kn, which was achieved with the center engine near maximum continuous thrust and the wing engines near idle.

High-Altitude Testing

PCA was tested at 15,000, 20,000, and 30,000 ft. Contrary to predictions from the simulation, operation was good; FPA was somewhat less damped at the higher altitudes but still adequate. Lateral control was adequate as well.

Tests at Aft CG

At 30,000 ft, the CG was shifted from 23.6 to 31 percent, and step response tests were conducted. Response was good. Pitch step response was only slightly less damped than at the mid-CG conditions. This lack of sensitivity to aft CG was primarily because of the low-slung engines providing pitching moment without a speed change. Figure 26(b) shows a time history of PCA performance at 29,000 ft with the CG at 31 percent. The speed control mode was engaged. A 180° turn was commanded; differential thrust was commanded to roll to the 20° bank limit, which took approximately 12 sec. Roll-pitch coupling caused a small FPA decrease; 150 ft was lost. The increased thrust caused a speed increase, as it did at low altitudes (fig. 18). The speed control loop reduced the center-engine thrust to hold speed. Once stabilized in the turn, the FPA converged to level flight and held it well. During the turn, a -1° FPA command was made. Response was good, similar to that at low altitudes and mid-CG conditions (fig. 16). Center-engine thrust decreased to idle to hold airspeed. During the rollout, a 0.5° pitchup occurred, and the 150 ft lost on the turn initiation was recovered. Although overall performance was slightly degraded, it was still certainly adequate and better than the simulation predictions.

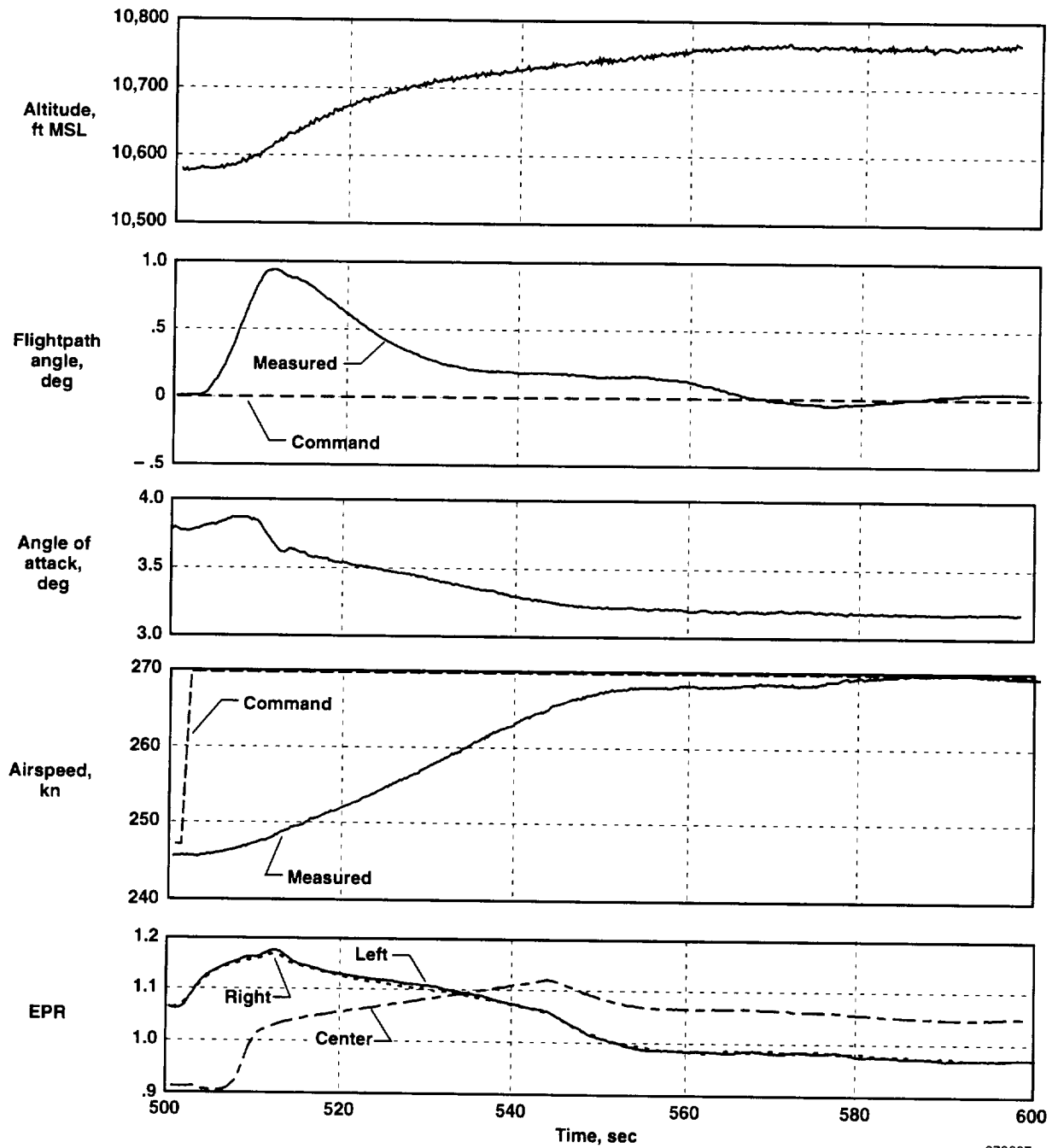

970607

(a) Airspeed command increase from 247 to 270 kn.

Figure 26. Time histories of three-engine PCA speed control mode, gear and flaps up.

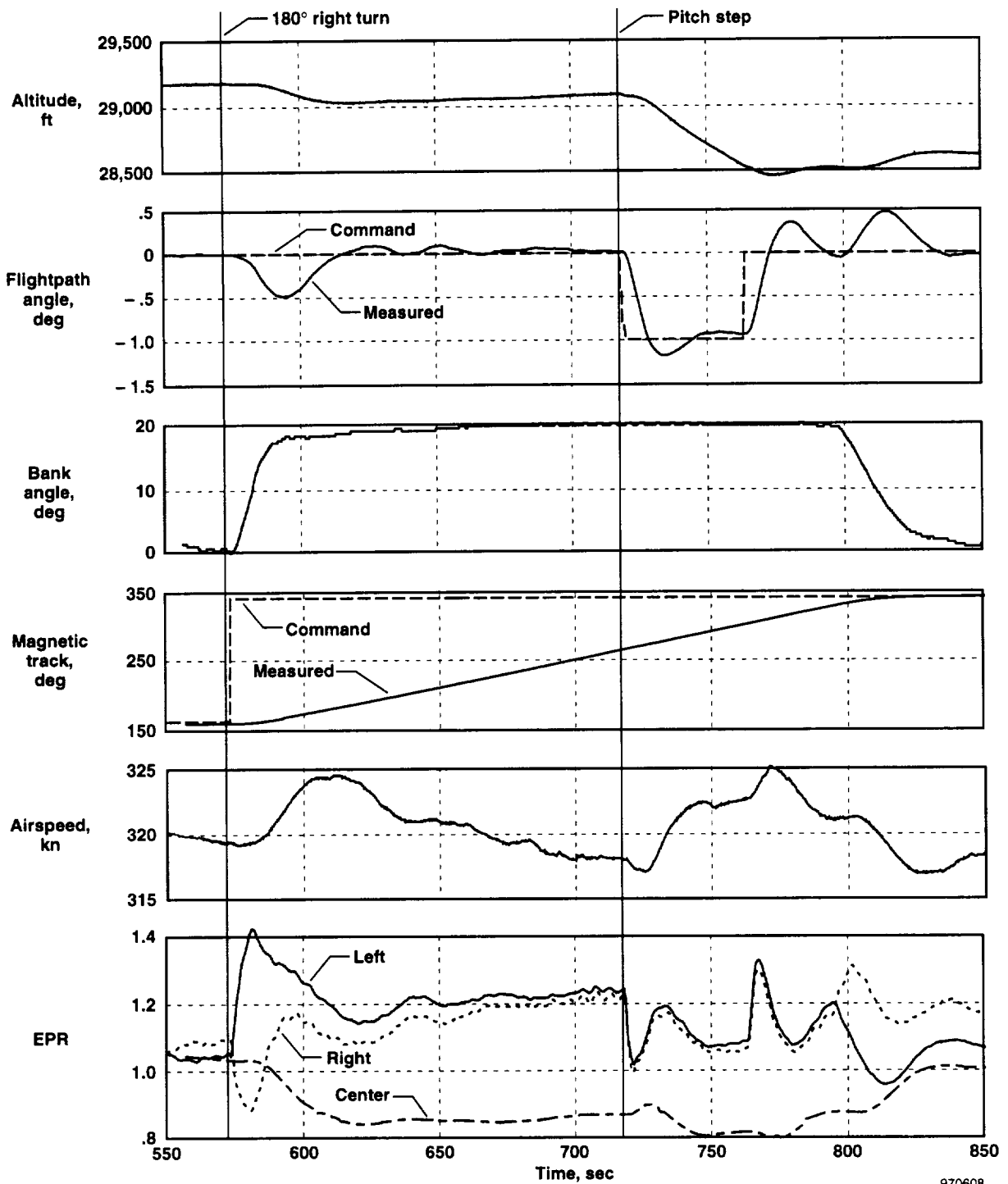

970608

(b) PCA operation at aft CG, high altitude, high speed, CG = 31 percent, speed control on.

Figure 26. Concluded.

Three-Engine Dynamic Pitch Control

Figure 27 shows the three-engine dynamic pitch control mode from figure 14(b). This mode showed better pitch response with less overshoot than the two-engine pitch control. Note that the initial response of the center engine is opposite that of the wing engines, thus increasing the pitch-rate-generating moments due to thrust.

High-Airspeed Tests

PCA was tested at airspeeds to 360 kn and Mach numbers to 0.83 with no degradation in performance.

Recovery From Upsets

With the PCA system enabled but not engaged, the airplane was upset using the normal controls. When the desired conditions were achieved, the pilot released the controls and engaged PCA. All recoveries were successful, the most severe being from a 45° bank and a 7° dive (fig. 28). In this case, with gear and flaps up, two-engine pitch mode, and the center engine at idle, the PCA system logic commanded collective thrust for the flightpath error and then differential thrust to reduce the bank error to less than 20°. A more suitable procedure for upset recovery would be to first level the wings, then correct the flightpath angle error, but PCA system logic is programmed so that on initial engagement, it tries to simultaneously achieve the commanded flightpath and track. In the upsets, the track deviated many degrees during the recovery; so after flightpath was stabilized, there was still a track error, and the airplane returned back to the reference track command.

A recovery from a more severe upset was flown in the FDS (fig. 29). In this case, the bank angle was 80° with a flightpath of +5°. The initial differential thrust input was overridden (still with a 60° bank) by both engines going to full thrust to reduce the FPA error. After 13 sec, the differential thrust input again was honored, with bank angle reduced to 20°, before the pitch command error drove both engines toward idle thrust. Recovery to level flight was completed 57 sec after the upset.

In both the flight and FDS cases, getting the wings level was delayed by pitch priority. A more suitable procedure for upset recovery might be to first test the bank angle upon engagement, and if excessive, level the wings first, then correct the flightpath angle error, and finally correct back to the commanded track.

PCA Operation With Two of Three Hydraulic Systems Off

Turning off hydraulic systems 2 and 3 allowed three of the four aileron surfaces to float. Those surfaces floated up, reducing the lift and increasing trim speed. The offset was small at 300 kn but significant at 200 kn. Figure 30 shows a portion of this test. Both outboard ailerons floated to +12°, and the right inboard aileron floated to +7°. The aileron offset required enough differential thrust that the right engine was near idle. Speed control was still on, so the center engine was well above idle. This situation made turning right difficult (note that the commanded heading was overshoot by several degrees), but PCA did maintain gross control. Several solutions were available: turning off speed control, turning off the last hydraulic system, trimming the remaining inboard aileron to eliminate the asymmetry, or lowering the landing gear to raise the throttle settings.

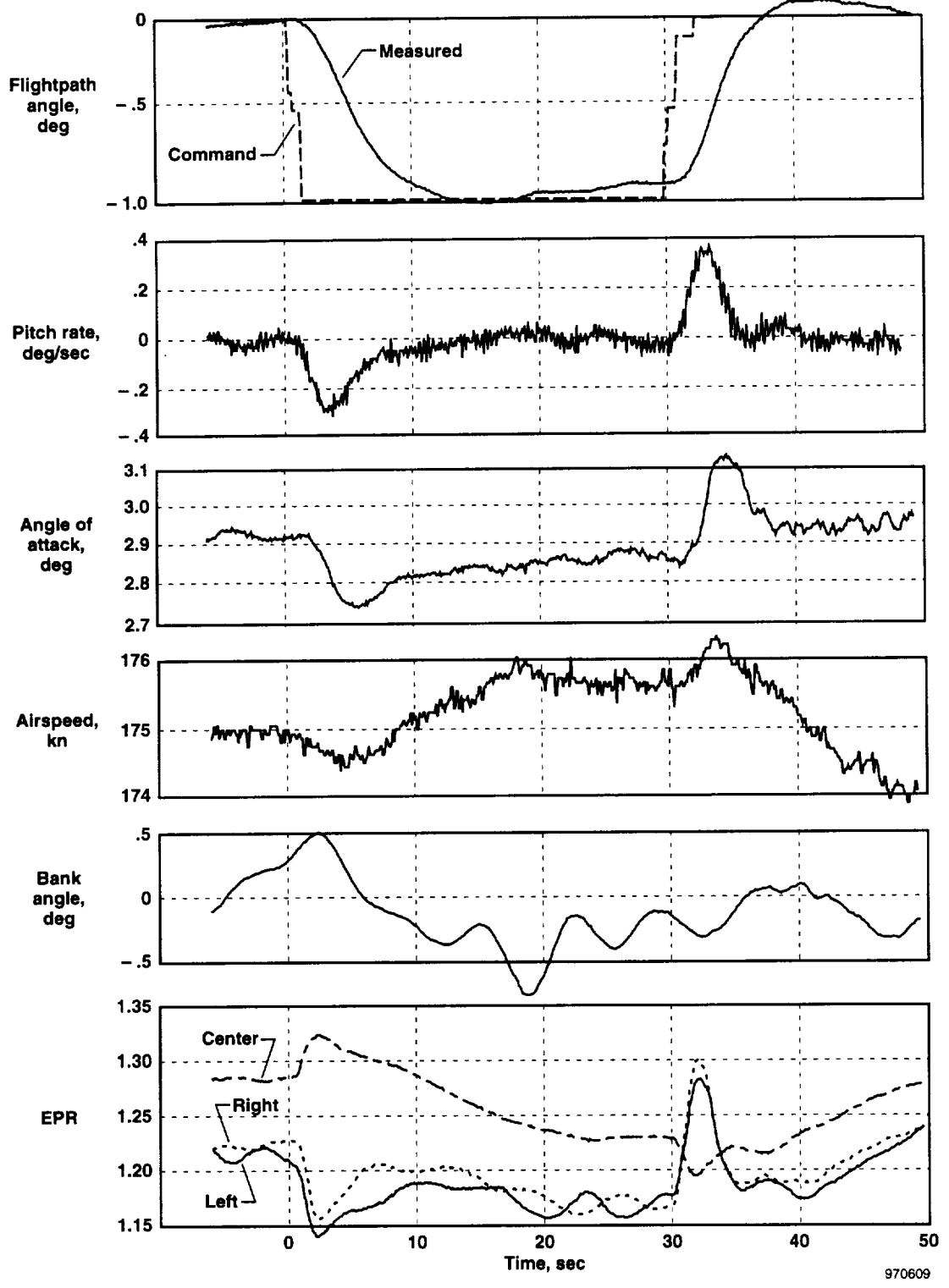

970609

Figure 27. Time history of MD-11 flightpath steps, three-engine dynamic longitudinal mode, 17,000 ft, gear down, Flaps 28.

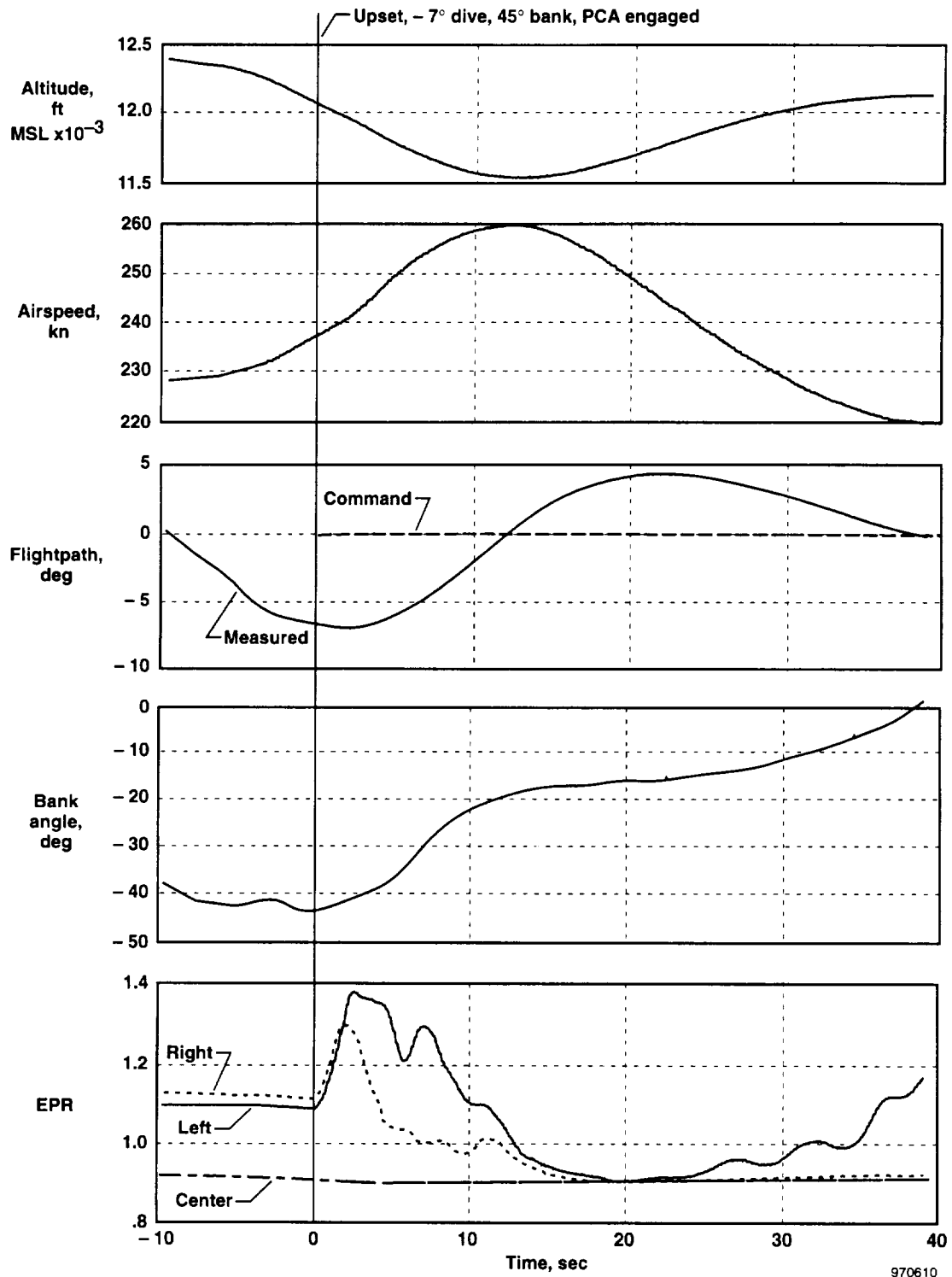
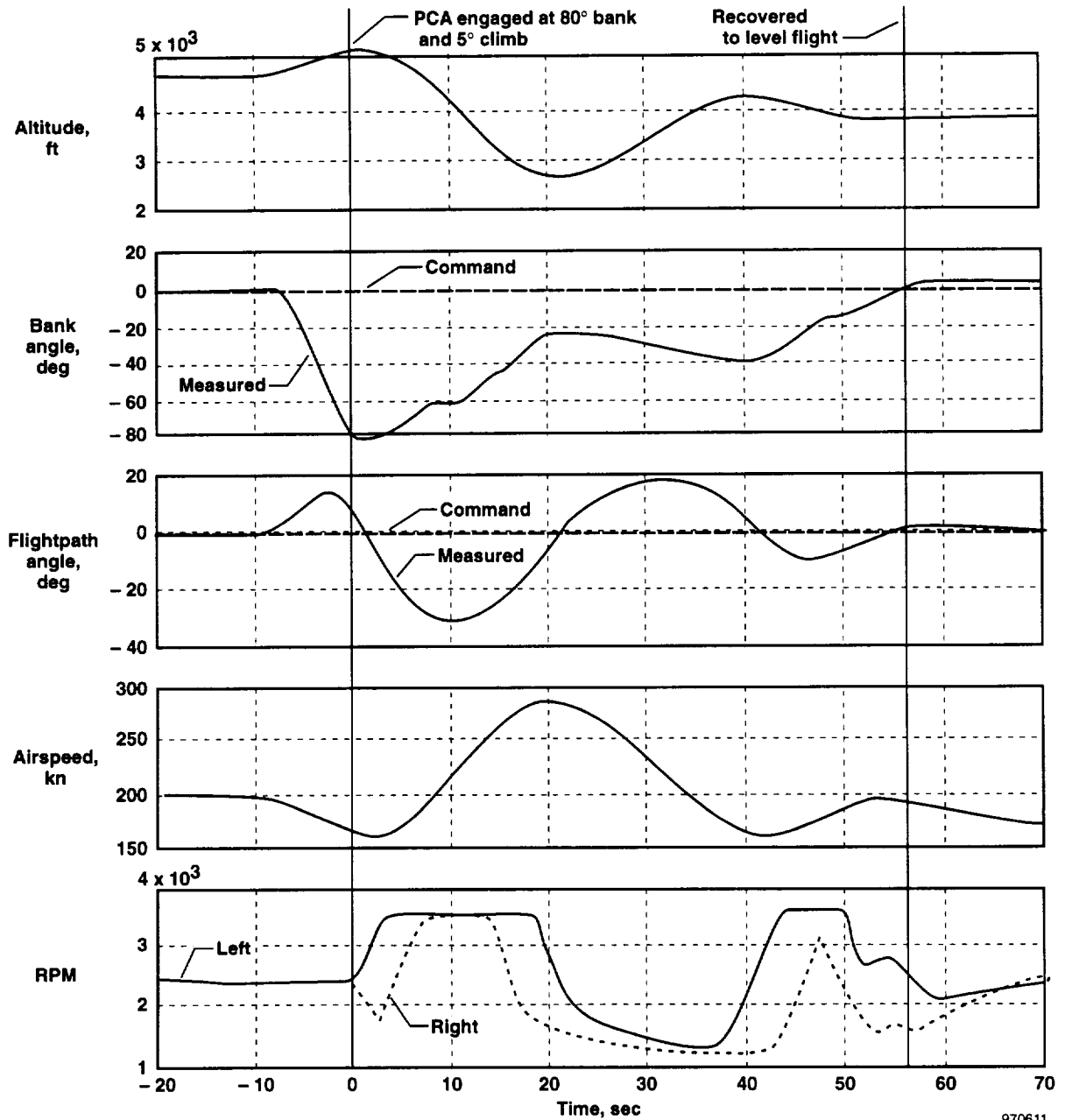
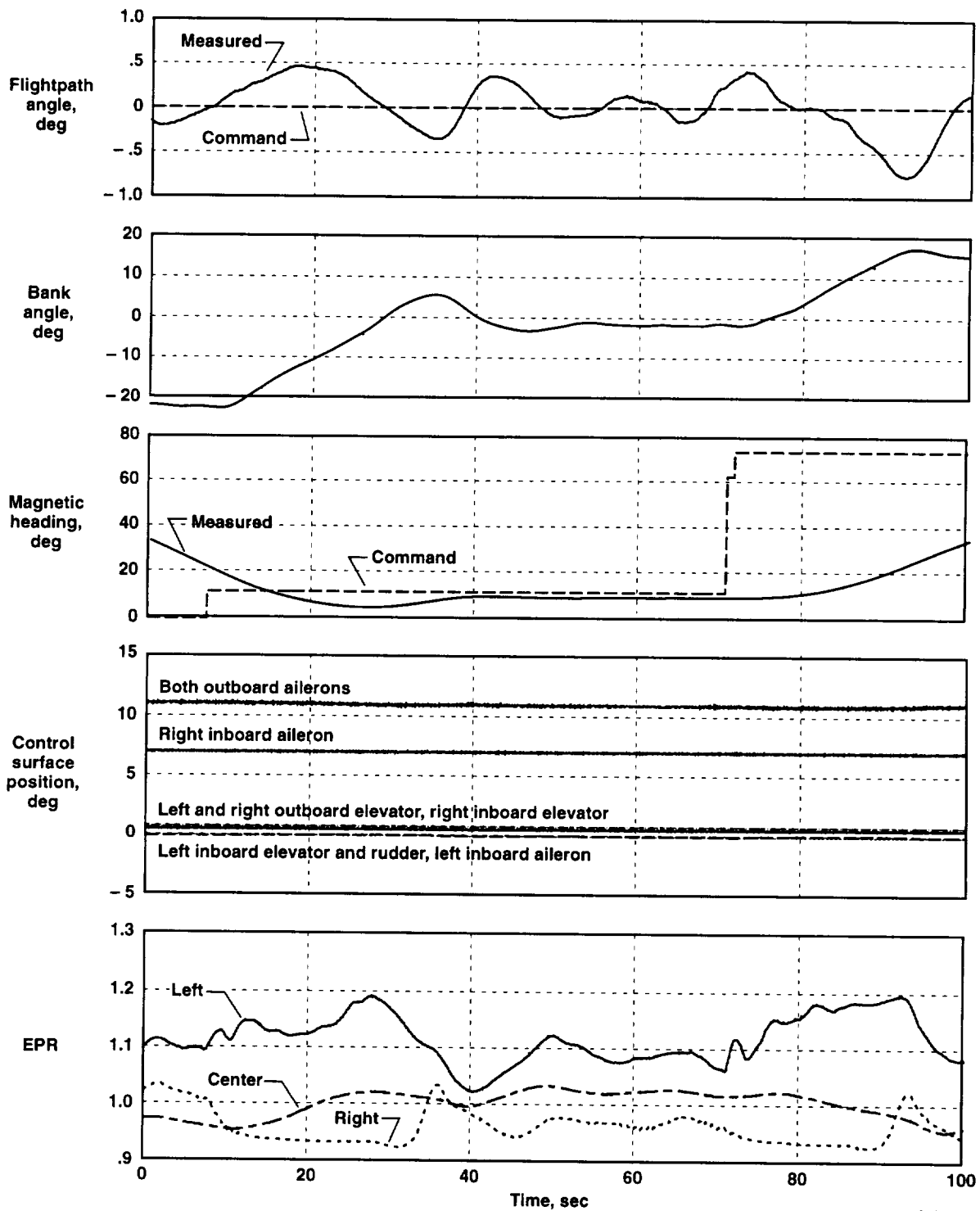

Figure 28. Time history of PCA system recovery from a 7° dive/45° bank upset condition, gear and flaps up, no flight control movement.



970611

Figure 29. FDS time history of MD-11 PCA upset and recovery, 200 kn, 4800 ft AGL, gear and flaps up, center engine idle.



970612

Figure 30. Time history of MD-11 PCA operation with hydraulic systems 2 and 3 off, three of four ailerons floating, 220 kn, 10,000 ft, gear up, flaps up, CG = 31 percent, speed control mode on.

PCA System Operation in the Enhanced Mode

As discussed earlier, the MD-11 and DC-10 aircraft incorporate hydraulic fuses in hydraulic system 3 so that control can be maintained in case an uncontained failure in the tail engine severs all three hydraulic systems in the tail. With this control capability, a landing may be accomplished, although the lack of phugoid damping makes flightpath control very difficult.

For the flight test, this configuration was made available by installing a switch to activate the tail hydraulic shutoff valve. Activating this switch, coupled with turning off hydraulic systems 1 and 2, effectively left the aircraft in the enhanced configuration with no hydraulics to the elevators and rudders, and hydraulics to one-half of the stabilizer trim actuator, only one of the four ailerons, and the leading edge slats. The PCA system test in the enhanced mode was performed to see whether flying qualities were substantially improved.

The initial test conditions flown were at a speed of 220 kn at 13,000 ft AGL with the landing gear down, flaps up, and slats extended. The gross weight and CG were ~361,000 lb and 24.7 percent, respectively. The roll thrust gain was zeroed with an MCDU input so that only aileron control was available for the lateral mode and the vertical mode was controlled through the PCA system. The gain set was the same configuration used for most approaches and landing. Once the configuration was achieved, all elevators and rudders floated to the trail position, which was approximately the normal faired position. The PCA system FPA mode had no problem maintaining level flight or a -1° FPA commanded descent and return back to level flight. With the center engine (number 2) at idle, the wing engines achieved maximum authority at a commanded $+1^\circ$ FPA. Once engine 2 was advanced above idle, the wing engines could modulate and allow a steeper climb.

In the opinion of the flight crew, a safe landing could easily be made in this configuration. The aileron effectiveness was adequate for roll control, and aileron forces were significantly lower than in the simulator. Pitch control was greatly improved using the PCA flightpath mode. No evidence of a phugoid oscillation was seen, even when the stabilizer trim was used to change airspeed.

PCA System Operation With All Hydraulics Off

Figure 31 shows a time history of tests with all three hydraulic systems turned off. Before the time shown, all hydraulic systems had been off for several minutes. The outboard ailerons had floated to $+12^\circ$, the inboard ailerons floated to $+5^\circ$, while the elevators floated near 0° . Contrary to simulation results, the floating surfaces resulted in a nose-up pitch and caused a lower trim speed. Lowering the landing gear was planned, which was expected to lower the trim speed further. Because airspeed was already near the minimum speed for flaps-up flight, hydraulic system 3 was turned on as shown, the ailerons returned to the trim position causing a pitchdown, and the stabilizer was retrimmed to a higher speed position. When hydraulic system 3 was again turned off, the ailerons again floated up and the pitchup occurred again. The PCA system reduced the throttles to idle to reestablish the commanded flightpath, and speed stabilized at 212 kn. After a small track change, the landing gear was lowered using the alternate gear extension system. With the gear doors down and the wheel wells remaining open, speed decreased to 195 kn. Note that lowering the gear moved the aileron and elevator slightly; the hydraulic pressure was zero, but of course fluid was still in the system. The PCA system maintained flightpath well in this transient. Track and pitch control at this point were normal, identical to that with hydraulics on. A simulated landing approach was made using a -2.5° glideslope with a small track change. A large track change was commanded at 560 sec; bank angle stabilized at its 20° limit, and flightpath was stepped back to level flight. The center main landing gear was then extended, resulting in another small disturbance to the surface positions. PCA control remained normal. Hydraulics were then turned back on still under PCA control.

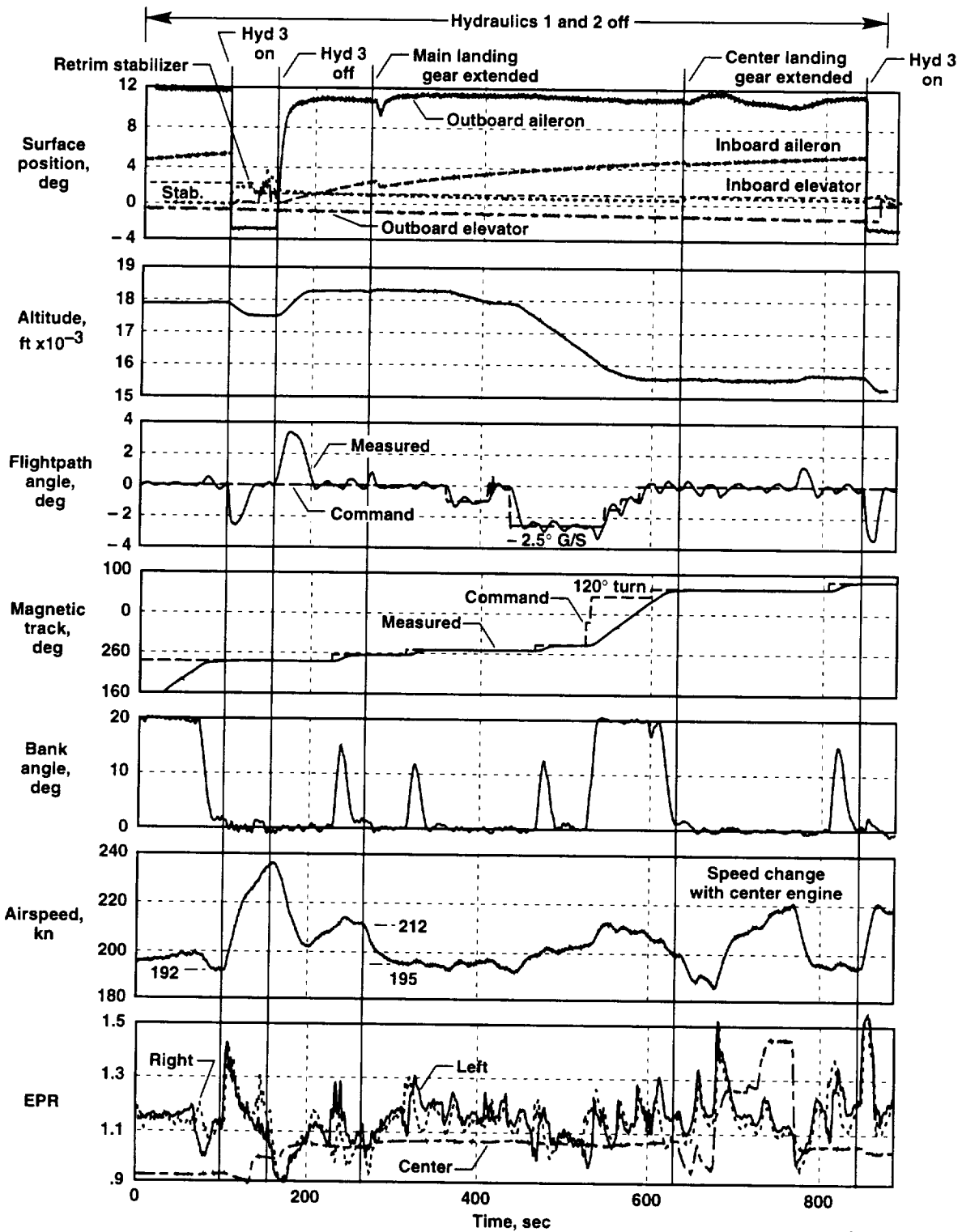

970613

Figure 31. Time history of MD-11 PCA operation with all hydraulic systems turned off, flaps up.

This test verified that the PCA system can control the MD-11 with no hydraulic pressure, and that the floating surfaces make little or no change in the PCA system response or stability. The test also showed that simulator predictions of the effects of floating surfaces were not correct. The simulation predicted that the outboard ailerons would float to 17°, whereas the flight data aileron position was approximately 12°.

PCA System and Rudder Mode

A partial-failure PCA test was conducted at ~12,000 ft at an airspeed of 175 kn, with gear down and Flaps 28. The test consisted of using only the longitudinal mode of PCA (FPA) in conjunction with the rudder for achieving lateral control. This test would simulate a failure mode that is possible in some aircraft that have an all fly-by-wire flight control system except for the rudder. The wing-engine PCA roll gains were zeroed to preclude any PCA differential thrust inputs. PCA system pitch control was normal, and after becoming familiar with the aircraft response to rudder, the pilot could effectively control bank angle and heading. With the yaw dampers off, rudder inputs excited the dutch roll, but at 175 kn, it was reasonably well damped. Pilot A commented that this configuration was controllable with a 2° to 3° roll oscillation, which is satisfactory for flying at altitude but another evaluation would have to be made for flying this configuration in a lineup to a runway. In a later test, this same mode was selected at low altitude in light-to-moderate turbulence. Pilot A flew a descent and turn to downwind and was pleasantly surprised with the controllability.

Rudder With Wing Engine Failed, PCA System Control

This test was configured as the earlier test except that a wing-engine failure was simulated by retarding engine 3 to flight idle. In this case, the pitch thrust gain on the remaining engine was doubled to increase the authority for pitch response and control. The pilot controlled bank angle with rudder, and the PCA system controlled pitch with the wing engine. The center-engine thrust was manually set by the pilot to provide an acceptable average thrust setting for the wing engine. Because of the lateral thrust asymmetry, every pitch input generated a large rolling input as well. The results were that PCA vertical control was much more loose, the dutch roll was more pronounced, and the aircraft control was much poorer than in the earlier test. Minimum simulator development had been done on this mode (it had been successfully flown on the F-15 (ref. 1)), and more development would be required for acceptable performance.

Sustained PCA Operation

In addition to the PCA system testing, PCA operation as an autopilot was sufficiently good that the flight crew used it routinely. At times, the PCA system was left engaged for an hour or more. The crew did not need to disengage PCA to change flight conditions or set up for the next approach. Overall, in the 30-hr flight program, over 25 hr of PCA operation were logged. No unplanned PCA disengagements occurred.

Simulation-to-Flight Comparison

In general, the flight results have compared well with the flight deck simulation. The pitch control in flight is somewhat less damped than in the simulator, possibly because the vertical CG in the test airplane is lower than in the simulation. The somewhat sluggish and difficult lateral control effects on approach are well modeled. Anticipated lateral control instability at higher altitudes, based on simulation, was not found in flight. The trim speed change caused by turning off all hydraulics was of the right magnitude but in the opposite direction.

Pilot Comments

Pilot comments were recorded on the cockpit video immediately after each approach. Pilot A, the project pilot, reported that pitch control was excellent and that all of the workload was in the lateral task. He reported that, in turbulent air, it was difficult to anticipate the lead needed for track changes, and that it was necessary to get established on the extended centerline well out and use only small inputs. After the PCA landings, he commented that he was really impressed that control was so good that not only a survivable landing but a normal landing could be made using PCA control. Pilot C reported that he would not have believed that such precise control could be achieved using only the wing engines. Other pilots also found that the lateral control was sufficiently sluggish that considerable experience was needed before learning how to maintain runway lineup.

Need for Coupled Approach

At this point in the flight test, it was obvious that the lateral control was sufficiently sluggish that a pilot could not be sure of making a successful approach on the first try with a significant level of turbulence. An ILS-coupled PCA mode had been developed and evaluated on the B-720 PCA simulation at NASA Dryden and on the medium twin-jet simulation at NASA Ames (ref. 7), and it worked very well. Therefore, the ILS-coupled mode was incorporated into the MD-11 PCA system. Honeywell added this capability using the existing MD-11 ILS-coupled logic and displays as much as possible. This capability was to be a concept demonstration only, and no attempt was to be made to optimize the ILS-coupled system. Requirements were to capture the ILS localizer (LOC) first within a 30° intercept and from below the glideslope. The glideslope to be flown was adjustable from 0.5 to 1.5 dots (1 dot is 0.35°) below the glideslope to keep the thrust required well above idle. A simple two-step autoflare capability was also added. Transition from glideslope control to the first flare was smoothed by a filter with a 2-sec time constant. Because sluggish lateral control was the impetus for the coupled approach, the capability to fly a LOC-only approach was also added. In this mode, the pilot would couple to the LOC for lateral guidance and would use the FPA thumbwheel for glidepath control.

The standard MD-11 ILS glideslope control logic includes integration of terms including true airspeed and attitude, which were not optimized for this concept demonstration. The objective was to demonstrate improved control suitable for an emergency landing down to 20 ft AGL, with a goal to make actual landings.

PCA-ILS Approaches

The ILS-coupled PCA logic was checked and approaches were flown. Two were conducted at Edwards on runway 22, and seven were performed at Palmdale, California on runway 25. Figure 32 shows the Edwards and Palmdale ILS information and typical ground tracks flown. The nominal Edwards ILS glideslope was 2.5° ; at Palmdale, it was 3.0° . Because the nominal PCA ILS-coupled approach was flown one dot (0.35°) below the glideslope, the nominal glideslope for PCA approaches at Edwards was 2.15° , while at Palmdale it was 2.65° . All the approaches were flown down to predetermined decision heights and terminated with an automatic PCA system go-around using the TOGA go-around button similar to normal MD-11 operation. The conditions flown were Flaps 28 with aircraft trimmed for a speed of approximately 1.4 times the stall airspeed, and in the two-engine PCA configuration with the center engine at or near idle. All approaches were flown in smooth air with light winds.

The ILS localizer at Palmdale was noisy starting at about 1000 ft above the ground and continuing on down to about 100 ft, but the ILS filtering in the logic effectively smoothed the noise. Localizer intercepts up to 30° were found to be captured immediately, but larger intercept angles resulted in overshoots. (The PCA localizer capture specification was for intercepts less than 30° .) One capture at a 50° intercept had three overshoots before stabilizing at 500 ft AGL.

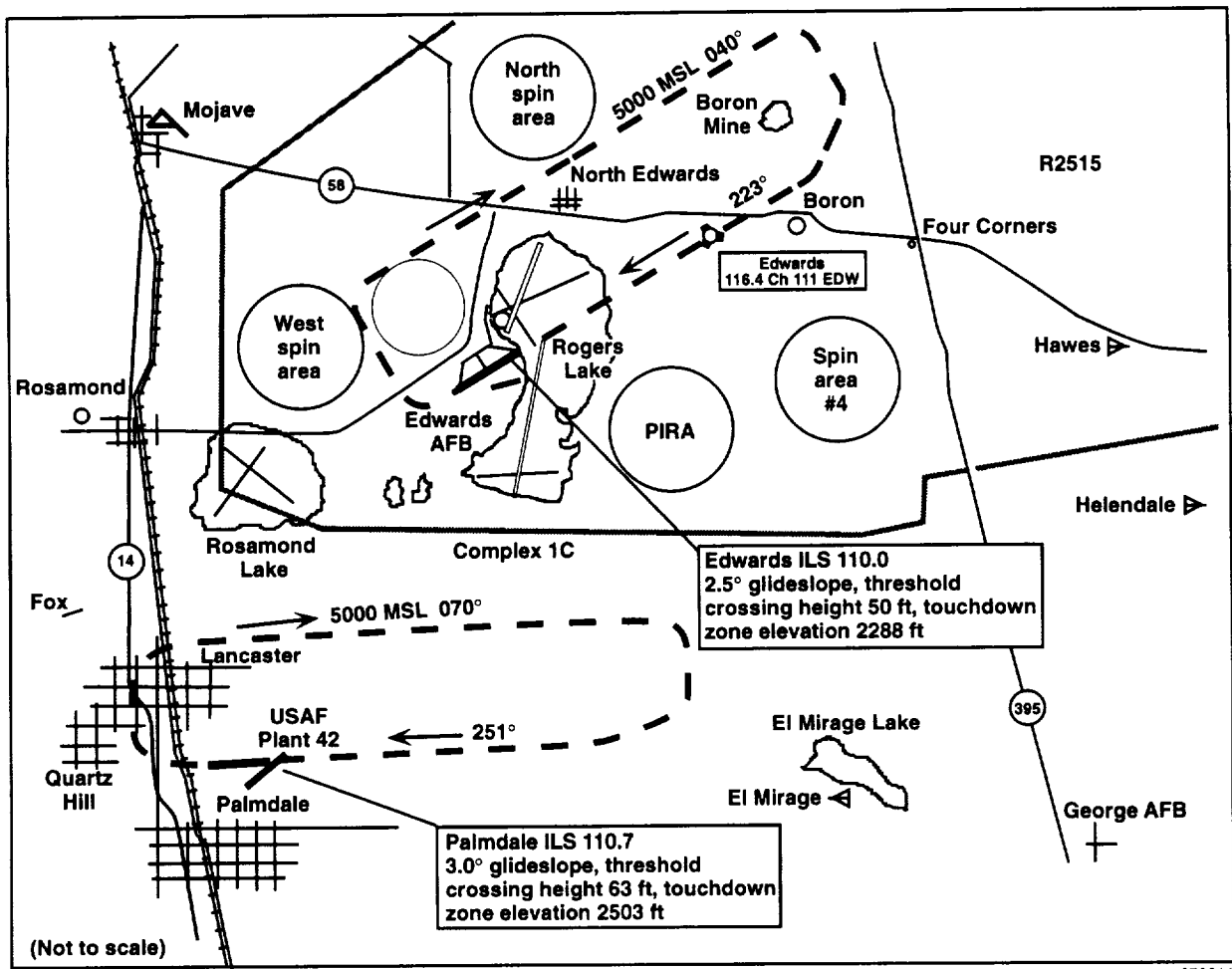
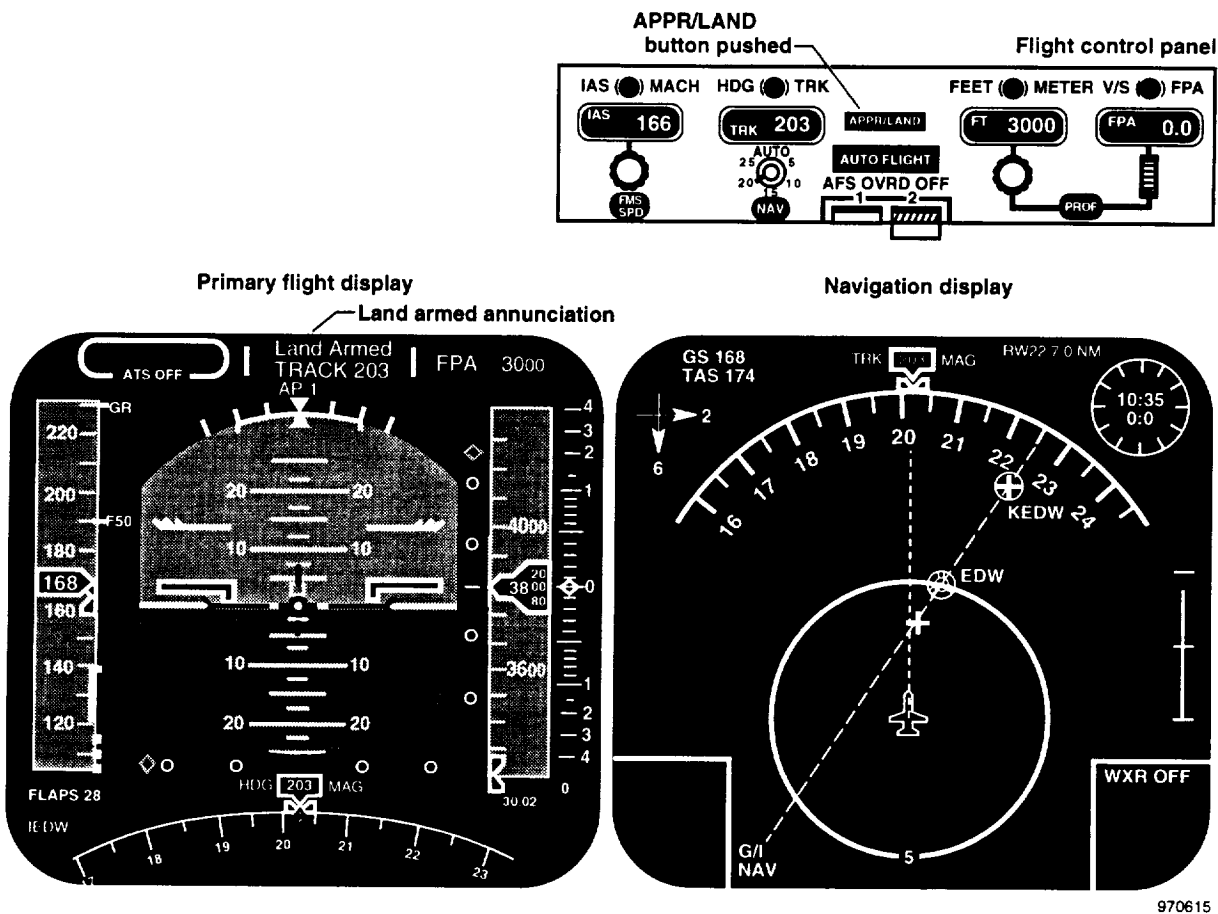

Figure 32. Ground track and ILS approach information for Edwards AFB and USAF Plant 42 at Palmdale.

Initially, the autoflare logic was a first flare to a flightpath angle of -1.5° at 100 ft and a second flare to -0.5° at 50 ft. These flares were raised for initial tests by 100 ft to see their effect without entering ground effect. High sink rates (~ 11 ft/sec) were experienced at 100 ft AGL; so a change was made to raise the first flare to 130 ft. Tests were then flown to 100 ft and 70 ft go-around altitudes. Go-arounds typically resulted in 50 to 60 ft loss in altitude.

The last ILS approach at Palmdale was flown without a PCA go-around at a specific altitude but with the safety pilot briefed to not allow a touchdown. Airspeed was about 153 kn. At 130 ft, the first flare reduced the FPA to -1.5° . At 100 ft AGL, sink rate was 11 ft/sec. At 30 ft AGL, the -0.5° FPA second flare further reduced the sink rate and, as predicted by the simulator, the airplane leveled off at 10 ft AGL and floated for approximately 10 sec. At this point, with a sink rate of 2 ft/sec and still on the centerline, the safety pilot made a small elevator input to prevent touchdown, and initiated a go-around.

As shown in figure 33, to initiate an ILS approach at Edwards, the pilot used the track and FPA modes to intercept the ILS. The 203° track would intercept the ILS localizer about 8 mi from the runway, while the 3800 ft altitude would ensure capture from below the glideslope. The Approach/Land button was depressed, as indicated by the Land Armed annunciation on the PFD roll window.



970615

Figure 33. PCA ILS-coupled approach procedure and displays. Track of 203° set up to intercept Edwards ILS localizer, flightpath level at 3800 ft MSL to be below glideslope, APPR/LAND button pushed to arm coupled approach logic.

The first attempted ILS landing at Edwards with first flare of -1.5° at 130 ft and a second flare of -0.5° at 30 ft resulted in the aircraft floating down the runway at 10 ft AGL, as it had at Palmdale. At the 5000-ft mark beyond the runway threshold, the system was intentionally disconnected, and a manual go-around was flown. For the next ILS approach, the second flare angle was set to a slightly steeper approach, using an MCDU input.

ILS-Coupled PCA Landings

Figure 34 shows the last 83 sec of the first PCA ILS-coupled landing. For this approach to Edwards runway 22 with a 6-kn wind from 260° , the second flare was reduced to an FPA of -0.75° . Localizer tracking was excellent all the way to touchdown. Glideslope tracking showed a $\pm 0.25^\circ$ wander that was typical of the coupled approaches. First flare at 130 ft and second flare at 30 ft to -0.75° reduced the flightpath to less than 0.5° , and touchdown occurred at about 1 ft/sec on the centerline 3000 ft beyond the runway threshold. Pilot A stated that this was as good a landing as he could have made with the normal flight controls. The cockpit views from the cockpit video camera showed runway lineup was maintained throughout the approach.

Figure 35(a) shows a time history of another ILS-coupled approach and landing. Before the time shown, the pilot had selected a track that intercepted the localizer about 12 mi from the runway, and pressed the

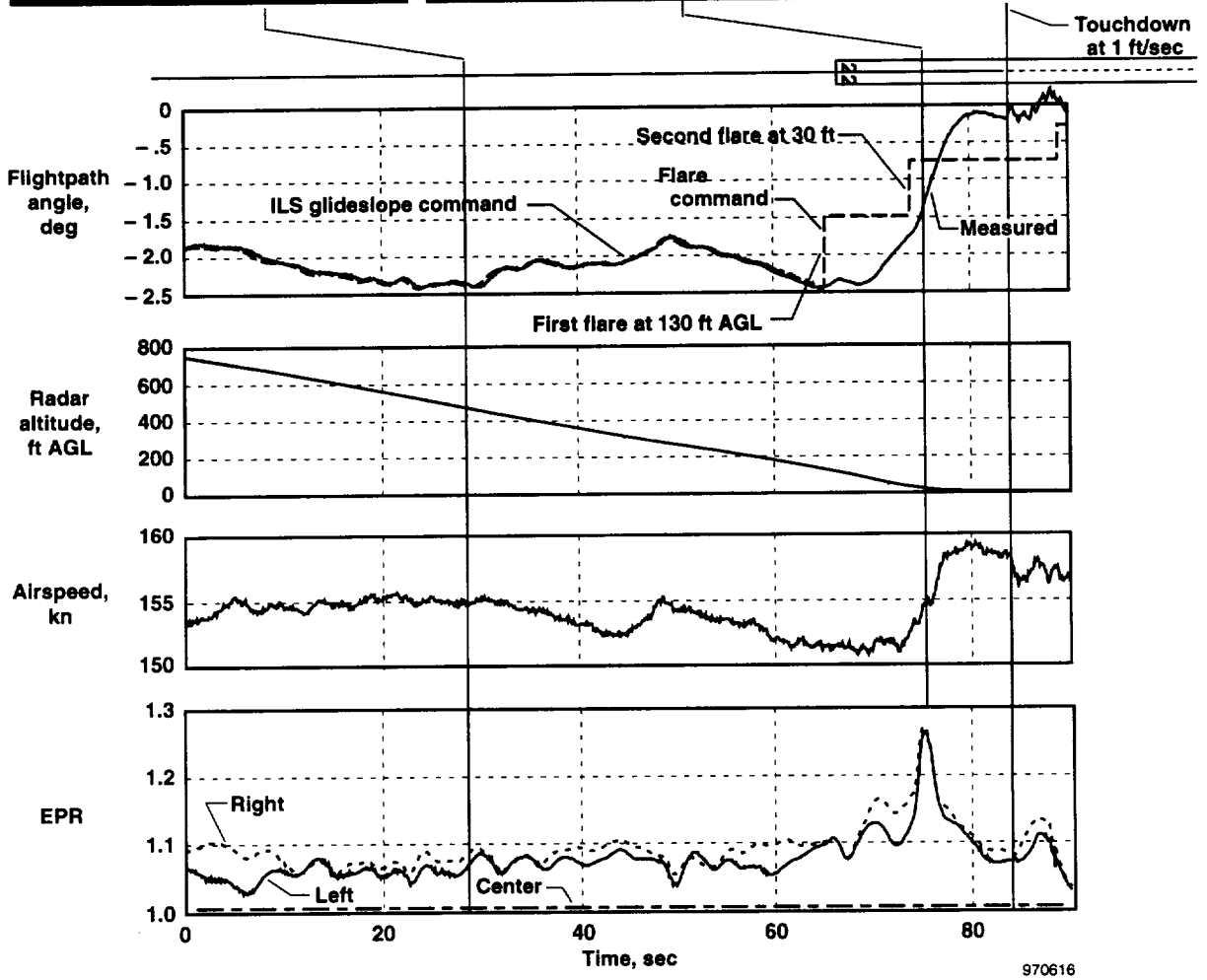
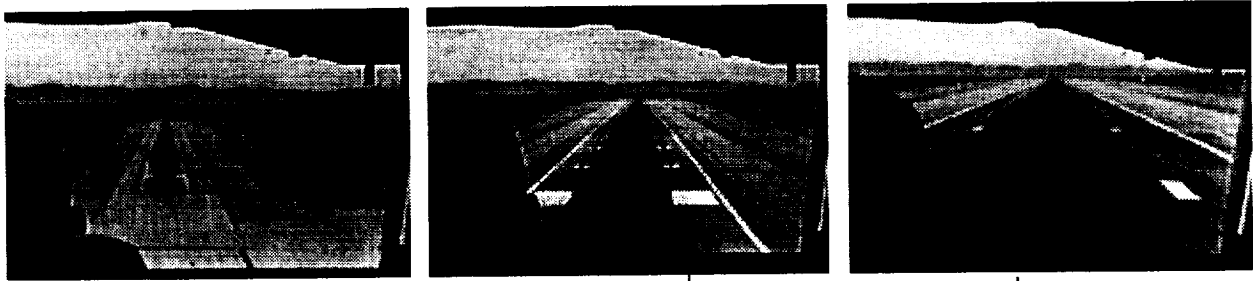

Figure 34. Time history and pilot views for PCA ILS-coupled approach and landing, Flaps 28, winds 260° at 6 kn, smooth air, center engine idle, no flight control movement, pilot A.

Approach/Land button (shown in fig. 33) to arm the ILS capture mode. At localizer capture, the system rolled onto the localizer with one overshoot and maintained the selected slight descent rate until glideslope capture 10 mi out. The glideslope capture resulted in an overshoot, but once established on the ILS, localizer tracking was excellent, and glideslope tracking was adequate. The preprogrammed flares at 130 ft and 30 ft mostly arrested the sink rate and resulted in a touchdown a foot from the centerline at 5 ft/sec sink rate, 1200 ft beyond the threshold. After touchdown, the PCA system was disengaged by moving the throttles to idle. The nose lowered and the nosewheel touched down smoothly; the pilot then used differential braking to slow and maintain directional control. Figure 35(b) shows an expanded view of the final minute of this landing. The higher sink rate for this ILS-coupled landing was primarily caused by the 2-sec lag in translating between the glideslope and the first flare. For this approach, the MD-11 glideslope was becoming more negative at 130 ft, and the lag allowed the airplane to continue to sink below the glideslope, resulting in a shorter touchdown at a higher sink rate. This transition logic could have been better refined for improved control (and in fact was improved for the analytical touchdown dispersion study discussed later).

Two more ILS-coupled approaches were flown with flaps and slats retracted at a speed of about 200 kn. As expected, the one-dot-low approach could not be flown because the engines were at or near idle. With the glideslope set, through an MCDU input, to 1.5 dots low, the approach worked well and was executed down to a go-around at 100 ft. Figure 36 shows this approach. A good landing could have been made from this low approach, but because of the airspeed proximity to the 204-kn tire speed limit, no landings without flaps were made. Localizer and glideslope tracking was excellent. Engine thrust was very close to idle, so significant turbulence could probably not have been accommodated in this configuration.

A three-engine ILS-coupled approach to 50 ft AGL was also flown (fig. 37), and worked well. In this case, the center engine was used for short-term pitch control, with a thrust command opposite to the wing engines, washed out with a 4-sec time constant. The wing- and center-engine EPRs may be observed going in opposite directions in the time between 10 and 20 sec when the bank angle was essentially zero and no differential thrust was being commanded. At 50 ft AGL, as planned, the pilot disengaged PCA and made a normal landing. Note also that speed was held within 1 kn with the center engine active. Pilots commented that pitch control on this approach was the best they had seen, although the air was smooth and the full potential of this mode was not tested (ref. 12).

As mentioned earlier, the ILS-coupled PCA system was designed to demonstrate feasibility and potential improvement and was not a fully developed autoland system. The flightpath control below 600 ft exhibited some small deviation from the glideslope and resulted in scatter in touchdown sink rate and location. Figure 38 shows an overlay of three ILS-coupled approaches and shows a somewhat repeatable deviation initially below the glideslope beginning at 600 ft AGL. This deviation is caused by integrators in the ILS logic that were not optimized in this application. In addition, the transition from glideslope to first flare command had a 2-sec lag filter. This filter allowed random variations in sink rate at the 130 ft first flare to continue for 2 sec, increasing scatter in touchdown point and touchdown sink rate.

These ILS-coupled approaches and landings were made in November under near ideal weather conditions, light winds and smooth air. Attempts to find turbulence at Yuma, Palmdale, and Edwards, were unsuccessful. To evaluate the performance of the ILS-coupled PCA system in more severe weather, simulator and computer analyses were performed. These analyses showed that safe ILS-coupled landings could be made in turbulence levels up to moderate. Figure 39 shows an FDS ILS-coupled approach with severe turbulence and a 15 kn wind 45° off the nose. Note that airspeed excursions of 10 kn result from the turbulence. An updraft caused a deviation above the glideslope, but the system compensated well. An upset during the first flare was corrected, with touchdown at 4 ft/sec near the centerline with a 5° bank.

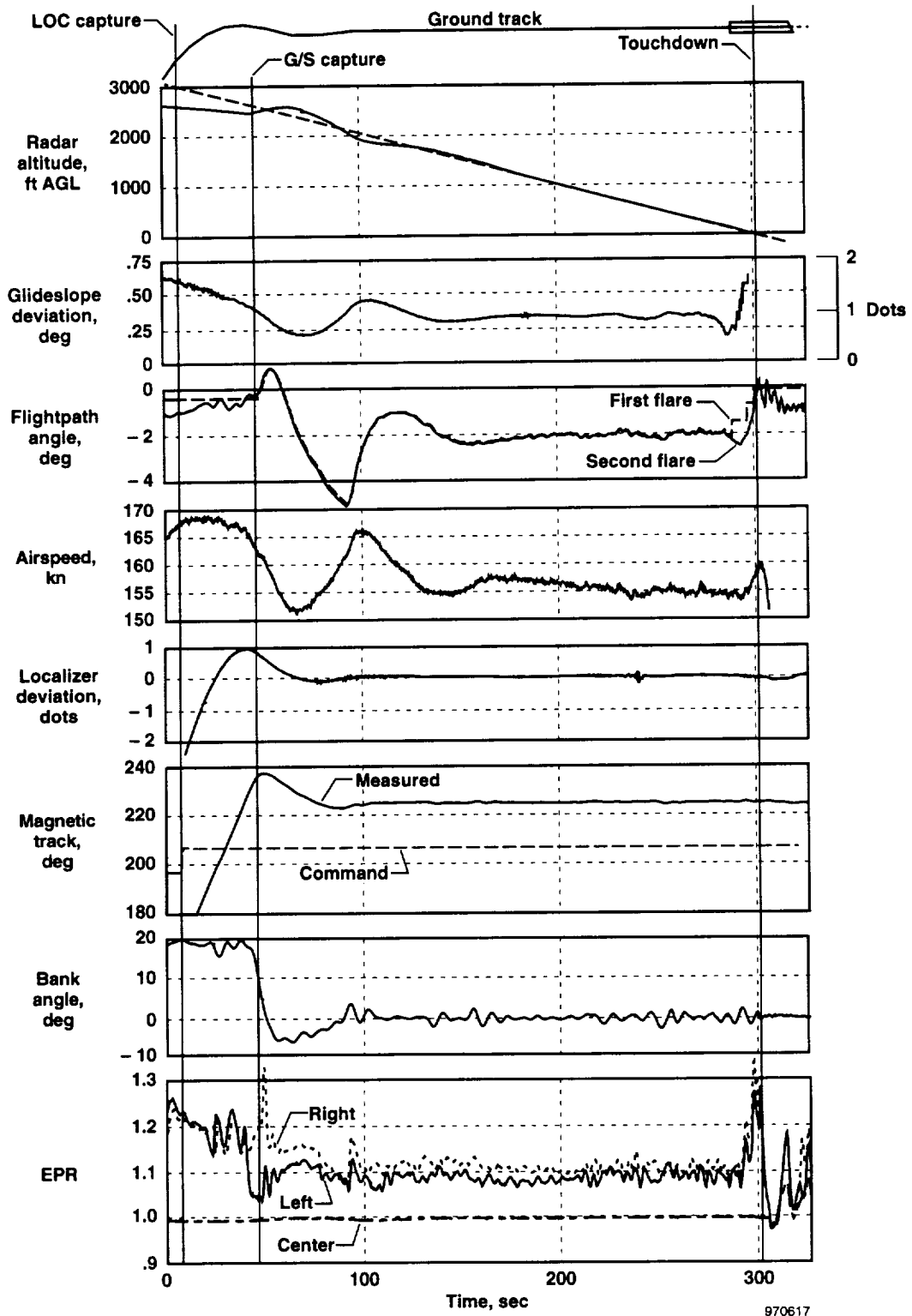

(a) Entire approach and landing.

Figure 35. Time history of PCA ILS-coupled approach and hands-off landing, Flaps 28.

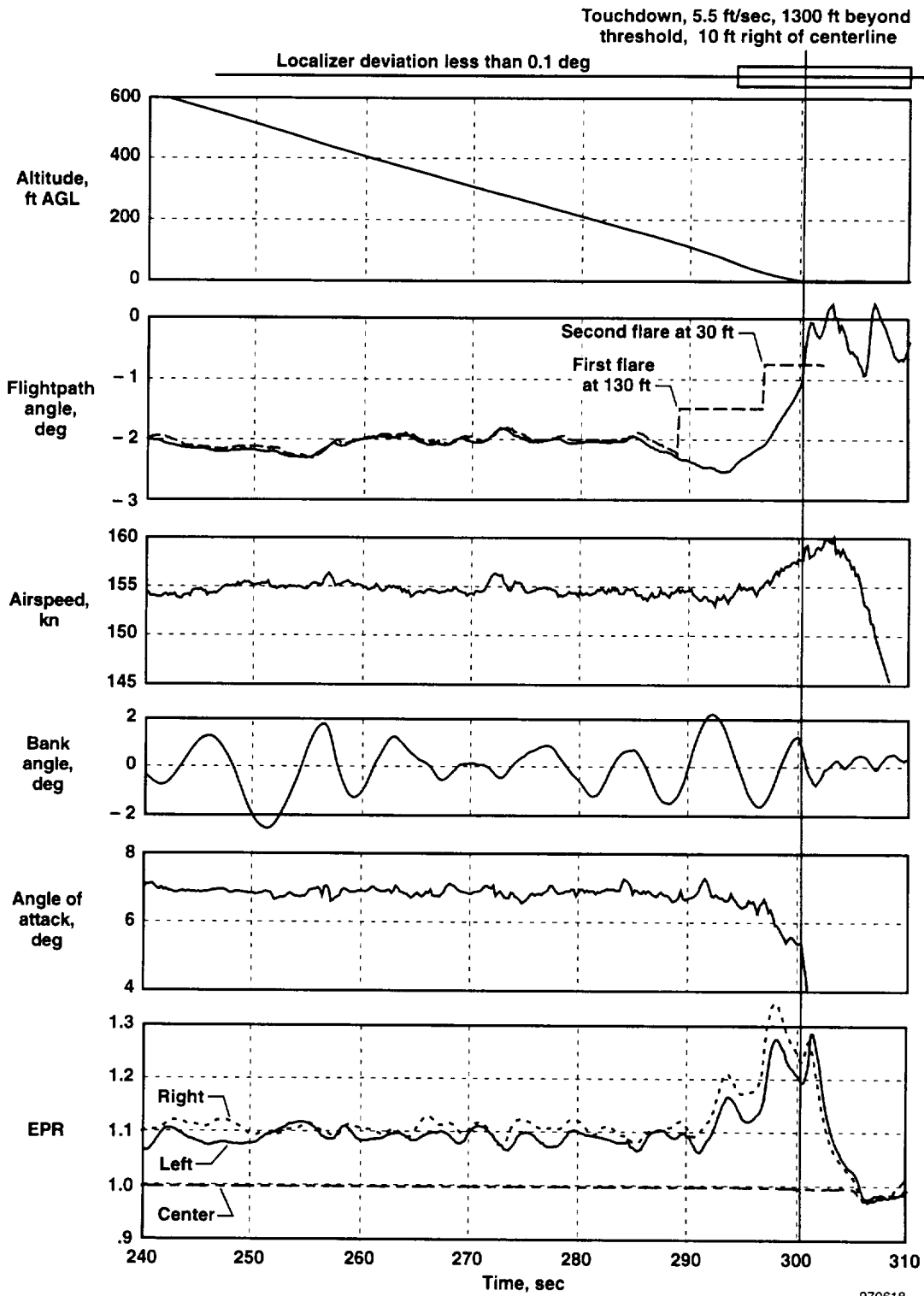

(b) Final 60 sec of ILS-coupled hands-off flare and landing.
Figure 35. Concluded.

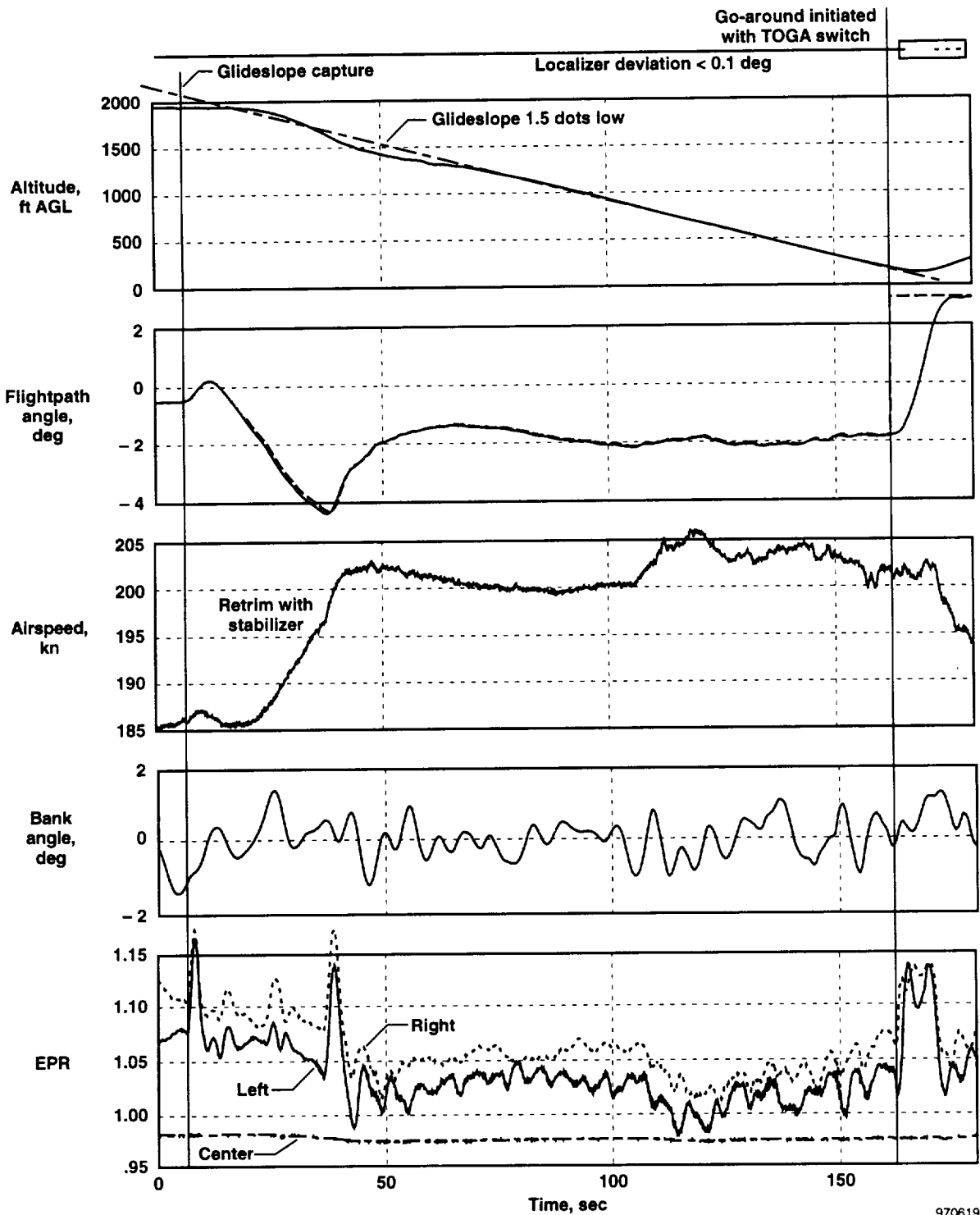
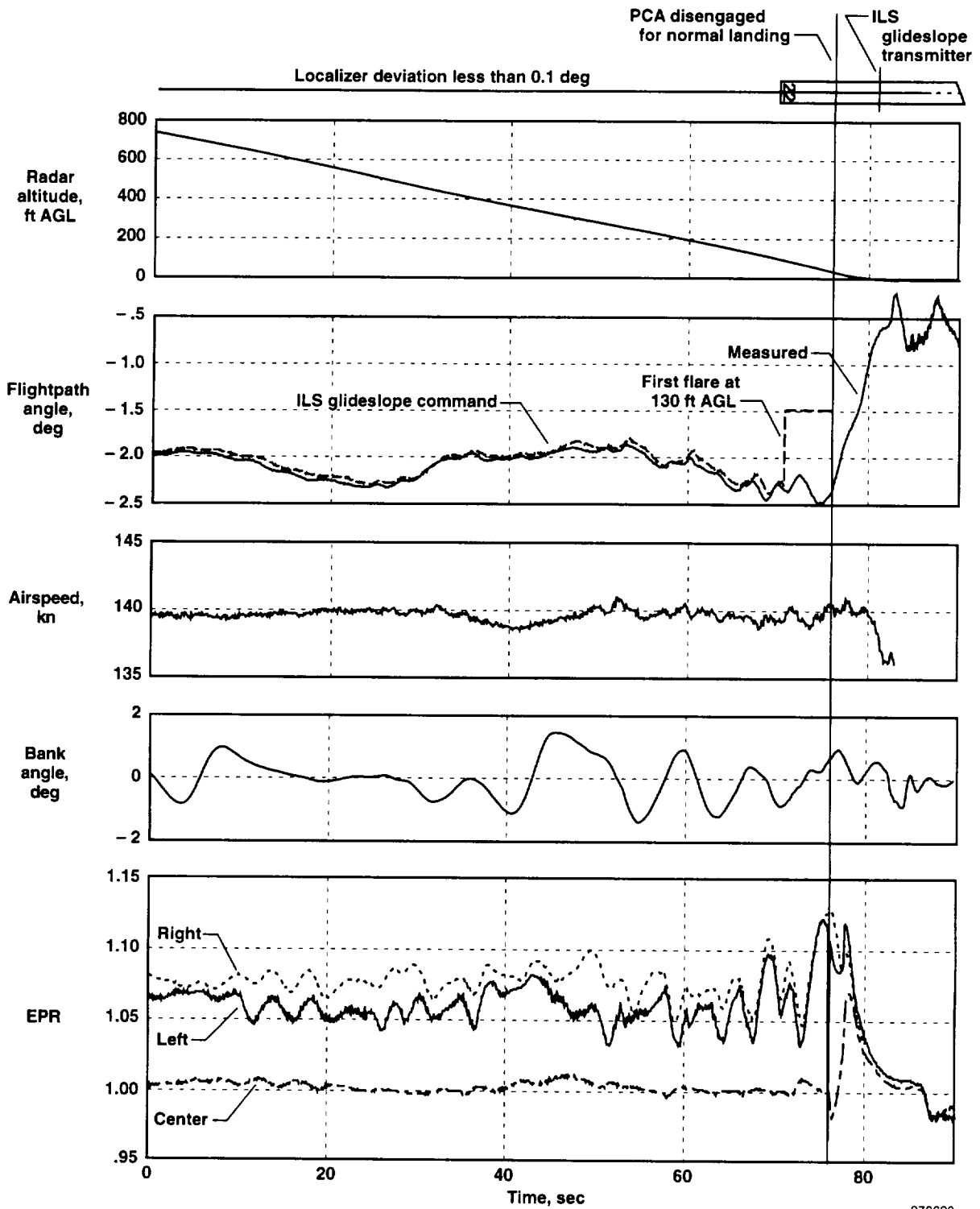

Figure 36. Time history of PCA ILS-coupled approach and go-around, flaps and slats retracted, landing gear down, center engine idle, 1.5 dots below nominal glideslope, smooth air, pilot A.



970620

Figure 37. Time history of ILS-coupled approach, three-engine dynamic pitch mode, Flaps 28, PCA disengaged at 50 ft AGL before normal landing, pilot A.

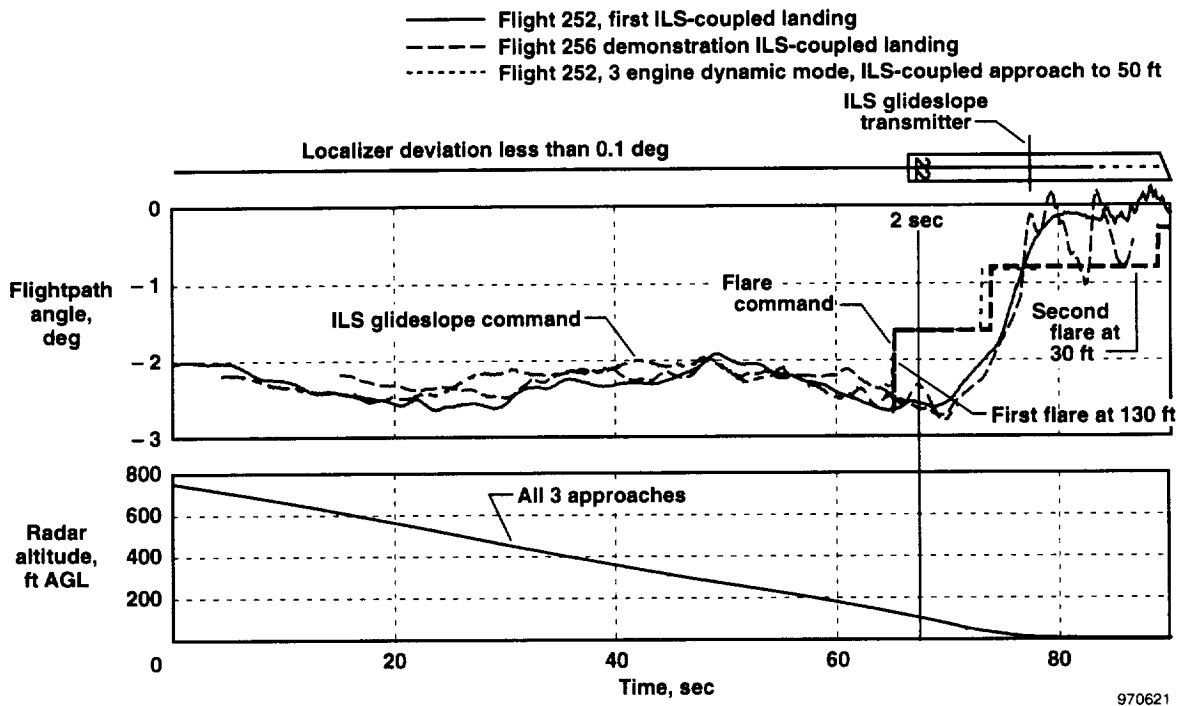
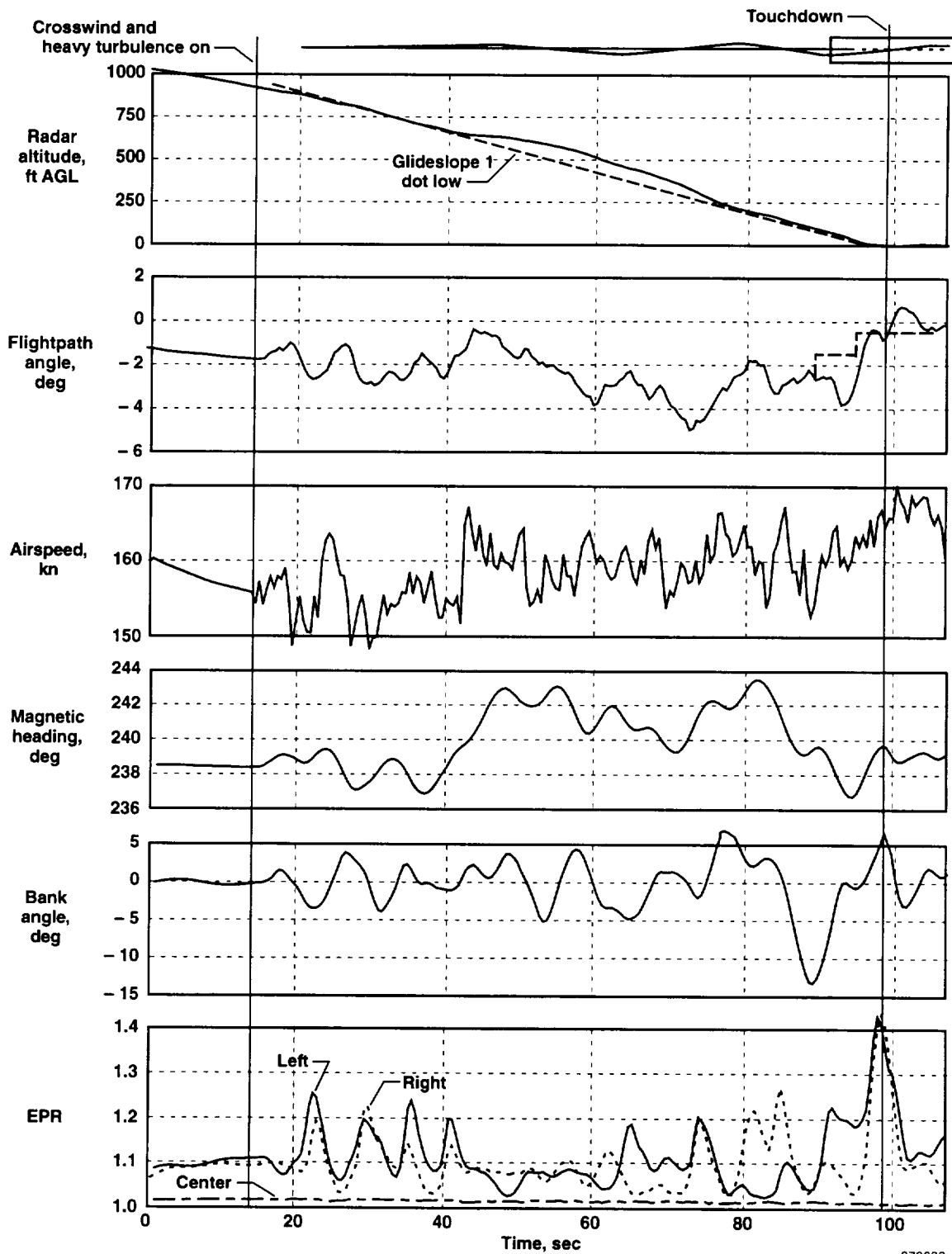

Figure 38. Overlay of three MD-11 PCA ILS-coupled final approaches. Flaps 28, gear down, light winds, no turbulence.



970622

Figure 39. Time history of MD-11 flight deck simulation ILS-coupled landing, severe turbulence, wind 270° at 15 kn, two-engine pitch mode, Flaps 28.

Honeywell also conducted an analysis to study the statistical probability of ILS-coupled PCA landing success. This analysis is normally used for autoland studies and certification, and includes a full range of variables in weather, aircraft weight, and CG, including turbulence up to severe. Before the study, the problems of the overshoot on glideslope capture and the 2-sec lag in the transition from the glideslope to the first flare were corrected. Reference 13 gave results of 400 landings. Results of 100 landings are summarized in figure 40. All 100 landings were at safe sink rates and bank angles; the touchdown dispersion data are seen to be very good. The ability of the ILS-coupled PCA system to make small thrust changes to correct a deviation immediately provided a major improvement in capability over PCA system pilot-in-the loop control as well as a significant reduction in pilot workload.

Demonstration Flights

The PCA system was demonstrated to many pilots and observers (table 3), representing NASA, airlines, U.S. Air Force, U.S. Navy, industry, and the Federal Aviation Agency. For each pilot, there was a briefing and simulator session. Once in the MD-11 test airplane, each pilot could observe the previous pilot's demonstration. Then, each of the pilots flew the pattern shown in figure 32; most of the tests were flown at Edwards, but some were flown at Palmdale. On the downwind approach leg, they first flew a few minutes of manual throttles-only control, then flew with the PCA system using the FCP knobs. Usually, both FPA and V/S modes were used in pitch, and track angle (TRK) and bank angle modes were used for lateral control, but FPA and TRK were usually used on the approach. Figure 41 shows typical manual throttles-only flight control. Even though starting from a trimmed condition in very smooth air, and having some recent simulator experience, pitch control was not good, with excursions of at least $\pm 3^\circ$. Bank angle was typically held within a few degrees, but the task was to hold heading, not to turn and establish a new heading. After PCA was engaged, all were impressed at the immediate improvement in control and the precision of PCA operation being very similar to a normal autopilot.

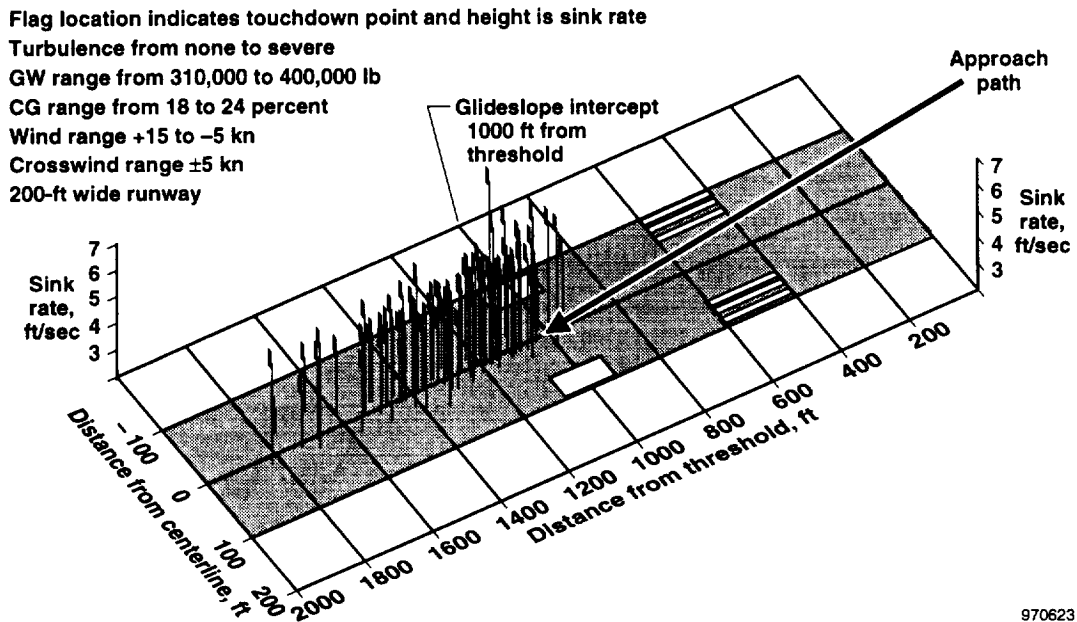
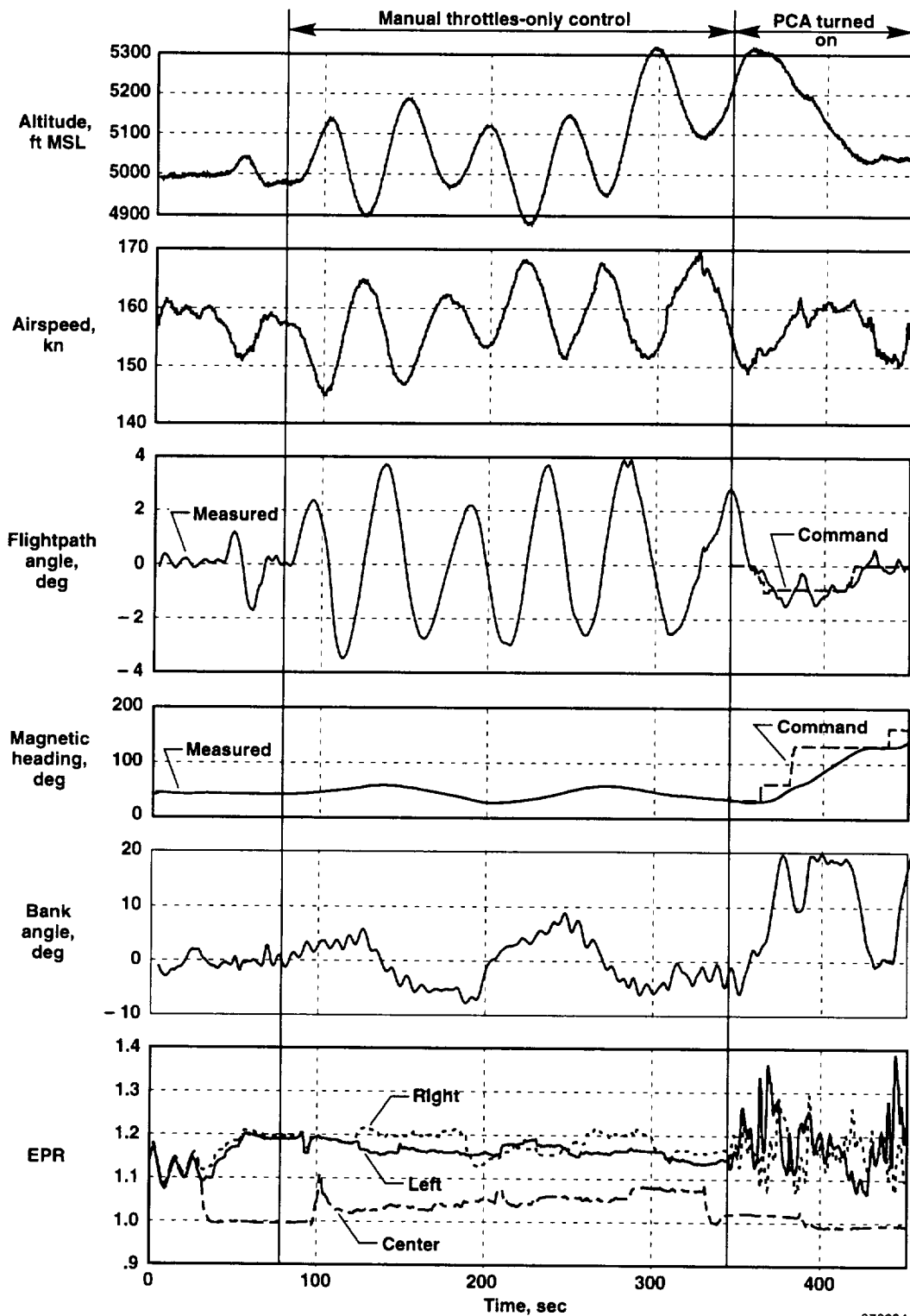

Figure 40. Simulation results of MD-11 PCA ILS-coupled landing dispersion, Flaps 28, two-step autoflare at 130 and 30 ft AGL; Honeywell simulation, 100 landings.



970624

Figure 41. Time history of PCA demonstration pilot manual throttles-only control and PCA engagement, Flaps 28, gear down.

Table 3. PCA pilots and observers in MD-11.

Name	Affiliation	Position
Pilots		
William Wainwright	Airbus Industrie	Chief test pilot
Kenneth Higgins	Boeing	Vice president, flight operations
Tom McBroom, captain	American Airlines	Chief technical pilot
Roy Tucker, captain	Delta Airlines	MD-11 chief pilot
Chip Adam	Federal Aviation Agency	Engineering pilot
Tom Imrich	Federal Aviation Agency	NRS, air carrier operations
George Lyddane	Federal Aviation Agency	NRS, flight management
Carl Malone	Federal Aviation Agency	Aircraft evaluation group
Hiromichi Mitsuhashi, captain	Japan Air Lines	Assistant to director of engineering
Koci Sasaki, captain	Japan Air Lines	Deputy vice president
Abdullah Alhabdad, captain	Royal Flight (Saudi)	Vice president, flight operations
Ruedi Bornhauser, captain	Swissair	Technical operations
Ed Allvin, captain	U.S. Air Force	AFFTC, 418th flight test force
Frank Batteas, Lt Col	U.S. Air Force	AFFTC
Bob Stoney, Lt Cdr	U.S. Navy	NATC TPS
Steve Wright, Cdr	U.S. Navy	NATC TPS
Gordon Fullerton	NASA Dryden	Project pilot
Dana Purifoy	NASA Dryden	PCA evaluation pilot
John Miller	McDonnell Douglas	MD-11 chief pilot
Ralph Luczak	McDonnell Douglas	PCA project pilot
Tom Melody	McDonnell Douglas	MDA chief pilot
Walt Smith	McDonnell Douglas	MD-11 PCA pilot
Tim Dineen	McDonnell Douglas	MD-11 pilot
Don Alexander	McDonnell Douglas	MD-11 pilot
Observers		
Robert Gilles	Airbus Industrie	Director, flight test
Mike Dornheim	Aviation Week	Technical writer
Ed Kolano	Flight International	Technical writer
John Bull	NASA Ames	PCA engineer
Don Bryant	NASA Ames	ACFS simulation engineer
Larry Yount	Honeywell	Honeywell fellow
Tom Enyart	Federal Aviation Agency	Private pilot/engineer
Bill Dana	NASA Dryden	Chief engineer

Following the engagement of PCA, each pilot flew a downwind and base leg to a 12-mi straight-in approach. Each pilot then made a PCA approach to a virtual runway at 100 ft AGL (the first flare was set for 230 ft AGL and the second flare to 130 ft AGL). Most used the ILS-coupled mode, while a few used PCA FPA and TRK control. In the very smooth air of these tests, even the PCA approaches using the FCP knobs were successful; an example was shown in figure 24. At the 100-ft decision height, the pilots then pushed the TOGA button on the throttles to initiate a PCA go-around. The go-around was continued with a turn to the crosswind leg.

All pilots were very impressed with the PCA system. In general, FPA and TRK modes were preferred, although the bank angle mode and V/S modes received very little evaluation. The pilots all were impressed with the go-around capability in which less than 60 ft of altitude were typically lost. These pilots also commented that control seemed almost normal and that, aside from the brief lateral acceleration immediately after making a track change, they could not tell whether the engines were providing all of the flight control. All pilots found the FCP knobs very easy and natural to use. Observers sitting in the cabin noted no difference from a normal approach unless seated where they could hear the engine sounds changing pitch.

The following excerpts from questionnaires summarize the demonstration pilot comments and suggestions for additional work:

1. Conceptually, a very good idea. This demonstration effectively shows the potential for practical implementation. More work is needed in order to move to the regulatory credit stage.
2. Basic PCA track/flightpath angle is excellent for all normal tasks. Use of fully coupled ILS/MLS/FMS, etc., is the safest concept.
3. Pilotage with manual throttle consistently induced both phugoid and dutch roll tendencies. The insertion of PCA damped these modes out.
4. The PCA is an enhancing characteristic and will increase the level of safety of the aircraft. This technology should be further developed.
5. I had trouble flying manual with throttles only for pitch and roll. When on auto, it smoothed out. I think this program will be good for future backup systems, or partial control for normal systems.
6. Simulator evaluation was perfect setup to understand principles for PCA and see small throttle maneuvers. Aircraft was easier to fly in manual mode than simulator, but got better feel for phugoid in the aircraft. Controlled flight with autopilot more consistent than manual mode.
7. PCA manual track very controllable—smooth pitch corrections. Side force during turn initiation was noticeable but not objectionable. Pitch and glidepath angle were easily achieved using the thumbwheel. ILS was intercepted using this mode, and tracking, while requiring attention, was a nonevent.
8. Manual manipulation of throttles for pitch/roll control was very workload intensive. Bank control to within 5° moderately difficult. Pitch control extremely difficult. Utilization of track/bank and flightpath angle modes was impressive. These modes took a marginally controllable aircraft (especially in pitch) and made it extremely easy to fly.
9. Manual flying—to control phugoid, needed a couple of simulator approaches for experience. But when PCA engaged, it could be controlled perfectly. PCA flightpath angle control was smooth and better than expected.
10. Very useful demonstration of a system which shows good potential for use in some serious failure cases. An obvious limitation is that the system can only work (without the center engine) about a trim speed, which will vary with circumstances. Thus, its ability to maneuver is limited, but it works well on a well-constrained task such as a level entry to a glideslope with a small intercept angle to the localizer.
11. Aircraft very controllable in autopilot modes (PCA). Manually, control next to impossible. Coupled, very impressive—a safe landing should be possible.
12. Basically, takes what had been a very challenging, if not impossible, situation into what could be considered a textbook lesson with no exceptional pilot skills required.
13. Amazing! Overall, you have to see it to believe it! All involved people have done a great job.
14. I was amazed that the roll response was very quick and positive compared to the simulator. I experienced manual throttle control, PCA is very helpful.

15. Pitch and roll rates experienced with the PCA system engaged were comparable with those routinely used by the airlines. A small lateral acceleration was felt as the system commanded differential thrust. Noticeable, but not uncomfortable, this sideways pulse was only evident with roll initiation.

Pilot PCA System Interface

The existing autopilot flightpath and Heading/Track knobs were used without modification. In general, this approach worked well, but there were exceptions. The rapid change mode on the knobs was undesirable for PCA control, because a pilot would occasionally engage the rapid mode of a knob and get a larger-than-desired command (for example, fig. 22 at T = 55 sec). Also, no tactile feedback (such as a detent) was available to determine where the 0° position was on the Heading/Track knob when used as a bank angle command or on the flightpath command knob. For a pilot on final approach, while concentrating on looking out of the windscreen, a tendency was to inadvertently select the speed knob rather than the adjacent Heading/Track knob.

In this concept demonstration, when under PCA system control, the throttle levers in the cockpit did not move, and thus, did not represent the current engine throttle position. For a flight test, this situation was not considered a problem, but some pilots prefer that the throttle levers move to match the engine control throttle position. In an actual PCA implementation, these issues would need to be addressed.

Split Piloting Tasks

In the MD-11 PCA flight test, one pilot controlled PCA while the other pilot acted as safety pilot. In the FDS, it was found very helpful for pilots to split the task, with the left-seat pilot flying the lateral control knob, while the right-seat pilot would fly the FPA thumbwheel. This task splitting greatly reduced the workload and improved performance, and would likely be the preferred mode for an operational PCA system. Task splitting would also improve the likelihood of a successful approach on the first try that was very difficult for a single pilot.

MD-11 Speed Control Example

With flight controls failed, the MD-11 has several indirect means of changing the trim speed, as discussed earlier. The degree of speed adjustment available is a function of the initial speed, initial payload, fuel quantity, and CG position. Except right after takeoff, the likely problem is to slow to an appropriate landing speed. Effective ways to reduce the trim speed (assuming a total hydraulic failure) include the following:

1. Reduce weight
2. Move the CG aft
3. Lower the landing gear
4. Reduce center engine thrust

The condition with the least amount of speed-reduction capability would be late in the flight when the CG is still aft but not much fuel is available.

Using analytical techniques with the data of figure 10, supplemented with flight data on the effects of gear extension and loss of all hydraulics, trim speed variation was determined. Two examples are presented: one is at a high-speed climb condition at high weight with a mid CG, and the other is at the mid weight aft CG cruise condition.

Figure 42 shows the speed change for the heavyweight 550,000-lb climb at 330 kn case with the CG at 25 percent. Loss of all hydraulics is assumed at the initial condition, resulting in 25 kn of slowing. Then fuel burning/dumping to a GW of 400,000 lb is used to reduce the speed to 262 kn. A small CG shift to 27 percent reduces the speed further to 248 kn. Once near the landing site, the gear is lowered with the alternate gear extension system, slowing another 15 kn to 233 kn. When the center-engine thrust is reduced to idle, the trim speed is reduced to 200 kn, just right for a no-flaps approach and landing.

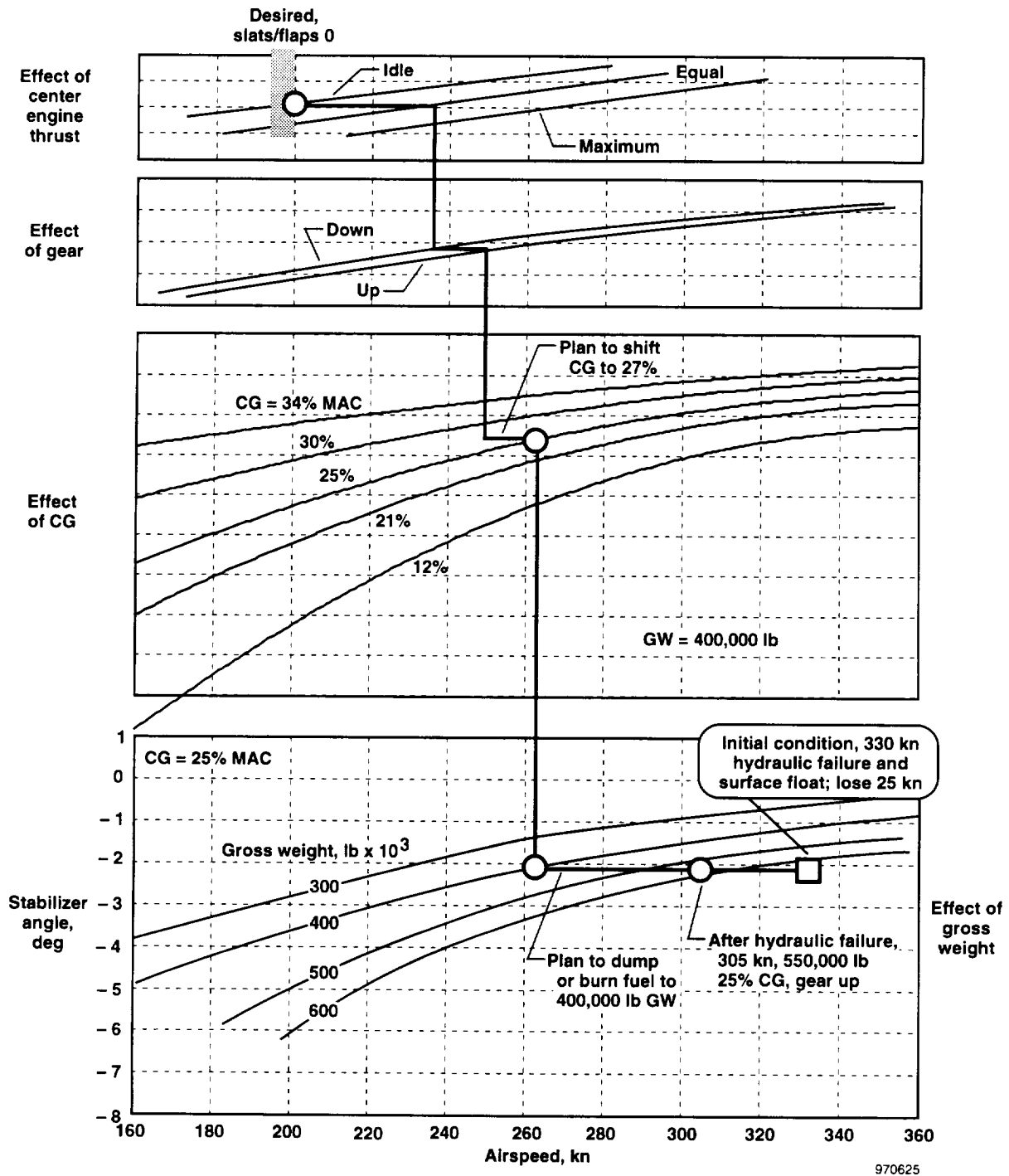

Figure 42. Analytical trim speed variation with GW, CG, landing gear, and center-engine thrust setting. Initial conditions: 330 kn climb, 25 percent CG, gear and flaps up.

Figure 43 shows the speed situation for an initial condition of cruise flight at a CG of 31 percent, 285 kn at 450,000 lb. At hydraulic failure, the floating surfaces reduce the airspeed from 285 to 260 kn. Burning or dumping fuel to 400,000 lb reduces speed to 252 kn. The CG is maintained at 31 percent by inhibiting the forward transfer of tail fuel, which would normally occur when the airplane descends below 20,000 ft. Lowering the gear with the alternate system reduces speed to 238 kn, and reducing the center engine to near idle lowers speed another 38 kn to 200 kn, appropriate for a no-flaps landing.

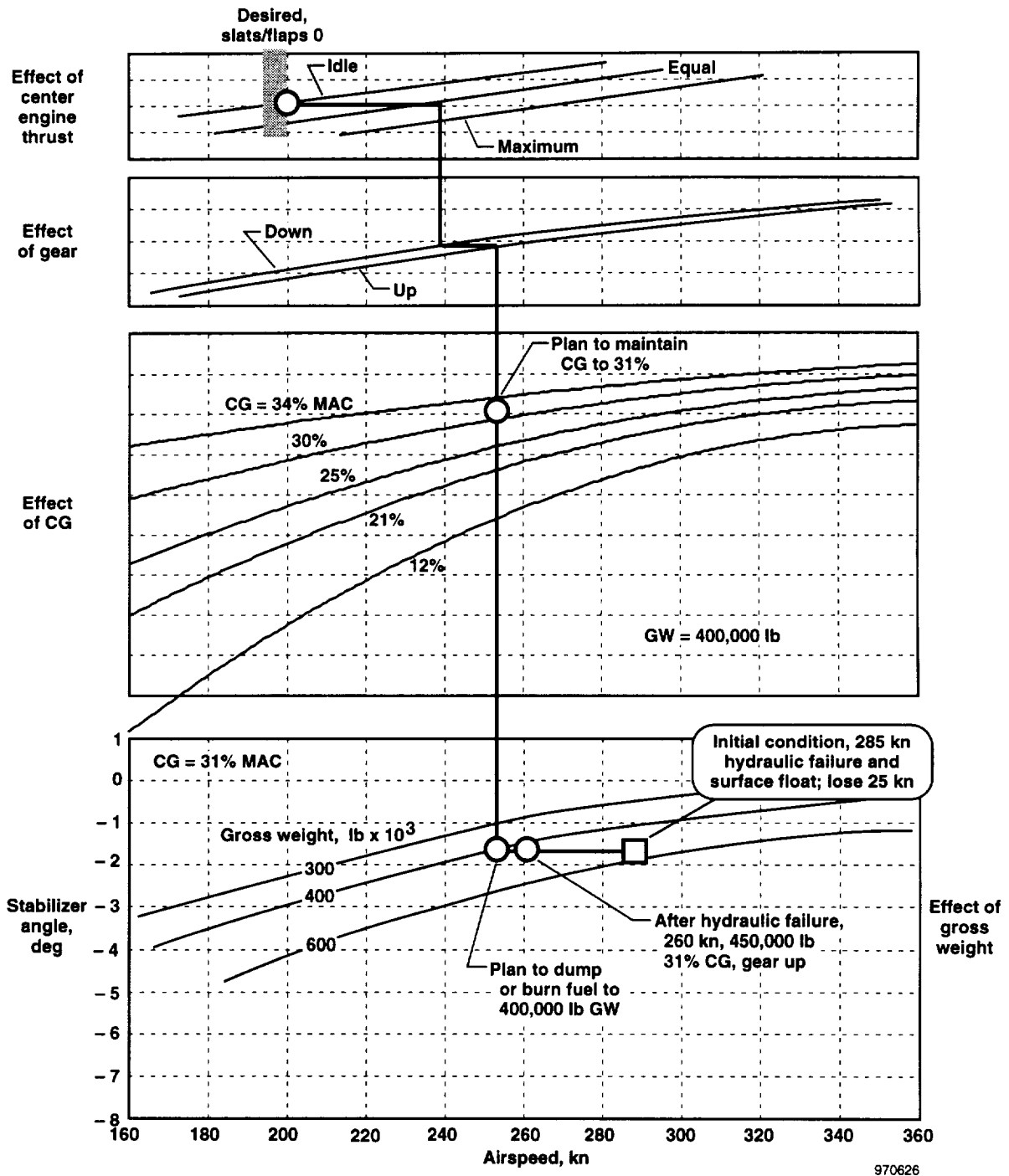

Figure 43. Analytical trim speed variation with GW, CG, landing gear, and center-engine thrust setting. MD-11 initial conditions: 285 kn high altitude cruise, 31 percent CG.

Other data also show that a suitable landing speed can be achieved for most conditions in a typical flight. Some difficulties arise if a total hydraulic failure occurs right after takeoff at a high gross weight. Aileron float and dumping fuel would cause the speed to be reduced to an unacceptably low value unless the CG can be transferred forward and the center-engine thrust increased above that of the wing engines. At maximum landing weight of 430,000 lb, as shown in figure 6, fuel could be transferred to the center tank to move the CG forward to 21 percent. Figure 10(j) or 10(k) shows that moving the CG from 25 to 21 percent would increase speed by 30 kn.

Wing Engine and Lateral CG Offset

As discussed in the section, Principles of Throttles-Only Control, the MD-11 without flight controls and without an operating engine on one wing can have a degree of control if the lateral CG is offset toward the side with the operating engine (ref. 22).

The MD-11 Flight Deck Simulator (FDS) was used to briefly study the wing-engine-out thrust control capability. On the MD-11, a CG offset of up to 48 in. can be obtained using the existing fuel system. Figure 44 shows the maximum lateral CG offset as a function of fuel quantity. If one wing tank is full and the other is empty, a CG offset of 48 in. occurs. With all tanks full, obviously no offset is possible. As fuel is burned or dumped, the maximum offset occurs after the tanks in one wing are empty and can be maintained as long as fuel is in the center or tail tanks to keep the other wing tank full. After the center and tail tanks are empty, the lateral CG offset decreases until, with all fuel exhausted, it is again zero.

Figure 45 shows MD-11 FDS results of the time required for the fuel transfer, based on the normal fuel pump operational rates. Starting with all wing tanks equally full, about 7 min is needed to get a lateral CG offset of 25 in., transferring from the left wing to the right wing. At this time the right wing is full, and further transfer is from the left wing to the center tank, which is obviously less effective in shifting lateral CG offset. After a total of 13 min, the lateral CG was 40 in., and the maximum tested 45 in. was reached in 15 min. An average rate of change of lateral CG offset is ≈ 3 in./min.

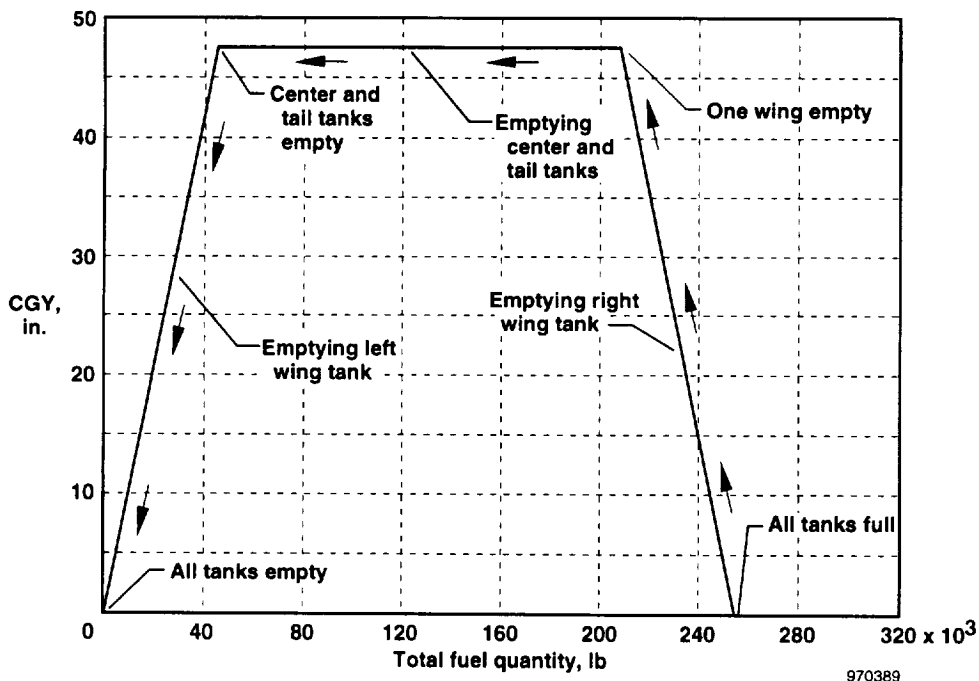

Figure 44. MD-11 lateral CG offset compared with total fuel quantity and location.

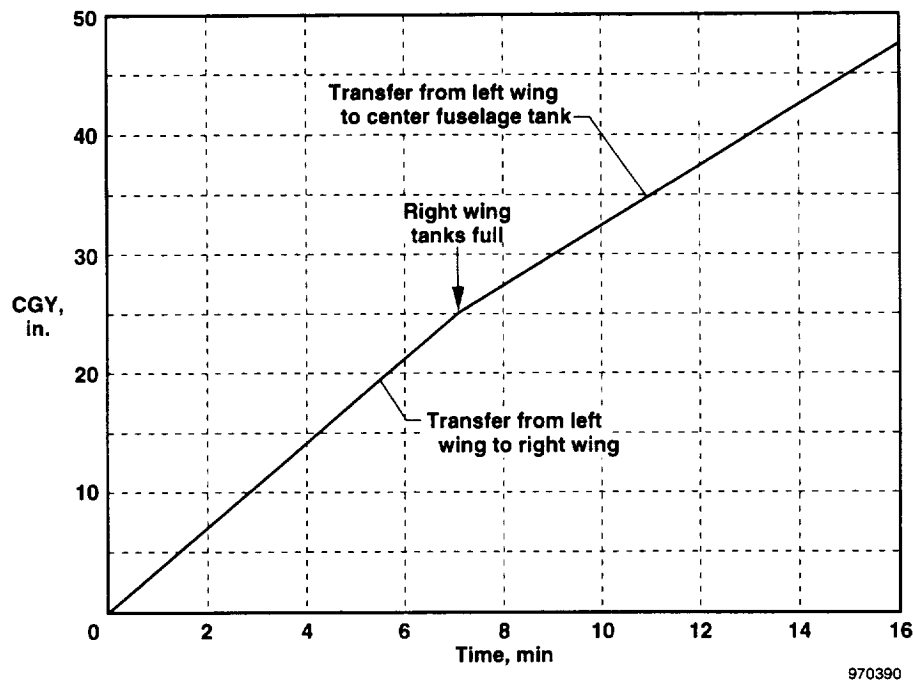

Figure 45. Time history of fuel transfer and lateral CG offset, MD-11 FDS. Initial wing fuel tank quantities approximately 31,000 lb.

Well within this lateral CG offset, wings-level flight on one engine is available over a range of speeds from 200 to 300 kn. Figure 46 shows simulation results of the engine 3 EPR required to hold wings level (with engine 1 off or at idle) as a function of speed. A level flightpath is possible depending on speed and the degree of lateral CG offset.

Figure 47 shows a time history of a right-engine throttle step increase followed by a step to idle at 205 kn with gear and flaps up, and the left and center engines at idle and a lateral CG offset of 35 in. The initial sideslip is 2°. With the thrust increase, sideslip increased and the roll rate was 5 deg/sec. Angle of attack also increased because the engine was below the vertical CG as well as to the right of the lateral CG. As the bank angle passed through 40°, the right-engine thrust was reduced to idle, which caused the sideslip to go to zero and the roll rate to reverse to ≈4 deg/sec. Maximum roll rates up to 4 to 5 deg/sec are possible, although depending on speed, it may not be equal in each direction. These rates should be adequate for runway lineup in light turbulence.

Manual throttles-only control is extremely difficult, but the PCA control laws provide stable track control and show promise of providing stable flightpath control. Using the PCA track control knob, runway alignment could be achieved and maintained. Figure 48 shows the MD-11 with a 31-in. CG offset, the left engine at idle, and the right engine being controlled by the unmodified PCA lateral control laws to hold track. As seen, track control is very sluggish but it does track and hold the command with a steady-state error. A limit is apparent on roll rate with the unmodified control laws. The pitch phugoid is uncontrolled and is a problem; it interacts with the lateral control.

In figure 49, an open-loop thrust increase on the center engine (to establish a climb) fortuitously damped the phugoid. Also shown at 1965 sec is a decrease in the bank angle feedback gain from 1.0 to 0.5. This change was designed to reduce the steady-state error in track, which it did, but it also increased the amplitude of a dutch-roll limit cycle.

Control law improvements are expected to greatly improve the lateral control, and a longitudinal control law has been developed to control pitch with the center engine.

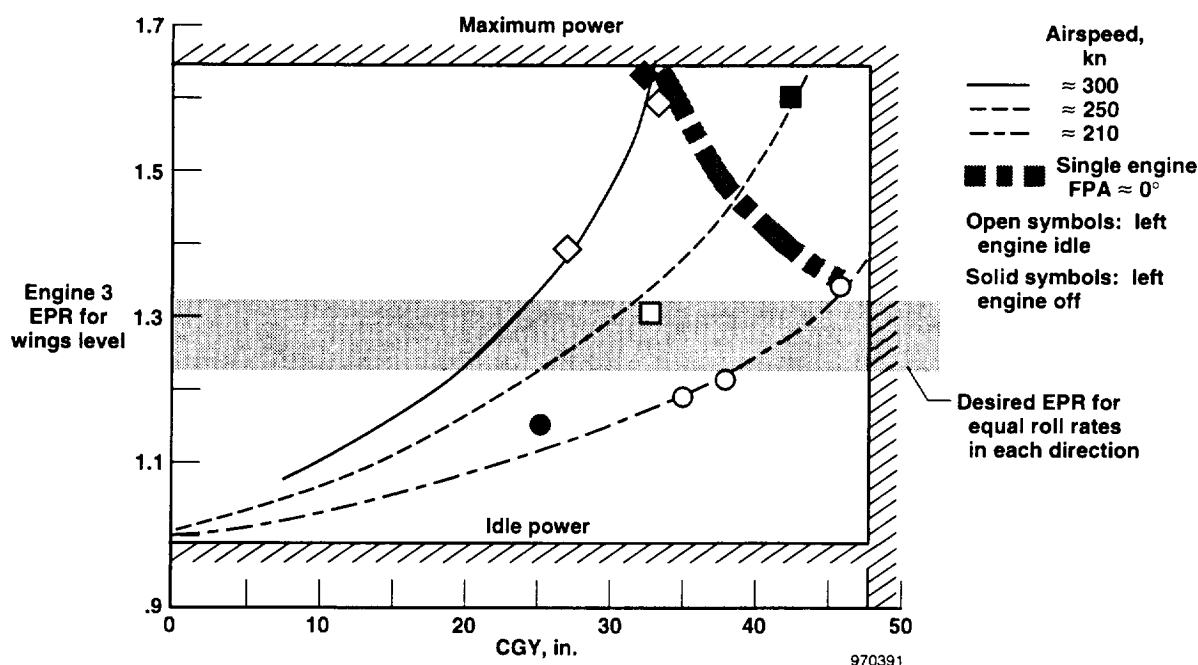

Figure 46. Effect of lateral CG offset on EPR on engine 3 required for wings-level flight, flaps and slats up, gear up, altitude \approx 10,000 ft, gross weight \approx 400,000 lb, center engine idle.

Unfamiliar Crew PCA System Test

In a test designed to evaluate the need for PCA system training, a crew with no previous experience with the PCA system was exposed to a total flight control system failure situation in the MD-11 FDS. One of the crewmembers was an MDA pilot without extensive MD-11 experience. The other was a Honeywell pilot that was familiar with normal MD-11 operation. Neither had ever seen PCA in operation.

The failure was induced soon after takeoff at Los Angeles International Airport with the gear up, Flaps 10, gross weight of 445,000 lb, and an airspeed of 230 kn. The simulation operator turned off all three hydraulic systems. A placard was exposed (simulating an electronic advisory system message) advising the crew that all three hydraulic systems had failed, and that a PCA system was available with instructions on how to engage the PCA system. The placard also referred the crew to a PCA page that could be included in an emergency procedures manual for more information.

The crew immediately engaged the PCA system and found operation similar to the normal autopilot. They continued the climb to a safer altitude, then read the emergency procedures PCA page, and planned a return to the airport. The crew leveled off, practiced with PCA operation, and were satisfied that they understood its operation and performance. They initially decided to fly to Edwards, but to make this test more generic, they were asked to return to Los Angeles. The crew decided to fly an ILS-coupled approach at Los Angeles. The hydraulic failure had increased trim speed by 20 kn. Available information included ways to reduce airspeed; the crew used the technique of reducing the center engine to idle, which reduced airspeed by 20 kn. They also dumped fuel, reducing speed by another 15 kn to 215 kn. The crew set up a long downwind at 4000 ft, lowered the gear, and turned inbound at 20 mi to intercept the ILS. Approach speed was 210 kn, still with Flaps 10. ILS capture was nominal, and the approach was successfully flown down to 20 ft. At this point, because of the ground effect and the higher than normal speed, the airplane floated, and with most of the runway behind them, the crew elected to go around. They stated that if

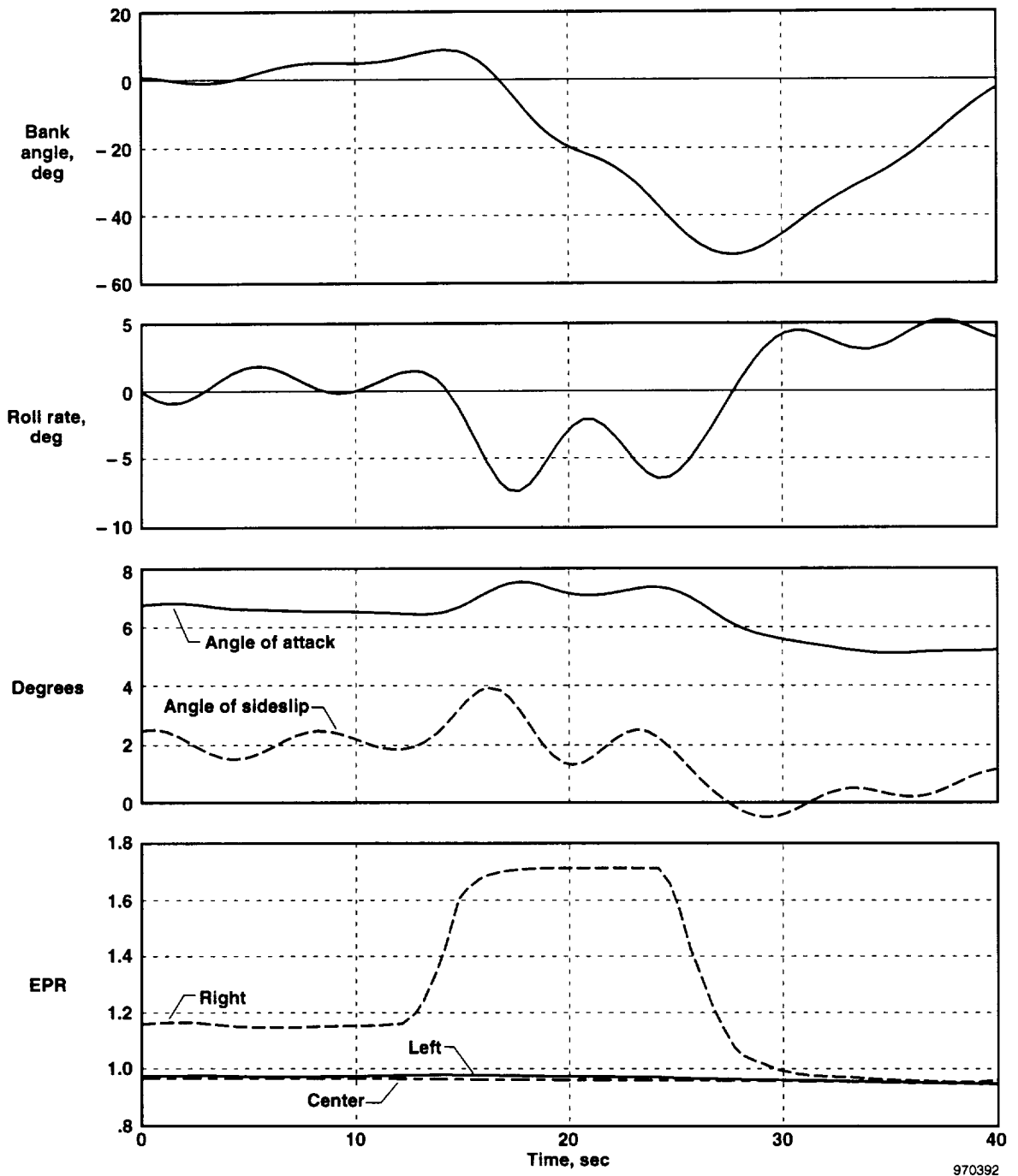

970392

Figure 47. Time history of response to right throttle step inputs, MD-11 FDS, 205 kn, altitude = 7500 ft, gear and flaps up, dampers off, 35 in. lateral CG offset.

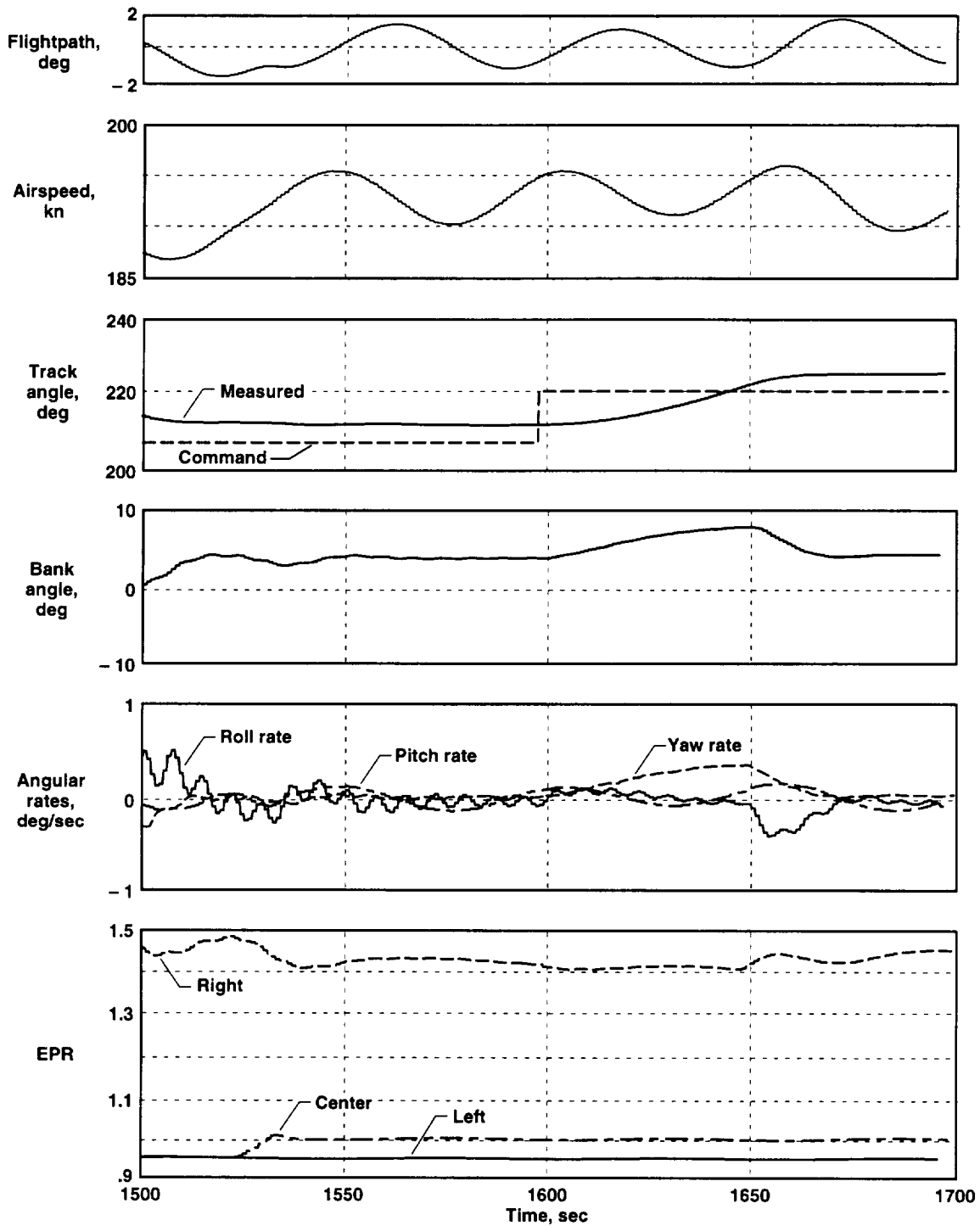

970393

Figure 48. MD-11 FDS with left engine idle, lateral CG offset 31 in. right, gear and flaps up, PCA lateral track mode active, 15,000 ft, GW = 380,000 lb.

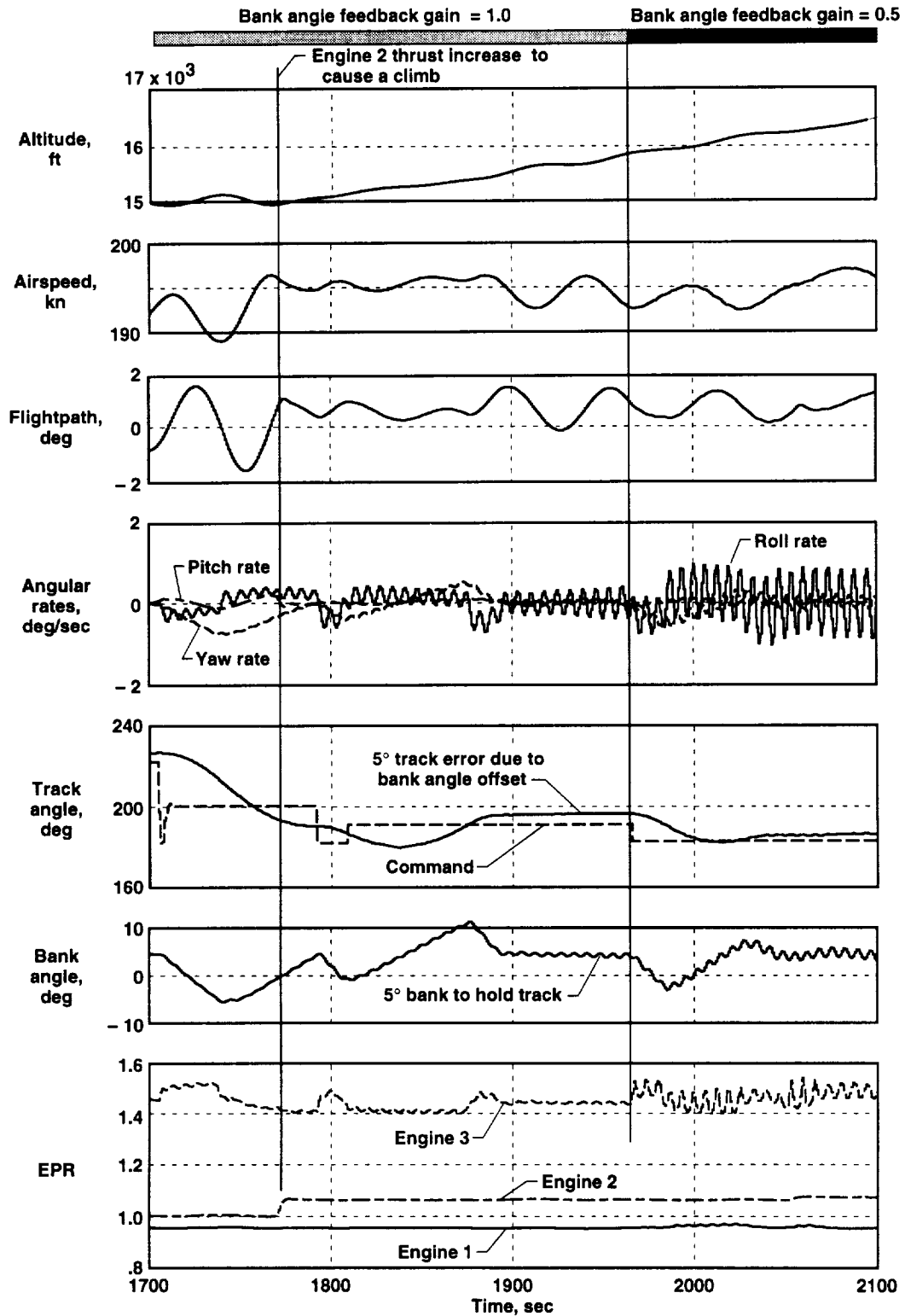

970394

Figure 49. MD-11 PCA FDS with left engine at idle, lateral CG 31 in. right, PCA lateral mode engaged, no flight control inputs, all dampers off, gear and flaps up, center throttle step increase and bank angle feedback gain decrease.

time permitted, they would then have flown to Edwards and landed on the lakebed. If not, they would have made another ILS approach and pulled the power to idle during the flare. All of this was done without any training, and indicates that PCA system operation is so sufficiently straightforward that extensive training is not required. The demonstration also showed that the flare logic that worked for Flaps 28 would need more tuning to operate at other conditions.

FUTURE APPLICATION OF A PCA SYSTEM

Based on the success of the MD-11 PCA system tests, previous F-15 PCA flight tests, and B-747 and C-17 simulator tests, a PCA system appears to provide an acceptable backup flight control system capable of safe landings independent of hydraulic power. The addition of a slow electric actuator for trimming the stabilizer would allow the crew to select the trim speed, thereby eliminating the need to plan and use CG and weight control for controlling trim speed. Of course, annunciation, display, and engagement issues would have to be refined over what was done in this concept demonstration flight test.

CONCLUSIONS

A concept demonstration propulsion-controlled aircraft (PCA) system using closed-loop thrust for control has been designed, developed, and flight tested on an MD-11 airplane. The system was implemented with software changes to existing flight and engine control computers, and uses the autopilot knobs on the glareshield flight control panel for pilot inputs.

1. Flight tests totaling 25 hr have shown that a PCA system can successfully provide control adequate for up-and-away flight and for runway landings without the use of normal flight control surfaces.
2. Pitch PCA control using the wing engines was excellent primarily because of the location of the wing engines well below the vertical center of gravity. Approximately 8 to 10 sec was required to achieve a flightpath command. In smooth air, flightpath was held to within less than 0.5° of the pilot's command; in light-to-moderate turbulence, flightpath was held within 1° of that commanded.
3. Lateral PCA control was stable and adequate for up-and-away flight. In smooth air, track angle was held to within 0.5° of the pilot's command. A 5° track command took 15 sec to achieve. On approach, lateral control was sluggish and required some pilot compensation.
4. In smooth air, a new pilot could make a successful PCA approach on a first try. In turbulence, three or four approaches were needed before a new pilot was able to effectively adapt to the sluggish lateral control and maintain runway alignment.
5. A PCA instrument landing system-coupled approach and landing capability was added, which allowed new pilots to make very good approaches on their first try. The instrument landing system-coupled approaches were successful in turbulence levels up to at least moderate.
6. The PCA system was tested over a wide flight envelope well beyond the design envelope and was found to perform somewhat better than predicted. Performance at 30,000 ft, at an aft center of gravity position, and at 360 kn was adequate, even though the design was developed for speeds from 150 to 200 kn at altitudes below 15,000 ft.
7. The PCA system was tested with all three hydraulic systems depressurized and functioned normally during 25 min of flight tests.
8. In general, flight-to-simulation comparisons were reasonably good. An exception was that although the trim speed change with loss of hydraulic pressure was predicted to be a 20 kn gain, it was found to be a 20 kn loss.

9. A total of 16 demonstration pilots flew the PCA system, and pilot comments were very favorable. All pilots adapted rapidly to the PCA system, and all made successful instrument-landing system-coupled approaches on the first try.
10. Several ways are available to adjust the trim speed on the MD-11: reducing weight, moving the CG, extending the landing gear, and changing the throttle setting on the center engine. A more flexible way to control trim speed on a new aircraft design would be to incorporate an independent slow rate stabilizer trim capability.
11. Digital electronic engine controllers provide accurate and repeatable thrust control that improves the performance of a PCA system.
12. Wing-engine-out lateral control using only thrust and a lateral center-of-gravity offset from fuel transfer has been demonstrated in the flight deck simulator (FDS), and appears promising for further development.

LESSONS LEARNED

Digital flight control and engine control systems with digital data buses provide a powerful capability to add new control modes with only software changes.

PCA capability on a transport airplane was accurately predicted by a high-fidelity simulation. This prediction was in contrast to the PCA system tested on the F-15 fighter airplane, where the simulation required extensive modification to duplicate flight trends. The podded engines on a typical transport airplane are believed to be more easily modeled, in contrast to the difficulty in modeling the characteristics of the typical highly integrated fighter engine and inlet.

The flexibility designed into the flight software was key in the successful PCA test. In particular, it was possible to improve the lateral response and to test the system far beyond its design envelope using this software flexibility.

PCA system flight tests on the MD-11 were needed to validate the PCA concept. Before the flight test, one knowledgeable company test pilot said that the airplane would never be landed under PCA system control. At the end of the demonstration flights, this same pilot was advocating additional PCA landings.

*Dryden Flight Research Center
National Aeronautics and Space Administration
Edwards, California, April 16, 1997*

REFERENCES

1. Burcham, Frank W., Jr., Trindel A. Maine, C. Gordon Fullerton, and Lannie Dean Webb, *Development and Flight Evaluation of an Emergency Digital Flight Control System Using Only Engine Thrust on an F-15 Airplane*, NASA TP-3627, Sept. 1996.
2. Burcham, Frank W., Jr. and C. Gordon Fullerton, *Controlling Crippled Aircraft—With Throttles*, NASA TM-104238, Sept. 1991.
3. Gilyard, Glenn B., Joseph L. Conley, Jeanette Le, and Frank W. Burcham, Jr., “A Simulation Evaluation of a Four-Engine Jet Transport Using Engine Thrust Modulation for Flightpath Control,” AIAA-91-2223, June 1991.
4. Burcham, Frank W., Jr., Trindel Maine, and Thomas Wolf, *Flight Testing and Simulation of an F-15 Airplane Using Throttles for Flight Control*, NASA TM-104255, Aug. 1992.
5. Powers, Sheryll Goecke, compiler, *An Electronic Workshop on the Performance Seeking Control and Propulsion Controlled Aircraft Results of the F-15 Highly Integrated Digital Electronic Control Flight Research Program: Proceedings of the Electronic Workshop*, NASA TM-104278, Jan. 1995.
6. Gerren, Donna S., *Design, Analysis, and Control of a Large Transport Aircraft Utilizing Selective Engine Thrust as a Backup System for the Primary Flight Control*, NASA CR-186035, Oct. 1995.
7. Bull, John, Robert Mah, Gloria Davis, Joe Conley, Gordon Hardy, Jim Gibson, Matthew Blake, Don Bryant, and Diane Williams, *Piloted Simulation Tests of Propulsion Control as Backup to Loss of Primary Flight Controls for a Mid-Size Jet Transport*, NASA TM-110374, Dec. 1995.
8. Bull, John, Robert Mah, Gordon Hardy, Barry Sullivan, Jerry Jones, Diane Williams, Paul Soukup, and Jose Winters, *Piloted Simulation Tests of Propulsion Control as Backup to Loss of Primary Flight Controls for a B-747-400 Jet Transport*, NASA TM-112191, Apr. 1997.
9. Dornheim, Michael A., “Throttles Land ‘Disabled’ Jet,” *Aviation Week & Space Technology*, Sept. 4, 1995, pp. 26–27.
10. Kolano, Ed, “Fly by Fire,” *Flight International*, Dec. 20, 1995, pp. 26–29.
11. Burcham, Frank W., Jr., Trindel A. Maine, John J. Burken, and Drew Pappas, “Development and Flight Test of an Augmented Thrust-Only Flight Control System on an MD-11 Transport Airplane,” AIAA-96-3742, July 1996. Also available as NASA TM-4745, July 1996.
12. Burken, John J., Frank W. Burcham, Jr., Trindel A. Maine, John Feather, Steven Goldthorpe, and Jeffrey A. Kahler, “Flight Test of a Propulsion-Based Emergency Control System on the MD-11 Airplane With Emphasis on the Lateral Axis,” AIAA-96-3919, July 1996.
13. Burken, John J., Trindel A. Maine, Frank W. Burcham, Jr., and Jeffrey A. Kahler, “Longitudinal Emergency Control System Using Thrust Modulation Demonstrated on an MD-11 Airplane,” AIAA-96-3062, July 1996.
14. Feather, J. B. and F. W. Burcham, Jr., “Development and Flight Test of the Propulsion Controlled Aircraft (PCA) Concept as Applied to an MD-11,” CRAD-9206-TR-1654, MDC 96K0202, Mar. 1996.
15. Burcham, Frank W., Jr. and C. Gordon Fullerton, “Propulsion Control Update—MD-11 Flight Results,” Society of Experimental Test Pilots, *40th Symposium Proceedings*, Sept. 1996, pp. 16–26.
16. Anon., “Inquiry Committee Analyzes JAL 747 Flight Data Recorder,” *Aviation Week & Space Technology*, Sept. 9, 1985, p. 97.
17. Anon., “Aircraft Accident Report—United Airlines Flight 232, McDonnell Douglas DC-10-10,” Sioux Gateway Airport, Sioux City, Iowa, July 19, 1989, PB90-910406, NTSB/AAR 90/06, Nov. 1990.

18. Anon., "Aircraft Accident Report —American Airlines, Inc., McDonnell Douglas DC-10-10," N103AA, Near Windsor, Ontario, Canada, June 12, 1972, NTSB/AAR 73-2, Feb. 28, 1973.
19. Anon., "Cargo Door Focus of Paris Crash Study," *Aviation Week & Space Technology*, Mar. 11, 1974, pp. 198–199.
20. McMahan, Jack, "Flight 1080," *Air Line Pilot*, July 1978, pp. 182–186.
21. Anon., "C-5 Crash Cause Sought," *Aviation Week & Space Technology*, Apr. 14, 1975, p. 18.
22. Burcham, Frank W., Jr., John J. Burken, Trindel A. Maine, and John Bull, "Emergency Flight Control Using Only Engine Thrust and Lateral CG Offset—A First Look," AIAA-97-3189.

REPORT DOCUMENTATION PAGE

Form Approved
OMB No. 0704-0188

Public reporting burden for this collection of information is estimated to average 1 hour per response, including the time for reviewing instructions, searching existing data sources, gathering and maintaining the data needed, and completing and reviewing the collection of information. Send comments regarding this burden estimate or any other aspect of this collection of information, including suggestions for reducing this burden, to Washington Headquarters Services, Directorate for Information Operations and Reports, 1215 Jefferson Davis Highway, Suite 1204, Arlington, VA 22202-4302, and to the Office of Management and Budget, Paperwork Reduction Project (0704-0188), Washington, DC 20503.

1. AGENCY USE ONLY (Leave blank)	2. REPORT DATE October 1997	3. REPORT TYPE AND DATES COVERED Technical Paper	
4. TITLE AND SUBTITLE Development and Flight Test of an Emergency Flight Control System Using Only Engine Thrust on an MD-11 Transport Airplane			5. FUNDING NUMBERS WU 522 15 34
6. AUTHOR(S) Frank W. Burcham, Jr., John J. Burken, Trindel A. Maine, and C. Gordon Fullerton			
7. PERFORMING ORGANIZATION NAME(S) AND ADDRESS(ES) NASA Dryden Flight Research Center P.O. Box 273 Edwards, California 93523-0273			8. PERFORMING ORGANIZATION REPORT NUMBER H-2170
9. SPONSORING/MONITORING AGENCY NAME(S) AND ADDRESS(ES) National Aeronautics and Space Administration Washington, DC 20546-0001			10. SPONSORING/MONITORING AGENCY REPORT NUMBER NASA /TP-97-206217
11. SUPPLEMENTARY NOTES			
12a. DISTRIBUTION/AVAILABILITY STATEMENT Unclassified—Unlimited Subject Category 08			12b. DISTRIBUTION CODE
13. ABSTRACT (Maximum 200 words) An emergency flight control system that uses only engine thrust, called the propulsion-controlled aircraft (PCA) system, was developed and flight tested on an MD-11 airplane. The PCA system is a thrust-only control system, which augments pilot flightpath and track commands with aircraft feedback parameters to control engine thrust. The PCA system was implemented on the MD-11 airplane using only software modifications to existing computers. Results of a 25-hr flight test show that the PCA system can be used to fly to an airport and safely land a transport airplane with an inoperative flight control system. In up-and-away operation, the PCA system served as an acceptable autopilot capable of extended flight over a range of speeds, altitudes, and configurations. PCA approaches, go-arounds, and three landings without the use of any normal flight controls were demonstrated, including ILS-coupled hands-off landings. PCA operation was used to recover from an upset condition. The PCA system was also tested at altitude with all three hydraulic systems turned off. This paper reviews the principles of throttles-only flight control, a history of accidents or incidents in which some or all flight controls were lost, the MD-11 airplane and its systems, PCA system development, operation, flight testing, and pilot comments.			
14. SUBJECT TERMS Emergency Control, MD-11, Propulsion Control, Throttle-only control			15. NUMBER OF PAGES 92
			16. PRICE CODE A05
17. SECURITY CLASSIFICATION OF REPORT Unclassified	18. SECURITY CLASSIFICATION OF THIS PAGE Unclassified	19. SECURITY CLASSIFICATION OF ABSTRACT Unclassified	20. LIMITATION OF ABSTRACT Unlimited