



1N-15
358489
90

Reusable Rocket Engine Operability Modeling and Analysis

*R.L. Christenson and D.R. Komar
Marshall Space Flight Center, Marshall Space Flight Center, Alabama*

The NASA STI Program Office...in Profile

Since its founding, NASA has been dedicated to the advancement of aeronautics and space science. The NASA Scientific and Technical Information (STI) Program Office plays a key part in helping NASA maintain this important role.

The NASA STI Program Office is operated by Langley Research Center, the lead center for NASA's scientific and technical information. The NASA STI Program Office provides access to the NASA STI Database, the largest collection of aeronautical and space science STI in the world. The Program Office is also NASA's institutional mechanism for disseminating the results of its research and development activities. These results are published by NASA in the NASA STI Report Series, which includes the following report types:

- **TECHNICAL PUBLICATION.** Reports of completed research or a major significant phase of research that present the results of NASA programs and include extensive data or theoretical analysis. Includes compilations of significant scientific and technical data and information deemed to be of continuing reference value. NASA's counterpart of peer-reviewed formal professional papers but has less stringent limitations on manuscript length and extent of graphic presentations.
- **TECHNICAL MEMORANDUM.** Scientific and technical findings that are preliminary or of specialized interest, e.g., quick release reports, working papers, and bibliographies that contain minimal annotation. Does not contain extensive analysis.
- **CONTRACTOR REPORT.** Scientific and technical findings by NASA-sponsored contractors and grantees.

- **CONFERENCE PUBLICATION.** Collected papers from scientific and technical conferences, symposia, seminars, or other meetings sponsored or cosponsored by NASA.
- **SPECIAL PUBLICATION.** Scientific, technical, or historical information from NASA programs, projects, and mission, often concerned with subjects having substantial public interest.
- **TECHNICAL TRANSLATION.** English-language translations of foreign scientific and technical material pertinent to NASA's mission.

Specialized services that complement the STI Program Office's diverse offerings include creating custom thesauri, building customized databases, organizing and publishing research results...even providing videos.

For more information about the NASA STI Program Office, see the following:

- Access the NASA STI Program Home Page at <http://www.sti.nasa.gov>
- E-mail your question via the Internet to help@sti.nasa.gov
- Fax your question to the NASA Access Help Desk at (301) 621-0134
- Telephone the NASA Access Help Desk at (301) 621-0390
- Write to:
NASA Access Help Desk
NASA Center for AeroSpace Information
800 Elkridge Landing Road
Linthicum Heights, MD 21090-2934



Reusable Rocket Engine Operability Modeling and Analysis

R.L. Christenson and D.R. Komar

Marshall Space Flight Center, Marshall Space Flight Center, Alabama

National Aeronautics and
Space Administration

Marshall Space Flight Center

Acknowledgments

Many made contributions directly and indirectly to this effort that are much appreciated. These include Robert Beil, Ron Liston, Jennifer Ringelberg, Richard Brown, William D. Morris, Edgar Zapata, Russ Rhodes, Michael Nix, Fred Huffaker, and Barney Holt. A special thanks to Richard Ryan, who supported the requirements definition and to Bruce Fleming, who supported the extensive data collection necessary to conduct these analyses.

Available from:

NASA Center for AeroSpace Information
800 Elkridge Landing Road
Linthicum Heights, MD 21090-2934
(301) 621-0390

National Technical Information Service
5285 Port Royal Road
Springfield, VA 22161
(703) 487-4650

TABLE OF CONTENTS

| | | |
|----|---|----|
| 1. | INTRODUCTION | 1 |
| 2. | BACKGROUND | 3 |
| 3. | OPERABILITY ASSESSMENT METHODOLOGY | 4 |
| | A. Approach | 4 |
| | B. Key Concepts and Definitions | 7 |
| | C. Modeling and Uncertainty | 8 |
| | D. Process Flow Definition | 9 |
| 4. | MODELING TOOLS | 10 |
| 5. | BASELINE ENGINE OPERATIONS DATA | 11 |
| | A. Data Collection | 11 |
| | B. Scheduled Processing | 12 |
| | C. Unscheduled Processing | 15 |
| | D. Baseline Requirements Database | 17 |
| 6. | MODEL DEVELOPMENT AND RESULTS | 19 |
| | A. Deterministic Model | 20 |
| | B. Probabilistic Model | 23 |
| 7. | CONCLUSIONS | 32 |
| | Appendix A—Engine Operations Requirements Database | 33 |
| | Appendix B—Scheduled SSME Operations Data | 45 |
| | Appendix C—Unscheduled SSME Operations Data | 66 |
| | Appendix D—Pertinent SSME Results From Analysis of Data Collected | 73 |
| | Appendix E—Reliability of Engine Sets With Engine Out Capability | 77 |
| | REFERENCES | 80 |

LIST OF FIGURES

| | | |
|-----|---|----|
| 1. | Disciplines in design..... | 1 |
| 2. | Launch vehicle process flow—operational phase | 4 |
| 3. | Operability assessment methodology | 5 |
| 4. | Design-to-operations analysis approach | 7 |
| 5. | Operations modeling and data collection process | 11 |
| 6. | OPF SSME postflight operations | 12 |
| 7. | OMEF SSME operations | 13 |
| 8. | OPF post-SSME installation operations | 13 |
| 9. | SSME VAB/pad processing operations | 14 |
| 10. | Example of detailed model—HPFTP removal and replace | 14 |
| 11. | SSME base R&R | 16 |
| 12. | Requirements to process definition | 17 |
| 13. | Engine operations processing | 20 |
| 14. | Hierarchical engine model | 21 |
| 15. | Extend reusable engine operations model | 25 |
| 16. | Operability measures by process time | 28 |
| 17. | Impact of reliability on operability | 29 |
| 18. | Operability metrics by reliability | 29 |
| 19. | Engine operations manhours/cost analysis | 30 |
| 20. | Base MR accept | 66 |

LIST OF FIGURES (Continued)

| | | |
|-----|---|----|
| 21. | Base MR repair | 66 |
| 22. | Base PR accept | 67 |
| 23. | Base PR repair | 67 |
| 24. | Base waiver/exception | 67 |
| 25. | Total SSME manhours by process type | 73 |
| 26. | Scheduled SSME manhours by process type | 74 |
| 27. | Unscheduled SSME manhours by process type | 75 |
| 28. | SSME manhours by process type | 76 |

LIST OF TABLES

| | | |
|-----|---|----|
| 1. | SSME PR classification summary | 15 |
| 2. | OMRSD/OMI database with requirements rationale | 17 |
| 3. | SSME unscheduled maintenance experience | 22 |
| 4. | Goal-oriented engine operations timelines | 23 |
| 5. | Results of probabilistic analysis | 27 |
| 6. | Probabilistic model uncertainty impact | 28 |
| 7. | Engine processing manhours and launch delay reduction | 30 |
| 8. | Engine requirements database | 34 |
| 9. | OPF SSME postflight planned operations | 46 |
| 10. | OMEF SSME planned operations | 47 |
| 11. | OPF post-SSME installation planned operations | 48 |
| 12. | SSME VAB/pad processing planned operations | 49 |
| 13. | OPF rollin to SSME removal tasks | 50 |
| 14. | Engine shop turnaround tasks | 55 |
| 15. | Engine installation to OPF rollout tasks | 56 |
| 16. | VAB rollin to launch tasks | 60 |
| 17. | Example of detailed data for scheduled processing in OMEF | 65 |
| 18. | SSME unscheduled processing summary | 68 |
| 19. | Example of detailed data for unscheduled processing | 72 |
| 20. | Engine out capability comparison | 77 |
| 21. | Engine out and time of engine out comparison | 79 |

ACRONYMS

| | |
|-----------------|--|
| CAPSS | Computer-Aided Planning and Scheduling System |
| DAR | deviation approval request |
| ELV | expendable launch vehicles |
| EMA | electromechanical actuator |
| gox | gaseous oxygen |
| GSE | ground support equipment |
| HPFTP | high-pressure fuel turbopump |
| HPOTP | high-pressure oxidizer turbopump |
| I_{sp} | specific impulse |
| KSC | Kennedy Space Center |
| LH ₂ | liquid hydrogen |
| LO ₂ | liquid oxygen |
| MDT | mean downtime |
| MR | material review |
| MS | Microsoft® |
| MSFC | Marshall Space Flight Center |
| MTBF | mean time between failure |
| MTBM | mean time between maintenance |
| MTTR | mean time to repair |
| NASA | National Aeronautics and Space Administration |
| OMEF | orbiter main engine facility |
| OMI | Operations and Maintenance Instructions |
| OMRSD | Operations and Maintenance Requirements and Specification Document |
| OPF | orbiter processing facility |
| PR | problem report |
| PRACA | Problem Reporting and Corrective Action |
| R&R | remove and replace |
| RLV | reusable launch vehicle |
| SSME | space shuttle main engine |
| STS | Space Transportation System |
| TVCA | thrust vector control assembly |
| VAB | vehicle assembly building |

TECHNICAL PUBLICATION

REUSABLE ROCKET ENGINE OPERABILITY MODELING AND ANALYSIS

1. INTRODUCTION

The reusable launch vehicle (RLV) cooperative development program between NASA and the aerospace industry demands the design of cost-effective vehicles and associated propulsion systems. In turn, cost-effective propulsion systems demand minimal and low recurring costs for ground operations. Thus, the emphasis early on in this program should be effective operations modeling supported by the collection and use of applicable operations data from a comparable existing system. Such a model could support the necessary trades and design decisions toward a cost-effective propulsion system development program. These analyses would also augment the more traditional performance analyses in order to support a concurrent engineering design environment.¹⁻⁴

In this view, functional area analyses are conducted in many areas including operations, reliability, manufacturing, cost, and performance, as presented in figure 1. The design engineer is responsible to incorporate the input from these areas into the design where appropriate. The designer also has the responsibility to conduct within and between discipline design trades with support from the discipline experts. Design decisions without adequate information from one or more of these areas results in an incomplete decision with potential serious consequences for the hardware. Design support activities in each functional area are the same. Models are developed and data are collected to support the model analysis. These models and data are at an appropriate level of detail to match the objectives of the analysis. Metrics are used in order to quantify the output. This is an iterative approach that supports the design schedule with results updated from increasingly more detailed design information.

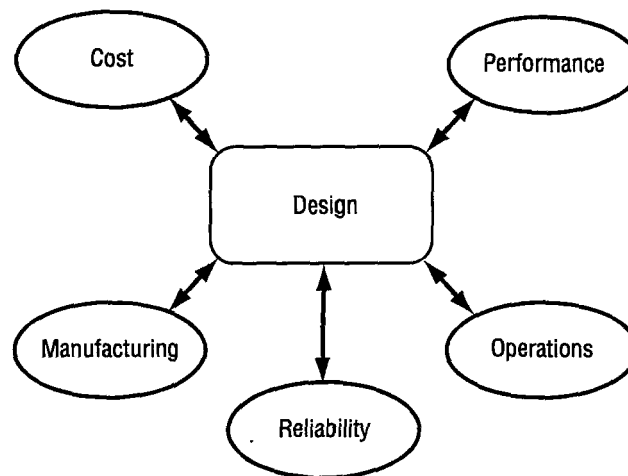

Figure 1. Disciplines in design.

Currently, in aerospace applications, there is a mismatch between the complexity of models (as supported by the data) within the various disciplines. For example, while good engine performance models with accurate metrics exist, the use of absolute metrics of reliability for rocket engine systems analysis is rarely supported. This is a result of the lack of good test data, lack of comparable aerospace systems, and a lack of comparative industrial systems relative to aerospace mechanical systems. Metrics also tend to be less credible for reliability. There is, as yet, not a comparable reliability metric that would allow one to measure and track reliability as the engine specific impulse (I_{sp}) metric allows one to measure and track engine performance. Performance models such as an engine power balance model or a vehicle trajectory model tend to be of good detail, with a good pedigree, and the results well accepted by the aerospace community. The propulsion system designer has to be aware of these analysis fidelity disparities when it becomes necessary to base a design decision on an analysis.

There is a need to develop models to obtain different objectives. Early in a launch vehicle development program, a top-level analysis serves the purpose of defining the problem and securing top-level metrics as to the feasibility and goals of the program. This “quick-look” model effort serves a purpose—it often defines the goals of the program in terms of performance, cost, and operability. It also is explicit about the need to do things differently in terms of achieving more stringent goals. A detailed bottom-up analysis is more appropriate to respond to the allocation based on an indepth study of the concepts. The “quick-look” model is appropriate if the project manager is the customer; the detailed analysis is directed more at the design engineer. Both are of value. The “quick-look” model also may serve the purpose of the allocated requirements model, the model to which comparisons are made to determine maturity of the design. It is inappropriate to use the data that supported the allocation of requirements to also support the detailed analysis. Although often done, this is inappropriate and could lead to misleading results.

The acquisition of good data is a traditional problem for the definition of baseline systems for aerospace launch vehicle operations analyses. For all models developed here, the Space Transportation System (STS) and the space shuttle main engine (SSME) are used as the source of historical reusable vehicle and engine systems operations experience. For the detailed model, the approach demands the identification of the requirements for SSME ground operations and the root source of the requirements. From this, a reusable engine model is developed that is based on the SSME operations model. This is done through incremental modification of the baseline operations model based on the proposed changes from the SSME to the reusable engine. The modifications of these processing activities are based on changes in hardware configuration and technology, processing technology improvements, and operations philosophy. The reusable engine system model is then traceable to past requirements and historical experience. This modeling approach supports credible operations modeling and analysis. In this paper, the baseline SSME model and a demonstration of its utility are presented.

2. BACKGROUND

The lack of historical data in support of aerospace launch vehicle operations analyses is acute. Data are either unavailable due to not being collected or not public, or are so highly aggregated as to mask needed detail at the process level. Top-level models generated by existing data were generally useful only for supporting programmatic goal discussions. Discrete event simulation models have often been models of choice.⁵⁻⁷

One approach to aerospace launch vehicle operations analyses is to compare with aircraft data. This information is generally more readily available and in the proper format with data collected from a maintainability point of view. Several papers have taken this approach.^{8,9} While this data supports good model development, the question of applicability of results is more of an issue. This is especially true of rocket and aircraft propulsion systems with major differences in configurations, environment, and operating philosophy. Specifically, these differences include operating environment; operating temperatures, pressures, and thrust; ability to idle, taxi, and loiter aircraft engines and vehicles; use of cryogenic fuels on rockets; large performance margins on aircraft; nonintrusive health management of aircraft propulsion systems; and, perhaps the major difference, a philosophy of use with aircraft that tolerates test and operational failures (and even loss of life).

Ground operations analyses have also been conducted for aerospace launch vehicles based on available STS operations data.^{10,11} Although the available data were found to be insufficient,¹² existing databases can be augmented by other sources, such as the experience of launch site personnel. This study builds on this approach. The SSME is regarded as the most directly applicable baseline for comparison with future and similar liquid oxygen (LO₂)/liquid hydrogen (LH₂) rocket systems. Thus, for this effort, extensive data collection was undertaken for STS propulsion systems to augment the existing databases. A baseline set of propulsion systems ground operations databases has been developed with the goal of supporting detailed engineering analyses of process and manpower requirements for future propulsion system concepts.

3. OPERABILITY ASSESSMENT METHODOLOGY

A. Approach

The operability assessment methodology described in this document reflects an end-to-end process flow model that models the uncertainties inherent in the attributes of the process flows. This approach attempts to substitute a rigorous and objective structure for more qualitative types of judgments and to focus design experiences to help determine areas of design confidence. It is to be used upfront in the design process and combines past flight vehicle experiences with design analysis to determine cost and schedule parameters of interest. It can be used in the analysis of any process flow where the goal is to optimize processing in order to minimize cost and schedule impacts.

The continuum of process flow activities includes development through manufacturing, assembly, and operations. For this modeling effort, the emphasis will be on the operational phase only. Figure 2 presents the flows of the operational phase of a launch vehicle, a subset of which will be the focus of this analysis.

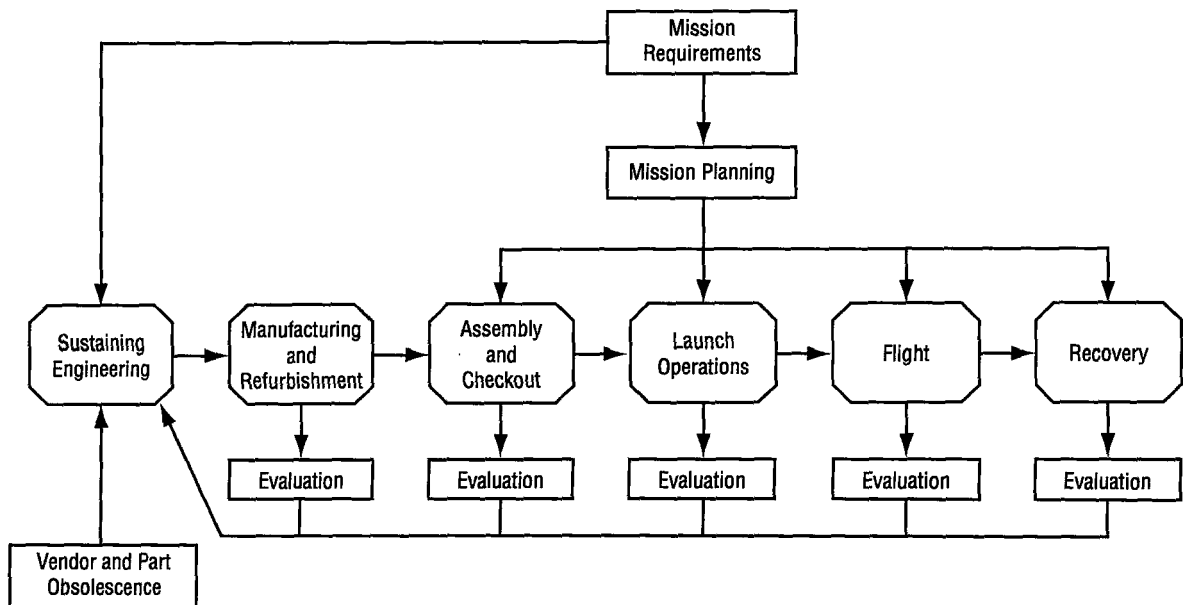

Figure 2. Launch vehicle process flow—operational phase.

The process flow model avoids estimates of cost and schedule parameters based upon nonspecific design characteristics such as weight and the use of integration “scale factors.” In this modeling effort, cost and schedule indicators will be based upon realistic, high-fidelity process flows targeted against the current design configuration.

This approach incorporates past vehicle development experiences in terms of experience databases. These are critical parts of this methodology and are explicitly included in the approach. Since it is often difficult to obtain historical data to support these design decisions, a significant effort was undertaken to identify, incorporate, and appropriately structure this information for use with the process flow model.

Figure 3 presents the input flowing to the proposed process flows of a new launch vehicle. The new vehicle requirements and design configuration contribute in the definition of flows as does information gathered relative to historical launch vehicle flows. Data and requirements that are applicable from past launch and flight vehicles, including aircraft, expendable launch vehicles (ELV’s), and the STS, may be used to generate or edit proposed flows and will be the main source of what is required (attributes) by these process flows in terms of manpower and schedule. The design and proposed flows will be continually updated, thus the approach is iterative. Also, historical data will be useful in providing insight into the traditional problems associated with the proposed process flow. Finally, new systems may require certain technology or special analyses to determine the operability of the system. This is also input to the process flow definition process. All of this information is, of course, subject to adaptation and interpretation by the design, manufacturing, and operations engineers. These groups and others must be involved at the outset in order for this to be a truly concurrent engineering effort.

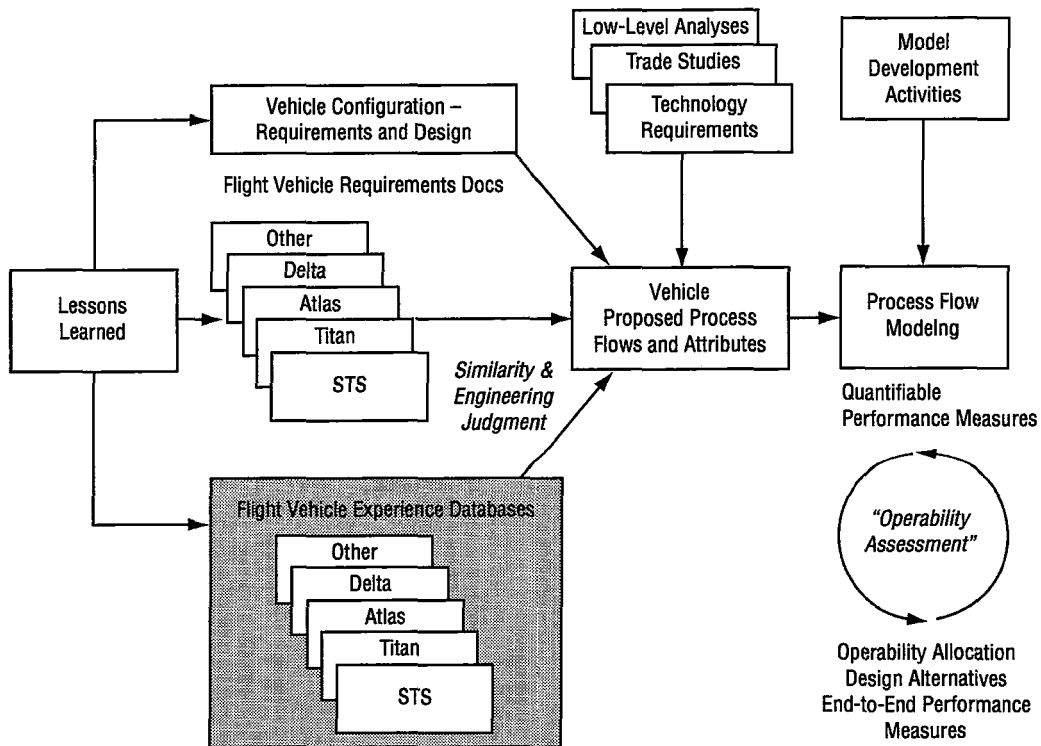

Figure 3. Operability assessment methodology.

The lessons learned on other vehicles implicitly affects current design engineering efforts and also serves to organize the search for applicable historical data. For example, the problems of past hydraulic systems on flight vehicles may cause the design engineer to attempt to include an electromechanical actuator (EMA) subsystem into the current design. Also, this “lesson learned” can serve to organize the identification of historical process flows, requirements, and experiences. Organized appropriately, historic processes associated with hydraulics can be easily pulled from the database, thus facilitating the analysis of this problem area by an appropriate design engineering team. This step of the methodology involves more of a qualitative assessment than a quantitative one. However, there is a structure surrounding the use of “lessons learned” that reflects the need to evolve and iterate this process with the “lesson learned” information.

Once the process flows and associated attributes have been defined, the modeling of the flows to generate quantifiable performance measures can be supported. The probabilistic nature of the system is clear due to the uncertain environment. Sensitivity studies, design change studies, and operability assessment studies are all supported.

A top-down approach is utilized in identifying and tracing process flows. At the outset, this hierarchical method is useful in identifying major cost and schedule drivers and assists in the allocation of scarce resources in the further analysis of the lower-level process flows. The danger of low-level analyses is the danger of misallocation of scarce resources to analyses that are not clearly important cost or schedule drivers. A top-down approach creates traceability of functional flows at each level in the hierarchy. It also serves to document and allocate the top-level program requirements. Its usefulness is limited to a “quick-look” analysis and for comparison purposes with the detailed analyses.

This methodology is designed to incorporate results from bottom-up analyses. Systematic evaluations of low-level process flows in terms of cost and schedule attributes will feed a detailed modeling activity. Once both models exist and comparisons are supported, both goals and actual timelines are subject to change: the top-down apportionment can be reallocated or changed; and the bottom-up reanalyzed and adapted to design changes resulting from changes incorporated into the design influenced by this modeling activity. Given this approach, the initial emphasis of this effort will be on supporting relative comparisons among design changes. Upon completion of an appropriate level of detail, accurate estimates can be generated.

Figure 4 provides an overview of this two-pronged approach. First, a goal timeline is created from a future launch vehicle operations concept. Making this goal reflect an actual design is desirable if such a design exists. However, these are goals, and as such, are meant as comparison points for a bottom-up engineering analysis of a historical baseline system. The second prong is this bottom-up effort, which provides an experience base and supports traceability to design, technology, and process improvements for the future launch vehicle propulsion system. This bottom-up effort is the focus of this paper. A previous paper¹³ presented the goal-oriented approach, with both scheduled and unscheduled processing included in the goal flows. By nature, this approach is iterative. Comparing the historical estimates against the goals provides an identification of key differences. Design decisions will seek to lessen these differences—larger differences seeking the most design effort in an appropriate design manpower allocation process. The design will change and so also will the goals. Unrealistic goals and requirements will be identified and adjusted. Trades between performance and operations or cost and operations will be key for the overall risk assessment. A previous paper also laid out an example of such a bottom-up analysis based upon experience

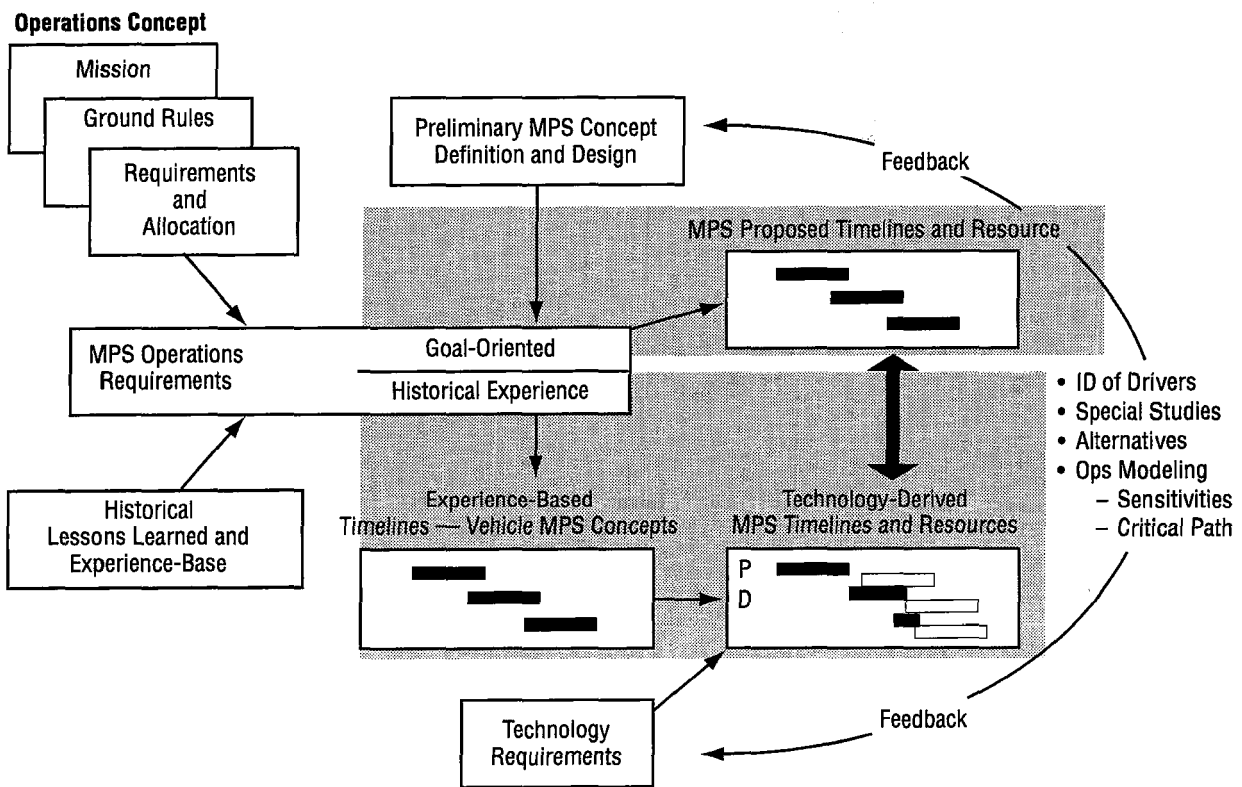

Figure 4. Design-to-operations analysis approach.

data.¹⁴ Yet another paper points out the need to begin with experience-based requirements for this type of bottom-up analysis.¹⁵

Performance requirements as defined in requirements documents are allocated to a lower level and serve as goals for the system designer. One of the purposes of this effort is for the quantification of operability measures to support the comparison of the design against the requirement. Thus, this methodology serves to verify the relationship between design decisions and the fulfillment of design objectives. Furthermore, an appropriate quantification can serve to support the analysis of the current design suitability against a previous design. In this sense, both absolute and relative measures of merit are generated in this modeling approach. However, before a fully detailed model supporting the generation of absolute measures can be generated, a top-down flow can support the relative model comparison of critical use to the designer. A designer involved in a specific area of design can “stub” in the other parts along with their schedule and cost estimates and work in detail in their appropriate design area.

B. Key Concepts and Definitions

Establishing good measurable metrics is key to any functional area analysis methodology. Following is a discussion of key operability definitions and metrics.

Operability—the ability to support required flight rates and schedules and to meet a variety of operational characteristics while minimizing cost and risk. In this definition, operability is not directly

measurable. Common metrics for operability include availability, turnaround time, and dependability. The definition of operability touches upon several key ideas including those of minimizing cost and risk. Risk may be defined as an expression of the likelihood and consequence of an event of interest. Risk involves an attempt to understand the uncertainty in and between the functional areas of the design. This emphasizes the need to model an end-to-end system.

Dependability—probability of achieving a given launch without sliding the schedule on the next launch, given that the system is not in postfailure standdown; if hardware, the ability for the hardware to perform as needed when needed. Often defined in terms of probability of launching within x days of the originally scheduled launch date.

Availability—fraction of time the system is operational rather than in standdown or delay; the probability that a piece of equipment will be capable of performing its mission when needed rather than being unserviceable due to failure, delays, or intentionally or unintentionally removed from service for maintenance or testing; is useful as metric for both hardware and processes; inherent is mean time between failure (MTBF)/(MTBF + mean time to repair (MTTR)); operational is mean time between maintenance (MTBM)/(MTBM + mean down-time (MDT)); also, scheduled time/(scheduled + unscheduled time). This latter definition is more aerospace-oriented given its acknowledgment of few vehicles that require extensive processing due to leading-edge technologies and cryogenic fuel operations. The traditional definition of availability is directed more at the military and commercial aircraft operations where there are large fleets of vehicles and preflight operations are relatively minimal. The process definition of availability is more suitable for this discussion and will be referred to throughout this analysis. Also, in this definition, a system is penalized only for unscheduled maintenance activities that occur on the critical path.

Turnaround Time—a measure of maintenance having to do with time from last recovery to next launch.

Reliability—probability of successfully concluding a mission segment; probability that an item will perform a required function under stated conditions for a stated period of time. Though metrics for reliability are not often included in operations analyses, reliability of the components and systems plays a critical role in determining the operability of the system. The operability study in this paper will include engine reliability measures.

C. Modeling and Uncertainty

The goal of any modeling activity is to accomplish accurate quantification in as realistic an environment as possible. This involves the need for quantifying in the presence of uncertainty. Thus, the model should ultimately be reflective of a probabilistic approach. Uncertainty is not only reflected in the accuracy of the information that exists but also in the availability of information that may lead to an inability to effectively model the system. These are both important pieces of information—manpower can be allocated to obtain the data or to complete the analysis that is required to lessen the uncertainty. The analyses cannot entirely eliminate the uncertainty associated with a process flow but are intended more to understand the extent of the uncertainty. Indeed, if no uncertainty exists in a design, no decisions are necessary.

There are several sources of uncertainty inherent to a process flow, including variation of nominal processing; that is, a process scheduled for 5 hr may actually take 4 hr one time and 6 hr the next. This can be modeled through the selection of an appropriate process time distribution supported by empirical evidence. Other realistic scenarios that will affect the schedule and cost include process failures, equipment failures, and associated unscheduled maintenance activities. Also, delays due to repair times, queuing delays, and waiting for resources can affect the planned schedule. The weather is a major source of delay at time of launch.

D. Process Flow Definition

The types of documents and databases used to generate the process flow for this analysis may be identified. In the case of the world's only RLV, the space shuttle, the documents that describe the requirements and the implementation of the requirements are the Operations and Maintenance Requirements and Specification Documents (OMRSD) and the Operations and Maintenance Instructions (OMI), respectively. Applicable process requirements and flows have been obtained from these sources for the specification of new vehicle operations process flows.

Some attributes of the proposed flows can be obtained from the electronic database system in use by the STS program. The STS Computer-Aided Planning and Scheduling System (CAPSS)¹⁶ contains the nominal schedule and manpower requirements while the Problem Reporting and Corrective Action (PRACA)¹⁷ supplies the information on the problems and off-nominal flows that occur throughout STS processing. Other commercial launch vehicle data such as Titan, Atlas, and Delta operations requirements documents and operations experience databases, if available, can also support this type of analysis. Data requirements include both nominal and off-nominal process times and resource requirements. Mean time to repair along with incidence of repair are typical performance measures derived from such databases.

As stated earlier, the data that supports the allocation process and the data that supports the detailed design evaluation should come from separate sources. In aerospace analyses, this is often not the case, primarily due to the lack of good data. While rough parametrics from one detailed source may feed the allocation process that uses several sources, this kind of analysis should be discouraged. At best, this kind of analysis is redundant and provides little confidence that the conclusions reached are correct. It could lead to inaccurate and misleading conclusions, resulting in a misallocation of design resources.

4. MODELING TOOLS

Several good off-the-shelf software packages fit the need to support operations model development. A process flow model is the model of choice: it allows the analysis of timelines, schedule dependencies, resource requirements, and supports the generation of measures of operability including recurring costs, availability, and dependability. The models used here utilize Microsoft® (MS) Project¹⁸ for deterministic flow analysis and Imagine That![®] Extend[™] software¹⁹ for probabilistic support. The benefit of MS Project[™] as a process modeling tool is its ability to graphically represent detailed tasks in Gantt charts, allocate and track resource levels, and filter project information. Inputs to the model include the task description, resource allocation, task duration, and establishment of task precedence. MS Project[™] is generally all that is required to do the “quick-look” analysis—layout top-level requirements and allocations to subsystems and components. Charts, tables, or reports can be customized to output the level of detail desired by the user. Extend[™] allows us to apply the model in a discrete-event simulation format. It supports ease-of-input (icon-based), provides good report-generation capabilities, is well supported and tailorable with source code available, and provides animation capabilities useful for display and debugging purposes.

5. BASELINE ENGINE OPERATIONS DATA

A. Data Collection

The data collection process was a considerable part of this activity. This section will discuss this process and the data in some detail. Data were collected from a task-by-task point of view: what is required to complete only this task. Often times data are collected from a time-reporting point of view, making it difficult to determine actual task time. Appendices are provided to this document that will contain the data collected. An overview of the SSME data collection in support of the operations modeling approach is shown in figure 5. The analysis consisted of three parts: deterministic model of allocated processing, deterministic model of unscheduled processing, and the probabilistic model. This section discusses the baseline SSME model in the context of the deterministic modeling approach (both scheduled and unscheduled) and the baseline requirements database that is the foundation for all SSME processing activities. A complete presentation of the SSME operations database resides in appendices A (requirements), B (scheduled), C (unscheduled), and D (results).

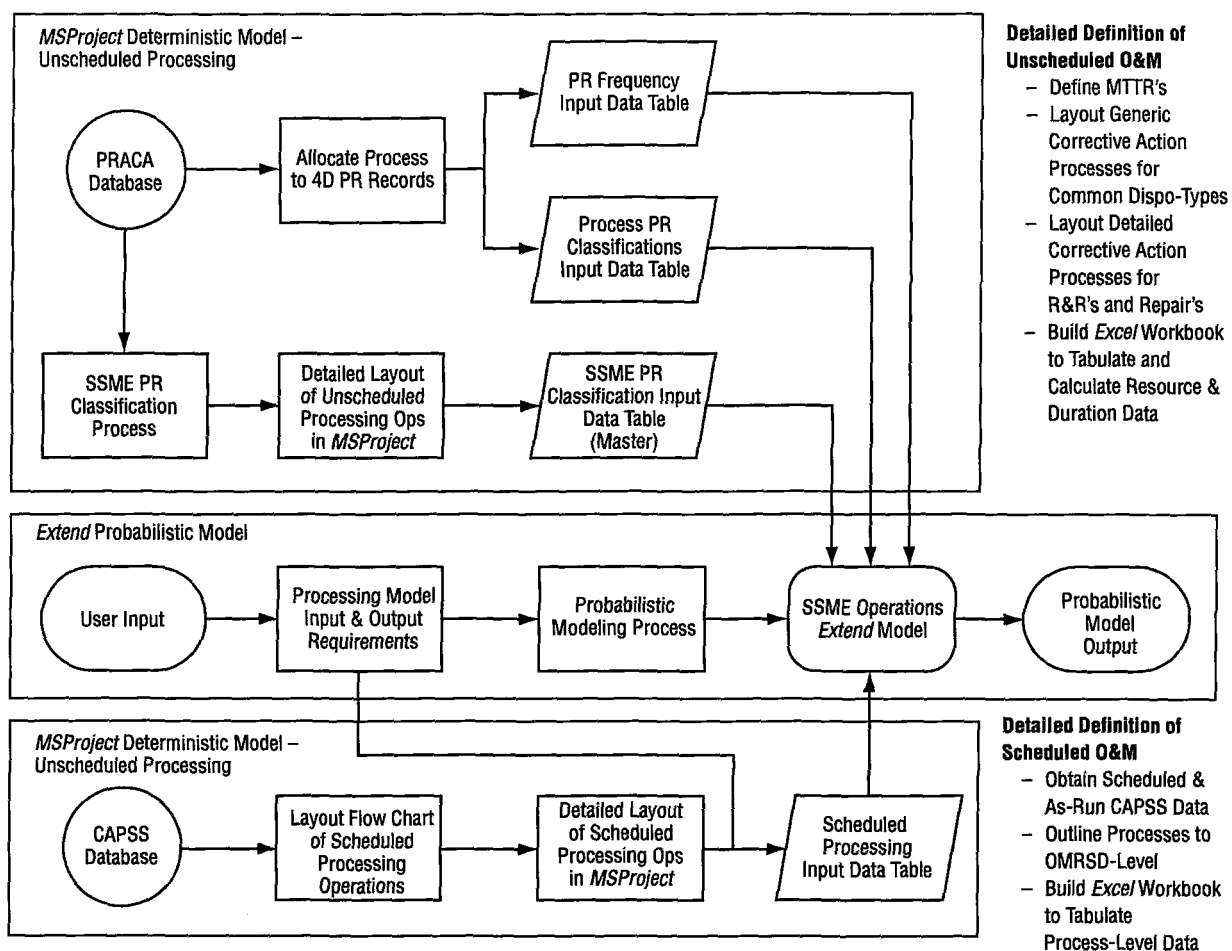

Figure 5. Operations modeling and data collection process.

B. Scheduled Processing

The first step was to define the nominal SSME processing flow. This was accomplished with flowcharts that identified the OMI-level processes and the location/facility in which the process was performed. SSME component life limit issues dictate that engine removal be scheduled each processing flow to allow the SSME's to be processed offline in the orbiter main engine facility (OMEF). Thus, in addition to the every flight requirements defined by OMRSD, nominal processing, for the purposes of the model, included SSME removal in the orbiter processing facility (OPF); SSME processing off-line in the OMEF; high-pressure turbopump removal and installation in the OMEF; and SSME installation in the OPF.

Data collected relative to SSME processing is presented in figures 6–9. Figure 6 identifies the OMI's and the serial and parallel nature of the process flow for the events that occur immediately after flight in the OPF. The engines are then moved to the OMEF. Figure 7 presents the processes and flow for this facility. After processing in the OMEF, the engines are returned to the OPF to be reinstalled on the vehicle. This process is shown in figure 8. After installation, the engine processing steps that occur during the vehicle assembly building (VAB) and pad operations are defined (see fig. 9). The detailed SSME scheduled data that matches the OMI's in figures 6–9 appears in appendix B. These data are quite extensive, breaking out process flow dependencies, clock hour, and manpower requirements by type for each engine process. It should be noted that not all engine processing is fully represented here. Some routine and periodic actions associated with minor OMI's, job cards, or deviation approval requests (DAR's) were excluded in order to present a system that can be represented in a model as an operational system. It is arguable as to whether or not the Shuttle system is a fully operational system. There are too many things that are done that are not necessarily repeatable from a modeling point of view. For example, the exact order of engine processing in the OMEF is subject to visibility, manpower available, and priorities in place at the time of repair, making this aspect difficult to model.

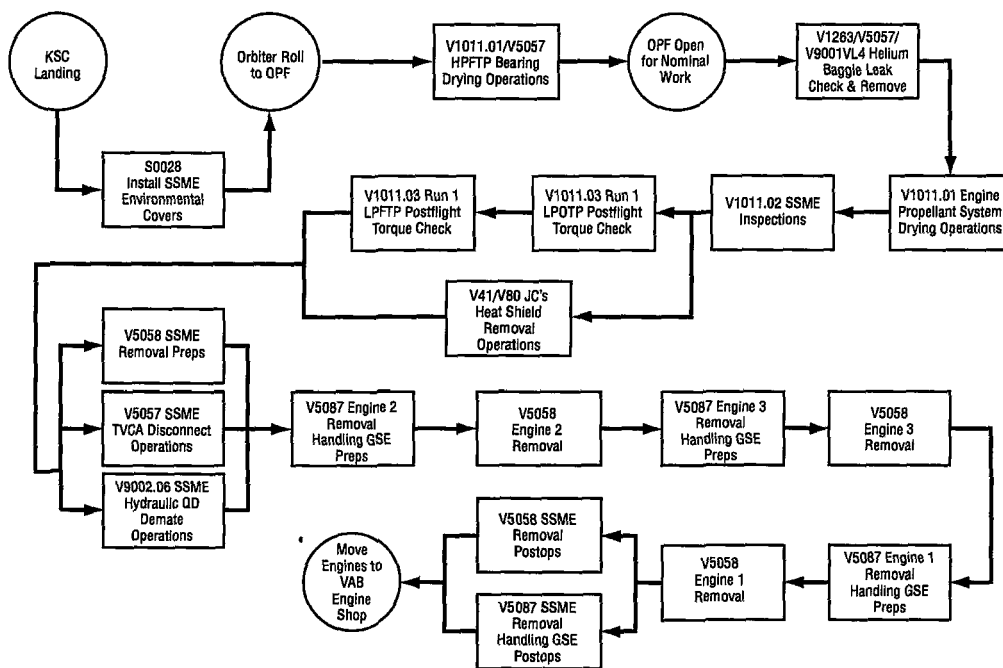

Figure 6. OPF SSME postflight operations.

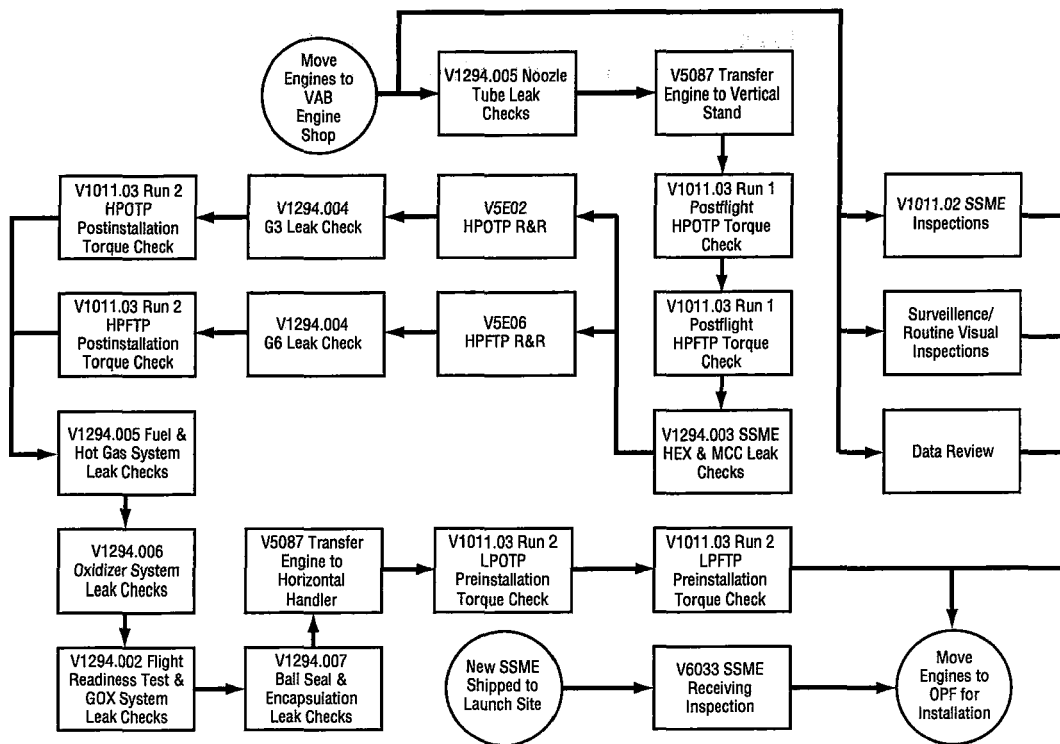

Figure 7. OMEF SSME operations.

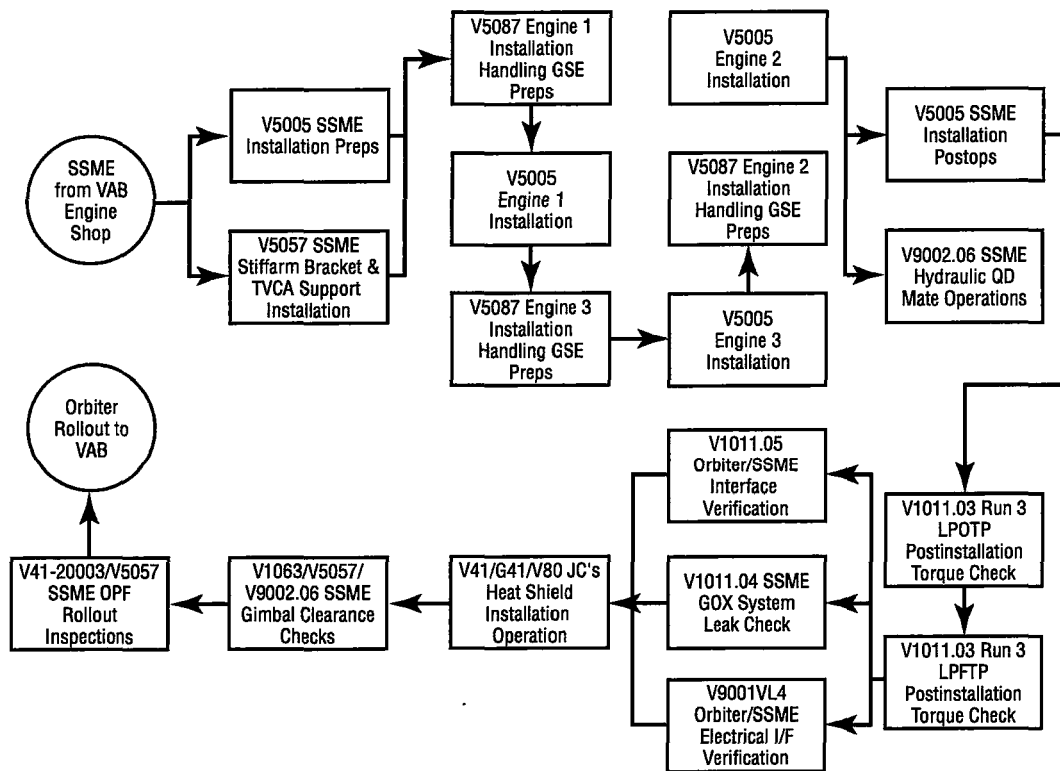

Figure 8. OPF post-SSME installation operations.

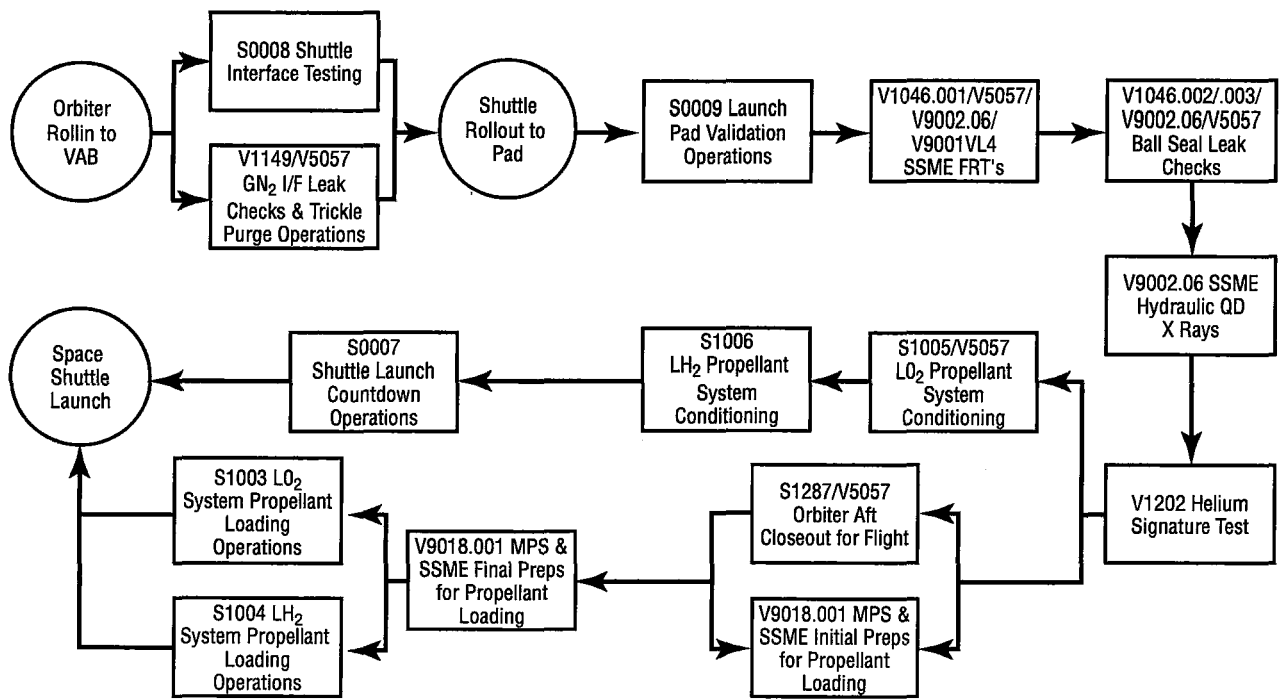

Figure 9. SSME VAB/pad processing operations.

The data that were collected were laid out into Gantt charts and task sheets to a lowest level of detail. Technician, quality control, and engineering resources were identified for each detailed task and the task duration was quantified based upon National Aeronautics and Space Administration's (NASA's) SSME engineering experience at Kennedy Space Center (KSC). Figure 10 exemplifies the level of detail outlined in each deterministic process; in this case, the high-pressure fuel turbopump (HPFTP) removal and replacement. In figure 10, many tasks have been rolled up to subtasks for brevity of presentation.

| ID | Man-hr | Jul 23, '95 | | Jul 30, '95 | | Aug 6, '95 | | Aug 13, '95 | | Aug 20, '95 | | Aug 27, '95 | | |
|----|--------|-------------|---|-------------|---|------------|---|-------------|---|-------------|---|-------------|---|---|
| | | T | W | T | F | S | M | T | W | F | S | M | T | F |
| 1 | 375.75 | | | | | | | | | | | | | |
| 2 | 4 | | | | | | | | | | | | | |
| 4 | 0.25 | | | | | | | | | | | | | |
| 5 | 36 | | | | | | | | | | | | | |
| 17 | 31.25 | | | | | | | | | | | | | |
| 32 | 29 | | | | | | | | | | | | | |
| 37 | 42 | | | | | | | | | | | | | |
| 38 | 6 | | | | | | | | | | | | | |
| 39 | 8 | | | | | | | | | | | | | |
| 40 | 12 | | | | | | | | | | | | | |
| 41 | 16 | | | | | | | | | | | | | |
| 42 | 64.25 | | | | | | | | | | | | | |
| 56 | 24 | | | | | | | | | | | | | |
| 58 | 23 | | | | | | | | | | | | | |
| 59 | 4 | | | | | | | | | | | | | |
| 60 | 2 | | | | | | | | | | | | | |
| 61 | 12 | | | | | | | | | | | | | |
| 62 | 1 | | | | | | | | | | | | | |
| 63 | 4 | | | | | | | | | | | | | |
| 64 | 24 | | | | | | | | | | | | | |

Figure 10. Example of detailed model—HPFTP removal and replace.

Although serial and parallel relationships were established between the detailed tasks and OMI processes within the Gantt charts, it is difficult to accurately predict overall OMI durations or end-to-end vehicle or SSME subsystem processing times. Reasons for this include:

1. Lack of all downtime data including logistic delay time, administrative delay time, and maintenance delays downtime.
2. Interdependence between SSME and other subsystems was not modeled.
3. Other vehicle subsystems not modeled.

While accurate predictions of SSME processing are not always possible with this data, it is appropriate for future launch vehicle engine analysis since these kinds of attributes need not be modeled. Of interest for a future system analysis is the definition of an operational system. It is not desirable to model all the artifacts of the STS processing system as appropriate to the new system. While downtimes will occur for a future system as well, it is premature, without detail, to model those. Of course, a complete vehicle model should represent the engine-vehicle interface and other subsystem operations fully.

The baseline SSME model will provide insight into the actual workload, required subtasks, and the overall processing flow. This actual manhour prediction method differs from top-down manhour estimates in that manhours of downtime are not accounted for. The utility of determining manhours in this fashion is that labor-intensive processing activities are readily identified whereas the actual impact of each processing activity can be masked by downtimes in the top-down approach.

C. Unscheduled Processing

An analysis of SSME unscheduled maintenance operations was performed using the PRACA database. Unscheduled maintenance information from the PRACA database was obtained for 30 STS flights between 1989 and 1994. During this period there were 3,785 problem reports (PR's) that were processed. This is engine PR's only, thus, ground support equipment (GSE), facility, and spares PR's relative to the engine were not included. The PR's were sorted and grouped by component, malfunction, and disposition code. This allowed the filtering of this database into 123 PR classes representing 84 SSME processing flows. PR's were further classified into six types based upon processing action taken. The six types, the 123 classes, and the number of applicable PR's are presented in table 1.

Table 1. SSME PR classification summary.

| PP Classification Type | Number of Classes | Number of PR's |
|------------------------|-------------------|----------------|
| Remove and Replace | 70 | 795 |
| MR Repair | 13 | 79 |
| Repair | 19 | 1,121 |
| MR Accept | 6 | 156 |
| Accept | 7 | 137 |
| Waiver/Exception | 8 | 82 |

This filtering processed 2,370 PR's. PR's that were eliminated from the database during this classification and filtering process included PR's from incomplete processing flows and PR records with insufficient data to allow it to be classified.

Each PR will fall into one of the six classification types. These types were categorized based upon the disposition code in the PRACA database and limited to the detail provided therein. These represent the most common actions required for each PR at the lowest level of detail possible. Each classification type was outlined to identify the basic tasks and resources associated with setup, performance, diagnostics, administration, review, and delay times. Figure 11 presents an MS Project™ view of the base remove and replace (R&R) classification type. In addition, an initial attempt at quantifying the resources required was conducted. Note that these are initial estimates until more accurate data can be made available and collected. The actual "hands-on" R&R time is represented by a milestone on line 4. This would be replaced in the model by the actual component R&R timeline.

The classes identify the number of different PR's that fall into each PR type. These are usually associated with components or hardware. In the case of an R&R PR type, the 70 different classes are mostly associated with different hardware or components that require R&R. However, this is not necessarily the case for the other PR types. For example, a large number of PR's were generated due to contamination and corrosion on unidentified hardware. Because the detail in the database did not allow us to associate the corrosion problems with the hardware or component, the contamination and corrosion PR's were separated into five different PR classification types based upon the nature of the disposition (repair, material review (MR) repair, accept, MR accept, or waiver/exception). The five other PR classifications as well as the standard R&R operations by component appear in detail in appendix C.

| ID | Duration hr | Man-hr | y | Wednesday | | | Thursday | | | Friday | | | Saturday | | | Sunday | | |
|----|----------------|--------|---|-----------|----|---|----------|----|---|--------|----|---|----------|----|---|--------|----|---|
| | | | | 4 | 12 | 8 | 4 | 12 | 8 | 4 | 12 | 8 | 4 | 12 | 8 | 4 | 12 | 8 |
| 1 | 8.97 | 0.5 | | | | | | | | | | | | | | | | |
| 2 | 0.25 | 0.25 | | | | | | | | | | | | | | | | |
| 3 | 0.25 | 0.25 | | | | | | | | | | | | | | | | |
| 4 | 0 | 0 | | | | | | | | | | | | | | | | |
| 5 | 2 | 2 | | | | | | | | | | | | | | | | |
| 6 | 1 | 1 | | | | | | | | | | | | | | | | |
| 7 | 1 | 1 | | | | | | | | | | | | | | | | |
| 8 | 8.48 | 6.5 | | | | | | | | | | | | | | | | |
| 9 | 0.5 | 0.5 | | | | | | | | | | | | | | | | |
| 10 | 2 | 2 | | | | | | | | | | | | | | | | |
| 11 | 4 | 4 | | | | | | | | | | | | | | | | |
| 12 | 1.5 | 0 | | | | | | | | | | | | | | | | |
| 13 | 1 | 0 | | | | | | | | | | | | | | | | |
| 14 | 0.5 | 0 | | | | | | | | | | | | | | | | |

Figure 11. SSME base R&R.

This PRACA database is limited in that it does not provide resource or task duration information for unscheduled corrective actions. However, PRACA does provide data to determine the frequencies of PR's as well as information to determine what malfunctioned and how the PR was dispositioned. Corrective action processes, including task descriptions, durations, and resource assignments, were defined and quantified by SSME engineering in the same manner as the scheduled processes for each PR classification.

A few low-level processes were set to a standard time for simplicity sake. For example, QC response time was set to one standard value, when in actuality, this value is more dynamic. The unscheduled data as it applies to the six PR classifications appears in appendix C and a summary of the results from the data (relative to SSME) in appendix D.

D. Baseline Requirements Database

Figure 12 describes how the data collected are being applied to the reusable engine analysis. The applicable requirements identified by the STS OMRSD's are mapped to major corresponding STS OMI's (see appendix A). An iterative review process identifies, task by task, the appropriate processing for the future engine operations. Future reusable engine-specific operations are added; SSME operations artifacts are removed; changes to processing facilities and support equipment is identified; and any dependency, timeline, or resource requirements are also specified. This leads to a traceable proposed operations flow prediction and resource estimate. Table 2 displays a sample of the OMRSD/OMI database with comments as to the applicability of the requirements to the reusable vehicle engine.

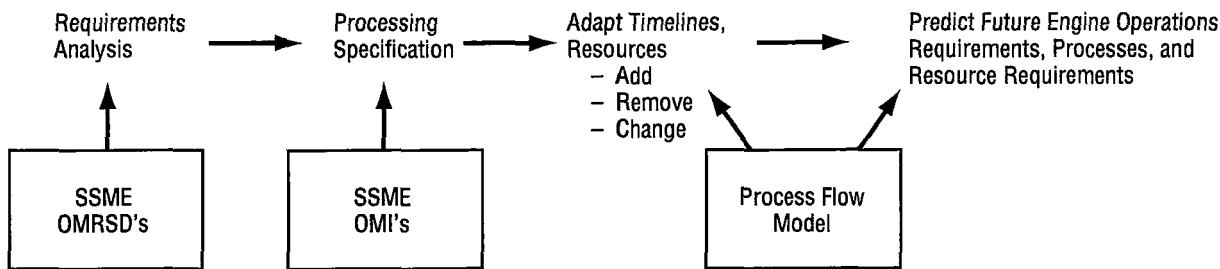

Figure 12. Requirements to process definition.

Table 2. OMRSD/OMI database with requirements rationale.

| OMRSD Number | New Engine Use | OMRSD Description (V41 File III Dated 9/15/95) | OPF OMI's | Engine Shop OMI's | VAB/PAD OMI's | OMRSD Rationale/Root Causes |
|--------------|----------------|---|-----------------|-------------------|------------------|--|
| V41BL0.050 | n | SSME Weld 22 & 24 Lk Ck | V1011.05 Seq 07 | V1294.007 Seq 04 | V1046.003 Seq 07 | Due to poor processing, HPOTP balance cavity standoff welds are leak checked – No leaks ever verified, but lack of weld penetration up to 90% has been found on these welds. Standoffs have been suspected of leaking and caused return to Canoga. |
| V41BL0.060-A | n | E1 HPOTP Plug Weld Lk Ck | V1011.05 Seq 09 | V1294.004 Seq 04 | V1046.004 Seq 04 | Plug weld leak occurred on a unit – Concern over these welds leaking either Gox/Helium/Hot gas into boat tail – therefore all external plug welds on the housing are checked |
| V41AX0.020-A | y | E1 LO ₂ Feed (Joint 01) I/F Lk Ck | V1011.05 Seq 07 | | V1046.003 Seq 05 | Ensure joint integrity of LPOTP to pump inlet ducting after engine is installed |
| V41AX0.020-B | y | E1 LH ₂ Feed (Joint F1) I/F Lk Ck | V1011.05 Seq 05 | | V1046.002 Seq 04 | Verify pump inlet joint integrity after installing the LPFTP |
| V41AX0.020-C | y | E1 GH ₂ Press (Joint F9.3) I/F LK CK | V1011.05 Seq 09 | | V1046.004 Seq 04 | Joint integrity Post Engine Installation |
| V41BL0.033 | y | SSME Encapsulation Oxid Sys ISO Test | | V1294.007 Seq 04 | | System leak integrity check for launch – Mat. 1 or Weld Thru-Crack: Seal not Sealed -> Crit. 1 |
| V41BL0.034 | y | SSME Encapsulation Hot Gas Sys ISO Test | | V1294.007 Seq 04 | | System leak integrity check for launch – Mat. 1 or Weld Thru-Crack: Seal not Sealed -> Crit. 1 |
| V41BP0.010-A | n | E1 GO ₂ /GCV Ext Lk Ck & Orifice Verif | V1011.04 Seq 07 | V1294.002 Seq 17 | V1046.005 Seq 05 | Establishes leak test of all gaseous oxygen system joints from the AFV to the orbiter interface on an each flight basis |
| V41AQ0.010-A | y | E1 Sensor Checkout | V1011.06 Seq 02 | V1294.002 Seq 08 | V1046.001 Seq 04 | Planned Preflight Checkout |

From table 2, development or definition of an reusable engine operations concept is traced to the SSME experience. This database was developed to link propulsion system concepts and technology candidates to the SSME operations experience. The backbone of the SSME experience is the OMRSD database. Deterministic model data are linked to the OMRSD database for each requirement. Additionally, root causes and/or OMRSD rationales are provided that allow for rapid determination of those OMRSD's affected by technology improvements or hardware configuration changes. From table 2, first row, a requirement was established for SSME weld and leak checks on the high-pressure oxidizer turbopump (HPOTP). The root cause of this requirement is a concern for weld integrity. The OMRSD number, three applicable OMI's, and an applicability column for the new launch vehicle engine are provided. It is interesting to note that this requirement was generated well after the design of the SSME and its processing when potential problems with welds were identified. This specification of postdesign requirements is likely to occur in a new launch vehicle engine as well.

6. MODEL DEVELOPMENT AND RESULTS

The scope of the analysis for this document is a future launch vehicle ground operations analysis that includes shuttle-based uncertainties associated with scheduled and unscheduled maintenance. The emphasis is on propulsion systems and the specific topic is the engine which will be modeled in order to be responsive to the vehicle requirements. Of course, the engine processing is only one part of the overall vehicle processing. Interactions of the engine processing and other subsystems must be taken into account to get a proper estimate of vehicle and even engine flows. The results of this analysis reflect the impact of unscheduled processing on turnaround time in a deterministic model and on launch availability and dependability in a probabilistic model. The attributes of the maintenance activities will be limited to those supported by analysis of the STS PRACA, CAPSS, and Marshall Space Flight Center (MSFC) Propulsion Laboratory operations databases.

Given ground rules and assumptions, key processes were laid out for a fully reusable future launch vehicle engine concept. To avoid proprietary data considerations and to simplify the presentation, a rough-cut engine design is assumed for this analysis. It is essentially SSME-like;²⁰ a pump-fed LO₂/LH₂ high-thrust engine with pneumatic and EMA valve control (no hydraulics) and health monitoring capabilities. The proposed launch vehicle uses three such engines with engine processing conducted in parallel. From this, a logic model associated with the flow of ground processing is developed. A 40-hr, goal-oriented engine ground flow serves as a baseline to the defined flows. Effectively, this 40-hr timeline was provided as a requirement (baseline allocation) for this model activity. Figure 13 shows the engine flows and the success-oriented timelines by processing facility. Three facilities were assumed after landing—a single processing facility with five bays and two launch pads. From figure 13, engine ground operations processes include drying; access; visual inspections; leak checks; and closeout on each engine in the processing facility and purge; flight readiness test; and launch preparation on the engine set on the pad. An unscheduled maintenance timeline is supported in parallel with the scheduled timeline. Key assumptions and ground rules to this development were 30 flights per year, a five-vehicle fleet, and 7-day missions. Others included minimal and automated operations, separate payload processing, depot maintenance every 20 missions, and automated health monitoring. Manpower assumptions included two shifts per day, 5 days per week for processing facility operations and three shifts per day, 7 days per week for all other processing.

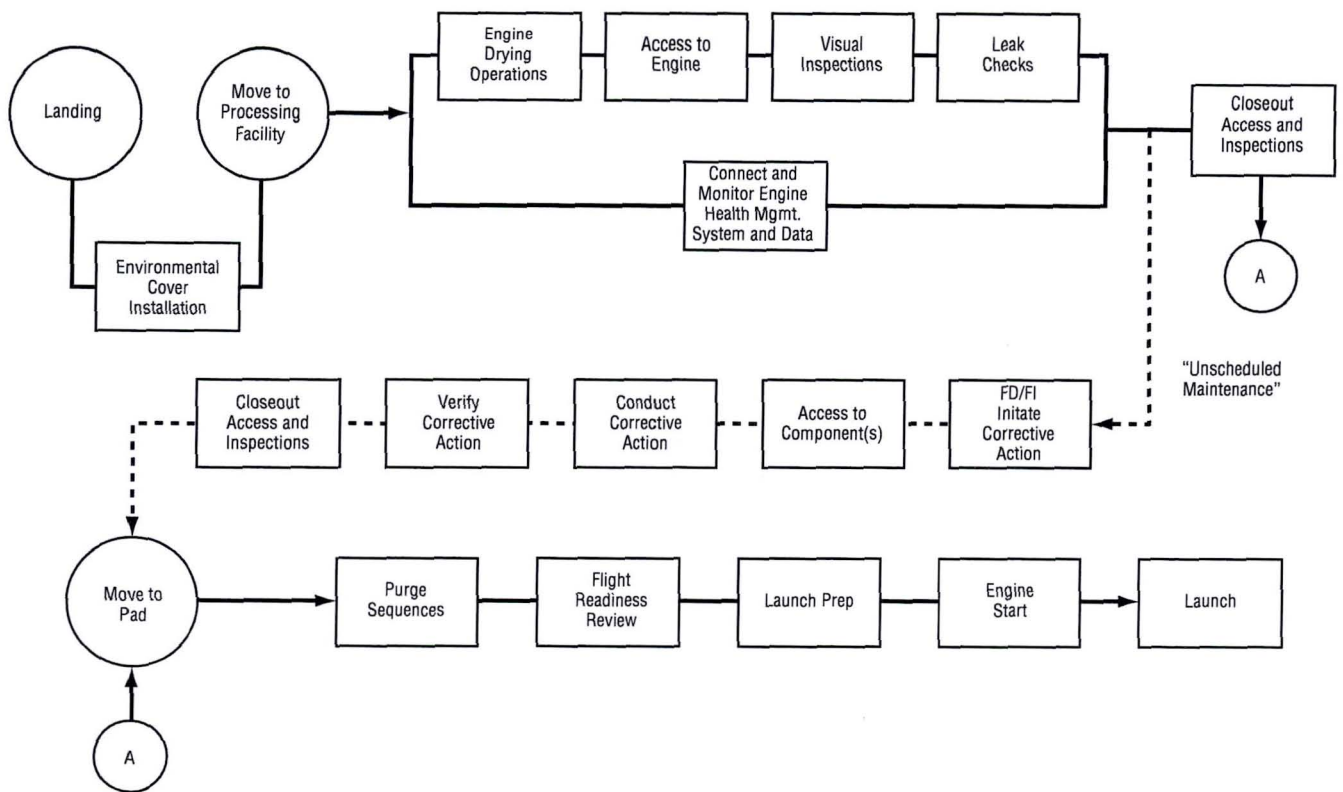

Figure 13. Engine operations processing.

A. Deterministic Model

An MS Project™ model was developed to reflect the processing requirements (top-level and allocated) of the engine system. From the flows defined in figure 13, processing timelines and resources required were input into the MS Project™ scheduler. The tasks were defined to three levels as subprojects. Figure 14 presents the top level to the level of detail at one of the lowest level processes defined here—that of the engine drying operation. Total duration and manpower requirements in the subprocesses of figure 14 can be rolled up to the top level in a very direct fashion. This is the allocated appropriate times and requirements for those systems within the constraint of the overall requirement, which was provided as a top-level requirement; in this case, 40-hr total for the engine. Thus, the times and resources reflect a relative allocation to the subsystems: it remains to be seen, for example, whether or not a gaseous oxygen (gox) system leak check will take the 1 hr allocated, but the 1 hr allocated to this system is consistent with the time allocated for the fuel system leak checks (1 hr). Again, this model serves as the goal-oriented model useful for allocation and comparison with the detailed engineering estimates. In the approach identified in figure 4, this is the top half—the goal-oriented model.

to deal with this. Even if dependability is defined as launch within 2 days of scheduled launch, such variation is manageable—an extra 20-hr duration is still within 2 days, if there are multiple shifts per day.

Much more significant is the variation in unscheduled processing. In the baseline case, the unscheduled processing is designed to be in parallel to scheduled processing. Even this can tolerate some additional unscheduled processing before impacting overall flow. However, this assumes sufficient manpower to handle problems in parallel and that problems will occur in parallel. Such an assumption is not credible. For example, if four to six engineers are allocated to handle processing, the extra unscheduled activities cannot be conducted entirely in parallel without a schedule slip—there simply is not enough manpower. Also, if problems occur late in launch to critical path operations, there is a serial effect—problems must be resolved before any more normal launch processing can be supported. Built-in holds can also mitigate the problem of unscheduled processes, especially early in the flow. Late processes, such as pad processes, must attempt to minimize all unscheduled activity.

In this deterministic model, the unscheduled maintenance activities were added to reflect these issues. A notion of unscheduled maintenance considerations should be incorporated into the requirements allocation for accuracy sake. Table 3 lays out the SSME-based experience and the impact per OMI for this analysis. For example, from the historical SSME record, twice as much time is spent on unscheduled maintenance during the visual inspection OMI (V1011.02) than for scheduled maintenance. Table 4 presents the results of this analysis including a run with the unscheduled maintenance data. The first column of the table presents the baseline results—both clock hours and personnel manhour requirements. The second column adds in unscheduled timelines based on STS SSME experience. If the unscheduled activities are assumed to be done in parallel, the overall impact to the timeline is small. That which is not on the critical path has little impact, while adding unscheduled maintenance activities to critical path operations is realistic and has a significant impact. The impact to the overall dependability and availability metrics can also be considerable as will be seen in the next section. Keep in mind that many of the SSME OMI's have already been excluded and that the baseline processing time is allocated. The result in table 4 is more of interest in a relative sense—the duration and manhour requirements practically doubled with experience-based unscheduled maintenance included in the analysis (from 40- to 70-hr duration, 348 to 615.6 man-hour total). Further and more detailed analysis is clearly necessary.

Table 3. SSME unscheduled maintenance experience.

| Task Description | OMI Number | % Additional Unscheduled Processing* |
|-----------------------|-------------------|--------------------------------------|
| Envir. Cover Install | S0028 | 10 |
| Engine Drying | V1011.01 | 10 |
| Assess to Engine | V5058/V5057/V5087 | 10 |
| Visual Inspections | V1011.02 | 200 |
| Leak Checks | V1294.xx | 100 |
| Closeout | S1287/V5057 | 50 |
| Purge Sequences | V9018.001 | 10 |
| Flight Readiness Test | V1046/V5057/V9002 | 75 |
| Launch Prep & Start | S0007 | 10 |

* Per SSME Experience, 1989–1994

Table 4. Goal-oriented engine operations timelines.

| Task Name | 40-Hr Goal-Oriented Baseline | | 40-Hr Baseline With Unscheduled Maint. Included (SSME-Based)* | |
|----------------------------------|------------------------------|--------|---|--------|
| | Duration, hr | Man-hr | Duration, hr | Man-hr |
| Processing Assessment | 40 | 348 | 70 | 615.6 |
| • Landing Operations | 2 | 6 | 2.2 | 6.6 |
| • Processing Facility Operations | 30 | 310 | 59 | 573.8 |
| – Engine Drying | 3 | 20 | 3.3 | 22 |
| – Engine Access | 2 | 8 | 2.2 | 8.8 |
| – Inspections | 8 | 32 | 24 | 96 |
| – Leak Checks | 8 | 32 | 16 | 64 |
| – HM Monitor | [20] | 40 | [22] | 44 |
| – <i>Unscheduled Allocation</i> | [24] | 144 | [48] | 288 |
| – Closeout | 9 | 34 | 13.5 | 51 |
| • Pad Operations | 8 | 32 | 8.8 | 35.2 |

* 1989–1994
 [] Not on critical path

This concludes the discussion of the goal-oriented model and analysis results. Turnaround time and resource requirements have served as primary metrics to this point. Operability metrics such as availability and dependability are more appropriate to a detailed probabilistic model. The probabilistic model and its results are the topics of the next section.

B. Probabilistic Model

1. Overview

The following analysis serves to illustrate the probabilistic approach—modeling to include uncertainty in the analysis. As in the earlier deterministic analysis, the scope of this analysis is a future engine operations analysis that includes uncertainties associated with unscheduled and scheduled maintenance. Consistent with the overall process, requirements were generated from the STS requirements list applicable to this new engine system. Engine design data were assumed for this application and use no proprietary information. Identical to the engine used for the deterministic model analysis, the future engine system is a pump-fed LH₂/LO₂ system with EMA and pneumatic valve actuation (no hydraulics), and active health monitoring. A three-engine vehicle is also assumed for this analysis. The emphasis is on the engine processing, with the vehicle operations requirements allocated out to the engine level. The interest here is on the impact of engine scheduled and unscheduled processing on engine dependability and availability. The data used as baseline for this analysis are those of the shuttle engine system.

2. Operations Concept

Given ground rules and assumptions, key processes were laid out for a fully reusable future launch vehicle concept. These are the same as those laid out for the deterministic model of the previous section with detail of depot maintenance now included. A logic model associated with the flow of ground processing was developed and figure 13 shows these engine flows by processing facility. The assumptions and ground rules are the same as in the deterministic case except for the following. Depot maintenance consists of engine removal and replacement, more detailed tests and checkout, and generally takes 30 days. Automated health monitoring is assumed, although this would only affect diagnostic and isolation time for unscheduled activities. Three vehicles may be on orbit at one time and two vehicles can be in depot maintenance at one time. The resources have been designed for minimal bottlenecks. This includes manpower, which is assumed available when and where needed, given shifting constraints. The block flows reflect periodic and depot maintenance operations that utilize parallelism and adequate manpower. For example, the engine processing for the three-engine vehicle is done in parallel. This provides a much shorter process clock time; however, manpower must be calculated accordingly. Typical engine operations include engine drying, inspection, and leak checks for the routine turnaround operations and engine removal and replacement for the depot maintenance operations. This discrete-event logic flow will be represented in a simulation model to be developed as part of this analysis. This flow will be modeled over a 20-yr lifetime. Results will be presented from a set of Monte Carlo runs.

3. Model Development

A computer program that supports discrete-event simulation on a personal computer was used for this analysis. This package, Extend™, allows icon-based time and event modeling. The package is available commercially and provides ease of use in building models and in specifying output parameters. It supports probabilistic modeling and hierarchical levels of detail for complex systems.

The logic of the operations processes timelines was incorporated into the Extend™ modeling language and runs were made to analyze the parameters of interest. All simulations for this analysis were performed on a PowerMac 7600. This operations model was developed fully from Extend™ library building blocks. Figure 15 presents the top level of the ground operations modeled. The model is reflected in a hierarchy, the lowest level of detail for the processing facility, as presented earlier in figure 13. From figure 15, the processing facility with five bays (three for nominal, two for depot); the two pads; the runway; and vehicle tows are evident. The five vehicles come in as scheduled in the new vehicle block to the appropriate routine processing in the upper three bays or the depot processing in the lower two bays.

This probabilistic detailed model serves as an experience-based model outlined in the approach of figure 4 (lower half of schematic). Results from it are intended to be compared against the goal-oriented model results.

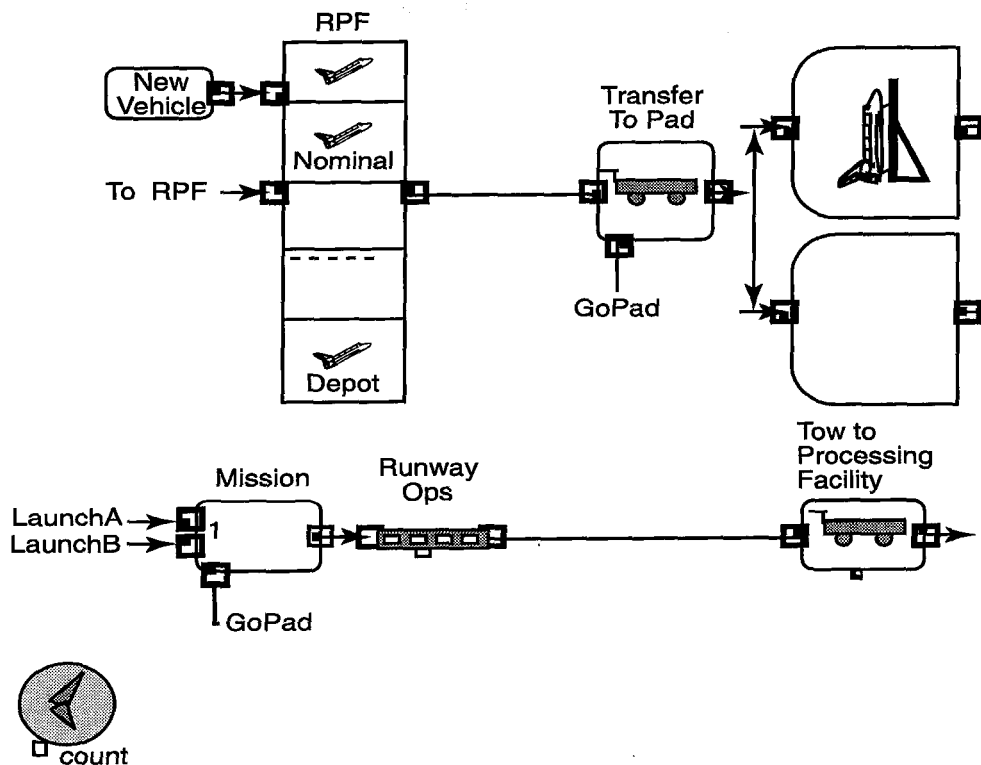

Figure 15. Extend reusable engine operations model.

4. Data and Metrics for Analysis

For this analysis, the data as described in section 5 were used for model data support. As stated earlier, this database keeps track of the ground operations unscheduled and scheduled maintenance activities for SSME processing. Distributions around the scheduled and unscheduled maintenance processing are modeled with a triangular distribution,²² selected due to its “conservative” nature. Evidence exists that for process simulation the lognormal distribution may be the most appropriate.^{23,24} Such evidence also exists relative to some aerospace applications;^{25,26} but without actual operational data to support this, the triangular distribution has been chosen. The triangular distribution requires a minimum, a maximum, and a mode. For this application the mode is the selected STS value, the minimum is 5 percent less than the mode, and the maximum 10 percent greater than the mode. These values were accepted during the data collection process by the system engineers as generally representative of actual shuttle engine task processing uncertainty. Extend™ supports many distribution types including the definition of a user input type. If desired, distribution types and parameters can be easily varied as part of a sensitivity study.

Metrics for this analysis include measures of merit for availability and dependability. The measure of availability deemed most suitable for this analysis is the one described earlier in the metrics discussion for process availability—nominal processing divided by total processing which includes nominal and off-nominal processing times. Off-nominal processing time includes unscheduled maintenance, queuing delays, and standdown times due to failures. This is a measure deemed more suitable to spacecraft processing systems due to the processing-intensive nature of cryogenic-fueled rocket systems and small fleet sizes.

The dependability measure is a characterization of the on-time launches. This is reflected in a probability that all vehicles are launched on time (from an engine processing point of view), measured as within 2 days of original launch date.

Requirements for engine processing were collected via the STS requirements list. There are three engines per vehicle with an engine out at liftoff capability. The only unique engine operation process proposed and not covered by STS operations is an engine-to-engine mate process which slightly expands the timelines for inspection and engine R&R.

The reliability of the engine will be modeled as will any associated standdown time due to failures to illustrate the impact of reliability on operability. Standdown time in this case is 4 mo and is a required result of any vehicle failure. A range of reliability values and their impact to the overall processing system will be presented. Appendix E presents the engine out reliability analysis and its impact on engine set reliability that is used in this analysis.

5. Results

The simulation time for the model was set to 20 yr and run in a Monte Carlo environment. A relatively evenly spaced flight manifest spanning this duration served as input for the model. Vehicle flights were staggered so that, at most, three flights were on orbit and, at most, two vehicles (engine sets) would require depot maintenance at any given time.

It was apparent from back of the envelope analysis that the use of the complete shuttle engine database would present a processing timeline that was a factor of 10 over the allocated requirement. Availability for such a system is approximately 70 percent and dependability is very low unless processing start dates were backed up to allow for this extra processing. If enough time is allowed up front, any system can be made technically dependable. Implicit in the measure of dependability is an acceptable and minimal turnaround time. This is a problem in using the STS system. The inherent philosophy and conservatism associated with this manned system leads to intense processing requirements due to extensive checking and double-checking. Using shuttle experience data results in a vehicle that is only capable of five flights per year at the outset. The required processing times preclude any more. This also assumes processing manpower available to process all vehicles in parallel to support a maximum of 25 flights per year. This would result in a prohibitively expensive system. Thus, for this analysis, a decision was made to just use the “active” process conducted on the shuttle engines for this model. This excludes all vehicle setup and access time (except that explicitly allowed); all GSE setup; test setup; and of course, shuttle-specific operations. Clearly as important to the processing requirements for the future engine system is the philosophy of operation. Philosophy changes create the most significant process changes; of course, it remains to be seen whether these changes can be maintained when the actual system is in operation.

Given the above ground rule, a baseline case with no off-nominal (unscheduled maintenance) time was first established. The results for the probabilistic analysis for the operability parameters are presented in table 5. This turnaround baseline required, on average, 109.6 hr per flight. When adjusting for manpower shifting, this translates into just over a 6-day turnaround. The dependability measure assumes launch on time if launch occurs within 2 days of the original scheduled data. This system is appropriately rated at 100 percent for both availability and dependability. Without unscheduled processing time, the only

uncertainty in this system is in normal processing and this is not enough to affect on-time launch. It is interesting to note that the original goal for the turnaround of the engine system as presented in the deterministic model was 40 hr. Even with extensive and optimistic ground rules, the projected turnaround is over twice that without considering any unscheduled processing. Extra manpower may make up some of the difference but this also raises the cost to the processing system. Clearly, the original goal must be adjusted to be more realistic.

Table 5. Results of probabilistic analysis.

| Case | Availability (%) | Dependability (%) |
|--|------------------|----------------------------|
| Full-up STS Active Processes Only (No Unscheduled) | 70 | Low (Assumption Dependent) |
| Active With STS Unscheduled | 100 | 100 |
| Active With 25% of STS Unscheduled | 82 | 0 |
| | 94 | 78 |

When the shuttle-based, off-nominal times were incorporated into the model as reflected in table 5, the turnaround increased to an average of 171.5 hr which translates into a 12-day turnaround (a weekend added since processing facility time goes past 1 wk). With only 6 days allowed for turnaround time with a 2-day buffer, the dependability of this system is zero. Availability of this system is at 82 percent.

It is reasonable to assume that improvements in unscheduled processing and hardware will result in something significantly better than for the shuttle. From table 5, the case where 25 percent of the shuttle unscheduled processing is assumed, the dependability is at 78 percent and the availability at 94 percent. Improvement to 10 percent of shuttle unscheduled processing improves the measures to 100 percent and 96 percent, respectively. The general relationships of process time, dependability, and availability for this system are presented in figure 16. A typical requirement (95 percent) for availability and dependability is also included in this figure. Availability varies from 100 to 82 percent, based upon the amount of unscheduled processing time. Dependability displays a unique shape—almost a step function. Only between 23 and 27 percent of STS unscheduled process time is any variation evident. This range is reflective of the variation in nominal and off-nominal processing. As such, dependability is a very sensitive measure. First, it is sensitive to the time allowed for processing—in this case, 6 days. Also, it is sensitive to the buffer amount; amount of uncertainty; and staffing schedules. Dependability can be improved by an early processing start or by the use of timing control mechanisms such as built-in holds. It is interesting to note that, traditionally, engine processing delays are not key to the vehicle launch delays and dependability. Weather is the predominant cause of vehicle launch delays.

Other typical results from a discrete event simulation model include resource estimates of interest such as facility utilization rates, manpower usage, and queuing delays. In order to identify areas of improvement for operations, a Monte Carlo analysis of each process was performed by reducing the unscheduled maintenance from the shuttle-based percentage to a 10-percent target. Total manhours, cost per flow, and launch delay time per flight were used to provide a quantifiable measure of improvement. The results from these analyses are shown in table 7 for each engine task in the current processing flow.

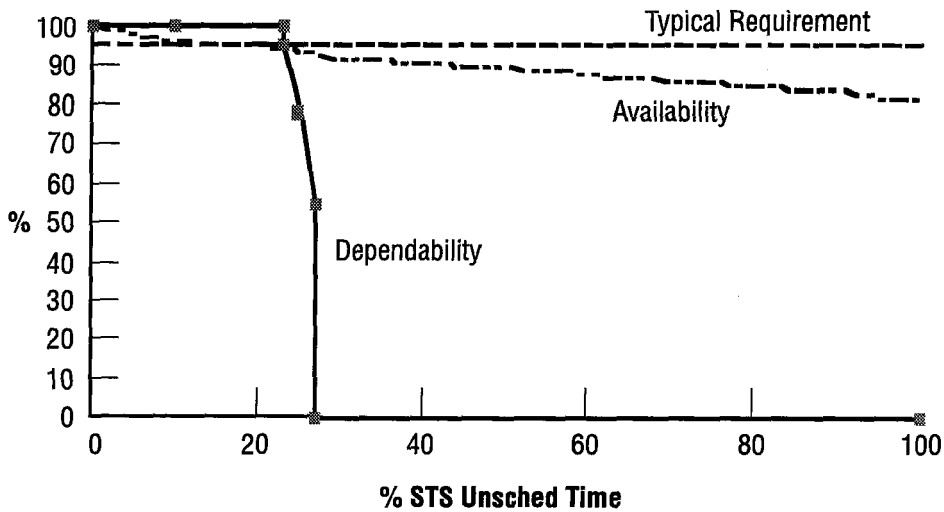

Figure 16. Operability measures by process time.

6. Effect of Uncertainty

Table 6 presents the impact of the incorporation of uncertainty in the model. As discussed earlier, the purpose of modeling this uncertainty is to provide for a more realistic model. The hours presented are the total for the system over the 20-yr period (600 flights). The uncertainty in this case has little impact on the availability measure, given that availability is a ratio of values, both changing in similar fashion. In this case, the impact is small since the processes modeled have relatively low uncertainty in both scheduled and unscheduled activities. Also, consistent with earlier conclusions, the dependability measure shows a high sensitivity to the amount of uncertainty. Indeed the use of the maximum amount of uncertainty for the case here drops this value to zero. Upon further analysis, this was determined to be an effect of processing facility operation being extended past 5 days, resulting in the addition of a weekend to the processing time. These two events were enough to push the launch time past the 2-day buffer allowed. The dependability value is controllable to a large extent through the use of different ground rules, built-in holds, earlier start dates, or additional manpower.

Table 6. Probabilistic model uncertainty impact.

| Case | Sched Hr | Unsched Hr | Avail (%) | Dep (%) |
|--------------------------------|----------|------------|-----------|---------|
| 25% of STS Unscheduled Mode | 166,460 | 11,482 | 93.5 | 78 |
| 25% — Min | 162,348 | 10,764 | 93.8 | 95 |
| 25% — Max | 171,552 | 12,402 | 93.2 | 0 |

7. Reliability Impacts

When a measure of reliability is added to the model, impacts to operability are apparent. In this case, reliability is measured relative to catastrophic failure of the engine, and catastrophic failure of any engine leads to failure of the vehicle. The ground rule at the outset was that the system went into standdown of 4 mo after a failure in order to diagnose, isolate, redesign, or mitigate the problem causing the failure. The reliability impact of lost launches is presented in figure 17. Besides the failures, launches for the next

4 mo are delayed. Out of the 600 launches (rescheduled now over a longer period of time), 126 were canceled given an engine reliability of 0.95. For a reliability of 0.999, the number of lost launches is 1.8. Clearly, a reliability value much lower than 0.999 would be unacceptable to a launch system such as this one. Certain vehicle characteristics mitigate these failures (holddown, engine out), but the engines must be very robust for consistent acceptable operability scores. The relationship of reliability, dependability, and availability of this system as generated from the Extend™ model runs is presented in figure 18. The reliability estimates used for this analysis were as derived in the analysis of table 21 for the engine out at liftoff and catastrophic failure probability of 0.1 case. Clearly, reliability is the single biggest determinant of the operability of the system.

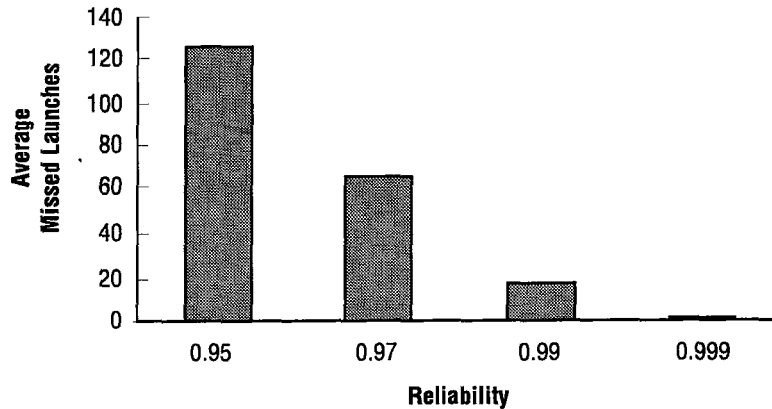

Figure 17. Impact of reliability on operability.

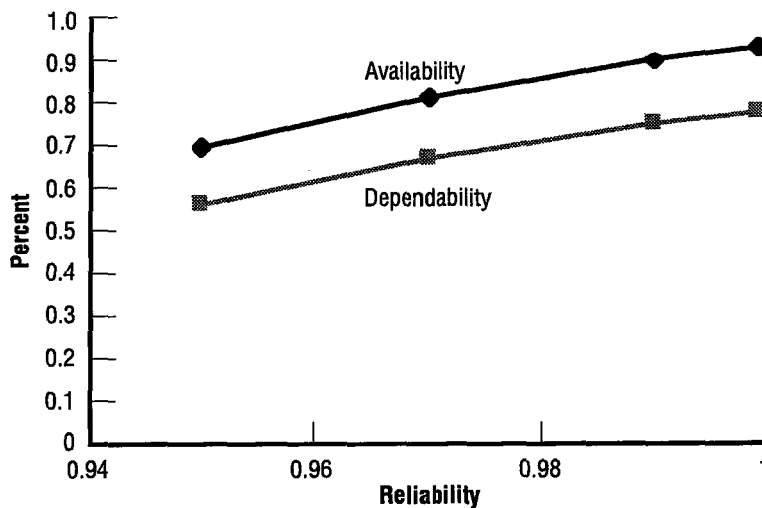

Figure 18. Operability metrics by reliability.

These results indicate the impact of scheduled and unscheduled processing and reliability on the launch system. Values of acceptable availability and dependability requirements would likely be around 95 percent. Considerable improvements in traditional spacecraft engine processing and design are necessary to meet this requirement.

These results indicate a potential manhour cost savings of approximately \$115.3K per flight along with a 7.4-hr reduction in the launch delay for the engine set modeled in this flow. The shuttle manpower data were used for this analysis. Figure 19 provides a graphical view of the manhour cost reductions and launch delay reductions for engine processing. While potential reductions are greatest in earlier processes (e.g., visual inspections), it is important to note that later processes may be more critical (e.g., pad activities). Timing controls such as built-in holds will be more effective earlier in the process flow. There is less opportunity for controlling delays late in launch.

Table 7. Engine processing manhours and launch delay reduction.

| Process Description | Process MHRS (Sched) | Process MHRS (Total) | Process MHRS Cost-3-Engine Set (\$K) | Target Cost Reduction (\$K) | Launch Delay Reduction (Hr) |
|-----------------------|----------------------|----------------------|--------------------------------------|-----------------------------|-----------------------------|
| Engine Drying | 154 | 169 | 20.2 | 1.7 | 0.03 |
| Engine Access | 20 | 22 | 2.6 | 0.2 | 0.05 |
| Visual Inspections | 374 | 1,120 | 134.4 | 80.7 | 1.6 |
| Leak Checks | 216 | 432 | 51.8 | 23.4 | 2.4 |
| Closeout Access | 140 | 210 | 25.2 | 7.6 | 1.2 |
| Engine Purge | 52 | 57 | 6.8 | 0.2 | 0.8 |
| Flight Readiness Test | 52 | 90 | 10.8 | 1.4 | 0.5 |
| Launch Preparation | 40 | 44 | 5.3 | 0.1 | 0.8 |

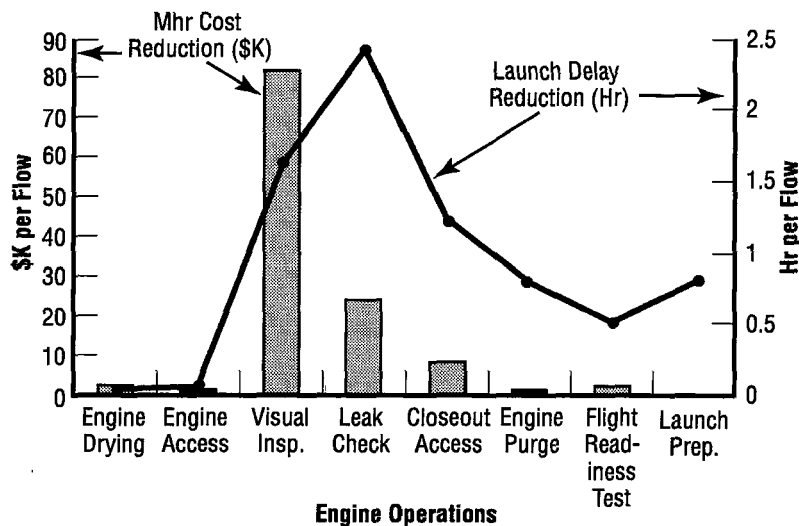

Figure 19. Engine operations manhours/cost analysis.

By using the shuttle-based results and the process target results, a relationship between percent nominal processing and clock hours or manhour cost can be determined for each process analyzed. This type of relationship provides a means to estimate how much improvement is needed to reduce the manhour cost of a given process to a specified target value, and where the improvements are most needed.

7. CONCLUSIONS

Deterministic and probabilistic operations models of engine processing flows have been constructed to illustrate the methodology defined in this document. The goal was to select appropriate metrics, develop a model, and conduct an appropriate design operations analysis. This supports design trade studies where operations will be considered equally with performance analyses. Traditionally, this has been a serious shortcoming of disciplines such as design operations. It has not been understood how to conduct such an analysis and what measures of merit to use. This analysis presents such an approach and applies it to a future engine concept. These models support trade and sensitivity studies allowing users to investigate “what if” scenarios to support design decisions. With the availability and dependability measures, it provides a means to quantitatively analyze scheduled and unscheduled maintenance activities for operations analysis.

The applications of this approach illustrate the traditional outcome in aerospace launch vehicle operations modeling. The difference between processing goals and initial historical-based operations estimates is large. This is at least in part due to the lack of good and accepted operations modeling techniques which use well-understood and interpretable metrics. The approach described here attempts to correct this problem by offering a rigorous process and good baseline data to identify operations concerns.

The results presented here represent a first iteration in an operations analysis process outlined in figure 4 for a hypothetical engine concept. Deterministic, goal-oriented modeling provides a top view of the requirements and allocations. The bottom-up, probabilistic analysis provides the operations processing estimates to compare against the goals and requirements. The first iteration involved the use of the STS engine (SSME) experience base. Further iterations will adjust this baseline to better estimates based upon actual design decisions. All specifications of processing are subject to requirements traceability via the STS requirements database.

Engine system scheduled and unscheduled maintenance impacts in the proposed launch vehicle flows have been identified. Critical path processes will have the greatest impact on launch delay. It is interesting to note that noncritical path processes defined in the initial operations concept may end up as critical path processes once an incidence of historical unscheduled maintenance activities is considered. From the results it is clear that the single biggest determinant of operability measures is reliability. While hardware reliability improvements are critical to improving operability, these results also point to improvements in corrective maintenance processing activities as critical to improved turnaround times and operability measures for future launch systems.

APPENDIX A—Engine Operations Requirements Database

Table 8 presents SSME operations requirements (OMRSD's) and other pertinent information to support definition and traceability for future engine requirements.

Table 8. Engine requirements database.

| OMRSD NUMBER | OMRSD DESCRIPTION (V41 FILE III DATED 9/15/95) | OMRSD EFFECTIVITY | Component | OPF OMI's | ENGINE SHOP OMI'S | VAB/PAD OMI'S | OTHER OMI'S | RT OMI'S | SUBSYSTEM CODE | OMRSD RATIONALE/ROOT CAUSES | Root Cause Categories |
|--------------|--|-------------------|-----------------|-----------------|-------------------|------------------|------------------|-----------------|----------------|--|--|
| V41BL0.060 | 88ME WELD Z2 & Z4 LEAK CHECK | PK8C, NRAT | HPOTP | V1011.05 Seq 07 | V1284.007 Seq 04 | V1046.003 Seq 07 | | | | Due to poor processing, HPOTP balance cavity standoff welds are leak checked - No leaks ever verified, but lack of weld penetration up to 90% has been found on these welds. Standoffs have been suspected of leaking and caused return to Plug weld leak occurred on a unit - Concern over these welds leading either Cocatalum/Pot gas into boost - therefore all external plug welds on the housing are checked | Aft Compartment overpressurization or fire |
| V41BL0.060-A | E1 HPOTP PUG WELD LEAK CHECK | PK8C, NRAT | HPOTP | V1011.05 Seq 09 | V1284.004 Seq 04 | V1046.004 Seq 04 | V1284.005 Seq 07 | | | Ensure joint integrity of LPOTP to pump inlet ducting after engine is installed | Aft Compartment overpressurization or fire |
| V41AX0.020-A | E1 L02 FEED (JOINT 01) I/F LK CK | ER, PR, OMDP | Lines/Ducts | V1011.05 Seq 07 | | V1046.003 Seq 05 | | | DUCTS | Verify pump inlet joint integrity after installing the LPOTP | Aft Compartment overpressurization or fire |
| V41AX0.020-B | E1 LH2 FEED (JOINT F1) I/F LK CK | ER, PR, OMDP | Lines/Ducts | V1011.05 Seq 05 | | V1046.002 Seq 04 | | | DUCTS | Joint Integrity Post Engine Installation | Aft Compartment overpressurization or fire |
| V41AX0.020-C | E1 GH2 PRESS (JOINT F9.3) I/F LK CK | ER, PR, OMDP | Lines/Ducts | V1011.05 Seq 09 | | V1046.004 Seq 04 | | | DUCTS | Joint Integrity Post Engine Installation | Aft Compartment overpressurization or fire |
| V41AX0.020-D | E1 L02 BLEED (JOINT 01S) I/F LK CK | ER, PR, OMDP | Lines/Ducts | V1011.05 Seq 07 | | V1046.003 Seq 05 | | | DUCTS | Joint Integrity Post Engine Installation | Aft Compartment overpressurization or fire |
| V41AX0.020-E | E1 LH2 BLEED (JOINT F4.3) I/F LK CK | ER, PR, OMDP | Lines/Ducts | V1011.05 Seq 05 | | V1046.002 Seq 04 | | | DUCTS | Joint Integrity Post Engine Installation | Aft Compartment overpressurization or fire |
| V41AX0.020-F | E1 HELIUM (JOINT P1) I/F LK CK | ER, PR, OMDP | Lines/Ducts | V1011.05 Seq 12 | | V1046.001 Seq 05 | V1046.006 Seq 04 | | DUCTS | Joint Integrity Post Engine Installation | Aft Compartment overpressurization or fire |
| V41AX0.020-G | E1 GN2 (JOINT N1) I/F LK CK | ER, PR, OMDP | Lines/Ducts | | | V1149 Seq 15 | V1046.006 Seq 03 | | DUCTS | Joint Integrity Post Engine Installation | Aft Compartment overpressurization or fire |
| V41AX0.020-H | E1 HYD - PRESS (JOINT H1) I/F LK CK | ER, PR, OMDP | Lines/Ducts | | VSE17 Seq 09 | | VSE18 | V9002.06 Seq 05 | DUCTS | Joint integrity Post Engine Installation | Aft Compartment overpressurization or fire |
| V41AX0.020-I | E1 HYD - RETURN (JOINT H17) I/F LK CK | ER, PR, OMDP | Lines/Ducts | | VSE17 Seq 09 | | VSE18 | V9002.06 Seq 05 | DUCTS | Joint Integrity Post Engine Installation | Aft Compartment overpressurization or fire |
| V41AX0.050-A | E1 G02 DRB/88ME INTERFACE FLANGE LEAK CHECK | A, ER | Lines/Ducts | | | V1046.005 Seq 05 | | | DUCTS | Joint Integrity Post Engine Installation | Aft Compartment overpressurization or fire |
| V41BL0.031 | 88ME ENCAPSULATION POWER HD LEAK CK | EK8C & ER | Powerhead | | V1284.007 Seq 04 | | | | ENGINE | System leak integrity check for launch - Mat.1 or Weld Thru-Crack; Seal not Sealed -> Crit. 1 | Aft Compartment overpressurization or fire |
| V41BL0.032 | 88ME ENCAPSULATION FUEL SVS 180 TEST | F | System | | V1284.007 Seq 04 | | | | ENGINE | System leak integrity check for launch - Mat.1 or Weld Thru-Crack; Seal not Sealed -> Crit. 1 | Aft Compartment overpressurization or fire |
| V41BL0.033 | 88ME ENCAPSULATION OXID SVS 180 TEST | F | System | | V1284.007 Seq 04 | | | | ENGINE | System leak integrity check for launch - Mat.1 or Weld Thru-Crack; Seal not Sealed -> Crit. 1 | Aft Compartment overpressurization or fire |
| V41BL0.034 | 88ME ENCAPSULATION HOT GAS SVS 180 TEST | F | System | | V1284.007 Seq 04 | | | | ENGINE | System leak integrity check for launch - Mat.1 or Weld Thru-Crack; Seal not Sealed -> Crit. 1 | Aft Compartment overpressurization or fire |
| V41BP0.010-A | E1 G02/GCV EXT LK CK & ORIFICE VERIF | EK8C, I | Valves | V1011.04 Seq 07 | V1284.002 Seq 17 | V1046.005 Seq 05 | V1284.006 Seq 05 | | | Establishes leak test of all gaseous oxygen system joints from the AFV to the orbiter interface on a each flight basis. | Aft Compartment overpressurization or fire |
| V41A00.010-A | E1 SENSOR CHECKOUT | EK8C, ER, LRU | Instrumentation | V1011.06 Seq 02 | V1284.002 Seq 06 | V1046.001 Seq 04 | | V9001VL4 Seq 02 | AVIONICS | Planned Preflight Checkout | Erroneous shutdown, loss of vehicle |
| V41A00.013-A | E1 OPERATIONAL INSTRUMENTATION VERIFICATION | A, ER | Instrumentation | | | V1046.001 Seq 04 | | V9001VL4 Seq 02 | AVIONICS | Instrumentation Integrity checkout | Erroneous shutdown, loss of vehicle |
| V41BU0.250-A | E1 SENSOR IR VERIFICATIONS | EK8C, LRU | Instrumentation | V1011.02 Seq 07 | | | | | HEX | Functional check of each turbine discharge temp | Erroneous shutdown, loss of vehicle |
| V41BP0.020-A | E1 HEX COIL LEAK TEST | A, EK8C, PLRU | HEX | V1011.04 Seq 02 | V1284.003 Seq 03 | V1046.005 Seq 06 | | | HEX | Mat.1 (stringer) or Weld Thru-Crack; HPOTP Installation Impact Hole -> HG to Tank; Crit. 1 | Fire, Uncontained engine failure |
| V41BP0.030 | 88ME HEX COIL PROOF TEST | PLRU | HEX | V1011.04 Seq 03 | V1284.003 Seq 04 | V1046.005 Seq 07 | | | HEX | Mat.1 (stringer) or Weld Thru-Crack; HPOTP Installation Impact Hole -> HG to Tank; Crit. 1 | Fire, Uncontained engine failure |
| V41BU0.086 | HEX EDDY CURRENT INSPECTIONS (TIME & CYCLE) | TC | HEX | V1011.02 Seq 11 | | | | | HEX | Thin Walls from Bracket Wear, Manuf -> Thru-Crack, HG Leakage to Tank; Crit. 1 | Fire, Uncontained engine failure |
| V41BU0.115 | HEAT EXCHANGER INSPECTION | TC | HEX | | VSE02 Seq 14 | | | | HEX | Visible Impact Damage, Bracket Wear -> Thru-Crack -> HG to Tank; Crit. 1; Turn. Vane Cracks -> Loss of Vane Impact MI Post -> Damage or Crit. 1 | Fire, Uncontained engine failure |
| V41BU0.125 | HEX VISUAL INSPECTION | PLRU | HEX | | VSE02 Seq 12 | | | | HEX | HPOTP Installation Impact Hole -> HG to Tank; Crit. 1 | Fire, Uncontained engine failure |
| V41BU0.075-A | E1 HPFTP INTERNAL INSPECTION | PK8C | HPFTP | V1011.02 Seq 08 | | | | | TURBOPUMPS | Verify no inlet or discharge sheet metal cracking; no nozzle cracking or erosion; no blade cracking, platform cracking, or erosion; no fishmouth seal cracking or missing pieces; no bellows shield cracking. (All inspections completed with | Fire, Uncontained engine failure |
| V41BU0.076 | HPFTP FIRST STAGE BLADE 22X INSPECTION | TC, DCE | HPFTP | | VSE06 Seq 14 | | | | TURBOPUMPS | Verify no blade cracking due to previous occurrences of airfoil cracking | Fire, Uncontained engine failure |
| V41BU0.080 | HPFTP TURBINE INSPECTION (TIME & CYCLE) | PK8C | HPFTP | | VSE06 Seq 14 | | | | TURBOPUMPS | Verify no inlet or discharge sheet metal cracking including weld 450 and the turning vanes; no nozzle cracking or erosion; no blade cracking, platform cracking, or erosion; no fishmouth seal cracking or missing pieces; no bellows shield cracking via | Fire, Uncontained engine failure |
| V41BU0.087 | HPFTP BELLOW'S HEIGHT VERIF | PLRU | HPFTP | | VSE06 08SU 2 | | | | TURBOPUMPS | Verify bellows height adequate to provide proper preload on the bellows at installation. Incorporated as a result of a previous failure of the bellows. | Fire, Uncontained engine failure |
| V41C30.050-A | E1 HPFTP TURBINE BEARING DRYING | EK8C | HPFTP | V1011.01 Seq 03 | | V9018.002 Seq 04 | V1038VL2 Seq 07 | | TURBOPUMPS | Ensure all moisture is removed from the bearing area after a testflight | Fire, Uncontained engine failure |

Table 8. Engine requirements database (Continued).

| OMRSD NUMBER | OMRSD DESCRIPTION (V41 FILE III DATED 9/15/95) | OMRSD EFFECTIVITY | Component | OPF OMI's | ENGINE SHOP OMI's | VAB/PAD OMI's | OTHER OMI's | RT OMI's | SUBSYSTEM CODE | OMRSD RATIONALE/ROOT CAUSES | Root Cause Categories |
|--------------|---|----------------------|---------------|-----------------|-------------------|------------------|------------------|--------------|----------------|---|----------------------------------|
| V41B00.390-A | E1 LPFD OVALITY CHECK | F | Lines/Ducts | V1011.02 Seq 10 | | | V9018.002 Seq 10 | | DUCTS | Contingency test performed only when the LPFD helium barrier system has been damaged. Object is to detect potential duct collapse or separation from the layer of insulation by measuring the roundness of the duct. | Fire, Uncontained engine failure |
| V41B00.400 | PERFORM LPFD XRAY INSPECTION | F | Lines/Ducts | TBD | | | | | DUCTS | Contingency reqmt performed only when the ovality check indicates that some damage or collapse has occurred in the LPFD. The cross section is X-rayed in an attempt to verify | Fire, Uncontained engine failure |
| V41BS0.050 | HPOTPIAT TORQUE TEST | EKSC, RI, PLRU | HPOTP | V1011.03 Seq 06 | V5E02 Seq 25 | | | | TURBOPUMPS | Replaced by V41BS0.040-A | Fire, Uncontained engine failure |
| V41BS0.055 | HPOTPIAT INVESTIGATIVE TORQUE | F | HPOTP | V1011.03 Seq 06 | V5E02 Seq 25 | | | | TURBOPUMPS | Replaced by V41BS0.042 | Fire, Uncontained engine failure |
| V41B00.405 | SSME LPFD TRIPDOL LEGS INSPECTION | DCE | Lines/Ducts | TBD | | | | | DUCTS | Performed to insure LPFD structural integrity. Inspection is performed if post flight data evaluation reveals HPFTP unacceptable synchronous frequencies. | Fire, Uncontained engine failure |
| V41B00.065-A | E1 ATD BLOCK III HPOTP INTERNAL INSPECTION | PKSC, NRAT | HPOTP | V1011.02 Seq 03 | | | | | TURBOPUMPS | No HPOTPIAT Internal Inspections were made during certification. Inspections of the turbine, mainstage pump and PBP Inlets, and all three bearings have been added only because the inspections aren't time consuming and because | Fire, Uncontained engine failure |
| V41BS0.010-A | E1 LPFTP TORQUE TEST | A, RI, PSI, ER, PLRU | LPFTP | V1011.03 Seq 04 | | | | | TURBOPUMPS | Verify rotor is free to rotate prior to testing | Fire, Uncontained engine failure |
| V41B00.127 | HPOTPIAT PBP TIEBOLT LOCK | F | HPOTP | V1011.03 | | | | | TURBOPUMPS | | Fire, Uncontained engine failure |
| V41B00.128 | HPOTPIAT CONTAMINATION INSPECTION | A, PKSC | HPOTP | V1011.07 Seq ?? | | | | | TURBOPUMPS | | Fire, Uncontained engine failure |
| V41CB0.085 | SSME HPOTPIAT TURBINE BEARING DRYING | PKSC | HPOTP | V1011.01 Seq 03 | V1294.008 Seq 04 | V9018.002 Seq 04 | | | TURBOPUMPS | | Fire, Uncontained engine failure |
| V41BS0.011 | LPFTP INVESTIGATIVE TORQUE | F | LPFTP | V1011.03 Seq 04 | | | | | TURBOPUMPS | Verify all moisture is removed from the bearing area after a test/flight. | Fire, Uncontained engine failure |
| V41BS0.030-A | E1 LPOTP TORQUE TEST | A, RI, PSI, ER, PLRU | LPOTP | V1011.03 Seq 05 | V5E23 | | | | TURBOPUMPS | Investigative torque check if the specification limits are exceeded - torque check failure generally lift-off seal binding or laby seal - copper plating rub | Fire, Uncontained engine failure |
| V41BS0.031 | LPOTP INVESTIGATIVE TORQUE | F | LPOTP | V1011.03 Seq 05 | | | | | TURBOPUMPS | Done to ensure rotor is not bound up prior to start - concern over contamination if high and also start characteristics if rotor is slow to spin - contamination has been found that bound the rotor and bearing wind-up can also routinely causes failures | Fire, Uncontained engine failure |
| V41BS0.032-A | E1 LPOTP SHAFT TRAVEL | A, ER, PLRU | LPOTP | V1011.03 Seq 05 | V5E23 | | | | TURBOPUMPS | Performed to free the rotor if possible - done only if failure - must make torque return to normal value or pump is removed | Fire, Uncontained engine failure |
| V41BR0.040-A | E1 MAIN INJECTOR LOX POST VACUUM DECAY | DLP | Main Injector | V1011.02 Seq 08 | | | | | COMBUSTION | Bearing wear on LPOTP thrust bearing must be monitored | Fire, Uncontained engine failure |
| V41B00.034-A | E1 MAIN INJECTOR LOX POST BIASING | EKSC | Main Injector | V1011.02 Seq 04 | | | | | COMBUSTION | LDX Post Integrity check - Impacted or Deflected Post Plugged & Plug Damaged -> Loss of Plug, Increase Damage to Post -> Loss of Post, Crit. 1 | Fire, Uncontained engine failure |
| V41B00.165 | MCC ISOLATION LEAK TEST | F | MCC | | V1294.003 Seq 06 | | | | COMBUSTION | Under Bias (cont) -> Flow Erosion MCC H/G Wall -> Repair or Crit. 1 Leak, Under Bias -> Combustion Performance Loss | Fire, Uncontained engine failure |
| V41B00.240-A | E1 MCC LINER CAVITY DECAY CHECK | EKSC, LRU | MCC | | V1294.003 Seq 06 | | | | COMBUSTION | Mat'l Debond @ Liner Air -> Repair; UAI Performance Loss; Crit 3 to Crit 1 if increase. | Fire, Uncontained engine failure |
| V41B00.031-A | E1 MCC BONDLINE ULTRASONIC INSPECTION | EKSC | MCC | V1011.02 Seq 05 | | | V1038V12 Seq 08 | | COMBUSTION | Burst Diaphragm Damage, Internal Liner To Structure Thru-Internal Debonds -> Emulsion, Crit 1; External Leak, UAI to Crit 1 | Fire, Uncontained engine failure |
| V41B00.081-A | MCC INJECTOR INSPECTION WITH HPFTP REMOVED | PLRU | MCC | | V5E06 Seq 12 | | | | COMBUSTION | Inspect when HPFTP Removed | Fire, Uncontained engine failure |
| V41B00.082-A | MCC INJECTOR INSPECTION WITH HPOTP REMOVED | PLRU | MCC | | V5E02 Seq 14 | | | | COMBUSTION | Inspect when HPOTP Removed | Fire, Uncontained engine failure |
| V41B00.180-A | E1 THRUST CHAMBER NOZZLE LEAK TEST | EKSC | MCC/Nozzle | V1011.05 Seq 09 | V1294.011 Seq 08 | V1046.004 Seq 04 | V1038V12 Seq 08 | | COMBUSTION | Cold or Hot Wall Thru-Crack; Degraded Liner Mat'l or Bonded -> Repair; UAI Performance Loss; Crit 3 to Crit 1 if increase. If no action required then data used to adjust engine performance predictions | Fire, Uncontained engine failure |
| V41B00.200-A | E1 MCC TO NOZZLE SEAL LEAK TEST | EKSC, LRU, I | MCC/Nozzle | V1011.05 Seq 08 | V1294.004 Seq 03 | V1046.004 Seq 08 | | | COMBUSTION | G-15 Seal Thermal Degradation -> Air Compartment Leak, Crit. 1 | Fire, Uncontained engine failure |
| V41B00.167 | SSME NOZZLE ENCAPSULATION LEAK TEST | F | Nozzle | V1011.02 Seq 05 | V1294.010 Seq 03 | | | | COMBUSTION | Cold or Hot Wall Thru-Crack like Crown Erosion, Brazeloss Tube Ends -> Repair; UAI Performance Loss; Crit 3 to Crit 1 if Exposed Tube Crowns -> Leakage up to Crit 1; Tube Bulges -> Trip HG Flow or Shock Wave -> Dyn. Destruction NZ, Crit 1; Re-entry Annealing -> Mat'l Degradation, Burst -> Crit. 1 | Fire, Uncontained engine failure |
| V41B00.353-D | NOZZLE VISUAL INSPECTION | EKSC | Nozzle | V1011.02 Seq 05 | | | V1038V12 Seq 08 | | COMBUSTION | Eroded Tube Crowns -> Leakage up to Crit 1; Tube Bulges -> Trip HG Flow or Shock Wave -> Dyn. Destruction NZ, Crit 1; Re-entry Annealing -> Mat'l Degradation, Burst -> Crit. 1 | Fire, Uncontained engine failure |
| V41B00.353-E | NOZZLE PARENT METAL DISCOLORATION INSPECTION | EKSC | Nozzle | V1011.02 Seq 05 | | | V1038V12 Seq 08 | | COMBUSTION | Inspect when HPFTP Removed | Fire, Uncontained engine failure |
| V41B00.081-B | FUEL SIDE TRANSFER TUBE INSPECTION | PLRU | Powerhead | | V5E06 Seq 12 | | | | COMBUSTION | Inspect when HPOTP Removed | Fire, Uncontained engine failure |
| V41B00.082-B | OXIDIZER SIDE TRANSFER TUBE INSPECTION | PLRU | Powerhead | | V5E02 Seq 14 | | | | COMBUSTION | Inspect when HPOTP Removed | Fire, Uncontained engine failure |
| V41B00.081-C | FUEL PREBURNER INSPECTION | PLRU | Preburner | | V5E06 Seq 12 | | | | COMBUSTION | Inspect when HPFTP Removed | Fire, Uncontained engine failure |
| V41B00.081-D | FPB LINER INSPECTION | PLRU | Preburner | | V5E06 Seq 12 | | | | COMBUSTION | Inspect when HPFTP Removed | Fire, Uncontained engine failure |
| V41B00.082-C | OXIDIZER PREBURNER INSPECTION | PLRU | Preburner | | V5E02 Seq 14 | | | | COMBUSTION | Inspect when HPOTP Removed | Fire, Uncontained engine failure |
| V41B00.082-D | OPB LINER INSPECTION | PLRU | Preburner | | V5E02 Seq 14 | | | | COMBUSTION | Inspect when HPOTP Removed | Fire, Uncontained engine failure |
| V41B00.085 | OXID P/B INJECTOR ELEMENT INSP | TC, MSP | Preburner | | V5E02 Seq 14 | | | | COMBUSTION | Damaged Posts Pinned, Loss of Pins -> Increase Damage to Post -> Loss of Post Into Turbine, Crit. 1 or Internal Leakage -> Overheat Turbine, Crit. 1 | Fire, Uncontained engine failure |
| V41B00.088 | SSME FUEL P/B INJECTOR ELEMENT INSP (IF ONE OR MORE PINS FOUND MISSING) | MSP | Preburner | TBD | | | | | COMBUSTION | Damaged Posts Pinned, Loss of Pins -> Increase Damage to Post -> Plug Post & Use or Loss of Post Into Turbine, Crit. 1 or Internal Leakage Overheat Turbine, Crit. 1 | Fire, Uncontained engine failure |
| V41B00.105 | FPB INJECTOR OXID POSTS INSP | TC | Preburner | | V5E06 Seq 12 | | | | COMBUSTION | Damaged Posts Pinned, Loss of Pins -> Increase Damage to Post -> Plug Post & Use or Loss of Post Into Turbine, Crit. 1 or Internal Leakage Overheat Turbine, Crit. 1 | Fire, Uncontained engine failure |
| V41B00.570 | FPB DIFFUSER INSPECTION | DCE | Preburner | TBD | | | | | COMBUSTION | Contingency reqmt performed to inspect for cracks in FPB diffuser. This reqmt will be invoked only if data evaluation of HPFTP turbine discharge temp deems it necessary | Fire, Uncontained engine failure |
| V41B00.032 | OPB FACEPLATE FLATNESS CHECKS | DCE | Preburner | | | | | | COMBUSTION | Integrity check after "POP" - "POP" Damage, Bowing Indication of Stress Cracks -> Loss of Element into Turbine, Crit 1; or Internal Leakage -> Overheat Turbine, Crit. 1 | Fire, Uncontained engine failure |
| V41B00.040-A | E1 COMPONENTS INTERNAL INSPECTION | EKSC | System | V1011.02 Seq 08 | | | | | | Boroscope inspection of accessible engine areas without disassembly | Fire, Uncontained engine failure |
| V41CB0.020-A | E1 ENVIR CLOSURE INSTALLATION | EKSC | System | S0028 Seq 19 | | | S0026 | | | Insure that LPFD helium barrier system is functional to preclude cryopumping in the event of a launch scrub which can lead to a collapse of the duct. | Fire, Uncontained engine failure |
| V41B00.080 | RV OVERRIDE SEALS LEAK TEST (TIME & CYCLE) | TC | Valves | TBD | | | | | | Periodic (every 10 starts). To verify that the RV shaft seals maintain override opening pressure within the RV. | Fire, Uncontained engine failure |
| V41B00.100 | AFV SEAT AND SHAFT SEAL LEAKAGE | A, GP | Valves | V1011.04 Seq 07 | | V1046.005 Seq 05 | | | | No LOX in HEX prestart - Crit 1 | Fire, Uncontained engine failure |
| V41B00.101 | AFV SHAFT AND SEAT ISOLATION | F | Valves | V1011.04 Seq 07 | | V1046.005 Seq 05 | | | | Isolation check if the V41B00.100 leakage limits are exceeded | Fire, Uncontained engine failure |
| V41B00.170-A | E1 PROP VALVE ACT PNEU SEAL LEAK | EKSC, LRU | Valves | V1011.05 Seq 12 | V1294.002 Seq 10 | V1046.006 Seq 04 | V1011.06 Seq 03 | V5E17 Seq 09 | | Valve/Seal Leakage - LRU Integrity Check | Fire, Uncontained engine failure |
| V41B00.171 | PROP VALVE ACT PNEU SEAL ISO TEST | F | Valves | TBD | | | | | | Isolation check if the V41B00.170-A leakage limits are exceeded | Fire, Uncontained engine failure |
| V41BR0.030-A | E1 AFV CRACKING PRESSURE TEST | EKSC, LRU | Valves | V1011.04 Seq 07 | V1294.002 Seq 17 | V1046.005 Seq 05 | | | | Verify proper AFV operation - Crit 1 | Fire, Uncontained engine failure |

Table 8. Engine requirements database (Continued).

| OMRSD NUMBER | OMRSD DESCRIPTION (V41 FILE III DATED 9/15/95) | OMRSD EFFECTIVITY | Component | OPF OMI's | ENGINE SHOP OMI's | VAB/PAD OMI's | OTHER OMI's | RT OMI's | SUBSYSTEM CODE | OMRSD RATIONALE/ROOT CAUSES | Root Cause Categories |
|--------------|--|-------------------|-------------------|-----------------|--------------------------|------------------|-----------------|-----------------|----------------|--|--|
| V418U.020-A | AFV FILTER INSPECTIONS | A | Valves | V1011.04 POSU 5 | V1294.002 POSU 8 | V1046.005 POSU 2 | | | | Contamination check to verify that filter is not plugged which could lead to a collapse of the HEX. | Fire, Uncontained engine failure |
| V418U.020-D | AFV FILTER REPLACEMENT | A | Valves | V1011.04 Seq 07 | | V1046.005 Seq 05 | V5005 POSU 3 | V5087 Task 28 | | Contamination check to verify that filter is not plugged which could lead to a collapse of the HEX. | Fire, Uncontained engine failure |
| V418U.010-A | E1 FUEL TP L/U/MFV BALL SEAL LK TEST | EKSC, ER | HPFTR, LPFTR, MFV | V1011.05 Seq 05 | V1294.007 Seq 03 | V1046.002 Seq 03 | | | | Verify no LPFTR or HPFTR lift-off seal carbon nose leakage or main fuel valve ball seal leakage. (Fuel system pressurized, measure leakage into hot gas system) | Hazardous gas buildup |
| V418U.011 | FUEL TP L/U/MFV SEALS ISOLATION TEST | F | HPFTR, LPFTR, MFV | TBD | | | | | | Isolation check if the V418U.010-A leakage limits are exceeded. | Hazardous gas buildup |
| V418U.020-A | E1 FUEL TP PIST/NFLX/MFV LK CK | EKSC | HPFTR, LPFTR, MFV | V1011.05 Seq 05 | V1294.005 Seq 03 | V1046.002 Seq 06 | | | | Verify no LPFTR or HPFTR large diameter secondary seal leakage or Naflex or MFV leakage (Fuel system pressurized, measure leakage out of the fuel component drain) | Hazardous gas buildup |
| V418U.021 | FUEL TP PIST/NFLX/MFV ISO TEST | F | HPFTR, LPFTR, MFV | V1011.05 Seq 05 | V1294.005 Seq 03 | V1046.002 Seq 06 | | | | Isolation check if the V418U.020-A leakage limits are exceeded. | Hazardous gas buildup |
| V418U.050-A | E1 COMB HOT GAS SYS SEAL LEAK TEST | EKSC, LRU | System | V1011.05 Seq 09 | V1294.005 Seq 06 | V1046.004 Seq 04 | | | | Verify no LPFTR or HPFTR small diameter secondary seal leakage or other system leakage (Hot gas system pressurized, measure leakage out of the fuel component drain) | Hazardous gas buildup |
| V418S0.043-B | E2 HPOTP IMPELLER LOCK VERIF | PKSC, PLRU, NRAT | | V1011.03 Seq 06 | V5E02 Seq 25 | | | | TURBOPUMPS | | |
| V418S0.043-C | E3 HPOTP IMPELLER LOCK VERIF | PKSC, PLRU, NRAT | | V1011.03 Seq 06 | V5E02 Seq 25 | | | | TURBOPUMPS | | |
| V418U.0351 | SSME HOT GAS SYS SEAL LK ISO TEST | F | System | TBD | | | | | | Isolation check if the V418U.0350-A leakage limits are exceeded. | Hazardous gas buildup |
| V418U.0352-A | E1 SSME COMB HOT GAS TO FUEL SYS REV LK CK | PKSC | System | V1011.05 Seq 09 | V1294.005 Seq 06 | V1046.004 Seq 04 | | | | Verify no reverse LPFTR or HPFTR carbon nose leakage (Hot gas system pressurized, measure leakage into fuel system) Incorporated when the pump end to turbine end leak check did not detect existing carbon nose leakage. | Hazardous gas buildup |
| V418U.0353 | SSME HOT GAS REVERSE ISO LK CK | F | System | TBD | | | | | | Isolation check if the V418U.0352-A leakage limits are exceeded. | Hazardous gas buildup |
| V418U.0353-A | E1 FUEL BLEED VALVE SEAT LEAK TEST | EKSC, LRU | Valves | V1011.05 Seq 04 | V1294.005 Seq 03 | V1046.002 Seq 05 | | | | Valve Leakage Check | Hazardous gas buildup |
| V418U.0353-B | E2 COMPONENTS EXTERNAL INSPECTION | EKSC | | V1011.02 Seq 04 | | | | | | Handling Damage, Clearance Checks, Loose Spot Welds on or Melted TPS | |
| V418U.0353-C | E3 COMPONENTS EXTERNAL INSPECTION | EKSC | | V1011.02 Seq 04 | | | | | | Handling Damage, Clearance Checks, Loose Spot Welds on or Melted TPS | |
| V418U.032 | FUEL BLEED VALVE BELLWIS LEAK TEST | LRU | Valves | V1011.05 Seq 10 | V1294.005 Seq 03 | V1046.002 Seq 07 | V1038VL2 Seq 08 | | COMBUSTION | LRU - Remove and replace verification | Hazardous gas buildup |
| V418U.031-B | E2 MCC BONDLINE ULTRASONIC INSPECTION | EKSC | | V1011.02 Seq 05 | | | | | | Internal Debonds -> Emulsion, Cr1 1; External Leak, UAI to Cr1 1 | |
| V418U.031-C | E3 MCC BONDLINE ULTRASONIC INSPECTION | EKSC | | V1011.02 Seq 05 | | | | | | Internal Debonds -> Emulsion, Cr1 1; External Leak, UAI to Cr1 1 | |
| V418U.034 | OXID BLEED VALVE BELLWIS LEAK TEST | LRU | Valves | V1011.05 Seq 11 | V1294.006 Seq 03 | V1046.003 Seq 09 | V1038VL2 Seq 08 | | COMBUSTION | LRU - Remove and replace verification | Hazardous gas buildup |
| V418S0.020-A | E1 HPFTR TORQUE TEST | A, R, PLRU | HPFTR | V1011.03 Seq 06 | V5E06 OSSU 1 | | | | TURBOPUMPS | Verify the rotor is free to rotate prior to testing | Improper start, Ox rich resulting in engine fire |
| V418S0.021 | HPFTR INVESTIGATIVE TORQUE | F | HPFTR | V1011.03 Seq 09 | V5E06 OSSU 1 | | | | TURBOPUMPS | Investigative torque check if the specification limits are exceeded. | Improper start, Ox rich resulting in engine fire |
| V41AL0.010-A | E1 GIMBAL ELECTRICAL BONDING TEST | I, ER | Avionics | | | | V5005 Seq 06 | | AVIONICS | Verifies proper electrical grounding conditions exist between the SSME gimbal bearing and the orbiter structure. Test performed each time the bonding straps are disturbed. | Unscheduled Maintenance Action or Launch Delay |
| V41AL0.020-A | E1 ELECTRICAL INTERFACE PANEL BONDING TEST | I, ER | Avionics | | | | V5005 Seq 06 | | AVIONICS | Verifies proper electrical grounding conditions exist between the SSME electrical interface panel and the orbiter structure. Test performed each time the bonding straps are disturbed. | Unscheduled Maintenance Action or Launch Delay |
| V41AL0.030-A | E1 SSME/TVC ELECTRICAL BONDING TEST | A, I, ER | Avionics | | | S1287 OSSU 3 | | | AVIONICS | Verifies proper electrical grounding conditions exist between the SSME TVC actuator attach points and the orbiter structure. Test performed each time the bonding straps are disturbed. | Unscheduled Maintenance Action or Launch Delay |
| V41AN0.010-A | E1 SSME CONTROLLER POWER APPLICATION | A, ER | Avionics | | | | | V9001VL4 Seq 02 | AVIONICS | Defines the proper sequencing of cockpit switches for application of SSME controller power as well as the values of the monitored responses. Identifies the constraints for cooling air and FACOS power. | Unscheduled Maintenance Action or Launch Delay |
| V41AN0.020-A | E1 AC POWER REDUNDANCY VERIFICATION | A, ER | Avionics | | | V1046.001 Seq 04 | | V9001VL4 Seq 02 | AVIONICS | Provides for SSME AC power redundancy verification while controllers are under power load. | Unscheduled Maintenance Action or Launch Delay |
| V41AN0.022-A | E1 CONTROLLER POWER SUPPLY REDUNDANCY VERIF | A, LRU | Avionics | V1011.06 Seq 02 | V1294.002 Seq 08 | V1046.001 Seq 04 | | V9001VL4 Seq 09 | AVIONICS | Performs a redundancy verification of the SSME controller power supplies. Controller channels A&C and B&C are verified. This procedure also verifies the backup memory power is functional and verifies the AC supplied $+10 V$ | Unscheduled Maintenance Action or Launch Delay |
| V41AN0.023-A | E1 CONTROLLER 28V MEMORY TEST | LRU | Avionics | | V1294.002 Seq 03 | | | V9001VL4 Seq 09 | AVIONICS | Verifies the capability of the 28 volt DC and battery systems are holding up the controller memory. | Unscheduled Maintenance Action or Launch Delay |
| V41AN0.035-A | E1 COMMANDED CONTROLLER CHECKOUT | A, ER, LRU | Avionics | V1011.06 Seq 02 | V1294.002 Seq 07 | V1046.001 Seq 04 | | V9001VL4 Seq 09 | AVIONICS | Controller Changeout Verification. Functional hardware and software checkout. | Unscheduled Maintenance Action or Launch Delay |
| V41ZAO.010 | SSME HARNESS REPLACEMENT RETEST | LRU | Avionics | | V5E02 Seq 27 | | | | AVIONICS | Defines the continuity and insulation resistance tests to be performed on any replacement harness installed on an engine | Unscheduled Maintenance Action or Launch Delay |
| V72AQ0.020-A | E1U 1 READINESS TEST | A, LRU | Avionics | | | | | V9001VL4 Seq 02 | AVIONICS | Unscheduled Maintenance Action or Launch Delay | |
| V41AU0.090-A | E1 GIMBAL BEARING SENSOR CHANNELIZATION VERIF | ER, LRU | Instrumentation | | | V1046.001 Seq 12 | | V9001VL4 Seq 02 | AVIONICS | Instrumentation integrity checkout | Unscheduled Maintenance Action or Launch Delay |
| V41AU0.090-A | E1 POST-FLT STRAIN GAGE CHECKOUT | A, EKSC | Instrumentation | V1011.02 Seq 04 | | | | V9001VL4 Seq 02 | AVIONICS | Part of this check is Weld #3 Strain Gage checkout - needed to ensure electrical continuity of gage after bond is assured | Unscheduled Maintenance Action or Launch Delay |
| V41AU0.090-D | E1 POST-FLIGHT SENSOR CHECKOUT | A, EKSC | Instrumentation | | | | | V9001VL4 Seq 02 | AVIONICS | Instrumentation integrity checkout | Unscheduled Maintenance Action or Launch Delay |
| V41AU0.016-A | E1 MADS INSTRUMENTATION VERIFICATION | ER, LRU | Instrumentation | V1011.06 Seq 08 | V1294.002 POSU 11 | V1046.001 Seq 13 | | V9001VL4 Seq 02 | AVIONICS | Instrumentation integrity checkout | Unscheduled Maintenance Action or Launch Delay |
| V41AU0.020-A | E1 SKIN TEMP CHANNELIZATION VERIFICATION | ER, LRU | Instrumentation | | | V1046.001 Seq 13 | | | AVIONICS | Instrumentation integrity checkout | Unscheduled Maintenance Action or Launch Delay |
| V41AU0.042-A | E1 HPOTP STRAIN GAGE DEBOND TEST | A, PLRU, I, NRAT | Instrumentation | | V5E02 Seq 27 & V1294.002 | | | | AVIONICS | Weld #3 Strain gage in place to detect uneven bearing wear - debond test needed to ensure acceptable data on next flight | Unscheduled Maintenance Action or Launch Delay |
| V41AP0.020-A | E1 MFVA PRI HEATER POWER ON COMMAND | I | Valves | | | | | | AVIONICS | Changeout Verification | Unscheduled Maintenance Action or Launch Delay |
| V41AP0.020-D | E1 MFVA SEC HEATER POWER ON COMMAND | I | Valves | | | | | | AVIONICS | Changeout Verification | Unscheduled Maintenance Action or Launch Delay |
| V41BU0.351-A | E1 POST FLIGHT MCC LINER POLISHING | EKSC | MCC | V1011.02 Seq 05 | | | | V1038VL2 Seq 08 | COMBUSTION | Remove Liner Roughness from Intense Environ. -> Erosion -> Leakage, Performance Loss | Unscheduled Maintenance Action or Launch Delay |
| V41BU0.352-A | E1 PRELAUNCH MCC LINER POLISHING | A | MCC | | | S1287 OSSU 9 | | | COMBUSTION | Remove Surface Oxidation -> Erosion -> Leakage, Performance Loss | Unscheduled Maintenance Action or Launch Delay |
| V41BU0.093 | HGM FUEL SIDE DYE PEN INSP (PHASE II) | TC | Powerhead | | V5E06 Seq 12 | | | | COMBUSTION | Liner Mat.1 & Transfer Tube Weld Thru-Cracks -> By-pass Flow Performance Loss | Unscheduled Maintenance Action or Launch Delay |
| V41BU0.096 | HGM OXID SIDE DYE PEN INSP (PHASE II) | TC | Powerhead | | V5E02 Seq 14 | | | | COMBUSTION | Liner Mat.1 & Transfer Tube Weld Thru-Cracks -> By-pass Flow Performance Loss | Unscheduled Maintenance Action or Launch Delay |
| V41BU0.097 | HGM FUEL SIDE DYE PEN INSP (PHASE II) | TC | Powerhead | | V5E06 Seq 12 | | | | COMBUSTION | Liner Mat.1 & Transfer Tube Weld Thru-Cracks -> By-pass Flow Performance Loss | Unscheduled Maintenance Action or Launch Delay |
| V41BU0.098 | HGM OXID SIDE DYE PEN INSP (PHASE II) | TC | Powerhead | | V5E02 Seq 14 | | | | COMBUSTION | Liner Mat.1 & Transfer Tube Weld Thru-Cracks -> By-pass Flow Performance Loss | Unscheduled Maintenance Action or Launch Delay |
| V72AQ0.040-A | VERIFY SSME 1E1U 1 COMMAND PATH | A, LRU | Avionics | | | | | V9001VL4 Seq 02 | AVIONICS | Performance Loss | |

Table 8. Engine requirements database (Continued).

| OMRSD NUMBER | OMRSD DESCRIPTION (V41 FILE #) DATED 9/15/95 | OMRSD EFFECTIVITY | Component | OPF OMI's | ENGINE SHOP OMI's | VAB/PAD OMI's | OTHER OMI's | RT OMI's | SUBSYSTEM CODE | OMRSD RATIONALE/ROOT CAUSES | Root Cause Categories |
|--------------|--|-------------------|-------------|-----------------|-------------------|------------------|------------------|-----------------|----------------|--|-----------------------|
| V72AQ0.050-A | VERIFY SSME 1/EU 1 STAT CHANNEL | A, LRU | Avionics | | | | V9001V4 Seq 02 | | AVIONICS | | |
| V72AQ0.060-A | EU 1 FM SYSTEM INTERFACE DATA | LRU | Avionics | | | S0017VL13 Seq 42 | | | AVIONICS | | |
| V72AW0.030-A | EU 1 POWER REDUNDANCY | A, LRU | Avionics | | | | V9001V4 Seq 02 | | AVIONICS | | |
| V41BU0.420-A | E1 HEAT SHIELD BLANKET INSPECTION | A | Heat Shield | | | S1287 Seq 04 | | | HEAT SHIELD | Thermal Deformations -> AR Leak to Atmosphere -> CRIL 1? | |
| V41BU0.421-A | E1 EMHS INSPECTION | A | Heat Shield | V41-40018 | V1294.002 Seq 19 | | | | HEAT SHIELD | | |
| V41BU0.050 | HYDRAULIC DRAIN LINE INSPECTION (TIME & CYCLE) | TC | Lines/Ducts | | | V1046.001 Seq 13 | | | HYDRAULIC | Periodic inspection (every 10 tests) of hydraulic actuator shaft seals. | |
| V58AG0.121-A | SUPPLY QD PRE-MATE INSPECTION | I | Lines/Ducts | | | | V9002.06 Seq 03 | | HYDRAULICS | Verify Configuration | |
| V58AG0.121-B | RETURN QD PRE-MATE INSPECTION | I | Lines/Ducts | | | | V9002.06 Seq 03 | | HYDRAULICS | Verify Configuration | |
| V58AG0.123-A | SUPPLY QD DEMATE INSPECTION | I | Lines/Ducts | | | | V9002.06 Seq 03 | | HYDRAULICS | Verify Configuration | |
| V58AG0.123-B | RETURN QD DEMATE INSPECTION | I | Lines/Ducts | | | | V9002.06 Seq 03 | | HYDRAULICS | Verify Configuration | |
| V41CB0.050-A | E1 MCC INJECTOR INSPECTION | EKSC | MCC | V1011.01 POSU 5 | V1294.008 Seq 02 | | V1038VL2 Seq 06 | | COMBUSTION | H2O or Contaminants in Acoustic Cavities | |
| V41CB0.065-A | E2 SSME NOZZLE BUMPER INSTALLATION | PLCL | Nozzle | S0028 Seq 19 | | | S0026 | V1038VL2 Seq 14 | COMBUSTION | Install Protective Bumpers for Ground Transport prior to STS Stack -> AR Manifold Impact, Thru-Crack -> Leakage to or Combined test demonstrates that the emergency shutdown PAV vent port seal is not leaking beyond acceptable limits. Also checks fuel purge and bleed valve solenoids and fuel Combined test demonstrates that the emergency shutdown solenoid vent port seal is not leaking beyond acceptable limits. Also the HPV poppet and shaft seals are verified. Performed only when combined test indicates excessive | |
| V41BQ0.090-A | E1 PCA FUEL SIDE INTERNAL LEAK TEST | EKSC, LRU | PCA | V1011.05 Seq 12 | V1294.002 Seq 10 | V1046.006 Seq 04 | V1011.06 Seq 03 | | | | |
| V41BQ0.091-A | E1 PCA LO2 SIDE INT/HPV ST/SFT SL LKG | EKSC, LRU | PCA | V1011.05 Seq 12 | V1294.002 Seq 10 | V1046.006 Seq 04 | V1011.06 Seq 03 | | | | |
| V41BQ0.092 | PCA LO2 SIDE/HPV LKG ISOLATION | F | PCA | | TBD | | | | | | |
| V41AS0.020-A | E1 PNEUMATIC CHECKOUT | EKSC, ER, LRU | Pneumatica | V1011.06 Seq 04 | V1294.002 Seq 11 | V1046.001 Seq 06 | | | ENGINE | Planned Preflight Checkout | |
| V41BU0.073-A | E1 PNEUMATIC VENT FLANGE VERIFICATION | TC, LRU | Pneumatica | | V1294.002 Seq 10 | | | | ENGINE | Flow Verification | |
| V41BU0.030-A | E1 COMPONENTS EXTERNAL INSPECTION | EKSC | System | V1011.02 Seq 04 | | | | | | Handling Damage, Clearance Checks, Loose Spot Welds on or Melts TP | |
| V41BU0.033 | FUEL SYSTEM LAJ INSPECTION | EKSC | System | V1011.02 Seq 04 | | | | | | | |
| V41BU0.380-A | E1 HELIUM BARRIER SYS INSPECTION | A, LRU | System | | | S1287 Seq 06 | V9018.002 Seq 07 | | DUCTS | Verify Bag Intact | |
| V41BU0.510-A | E1 SSME TO ORBITER GIMBAL CLEARANCE CHECK | ER, MOD, LRU | System | V1063 Seq 14 | | | | | DUCTS | Interference Check | |
| V41BU0.520-A | E1 GIMBAL CLEARANCE CHECK | ER, MOD, LRU | System | V1063 Seq 14 | | | | | | | |
| V41BU0.530-A | E1 SSME-TO-EMHS CLEARANCE CHECK | A | System | V41-50024 | | | | | | | |
| V41BW0.031-A | E1 PREPS FOR OFF ROLLOUT | A | System | V41-20003 | | | | | | | |
| V41BW0.034 | INSTL SSME STORAGE/SHIPPING COVERS | ERS | System | V5057 | | | | | | Defines the conditions governing use of the subject protective covers | |
| V41BW0.050 | OPENING CLOSEOUT COVERS | ERW | System | V5057 | | | | | | | |
| V41CB0.010 | SSME POSITIONING POST LANDING | PLCL | System | | V5057 | | S0026 | | | Minimize rain or other contaminants entry into the nozzle | |
| V41CB0.012-A | E1 HE BARRIER SYS INSPECTION POST FLIGHT | EKSC | System | V1263 Seq 04 | | V9018.002 Seq 07 | V1038VL2 Seq 06 | | DUCTS | Verify Bag Intact | |
| V41CB0.030 | FERRY FLIGHT SET INSTALLATION | FF | System | | | | V1038VL2 Seq 06 | | | | |
| V41CB0.080-D | ENGINE DRYING - 1ST PURGE (PHASE I) | EKSC | System | | V1294.008 Seq 04 | | | | COMBUSTION | Install Protective Covers, etc. for "Piggy-Back" Fly Controls the criteria used to perform engine drying operations following each flight. Pressures, temperatures, minimum durations and configurations are defined | |
| V41CB0.080-E | ENGINE DRYING - 2ND PURGE (PHASE II) | EKSC | System | | V1294.008 Seq 04 | | | | COMBUSTION | Controls the criteria used to perform engine drying operations following each flight. Pressures, temperatures, minimum durations and configurations are defined | |
| V41CB0.081 | DRYNESS VERIFICATION (PHASE II) | EKSC | System | | V1294.008 Seq 05 | | | | COMBUSTION | Requires a verification of dryness, defined by a maximum moisture criteria, to be performed following completion of drying | |
| V41AS0.030-A | E1 FRT CHECKOUT | EKSC, ER, LRU | Systems | V1011.06 Seq 06 | V1294.002 Seq 13 | V1046.001 Seq 08 | | | ENGINE | Planned Preflight Checkout | |
| V41AS0.030-D | E1 FRT PNEUMATIC SHUTDOWN SEQ DATA VERIF | EKSC, ER, LRU | Systems | V1011.06 Seq 08 | V1294.002 Seq 19 | V1046.001 Seq 13 | | | ENGINE | Planned Preflight Checkout | |
| V41BU0.130-A | E1 YAW MPS TVCA ALIGNMENT | LRU, IST | TVC | | TBD | | | | | | |
| V41BU0.130-B | E1 PITCH MPS TVCA ALIGNMENT | LRU, IST | TVC | | TBD | | | | | | |
| V41AS0.010-A | E1 ACTUATOR CHECKOUT | EKSC, ER, LRU | Valves | V1011.06 Seq 05 | V1294.002 Seq 12 | V1046.001 Seq 07 | | | ENGINE | Checked Preflight Checkout | |
| V41BQ0.040-A | E1 OXIDIZER PROP VLVS/PRG CN LEAK TEST | EKSC, I | Valves | V1011.05 Seq 09 | V1294.012 Seq 04 | V1046.004 Seq 04 | V1294.005 Seq 06 | | | Check Valve Failure - Contamination; STS-55 abort Investigation risk mitigation | |
| V41BQ0.041 | OXIDIZER PROP VLVS/PRG CV ISOLATION TEST | F | Valves | | V1294.012 Seq 04 | | | | | Isolation check if the V41BQ0.040-A leakage limits are exceeded | |
| V41BQ0.120-A | E1 LO2 PROP VALVE BALL SEAL LEAK TEST | EKSC, ER | Valves | V1011.05 Seq 07 | V1294.007 Seq 03 | V1046.003 Seq 04 | | | | Valve Leakage - LOX system integrity check | |
| V41BQ0.121 | LO2 PROP VALVE BALL LKG ISOLATION | F | Valves | | TBD | | | | | Isolation check if the V41BQ0.120-A leakage limits are exceeded | |
| V41BQ0.130 | RIV SHAFT SEAL LEAK TEST (TIME & CYCLE) | TC | Valves | | TBD | | | | | Valve Leakage | |
| V41BQ0.140-A | E1 RIV SEAT FLOW TEST | EKSC | Valves | V1011.05 Seq 06 | V1294.006 Seq 03 | V1046.003 Seq 06 | | | | Valve Leakage | |
| V41BQ0.141-A | E1 OVB SEAT LEAK TEST | EKSC, LRU | Valves | V1011.05 Seq 06 | V1294.006 Seq 03 | V1046.003 Seq 06 | | | | Valve Leakage | |
| V41BQ0.150-A | E1 OCV CHECK VALVE LEAK TEST | EKSC, LRU | Valves | V1011.05 Seq 08 | V1294.006 Seq 03 | V1046.003 Seq 06 | | | | Valve Leakage | |
| V41BQ0.180 | HPV CHECK VALVE LEAK TEST | TC | Valves | | TBD | | | | | Valve Leakage | |
| V41BQ0.190 | OPOV SLEEVE TEST & WINDOW CALIB | I, LRU | Valves | | V1294.002 Seq 14 | V5E17 Seq 09 | | | | Sets Open Loop Command % - Used to adjust start sequence | |
| V41BQ0.191 | FPOV SLEEVE TEST & WINDOW CALIB | I, LRU | Valves | | V1294.002 Seq 14 | V5E18 | | | | Sets Open Loop Command % - Used to adjust start sequence | |
| V41BU0.070-A | E1 AFT CLOSEOUT INSPECTION | A | Valves | | | S1287 OSSU 8 | | | | Final look before launch | |

Table 8. Engine requirements database (Continued).

| OMRSD NUMBER | OMRSD DESCRIPTION (V41 FILE III DATED 9/15/95) | OMRSD EFFECTIVITY | Component | OPF OMI's | ENGINE SHOP OMI's | VAB/PAD OMI's | OTHER OMI's | RT OMI's | SUBSYSTEM CODE | OMRSD RATIONALE/ROOT CAUSES | Root Cause Categories |
|--------------|--|-------------------|-----------------|-----------------|-------------------|------------------|------------------|-----------------|----------------|--|--|
| V41BL0.050 | SSME WELD 22 & 24 LEAK CHECK | PKSC, NRAT | HPOTP | V1011.05 Seq 07 | V1294.007 Seq 04 | V1046.003 Seq 07 | | | | Due to poor processing, HPOTP balance cavity standoff welds are leak checked -- No leaks ever verified, but lack of weld penetration up to 90% has been found on these welds. Standoffs have been suspected of leaking and caused return to Canoga | Air Compartment overpressurization or fire |
| V41BL0.060-A | E1 HPOTP PLUG WELD LEAK CHECK | PKSC, NRAT | HPOTP | V1011.05 Seq 09 | V1294.004 Seq 04 | V1046.004 Seq 04 | V1294.005 Seq 07 | | | Plug weld leak occurred on a unit -- Concern over these welds leaking either Gov/Helium/Hot gas into boattail -- therefore all external plug welds on the housing are checked | Air Compartment overpressurization or fire |
| V41AX0.020-A | E1 L02 FEED (JOINT 01) W/LK CK | ER, PR, OMDP | Lines/Ducts | V1011.05 Seq 07 | | V1046.003 Seq 05 | | | DUCTS | Ensure joint integrity of LPOTP to pump inlet ducting after engine is installed | Air Compartment overpressurization or fire |
| V41AX0.020-B | E1 LH2 FEED (JOINT F1) W/LK CK | ER, PR, OMDP | Lines/Ducts | V1011.05 Seq 05 | | V1046.002 Seq 04 | | | DUCTS | Verify pump inlet joint integrity after installing the LPFTF | Air Compartment overpressurization or fire |
| V41AX0.020-C | E1 GH2 PRESS (JOINT F0.3) W/LK CK | ER, PR, OMDP | Lines/Ducts | V1011.05 Seq 09 | | V1046.004 Seq 04 | | | DUCTS | Joint Integrity Post Engine Installation | Air Compartment overpressurization or fire |
| V41AX0.020-D | E1 L02 BLEED (JOINT 015) W/LK CK | ER, PR, OMDP | Lines/Ducts | V1011.05 Seq 07 | | V1046.003 Seq 05 | | | DUCTS | Joint Integrity Post Engine Installation | Air Compartment overpressurization or fire |
| V41AX0.020-E | E1 LH2 BLEED (JOINT F4.3) W/LK CK | ER, PR, OMDP | Lines/Ducts | V1011.05 Seq 05 | | V1046.002 Seq 04 | | | DUCTS | Joint Integrity Post Engine Installation | Air Compartment overpressurization or fire |
| V41AX0.020-F | E1 HELIUM (JOINT P1) W/LK CK | ER, PR, OMDP | Lines/Ducts | V1011.05 Seq 12 | | V1046.001 Seq 05 | V1046.006 Seq 04 | | DUCTS | Joint Integrity Post Engine Installation | Air Compartment overpressurization or fire |
| V41AX0.020-G | E1 GR2 (JOINT N1) W/LK CK | ER, PR, OMDP | Lines/Ducts | | | V1149 Seq 15 | V1046.006 Seq 03 | | DUCTS | Joint Integrity Post Engine Installation | Air Compartment overpressurization or fire |
| V41AX0.020-H | E1 HYD - PRESS (JOINT H1) W/LK CK | ER, PR, OMDP | Lines/Ducts | | V5E17 Seq 09 | | V5E18 | V9002.06 Seq 05 | DUCTS | Joint Integrity Post Engine Installation | Air Compartment overpressurization or fire |
| V41AX0.020-I | E1 HYD - RETURN (JOINT H17) W/LK CK | ER, PR, OMDP | Lines/Ducts | | V5E17 Seq 09 | | V5E18 | V5002.06 Seq 05 | DUCTS | Joint Integrity Post Engine Installation | Air Compartment overpressurization or fire |
| V41AX0.050-A | E1 G02 ORB/SSME INTERFACE FLANGE LEAK CHECK | A, ER | Lines/Ducts | | | V1046.005 Seq 05 | | | DUCTS | Joint Integrity Post Engine Installation | Air Compartment overpressurization or fire |
| V41BL0.031 | SSME ENCAPSULATION POWER HD LEAK CK | EKSC & ER | Powerhead | | V1294.007 Seq 04 | | | | ENGINE | System leak integrity check for launch - Mat.1 or Weld Thru-Crack; Seal not Sealed -> Crit. 1 | Air Compartment overpressurization or fire |
| V41BL0.032 | SSME ENCAPSULATION FUEL SYS ISO TEST | F | System | | V1294.007 Seq 04 | | | | ENGINE | System leak integrity check for launch - Mat.1 or Weld Thru-Crack; Seal not Sealed -> Crit. 1 | Air Compartment overpressurization or fire |
| V41BL0.033 | SSME ENCAPSULATION OXID SYS ISO TEST | F | System | | V1294.007 Seq 04 | | | | ENGINE | System leak integrity check for launch - Mat.1 or Weld Thru-Crack; Seal not Sealed -> Crit. 1 | Air Compartment overpressurization or fire |
| V41BL0.034 | SSME ENCAPSULATION HOT GAS SYS ISO TEST | F | System | | V1294.007 Seq 04 | | | | ENGINE | System leak integrity check for launch - Mat.1 or Weld Thru-Crack; Seal not Sealed -> Crit. 1 | Air Compartment overpressurization or fire |
| V41BP0.010-A | E1 G02/GCV EXT LK CK & ORIFICE VERIF | EKSC, I | Valves | V1011.04 Seq 07 | V1294.002 Seq 17 | V1046.005 Seq 05 | V1294.006 Seq 05 | | | Establishes leak test of all gaseous oxygen system joints from the APV to the orbiter interface on each flight basis | Air Compartment overpressurization or fire |
| V41AQ0.010-A | E1 SENSOR CHECKOUT | EKSC, ER, LRU | Instrumentation | V1011.06 Seq 02 | V1294.002 Seq 06 | V1046.001 Seq 04 | | V9001VL4 Seq 02 | AVIONICS | Planned Preflight Checkout | Erroneous shutdown, loss of vehicle |
| V41AU0.013-A | E1 OPERATIONAL INSTRUMENTATION VERIFICATION | A, ER | Instrumentation | | | V1046.001 Seq 04 | | V9001VL4 Seq 02 | AVIONICS | Instrumentation integrity checkout | Erroneous shutdown, loss of vehicle |
| V41BU0.250-A | E1 SENSOR IR VERIFICATIONS | EKSC, LRU | Instrumentation | V1011.02 Seq 07 | | | | | | Functional check of each turbine discharge temp | Erroneous shutdown, loss of vehicle |
| V41BP0.020-A | E1 HEX COIL LEAK TEST | A, EKSC, PLRU | HEX | V1011.04 Seq 02 | V1294.003 Seq 03 | V1046.005 Seq 06 | | | HEX | Mat.1 (gtringer) or Weld Thru-Crack; HPOTP installation Impact Hole -> HG to Tank Crit. 1 | Fire, Uncontained engine failure |
| V41BP0.030-A | SSME HEX COIL PROOF TEST | PLRU | HEX | V1011.04 Seq 03 | V1294.003 Seq 04 | V1046.005 Seq 07 | | | HEX | Mat.1 (gtringer) or Weld Thru-Crack; HPOTP installation Impact Hole -> HG to Tank Crit. 1 | Fire, Uncontained engine failure |
| V41BU0.066 | HEX EDDY CURRENT INSPECTIONS (TIME & CYCLE) | TC | HEX | V1011.02 Seq 11 | | | | | HEX | Thin Walls from Bracket Wear, Manuf -> Thru-Crack, HG Leakage to Tank, Crit. 1 | Fire, Uncontained engine failure |
| V41BU0.115 | HEAT EXCHANGER INSPECTION | TC | HEX | | V5E02 Seq 14 | | | | HEX | Visible Impact Damage, Bracket Wear -> Thru-Crack -> HG to Tank, Crit. 1, Turb. Vane Cracks -> Loss of Flow Impact M1 Post -> Damage or Crit. 1 | Fire, Uncontained engine failure |
| V41BU0.125 | HEX VISUAL INSPECTION | PLRU | HEX | | V5E02 Seq 12 | | | | HEX | HPOTP installation Impact Hole -> HG to Tank Crit. 1 | Fire, Uncontained engine failure |
| V41BU0.075-A | E1 HPFTP INTERNAL INSPECTION | PKSC | HPFTP | V1011.02 Seq 08 | | | | | TURBOPUMPS | Verify no inlet or discharge sheet metal cracking; no nozzle cracking or erosion; no blade cracking, platform cracking, or erosion; no fishmouth seal cracking or missing pieces; no bellows shield cracking. (All inspections completed with turbopump ins) | Fire, Uncontained engine failure |
| V41BU0.079 | HPFTP FIRST STAGE BLADE 22X INSPECTION | TC, DOE | HPFTP | | V5E06 Seq 14 | | | | TURBOPUMPS | Verify no blade cracking due to previous occurrences of air oil cracking | Fire, Uncontained engine failure |
| V41BU0.080 | HPFTP TURBINE INSPECTION (TIME & CYCLE) | PKSC | HPFTP | | V5E06 Seq 14 | | | | TURBOPUMPS | Verify no inlet or discharge sheet metal cracking including weld 450 and the turning vanes; no nozzle cracking or erosion; no blade cracking, platform cracking, or erosion; no fishmouth seal cracking or missing pieces; no bellows shield cracking via dy | Fire, Uncontained engine failure |
| V41BU0.087 | HPFTP BELLOW HEIGHT VERIF | PLRU | HPFTP | | V5E06 OSSU 2 | | | | TURBOPUMPS | Verify bellows height adequate to provide proper preload on the bellows at installation. incorporated as a result of a previous failure of the bellows. | Fire, Uncontained engine failure |

Table 8. Engine requirements database (Continued).

| OMRSD NUMBER | OMRSD DESCRIPTION (V41 FILE IN DATED Q16/95) | OMRSD EFFECTIVITY | Component | OPF OMI's | ENGINE SHOP OMI's | VAB/PAD OMI's | OTHER OMI's | RT OMI's | SUBSYSTEM CODE | OMRSD RATIONALE/ROOT CAUSES | Root Cause Categories |
|--------------|--|----------------------|-------------|-----------------|-------------------|------------------|------------------|----------|----------------|--|----------------------------------|
| V41C80.060-A | E1 HPFTP TURBINE BEARING DRYING | EKSC | HPFTP | V1011.01 Seq 03 | | V0018.002 Seq 04 | V1038VL2 Seq 07 | | TURBOPUMPS | Ensure all moisture is removed from the bearing area after a test/flight | Fire, Uncontained engine failure |
| V41B00.110-A | E1 HPOTP PRIMARY OXID SEAL LEAK TEST | PKSC, NRAT | HPOTP | V1011.05 Seq 07 | V1294.008 Seq 03 | V1046.003 Seq 07 | | | | Checks for excessive leakage of LOX/GOX from the HPOTP seal - Protects against excessive flow overcoming the barrier seal and from having excessive leakage losses during the chill down of the engine. Kel-F seal does wear during operation. | Fire, Uncontained engine failure |
| V41B50.040-A | E1 HPOTP TORQUE TEST | EKSC, RI, PLRU, NRAT | HPOTP | V1011.03 Seq 06 | V6E02 Seq 25 | | | | TURBOPUMPS | Done to ensure rotor is not bound up prior to start -- concern over contamination if high and also start characteristics if rotor is slow to spin -- contamination has been found around the rotor but only once enough to affect start (ruled P/E bearings) | Fire, Uncontained engine failure |
| V41B50.042 | HPOTP INVESTIGATIVE TORQUE | F, NRAT | HPOTP | V1011.03 Seq 06 | V6E02 Seq 25 | | | | TURBOPUMPS | Done only to run in a high torque pump to bring the torque value below spec requirements | Fire, Uncontained engine failure |
| V41B50.043-A | E1 HPOTP IMPELLER LOCK VERIF | PKSC, PLRU, NRAT | HPOTP | V1011.03 Seq 06 | V6E02 Seq 25 | | | | TURBOPUMPS | Locking feature was overcome on a HPOTP PBP impeller bolt lock during torque tests/spinning of pump for inspections. Recurrence control is to only turn the pump in the bolt tightening direction during inspections and to check the locking feature after it | Fire, Uncontained engine failure |
| V41B50.046 | HPOTP MICROSHAFT TRAVEL | PKSC, NRAT | HPOTP | V1011.03 Seq 06 | | | | | TURBOPUMPS | Turbine bearings have worn very quickly in past -- this measurement is to ensure that the bearings are still capable of 1 flight prior to a launch. | Fire, Uncontained engine failure |
| V41B00.110-A | E1 ATD BLOCK VNI HPOTP PRIMARY OXID SEAL LEAK TEST | PKSC, NHAT | HPOTP | V1011.05 Seq 07 | V1294.008 Seq 03 | V1046.003 Seq 07 | | | | This leak check was never performed during HPOTP/AT certification. The data obtained is erratic and is probably indicative of only gross seal imperfections (which would most likely be detected through torque checks). It is currently an OMRSD requirement | Fire, Uncontained engine failure |
| V41B00.065-A | E1 HPOTP INTERNAL INSPECTION | PKSC, NRAT | HPOTP | V1011.02 Seq 08 | | | | | TURBOPUMPS | Visual inspections of turbine hardware (shrouds/rotor/ blades) due to cracking and erosion seen in the past, of the main pump inlet / inducer due to cavitation damage and contamination found in the past, of the PBP impeller inlet due to locking test | Fire, Uncontained engine failure |
| V41B00.068-A | E1 HPOTP TIP SEAL RETAINER INSPECTION | PKSC, NRAT | HPOTP | | | | | | TURBOPUMPS | Verifies 1st stage tip seal retainer screws have not rotated. Could lead to blade failure. | Fire, Uncontained engine failure |
| V41B00.390-A | E1 LPFD OVALITY CHECK | F | Lines/Ducts | V1011.02 Seq 10 | | | V9018.002 Seq 10 | | DUCTS | Contingency test performed only when the LPFD helium barrier system has been damaged. Object is to detect potential duct collapse or separation from the layer of insulation by measuring the roundness of the duct. | Fire, Uncontained engine failure |
| V41B00.400 | PERFORM LPFD XRAY INSPECTION | F | Lines/Ducts | TBD | | | | | DUCTS | Contingency reqmt performed only when the ovality check indicates that some damage or collapse has occurred in the LPFD. The cross section is X-rayed in an attempt to verify presence of damage. | Fire, Uncontained engine failure |
| V41B50.090 | HPOTP/AT TORQUE TEST | EKSC, RI, PLRU | HPOTP | V1011.03 Seq 06 | V6E02 Seq 25 | | | | TURBOPUMPS | Replaced by V41B50.040-A | Fire, Uncontained engine failure |
| V41B50.065 | HPOTP/AT INVESTIGATIVE TORQUE | F | HPOTP | V1011.03 Seq 06 | V6E02 Seq 25 | | | | TURBOPUMPS | Replaced by V41B50.040-A | Fire, Uncontained engine failure |
| V41B00.405 | SSME LPFD TRIPOD LEGS INSPECTION | DOE | Lines/Ducts | TBD | | | | | DUCTS | Performed to insure LPFD structural integrity. Inspection is performed if post flight data evaluation reveals HPFTP unacceptable synchronous frequencies. | Fire, Uncontained engine failure |
| V41B00.065-A | E1 ATD BLOCK VNI HPOTP INTERNAL INSPECTION | PKSC, NRAT | HPOTP | V1011.02 Seq 08 | | | | | TURBOPUMPS | No HPOTP/AT internal inspections were made during certification. Inspections of the turbine, mainstage pump and PBP inlets, and all three bearings have been added only because the inspections aren't time consuming and because some "human error" could be | |
| V41B50.010-A | E1 LPDTP TORQUE TEST | A, RI, PSL, FR, PLRU | LPDTP | V1011.03 Seq 04 | | | | | TURBOPUMPS | Verify rotor is free to rotate prior to testing | Fire, Uncontained engine failure |
| V41B00.127 | HPOTP/AT PBP TIEBOLT LOCK INSPECTION | F | HPOTP | V1011.03 | | | | | TURBOPUMPS | | Fire, Uncontained engine failure |
| V41B00.128 | HPOTP/AT CONTAMINATION INSPECTION | A, PKSC | HPOTP | V1011.02 Seq 77 | | | | | TURBOPUMPS | | Fire, Uncontained engine failure |
| V41C80.085 | SSME HPOTP/TURBINE BEARING DRYING | PKSC | HPOTP | V1011.01 Seq 03 | V1294.008 Seq 04 | V0018.002 Seq 04 | | | TURBOPUMPS | Verify all moisture is removed from the bearing area after a test/flight. | Fire, Uncontained engine failure |
| V41B50.011 | LPFTP INVESTIGATIVE TORQUE | F | LPFTP | V1011.03 Seq 04 | | | | | TURBOPUMPS | Investigative torque check if the specification limits are exceeded - torque check failure generally ill-off seal binding or lily seal - copper plating risk | Fire, Uncontained engine failure |

Table 8. Engine requirements database (Continued).

| OMRSD NUMBER | OMRSD DESCRIPTION (V41 FILE #) DATED 9/15/95 | OMRSD EFFECTIVITY | Component | OPF OMI's | ENGINE SHOP OMI's | VAB/PAD OMI's | OTHER OMI's | RT OMI's | SUBSYSTEM CODE | OMRSD RATIONALE/ROOT CAUSES | Root Cause Categories |
|--------------|--|---------------------|---------------|-----------------|-------------------|------------------|-----------------|-----------------|----------------|---|----------------------------------|
| V41880.030-A | E1 LPOTP TORQUE TEST | A, RI, PI, ER, PLRU | LPOTP | V1011.03 Req 05 | V6033 | | | | TURBOPUMPS | Done to assure rotor is not bound up prior to start -> concerns about contamination of high and also start characteristics if rotor is slow to spin -> contamination has been found that bound the rotor and bearing wind-up can also routinely causes failure of | Fire, Uncontained engine failure |
| V41880.031 | LPOTP INVESTIGATIVE TORQUE | F | LPOTP | V1011.03 Req 05 | | | | | TURBOPUMPS | Performed to free the rotor if possible - done only if needed -> must make torque return to normal value or pump is returned | Fire, Uncontained engine failure |
| V41880.032-A | E1 LPOTP SHAFT TRAVEL | A, ER, PLRU | LPOTP | V1011.03 Req 05 | V6033 | | | | TURBOPUMPS | Bearing wear on LPOTP drive bearing must be monitored | Fire, Uncontained engine failure |
| V41880.040-A | E1 MAIN INJECTOR LOX PORT VACUUM DECAY | DLP | Main Injector | V1011.02 Req 08 | | | | | COMBUSTION | LOX Port integrity check - if cracked or detected Post Plugged & Plug Damaged -> Loss of Plug, Increase Damage to Post -> Loss of Post, CRI 1 | Fire, Uncontained engine failure |
| V41880.034-A | E1 MAIN INJECTOR LOX PORT BIASING | ENRC | Main Injector | V1011.02 Req 04 | | | | | COMBUSTION | Under Bias (ENI) -> Flow Erosion MCC RDG Wall -> Repair or CRI 1 Leak; Under Bias -> Combustion Performance Loss | Fire, Uncontained engine failure |
| V41880.185 | MCC ISOLATION LEAK TEST | F | MCC | | V1204.003 Req 08 | | | | COMBUSTION | Max. To Above @ 1.5bar AN -> Repair; UAI Performance Loss; CRI 2 to CRI 1 if increase. | Fire, Uncontained engine failure |
| V41880.240-A | E1 MCC LINER CAVITY DECAY CHECK | ENRC, LRU | MCC | | V1204.003 Req 08 | | | | COMBUSTION | Buret Diaphragm Damage, Internal Liner To Structure Thru-Crack | Fire, Uncontained engine failure |
| V41880.031-A | E1 MCC BONDLINE ULTRASONIC INSPECTION | ENRC | MCC | V1011.02 Req 05 | | | V1038VL2 Req 08 | | COMBUSTION | Internal Damage -> Emission, CRI 1; External Leak, UAI to CRI 1 | Fire, Uncontained engine failure |
| V41880.081-A | MCC INJECTOR INSPECTION WITH HPOTP REMOVED | PLRU | MCC | | V6008 Req 12 | | | | COMBUSTION | Inspect when HPOTP Removed | Fire, Uncontained engine failure |
| V41880.082-A | MCC INJECTOR INSPECTION WITH NPOTP REMOVED | PLRU | MCC | | V6008 Req 14 | | | | COMBUSTION | Inspect when NPOTP Removed | Fire, Uncontained engine failure |
| V41880.100-A | E1 THRUST CHAMBER NOZZLE LEAK TEST | ENRC | MCC/Nozzle | V1011.05 Req 08 | V1204.011 Req 08 | V1048.004 Req 04 | | V1038VL2 Req 08 | COMBUSTION | Crack or Hot Wall Thru-Crack; Degraded Liner-Mat/Liner Rebound -> Repair; UAI Performance Loss; CRI 2 to CRI 1 if increase. If no action required then data used to adjust engine performance predictions | Fire, Uncontained engine failure |
| V41880.210-A | E1 MCC TO NOZZLE SEAL LEAK TEST | ENRC, LRU, I | MCC/Nozzle | V1011.05 Req 08 | V1204.004 Req 03 | V1048.004 Req 08 | | | COMBUSTION | 0-16 Seal Thermal Degradation -> AN Compartment Leak, CRI 1 | Fire, Uncontained engine failure |
| V41880.187 | SEAL NOZZLE ENCAPSULATION LEAK TEST | F | Nozzle | | V1204.010 Req 03 | | | | COMBUSTION | Crack or Hot Wall Thru-Crack like Crown Erosion, Brazing Seal Ends -> Repair; UAI Performance Loss; CRI 2 to CRI 1 if increase. | Fire, Uncontained engine failure |
| V41880.363-D | NOZZLE VISUAL INSPECTION | ENRC | Nozzle | V1011.02 Req 05 | | | V1038VL2 Req 08 | | COMBUSTION | Erosion Tube Crowns -> Leakage up to CRI 1; Tube Bulges -> Trip HD Flow or Shock Wave -> Dph. Destruction NZ, CRI 1; Re-entry Annealing -> Mat.1 Degradation, Burnt -> CRI 1 | Fire, Uncontained engine failure |
| V41880.365-E | NOZZLE PARENT METAL DISCOLORATION INSPECTION | ENRC | Nozzle | V1011.02 Req 05 | | | V1038VL2 Req 08 | | COMBUSTION | Erosion Tube Crowns -> Leakage up to CRI 1; Tube Bulges -> Trip HD Flow or Shock Wave -> Dph. Destruction NZ, CRI 1; Re-entry Annealing -> Mat.1 Degradation, Burnt -> CRI 1 | Fire, Uncontained engine failure |
| V41880.081-D | FUEL SIDE TRANSFER TUBE INSPECTION | PLRU | Powerhead | | V6008 Req 12 | | | | COMBUSTION | Inspect when HPOTP Removed | Fire, Uncontained engine failure |
| V41880.082-D | OXIDIZER SIDE TRANSFER TUBE INSPECTION | PLRU | Powerhead | | V6002 Req 14 | | | | COMBUSTION | Inspect when NPOTP Removed | Fire, Uncontained engine failure |
| V41880.081-C | FUEL PREBURNER INSPECTION | PLRU | Preburner | | V6008 Req 12 | | | | COMBUSTION | Inspect when HPOTP Removed | Fire, Uncontained engine failure |
| V41880.081-D | FPB LINER INSPECTION | PLRU | Preburner | | V6008 Req 12 | | | | COMBUSTION | Inspect when HPOTP Removed | Fire, Uncontained engine failure |
| V41880.082-C | OXIDIZER PREBURNER INSPECTION | PLRU | Preburner | | V6002 Req 14 | | | | COMBUSTION | Inspect when NPOTP Removed | Fire, Uncontained engine failure |
| V41880.082-D | FPB LINER INSPECTION | PLRU | Preburner | | V6002 Req 14 | | | | COMBUSTION | Inspect when NPOTP Removed | Fire, Uncontained engine failure |
| V41880.085 | OXID FIB INJECTOR ELEMENT INSP | TC, MRP | Preburner | | V6002 Req 14 | | | | COMBUSTION | Damaged Pore Pinns, Loss of Pin -> Increase Damage to Post -> Loss of Post into Turbine, CRI 1 or Internal Leakage -> Overheat Turbine, CRI 1 | Fire, Uncontained engine failure |
| V41880.086 | SEAL FUEL FIB INJECTOR ELEMENT (INSP. IF ONE OR MORE PINS FOUND MISSING) | MRP | Preburner | TBD | | | | | COMBUSTION | Damaged Pore Pinns, Loss of Pin -> Increase Damage to Post -> Plug Post & Use of Loss of Post into Turbine, CRI 1 or Internal Leakage Overheat Turbine, CRI 1 | Fire, Uncontained engine failure |
| V41880.105 | FPB INJECTOR OXID POSTS INSP | TC | Preburner | | V6008 Req 12 | | | | COMBUSTION | Damaged Pore Pinns, Loss of Pin -> Increase Damage to Post -> Plug Post & Use of Loss of Post into Turbine, CRI 1 or Internal Leakage Overheat Turbine, CRI 1 | Fire, Uncontained engine failure |
| V41880.070 | FPB DIFFUSER INSPECTION | DCE | Preburner | TBD | | | | | COMBUSTION | Contingency reqmt performed to inspect for cracks in FPB diffuser. This reqmt will be invoked only if data evaluation of HPOTP turbine discharge temp deems it necessary | Fire, Uncontained engine failure |

Table 8. Engine requirements database (Continued).

| OMRSD NUMBER | OMRSD DESCRIPTION (V41 FILE III DATED 9/18/95) | OMRSD EFFECTIVITY | Component | OPF OMI's | ENGINE SHOP OMI's | VAB/PAD OMI's | OTHER OMI's | RT OMI's | SUBSYSTEM CODE | OMRSD RATIONALE/ROOT CAUSES | Root Cause Categories |
|--------------|--|-------------------|-------------------|-----------------|-------------------|------------------|-----------------|---------------|----------------|---|--|
| V41800.032 | OP9 FACEPLATE FLATNESS CHECKS | DCE | Preburner | | | | | | COMBUSTION | Integrity check after "POP" - "POP" Damage, Bowing (Indication of Braze Cracks -> Loss of Element into Turbine, Crit 1; of Internal Leakage -> Overheat Turbine, Crit | Fire, Uncontained engine failure |
| V41800.040-A | E1 COMPONENTS INTERNAL INSPECTION | EKSC | System | V1011.02 Seq 08 | | | | | | Boronace inspection of accessible engine areas without assembly | Fire, Uncontained engine failure |
| V41800.020-A | E1 ENVR CLOSURE INSTALLATION | EKSC | System | S0028 Seq 19 | | | S0025 | | | Insure that LPFD helium barrier system is functional to preclude cryopumping in the event of a launch scrub which can lead to a collapse of the duct | Fire, Uncontained engine failure |
| V41800.080 | RIV OVERRIDE SEALS LEAK TEST (TIME & CYCLE) | TC | Valves | TBD | | | | | | Periodic (every 10 starts). To verify that the RIV shaft seals maintain override opening pressure within the RIV | Fire, Uncontained engine failure |
| V41800.100 | AFV SEAT AND SHAFT SEAL LEAKAGE | A, RP | Valves | V1011.04 Seq 07 | | V1046.005 Seq 05 | | | | No LOX in HEX prestart - Crit 1 | Fire, Uncontained engine failure |
| V41800.101 | AFV SHAFT AND SEAT ISOLATION | F | Valves | V1011.04 Seq 07 | | V1046.005 Seq 05 | | | | Isolation check if the V41800.100 leakage limits are exceeded | Fire, Uncontained engine failure |
| V41800.170-A | E1 PROP VALVE ACT PNEU SEAL LEAK TEST | EKSC, LRU | Valves | V1011.05 Seq 12 | V1294.002 Seq 10 | V1046.005 Seq 04 | V1011.05 Seq 03 | VSE17 Seq 09 | | Valve/Seal Leakage - LRU Integrity Check | Fire, Uncontained engine failure |
| V41800.171 | PROP VALVE ACT PNEU SEAL ISO TEST | F | Valves | TBD | | | | | | Isolation check if the V41800.170-A leakage limits are exceeded | Fire, Uncontained engine failure |
| V41800.030-A | E1 AFV CRACKING PRESSURE TEST | EKSC, LRU | Valves | V1011.04 Seq 07 | V1294.002 Seq 17 | V1046.005 Seq 05 | | | | Verify proper AFV operation - Crit 1 | Fire, Uncontained engine failure |
| V41800.220-A | AFV FILTER INSPECTIONS | A | Valves | V1011.04 POSU 5 | V1294.002 POSU 6 | V1046.005 POSU 2 | | | | Contamination check to verify that filter is not plugged which could lead to a collapse of the HEX | Fire, Uncontained engine failure |
| V41800.220-D | AFV FILTER REPLACEMENT | A | Valves | V1011.04 Seq 07 | | V1046.005 Seq 05 | V5005 POSU 3 | V5087 Task 28 | | Contamination check to verify that filter is not plugged which could lead to a collapse of the HEX | Fire, Uncontained engine failure |
| V41800.010-A | E1 FUEL TP L/Q/M/FV BALL SEAL LK TEST | EKSC, ER | HPFTP, LPFTP, MFV | V1011.05 Seq 05 | V1294.007 Seq 03 | V1046.002 Seq 03 | | | | Verify no LPFTP or HPFTP lift-off seal carbon nose leakage or main fuel valve ball seal leakage. (Fuel system pressurized, measure leakage into hot gas system) | Hazardous gas buildup |
| V41800.011 | FUEL TP L/Q/M/FV SEALS ISOLATION TEST | F | HPFTP, LPFTP, MFV | TBD | | | | | | Isolation check if the V41800.010-A leakage limits are exceeded | Hazardous gas buildup |
| V41800.020-A | E1 FUEL TP PIST/AFLEX/MFV LK CK | EKSC | HPFTP, LPFTP, MFV | V1011.05 Seq 05 | V1294.005 Seq 03 | V1046.002 Seq 06 | | | | Verify no LPFTP or HPFTP large diameter secondary seal leakage or Helix or MFV leakage (Fuel system pressurized, measure leakage out of the fuel component drain) | Hazardous gas buildup |
| V41800.021 | FUEL TP PIST/AFLEX/MFV ISO TEST | F | HPFTP, LPFTP, MFV | V1011.05 Seq 05 | V1294.005 Seq 03 | V1046.002 Seq 06 | | | | Isolation check if the V41800.020-A leakage limits are exceeded | Hazardous gas buildup |
| V41800.050-A | E1 COMB HOT GAS SYS SEAL LEAK TEST | EKSC, LRU | System | V1011.05 Seq 09 | V1294.005 Seq 06 | V1046.004 Seq 04 | | | | Verify no LPFTP or HPFTP small diameter secondary seal leakage or other system leakages (Hot gas system pressurized, measure leakage out of the fuel component drain) | Hazardous gas buildup |
| V41800.040-B | E2 HPFTP IMPELLER LOCK VERIFY | PKSC, PIRU, NRAT | | V1011.03 Seq 06 | V5E02 Seq 25 | | | | TURBOPUMPS | | |
| V41800.040-C | E2 HPFTP IMPELLER LOCK VERIFY | PKSC, PIRU, NRAT | | V1011.03 Seq 06 | V5E02 Seq 25 | | | | TURBOPUMPS | | |
| V41800.051 | SSME HOT GAS SYS SEAL LK ISO TEST | F | System | TBD | | | | | | Isolation check if the V41800.050-A leakage limits are exceeded | Hazardous gas buildup |
| V41800.052-A | E1 SSME COMB HOT GAS TO FUEL SYS REV LK CK | PKSC | System | V1011.05 Seq 09 | V1294.005 Seq 06 | V1046.004 Seq 04 | | | | Verify no reverse LPFTP or HPFTP carbon nose leakage (Hot gas system pressurized, measure leakage into fuel system) Incorporated when the pump and to turbine end leak check did not detect existing carbon nose leakage. | Hazardous gas buildup |
| V41800.053 | SSME HOT GAS REVERSE ISO LK CK | F | System | TBD | | | | | | Isolation check if the V41800.052-A leakage limits are exceeded | Hazardous gas buildup |
| V41800.030-A | E1 FUEL BLEED VALVE SEAT LEAK TEST | EKSC, LRU | Valves | V1011.05 Seq 04 | V1294.005 Seq 03 | V1046.002 Seq 05 | | | | Valve Leakage Check | Hazardous gas buildup |
| V41800.030-B | E2 COMPONENTS EXTERNAL INSPECTION | EKSC | | V1011.02 Seq 04 | | | | | | Handling Damage, Clearance Checks, Loose Spot Welds on or Matted TPS | |
| V41800.030-C | E3 COMPONENTS EXTERNAL INSPECTION | EKSC | | V1011.02 Seq 04 | | | | | | Handling Damage, Clearance Checks, Loose Spot Welds on or Matted TPS | |
| V41800.032 | FUEL BLEED VALVE BELLOW LEAK TEST | LRU | Valves | V1011.05 Seq 10 | V1294.005 Seq 03 | V1046.002 Seq 07 | | | | LRU - Remove and replace verification | Hazardous gas buildup |
| V41800.031-B | E2 MCC BONDLINE ULTRASONIC INSPECTION | EKSC | | V1011.02 Seq 05 | | | V1038VL2 Seq 08 | | COMBUSTION | Internal Debonds -> Emulsion, Crit 1; External Leak, UAI to Crit 1 | |
| V41800.031-C | E3 MCC BONDLINE ULTRASONIC INSPECTION | EKSC | | V1011.02 Seq 05 | | | V1038VL2 Seq 08 | | COMBUSTION | Internal Debonds -> Emulsion, Crit 1; External Leak, UAI to Crit 1 | |
| V41800.034 | OXID BLEED VALVE BELLOW LEAK TEST | LRU | Valves | V1011.05 Seq 11 | V1294.006 Seq 03 | V1046.003 Seq 09 | | | | LRU - Remove and replace verification | Hazardous gas buildup |
| V41800.020-A | E1 HPFTP TORQUE TEST | A, R, PIRU | HPFTP | V1011.03 Seq 09 | V5E06 OSSU 1 | | | | TURBOPUMPS | Verify the rotor is free to rotate prior to testing | Improper start, Ox rich resulting in engine fire |
| V41800.021 | HPFTP INVESTIGATIVE TORQUE | F | HPFTP | V1011.03 Seq 09 | V5E06 OSSU 1 | | | | TURBOPUMPS | Investigative torque check if the specification limits are exceeded | Improper start, Ox rich resulting in engine fire |

Table 8. Engine requirements database (Continued).

| OMR&D NUMBER | OMR&D DESCRIPTION (V41 FILE IN DATED 9/16/05) | OMR&D EFFECTIVITY | Component | OPF OMI's | ENGINE SHOP OMI's | VAB/PAD OMI's | OTHER OMI's | RT OMI's | SUBSYSTEM CODE | OMR&D RATIONALE/ROOT CAUSES | Root Cause Categories |
|--------------|---|-------------------|-----------------|-----------------|--------------------------|-------------------|-----------------|-----------------|----------------|--|--|
| V41AL0.010-A | E1 GIMBAL ELECTRICAL BONDING TEST | I, ER | Avionics | | | | V5005 Seq 06 | | AVIONICS | Verifies proper electrical grounding conditions exist between the SSME gimbal bearing and the orbiter structure. Test performed each time the bonding straps are disturbed. | Unscheduled Maintenance Action or Launch Delay |
| V41AL0.020-A | E1 ELECTRICAL INTERFACE PANEL BONDING TEST | I, ER | Avionics | | | | V5005 Seq 06 | | AVIONICS | Verifies proper electrical grounding conditions exist between the SSME electrical interface panel and the orbiter structure. Test performed each time the bonding straps are disturbed. | Unscheduled Maintenance Action or Launch Delay |
| V41AL0.030-A | E1 SSME/TVC ELECTRICAL BONDING TEST | A, I, ER | Avionics | | | S1287 OSSU 3 | | | AVIONICS | Verifies proper electrical grounding conditions exist between the SSME TVO actuator attach points and the orbiter structure. Test performed each time the bonding straps are disturbed. | Unscheduled Maintenance Action or Launch Delay |
| V41AN0.010-A | E1 SSME CONTROLLER POWER APPLICATION | A, ER | Avionics | | | | | V9001VL4 Seq 02 | AVIONICS | Defines the proper sequencing of cockpit switches for application of SSME controller power as well as the values of the monitored response. Identifies the constraints for cooling air and FACOS power. | Unscheduled Maintenance Action or Launch Delay |
| V41AN0.020-A | E1 AC POWER REDUNDANCY VERIFICATION | A, ER | Avionics | | | V1046.001 Seq 04 | | V9001VL4 Seq 02 | AVIONICS | Provides for SSME AC power redundancy verification while controllers are under power/ load. | Unscheduled Maintenance Action or Launch Delay |
| V41AN0.022-A | E1 CONTROLLER POWER SUPPLY REDUNDANCY VERIF | A, LRU | Avionics | V1011.06 Seq 02 | V1294.002 Seq 08 | V1046.001 Seq 04 | | V9001VL4 Seq 09 | AVIONICS | Performs a redundancy verification of the SSME controller power supplies. Controller channels A&C and B&C are verified. This procedure also verifies the backup memory power is functional and verifies the AC supplied +10 V reference diode. | Unscheduled Maintenance Action or Launch Delay |
| V41AN0.023-A | E1 CONTROLLER 28V MEMORY TEST | LRU | Avionics | | V1294.002 Seq 03 | | | | AVIONICS | Verifies the capability of the 28 volt DC and battery systems are holding up the controller memory. | Unscheduled Maintenance Action or Launch Delay |
| V41AN0.035-A | E1 COMMANDED CONTROLLER CHECKOUT | A, ERL, LRU | Avionics | V1011.06 Seq 02 | V1294.002 Seq 07 | V1046.001 Seq 04 | | V9001VL4 Seq 09 | AVIONICS | Controller Changeout Verification. Functional hardware and software checkout. | Unscheduled Maintenance Action or Launch Delay |
| V412A0.010 | SSME HARNESS REPLACEMENT RETEST | LRU | Avionics | | V5E02 Seq 27 | | | | AVIONICS | Defines the continuity and insulation resistance tests to be performed on any replacement harness installed on an engine | Unscheduled Maintenance Action or Launch Delay |
| V72A00.020-A | E1U 1 READINESS TEST | A, LRU | Avionics | | | | V9001VL4 Seq 02 | | AVIONICS | | Unscheduled Maintenance Action or Launch Delay |
| V41AU0.060-A | E1 GIMBAL BEARING SENSOR CHANNELIZATION VERIF | ER, LRU | Instrumentation | | | V1046.001 Seq 12 | | V9001VL4 Seq 02 | AVIONICS | Instrumentation integrity checkout | Unscheduled Maintenance Action or Launch Delay |
| V41AU0.090-A | E1 POST-FLT STRAIN GAGE CHECKOUT | A, EKSC | Instrumentation | V1011.02 Seq 04 | | | | | AVIONICS | Part of this check is Weld #3 Strain Gage checkout -- needed to ensure electrical continuity of gage after bond is assured | Unscheduled Maintenance Action or Launch Delay |
| V41AU0.090-D | E1 POST-FLIGHT SENSOR CHECKOUT | A, EKSC | Instrumentation | | | | | V9001VL4 Seq 02 | AVIONICS | Instrumentation integrity checkout | Unscheduled Maintenance Action or Launch Delay |
| V41AU0.016-A | E1 MADS INSTRUMENTATION VERIFICATION | A, ER | Instrumentation | | | V1046.001 Seq 13 | | V9001VL4 Seq 02 | AVIONICS | Instrumentation integrity checkout | Unscheduled Maintenance Action or Launch Delay |
| V41AU0.020-A | E1 SKIN TEMP CHANNELIZATION VERIFICATION | ER, LRU | Instrumentation | V1011.06 Seq 08 | V1294.002 PGSU 11 | V1046.001 Seq 13 | | | AVIONICS | Instrumentation integrity checkout | Unscheduled Maintenance Action or Launch Delay |
| V41AU0.042-A | E1 HPOTP STRAIN GAGE DEBOND TEST | A, PLRU, I, NRAT | Instrumentation | | V5E02 Seq 27 & V1294.002 | | | | AVIONICS | Weld #3 Strain gage in place to detect uneven bearing wear -- debond test needed to ensure acceptable data on next flight | Unscheduled Maintenance Action or Launch Delay |
| V41AP0.020-A | E1 MPVA PRI HEATER POWER ON COMMAND | I | Valves | | | | | | AVIONICS | Changeout Verification | Unscheduled Maintenance Action or Launch Delay |
| V41AP0.020-D | E1 MPVA SEC HEATER POWER ON COMMAND | I | Valves | | | | | | AVIONICS | Changeout Verification | Unscheduled Maintenance Action or Launch Delay |
| V41BU0.351-A | E1 POST FLIGHT MCC LINER POLISHING | EKSC | MCC | V1011.02 Seq 05 | | | V1038VL2 Seq 08 | | COMBUSTION | Remove Liner Roughness from Intense Environ. -> Erosion -> Leakage, Performance Loss | Unscheduled Maintenance Action or Performance loss |
| V41BU0.352-A | E1 PRELAUNCH MCC LINER POLISHING | A | MCC | | | S1287 OSSU 9 | | | COMBUSTION | Remove Surface Oxidation -> Erosion -> Leakage, Performance Loss | Unscheduled Maintenance Action or Performance loss |
| V41BU0.093 | HGM FUEL SIDE DYE PEN INSP (PHASE II) | TC | Powerhead | | V5E06 Seq 12 | | | | COMBUSTION | Liner Mat.1 & Transfer Tube Weld Thru-Cracks -> By-pass Flow Performance Loss | Unscheduled Maintenance Action or Performance loss |
| V41BU0.096 | HGM OXID SIDE DYE PEN INSP (PHASE II) | TC | Powerhead | | V5E02 Seq 14 | | | | COMBUSTION | Liner Mat.1 & Transfer Tube Weld Thru-Cracks -> By-pass Flow Performance Loss | Unscheduled Maintenance Action or Performance loss |
| V41BU0.097 | HGM FUEL SIDE DYE PEN INSP (PHASE II+) | TC | Powerhead | | V5E06 Seq 12 | | | | COMBUSTION | Liner Mat.1 & Transfer Tube Weld Thru-Cracks -> By-pass Flow Performance Loss | Unscheduled Maintenance Action or Performance loss |
| V41BU0.098 | HGM OXID SIDE DYE PEN INSP (PHASE II+) | TC | Powerhead | | V5E02 Seq 14 | | | | COMBUSTION | Liner Mat.1 & Transfer Tube Weld Thru-Cracks -> By-pass Flow Performance Loss | Unscheduled Maintenance Action or Performance loss |
| V72AQ0.040-A | VERIFY SSME 1/EIU 1 COMMAND PATH | A, LRU | Avionics | | | | V9001VL4 Seq 02 | | AVIONICS | | |
| V72AQ0.050-A | VERIFY SSME 1/EIU 1 STAT CHANNEL PATH | A, LRU | Avionics | | | | V9001VL4 Seq 02 | | AVIONICS | | |
| V72AQ0.060-A | E1U 1 FM SYSTEM INTERFACE DATA | LRU | Avionics | | | S0017VL 13 Seq 42 | | | AVIONICS | | |

Table 8. Engine requirements database (Continued).

| OMRSD NUMBER | OMRSD DESCRIPTION (V41 FILE III DATED 8/15/85) | OMRSD EFFECTIVITY | Component | OPF OMI's | ENGINE SHOP OMI's | VAR/PAD OMI's | OTHER OMI's | RT OMI's | SUBSYSTEM CODE | OMRSD RATIONALE/ROOT CAUSES | Root Cause Categories |
|--------------|--|-------------------|-------------|-----------------|-------------------|------------------|------------------|-----------------|----------------|--|-----------------------|
| V72AW.038-A | E11 POWER REDUNDANCY VERIFICATION | A, LRU | Avionics | | | | V001V14 Sec 02 | | AVIONICS | | |
| V418U.430-A | E1 HEAT SHIELD BLANKET INSPECTION | A | Heat Shield | | | 81287 Sec 04 | | | HEAT SHIELD | Thermal Deformation -> Aft Leak to Atmosphere -> Critic 17 | |
| V418U.421-A | E1 EMWB INSPECTION | A | Heat Shield | V41-40018 | | | | | HEAT SHIELD | | |
| V418U.090 | HYDRAULIC DRAIN LINE INSPECTION (TIME & CYCLE) | TC | Lines/Ducts | | V1284.002 Sec 10 | V1048.001 Sec 13 | | | HYDRAULIC | Periodic inspection (every 10 tests) of hydraulic actuators/shaft seals | |
| V88AG.121-A | SUPPLY QD PRE-MATE INSPECTION | I | Lines/Ducts | | | | V8002.08 Sec 03 | | HYDRAULICS | Verify Configuration | |
| V88AG.121-B | RETURN QD PRE-MATE INSPECTION | I | Lines/Ducts | | | | V8002.08 Sec 03 | | HYDRAULICS | Verify Configuration | |
| V88AG.123-A | SUPPLY QD DE-MATE INSPECTION | I | Lines/Ducts | | | | V8002.08 Sec 03 | | HYDRAULICS | | |
| V88AG.123-B | RETURN QD DE-MATE INSPECTION | I | Lines/Ducts | | | | V8002.08 Sec 03 | | HYDRAULICS | | |
| V41C80.089-A | E1 MCC INJECTOR INSPECTION | EK8C | MCC | V1011.01 PO8U 5 | V1284.008 Sec 02 | | V1028VL2 Sec 08 | | HYDRAULICS | | |
| V41C80.089-A | E2 88ME NOZZLE BUMPER INSTALLATION | PLCL | Nozzle | 88025 Sec 10 | | | 80026 | V1028VL2 Sec 14 | COMBUSTION | H2O or Contaminants In Acoustic Coviler Install Protective Bumpers for Ground Transport prior to STS Stack -> All Manifold Impact, Thru-Crack -> Leakage to or from Crit. 1 | |
| V41808.089-A | E1 PCA FUEL SIDE INTERNAL LEAK TEST | EK8C, LRU | PCA | V1011.08 Sec 12 | V1284.002 Sec 10 | V1048.008 Sec 04 | V1011.08 Sec 03 | | | Combined test demonstrates that the emergency shutdown PAV vent port seal is not leaking beyond acceptable limits. Also checks fuel purge and bleed valve solenoids and fuel purges PAV. | |
| V41808.081-A | E1 PCA LO2 SIDE INT/HPV BY/FT BL LAD | EK8C, LRU | PCA | V1011.09 Sec 12 | V1284.002 Sec 10 | V1048.008 Sec 04 | V1011.08 Sec 03 | | | Combined test demonstrates that the emergency shutdown solenoid vent port seal is not leaking beyond acceptable limits. Also the HPV poppet and shaft seal are tested. | |
| V41808.092 | PCA LO2 SIDE/HPV LKG ISOLATION | F | PCA | T80 | | | | | | Performed only when combined test indicates excessive leakage. | |
| V41802.029-A | E1 PNEUMATIC CHECKOUT | EK8C, ER, LRU | Pneumatics | V1011.09 Sec 04 | V1284.002 Sec 11 | V1048.001 Sec 06 | | | ENGINE | Passport Preflight Checkout | |
| V41808.073-A | E1 PNEUMATIC VENT FLANGE VERIFICATION | TC, LRU | Pneumatics | | V1284.002 Sec 10 | | | | | Flow Verification | |
| V41808.030-A | E1 COMPONENTS EXTERNAL INSPECTION | EK8C | System | V1011.02 Sec 04 | | | | | | Heading Damage, Clearance Checks, Loose Spot Welds on or Mated TFS | |
| V418U.033 | FUEL SYSTEM LAM INSPECTION | EK8C | System | V1011.02 Sec 04 | | | | | | | |
| V41808.388-A | E1 HELIUM BARRIER BYB INSPECTION | A, LRU | System | | | 81287 Sec 06 | V8018.002 Sec 07 | | DUCTS | Verify Bag Intact | |
| V41808.810-A | E1 88ME TO DRIBBLER GIBBAL CLEARANCE CHECK | ER, MDD, LRU | System | V1063 Sec 14 | | | | | | Interference Check | |
| V41808.828-A | E1 GIBBAL CLEARANCE CHECK | ER, MDD, LRU | System | V1063 Sec 14 | | | | | | | |
| V41808.829-A | E1 88ME TO EMWB CLEARANCE CHECK | A | System | V41-20024 | | | | | | | |
| V41808.031-A | E1 PREP FOR OFF BOLLOUT | A | System | V41-20033 | | | | | HEAT SHIELD | Verifies that the engine is configured for together from the OPF. TVC actuator locks restrain engine movements and covers protect against contamination. | |
| V418W.034 | INBTL 88ME STORAGE/SHIPPING COVERS | ER8 | System | V8057 | | | | | | Defines the conditions governing use of the subject protective covers | |
| V418W.080 | OPENING CLOSET/OUT COVERS | ENV | System | V8057 | | | | | | | |
| V41C80.510 | 88ME POSITIONING POST LANDING | PLCL | System | | | | 80026 | | | Minimize rain or other contaminants entry into the 88ME | |
| V41C80.012-A | E1 HE BARRIER BYB INSPECTION POST FLIGHT | EK8C | System | V1283 Sec 04 | | | V8018.002 Sec 07 | V1028VL2 Sec 06 | DUCTS | Verify Bag Intact | |
| V41C80.030 | FERRY FLIGHT RET INSTALLATION | FF | System | | | | | V1038VL2 Sec 06 | | Install Protective Covers, etc. for "Plug-&Fly" | |
| V41C80.080-D | ENGINE DRYING - 18T PURGE (PHASE II) | EK8C | System | | V1284.008 Sec 04 | | | | COMBUSTION | Controls the criteria used to perform engine drying operations following each flight. Pressures, temperatures, minimum durations and configurations are defined. | |

Table 8. Engine requirements database (Continued).

| OMRSD NUMBER | OMRSD DESCRIPTION (V41 FILE IN DATED 9/15/05) | OMRSD EFFECTIVITY | Component | OPF OMI's | ENGINE SHOP OMI's | VAB/PAD OMI's | OTHER OMI's | RT OMI's | SUBSYSTEM CODE | OMRSD RATIONALE/ROOT CAUSES | Root Cause Categories |
|--------------|---|-------------------|-----------|-----------------|-------------------|------------------|------------------|----------|----------------|---|-----------------------|
| V41C80.030-E | ENGINE DRYING - 2ND PURGE (PHASE II) | EKSC | System | | V1294.003 Seq 04 | | | | COMBUSTION | Controls the criteria used to perform engine drying operations following each flight. Pressures, temperatures, minimum durations and configurations are defined | |
| V41C80.081 | DRYNESS VERIFICATION (PHASE II) | EKSC | System | | V1294.003 Seq 05 | | | | COMBUSTION | Requires a verification of dryness, defined by a maximum moisture criteria, to be performed following completion of drying operation | |
| V41AS0.030-A | E1 FRF CHECKOUT | EKSC, ER, LRU | Systems | V1011.06 Seq 06 | V1294.002 Seq 13 | V1046.001 Seq 08 | | | ENGINE | Planned Preflight Checkout | |
| V41AS0.030-D | E1 FRF PNEUMATIC SHUTDOWN SEQ DATA VERIFY | EKSC, ER, LRU | Systems | V1011.06 Seq 08 | V1294.002 Seq 18 | V1046.001 Seq 13 | | | ENGINE | Planned Preflight Checkout | |
| V41B00.130-A | E1 YAW MPS TVCA ALIGNMENT | LRU, IST | TVC | TBD | | | | | | | |
| V41B00.130-B | E1 PITCH MPS TVCA ALIGNMENT | LRU, IST | TVC | TBD | | | | | | | |
| V41AS0.010-A | E1 ACTUATOR CHECKOUT | EKSC, ER, LRU | Valves | V1011.06 Seq 05 | V1294.002 Seq 12 | V1046.001 Seq 07 | | | ENGINE | Planned Preflight Checkout | |
| V41B00.040-A | E1 OXIDIZER PROP VLV/PRG CV LEAK TEST | EKSC, I | Valves | V1011.05 Seq 09 | V1294.012 Seq 04 | V1046.004 Seq 04 | V1294.005 Seq 06 | | | Check Valve Failure - Contamination; STS-05 abort investigation/risk mitigation | |
| V41B00.041 | OXIDIZER PROP VLV/PRG CV ISOLATION TEST | F | Valves | | V1294.012 Seq 04 | | | | | Isolation check if the V41B00.040-A leakage limits are exceeded | |
| V41B00.120-A | E1 LO2 PROP VALVE BALL SEAL LEAK TEST | EKSC, ER | Valves | V1011.05 Seq 07 | V1294.007 Seq 03 | V1046.003 Seq 04 | | | | Valve Leakage - LOX system integrity check | |
| V41B00.121 | LO2 PROP VALVE BALL LKG ISOLATION TEST | F | Valves | TBD | | | | | | Isolation check if the V41B00.120-A leakage limits are exceeded | |
| V41B00.130 | RIV SHAFT SEAL LEAK TEST (TIME & CYCLE) | TC | Valves | TBD | | | | | | Valve Leakage | |
| V41B00.140-A | E1 RIV SEAT FLOW TEST | EKSC | Valves | V1011.05 Seq 06 | V1294.006 Seq 03 | V1046.003 Seq 06 | | | | Valve Leakage | |
| V41B00.141-A | E1 ORV SEAT LEAK TEST | EKSC, LRU | Valves | V1011.05 Seq 06 | V1294.006 Seq 03 | V1046.003 Seq 06 | | | | Valve Leakage | |
| V41B00.150-A | E1 OGV CHECK VALVE LEAK TEST | EKSC, LRU | Valves | V1011.04 Seq 06 | V1294.006 Seq 03 | V1046.003 Seq 06 | | | | Valve Leakage | |
| V41B00.180 | HPV CHECK VALVE LEAK TEST | TC | Valves | TBD | | | | | | Valve Leakage | |
| V41B00.190 | DPOV SLEEVE TEST & WINDOW CALIB | I, LRU | Valves | | V1294.002 Seq 14 | V5E17 Seq 09 | | | | Sets Open Loop Command % - Used to adjust start sequence | |
| V41B00.191 | FPOV SLEEVE TEST & WINDOW CALIB | I, LRU | Valves | | V1294.002 Seq 14 | V5E18 | | | | Sets Open Loop Command % - Used to adjust start sequence | |
| V41B00.070-A | E1 AFT CLOSEOUT INSPECTION | A | Valves | | | S1287 OSSU 8 | | | | Final look before launch | |

APPENDIX B—Scheduled SSME Operations Data

The following spreadsheets present the detailed data collection from SSME processing experience at KSC relative to scheduled activities. Tables 9–12 present the *summary information* relative to figures 6 through 9. Following that, the specific processing tasks for the four flows appear in tables 13–16. Finally, an example of the existing level of detail supporting the flow layouts is presented in table 17. Note also that a zero in a work column only reflects that no engine processing personnel are required for that task.

Table 9. OPF SSME postflight planned operations.*

| OMRBD NUMBE R | OMRBD DESCRIPTION (V41 FILE III DATED 8/1/99) | OMRBD EFFECTIVITY | Component | OPF OMI's | ENGINE SHOP OMI's | VAB/PAD OMI's | OTHER OMI's | RT OMI's | SUBSYSTEM CODE | OMRBD RATIONALE/ROOT CAUSES | Root Cause Categories |
|---------------|---|-------------------|-----------------|-----------------|-------------------|------------------|------------------|-----------------|----------------|---|---|
| V41BL0.060 | 88ME WELD 22 & 24 LEAK CHECK | PK8C, NRAT | HPOTP | V1011.06 Req 07 | V1264.007 Req 04 | V1046.003 Req 07 | | | | Due to poor proofing, HPOTP balance cavity stand-off welds are leak checked -- No leaks ever verified, but lack of weld penetration up to 90% has been found on these welds. Standoffs have been suspected of leaking and caused return to Camp. | AR Component overpressurization or fire |
| V41BL0.060-A | E1 HPOTP PLUG WELD LEAK CHECK | PK8C, NRAT | HPOTP | V1011.06 Req 09 | V1264.004 Req 04 | V1046.004 Req 04 | V1264.005 Req 07 | | | Plug weld leak occurred on a URH -- Concern over these welds being silver coated/insulated gas into bellows -- to ensure all external plug welds on the housing are checked. | AR Component overpressurization or fire |
| V41AX0.020-A | E1 LQ2 FEED (JOINT 01) UP LK CK | ER, PR, OMDP | Lines/Ducts | V1011.06 Req 07 | | V1046.003 Req 06 | | | DUCTS | Ensure joint integrity of LPOTP to pump inlet during start of engine as installed. | AR Component overpressurization or fire |
| V41AX0.020-B | E1 LQ2 FEED (JOINT P1) UP LK CK | ER, PR, OMDP | Lines/Ducts | V1011.06 Req 06 | | V1046.003 Req 04 | | | DUCTS | Verify pump inlet joint integrity after installing the LPOTP. | AR Component overpressurization or fire |
| V41AX0.020-C | E1 Q18 PRESS (JOINT P0.3) UP LK CK | ER, PR, OMDP | Lines/Ducts | V1011.06 Req 08 | | V1046.004 Req 04 | | | DUCTS | Joint integrity Post Engine Installation | AR Component overpressurization or fire |
| V41AX0.020-D | E1 LQ2 BLEED (JOINT 016) UP LK CK | ER, PR, OMDP | Lines/Ducts | V1011.06 Req 07 | | V1046.003 Req 05 | | | DUCTS | Joint integrity Post Engine Installation | AR Component overpressurization or fire |
| V41AX0.020-E | E1 LQ2 BLEED (JOINT P4.3) UP LK CK | ER, PR, OMDP | Lines/Ducts | V1011.06 Req 05 | | V1046.002 Req 04 | | | DUCTS | Joint integrity Post Engine Installation | AR Component overpressurization or fire |
| V41AX0.020-F | E1 HELIUM (JOINT P1) UP LK CK | ER, PR, OMDP | Lines/Ducts | V1011.06 Req 12 | | V1046.001 Req 05 | V1046.006 Req 04 | | DUCTS | Joint integrity Post Engine Installation | AR Component overpressurization or fire |
| V41AX0.020-G | E1 QN2 (JOINT N1) UP LK CK | ER, PR, OMDP | Lines/Ducts | | | V145 Req 11 | V1046.009 Req 03 | | DUCTS | Joint integrity Post Engine Installation | AR Component overpressurization or fire |
| V41AX0.020-H | E1 HYD - PRESS (JOINT H1) UP LK CK | ER, PR, OMDP | Lines/Ducts | | V5E17 Req 08 | | V5E18 | V902.06 Req 05 | DUCTS | Joint integrity Post Engine Installation | AR Component overpressurization or fire |
| V41AX0.020-I | E1 HYD - RETURN (JOINT H17) UP LK CK | ER, PR, OMDP | Lines/Ducts | | V5E17 Req 09 | | V5E18 | V902.06 Req 05 | DUCTS | Joint integrity Post Engine Installation | AR Component overpressurization or fire |
| V41AX0.060-A | E1 Q08 DRUM/SSME INTERFACE FLANGE LEAK CHECK | A, ER | Lines/Ducts | | | V1046.005 Req 05 | | | DUCTS | Joint integrity Post Engine Installation | AR Component overpressurization or fire |
| V41BL0.071 | 88ME ENCAPSULATION POWER HD LEAK CK | ER, PR, OMDP | Powerhead | | V1264.007 Req 04 | | | | ENGINE | System leak integrity check for launch - Mat. 1 or Weld Thru-Crack, Seal not Beaded -> Crk. 1 | AR Component overpressurization or fire |
| V41BL0.032 | 88ME ENCAPSULATION FUEL 8Y8 IFO TEST | F | System | | V1264.007 Req 04 | | | | ENGINE | System leak integrity check for launch - Mat. 1 or Weld Thru-Crack, Seal not Beaded -> Crk. 1 | AR Component overpressurization or fire |
| V41BL0.033 | 88ME ENCAPSULATION OXID 8Y8 IFO TEST | F | System | | V1264.007 Req 04 | | | | ENGINE | System leak integrity check for launch - Mat. 1 or Weld Thru-Crack, Seal not Beaded -> Crk. 1 | AR Component overpressurization or fire |
| V41BL0.034 | 88ME ENCAPSULATION HOT GAS 8Y8 IFO TEST | F | System | | V1264.007 Req 04 | | | | ENGINE | System leak integrity check for launch - Mat. 1 or Weld Thru-Crack, Seal not Beaded -> Crk. 1 | AR Component overpressurization or fire |
| V41BP0.010-A | E1 GDS/SDV DDT LK CK & ORIFICE VERIF | ER, PR, OMDP | Valves | V1011.04 Req 07 | V1264.002 Req 17 | V1046.006 Req 05 | V1264.006 Req 05 | | | Each/linea leak test of all passive oxygen system joints from the AFV to the orbiter interface on each flight back. | AR Component overpressurization or fire |
| V41A00.010-A | E1 SENBOR CHECKOUT | ER, PR, OMDP | Instrumentation | V1011.06 Req 02 | V1264.002 Req 08 | V1046.001 Req 04 | | V9001VL4 Req 02 | AVIONICS | Planned Preflight Checkout | Erroneous shutdowns, loss of vehicle |
| V41AL0.013-A | E1 OPERATIONAL INSTRUMENTATION VERIFICATION | A, ER | Instrumentation | | V1046.001 Req 04 | | | V9001VL4 Req 02 | AVIONICS | Instrumentation integrity checkout | Erroneous shutdowns, loss of vehicle |
| V41B00.250-A | E1 SENBOR IR VERIFICATION | ER, PR, OMDP | Instrumentation | V1011.02 Req 07 | | | | | | Functional check of each turbine discharge temp | Erroneous shutdowns, loss of vehicle |
| V41BP0.020-A | E1 HEX COIL LEAK TEST | A, ER, PR, OMDP | HEX | V1011.04 Req 02 | V1264.003 Req 03 | V1046.005 Req 08 | | | HEX | Mat. 1 (fringing) or Weld Thru-Crack; HPOTP installation Impact Hole -> HD to Tank; Crk. 1 | Fire, Uncontained engine failure |
| V41BP0.030 | 88ME HEX COIL PROOF TEST | PLRU | HEX | V1011.04 Req 03 | V1264.003 Req 04 | V1046.005 Req 07 | | | HEX | Mat. 1 (fringing) or Weld Thru-Crack; HPOTP installation Impact Hole -> HD to Tank; Crk. 1 | Fire, Uncontained engine failure |
| V41BU0.080 | HEX BODY CURRENT INSPECTIONS (TIME & CYCLE) | TC | HEX | V1011.02 Req 11 | | | | | HEX | This Made from Bracket Wear, Manuf -> Thru-Crack, HD Leakage to Tank; Crk. | Fire, Uncontained engine failure |
| V41BU0.110 | HEAT EXCHANGER INSPECTION | TC | HEX | | V5E02 Req 14 | | | | HEX | Visible Impact Damage, Bracket Wear -> Thru-Crack -> HD to Tank; Crk. 1; Turb. Vane Cracks -> Loss of Vane Impact M1 Post -> Damage of Crk. 1. | Fire, Uncontained engine failure |
| V41BU0.120 | HEX VISUAL INSPECTION | PLRU | HEX | | V5E02 Req 12 | | | | HEX | HPOTP Installation Impact Hole -> HD to Tank; Crk. 1 | Fire, Uncontained engine failure |
| V41BU0.075-A | E1 HPFTP INTERNAL INSPECTION | PK8C | HPFTP | V1011.02 Req 08 | | | | | TURBOPUMPS | Verify no inlet or discharge shaft metal cracking, no rotor cracking or erosion, no blade cracking, platform cracking, or erosion, no heliograph seal cracking or missing pieces, no bellows shield cracking. (All inspections completed with turbo pumps in. | Fire, Uncontained engine failure |
| V41BU0.070 | HPFTP FIRST STAGE BLADE 22X INSPECTION | TC, DCE | HPFTP | | V5E06 Req 14 | | | | TURBOPUMPS | Verify no inlet or discharge shaft metal cracking (including welds) and the turning vanes, no rotor cracking or erosion, no blade cracking, platform cracking, or erosion, no heliograph seal cracking or missing pieces, no bellows shield cracking via CV. | Fire, Uncontained engine failure |
| V41BU0.080 | HPFTP TURBINE INSPECTION (TIME & CYCLE) | PK8C | HPFTP | | V5E06 Req 14 | | | | TURBOPUMPS | Verify no inlet or discharge shaft metal cracking (including welds) and the turning vanes, no rotor cracking or erosion, no blade cracking, platform cracking, or erosion, no heliograph seal cracking or missing pieces, no bellows shield cracking via CV. | Fire, Uncontained engine failure |
| V41BU0.087 | HPFTP BELLOW HEIGHT VERIF | PLRU | HPFTP | | V5E08 DBAU 2 | | | | TURBOPUMPS | Verify bellows height adequate to provide proper preload on the bellows at installation. Inspect/repair as a result of a previous failure of the bellows. | Fire, Uncontained engine failure |

*Based upon three-engine set

Table 10. OMEF SSME planned operations.*

| OMRBD NUMBER | OMRBD DESCRIPTION (V41 FILE # DATED 8/16/00) | OMRBD EFFECTIVITY | Component | OPF OMI's | ENGINE SHDP OMI's | VAR/PAD OMI's | OTHER OMI's | RT OMI's | SUBSYSTEM CODE | OMRBD RATIONALE/ROOT CAUSES | Root Cause Categories |
|--------------|--|-----------------------|-------------|-----------------|-------------------|------------------|------------------|----------|----------------|---|----------------------------------|
| V41890.090-A | E1 HPOTP TURBINE BEARING DRIVING | EK80 | HPOTP | V1011.01 Req 03 | | V0018.002 Req 04 | V1038VL2 Req 07 | | TURBOPUMPS | Ensure all moisture is removed from the bearing area after a test/flight. | Fire, Uncontained engine failure |
| V41890.110-A | E1 HPOTP PRIMARY OXID SEAL LEAK TEST | PK80, NRAT | HPOTP | V1011.08 Req 07 | V1294.008 Req 03 | V1048.003 Req 07 | | | | Check for excessive leakage of LOX/DOK from the HPOTP seal - Protease against excessive flow overcoming the barrier seal and from having excessive torque losses during the chill down of the engine. Kai-seal does wear during operation. | Fire, Uncontained engine failure |
| V41890.040-A | E1 HPOTP TORQUE TEST | EK80, RI, PLRU, NRAT | HPOTP | V1011.08 Req 08 | V6E02 Req 25 | | | | TURBOPUMPS | Done to ensure rotor is not bound up prior to start -- sensors cover contamination. If high and also start abnormalities if rotor is slow to spin -- contamination has been found around the rotor but only since enough to affect start (checked IVE bearings) | Fire, Uncontained engine failure |
| V41890.042 | HPOTP INVESTIGATIVE TORQUE | F, NRAT | HPOTP | V1011.03 Req 08 | V6E02 Req 25 | | | | TURBOPUMPS | Done only to run to a high torque pump to bring the torque value below spec requirements | Fire, Uncontained engine failure |
| V41890.043-A | E1 HPOTP IMPELLER LOCK VERIF | PK80, PLRU, NRAT | HPOTP | V1011.03 Req 08 | V6E02 Req 25 | | | | TURBOPUMPS | Loading feature was overcome on a HPOTP PBP impeller bolt lock during torque testing/shim of pump for inspections. Recurrence control is to only turn the pump in the both spinning direction during inspections and to check the locking feature after it. | Fire, Uncontained engine failure |
| V41890.045 | HPOTP MICROSHAFT TRAVEL | PK80, NRAT | HPOTP | V1011.03 Req 08 | | | | | TURBOPUMPS | Turbine bearings have worn very quickly in past -- this measurement is to ensure that the bearings are still capable of 1 flight prior to a burn. | Fire, Uncontained engine failure |
| V41890.110-A | E1 ATD BLOCK VII HPOTP PRIMARY OXID SEAL LEAK TEST | PK80, NRAT | HPOTP | V1011.06 Req 07 | V1294.008 Req 03 | V1048.003 Req 07 | | | | This bolt check was never performed during HPOTP/VAT certification. The data obtained is erratic and is probably indicative of only gross seal imperfections (which would most likely be detected through torque checks). It is currently an OMRBD requirement. | Fire, Uncontained engine failure |
| V41890.088-A | E1 HPOTP INTERNAL INSPECTION | PK80, NRAT | HPOTP | V1011.02 Req 08 | | | | | TURBOPUMPS | Visual inspections of turbine hardware (abnormalities/missing blades) due to cracking and erosion seen in the past, of the main pump inlet/inducer due to cavitation damage and contamination found in the past, of the PBP impeller inlet due to locking test | Fire, Uncontained engine failure |
| V41890.099-A | E1 HPOTP TIP SEAL RETAINER INSPECTION | PK80, NRAT | HPOTP | | | | | | TURBOPUMPS | Verify leakage tip seal retainer screws have not rotated. Could lead to blade failure. | Fire, Uncontained engine failure |
| V41890.390-A | E1 LPFD QUALITY CHECK | F | Lines/Ducts | V1011.02 Req 10 | | | V0018.002 Req 10 | | DUCTS | Contingency test performed only when the LPFD helium barrier system has been damaged. Object is to detect potential dust collapse or separation from the layer of insulation by measuring the roundness of the dust. | Fire, Uncontained engine failure |
| V41890.400 | PERFORM LPFD XRAY INSPECTION | F | Lines/Ducts | TBD | | | | | DUCTS | Contingency test performed only when the ovality check indicates that some damage or collapse has occurred in the LPFD. The cross section is X-rayed in an attempt to verify presence of damage. | Fire, Uncontained engine failure |
| V41890.080 | HPOTP/TORQUE TEST | EK80, RI, PLRU | HPOTP | V1011.03 Req 08 | V6E02 Req 25 | | | | TURBOPUMPS | Replaced by V41890.040-A | Fire, Uncontained engine failure |
| V41890.086 | HPOTP/VAT INVESTIGATIVE TORQUE | F | HPOTP | V1011.03 Req 08 | V6E02 Req 25 | | | | TURBOPUMPS | Replaced by V41890.042 | Fire, Uncontained engine failure |
| V41890.406 | 80ME LPFD THROUD LOGS INSPECTION | DCE | Lines/Ducts | TBD | | | | | DUCTS | Performed to insure LPFD structural integrity. Inspection is performed if post flight data evaluation reveals HPOTP unacceptable symptoms/frequencies. | Fire, Uncontained engine failure |
| V41890.085-A | E1 ATD BLOCK VII HPOTP INTERNAL INSPECTION | PK80, NRAT | HPOTP | V1011.02 Req 08 | | | | | TURBOPUMPS | No HPOTP/VAT internal inspections were made during certification. Inspections of the turbine, mainstage pumps and PBP inlet, and all three bearings have been added only because the inspections aren't time consuming and because some "humus error" could be | Fire, Uncontained engine failure |
| V41890.010-A | E1 LPFTP TORQUE TEST | A, RI, PLRU, ER, PLRU | LPFTP | V1011.03 Req 04 | | | | | TURBOPUMPS | Verify rotor is free to rotate prior to testing. | Fire, Uncontained engine failure |
| V41890.127 | HPOTP/VAT PBP TIEBOLT LOCK INSPECTION | F | HPOTP | V1011.03 | | | | | TURBOPUMPS | | Fire, Uncontained engine failure |
| V41890.128 | HPOTP/VAT CONTAMINATION INSPECTION | A, PK80 | HPOTP | V1011.02 Req 07 | | | | | TURBOPUMPS | | Fire, Uncontained engine failure |
| V41890.085 | 80ME HPOTP/VAT TURBINE BEARING DRIVING | PK80 | HPOTP | V1011.01 Req 03 | V1294.008 Req 04 | V0018.002 Req 04 | | | TURBOPUMPS | Verify all moisture is removed from the bearing area after 1 test/flight. | Fire, Uncontained engine failure |
| V41890.011 | LPFTP INVESTIGATIVE TORQUE | F | LPFTP | V1011.03 Req 04 | | | | | TURBOPUMPS | Investigative torque check if the application limits are exceeded - torque check failure generally (th-off seal binding or (dry seal) copper plating rub | Fire, Uncontained engine failure |

* OMEF data reflects single-engine processing. For complete model, processing timelines must consider number of engines per vehicle.

Table 11. OPF post-SSME installation planned operations.*

| Process | Sub-Process | Process Description | Duration (PD) | Tech Mhrs | QC Mhrs | Engr Mhrs | Total Mhrs |
|------------------|-------------|---|---------------|-----------|---------|-----------|------------|
| V5005 | | SSME Installation Preps | 24.00 | 31 | 37 | 13 | 81 |
| | V5057 | Stiffarm Bracket & TVCA Support Installation | 4.00 | 8 | 4 | 0 | 12 |
| V5087 | | Engine 1 Installation Handling GSE Operations | 5.00 | 19 | 4 | 11.5 | 34.5 |
| V5005 | | Engine 1 Installation Operations | 7.00 | 42 | 12 | 25 | 79 |
| V5087 | | Engine 3 Installation Handling GSE Operations | 5.00 | 19 | 4 | 11.5 | 34.5 |
| V5005 | | Engine 3 Installation Operations | 7.00 | 42 | 12 | 25 | 79 |
| V5087 | | Engine 2 Installation Handling GSE Operations | 5.00 | 19 | 4 | 11.5 | 34.5 |
| V5005 | | Engine 2 Installation Operations | 7.00 | 42 | 12 | 25 | 79 |
| V5005 | | Post-SSME Installation Operations | 32.00 | 88 | 56 | 0 | 144 |
| | V9002.06 | SSME Hydraulic QD Demate Operations | 4.00 | 4 | 4 | 0 | 8 |
| V1011.03 Run 3 | | LPOTP Post-Installation Torque Check | 12.00 | 12 | 12 | 12 | 36 |
| V1011.03 Run 3 | | LPFTP Post-Installation Torque Check | 6.00 | 6 | 6 | 6 | 18 |
| V1011.05 | | Orbiter/SSME Interface Verification | 72.25 | 59 | 50.5 | 24.5 | 134 |
| | V1011.04 | SSME GOX System Leak Checks | 14.00 | 20 | 12 | 10.5 | 42.5 |
| | V9001VL4 | Orbiter/SSME Electrical Interface Verification | 8.00 | 0 | 8 | 8 | 16 |
| V41/G41/V80 JC's | | Heat Shield Installation Operations | 126.00 | 704 | 352 | 0 | 1056 |
| V1063 | | SSME Gimbal Clearance Checks | 17.50 | 34.5 | 31.5 | 42 | 108 |
| | V5057 | TVCA Pinning Operations | 4.00 | 8 | 4 | 0 | 12 |
| | V9002.06 | SSME Hydraulic QD Leak Checks | 1.00 | 1 | 1 | 1 | 3 |
| V41-20003 | | SSME OPF Roll-Out Inspections | 19.00 | 11 | 11 | 6 | 28 |
| | V5057 | Thrust Chamber & Miscellaneous Cover Installation | 4.00 | 4 | 4 | 0 | 8 |
| | V5057 | TVCA Midstroke Lock Installation | 4.00 | 8 | 4 | 0 | 12 |

* Based upon three-engine set

Table 12. SSME VAB/pad processing planned operations.*

| Process | Sub-Process | Process Description | Duration (PD) | Tech Mhrs | QC Mhrs | Engr Mhrs | Total Mhrs |
|------------------|-------------|--|---------------|-----------|---------|-----------|------------|
| S0008 | | Shuttle Interface Testing | 36.00 | 0 | 0 | 0 | 0 |
| | V1149 | GN2 Interface Leak Check & Trickle Purge Ops | 30.00 | 9.75 | 11.25 | 12.75 | 33.75 |
| | V5057 | Thrust Chamber Cover Removal & Installation | 1.00 | 1 | 0 | 0 | 1 |
| S0009 | | Launch Pad Validation | 44.00 | 4 | 4 | 4 | 12 |
| V1046.001 | | SSME Flight Readiness Test & Checkout | 21.00 | 2 | 9 | 12 | 23 |
| | V9002.06 | Preps for SSME Hydraulic Operations | 3.00 | 2 | 0 | 1 | 3 |
| | V5057 | TVCA Midstroke Lock Removal | 4.00 | 8 | 4 | 0 | 12 |
| | V9001VL4 | SSME Controller Power-Up Operations | 2.00 | 0 | 6 | 8 | 14 |
| V1046.002 | | LH2 System Ball Seal Leak Check | 3.00 | 6 | 5.5 | 4 | 15.5 |
| | V9002.06 | SSME/TVCA Actuator Hydraulic Power Dwon Securing Rqmts | 2.00 | 1 | 0 | 1 | 2 |
| | V5057 | TVCA Midstroke Lock Installation | 1.50 | 3 | 1.5 | 0 | 4.5 |
| V1046.003 | | LQ2 System Ball Seal Leak Check | 1.00 | 1 | 2 | 2 | 5 |
| V9002.06 | | SSME Hydraulic QD X-Rays | 4.00 | 4 | 4 | 0 | 8 |
| V1202 | | Orbiter Aft Helium Signature Test | 34.00 | 7 | 5.5 | 5.5 | 18 |
| S1005 | | LQ2 Propellant System Conditioning | 6.50 | 3.75 | 0 | 0 | 3.75 |
| | V5057 | SSME Chamber Cover Removal/Drain Line Adapter Installation | 2.00 | 2 | 2 | 0 | 4 |
| S1006 | | LH2 Propellant System Conditioning | 9.50 | 0 | 0 | 0 | 0 |
| | V9001VL4 | SSME Controller Power-Up Operations | 2.00 | 0 | 2 | 4 | 6 |
| S1287 | | Orbiter Aft Closeout for Flight | 100.00 | 48 | 42 | 66 | 156 |
| | V9018.001 | MPS & SSME Initial Preps for Propellant Loading | 8.00 | 8 | 8 | 8 | 24 |
| | V5057 | TVCA Midstroke Lock Removal | 34.00 | 68 | 34 | 0 | 102 |
| | V5057 | SSME Protective Cover Removal | 8.00 | 8 | 0 | 0 | 8 |
| S0007 | | Shuttle Launch Countdown Operations | 181.37 | 12 | 88 | 153 | 248 |
| | V9018.001 | MPS & SSME Final Preps for Propellant Loading | 8.00 | 3 | 3 | 0.25 | 6.25 |
| | S1003 | LQ2 Propellant System Loading Operations | 24.87 | 0 | 24.87 | 49.75 | 74.62 |
| | S1004 | LH2 Propellant System Loading Operations | 24.87 | 0 | 0 | 0 | 0 |

* Based upon three-engine set

Table 13. OPF roll-in to SSME removal tasks.

| ID | Task Name | Duration | Work | Predecessors | Resource Names |
|-----------|---|---------------|---------------|--------------|---------------------------|
| 1 | OPF Roll-in to SSME Removal | 271.9h | 1305h | | |
| 2 | Orbiter at OPF Door/S0028 | 0h | 0h | | |
| 3 | HPFTP Bearing Drying Operations/V1011.01 | 24.75h | 98.25h | | |
| 4 | Extend Platforms 10S and 19S/V1011.01/V35xx | 0.5h | 1.5h | | Tech[2],QC |
| 5 | Remove SSME Environmental Closures | 0.5h | 0.5h | 4 | Tech |
| 6 | Mate Bearing Drying Flexhoses | 2h | 4h | 5 | Tech,QC |
| 7 | Retract Platforms 10S and 19S/V1011.01/V35xx | 0.5h | 1.5h | 6 | Tech[2],QC |
| 8 | MCC Acoustic Cavity Inspections/Install Throat Plugs | 4h | 8h | | Tech,QC |
| 9 | Mate Bearing Drying Exhaust Duct | 4h | 12h | 8 | Tech[2],QC |
| 10 | Install SSME Bellows and Miscellaneous Covers/V5057 | 3h | 6h | 19 | Tech,QC |
| 11 | Establish Safety Clears | 0.25h | 1.25h | 9 | Tech[2],QC,Safety,Engr |
| 12 | HPFTP Bearing Drying Purge Initiated | 0h | 0h | 11 | |
| 13 | Perform SSME Bearing Drying | 8.5h | 42.5h | 12 | Tech[2],QC,Safety,Engr |
| 14 | Perform Filter Inspection and Cleaning | 2.5h | 5h | 13 | Tech,QC |
| 15 | Disassemble Test Setup and Remove Throat Plugs | 8h | 16h | 13 | Tech[2] |
| 16 | Establish Aft Access | 5h | 0h | | |
| 17 | Install Entry Level Platforms/V35-00001 | 2h | 0h | | |
| 18 | Install Floor Level Platforms/V35-00001 | 3h | 0h | 17 | |
| 19 | Aft Access Available | 0h | 0h | 16,18 | |
| 20 | OPF Bay Open for Normal Work | 0h | 0h | 19 | |
| 21 | Orbiter Initial Power-Up | 0h | 0h | | |
| 22 | Helium Baggie Leak Check/V1263 | 12.5h | 43.75h | 20 | |
| 23 | Install TVCA Midstroke Locks/V5057 | 3h | 9h | 20 | Tech[2],QC |
| 24 | Verify Throat Plugs Removed and MPS/SSME Helium Tanks Pressurized | 0.25h | 0.75h | | QC,Engr[2] |
| 25 | SSME Controller Initial Power-Up/V9001VLA | 4h | 8h | | Engr,QC |
| 26 | Establish Safety Clears for Helium System Activation | 0.25h | 1.5h | 24,25 | Tech,QC[2],Safety,Engr[2] |
| 27 | Perform SSME 750 psi Helium System Activation | 0.75h | 4.5h | 26 | Tech,QC[2],Safety,Engr[2] |
| 28 | Perform LPFD Helium Barrier Inspection per V41CB0.012 | 3h | 15h | 27 | Tech,QC[2],Engr[2] |
| 29 | Perform SSME 750 psi Helium System Securing | 0.5h | 1h | 28 | QC,Engr |
| 30 | Install LPFD Purge Blanking Plate Adapter/Remove Baggies | 4h | 4h | 29 | Tech |
| 31 | SSME Drying Operations/V1011.01 | 45.5h | 173h | 22 | |
| 32 | Mate GN2 Purge QD to Orbiter @ PD14 | 4h | 12h | | Tech[2],QC |
| 33 | Install Heise Gages @ TP24 and TP25 | 1h | 2h | 32 | Tech,QC |
| 34 | Assemble/Mate 15 Purge Hose/Filter Assemblies | 8h | 16h | 20 | Tech,QC |
| 35 | Remove Joint F6.10/F6.11 Plugs/Boroscope for Moisture | 2h | 4h | | Tech,QC |
| 36 | Install Joint F6.10/F6.11/G4.3/N16 Adapters | 1h | 2h | 35 | Tech,QC |
| 37 | Loosen Bolts @ Joint N14 Plate | 0.5h | 1h | 36 | Tech,QC |
| 38 | Install LPFTP Anti-Rotation Tool | 0.75h | 1.5h | 37 | Tech,QC |
| 39 | Install Shim @ Joint D35.2/N11.2 Transducer Stack | 0.75h | 1.5h | 38 | Tech,QC |
| 40 | Install Shim @ MCC Pc Transducer/Inspect for Moisture | 3h | 6h | 39 | Tech,QC |

Table 13. OPF rollin to SSME removal tasks (Continued).

| ID | Task Name | Duration | Work | Predecessors | Resource Names |
|----|--|------------|-------------|--------------|------------------------------|
| 41 | Install Throat Plug/Monitor Gage/Drain Line Adapters | 3h | 6h | 34 | Tech, QC |
| 42 | Mate Flexhoses @ HPOTP Turbine Primary Drain Adapters | 1h | 2h | 41 | Tech, QC |
| 43 | Mate Flexhoses @ Joints F6.10/F6.11/G4.3/N16 Adapters | 2h | 4h | 42 | Tech, QC |
| 44 | Mate Throat Plug/HPOTP Ox Seal/Turb Sec Seal to OPF Vent System | 3h | 6h | 41 | Tech, QC |
| 45 | Perform Engineering/Safety Walkdown of Drying Setup | 2h | 6h | 44 | Safety, Engr[2] |
| 46 | V1011.01 Call to Station | 1h | 7h | 45 | Tech[3], QC, Engr[3] |
| 47 | Configure/Prep GSE Panels | 1h | 7h | 46 | Tech[3], QC, Engr[3] |
| 48 | Establish Safety Clears for SSME Pneumatics Activation | 0.25h | 2h | 46 | Tech[3], QC, Safety, Engr[3] |
| 49 | Activate SSME Pneumatics/Verify SSME Valve Positions | 0.5h | 3.5h | 48, 47 | Tech[3], QC, Engr[3] |
| 50 | Apply MPS LO2 and LH2 System Blanket Pressure | 1h | 7h | 49 | Tech[3], QC, Engr[3] |
| 51 | Establish Safety Clear of Level 10/19 Platforms | 0.25h | 2h | 50 | Tech[3], QC, Safety, Engr[3] |
| 52 | Initiate HPOTP Turb Pri Seal/Ox System Drying Purge per V41CB0.080 | 0.75h | 5.25h | 51 | Tech[3], QC, Engr[3] |
| 53 | HPOTP Turb Pri Seal/Ox System Drying Purge Active Monitoring | 2h | 6h | 52 | Tech, QC, Engr |
| 54 | Secure HPOTP Turb Pri Seal/Ox System Drying Purge | 0.25h | 1.75h | 53 | Tech[3], QC, Engr[3] |
| 55 | Switch Flexhose from Turbine Primary to Turbine Secondary Adapters | 0.5h | 3.5h | 54 | Tech[3], QC, Engr[3] |
| 56 | Mate Turbine Secondary Seal to OPF Vent System | 0.5h | 3.5h | 55 | Tech[3], QC, Engr[3] |
| 57 | Initiate MCC/FPB/Nozzle Drying Purge per V41CB0.080 | 0.75h | 5.25h | 56 | Tech[3], QC, Engr[3] |
| 58 | MCC/FPB/Nozzle Drying Purge Active Monitoring | 2h | 6h | 57 | Tech, QC, Engr |
| 59 | Secure MCC/FPB/Nozzle Drying Purge | 0.25h | 1.75h | 58 | Tech[3], QC, Engr[3] |
| 60 | Perform HPOTP Dryness Verification per V41CB0.081 | 2h | 6h | 59 | Tech, QC, Engr |
| 61 | Demate Flexhoses @ Joints F6.10/F6.11/G4.3/N16 Adapters | 0.5h | 1h | 60 | Tech, QC |
| 62 | Torque Joint N14 Plate | 0.25h | 0.5h | 61 | Tech, QC |
| 63 | Remove Shims/Torque MCC Pc Transducer and D35.2/N11.2 Stack | 1h | 2h | 62 | Tech, QC |
| 64 | Tee-Connect Turb Pri to Turb Sec/Connect to Lo Press Manifold | 1h | 2h | 63 | Tech, QC |
| 65 | Perform MCC/FPB/Nozzle Dryness Verification per V41CB0.081 | 2h | 6h | 64 | Tech, QC, Engr |
| 66 | Disassemble Test Setup/Route Filters for Bubble Point Analysis | 12h | 24h | 65 | Tech, QC |
| 67 | SSME Inspections and Checkouts in OPF/V1011.02 | 44h | 140h | 31 | |
| 68 | Perform Megger GR1864 Setup | 8h | 8h | | Tech |
| 69 | Perform E1 External Inspections (excluding Nozzle) per V41BU0.030 | 4h | 8h | 68 | QC, Engr |
| 70 | Remove E1 Internal Inspection Port Hardware | 4h | 4h | 69 | Tech |
| 71 | Perform E1 Quick Look Internal Inspections | 8h | 16h | 70 | QC, Engr |
| 72 | Secure E1 Inspection Port Hardware | 4h | 8h | 71 | Tech, QC |
| 73 | Perform E2 External Inspections (excluding Nozzle) per V41BU0.030 | 4h | 8h | 68, 69 | QC, Engr |
| 74 | Remove E2 Internal Inspection Port Hardware | 4h | 4h | 73 | Tech |
| 75 | Perform E2 Quick Look Internal Inspections | 8h | 16h | 74, 71 | QC, Engr |
| 76 | Secure E2 Inspection Port Hardware | 4h | 8h | 75 | Tech, QC |
| 77 | Perform E3 External Inspections (excluding Nozzle) per V41BU0.030 | 4h | 8h | 68, 69, 70 | QC, Engr |
| 78 | Remove E3 Internal Inspection Port Hardware | 4h | 4h | 77 | Tech |
| 79 | Perform E3 Quick Look Internal Inspections | 8h | 16h | 78, 75 | QC, Engr |
| 80 | Secure E3 Inspection Port Hardware | 4h | 8h | 79 | Tech, QC |

Table 13. OPF rollin to SSME removal tasks (Continued).

| ID | Task Name | Duration | Work | Predecessors | Resource Names |
|-----|---|------------|-------------|---------------|------------------------------|
| 81 | Perform HPOTP Strain Gauge Bonding Inspections per V41AU0.090 | 4h | 12h | 68 | Tech, QC, Engr |
| 82 | Perform TDT Sensors Resistance Measurements per V41BU0.250 | 4h | 12h | 81 | Tech, QC, Engr |
| 83 | SSME Post-Flight Low Pressure Pump Torque Checks | 18h | 54h | 67 | |
| 84 | Engine 1,2,3 LPFTP Torque Checks/V1011.03 Run 1 | 6h | 18h | | Tech, QC, Engr |
| 85 | Engine 1,2,3 LPOTP Torque and Travel Checks/V1011.03 Run 1 | 12h | 36h | 84 | Tech, QC, Engr |
| 86 | SSME Heat Shield Removal Operations/V41-40021,22,23,24,25,26 | 58h | 276h | 67 | |
| 87 | Remove DMHS Carrier Panels/V80-05907,33,35 | 40h | 120h | 23 | Tech[2], QC |
| 88 | Remove DMHS Splice/Perimeter Hardware/V41-40021,22,23 | 4h | 12h | | Tech[2], QC |
| 89 | Install E1 Lower Splice Platform | 0h | 0h | | |
| 90 | Position Davit Crane to 19W Platform | 2h | 6h | | Tech[2], QC |
| 91 | Begin Heat Shield Removal Operations | 0h | 0h | 87,88,89,90 | |
| 92 | Remove E1 Left Hand DMHS/V41-40021 | 1h | 10h | 91 | Tech[6], QC, Safety, Engr[2] |
| 93 | Remove E1 Lower Splice Platform | 0h | 0h | 92 | |
| 94 | Remove E2 Left Hand DMHS/V41-40022 | 1h | 10h | 93 | Tech[6], QC, Safety, Engr[2] |
| 95 | Remove E2 Right Hand DMHS/V41-40022 | 1h | 10h | 94 | Tech[6], QC, Safety, Engr[2] |
| 96 | Remove E2 Right Hand EMHS/V41-40025 | 1h | 10h | 95 | Tech[6], QC, Safety, Engr[2] |
| 97 | Remove E2 Left Hand EMHS/V41-40025 | 1h | 10h | 96 | Tech[6], QC, Safety, Engr[2] |
| 98 | Reposition Davit Crane to 19E Platform | 2h | 6h | 97 | Tech[2], QC |
| 99 | Remove E3 Right Hand DMHS/V41-40023 | 1h | 10h | 98 | Tech[6], QC, Safety, Engr[2] |
| 100 | Remove E3 Left Hand DMHS/V41-40023 | 1h | 10h | 99 | Tech[6], QC, Safety, Engr[2] |
| 101 | Remove E3 Left Hand EMHS/V41-40026 | 1h | 10h | 100 | Tech[6], QC, Safety, Engr[2] |
| 102 | Remove E3 Right Hand EMHS/V41-40026 | 1h | 10h | 101 | Tech[6], QC, Safety, Engr[2] |
| 103 | Install E2/E3 Lower Splice Platform | 0h | 0h | 102 | |
| 104 | Remove E1 Right Hand DMHS/V41-40021 | 1h | 10h | 103 | Tech[6], QC, Safety, Engr[2] |
| 105 | Remove E1 Right Hand EMHS/V41-40024 | 1h | 10h | 104 | Tech[6], QC, Safety, Engr[2] |
| 106 | Reposition Davit Crane to 19W Platform | 2h | 6h | 105 | Tech[2], QC |
| 107 | Remove E1 Left Hand EMHS/V41-40024 | 1h | 10h | 106 | Tech[6], QC, Safety, Engr[2] |
| 108 | Remove E2/E3 Lower Splice Platform | 0h | 0h | 107 | |
| 109 | Stow Davit Crane | 2h | 6h | 108 | Tech[2], QC |
| 110 | SSME Removal Operations | 64h | 520h | 109,86 | |
| 111 | Engine Removal Preps | 12h | 129h | | |
| 112 | Demate SSME Hydraulic QD's/V9002.06 | 7h | 29h | 86 | |
| 113 | Perform Orbiter Hydraulic System Venting | 4h | 20h | | Tech, Safety, Engr[3] |
| 114 | Demate E1 Hydraulic Return QD @ Joint H17 | 0.25h | 0.75h | 113 | Tech, QC, Engr |
| 115 | Perform E1 Hydraulic Return QD Demate Inspection per V58AG0.123-D | 0.25h | 0.75h | 114 | Tech, QC, Engr |
| 116 | Demate E1 Hydraulic Supply QD @ Joint H1 | 0.25h | 0.75h | 115 | Tech, QC, Engr |
| 117 | Perform E1 Hydraulic Supply QD Demate Inspection per V58AG0.123-A | 0.25h | 0.75h | 116 | Tech, QC, Engr |
| 118 | Demate E2 Hydraulic Return QD @ Joint H17 | 0.25h | 0.75h | 117 | Tech, QC, Engr |
| 119 | Perform E2 Hydraulic Return QD Demate Inspection per V58AG0.123-E | 0.25h | 0.75h | 118 | Tech, QC, Engr |
| 120 | Demate E2 Hydraulic Supply QD @ Joint H1 | 0.25h | 0.75h | 119 | Tech, QC, Engr |

Table 13. OPF rollin to SSME removal tasks (Continued).

| ID | Task Name | Duration | Work | Predecessors | Resource Names |
|-----|---|-----------|------------|---------------|------------------------------------|
| 121 | Perform E2 Hydraulic Supply QD Demate Inspection per V58AG0.123-B | 0.25h | 0.75h | 120 | Tech, QC, Engr |
| 122 | Demate E3 Hydraulic Return QD @ Joint H17 | 0.25h | 0.75h | 121 | Tech, QC, Engr |
| 123 | Perform E3 Hydraulic Return QD Demate Inspection per V58AG0.123-F | 0.25h | 0.75h | 122 | Tech, QC, Engr |
| 124 | Demate E3 Hydraulic Supply QD @ Joint H1 | 0.25h | 0.75h | 123 | Tech, QC, Engr |
| 125 | Perform E3 Hydraulic Supply QD Demate Inspection per V58AG0.123-C | 0.25h | 0.75h | 124 | Tech, QC, Engr |
| 126 | Orbiter Interface Hardware Verification (Aft) | 4h | 8h | | Tech, QC |
| 127 | LH2 Foam Removal (Aft) | 8h | 16h | | Tech, QC |
| 128 | Terminate Aft Compartment ECS Purge Air per V3555 | 0h | 0h | | |
| 129 | PVD Controller Duct Removal (Aft) | 6h | 18h | 128 | Tech[2], QC |
| 130 | Reinitiate Aft Compartment ECS Purge Air per V3555 | 0h | 0h | 129 | |
| 131 | Calibrate Force Gages (Roc) | 8h | 16h | | Tech, QC |
| 132 | Orbiter Preps (Roc) | 4h | 8h | | Tech, QC |
| 133 | Electrical Interface Demates (Aft) | 4h | 8h | | Tech, QC |
| 134 | Engine Preps (Roc) | 4h | 8h | | Tech, QC |
| 135 | Orbiter Helium Handvalve Installation (Aft) | 2h | 4h | 133 | Tech, QC |
| 136 | Terminate Aft Compartment ECS Purge Air per V3555 | 0h | 0h | 135 | |
| 137 | Demate Fluid System Interfaces (Roc) | 2h | 8h | 136, 131, 127 | Tech[3], QC |
| 138 | Reinitiate Aft Compartment ECS Purge Air per V3555 | 0h | 0h | 137 | |
| 139 | Install Interface Support Panel (Roc) | 2h | 6h | 138 | Tech[2], QC |
| 140 | Engine 2 Removal GSE Handling Operations (Roc)/V5087 | 8h | 36h | 111 | |
| 141 | Verify Lift Truck, Carrier and Rail Table Proofload Validations | 0.5h | 1h | | Tech, QC |
| 142 | Install Lift Spoon | 0.5h | 1h | 141 | Tech, QC |
| 143 | Mount Rail Table on Lift Truck | 1h | 4h | 142 | Tech[2], QC, Engr |
| 144 | Mount Carrier on Rail Table/Lift Truck | 2h | 8h | 143 | Tech[2], QC, Engr |
| 145 | Perform Dummy Load Brake Test without Engine | 3h | 21h | 144 | Tech[4], QC, Safety, Engr |
| 146 | Transport Lift Truck/Hyster to OPF for Engine 2 Removal | 1h | 1h | 145 | Engr |
| 147 | Engine 2 Removal Operations | 8h | 75h | 140 | |
| 148 | Position Installer for Engine 2 Removal | 2h | 10h | 111 | Tech[2], QC, Engr[2] |
| 149 | Mate Installer to Engine 2 | 2h | 30h | 148 | Tech[7], QC[2], Safety[2], Engr[4] |
| 150 | Terminate Aft Compartment ECS Purge Air per V3555 | 0h | 0h | 149 | |
| 151 | Demate Engine from Orbiter | 2h | 30h | 150 | Tech[7], QC[2], Safety[2], Engr[4] |
| 152 | Reinitiate Aft Compartment ECS Purge Air per V3555 | 0h | 0h | 151 | |
| 153 | Transport Engine 2 to VAB | 1h | 1h | 152 | Engr |
| 154 | Install Orbiter Engine 2 Interface Covers | 2h | 4h | 151 | Tech, QC |
| 155 | Rotate Engine 2 to Horizontal Handler/V5087 | 2h | 14h | 153 | |
| 156 | Install Rotating Sling and Unload Carrier/Engine | 0.5h | 3.5h | | Tech[4], QC, Safety, Engr |
| 157 | Mount Carrier on Skid | 0.5h | 3.5h | 156 | Tech[4], QC, Safety, Engr |
| 158 | Transfer Engine 2 to Horizontal Handler | 1h | 7h | 157 | Tech[4], QC, Safety, Engr |
| 159 | Engine 3 Removal GSE Handling Operations (Roc)/V5087 | 6h | 30h | 158 | |
| 160 | Mount Carrier on Rail Table/Lift Truck | 2h | 8h | | Tech[2], QC, Engr |

Table 13. OPF rollin to SSME removal tasks (Continued).

| ID | Task Name | Duration | Work | Predecessors | Resource Names |
|-----|--|-----------|------------|--------------|---------------------------------|
| 161 | Perform Dummy Load Brake Test without Engine | 3h | 21h | 160 | Tech[4],QC,Safety,Engr |
| 162 | Transport Hyster to OPF for Engine 3 Removal | 1h | 1h | 161 | Engr |
| 163 | Engine 3 Removal Operations | 8h | 75h | 147 | |
| 164 | Position Installer for Engine 3 Removal | 2h | 10h | 162 | Tech[2],QC,Engr[2] |
| 165 | Mate Installer to Engine 3 | 2h | 30h | 164 | Tech[7],QC[2],Safety[2],Engr[4] |
| 166 | Terminate Aft Compartment ECS Purge Air per V3555 | 0h | 0h | 165 | |
| 167 | Demate Engine from Orbiter | 2h | 30h | 166 | Tech[7],QC[2],Safety[2],Engr[4] |
| 168 | Reinitiate Aft Compartment ECS Purge Air per V3555 | 0h | 0h | 167 | |
| 169 | Transport Engine 3 to VAB | 1h | 1h | 168 | Engr |
| 170 | Install Engine 3 Interface Covers | 2h | 4h | 167 | Tech,QC |
| 171 | Rotate Engine 3 to Horizontal Handler/V5087 | 2h | 14h | 169 | |
| 172 | Install Rotating Sling and Unload Carrier/Engine | 0.5h | 3.5h | | Tech[4],QC,Safety,Engr |
| 173 | Mount Carrier on Skid | 0.5h | 3.5h | 172 | Tech[4],QC,Safety,Engr |
| 174 | Transfer Engine 3 to Horizontal Handler | 1h | 7h | 173 | Tech[4],QC,Safety,Engr |
| 175 | Engine 1 Removal GSE Handling Operations (Roc)/V5087 | 6h | 30h | 174 | |
| 176 | Mount Carrier on Rail Table/Lift Truck | 2h | 8h | | Tech[2],QC,Engr |
| 177 | Perform Dummy Load Brake Test without Engine | 3h | 21h | 176 | Tech[4],QC,Safety,Engr |
| 178 | Transport Hyster to OPF for Engine 1 Removal | 1h | 1h | 177 | Engr |
| 179 | Engine 1 Removal Operations | 8h | 75h | | |
| 180 | Position Installer for Engine 1 Removal | 2h | 10h | 178 | Tech[2],QC,Engr[2] |
| 181 | Mate Installer to Engine 1 | 2h | 30h | 180 | Tech[7],QC[2],Safety[2],Engr[4] |
| 182 | Terminate Aft Compartment ECS Purge Air per V3555 | 0h | 0h | 181 | |
| 183 | Demate Engine from Orbiter | 2h | 30h | 182 | Tech[7],QC[2],Safety[2],Engr[4] |
| 184 | Reinitiate Aft Compartment ECS Purge Air per V3555 | 0h | 0h | 183 | |
| 185 | Transport Engine 1 to VAB | 1h | 1h | 184 | Engr |
| 186 | Install Engine 1 Interface Covers | 2h | 4h | 183 | Tech,QC |
| 187 | Rotate Engine 1 to Horizontal Handler/V5087 | 6h | 30h | 185 | |
| 188 | Install Rotating Sling and Unload Carrier/Engine | 0.5h | 3.5h | | Tech[4],QC,Safety,Engr |
| 189 | Mount Carrier on Skid | 0.5h | 3.5h | 188 | Tech[4],QC,Safety,Engr |
| 190 | Transfer Engine 1 to Horizontal Handler | 1h | 7h | 189 | Tech[4],QC,Safety,Engr |
| 191 | Stow SSME Handling GSE/V5087 | 4h | 16h | 190 | Tech[2],QC,Engr |
| 192 | Post-Engine Removal Operations | 6h | 12h | 179 | |
| 193 | Interface Hardware Inspections | 4h | 8h | 186 | Tech,QC |
| 194 | Gimbal Bolt/Nut Torque Cycle | 2h | 4h | 186,193 | Tech,QC |
| 195 | SSME Removal Operations Complete/OK to Proceed with MPS Operations | 0h | 0h | 193,194 | |

Table 14. Engine shop turnaround tasks.*

| ID | Task Name | Duration | Work | Predecessors |
|----|--|----------|---------|--------------|
| 1 | Engine Shop Turnaround! | 252.75h | 1330h | |
| 2 | Nozzle Tube Leak Checks/V1294.005! | 3h | 6.5h | |
| 3 | SSME Inspections in Engine Shop (continued)/V1011.02! | 252.75h | 135.75h | |
| 4 | Vertical Stand Available | 0h | 0h | |
| 5 | Transfer Engine to Vertical Stand/V5087! | 3h | 32.5h | 4 |
| 6 | HPOTP Post-Flight Torque Check/V1011.03 Run 1! | 3.75h | 11.25h | 5 |
| 7 | HPFTP Post-Flight Torque Check/V1011.03 Run 1! | 3.5h | 10.5h | 6 |
| 8 | HEX Coil Post-Flight Leak Check/V1294.003! | 8h | 9h | 7 |
| 9 | MCC Liner Cavity Decay Check/V1294.003! | 3.25h | 8.25h | 8 |
| 10 | HPOTP Removal and Replacement/V5E02! | 97.75h | 435h | 6,8,9 |
| 11 | HPFTP Removal and Replacement/V5E06! | 101.25h | 375.75h | 7,8,9 |
| 12 | Fuel and Hot Gas System Internal and External Leak Checks/V1294.005! | 8.75h | 21.25h | 11 |
| 13 | LOX System Internal and External Leak Checks/V1294.006! | 8.5h | 20.25h | 12 |
| 14 | SSME Flight Readiness Test and Checkout/V1294.002! | 50.25h | 124h | 13 |
| 15 | GOX System Internal and External Leak Checks/V1294.002! | 2.75h | 12h | 14 |
| 16 | Rotate Engine to Horizontal Handler/V5087! | 4.25h | 38.5h | 15 |
| 17 | Fuel and LOX Ball Seal Leak Checks/V1294.007! | 3.5h | 7.5h | 16 |
| 18 | Move Engine to VAB Transfer Aisle! | 0h | 0h | 17 |
| 19 | Engine Encapsulation Leak Check/V1294.007! | 23.5h | 68.5h | 18 |
| 20 | Move Engine to Engine Shop! | 0h | 0h | 19 |
| 21 | LPFTP Torque Check! | 1.25h | 3.75h | 20 |
| 22 | LPOTP Torque and Shaft Travel! | 3.25h | 9.75h | 21 |

* Lowest level of detail not shown but available for all subtasks. See table 17 for examples.

Table 15. Engine installation to OPF rollout tasks.

| ID | Task Name | Duration | Work | Predecessors | Resource Names |
|----|--|---------------|---------------|--------------|------------------------------|
| 1 | Engine Installation to OPF Roll-Out! | 40.09d | 2207h | | |
| 2 | Engine Installation Operations/V5005! | 11.5d | 733.5h | | |
| 3 | Engine Installation Preps! | 3d | 241h | | |
| 4 | Installation Preps in OPFI | 3d | 93h | | |
| 5 | Remove/Inspect Orbiter Interface Covers (Aft) | 24h | 0h | | |
| 6 | Terminate Aft Compartment ECS Purge Air per V3555 | 0h | 0h | | |
| 7 | Remove PVD Controller Duct | 2h | 4h | 6 | Tech,QC |
| 8 | Photograph Fluid Interface Panels per V41DC0.030 | 1h | 2h | 7 | QC,Engr |
| 9 | Remove Test Plate/Inspect Orbiter LO2 Feedlines per V41BU0.360 | 4h | 12h | 8 | Tech,QC,Engr |
| 10 | Remove Test Plate/Inspect Orbiter LH2 Feedlines per V41BU0.360 | 4h | 12h | 9 | Tech,QC,Engr |
| 11 | Inspect SSME Controller Purge Line | 1h | 2h | 10 | Tech,QC |
| 12 | Reinitiate Aft Compartment ECS Purge Air per V3555 | 0h | 0h | 11 | |
| 13 | Remove Test Plate/Inspect Orbiter LO2/LH2 Bleed Lines | 4h | 8h | 12 | Tech,QC |
| 14 | Remove Test Plate/Inspect Orbiter LO2/LH2 Pressurization Lines | 4h | 8h | 13 | Tech,QC |
| 15 | Remove Test Plate/Inspect Orbiter GHe/GN2 Supply Lines | 4h | 8h | 14 | Tech,QC |
| 16 | Perform MPS Test Requirements (Aft) | 4h | 8h | | QC,Engr |
| 17 | Perform Engine Interface Flange Leak Check Port Verification (Aft) | 4h | 8h | | Tech,QC |
| 18 | Perform Orbiter Preps for SSME Installation (Roc) | 0.5d | 21h | | |
| 19 | Verify Body Flap Full Down | 0h | 0h | | |
| 20 | Perform Gimbal Interface Nut/Bolt Verification | 1h | 1h | | QC |
| 21 | Install Stiffarm Brackets and TVC Actuator Supports per V5057 | 4h | 12h | | Tech[2],QC |
| 22 | Perform Pre-Installation Inspection of Joint O1/F1 Interface Seals | 4h | 8h | | Tech,QC |
| 23 | Installation Preps in Engine Shop! | 1.5d | 148h | | |
| 24 | Install AFV/Helium Baggie Purge Adapters | 4h | 8h | | Tech,QC |
| 25 | Install Liquid Air Insulators | 12h | 24h | | Tech,QC |
| 26 | Perform SSME Engineering Walkdowns | 12h | 108h | | Tech[3],QC[3],Engr[3] |
| 27 | Remove/Inspect Engine Interface Covers | 4h | 8h | | Tech,QC |
| 28 | Engine 1 Installation GSE Handling Operations/V5087! | 0.63d | 34.5h | 5 | |
| 29 | Verify Lift Truck, Carrier and Rail Table Proofload Validations | 0.25h | 0.5h | | Tech,QC |
| 30 | Transfer Engine to Carrier from Horizontal Handler | 1.5h | 6h | 29 | Tech[2],QC,Engr |
| 31 | Establish Safety Clears for Engine Lifting Operations | 0.25h | 3h | 30 | Tech[7],QC,Safety,Engr[3] |
| 32 | Mount Carrier/Engine on Rail Table/Lift Truck | 2h | 24h | 31 | Tech[7],QC,Safety,Engr[3] |
| 33 | Transport Hyster to VAB for Engine 1 Installation | 1h | 1h | 32 | Engr |
| 34 | Engine 1 Installation Operations! | 0.88d | 79h | 28 | |
| 35 | Position Hyster/Installer for Engine 1 Installation | 2h | 26h | | Tech[7],QC[2],Safety,Engr[3] |
| 36 | Terminate Aft Compartment ECS Purge Air per V3555 | 0h | 0h | 35 | |
| 37 | Engine 1 Mate to Orbiter | 4h | 52h | 36 | Tech[7],QC[2],Safety,Engr[3] |
| 38 | Reinitiate Aft Compartment ECS Purge Air per V3555 | 0h | 0h | 37 | |
| 39 | Transport Hyster to VAB | 1h | 1h | 38 | Engr |
| 40 | Engine 3 Installation GSE Handling Preps/V5087! | 0.63d | 34.5h | 39 | |
| 41 | Verify Lift Truck, Carrier and Rail Table Proofload Validations | 0.25h | 0.5h | | Tech,QC |
| 42 | Transfer Engine to Carrier from Horizontal Handler | 1.5h | 6h | 41 | Tech[2],QC,Engr |
| 43 | Establish Safety Clears for Engine Lifting Operations | 0.25h | 3h | 42 | Tech[7],QC,Safety,Engr[3] |
| 44 | Mount Carrier/Engine on Rail Table/Lift Truck | 2h | 24h | 43 | Tech[7],QC,Safety,Engr[3] |
| 45 | Transport Hyster to OPF for Engine 3 Installation | 1h | 1h | 44 | Engr |

Table 15. Engine installation to OPF rollout tasks (Continued).

| ID | Task Name | Duration | Work | Predecessors | Resource Names |
|----|--|---------------|---------------|--------------|------------------------------|
| 46 | Engine 3 Installation Operations! | 0.88d | 79h | 34 | |
| 47 | Position Hyster/Installer for Engine 3 Installation | 2h | 26h | 40 | Tech[7],QC[2],Safety,Engr[3] |
| 48 | Terminate Aft Compartment ECS Purge Air per V3555 | 0h | 0h | 47 | |
| 49 | Engine 3 Mate to Orbiter | 4h | 52h | 48 | Tech[7],QC[2],Safety,Engr[3] |
| 50 | Reinitiate Aft Compartment ECS Purge Air per V3555 | 0h | 0h | 49 | |
| 51 | Transport Hyster to VAB for Engine 2 Installation | 1h | 1h | 49 | Engr |
| 52 | Engine 2 Installation GSE Handling Preps/V5087! | 0.63d | 34.5h | 51 | |
| 53 | Verify Lift Truck, Carrier and Rail Table Proofload Validations | 0.25h | 0.5h | | Tech,QC |
| 54 | Transfer Engine to Carrier from Horizontal Handler | 1.5h | 6h | 53 | Tech[2],QC,Engr |
| 55 | Establish Safety Clears for Engine Lifting Operations | 0.25h | 3h | 54 | Tech[7],QC,Safety,Engr[3] |
| 56 | Mount Carrier/Engine on Rail Table/Lift Truck | 2h | 24h | 55 | Tech[7],QC,Safety,Engr[3] |
| 57 | Transport Hyster to OPF for Engine 2 Installation | 1h | 1h | 56 | Engr |
| 58 | Engine 2 Installation Operations! | 0.88d | 79h | 52 | |
| 59 | Position Hyster/Installer for Engine 2 Installation | 2h | 26h | | Tech[7],QC[2],Safety,Engr[3] |
| 60 | Terminate Aft Compartment ECS Purge Air per V3555 | 0h | 0h | 59 | |
| 61 | Engine 2 Mate to Orbiter | 4h | 52h | 60 | Tech[7],QC[2],Safety,Engr[3] |
| 62 | Reinitiate Aft Compartment ECS Purge Air per V3555 | 0h | 0h | 61 | |
| 63 | Transport Hyster to VAB | 1h | 1h | 62 | Engr |
| 64 | Aft Swings Closed | 0h | 0h | 63 | |
| 65 | SSME 1,2,3 Interface Securing Operations! | 4d | 152h | 64 | |
| 66 | Interface Hardware Installation/GSE Removal | 32h | 96h | | Tech[2],QC |
| 67 | Controller Coolant Duct Installation | 8h | 16h | 64 | Tech,QC |
| 68 | Electrical Interface Connection | 16h | 32h | 64 | Tech,QC |
| 69 | Mate Hydraulic QD's per V58AG0.121/V9002.06 | 4h | 8h | 64 | Tech,QC |
| 70 | SSME Interface Securing Complete | 0h | 0h | 66 | |
| 71 | SSME/MPS Integrated Testing! | 11.28d | 246.5h | 70 | |
| 72 | Low Pressure Pump Post-Installation Torque Checks/V1011.03 Run 3! | 2.25d | 54h | | |
| 73 | Engine 1,2,3 LPFTP Torque Checks | 6h | 18h | | Tech,QC,Engr |
| 74 | Engine 1,2,3 LPOTP Torque Checks | 12h | 36h | 70,73 | Tech,QC,Engr |
| 75 | Orbiter/SSME Interface Verification! | 9.03d | 192.5h | | |
| 76 | GSE Configuration for Leak Checks/V1011.04 | 4h | 4h | 74 | Tech |
| 77 | Fuel Interface Leak Check/V1011.05! | 0.44d | 11h | 76 | |
| 78 | Install Throat Plugs | 2h | 2h | | Tech |
| 79 | Activate MPS 750 psi Pneumatics | 0.25h | 1.5h | 78 | Tech[2],QC[2],Engr[2] |
| 80 | Pressurize MPS LH2 Manifold | 0.25h | 1.5h | 79 | Tech[2],QC[2],Engr[2] |
| 81 | Perform Fuel Feed Joint F1 I/F Leak Checks per V41AX0.020/.030/.040 | 0.5h | 3h | 80 | Tech[2],QC[2],Engr[2] |
| 82 | Perform Fuel Bleed Joint F4.3 I/F Leak Checks per V41AX0.020/.030/.040 | 0.5h | 3h | 81 | Tech[2],QC[2],Engr[2] |
| 83 | LH2 Manifold Decay Test/V1009.05! | 1d | 0h | 77 | |
| 84 | Perform LH2 Manifold Decay Test per V41... | 8h | 0h | | |
| 85 | Vent Fuel System Manifold | 0.25h | 0h | | |
| 86 | Secure MPS 750 psi Pneumatics | 0.25h | 0h | 82 | |
| 87 | SSME Electrical Interface Verification/V9001VL4 | 8h | 16h | 86 | QC,Engr |
| 88 | GOX System Interface Leak Check/V1011.04! | 1d | 33.5h | 87 | |
| 89 | Mate Pneumatic Flexhoses/Leak Check Setup | 2h | 6h | | Tech[2],QC |
| 90 | Close LO2 Prevalves and Pressurize GO2 Pressurization System | 0.5h | 3h | 89 | Tech[2],QC[2],Engr[2] |

Table 15. Engine installation to OPF rollout tasks (Continued).

| ID | Task Name | Duration | Work | Predecessors | Resource Names |
|-----|--|----------|-------|--------------|-----------------------|
| 91 | Power Up SSME Controllers per V9001VL4 | 0.5h | 3.5h | 90 | Tech[2],QC[2],Engr[3] |
| 92 | Perform AFV Crack/Full Open Test per V41BR0.030 | 0.5h | 3.5h | 91 | Tech[2],QC[2],Engr[3] |
| 93 | Power Down SSME Controllers per V9001VL4 | 0.5h | 3.5h | 92 | Tech[2],QC[2],Engr[3] |
| 94 | Perform G02/GCV Ext Leak Check and Orifice Verif. per V41BP0.010 | 0.5h | 3h | 93 | Tech[2],QC[2],Engr[2] |
| 95 | Perform G02 I/F Temperature Xducer Leak Check per V41AY0.320 | 0.5h | 3h | 94 | Tech[2],QC[2],Engr[2] |
| 96 | Perform G02 I/F Flange Leak Check per V41AX0.050 | 0.5h | 3h | 95 | Tech[2],QC[2],Engr[2] |
| 97 | Perform Combined AFV Seat/Shaft Seal Flow Test per V41BQ0.100 | 0.5h | 3h | 96 | Tech[2],QC[2],Engr[2] |
| 98 | Disassemble Test Setup | 2h | 2h | 97 | Tech |
| 99 | Install Joint O18.1 Flight Plates/V1011.041 | 2h | 5h | 88 | |
| 100 | Install AFV Filter/Seal per V41BU0.220 | 1h | 3h | | Tech,QC,Engr |
| 101 | Secure Joint O18.1's | 1h | 2h | 100 | Tech,QC |
| 102 | LOX Interface Leak Check/V1011.051 | 7h | 32h | 99 | |
| 103 | Configure SSME Drain Lines | 1h | 1h | | Tech |
| 104 | Perform MPS 750 psi Pneumatic System Activation | 0.5h | 3h | 103 | Tech[2],QC[2],Engr[2] |
| 105 | Perform LO2 Manifold Pressurization | 0.5h | 3h | 104 | Tech[2],QC[2],Engr[2] |
| 106 | Perform LO2 Feed Joint O1 I/F Leak Checks per V41AX0.020/.030/.040 | 1h | 6h | 105 | Tech[2],QC[2],Engr[2] |
| 107 | Perform LO2 Bleed Joint O15 I/F Leak Checks per V41AX0.020/.030/.040 | 1h | 6h | 106 | Tech[2],QC[2],Engr[2] |
| 108 | Perform LO2 System Interface Mass Spec Leak Checks | 1h | 6h | 107 | Tech[2],QC[2],Engr[2] |
| 109 | Perform Joint O18.1 External Leak Check | 0.5h | 3h | 108 | Tech[2],QC[2],Engr[2] |
| 110 | Vent LO2 Feed and MPS 750 psi Systems | 0.5h | 3h | 109 | Tech[2],QC[2],Engr[2] |
| 111 | Secure LO2 Leak Check Setup | 1h | 1h | 110 | Tech |
| 112 | GSE Configuration for Hot Gas Leak Checks/V1011.05 | 2h | 2h | 102 | Tech |
| 113 | Install Throat Plugs/V1011.05 | 2h | 4h | 112 | Tech,QC |
| 114 | Hot Gas System Interface Leak Checks/V1011.051 | 6h | 22.5h | 113 | |
| 115 | Configure SSME Drain Lines | 0.5h | 0.5h | | Tech |
| 116 | Configure GH2 Pressurization System for Flow Test | 0.5h | 0.5h | | Tech |
| 117 | Perform GH2 Pressurization System Flow Test per V41BZ0.080 | 0.5h | 1.5h | 116 | Tech,QC,Engr |
| 118 | Perform GH2 I/F Pressure Xducer Leak Check per V41AY0.350 | 1h | 6h | 117 | Tech[2],QC[2],Engr[2] |
| 119 | Perform GH2 Press Joint F9.3 I/F Leak Check per V41AX0.020/.030/.040 | 1h | 6h | 118 | Tech[2],QC[2],Engr[2] |
| 120 | Perform GH2 System Interface Mass Spec Leak Checks | 0.5h | 3h | 119 | Tech[2],QC[2],Engr[2] |
| 121 | Vent Hot Gas System | 0.5h | 3h | 120 | Tech[2],QC[2],Engr[2] |
| 122 | Perform PD16 Hardware Installation | 1h | 1h | 121 | Tech |
| 123 | Secure Hot Gas Leak Check Setup | 1h | 1h | 122 | Tech |
| 124 | Throat Plug Removal/V1011.05 | 2h | 2h | 114 | Tech |
| 125 | Pneumatic System Interface Leak Checks/V1011.051 | 3.5h | 12.5h | 124 | |
| 126 | Configure SSME Drain Lines | 0.5h | 0.5h | | Tech |
| 127 | Perform SSME 750 psi Pneumatic System Activation | 1h | 5h | 126 | Tech,QC[2],Engr[2] |
| 128 | Perform Pneumatic I/F Joint P1 Leak Check per V41AX0.020/.030/.040 | 1h | 5h | 127 | Tech,QC[2],Engr[2] |
| 129 | Secure SSME 750 psi Pneumatic System | 1h | 2h | 128 | QC,Engr |
| 130 | Fuel System Interface Insulation Installation/V1011.05 | 24h | 48h | 125 | Tech,QC |
| 131 | SSME Engine and Dome Mounted Heat Shield Installation Operations! | 126h | 1056h | 125 | |
| 132 | Position Davit Crane on 19R/G41-20017 | 2h | 12h | | Tech[4],QC[2] |
| 133 | Install E-1 R/H EMHS/V41-50024 | 2h | 12h | | Tech[4],QC[2] |
| 134 | Install E-3 L/H EMHS/V41-50026 | 2h | 12h | 133 | Tech[4],QC[2] |
| 135 | Install E-3 R/H EMHS/V41-50026 | 2h | 12h | 134 | Tech[4],QC[2] |
| 136 | Verify E-3 EMHS Splice Line Hardware Torque Complete/Verify Bolt Protrusion Complete | 0h | 0h | 135 | Tech[4],QC[2] |

Table 15. Engine installation to OPF rollout tasks (Continued).

| ID | Task Name | Duration | Work | Predecessors | Resource Names |
|-----|--|--------------|-------------|--------------|------------------------|
| 137 | Install E-3 R/H DMHS/V41-50023 | 2h | 12h | 136 | Tech[4],QC[2] |
| 138 | Install E-3 L/H DMHS/V41-50023 | 2h | 12h | 137 | Tech[4],QC[2] |
| 139 | Position Davit Crane on 19L/G41-20017 | 1h | 6h | 138 | Tech[4],QC[2] |
| 140 | Install E-1 L/H EMHS/V41-50024 | 2h | 12h | 139 | Tech[4],QC[2] |
| 141 | Install E-2 L/H EMHS/V41-50025 | 2h | 12h | 140 | Tech[4],QC[2] |
| 142 | Install E-2 R/H EMHS/V41-50025 | 2h | 12h | 141 | Tech[4],QC[2] |
| 143 | Verify E-1 EMHS Splice Line Hardware Torque Complete/Verify Bolt Protrusion Complete | 0h | 0h | 142 | Tech[4],QC[2] |
| 144 | Verify E-2 EMHS Splice Line Hardware Torque Complete/Verify Bolt Protrusion Complete | 0h | 0h | 143 | Tech[4],QC[2] |
| 145 | Install E-1 L/H DMHS/V41-50021 | 2h | 12h | 144 | Tech[4],QC[2] |
| 146 | Install E-2 R/H DMHS/V41-50022 | 2h | 12h | 145 | Tech[4],QC[2] |
| 147 | Install E-2 L/H DMHS/V41-50022 | 2h | 12h | 146 | Tech[4],QC[2] |
| 148 | Position Davit Crane on 19R/G41-20017 | 1h | 6h | 147 | Tech[4],QC[2] |
| 149 | Install E-1 R/H DMHS/V41-50021 | 2h | 12h | 148 | Tech[4],QC[2] |
| 150 | Lower Davit Crane from Level 19/G41-20017 | 2h | 12h | 149 | Tech[4],QC[2] |
| 151 | Heat Shield Securing/Splice Line Configuration/V41-5002x | 48h | 288h | 150 | Tech[4],QC[2] |
| 152 | Install Carrier Panels/V80-95907,33,35 | 98h | 588h | 150 | Tech[4],QC[2] |
| 153 | SSME Gimbal Clearance Checks! | 17.5h | 123h | | |
| 154 | Pin TVC Actuators/V1063/V5057 | 4h | 12h | 152 | Tech[2],QC |
| 155 | Install Marking Tape on SSME Nozzle Tubes | 2h | 2h | 154 | Tech |
| 156 | Perform SSME Heat Shield Verification | 1h | 1h | 155 | Tech |
| 157 | Hydraulic System Power-Up/V1063/V9002.01 | 2h | 20h | 156 | Tech[3],QC[3],Engr[4] |
| 158 | MPS TVC Full Excursion Gimbal Clearance Checks/V1063 | 4.5h | 45h | 157 | Tech[3],QC[3],Engr[4] |
| 159 | SSME TVC Toe-In Clearance Checks/V1063 | 1.5h | 15h | 158 | Tech[3],QC[3],Engr[4] |
| 160 | SSME TVC Actuator Drift Test/V1063 | 1.5h | 15h | 159 | Tech[3],QC[3],Engr[4] |
| 161 | Orbiter Hydraulic Power-Down/V1063/V9002.01 | 1h | 10h | 160,162 | Tech[3],QC[3],Engr[4] |
| 162 | Hydraulic QD Leak Checks per V41AX0.020/.030/.040/V9002.06 | 1h | 3h | 157 | Tech,QC,Engr |
| 163 | SSME OPF Roll-Out Inspections/V41-200031 | 19h | 48h | 153 | |
| 164 | Perform SSME Valve Position Verification | 2h | 10h | | Tech,QC,Safety,Engr[2] |
| 165 | TVC Actuator Midstroke Lock Installation/V5057 | 4h | 12h | 164,162 | Tech[2],QC |
| 166 | Thrust Chamber Cover Installation/V5057 | 2h | 4h | 165 | Tech,QC |
| 167 | Verify Thrust Chamber Covers Installed per V41BW0.031 | 0.25h | 0.5h | 166 | Tech,QC |
| 168 | Verify Bellows Covers Installed per V41BW0.031 | 0.25h | 0.5h | 167 | Tech,QC |
| 169 | Verify TVC Actuators Connected per V41BW0.031 | 0.25h | 0.5h | 168 | Tech,QC |
| 170 | Verify Midstroke Locks Installed per V41BW0.031 | 0.25h | 0.5h | 169 | Tech,QC |
| 171 | Install Miscellaneous Covers per V5057 | 2h | 4h | 170 | Tech,QC |
| 172 | Visually Inspect Engine Components for Damage | 8h | 16h | 171 | Tech,QC |
| 173 | Aft Closeout for OPF Roll-Out Complete | 0h | 0h | 163 | |
| 174 | Orbiter Roll-Out to VAB | 0h | 0h | 173 | |

Table 16. VAB rollin to launch tasks.

| ID | Task Name | Duration | Work | Predecessors | Resource Names |
|----|---|----------------|----------------|--------------|----------------|
| 1 | VAB Roll-in to Launch! | 484.87h | 592.35h | | |
| 2 | Orbiter/ET Mate Operations/S0004I | 144h | 0h | | |
| 3 | Orbiter in Transfer Aisle | 0h | 0h | | |
| 4 | Connect Sling/Preps for Orbiter Lift | 8h | 0h | 3 | |
| 5 | Rotate Orbiter to Vertical/Disconnect Aft Sling | 8h | 0h | 4 | |
| 6 | Orbiter/ET Softmate | 8h | 0h | 5 | |
| 7 | Orbiter/ET Hardmate | 4h | 0h | 6 | |
| 8 | Sling Removal | 4h | 0h | 7 | |
| 9 | TSM Connect | 16h | 0h | 8 | |
| 10 | Umbilical Mate | 16h | 0h | 8 | |
| 11 | Monoball Connect/Closeout | 24h | 0h | 9 | |
| 12 | Hazardous Gas Leak Checks | 8h | 0h | 9 | |
| 13 | Ultrasonic Inspections | 4h | 0h | 10 | |
| 14 | TSM Static Measurement | 8h | 0h | 9 | |
| 15 | External Umbilical Can Closeout | 8h | 0h | 12,14 | |
| 16 | Ready for Orbiter Power-Up | 0h | 0h | 15 | |
| 17 | Umbilical Foaming | 40h | 0h | 15 | |
| 18 | Purge Curtain Installation | 40h | 0h | 17 | |
| 19 | Shuttle Interface Testing/S0008I | 38h | 0h | | |
| 20 | Shuttle Interface Testing Preps | 18h | 0h | | |
| 21 | Orbiter Power-Up | 0h | 0h | 20 | |
| 22 | Orbiter System Checks | 8h | 0h | 21 | |
| 23 | S0008 Testing | 4h | 0h | 20 | |
| 24 | ET/SRB Power-Up | 0h | 0h | 23 | |
| 25 | ET/SRB System Checks | 8h | 0h | 24 | |
| 26 | SRB TVC Actuator Testing | 4h | 0h | 25 | |
| 27 | Connect SRB TVC Actuators | 4h | 0h | 26 | |
| 28 | Umbilical Interface Leak Checks/V1149I | 30h | 33.75h | | |
| 29 | Umbilical Interface Leak Check Preps! | 12h | 2h | | |
| 30 | Perform GN2 Flowmeter Setup | 4h | 0h | | |
| 31 | Perform LO2/LH2 TSM Line Verification | 4h | 0h | | |
| 32 | Perform SSME Trickle Purge Activation | 1.5h | 2h | 31 | |
| 33 | Verify PD14 GN2 Purge T-0 Disconnect Mated | 0h | 0h | | |
| 34 | Perform Thrust Chamber Cover Removal/V5057 | 1h | 1h | | Tech |
| 35 | Activate/Verify SSME Trickle Purge per S00000.100 | 0.5h | 1h | 34 | Tech,QC |
| 36 | Perform TP8 Configuration | 4h | 0h | 31 | |
| 37 | Perform PD4/PD5 HUMS Leak Check Preps | 8h | 0h | 31 | |
| 38 | Perform Mass Spec Leak Check Preps | 8h | 0h | 31 | |
| 39 | Perform Mass Spec Leak Check Machine Preps | 2h | 0h | 31 | |
| 40 | Umbilical Interface Leak Check Operations! | 18h | 31.75h | 29 | |

Table 16. VAB rollin to launch tasks (Continued).

| ID | Task Name | Duration | Work | Predecessors | Resource Names |
|----|--|------------|---------------|--------------|---------------------------------|
| 41 | Orbiter MPS Helium Fill QD Leak Check | 2h | 0h | | |
| 42 | 17 Inch Disconnect Timing Checks/200 psi Leak Checks | 8h | 0h | 41 | |
| 43 | MPS LOX Fill and Drain QD Leak Check | 4h | 0h | 42 | |
| 44 | MPS LH2 Fill and Drain QD Leak Check | 4h | 0h | 43 | |
| 45 | SSME GN2 Heater Checkout/GN2 Leak Checks | 4h | 25.75h | | |
| 46 | Configure Heater Power Circuit Breakers | 0.25h | 1h | | Tech, QC, Engr[2] |
| 47 | Verify Panel Valve Configuration | 0.25h | 1h | 46 | Tech, QC, Engr[2] |
| 48 | Perform Automated GN2 Panel Valve Checkout | 0.5h | 2h | 47 | QC, Engr[2], Tech |
| 49 | Close TSM GN2 Supply Valve | 0.25h | 1.25h | 48 | Tech[2], QC, Engr[2] |
| 50 | Pressurize GN2 Panel | 0.25h | 1h | 49 | Tech, QC, Engr[2] |
| 51 | Establish Safety Clears | 0.25h | 2h | 50 | Tech[2], QC[3], Safety, Engr[2] |
| 52 | Open TSM GN2 Supply Valve | 0.25h | 2h | 51 | Tech[2], QC[3], Engr[2], Safety |
| 53 | Verify No Leakage @ PD14 GN2 Purge Interface per S00000.020 | 0.25h | 2h | 52 | Tech[2], QC[3], Engr[2], Safety |
| 54 | Perform Bubble Soap Leak Check of TSM GN2 Lines | 0.25h | 2h | 53 | Tech[2], QC[3], Engr[2], Safety |
| 55 | Perform Orbiter GN2 Joint Leak Check | 0.25h | 2h | 54 | Tech[2], QC[3], Engr[2], Safety |
| 56 | Perform SSME GN2 Joint Leak Check | 0.25h | 2h | 55 | Tech[2], QC[3], Engr[2], Safety |
| 57 | Perform GN2 I/F Joint N1 Leak Check per V41AX0.020/.030/.040 | 0.25h | 2h | 56 | Tech[2], QC[3], Engr[2], Safety |
| 58 | Perform SSME GN2 Heater Checkout | 0.5h | 4h | 57 | Tech[2], QC[3], Engr[2], Safety |
| 59 | Secure GN2 Flow | 0.25h | 1.5h | 58 | Tech[2], QC[2], Engr[2] |
| 60 | SSME MFV Heater T-0 Interface Verification | 2h | 6h | 59 | |
| 61 | Power Up Distributor Panels | 0.25h | 0.75h | | QC, Engr[2] |
| 62 | Close Panel Circuit Breakers | 0.25h | 0.75h | 61 | Tech, QC, Engr |
| 63 | Perform MFV Heater Checkout per S00000.101 | 1h | 3h | 62 | Tech, QC, Engr |
| 64 | Open Panel Circuit Breakers | 0.25h | 0.75h | 63 | Tech, QC, Engr |
| 65 | Power Down Distributor Panels | 0.25h | 0.75h | 64 | QC, Engr[2] |
| 66 | VAB Roll-Out Operations/452141 | 44h | 0h | | |
| 67 | Roll-Out Preps | 24h | 0h | 2 | |
| 68 | Shuttle Transfer to Launch Pad | 12h | 0h | 67 | |
| 69 | Crawler Transport Operations | 8h | 0h | 68 | |
| 70 | Launch Pad Validation Preps/S0009 POSU's | 12h | 0h | 67 | |
| 71 | Shuttle 1st Motion to Pad | 0h | 0h | 68 | |
| 72 | MLP Harddown at Pad | 0h | 0h | 71, 69 | |
| 73 | Launch Pad Validation/S00091 | 44h | 12h | 72 | |
| 74 | Perform PD15/PD16 Connect | 44h | 0h | | |
| 75 | Perform A2202 Firex Verification | 8h | 0h | | |
| 76 | Activate Pad Helium Supply Panel | 8h | 0h | | |
| 77 | Activate SSME Trickle Purge | 4h | 12h | | Tech, QC, Engr |
| 78 | Activate T-0 Trickle Purge | 8h | 0h | | |
| 79 | Perform LDB Safing Panel Verification | 8h | 0h | | |
| 80 | Perform Propellant System Switch Validation | 8h | 0h | | |

Table 16. VAB rollin to launch tasks (Continued).

| ID | Task Name | Duration | Work | Predecessors | Resource Names |
|-----|--|-------------|-------------|--------------|--------------------|
| 81 | Perform Recirc Pump Switch Validation | 8h | 0h | | |
| 82 | Perform ET OI Power Up | 8h | 0h | | |
| 83 | Perform ET OI Instrumentation Checks | 8h | 0h | | |
| 84 | Perform ET Level Sensor Cals | 8h | 0h | | |
| 85 | Perform Valve Verifications for G2340 LO2/LH2 Checkouts | 8h | 0h | | |
| 86 | Perform ET OI Power Down | 8h | 0h | | |
| 87 | Extend RSS | 0h | 0h | 73 | |
| 88 | Engine Flight Readiness Testing/V1046.0011 | 21h | 52h | | |
| 89 | Preps for SSME Hydraulic Operations/V9002.06 | 7h | 15h | | |
| 90 | SSME Engineering Determine Configuration Required Configuration for Hydraulics | 1h | 1h | | Engr |
| 91 | Perform TVC Actuator Preps for Hydraulic Operations/V5057 | 4h | 12h | 90 | Tech[2],QC |
| 92 | Remove Drain Line Adapters and Environmental Throat Plugs | 1h | 1h | 91 | Tech |
| 93 | Perform SSME LFPD Helium Barrier Purge System Venting | 1h | 1h | 92 | Tech |
| 94 | SSME Controller Power-Up/V9001VL4 | 1h | 7h | 89 | QC[3],Engr[4] |
| 95 | Shuttle Flight Control System Activation Complete | 0h | 0h | 94 | |
| 96 | SSME Controller Load and Sensor Checkout/V9001VL4 | 1h | 7h | 95 | QC[3],Engr[4] |
| 97 | Hydraulic System Pressurization Complete | 0h | 0h | 96 | |
| 98 | Activate SSME 750 psi Pneumatics | 0.5h | 3.5h | 97 | QC[3],Engr[4] |
| 99 | SSME Hydraulic System Conditioning and Actuator Checkout | 0.5h | 3.5h | 98 | QC[3],Engr[4] |
| 100 | SSME Flight Readiness Test | 2h | 16h | 99 | Tech,QC[3],Engr[4] |
| 101 | SSME Controller Power-Down | 0h | 0h | 100 | |
| 102 | Hydraulics and Flight Control Closeout Operations! | 9h | 0h | 101 | |
| 103 | Aerosurface and SSME Cycling/V1308 | 3h | 0h | | |
| 104 | Hydraulic System Compressibility/V9002.07 | 1.5h | 0h | 103 | |
| 105 | Frequency Response Testing/V1034 | 3h | 0h | 103 | |
| 106 | Hydraulic System Closeouts and Securing/V9002.02 | 3h | 0h | 105 | |
| 107 | SSME Pneumatics Secured | 0h | 0h | 105 | |
| 108 | SSME Ball Seal Leak Check Operations/V1046.002/V1046.0031 | 4h | 27h | 88 | |
| 109 | Install Base Heat Shield Access Ladder/V35-00008 | 1.5h | 4.5h | 106 | Tech[2],QC |
| 110 | SSME/TVC Actuator Hydraulic Power-Down Securing Requirements/V9002.06 | 3.5h | 6.5h | | |
| 111 | SSME Engineer Determine Required Power Down Configuration | 1h | 1h | | Engr |
| 112 | Install Midstroke Locks/V5057 | 1.5h | 4.5h | 111 | Tech[2],QC |
| 113 | Vent Bleeder Plug at Joint P20.2 | 1h | 1h | 112 | Tech |
| 114 | Install SSME Throat Plugs/V1046.002 | 2h | 6h | | Tech,QC,Safety |
| 115 | Fuel Valve Ball Seal Leak Check/V1046.002 | 1h | 5h | 114 | Tech,QC[2],Engr[2] |
| 116 | Oxidizer Valve Ball Seal Leak Check/V1046.003 | 1h | 5h | 115 | Tech,QC[2],Engr[2] |
| 117 | SSME Hydraulic QD X-Rays/V9002.06 | 4h | 8h | 116 | Tech,QC |
| 118 | LO2 Feed/SSME Pneumatics Vented | 0h | 0h | 114 | |
| 119 | LH2 Feed Vented | 0h | 0h | 115 | |
| 120 | G02 Blanking Plate Installation/T1402! | 6h | 0h | 119 | |

Table 16. VAB rollin to launch tasks (Continued).

| ID | Task Name | Duration | Work | Predecessors | Resource Names |
|-----|---|-------------|--------------|----------------|------------------|
| 121 | GH2 Blanking Plate Installation/T14011 | 6h | 0h | 120 | |
| 122 | Orbiter/ET 17 inch Disconnect Cavity Purge Verification/V11491 | 8h | 0h | 120,121 | |
| 123 | Helium Signature Test/V12021 | 34h | 18h | 120,121 | |
| 124 | SSME Preps for Helium Signature Test! | 7h | 18h | | |
| 125 | Install Drain Line Closures | 1h | 1h | | Tech |
| 126 | Establish Safety Clears/OK for Thrust Chamber Entry | 1h | 3h | 125 | Tech, QC, Safety |
| 127 | Perform MCC Liner Taping | 2h | 6h | 126 | Tech, QC, Safety |
| 128 | Install Throat Plug and Monitor Gage Manifold | 2.5h | 7.5h | 127 | Tech, QC, Safety |
| 129 | Mate Flexhose Between Supply Panel and Manifold | 0.5h | 0.5h | 128 | Tech |
| 130 | Perform PV13 GN2 Panel Setup | 7h | 0h | 127 | |
| 131 | Haz Gas Detection System Preps | 3h | 0h | 130 | |
| 132 | Pre-Test Helium Intrusion Test | 4h | 0h | 131 | |
| 133 | MPS GH2/LO2 Feed and SSME Hot Gas System Test | 3h | 0h | 132 | |
| 134 | GO2 System Test | 2h | 0h | 133 | |
| 135 | LH2 Feed System | 2h | 0h | 134 | |
| 136 | Orbiter Post-Test Operations | 9h | 0h | 135 | |
| 137 | GO2 Blanking Plate Installation/T14021 | 6h | 0h | 135 | |
| 138 | GH2 Blanking Plate Installation/T14011 | 6h | 0h | 137 | |
| 139 | Ordnance Installation Operations - Part 1! | 40h | 0h | | |
| 140 | Ordnance Installation/PIC Resistance Checks/S5009 | 16h | 0h | 138 | |
| 141 | Ordnance Closeouts/S5009 | 24h | 0h | 140 | |
| 142 | Pre-Launch Hypergolic Propellant Loading Operations/S0024! | 64h | 0h | | |
| 143 | Propellant Loading Operations/S0024 | 40h | 0h | 141 | |
| 144 | Propellant Loading Closeouts/S0024 | 24h | 0h | 143 | |
| 145 | Ordnance Installation Operations - Part 2! | 48h | 0h | | |
| 146 | SRSS System Test | 8h | 0h | 144 | |
| 147 | Ordnance Connect/PIC Resistance Checks/S5009 | 16h | 0h | 146 | |
| 148 | Ordnance Closeouts/S5009 | 24h | 0h | 147 | |
| 149 | LOX System Dewpoint and Conditioning/S1005! | 6.5h | 7.75h | 148 | |
| 150 | SSME Thrust Cover Removal/Drain Line Adapter Installation/V5057 | 2h | 4h | 147 | Tech, QC |
| 151 | Rocketdyne Tech on Station for Dewpoints | 2.75h | 2.75h | 150 | Tech |
| 152 | Orbiter and ET OI Power-Up | 0.5h | 0h | 150 | |
| 153 | SSME Trickle Purge Securing | 1h | 1h | 152 | Tech |
| 154 | MPS 750 psi Pneumatics Activation | 1.5h | 0h | 152 | |
| 155 | ET LOX Tank, SSME, TSM Vent and Engine Bleed Dewpoint | 1.5h | 0h | 153 | |
| 156 | Main Fill and Drain Dewpoint | 1.75h | 0h | 154 | |
| 157 | LOX ET Pressure Maintenance | 2.5h | 0h | 154 | |
| 158 | LH2 System Dewpoint and Conditioning/S1006! | 9.5h | 6h | 149 | |
| 159 | LH2 and MPS/SSMEC Power-Up | 2h | 6h | 150 | QC, Engr[2] |
| 160 | ET/Orbiter Purge and Sample | 5h | 0h | 159 | |

Table 16. VAB rollin to launch tasks (Continued).

| ID | Task Name | Duration | Work | Predecessors | Resource Names |
|-----|---|----------------|----------------|--------------|----------------------|
| 161 | Transfer Line Purge and Sample | 1.5h | 0h | 160 | |
| 162 | Vaporizer Purge | 1h | 0h | 161 | |
| 163 | Orbiter Aft Closeout/S12871 | 100h | 290h | 148 | |
| 164 | Aft Confidence Test - Pre-Door Installation | 12h | 0h | 148 | |
| 165 | SSME MCC Polishing | 8h | 24h | 164 | Tech, QC, Safety |
| 166 | TVC Actuator Flight Closeout and Insulation Installation/V5057 | 34h | 102h | 164 | Tech[2], QC |
| 167 | MPS Engineering Verification and Walkdown | 8h | 0h | 164 | |
| 168 | MPS Initial Preps for Flight/V9018.001 | 8h | 0h | 167 | |
| 169 | PD15/PD16 ET Standby Pressure Monitor Securing | 8h | 0h | 167 | |
| 170 | EMHS Insulation Inspection per V41BU0.420 | 8h | 24h | 168,169 | Tech, QC, Safety |
| 171 | SSME Engineering Walkdown | 8h | 40h | 170 | Engr[5] |
| 172 | SSME Initial Preps for Flight/V9018.001 | 8h | 24h | 171 | Tech, QC, Engr |
| 173 | SSME Quality Walkdown per V41BU0.070 | 16h | 32h | 171 | Tech, QC |
| 174 | MPS VJ Line Checks/V9019 | 8h | 0h | 173 | |
| 175 | Verify Midstroke Locks Removed | 0h | 0h | 173 | |
| 176 | LFPD Baggie Installation | 6h | 18h | 173 | Tech, QC, Engr |
| 177 | LFPD Baggie Leak Check per V41BU0.380 | 2h | 10h | 176 | Tech, QC[2], Engr[2] |
| 178 | EMHS Debris Shield Removal | 8h | 8h | 177 | Tech |
| 179 | MPS Protective Cover Removal/V35-00002 | 16h | 0h | 176,174 | |
| 180 | SSME Protective Cover Removal/V5057 | 8h | 8h | 179 | Tech |
| 181 | MPS Solenoid Protective Cover Removal/V35-00003 | 8h | 0h | 179 | |
| 182 | Install Aft 50-1/50-2 Doors for Flight | 4h | 0h | 181,180,181 | |
| 183 | MPS Functional Verification for Flight - Post-Door Installation/V9018.001 | 8h | 0h | 181 | |
| 184 | S0007 Launch Countdown Operations! | 364.87h | 137.85h | | |
| 185 | S0007 Launch Countdown Preps! | 80h | 36h | 163 | |
| 186 | S0007 Launch Countdown Preps | 80h | 0h | 163 | |
| 187 | SSME Drag On Panel Purge Preps/S0007VL1 POSU 8 | 12h | 36h | | Tech, QC, Engr |
| 188 | S0007 Seq 14: T-43 hours to T-11 hours! | 64h | 6.25h | 163,186 | QC, Engr[2] |
| 189 | S0007 Seq 15: T-11 hours to T-6 hours! | 7h | 21h | 188 | QC, Engr[2] |
| 190 | S0007 Seq 16: T-6 hours to Launch! | 8.87h | 26.6h | 189 | QC, Engr[2] |
| 191 | Shuttle Liftoff! | 0h | 0h | 190 | |
| 192 | S0007 Seq 17: Post-Launch Securing Operations | 16h | 48h | 191 | QC, Engr[2] |

Table 17. Example of detailed data for scheduled processing in OMEF.

| ID | Task Name | Duration | Work | Predecessors | Resource Names |
|----|---|---------------|----------------|--------------|----------------|
| 1 | SSME Inspections in Engine Shop (continued)/V1011.021 | 67.98h | 135.75h | | |
| 2 | External Inspections! | 67.98h | 36h | | |
| 3 | Perform Nozzle External Inspections per V41BU0.030 | 8h | 24h | | Tech, QC, Engr |
| 4 | Perform Liquid Air Insulator Inspections per V41BU0.033 | 2h | 4h | 3 | QC, Engr |
| 5 | Perform Main Injector LOX Post Bias Checks per V41BU0.034 | 4h | 8h | 4 | QC, Engr |
| 6 | MCC and Nozzle Inspections! | 17.5h | 34.5h | | |
| 7 | Install Thrust Chamber Protective Liner | 0.5h | 0.5h | | Tech |
| 8 | Perform Post-Flight Nozzle Inspections per V41BU0.353 | 2h | 4h | 7 | QC, Engr |
| 9 | Perform Post-Flight MCC Liner Inspection per V41BU0.351 | 4h | 8h | 8 | QC, Engr |
| 10 | Perform Post-Flight MCC Liner Polishing per V41BU0.351 | 8h | 16h | 9 | Tech, QC |
| 11 | Post-Polishing MCC Liner Inspection per V41BU0.351 | 1h | 2h | 10 | QC, Engr |
| 12 | Perform MCC Bondline Ultrasonic Inspection per V41BU0.031 | 2h | 4h | 11 | QC, Engr |
| 13 | Internal Inspections! | 16.25h | 65.25h | 6 | |
| 14 | Perform Flow Recirculation Inhibitor Inspection per V41BU0.040 | 1h | 1h | | Engr |
| 15 | Perform Main Injector Face Side Inspections per V41BU0.040 | 4h | 4h | 14 | Engr |
| 16 | Perform Main Combustion Chamber Inspections per V41BU0.040 | 2h | 4h | 15 | QC, Engr |
| 17 | Perform Fuel Preburner Internal Inspection per V41BU0.040 | 4h | 8h | | QC, Engr |
| 18 | Perform Oxidizer Preburner Internal Inspections per V41BU0.040 | 4h | 4h | | Engr |
| 19 | Perform Main Injector Internal Inspections per V41BU0.040 | 4h | 4h | 17, 18 | Engr |
| 20 | Verify Heat Exchanger Coils Internal Inspection performed per V5E02 | 0.25h | 0.25h | 19 | QC |
| 21 | Perform HPFTP Internal Inspections per V41BU0.075 | 8h | 24h | | Tech, QC, Engr |
| 22 | Perform HPOTP Internal Inspections per V41BU0.065 | 8h | 16h | | Tech, Engr |

| ID | Task Name | Duration | Work | Predecessors | Resource Names |
|----|--|-------------|--------------|--------------|----------------|
| 1 | HPFTP Post-Flight Torque Check/V1011.03 Run 11 | 3.5h | 10.5h | | |
| 2 | Remove HPFTP Thrust Bearing Housing @ Joint F3.1 | 0.5h | 1.5h | | Tech, QC, Engr |
| 3 | Install HPFTP Torque Tool | 0.5h | 1.5h | 2 | Tech, QC, Engr |
| 4 | Perform HPFTP Torque Check per V41BS0.020 | 0.5h | 1.5h | 3 | Tech, QC, Engr |
| 5 | Perform HPFTP Shaft Position and Axial Travel per V41BS0.020 | 1.5h | 4.5h | 4 | Tech, QC, Engr |
| 6 | Install Protective Cover @ HPFTP Joint F3.1 | 0.5h | 1.5h | 5 | Tech, QC, Engr |

| ID | Task Name | Duration | Work | Predecessors | Resource Names |
|----|--|--------------|---------------|--------------|----------------|
| 1 | HPOTP Post-Flight Torque Check/V1011.03 Run 11 | 3.75h | 11.25h | | |
| 2 | Remove HPOTP Torque Access Plate @ Joint O9.1 | 0.25h | 0.75h | | Tech, QC, Engr |
| 3 | Perform HPOTP Torque Check per V41BS0.040 | 0.5h | 1.5h | 2 | Tech, QC, Engr |
| 4 | Perform HPOTP Shaft Travel Measurement per V41BS0.044 | 2h | 6h | 3 | Tech, QC, Engr |
| 5 | Perform PBP Impeller Bolt Lock Inspection per V41BS0.043 | 0.5h | 1.5h | 4 | Tech, QC, Engr |
| 6 | Install HPOTP Torque Access Plate @ Joint O9.1 | 0.5h | 1.5h | 5 | Tech, QC, Engr |

APPENDIX C—Unscheduled SSME Operations Data

Figures 20–24 and tables 18–19 present the detailed data collected from SSME processing experience at KSC relative to unscheduled activities. Figures 20–24 present the remaining unscheduled processing classification types. The sixth, base R&R, is presented in section 5. Following these figures, an unscheduled summary data table (table 18) is presented. Finally, an example of the existing level of detail supporting the flow layouts is presented in table 19.

| ID | Duration (hr) | Man-hr | y | | Wednesday | | | Thursday | | | Friday | | | Saturday | | | Sunday | | |
|----|---------------|--------|---|----|-----------|---|----|----------|---|----|--------|---|----|----------|---|----|--------|---|----|
| | | | 4 | 12 | 8 | 4 | 12 | 8 | 4 | 12 | 8 | 4 | 12 | 8 | 4 | 12 | 8 | 4 | 12 |
| 1 | 24.43 | 1 | | | | | | | | | | | | | | | | | |
| 2 | 0.25 | 0.25 | | | | | | | | | | | | | | | | | |
| 3 | 0.25 | 0.25 | | | | | | | | | | | | | | | | | |
| 4 | 0.5 | 0.5 | | | | | | | | | | | | | | | | | |
| 5 | 0.5 | 0.5 | | | | | | | | | | | | | | | | | |
| 6 | 0.5 | 0.5 | | | | | | | | | | | | | | | | | |
| 7 | 11.98 | 12 | | | | | | | | | | | | | | | | | |
| 8 | 8 | 8 | | | | | | | | | | | | | | | | | |
| 9 | 4 | 4 | | | | | | | | | | | | | | | | | |
| 10 | 13.9 | 0 | | | | | | | | | | | | | | | | | |
| 11 | 1 | 0 | | | | | | | | | | | | | | | | | |
| 12 | 8 | 0 | | | | | | | | | | | | | | | | | |
| 13 | 2 | 0 | | | | | | | | | | | | | | | | | |
| 14 | 0.5 | 0 | | | | | | | | | | | | | | | | | |

Figure 20. Base MR accept.

| ID | Duration (hr) | Man-hr | y | | Wednesday | | | Thursday | | | Friday | | | Saturday | | | Sunday | | |
|----|---------------|--------|---|----|-----------|---|----|----------|---|----|--------|---|----|----------|---|----|--------|---|----|
| | | | 4 | 12 | 8 | 4 | 12 | 8 | 4 | 12 | 8 | 4 | 12 | 8 | 4 | 12 | 8 | 4 | 12 |
| 1 | 33.42 | 1 | | | | | | | | | | | | | | | | | |
| 2 | 0.25 | 0.25 | | | | | | | | | | | | | | | | | |
| 3 | 0.25 | 0.25 | | | | | | | | | | | | | | | | | |
| 4 | 0 | 0 | | | | | | | | | | | | | | | | | |
| 5 | 0.5 | 0.5 | | | | | | | | | | | | | | | | | |
| 6 | 11.98 | 12 | | | | | | | | | | | | | | | | | |
| 7 | 8 | 8 | | | | | | | | | | | | | | | | | |
| 8 | 4 | 4 | | | | | | | | | | | | | | | | | |
| 9 | 32.43 | 12.5 | | | | | | | | | | | | | | | | | |
| 10 | 0.5 | 0.5 | | | | | | | | | | | | | | | | | |
| 11 | 4 | 4 | | | | | | | | | | | | | | | | | |
| 12 | 8 | 8 | | | | | | | | | | | | | | | | | |
| 13 | 2.5 | 0 | | | | | | | | | | | | | | | | | |
| 14 | 2 | 0 | | | | | | | | | | | | | | | | | |
| 15 | 0.5 | 0 | | | | | | | | | | | | | | | | | |

Figure 21. Base MR repair.

| ID | Duration (hr) | Man-hr | Wednesday | | | Thursday | | | Friday | | | Saturday | | | Sunday | | |
|----|---------------|--------|-----------|----|---|----------|----|--------------------------------------|--------|----|---|----------|----|---|--------|----|---|
| | | | 4 | 12 | 8 | 4 | 12 | 8 | 4 | 12 | 8 | 4 | 12 | 8 | 4 | 12 | 8 |
| 1 | 0.48 | 0.5 | | | | 0.5h | ▼ | PR Performance Time | | | | | | | | | |
| 2 | 0.25 | 0.25 | | | | 0.25h | ▮ | Determine PR Condition | | | | | | | | | |
| 3 | 0.25 | 0.25 | | | | 0.25h | ▮ | Initiate PR Paperwork | | | | | | | | | |
| 4 | 0.5 | 0.5 | | | | 0.5h | ▼ | PR Administrative Time | | | | | | | | | |
| 5 | 0.5 | 0.5 | | | | 0.5h | ▮ | QE Research/Validate PR | | | | | | | | | |
| 6 | 5 | 5 | | | | 5h | ▼ | PR Diagnostics Time | | | | | | | | | |
| 7 | 4 | 4 | | | | 4h | ▮ | Engr/Mgt Review/Assess PR | | | | | | | | | |
| 8 | 1 | 1 | | | | 1h | ▮ | Engr/Mgt Determine Corrective Action | | | | | | | | | |
| 9 | 9.48 | 9.5 | | | | 9.5h | ▼ | PR Delay Time | | | | | | | | | |
| 10 | 4 | 4 | | | | 4h | ▮ | Engr Disposition PR | | | | | | | | | |
| 11 | 4 | 4 | | | | 4h | ▮ | Engr Rt PR through Signature Loop | | | | | | | | | |
| 12 | 1 | 1 | | | | 1h | ▮ | Engr Disposition PR Closure | | | | | | | | | |
| 13 | 0.5 | 0.5 | | | | 0.5h | ▮ | Engr Disposition PR Closure | | | | | | | | | |

Figure 22. Base PR accept.

| ID | Duration (hr) | Man-hr | Wednesday | | | Thursday | | | Friday | | | Saturday | | | Sunday | | |
|----|---------------|--------|-----------|----|---|----------|----|---|--------|----|---|----------|----|---|--------|----|---|
| | | | 4 | 12 | 8 | 4 | 12 | 8 | 4 | 12 | 8 | 4 | 12 | 8 | 4 | 12 | 8 |
| 1 | 6.98 | 0.5 | | | | 0.5h | ▼ | PR Performance Time | | | | | | | | | |
| 2 | 0.25 | 0.25 | | | | 0.25h | ▮ | Determine PR Condition | | | | | | | | | |
| 3 | 0.25 | 0.25 | | | | 0.25h | ▮ | Initiate PR Paperwork | | | | | | | | | |
| 4 | 0 | 0 | | | | | ◆ | Time/Resources for Corrective Action (Varies w/PR Classification) | | | | | | | | | |
| 5 | 2 | 2 | | | | 2h | ▼ | PR Diagnostics Time | | | | | | | | | |
| 6 | 1 | 1 | | | | 1h | ▮ | Engr/Mgt Review/Assess PR | | | | | | | | | |
| 7 | 1 | 1 | | | | 1h | ▮ | Engr/Mgt Determine Corrective Action | | | | | | | | | |
| 8 | 6.5 | 4.5 | | | | 4.5h | ▼ | PR Administrative Time | | | | | | | | | |
| 9 | 0.5 | 0.5 | | | | 0.5h | ▮ | QE Research/Validate PR | | | | | | | | | |
| 10 | 0 | 0 | | | | | ◆ | Engr Disposition PR (Varies with Repair Classification) | | | | | | | | | |
| 11 | 4 | 4 | | | | 4h | ▮ | Engr Rt PR through Signature Loop | | | | | | | | | |
| 12 | 1.5 | 0 | | | | 0h | ▼ | PR Delay Time | | | | | | | | | |
| 13 | 0 | 0 | | | | 0h | ▮ | Engr Disposition PR Closure | | | | | | | | | |
| 14 | 0.5 | 0 | | | | 0h | ▮ | QE Close PR | | | | | | | | | |

Figure 23. Base PR repair.

| ID | Duration (hr) | Man-hr | Wednesday | | | Thursday | | | Friday | | | Saturday | | | Sunday | | |
|----|---------------|--------|-----------|----|---|----------|----|---|-----------------------------|----|---|----------|----|---|--------|----|---|
| | | | 4 | 12 | 8 | 4 | 12 | 8 | 4 | 12 | 8 | 4 | 12 | 8 | 4 | 12 | 8 |
| 1 | 0.48 | 0.5 | | | | 0.5h | ▼ | Waiver Performance Time | | | | | | | | | |
| 2 | 0.25 | 0.25 | | | | 0.25h | ▮ | Determine PR Condition | | | | | | | | | |
| 3 | 0.25 | 0.25 | | | | 0.25h | ▮ | Initiate PR Paperwork | | | | | | | | | |
| 4 | 0.5 | 0.5 | | | | 0.5h | ▼ | Waiver Administrative Time | | | | | | | | | |
| 5 | 0.5 | 0.5 | | | | 0.5h | ▮ | QE Research/Validate PR | | | | | | | | | |
| 6 | 11.98 | 12 | | | | 12h | ▼ | Waiver Diagnostics Time | | | | | | | | | |
| 7 | 8 | 8 | | | | 8h | ▮ | Engr/Mgt Review/Assess PR | | | | | | | | | |
| 8 | 4 | 4 | | | | 4h | ▮ | Engr/Mgt Determine Corrective Action | | | | | | | | | |
| 9 | 16.5 | 0 | | | | 0h | ▼ | Waiver Delay Time | | | | | | | | | |
| 10 | 1 | 0 | | | | 0h | ▮ | Engr Disposition PR/Waiver Rationale | | | | | | | | | |
| 11 | 12 | 0 | | | | 0h | ▮ | Engr Rt PR/Waiver Rationale through Signature | | | | | | | | | |
| 12 | 1 | 0 | | | | | 0h | ▮ | Waiver Presentation | | | | | | | | |
| 13 | 2 | 0 | | | | | 0h | ▮ | Engr Disposition PR Closure | | | | | | | | |
| 14 | 0.5 | 0 | | | | | 0h | ▮ | QE Close PR | | | | | | | | |

Figure 24. Base waiver/exception.

Table 18. SSME unscheduled processing summary.

| ID | SSME PR Classification | Tech Base Perf MHrs | QC Base Perf MHrs | Engr Base Diag MHrs | Engr Base Admin MHrs | Total Base MHrs | Tech Perf MHrs | QC Perf MHrs | Engr Perf MHrs | Total Perf MHrs | Total MHrs | No. Techs | No. QCs | No. Engrs |
|----|--|------------------------------|----------------------------|------------------------------|-------------------------------|-----------------------|----------------------|-----------------|----------------------|-----------------------|---------------|--------------|------------|--------------|
| 1 | 48hr Drying OMRSD Waiver | 0 | 0.5 | 12 | 0.5 | 13 | 0 | 0 | 0 | 0 | 13 | 0 | 0 | 0 |
| 2 | AFV Filter R&R | 0 | 0.5 | 2 | 6.5 | 9 | 1 | 1 | 8.5 | 10.5 | 19.5 | 1 | 1 | 1 |
| 3 | Baggie Hose R&R | 0 | 0.5 | 2 | 6.5 | 9 | 1.25 | 1.25 | 0 | 2.5 | 11.5 | 1 | 1 | 0 |
| 4 | Baggie Hose Repair | 0 | 0.5 | 2 | 4.5 | 7 | 1 | 1 | 0 | 2 | 9 | 1 | 1 | 0 |
| 5 | Baggie R&R | 0 | 0.5 | 2 | 6.5 | 9 | 1.5 | 1.5 | 0 | 3 | 12 | 1 | 1 | 0 |
| 6 | Baggie Repair | 0 | 0.5 | 2 | 4.5 | 7 | 0.75 | 0.75 | 0 | 1.5 | 8.5 | 1 | 1 | 0 |
| 7 | Battery R&R | 0 | 0.5 | 2 | 6.5 | 9 | 1.25 | 1.25 | 0 | 2.5 | 11.5 | 1 | 1 | 0 |
| 8 | Burst Diaphragm R&R | 0 | 0.5 | 2 | 6.5 | 9 | 0.5 | 0.5 | 0 | 1 | 10 | 1 | 1 | 0 |
| 9 | Contamination MR Repair | 0.5 | 0.5 | 12 | 12.5 | 25.5 | 1.25 | 1.25 | 0 | 2.5 | 28 | 1 | 1 | 0 |
| 10 | Contamination Repair | 0 | 0.5 | 2 | 4.5 | 7 | 1.75 | 1.75 | 0 | 3.5 | 10.5 | 1 | 1 | 0 |
| 11 | Contamination/Corrosion Accept | 0 | 0.5 | 5 | 0.5 | 6 | 0 | 0 | 0 | 0 | 6 | 0 | 0 | 0 |
| 12 | Contamination/Corrosion MR Accept | 0.5 | 0.5 | 12 | 0.5 | 13.5 | 0 | 0 | 0 | 0 | 13.5 | 0 | 0 | 0 |
| 13 | Contamination/Corrosion Waiver | 0 | 0.5 | 12 | 0.5 | 13 | 0 | 0 | 0 | 0 | 13 | 0 | 0 | 0 |
| 14 | Controller R&R: Post-FRT | 0 | 0.5 | 2 | 6.5 | 9 | 154.5 | 74.25 | 93.25 | 322 | 331 | na | na | na |
| 15 | Controller R&R: Pre-FRT | 0 | 0.5 | 2 | 6.5 | 9 | 35.5 | 14.5 | 13 | 63 | 72 | na | na | na |
| 16 | Coolant Diffuser R&R | 0 | 0.5 | 2 | 6.5 | 9 | 2 | 2 | 0 | 4 | 13 | 1 | 1 | 0 |
| 17 | Coolant Duct R&R | 0 | 0.5 | 2 | 6.5 | 9 | 2 | 2 | 0 | 4 | 13 | 1 | 1 | 0 |
| 18 | EDNI Accept | 0 | 0.5 | 5 | 0.5 | 6 | 0 | 0 | 0 | 0 | 6 | 0 | 0 | 0 |
| 19 | EDNI MR Repair | 0.5 | 0.5 | 12 | 12.5 | 25.5 | 5.5 | 5.5 | 0 | 11 | 36.5 | 1 | 1 | 0 |
| 20 | EDNI R&R | 0 | 0.5 | 2 | 6.5 | 9 | 7 | 7 | 0 | 14 | 23 | 1 | 1 | 0 |
| 21 | EDNI Repair | 0 | 0.5 | 2 | 4.5 | 7 | 6 | 6 | 0 | 12 | 19 | 1 | 1 | 0 |
| 22 | Elliptical Plug R&R | 0 | 0.5 | 2 | 6.5 | 9 | 1 | 1 | 0 | 2 | 11 | 1 | 1 | 0 |
| 23 | Engine Assembly R&R | 0 | 0.5 | 2 | 6.5 | 9 | 8 | 8 | 8.5 | 24.5 | 33.5 | 1 | 1 | 1 |
| 24 | Engineering Change | 0 | 0.5 | 12 | 0.5 | 13 | 0 | 0 | 0 | 0 | 13 | 0 | 0 | 0 |
| 25 | Flange Sealing Surface MR Repair | 0.5 | 0.5 | 12 | 12.5 | 25.5 | 3.5 | 3.5 | 24.5 | 31.5 | 57 | 1 | 1 | 1 |
| 26 | Flange Sealing Surface Repair | 0 | 0.5 | 2 | 4.5 | 7 | 4 | 4 | 6.5 | 14.5 | 21.5 | 1 | 1 | 1 |
| 27 | FPB Oxidizer Supply Duct R&R: Post-HPOTP | 0 | 0.5 | 2 | 6.5 | 9 | 22.5 | 14.5 | 1 | 38 | 47 | na | na | na |
| 28 | FPB Oxidizer Supply Duct R&R: Pre-HPOTP | 0 | 0.5 | 2 | 6.5 | 9 | 13 | 9 | 0 | 22 | 31 | na | na | na |
| 29 | Fuel Bleed Duct R&R | 0 | 0.5 | 2 | 6.5 | 9 | 5 | 5 | 0 | 10 | 19 | 1 | 1 | 0 |
| 30 | Functional Failure Accept | 0 | 0.5 | 5 | 0.5 | 6 | 0 | 0 | 0 | 0 | 6 | 0 | 0 | 0 |
| 31 | Functional Failure Clean/Adjust | 0 | 0.5 | 2 | 4.5 | 7 | 4 | 4 | 0 | 8 | 15 | 1 | 1 | 0 |
| 32 | Functional Failure MR Accept | 0.5 | 0.5 | 12 | 0.5 | 13.5 | 0 | 0 | 0 | 0 | 13.5 | 0 | 0 | 0 |
| 33 | Functional Failure Reperform/Retest | 0 | 0.5 | 2 | 4.5 | 7 | 2.5 | 2.5 | 0 | 5 | 12 | 1 | 1 | 0 |
| 34 | Functional Failure Waiver | 0 | 0.5 | 12 | 0.5 | 13 | 0 | 0 | 0 | 0 | 13 | 0 | 0 | 0 |
| 35 | GCV Assembly R&R | 0 | 0.5 | 2 | 6.5 | 9 | 3 | 3 | 0 | 6 | 15 | na | na | na |

Table 18. SSME unscheduled processing summary (Continued).

| ID | SSME PR Classification | Tech Base Perf MHrs | QC Base Perf MHrs | Engr Base Diag MHrs | Engr Base Admin MHrs | Total Base MHrs | Tech Perf MHrs | QC Perf MHrs | Engr Perf MHrs | Total Perf MHrs | Total MHrs | No. Techs | No. QCs | No. Engrs |
|----|---------------------------------------|------------------------------|----------------------------|------------------------------|-------------------------------|-----------------------|----------------------|-----------------|----------------------|-----------------------|---------------|--------------|------------|--------------|
| 36 | Hardware Configuration Accept | 0 | 0.5 | 5 | 0.5 | 6 | 0 | 0 | 0 | 0 | 6 | 0 | 0 | 0 |
| 37 | Hardware Configuration MR Accept | 0.5 | 0.5 | 12 | 0.5 | 13.5 | 0 | 0 | 0 | 0 | 13.5 | 0 | 0 | 0 |
| 38 | Hardware Configuration MR Repair | 0.5 | 0.5 | 12 | 12.5 | 25.5 | 2.5 | 2.5 | 0 | 5 | 30.5 | 1 | 1 | 0 |
| 39 | Hardware Configuration Reinstallation | 0 | 0.5 | 2 | 4.5 | 7 | 3 | 3 | 0 | 6 | 13 | 1 | 1 | 0 |
| 40 | Hardware Configuration Waiver | 0 | 0.5 | 12 | 0.5 | 13 | 0 | 0 | 0 | 0 | 13 | 0 | 0 | 0 |
| 41 | Hardware Crack/Weld Defect MR Repair | 0.5 | 0.5 | 12 | 12.5 | 25.5 | 7.5 | 7.5 | 0 | 15 | 40.5 | 1 | 1 | 0 |
| 42 | Hardware Crack/Weld Defect Repair | 0 | 0.5 | 2 | 4.5 | 7 | 8 | 8 | 0 | 16 | 23 | 1 | 1 | 0 |
| 43 | Hardware Damage Accept | 0 | 0.5 | 5 | 0.5 | 6 | 0 | 0 | 0 | 0 | 6 | 0 | 0 | 0 |
| 44 | Hardware Damage MR Accept | 0.5 | 0.5 | 12 | 0.5 | 13.5 | 0 | 0 | 0 | 0 | 13.5 | 0 | 0 | 0 |
| 45 | Hardware Damage MR Repair | 0.5 | 0.5 | 12 | 12.5 | 25.5 | 3.5 | 3.5 | 0 | 7 | 32.5 | 1 | 1 | 0 |
| 46 | Hardware Damage Repair | 0 | 0.5 | 2 | 4.5 | 7 | 4 | 4 | 0 | 8 | 15 | 1 | 1 | 0 |
| 47 | Hardware Damage Waiver | 0 | 0.5 | 12 | 0.5 | 13 | 0 | 0 | 0 | 0 | 13 | 0 | 0 | 0 |
| 48 | Harness Accept | 0 | 0.5 | 5 | 0.5 | 6 | 0 | 0 | 0 | 0 | 6 | 0 | 0 | 0 |
| 49 | Harness MR Accept | 0.5 | 0.5 | 12 | 0.5 | 13.5 | 0 | 0 | 0 | 0 | 13.5 | 0 | 0 | 0 |
| 50 | Harness MR Repair | 0.5 | 0.5 | 12 | 12.5 | 25.5 | 2 | 2 | 0 | 4 | 29.5 | 1 | 1 | 0 |
| 51 | Harness R&R: Post-FRT | 0 | 0.5 | 2 | 6.5 | 9 | 11 | 4 | 4 | 19 | 28 | na | na | na |
| 52 | Harness R&R: Pre-FRT | 0 | 0.5 | 2 | 6.5 | 9 | 3 | 3 | 0 | 6 | 15 | 1 | 1 | 0 |
| 53 | Harness Repair | 0 | 0.5 | 2 | 4.5 | 7 | 2.5 | 2.5 | 0 | 5 | 12 | 1 | 1 | 0 |
| 54 | Heat Shield Clip/Bracket R&R | 0 | 0.5 | 2 | 6.5 | 9 | 1 | 1 | 0 | 2 | 11 | 1 | 1 | 0 |
| 55 | Hot Gas Manifold R&R | 0 | 0.5 | 2 | 6.5 | 9 | 4 | 4 | 8.5 | 16.5 | 25.5 | 1 | 1 | 1 |
| 56 | HPFD R&R: Pad | 0 | 0.5 | 2 | 6.5 | 9 | 70.75 | 27.25 | 9 | 107 | 116 | na | na | na |
| 57 | HPFD R&R: Shop Post-FRT | 0 | 0.5 | 2 | 6.5 | 9 | 37.25 | 26.75 | 8 | 72 | 81 | na | na | na |
| 58 | HPFD R&R: Shop Pre-HPFTP R&R | 0 | 0.5 | 2 | 6.5 | 9 | 23.25 | 13 | 2.5 | 38.75 | 47.75 | na | na | na |
| 59 | HPFTP Bellows Shield R&R | 0 | 0.5 | 2 | 6.5 | 9 | 2 | 2 | 0 | 4 | 13 | 1 | 1 | 0 |
| 60 | HPFTP R&R: Pre-R&R | 0 | 0.5 | 2 | 6.5 | 9 | 0 | 0 | 0 | 0 | 9 | na | na | na |
| 61 | HPFTP Thrust Bearing Housing R&R | 0 | 0.5 | 2 | 6.5 | 9 | 8 | 8 | 0 | 16 | 25 | 1 | 1 | 0 |
| 62 | HPOTP Preburner Volute R&R | 0 | 0.5 | 2 | 6.5 | 9 | 16 | 16 | 0 | 32 | 41 | 1 | 1 | 0 |
| 63 | HPOTP R&R: Pre-R&R | 0 | 0.5 | 2 | 6.5 | 9 | 0 | 0 | 0 | 0 | 9 | na | na | na |
| 64 | HPOTP Turbine Housing R&R | 0 | 0.5 | 2 | 6.5 | 9 | 2 | 2 | 0 | 4 | 13 | 1 | 1 | 0 |
| 65 | HPV Assembly R&R | 0 | 0.5 | 2 | 6.5 | 9 | 8 | 8 | 0 | 16 | 25 | 1 | 1 | 0 |
| 66 | Hydraulic QD R&R | 0 | 0.5 | 2 | 6.5 | 9 | 6 | 6 | 0 | 12 | 21 | 1 | 1 | 0 |
| 67 | Igniter R&R | 0 | 0.5 | 2 | 6.5 | 9 | 2 | 2 | 0 | 4 | 13 | 1 | 1 | 0 |
| 68 | Line Assembly R&R | 0 | 0.5 | 2 | 6.5 | 9 | 5 | 5 | 0 | 10 | 19 | 1 | 1 | 0 |
| 69 | LOX Post Support Pin R&R | 0 | 0.5 | 2 | 6.5 | 9 | 0 | 10 | 6.5 | 18.5 | 27.5 | 0 | 1 | 1 |
| 70 | LPFD R&R: OPF/Pad | 0 | 0.5 | 2 | 6.5 | 9 | 64.75 | 24.75 | 5.5 | 95 | 104 | na | na | na |

Table 18. SSME unscheduled processing summary (Continued).

| ID | SSME PR Classification | Tech Base Perf MHrs | QC Base Perf MHrs | Engr Base Diag MHrs | Engr Base Admin MHrs | Total Base MHrs | Tech Perf MHrs | QC Perf MHrs | Engr Perf MHrs | Total Perf MHrs | Total MHrs | No. Techs | No. QCs | No. Engrs |
|-----|--|------------------------------|----------------------------|------------------------------|-------------------------------|-----------------------|----------------------|-----------------|----------------------|-----------------------|---------------|--------------|------------|--------------|
| 71 | LPFD R&R: Shop Pre-HPFTP R&R | 0 | 0.5 | 2 | 6.5 | 9 | 23.5 | 11.5 | 2.5 | 37.5 | 46.5 | na | na | na |
| 72 | LPFT Discharge Duct R&R | 0 | 0.5 | 2 | 6.5 | 9 | 26 | 10 | 0 | 36 | 45 | na | na | na |
| 73 | LPFT Drive Duct R&R | 0 | 0.5 | 2 | 6.5 | 9 | 25 | 10 | 0 | 35 | 44 | na | na | na |
| 74 | LPFTP R&R | 0 | 0.5 | 2 | 6.5 | 9 | 53.5 | 29 | 11.5 | 94 | 103 | na | na | na |
| 75 | LPOD R&R | 0 | 0.5 | 2 | 6.5 | 9 | 57.25 | 26.25 | 4 | 87.5 | 96.5 | na | na | na |
| 76 | LPOTP R&R | 0 | 0.5 | 2 | 6.5 | 9 | 52.5 | 28.5 | 13 | 94 | 103 | na | na | na |
| 77 | Main Injector Assembly R&R | 0 | 0.5 | 2 | 6.5 | 9 | 4 | 4 | 8.5 | 16.5 | 25.5 | 1 | 1 | 1 |
| 78 | MCC Assembly R&R | 0 | 0.5 | 2 | 6.5 | 9 | 4 | 4 | 8.5 | 16.5 | 25.5 | 1 | 1 | 1 |
| 79 | MCC Roughness Repair | 0 | 0.5 | 2 | 4.5 | 7 | 4 | 4 | 6.5 | 14.5 | 21.5 | 1 | 1 | 1 |
| 80 | Miscellaneous Hardware Config. MR Repair | 0.5 | 0.5 | 12 | 12.5 | 25.5 | 2 | 2 | 0 | 4 | 29.5 | 1 | 1 | 0 |
| 81 | Miscellaneous Hardware Config. Repair | 0 | 0.5 | 2 | 4.5 | 7 | 2.5 | 2.5 | 0 | 5 | 12 | 1 | 1 | 0 |
| 82 | Miscellaneous Hardware Damage MR Repair | 0.5 | 0.5 | 12 | 12.5 | 25.5 | 2 | 2 | 0 | 4 | 29.5 | 1 | 1 | 0 |
| 83 | Miscellaneous Hardware Damage Repair | 0 | 0.5 | 2 | 4.5 | 7 | 2.5 | 2.5 | 0 | 5 | 12 | 1 | 1 | 0 |
| 84 | Miscellaneous Hardware R&R | 0 | 0.5 | 2 | 6.5 | 9 | 6 | 6 | 0 | 12 | 21 | 1 | 1 | 0 |
| 85 | MOVA R&R: Pad | 0 | 0.5 | 2 | 6.5 | 9 | 79.5 | 50.25 | 62.75 | 192.5 | 201.5 | na | na | na |
| 86 | MOVA R&R: Shop | 0 | 0.5 | 2 | 6.5 | 9 | 29.25 | 18.75 | 3.5 | 51.5 | 60.5 | na | na | na |
| 87 | Nozzle FRI R&R | 0 | 0.5 | 2 | 6.5 | 9 | 221.5 | 119.25 | 54 | 394.75 | 403.75 | na | na | na |
| 88 | Nozzle R&R: Post-Testing | 0 | 0.5 | 2 | 6.5 | 9 | 245 | 133.75 | 65 | 443.75 | 452.75 | na | na | na |
| 89 | Nozzle R&R: Pre-Testing | 0 | 0.5 | 2 | 6.5 | 9 | 213.5 | 111.25 | 54 | 378.75 | 387.75 | na | na | na |
| 90 | Nozzle TPS MR Repair | 0.5 | 0.5 | 12 | 12.5 | 25.5 | 5.5 | 5.5 | 0 | 11 | 36.5 | 1 | 1 | 0 |
| 91 | Nozzle TPS R&R | 0 | 0.5 | 2 | 6.5 | 9 | 8 | 8 | 0 | 16 | 25 | 1 | 1 | 0 |
| 92 | Nozzle TPS Repair | 0 | 0.5 | 2 | 4.5 | 7 | 4 | 4 | 0 | 8 | 15 | 1 | 1 | 0 |
| 93 | Nozzle Tube Leak MR Accept/Waiver | 0 | 0.5 | 12 | 0.5 | 13 | 0 | 0 | 0 | 0 | 13 | 0 | 0 | 0 |
| 94 | Nozzle Tube Leak MR Repair | 0.5 | 0.5 | 12 | 12.5 | 25.5 | 7.5 | 7.5 | 24.5 | 39.5 | 65 | 1 | 1 | 1 |
| 95 | OPB Oxidizer Supply Duct R&R | 0 | 0.5 | 2 | 6.5 | 9 | 6 | 4 | 0 | 10 | 19 | na | na | na |
| 96 | Orifice R&R | 0 | 0.5 | 2 | 6.5 | 9 | 2 | 2 | 0 | 4 | 13 | 1 | 1 | 0 |
| 97 | PCA Assembly R&R | 0 | 0.5 | 2 | 6.5 | 9 | 12 | 12 | 0 | 24 | 33 | 1 | 1 | 0 |
| 98 | Pogo Baffle R&R | 0 | 0.5 | 2 | 6.5 | 9 | 51.25 | 24.25 | 4 | 79.5 | 88.5 | na | na | na |
| 99 | Powerhead Assembly R&R | 0 | 0.5 | 2 | 6.5 | 9 | 4 | 4 | 8.5 | 16.5 | 25.5 | 1 | 1 | 1 |
| 100 | Requirement/Documentation Change | 0 | 0.5 | 12 | 0.5 | 13 | 0 | 0 | 0 | 0 | 13 | 0 | 0 | 0 |
| 101 | RIV Assembly R&R | 0 | 0.5 | 2 | 6.5 | 9 | 6.75 | 6.75 | 0 | 13.5 | 22.5 | na | na | na |
| 102 | Seal R&R | 0 | 0.5 | 2 | 6.5 | 9 | 1 | 1 | 0 | 2 | 11 | 1 | 1 | 0 |
| 103 | Sensor Accept | 0 | 0.5 | 5 | 0.5 | 6 | 0 | 0 | 0 | 0 | 6 | 0 | 0 | 0 |
| 104 | Sensor Mount R&R | 0 | 0.5 | 2 | 6.5 | 9 | 1 | 1 | 0 | 2 | 11 | 1 | 1 | 0 |
| 105 | Sensor MR Accept | 0.5 | 0.5 | 12 | 0.5 | 13.5 | 0 | 0 | 0 | 0 | 13.5 | 0 | 0 | 0 |
| 106 | Sensor R&R: Post-Checkouts | 0 | 0.5 | 2 | 6.5 | 9 | 19 | 8 | 8 | 35 | 44 | na | na | na |

Table 18. SSME unscheduled processing summary (Continued).

| ID | SSME PR Classification | Tech Base Perf MHrs | QC Base Perf MHrs | Engr Base Diag MHrs | Engr Base Admin MHrs | Total Base MHrs | Tech Perf MHrs | QC Perf MHrs | Engr Perf MHrs | Total Perf MHrs | Total MHrs | No. Techs | No. QCs | No. Engrs |
|-----|--------------------------------------|------------------------------|----------------------------|------------------------------|-------------------------------|-----------------------|----------------------|-----------------|----------------------|-----------------------|---------------|--------------|------------|--------------|
| 107 | Sensor R&R: Pre-Checkouts | 0 | 0.5 | 2 | 6.5 | 9 | 1 | 1 | 0 | 2 | 11 | 1 | 1 | 0 |
| 108 | Sensor Repair | 0 | 0.5 | 2 | 4.5 | 7 | 2.5 | 2.5 | 0 | 5 | 12 | 1 | 1 | 0 |
| 109 | Stud/Bolt R&R | 0 | 0.5 | 2 | 6.5 | 9 | 3 | 3 | 0 | 6 | 15 | 1 | 1 | 0 |
| 110 | Surface Corrosion MR Repair | 0.5 | 0.5 | 12 | 12.5 | 25.5 | 3.5 | 3.5 | 0 | 7 | 32.5 | 1 | 1 | 0 |
| 111 | Surface Corrosion Repair | 0 | 0.5 | 2 | 4.5 | 7 | 4 | 4 | 0 | 8 | 15 | 1 | 1 | 0 |
| 112 | Surface Discoloration MR Repair | 0.5 | 0.5 | 12 | 12.5 | 25.5 | 3.5 | 3.5 | 0 | 7 | 32.5 | 1 | 1 | 0 |
| 113 | Surface Discoloration Repair | 0 | 0.5 | 2 | 4.5 | 7 | 4 | 4 | 0 | 8 | 15 | 1 | 1 | 0 |
| 114 | Threads Damage Repair | 0 | 0.5 | 2 | 4.5 | 7 | 3 | 3 | 0 | 6 | 13 | 1 | 1 | 0 |
| 115 | TVCA Pin R&R | 0 | 0.5 | 2 | 6.5 | 9 | 5 | 5 | 0 | 10 | 19 | 1 | 1 | 0 |
| 116 | Valve Actuator R&R: Pad Post-Testing | 0 | 0.5 | 2 | 6.5 | 9 | 99.5 | 63 | 74 | 236.5 | 245.5 | na | na | na |
| 117 | Valve Actuator R&R: Pad Pre-Testing | 0 | 0.5 | 2 | 6.5 | 9 | 49.25 | 31.5 | 14.75 | 95.5 | 104.5 | na | na | na |
| 118 | Valve Actuator R&R: Shop Pre-Testing | 0 | 0.5 | 2 | 6.5 | 9 | 49.25 | 31.5 | 14.75 | 95.5 | 104.5 | na | na | na |
| 119 | Valve R&R: Pad | 0 | 0.5 | 2 | 6.5 | 9 | 127.75 | 80.25 | 93.5 | 301.5 | 310.5 | na | na | na |
| 120 | Valve R&R: Shop Post-Testing | 0 | 0.5 | 2 | 6.5 | 9 | 127.75 | 80.25 | 93.5 | 301.5 | 310.5 | na | na | na |
| 121 | Valve R&R: Shop Pre-Testing | 0 | 0.5 | 2 | 6.5 | 9 | 77.5 | 48.75 | 18.25 | 144.5 | 153.5 | na | na | na |
| 122 | HPFTP R&R: Post-R&R | 0 | 0.5 | 2 | 6.5 | 9 | 197 | 122.75 | 56 | 375.75 | 384.75 | na | na | na |
| 123 | HPOTP R&R: Post-R&R | 0 | 0.5 | 2 | 6.5 | 9 | 239.5 | 142.25 | 53.25 | 435 | 444 | na | na | na |

Table 19. Example of detailed data for unscheduled processing.

| ID | Task Name | Duration | Work | Predecessors | Resource Names |
|----|---|--------------|--------------|--------------|---------------------------|
| 1 | LPFTP Removal and Replacement/V5E24I | 37.5h | 94h | | |
| 2 | LPFTP GSE Removal PrepsI | 2h | 6h | | |
| 3 | Verify Proofload | 2h | 4h | | Tech, QC |
| 4 | Perform LPFTP Receiving Inspection | 1h | 2h | | Tech, QC |
| 5 | LPFTP Removal PrepsI | 20.5h | 25.5h | | |
| 6 | LAI Removal | 2h | 2h | | Tech |
| 7 | Disconnect LPFTP Drain Line @ Joint D17 | 0.5h | 0.5h | 6 | Tech |
| 8 | Disconnect LPFD @ Joint F2 | 3h | 3h | 7 | Tech |
| 9 | Support LPFD | 0.5h | 0.5h | 8 | Tech |
| 10 | Disconnect LPFT Drive Duct @ Joint F8 | 3h | 3h | 9 | Tech |
| 11 | Support LPFT Drive Duct | 0.5h | 0.5h | 10 | Tech |
| 12 | Disconnect LPFT Discharge Duct @ Joint F9 | 3h | 3h | 11 | Tech |
| 13 | Support LPFT Discharge Duct | 0.5h | 0.5h | 12 | Tech |
| 14 | Demate Connectors @ LPFT Speed Transducer Joint F1.1 | 1h | 1h | 13 | Tech |
| 15 | Install Handler Sling | 1h | 1h | 14 | Tech |
| 16 | Reference Check Joints F2, F8 and F9 | 5h | 10h | 15 | Tech, QC |
| 17 | Horizontal Handler Removal Preps | 0.5h | 0.5h | 16 | Tech |
| 18 | LPFTP Removal from EngineI | 7.25h | 23.5h | 5 | |
| 19 | Establish Safety Clears for LPFTP Removal | 0.25h | 1.5h | | Tech[3], QC, Safety, Engr |
| 20 | Connect J-Hook to Handler Sling | 1h | 6h | 19 | Tech[3], QC, Safety, Engr |
| 21 | Lower LPFTP to Floor | 1h | 6h | 20 | Tech[3], QC, Safety, Engr |
| 22 | Install LPFTP into Shipping Container | 5h | 10h | 21 | Tech, QC |
| 23 | LPFTP InstallationI | 2.25h | 13.5h | 21 | |
| 24 | Establish Safety Clears for LPFTP Installation | 0.25h | 1.5h | | Tech[3], QC, Safety, Engr |
| 25 | Connect J-Hook to Handler Sling | 1h | 6h | 24 | Tech[3], QC, Safety, Engr |
| 26 | Install LPFTP onto Engine | 1h | 6h | 25 | Tech[3], QC, Safety, Engr |
| 27 | LPFTP SecuringI | 11.5h | 24.5h | 23 | |
| 28 | Torque and Stretch Joint F9 | 2h | 4h | | Tech, QC |
| 29 | Torque and Stretch Joint F8 | 2h | 4h | 28 | Tech, QC |
| 30 | Torque and Stretch Joint F2 | 2h | 4h | 29 | Tech, QC |
| 31 | Install LPFTP Speed Transducer @ Joint F1.1 | 1h | 2h | 30 | Tech, QC |
| 32 | Perform Electrical Connector Mates | 2h | 4h | 31 | Tech, QC |
| 33 | Secure LPFTP Drain Line @ Joint D17 | 0.5h | 1h | 32 | Tech, QC |
| 34 | Perform LPFTP Torque Check | 1.5h | 4.5h | 33 | Tech, QC, Engr |
| 35 | RTV Bolt Heads @ Joints F2, F8 and F9 and Reinstall LAI | 0.5h | 1h | 34 | Tech, QC |
| 36 | Retest Verification! | 1h | 1h | 27 | Engr |

APPENDIX D—Pertinent SSME Results From Analysis of Data Collected

Figures 25–28 present examples of the fidelity of results supported by the data collected. These results, of course, apply to SSME processing and are subject to the assumptions, ground rules, and constraints described in section 5.

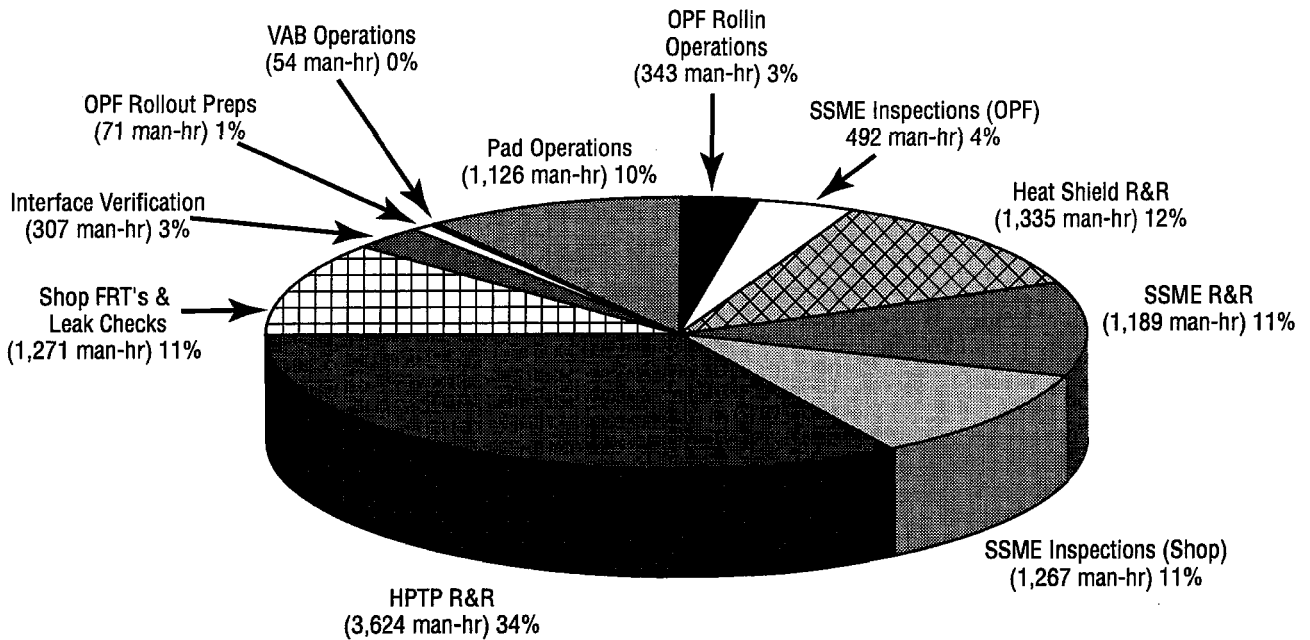

*Based upon three-engine processing

Figure 25. Total SSME manhours by process type.*

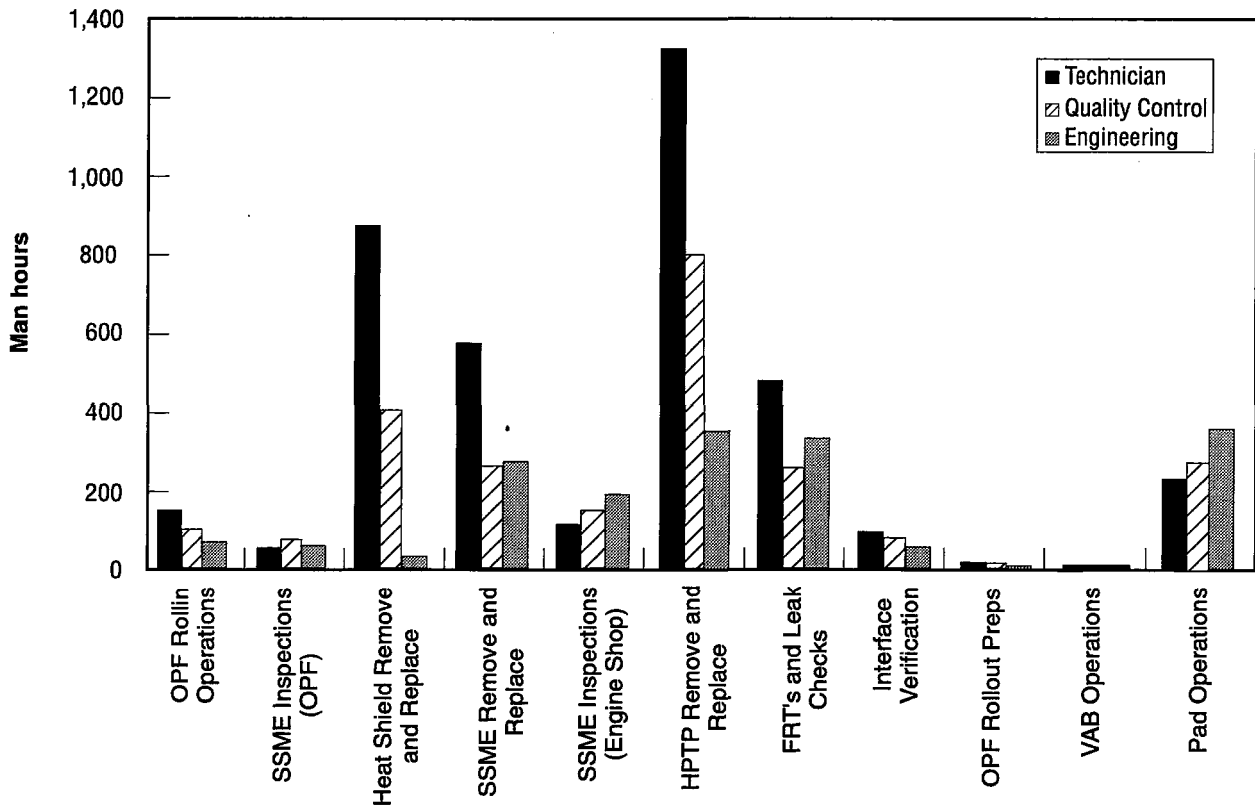

*Based upon three-engine processing

Figure 26. Scheduled SSME manhours by process type.*

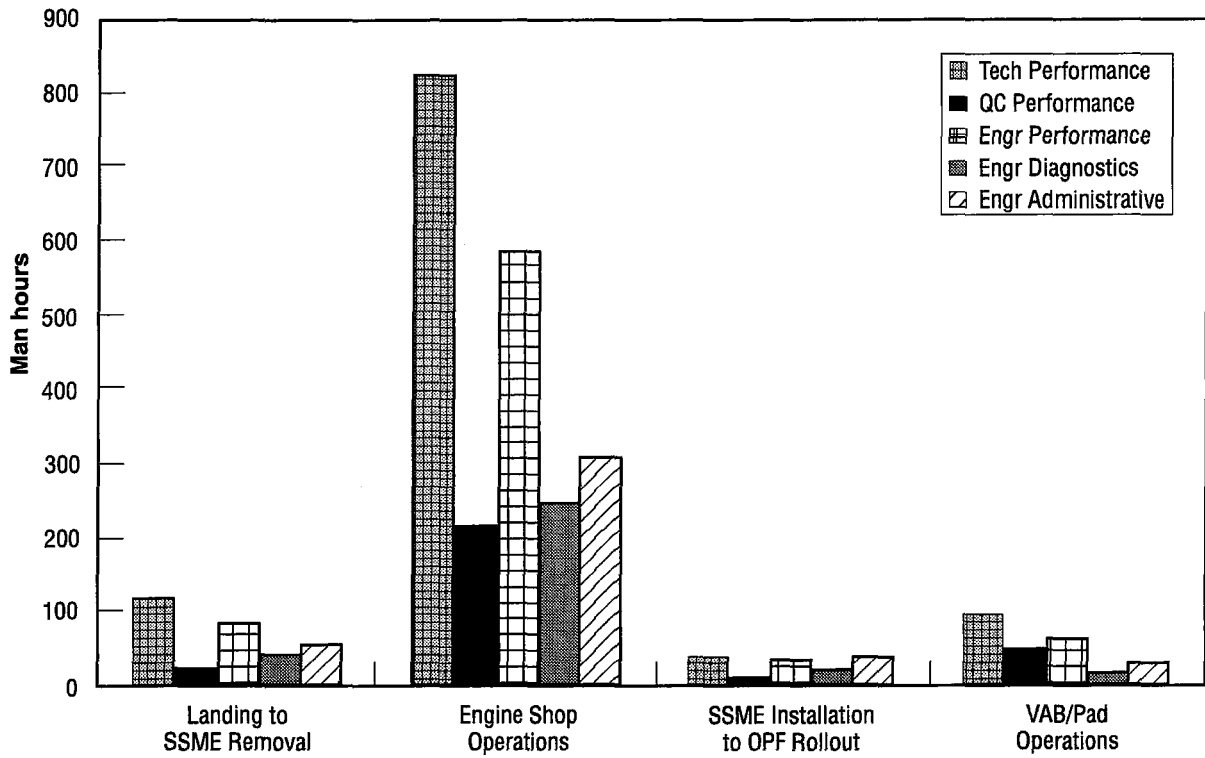

*Based upon three-engine processing

Figure 27. Unscheduled SSME manhours by process type.*

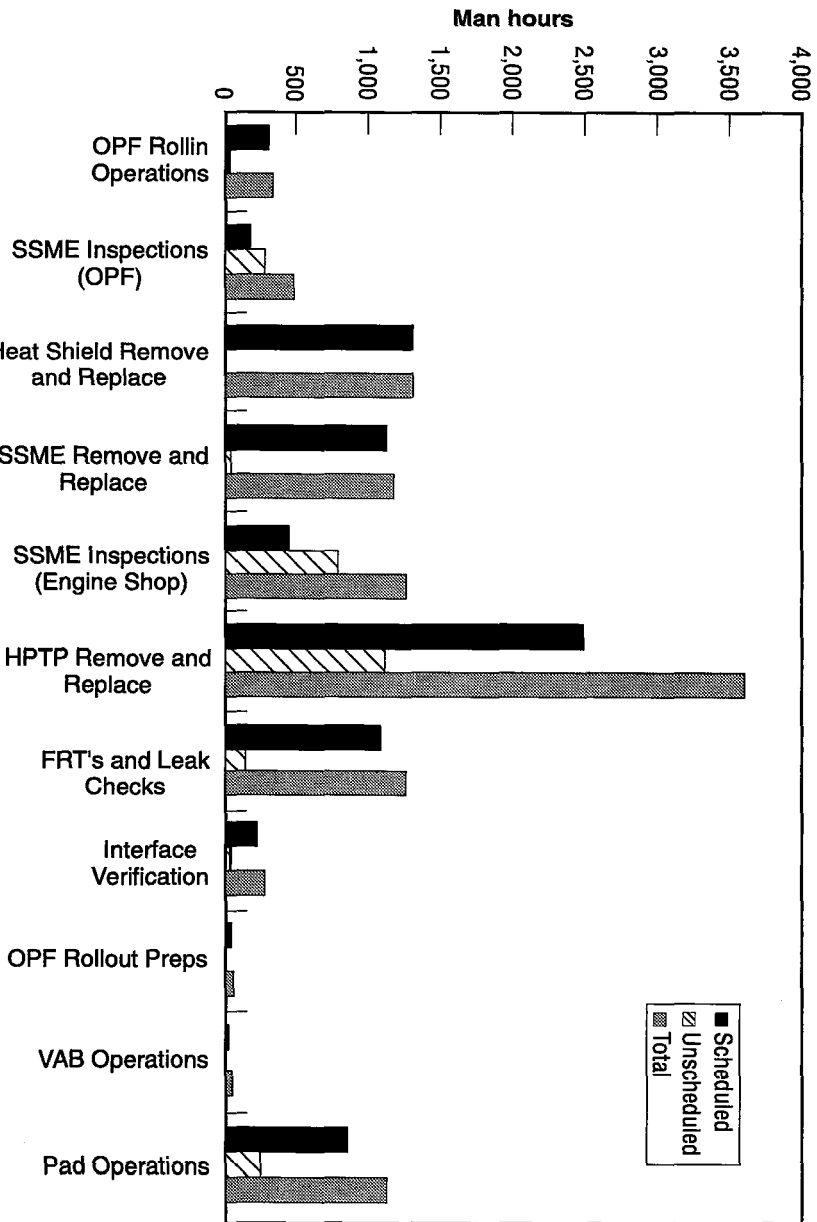

*Based upon three-engine processing

Figure 28. SSME manhours by process type.

APPENDIX E—Reliability of Engine Sets With Engine Out Capability

The reliability estimates of future launch vehicles can be further refined upon receipt of more accurate estimates of engine reliability, catastrophic failure probabilities, coverage time, and trajectory requirements. This is a discussion of the effect of engine out capability and time of engine out on the reliability of aerospace vehicles. This study looks at sample data, sets out basic formulas, and presents results related to the issue of engine out. For the purpose of this study, only engine data will be considered. Upstream component reliabilities such as tanks, feed systems, power systems, etc. will be omitted.

Certain definitions are important to this discussion. Engine failure is failure to provide the level of thrust desired at the time desired. Catastrophic failure in an engine is a failure that results in a failure of a second engine in an engine set. Benign failure is the proportion of failures where failure does not result in catastrophic failure. Time of engine out refers to the time at which an engine can be shut down and the remaining engines will still provide the necessary thrust to achieve the desired orbit. Time of engine out refers to a known event.

Engine out capability is generally believed to provide increased overall engine set reliability. For example, using a binomial distribution^{27,28} to analyze the example of three engines with one engine out at launch is as follows:

$R = p^n + np^{n-1}(1-p)$; where R is the engine set reliability, p the engine reliability, and n the number of engines with one engine out capability.

A comparison between a two-engine set with no engine out capability and a three-engine set with one engine out capability is presented in table 20.

Table 20. Engine out capability comparison.

| Engine Reliability (R) | Two Engines/ No Out ($R=p^2$) | Three Engines/ One Out (R) |
|-------------------------------|---------------------------------------|--------------------------------------|
| 0.95 | 0.903 | 0.993 |
| 0.97 | 0.941 | 0.997 |
| 0.99 | 0.98 | 0.9997 |
| 0.999 | 0.998 | 0.999997 |

With a baseline engine reliability at the above values, there is a significant gain displayed by a three-engine set with one engine out as opposed to the two-engine set with no engine out capability. The gain diminishes as the engine reliability improves.

This analysis is now expanded. The cases need to be examined where catastrophic failure fraction and coverage times are varied. The formula that incorporates time of engine out and benign failure fraction is:²⁹

$$R_{EO} = S^n T_d^n R^n [1 + T_u^{n-1} b n (R^{-c} - 1)] .$$

The parameters in the formula are:

- R = Engine reliability
- R_{EO} = Engine set reliability
- S = Startup reliability
- T_d = Throttle-down reliability
- T_u = Throttle-up reliability
- b = Benign failure fraction
- c = Coverage
- n = Number of engines.

For the following analysis, the formula will be simplified by setting both the throttle reliability and startup reliability to 1. It is assumed, in this case, that throttling is accomplished within design margins and that startup reliability is ensured by some event such as holddown, both reasonable assumptions.

One study of the SSME³⁰ has suggested that such a catastrophic failure could occur in the main engines approximately 17 percent of the time (benign failure fraction of 83 percent). This is derived data based on a small amount of data—almost all main engine tests have occurred singly and the study concluded that only 3 of 17 failures could have resulted in a second engine failure. This conclusion was generated based on the incidence of explosions and test stand damage that occurred. The small amount of data, typical in the aerospace industry, makes it difficult to draw definitive conclusions or to use confidence intervals.

Another factor to be considered in overall engine set reliability is the time of engine out. If all three engines are needed for 100 sec of flight and then only two are necessary to obtain orbit, this time of engine out translates to an increased reliability for the engine system.

With example engine reliability, table 21 can be generated. Two conclusions can be drawn. First the probability of catastrophic failure rather quickly degrades the increase of reliability gained due to engine out capability. From table 21, at 0.97 reliability and engine out at time 0, a catastrophic failure probability increase from 0.1 to 0.25 results in a decline in reliability from 0.9889 to 0.9762 for the three-engine case. Still, this is considerably higher than the two-engine, no out case reliability of 0.941.

Second, it is evident that reliability can be gained if some engine out time is possible. For example, if engine out is possible for two-thirds of the flight (0.97 engine reliability and 0.2 catastrophic failure factor), then the reliability goes from 0.913 to 0.9578—a significant gain. Note that the engine reliability at $t=1$ for all catastrophic failure factor values is equal to the n engines/no out capability since this is equivalent to all engines being necessary for the full-duration flight.

Table 21. Engine out and time of engine out comparison.

| Engine Reliability | Catastrophic Failure Probability | Engine Out Time | Three Engines/ One Out Reliability |
|--------------------|----------------------------------|-----------------|------------------------------------|
| 0.95 | 0.1 | 0 | 0.9792 |
| | | 0.33 | 0.9383 |
| | | 0.67 | 0.8969 |
| | | 1 | 0.8574 |
| | 0.2 | 0 | 0.9657 |
| | | 0.33 | 0.9293 |
| | | 0.67 | 0.8925 |
| | | 1 | 0.8574 |
| | 0.25 | 0 | 0.9589 |
| | | 0.33 | 0.9248 |
| | | 0.67 | 0.8903 |
| | | 1 | 0.8574 |
| 0.97 | 0.1 | 0 | 0.9889 |
| | | 0.33 | 0.9635 |
| | | 0.67 | 0.9376 |
| | | 1 | 0.9127 |
| | 0.2 | 0 | 0.9804 |
| | | 0.33 | 0.9578 |
| | | 0.67 | 0.9348 |
| | | 1 | 0.9127 |
| | 0.25 | 0 | 0.9762 |
| | | 0.33 | 0.9550 |
| | | 0.67 | 0.9334 |
| | | 1 | 0.9127 |
| 0.99 | 0.1 | 0 | 0.9968 |
| | | 0.33 | 0.9880 |
| | | 0.67 | 0.9790 |
| | | 1 | 0.9703 |
| | 0.2 | 0 | 0.9938 |
| | | 0.33 | 0.9860 |
| | | 0.67 | 0.9780 |
| | | 1 | 0.9703 |
| | 0.25 | 0 | 0.9924 |
| | | 0.33 | 0.9850 |
| | | 0.67 | 0.9776 |
| | | 1 | 0.9703 |
| 0.999 | 0.1 | 0 | 0.9997 |
| | | 0.33 | 0.9988 |
| | | 0.67 | 0.9979 |
| | | 1 | 0.9970 |
| | 0.2 | 0 | 0.9994 |
| | | 0.33 | 0.9986 |
| | | 0.67 | 0.9978 |
| | | 1 | 0.9970 |
| | 0.25 | 0 | 0.9992 |
| | | 0.33 | 0.9985 |
| | | 0.67 | 0.9977 |
| | | 1 | 0.9970 |

REFERENCES

1. Ryan, R.; et al.: "*Working on the Boundaries: Philosophies and Practices of the Design Process*," NASA-TP-3642, July 1996.
2. Blanchard, B.S.; and Fabrycky, W.J.: *Systems Engineering and Analysis*, Prentice-Hall, Englewood Cliffs, NJ, 1981.
3. Gaubatz, W.A.; et al.: "*Translating SSTO System Operability and Supportability Requirements into Measures of System Effectiveness*," AIAA 96-4247, September 1996.
4. Ryan, R.; and Verderaine, V.: "*Systems Design Analysis Applied to Launch Vehicle Configuration*," NASA-TP-3326, MSFC, January 1993.
5. NLS/ALS Project Office, "*Launch Operations Concerns and Operations Enhancing Technology*," NASA-MSFC, AL, 1990.
6. Banks, J.; and Carson, J.S.: *Discrete-Event System Simulation*, Prentice-Hall, Englewood Cliffs, NJ, 1990.
7. Joshi, B.; et al.: "*Optimization of Operations Resources via Discrete Event Simulation Modeling*," AIAA-96-4181, September 1996.
8. Morris, W.D.; et al.: "*Defining Support Requirements During Conceptual Design of Reusable Launch Vehicles*," AIAA-95-3619, September 1995.
9. Weber, T.F.: "Reliability and Maintainability in Space Systems Design," *Aerospace Design*, No. 93-1025, February 1993.
10. Fleming, B.: *Launch Vehicle Maintenance Analysis Final Report*, MCR-92-1341, November 1992.
11. Huffaker, F.; and Fleming, B.: "*Operations Database Development for VRC*," AIAA-96-4244, September 1996.
12. Findlow, F., et al.: "*Available Shuttle System Database Identification and Pathfinder RM&S Data Search—Final Report*," Lockheed-Martin Corp., May 1995.
13. Christenson, R.L.; and Holt, J.B.: "*Future Launch Vehicle Propulsion Systems Operability Analysis*," AIAA-95-4068, September 1995.
14. Komar, D.R.; and Christenson, R.L.: "*Reusable Launch Vehicle Engine Systems Operations Analysis*," AIAA-96-4246, September 1996.

| REPORT DOCUMENTATION PAGE | | | Form Approved OMB No. 0704-0188 | |
|---|--|---|---|--|
| Public reporting burden for this collection of information is estimated to average 1 hour per response, including the time for reviewing instructions, searching existing data sources, gathering and maintaining the data needed, and completing and reviewing the collection of information. Send comments regarding this burden estimate or any other aspect of this collection of information, including suggestions for reducing this burden, to Washington Headquarters Services, Directorate for Information Operation and Reports, 1215 Jefferson Davis Highway, Suite 1204, Arlington, VA 22202-4302, and to the Office of Management and Budget, Paperwork Reduction Project (0704-0188), Washington, DC 20503 | | | | |
| 1. AGENCY USE ONLY (Leave Blank) | 2. REPORT DATE July 1998 | 3. REPORT TYPE AND DATES COVERED Technical Publication | | |
| 4. TITLE AND SUBTITLE Reusable Rocket Engine Operability Modeling and Analysis | | | 5. FUNDING NUMBERS | |
| 6. AUTHORS R.L. Christenson and D.R. Komar | | | 8. PERFORMING ORGANIZATION REPORT NUMBER M-879 | |
| 7. PERFORMING ORGANIZATION NAME(S) AND ADDRESS(ES) George C. Marshall Space Flight Center Marshall Space Flight Center, Alabama 35812 | | | 10. SPONSORING/MONITORING AGENCY REPORT NUMBER NASA/TP-1998-208530 | |
| 9. SPONSORING/MONITORING AGENCY NAME(S) AND ADDRESS(ES) National Aeronautics and Space Administration Washington, DC 20546-0001 | | | 11. SUPPLEMENTARY NOTES Prepared by Propulsion Laboratory, Science and Engineering Directorate | |
| 12a. DISTRIBUTION/AVAILABILITY STATEMENT Unclassified—Unlimited Subject Category 15 Standard Distribution | | | 12b. DISTRIBUTION CODE | |
| 13. ABSTRACT (Maximum 200 words) This paper describes the methodology, model, input data, and analysis results of a reusable launch vehicle engine operability study conducted with the goal of supporting design from an operations perspective. Paralleling performance analyses in schedule and method, this requires the use of metrics in a validated operations model useful for design, sensitivity, and trade studies. Operations analysis in this view is one of several design functions. An operations concept was developed given an engine concept and the predicted operations and maintenance processes incorporated into simulation models. Historical operations data at a level of detail suitable to model objectives were collected, analyzed, and formatted for use with the models, the simulations were run, and results collected and presented. The input data used included scheduled and unscheduled timeline and resource information collected into a Space Transportation System (STS) Space Shuttle Main Engine (SSME) historical launch operations database. Results reflect upon the importance not only of reliable hardware but upon operations and corrective maintenance process improvements. | | | | |
| 14. SUBJECT TERMS EP73 operations analysis, operability, engine operations, reliability, availability, dependability, turnaround time, rocket engine, maintainability, scheduled and unscheduled maintenance, SSME operations data, reusable launch vehicle | | | 15. NUMBER OF PAGES 90 | |
| | | | 16. PRICE CODE A05 | |
| 17. SECURITY CLASSIFICATION OF REPORT Unclassified | 18. SECURITY CLASSIFICATION OF THIS PAGE Unclassified | 19. SECURITY CLASSIFICATION OF ABSTRACT Unclassified | 20. LIMITATION OF ABSTRACT Unlimited | |

15. Christenson, R.L.; and Ryan, R.M.: "*Critical Operations Analysis for a Future Reusable Engine*," unpublished, September 1997.
16. NASA-KSC, *STS CAPSS*, 1981-current.
17. NASA-KSC, *STS PRACA Database*, 1989-1994.
18. *MS Project User's Manual*, Microsoft Corporation, Redmond, WA, 1992.
19. *Extend™ User's Manual*, Imagine That®, Inc., San Jose, CA, 1995.
20. Rocketdyne, *SSME Orientation*, NASA Contract NAS8-40000, December 1991.
21. Jenkins, D.R.: *Space Shuttle*, Broadfield Publishing, Florida, 1992.
22. Law, A.; and Kelton, W.: *Simulation Modeling and Analysis*, McGraw-Hill, Inc., New York, 1991.
23. Hines, W.W.; and Montgomery, D.C.: *Probability and Statistics in Engineering and Management Science*, Wiley, NY, 1980.
24. Kapur, K.C.; and Lamberson, L.R.: *Reliability in Engineering Design*, Wiley, New York, 1977.
25. Morris, W.D.; et al.: "*Analysis of Shuttle Orbiter Reliability and Maintainability Data for Conceptual Studies*," AIAA-96-4245, September 1996.
26. Pierce, C.W.: "*A Cost Analysis of Integrated Vehicle Health Management as Applied to the Shuttle OMS/RCS*," LSO-093-1753, September 1993.
27. Snedecor, G.W.; and Cochran, W.G.: *Statistical Methods*, Iowa State University Press, Ames, Iowa, 1980.
28. Dhillon, B.S.: *Mechanical Reliability: Theory, Models, and Applications*, AIAA, Washington, DC, 20024, 1988.
29. Lee, R.A.; and Steincamp, J.W.: "*Reliability Analysis Techniques for Engine-Out Failures in Main Propulsion Systems*," AIAA-92-1337, March 1992.
30. Scientific Applications International Corporation, "*Current Launch Vehicle Practice and Data Base Assessment*," Astronautics Laboratory, Edwards Air Force Base, CA, 1989.