

TECH LIBRARY KAFB. NM
0144779

9301-141-1036

7852

TECHNICAL MEMORANDUMS
NATIONAL ADVISORY COMMITTEE FOR AERONAUTICS

No. 1036

AERODYNAMICS OF THE FUSELAGE

By H. Malthopp

Luftfahrtforschung
Vol. 18, No. 2-3, March 29, 1941
Verlag von R. Oldenbourg, München und Berlin

Washington
December 1942



NATIONAL ADVISORY COMMITTEE FOR AERONAUTICS

TECHNICAL MEMORANDUM NO. 1036

AERODYNAMICS OF THE FUSELAGE*

By H. Multhopp

SUMMARY

The present report deals with a number of problems, particularly with the interaction of the fuselage with the wing and tail, on the basis of simple calculating methods derived from greatly idealized concepts.

For the fuselage alone it affords, in variance with potential theory, a certain frictional lift in yawed flow, which, similar to the lift of a wing of small aspect ratio, is no longer linearly related to the angle of attack. Nevertheless there exists for this frictional lift something like a neutral stability point the position of which on oblong fuselages appears to be associated with the lift increase of the fuselage in proximity to the zero lift, according to the present experiments.

The pitching moments of the fuselage can be determined with comparatively great reliability so far as the flow conditions in the neighborhood of the axis of the fuselage can be approximated if the fuselage were absent, which, in general, is not very difficult.

For the unstable contribution of the fuselage to the static longitudinal stability of the airplane it affords comparatively simple formulas, the evaluation of which offers little difficulty. On the engine nacelles there is, in addition a very substantial wing moment contribution induced by the nonuniform distribution of the transverse displacement flow of the nacelle along the wing chord; this also can be represented by a simple formula. A check on a large number of dissimilar aircraft types regarding the unstable fuselage and nacelle moments disclosed an agreement with the wind-tunnel tests, which should be sufficient for practical requirements. The errors remained throughout within the scope of instrumental accuracy.

*"Zur Aerodynamik des Flugzeugrumpfes." Luftfahrtforschung, vol. 18, nos. 2-3, March 29, 1941, pp. 52-56.

For the determination of the fuselage effect on the lift distribution of the wing the flow transverse to the fuselage was assumed to be two-dimensional; then all the mathematical difficulties which the fuselage of itself would entail, can be removed by a conformal transformation of the fuselage cross section to a vertical slit. Then the calculation of the lift distribution for a wing-fuselage combination reduces to that of an equivalent wing, wherein the fuselage effect is represented by a change in chord distribution and also, to some extent, in the angle-of-attack distribution. Then the conventional methods of computing the lift distribution of a wing are fully applicable. In particular, it again affords two basic distributions from which the lift distributions for the different c_a values of the wing can be found by linear combination, as is customary on a wing without fuselage effect. The portion of lift taken over by the fuselage itself is easily estimated from the lift distribution so determined. The air load distributions determined for the wing-fuselage combination by this method differ considerably from those obtained by the orthodox method when the measured c_a differences were directly distributed as positive or negative fuselage lift across the fuselage width.

In the case of sideslip, the displacement flow of the fuselage causes an additional antisymmetrical lift distribution along the wing (for a high- or low-wing arrangement) with an attendant rolling moment of considerable magnitude. The simple formula evolved for this rolling moment on elliptical fuselage sections is very satisfactorily confirmed by the few available measurements.

As regards the effect of the fuselage on the flow conditions at the tail surfaces the sideslip of the fuselage for a high- or low-wing arrangement produces a sidewash at the vertical fin and rudder and leads to appreciable changes in directional stability and damping in yaw.

A few measurements demonstrating this phenomenon very distinctly are intended to rivet attention to the results of this phenomenon in the mechanics of unsymmetrical flight motions.

INTRODUCTION

One notoriously neglected phase in the aerodynamics of aircraft is that of the fuselage. This is due in the

first instance, to the fact that the fuselage considered by itself is a comparatively simple structure the effects of which are apparently readily perceived. But its real effects come into evidence only in combination with other parts of the aircraft, especially with the wing; hence it becomes necessary to evolve a fuselage theory which includes this mutual interference.

The search for mathematically exact solutions for such interference problems is exceedingly bothersome throughout, as it would entail the development of a three-dimensional potential theory with very arbitrary boundary conditions; a problem to which hardly more than a few proofs of existence could be adduced.

It therefore seemed expedient to evolve appropriate formulas which, for each phenomenon, bring out the essential parts while disregarding all secondary effects. Obviously such a method of treatment must first be justified either by an estimation of the errors involved or by suitable tests. The method itself as described hereinafter is merely to be construed as a first step which, because of the increasingly pressing demands of practical airplane design in this respect, will have to be attacked some time even if the suggested methods should for the present appear somewhat unwieldy. The mechanics of flight performance, the aerodynamics of the load assumptions for the stress analysis of aircraft and the mechanics of flight characteristics, all came under the influence of the fuselage or the engine nacelles.

For the present task the performance mechanics are, in general, excluded, since drag problems usually must be left to experimental research. As to induced resistances, the fuselage merely changes for the most part their distribution in an at times admittedly wholly unusual measure, but scarcely the total amount of the induced drag of aircraft. More important is the effect on the maximum lift, and hence the landing speed, for which the presented calculations may in many cases afford an explanation.

The stress analysis of aircraft stipulates the exact load distribution across the wing under the effect of fuselage and engine nacelles and also of the distribution of the aerodynamic loads along fuselage and nacelles themselves. As matters stood in this respect the discrepancies in air forces and moments between a model with fuselage and the wing alone were directly ascribed to the fuselage or to the

engine nacelles. In contrast with this the present calculations indicate that these changes in the air loads are in the majority of cases due to the effect of the fuselage on the wing and should therefore be treated as wing loads.

In the predetermination and the interpretation of the flight characteristics of an aircraft type a large number of problems also arises that fuselage aerodynamics must solve. There is, in particular, the position of the neutral stability point, so important for the mechanics of symmetrical flight motions which under the effect of fuselage and nacelle shifts considerably forward. But in unsymmetrical flight motions the fuselage also plays a noticeable part. First, in sideslip it affects the flow conditions at the wing in such a manner as to produce a rolling moment in yaw largely dependent upon the location of the wing relative to the fuselage, the order of magnitude of which is in many cases, comparable with that of the rolling moment due to yaw induced by the dihedral angle of the wing. Equally important, is the reaction of the lift distribution of the wing produced under the effect of the fuselage in the case of sideslip on the flow at the fin and rudder, namely, a considerable sidewash which, like the downwash on elevator and stabilizer, affects the directional stability and the damping in yaw in different manner. Hence, instead of the simple concept of damping in yaw two quantities should be considered: First, a rotation of the aircraft due to a path curvature, then a pure rotation of the aircraft without change of flight path, and the cited modifications of damping in yaw due to the sidewash occur only in the latter case. The knowledge of these conditions is in some degree important for the appraisal of lateral stability problems, and with the yaw vibrations of modern aircraft these effects cannot be ignored.

THE FUSELAGE ALONE

Before proceeding to the analysis of the interference of the fuselage with the other parts of the airplane, a brief discussion of the phenomena observed on the fuselage in the absence of all other airplane parts, is necessary. The greater part of the data can be taken over from the already existing data on airship hulls, as compiled, for instance, in volume VI of Durand's "Aerodynamic Theory."

On analyzing the conditions in frictionless parallel flow the first result is the total absence of resultant forces on the fuselage; the pressure distribution over the body merely affords free moments. These free moments are of some significance since they are proportional to the angle of attack of the fuselage and hence enter the stability quantities. The sign of these moments is such that the stability about the normal axis or about the lateral axis is lowered by the action of these free moments. On an axially symmetrical fuselage the free moment in flow along the fuselage axis is, of course, zero; on unsymmetrical fuselage forms or by appendages the axis for zero moment can be located at any other place. The free moment is produced by negative pressure on the upper side of the bow and on the lower side of the stern and positive pressure at the lower side of the bow and on the upper side of the stern (fig. 1).

The free moments can be computed in various ways. If time and patience are no object a field of singularities substituting for the fuselage may be built up by means of potential theory methods as developed by Von Kármán, Lotz, Kaplan, and others. But for the task in hand Hunk's method (reference 1) is much more suitable. He simply determined the asymptotic value for very slender fuselage forms and then added a correction factor dependent on the slenderness ratio, which he obtained by a comparison with the values of easily and accurately computable forms.

According to Hunk the unstable moment of a very slender body of revolution is

$$\frac{1}{q} \frac{dM}{d\alpha} = -2 \text{ vol.} \quad (2.1)$$

the effect of finite fuselage length being accounted for by the correction factor $(K_2 - K_1)$ which depends on the slenderness ratio l/D (fig. 2). In this representation K_2 is the air volume in ratio to the fuselage volume by transverse motion of the fuselage and K_1 that by longitudinal fuselage motion. For other than axially symmetrical surfaces it is

$$\frac{1}{q} \frac{dM_R}{d\alpha} = -\frac{\pi}{2} (K_2 - K_1) \int_0^l b_R^2 dx \quad (2.2)$$

and for the contribution to the yawing moment:

$$\frac{1}{q} \frac{dN_R}{d\tau} = -\frac{\pi}{2} (K_2 - K_1) \int_0^l h_R^2 dx \quad (2.3)$$

The unstable longitudinal moment of the fuselage which still changes considerably under the effect of the flow round the wing is taken care of later by more reliable formulas, while the formula for the yawing moment can be summarily taken over, as the wing downwash affords no appreciable contribution to the momentum of the fuselage flow along the transverse axis.

Rotations of a fuselage about the center of gravity of the fuselage volume on surfaces of revolution or about the center of gravity of the volumes

$$\int_0^l b_R^2 dx \quad \text{or} \quad \int_0^l h_R^2 dx$$

are neither accompanied by a resultant force nor an additive moment so long as the conditions in ideal flow are only considered. It merely results in a slightly modified transverse force distribution. If the rotation is not about the center of gravity of the volume, the moment resulting from the local yawed flow exactly in this center of gravity due to the rotation is used in the calculation. So, if in rotations about the normal aircraft axis, for instance, the center of gravity of the aircraft is, as usually happens, before the center of gravity of the fuselage volume, the fuselage directly furnishes a negative contribution to the damping in yaw by an amount

$$\frac{1}{q} \frac{2v}{b} \frac{dN_R}{d\omega_z} = \pi(K_2 - K_1) \frac{\Delta x}{b} \int_0^l h_R^2 dx \quad (2.4)$$

where Δx is the distance of the aircraft center of gravity and the volume center of gravity.

This is all that the consideration of the potential theory supplies concerning a single fuselage. But the actual behavior of the fuselage is not described by the potential flow alone. As soon as the flow past the fuselage

ceases to be perfectly symmetrical boundary-layer material accumulates more on one side than on the other and the flow conditions are altered. This results in additional forces at the fuselage and so becomes an appreciable factor in the moment balance of the fuselage. The point of application of the induced frictional lift or cross force is of course proportionally far aft at the fuselage. This moment is secured from the measurements after subtracting the theoretically unstable contribution from the recorded moments and correlating the remaining rest moment with the lift or cross force. Unfortunately the appraisable measurements are very scarce; the data used were from the NACA Reports Nos. 394 and 540, as well as from several unpublished data from Fw measurements. The outstanding feature of these evaluations was the existence of something like a neutral point for the frictional lift also, despite the fact that this lift is not even linearly related to the angle of attack (figs. 3 and 4).

As the dependence of frictional lift on angle of attack is strongly suggestive of a very similar course on wings of very small aspect ratio, its correlation suggests itself. For a wing of very small aspect ratio we get approximately $\alpha = 0$:

$$\frac{l}{q} \frac{dA}{d\alpha} = \frac{\pi}{2} b^2 \quad (2.5)$$

a result readily derivable by means of certain momentum considerations which is in good agreement with the available test data for such wings. However, the conventional fuselage has no sharp sides; hence a temporarily unknown measure that denotes the width of the separating boundary layer substitutes for the width b . In place of it we correlate the lift to the maximum fuselage width b_R and introduce a form factor f the exact determination of which might be a profitable field of experimental research; presumably it depends, above everything else, on the cross-sectional form of the fuselage on its solidity and the location of appendages. Hence we put

$$\frac{l}{q} \frac{dA_R}{d\alpha} = \frac{\pi}{2} f b_R^2 \quad (2.6)$$

or correspondingly for the lateral force

$$\frac{1}{q} \frac{dY_R}{dr} = - \frac{\pi}{2} fh_R^2 \quad (2.7)$$

Then the evaluated measurements available indicate, what by itself was plausible, a certain relationship between the form factor f and the position of the applied point of the frictional lift denoted with x_n (measured from nose of fuselage) in figure 5. This point is located, as may be expected, so much farther back as the frictional lift is actually less developed. This relationship of x_n with f has, at any rate, the advantage of obviating the extreme caution required in the estimation of the yawing moment due to yaw from the frictional transverse force at the usual center of gravity positions of the aircraft. It is further seen that the directional stability is so much more intimately related to this center of gravity position as f is greater and the slenderness ratio of the fuselage is smaller. The extent to which the fuselage boundary layer leads to the formation of aerodynamic forces and moments in rotations of the fuselage about the normal or the transverse axis, is up to now utterly unpredictable; their explanation is, of course, a matter of experiment.

FUSELAGE LONGITUDINAL MOMENTS UNDER THE EFFECT OF THE WING

In this instance the foregoing appraisal of the moments of the fuselage in free stream fails, because the flow pattern of the wings causes a very substantial variation of the flow at the fuselage. To begin with, the previously described frictional lift of the fuselage is not likely to exist, since the wing orientates the flow along the wing chord and even far aft of it with the result that no appreciable flow component transverse to the fuselage exists in the real zone of formation of the frictional lift. Hence there is some justification in assuming that the theoretically anticipated moments will afterward actually occur.

First of all the fuselage with wing differs from the fuselage alone in that the fuselage takes up a very substantial proportion of the lifting forces ordinarily carried by the wing section in its place. According to Lennertz (reference 4) and Vandrey (reference 5) the point

of application of the aerodynamic forces at the fuselage directly due to the circulation of the wing, is located at the same place as on the substitute wing section; separating this air force distribution for the moment leaves only a free moment which is solved from a simple momentum consideration.

Next the fuselage is assumed to be sufficiently long, so that, after fixing a reference plane at right angles to the flow direction that meets the fuselage at distance x from the nose, the integral over the pressure distribution of the fuselage portion ahead of the reference plane equals the vertical momentum passing through this area in unit time. Then, with β as the angle in yaw in the reference plane, that is, the angle which the flow would form with the fuselage axis if the fuselage were non-existent, and b_R as the fuselage width at this point, the lift of the thus segregated fuselage portion (fig. 6) is:

$$\int_0^x \frac{dA_R}{dx} dx = \rho v^2 \beta \frac{\pi}{4} b_R^2 \quad (3.1)$$

For, if the fuselage is long enough, the flow at right angles to the fuselage axis may be approximated to two-dimensional, and for the flow at right angles to an elliptic cylinder the comprised air volume, that is, the integral is

$$\int \rho (v_n - v_{n\infty}) df = \rho v_{n\infty} \frac{\pi}{4} b_R^2 = \rho v \beta \frac{\pi}{4} b_R^2 \quad (3.2)$$

(v_n and $v_{n\infty}$ being the components at right angles to cylinder axis) independent of the axes ratio of the ellipse. Since this formula holds true even for a cylinder degenerated to a flat plate, its approximate use for all cross-section forms appears justified.

Differentiation with respect to x then affords:

$$\frac{1}{q} \frac{dA}{dx} = \frac{\pi}{2} \frac{d}{dx} (\beta b_R^2) \quad (3.3)$$

By reason of the disappearance of b_R the so computed total fuselage lift is zero at both its ends, hence gives the desired free moments additionally supplied by the fuselage. This free moment is for any reference point

$$\frac{M_R}{q} = \frac{\pi}{2} \int_0^l \frac{d}{dx} (\beta b_R^2) x dx \quad (3.4)$$

and, after partial integration:

$$\frac{M_R}{q} = - \frac{\pi}{2} \int_0^l \beta b_R^2 dx \quad (3.5)$$

For surfaces of revolution on which the flow is not disturbed by the presence of the wing, we get, because $\beta = \text{constant}$

$$\frac{M_R}{q\beta} = - \frac{\pi}{2} \int_0^l D^2 dx = - 2 \text{ vol.} \quad (3.6)$$

or the same result as Munk's for the free moments of airship hulls. It then might be advisable to apply a correction factor to these free fuselage moments on Munk's pattern, containing the effect of the finite fuselage length, except for the difficulty of not quite knowing what slenderness ratio to apply. The reduction relative to the theoretical value is primarily due to the fact that the flow at the fuselage ends still varies somewhat from the assumed two-dimensional pattern; and while the rear end contributes almost nothing to the free fuselage moment, the portions of the fuselage directly before the wing, which certainly are not encompassed by this reduction through the effect of the finite length, contribute very large amounts. Hence the actual value for the correction factor is likely to be far closer to 1 than Munk's quantity ($K_2 - K_1$). So far the check on a large number of measurements has shown small need for such a correction factor in the prediction of the longitudinal moments of the fuselage.

The presence of the wing is allowed for by relating β to the wing circulation. The change of the moment with the angle of attack is:

$$\frac{1}{q} \frac{dM_R}{d\alpha} = - \frac{\pi}{2} \int_0^l b_R^2 \frac{d\beta}{d\alpha} dx \quad (3.7)$$

The change of the yawed flow with the angle of attack $\frac{d\beta}{d\alpha}$ is expressed as follows: The flow in the region of the wing is practically parallel to the wing chord; hence $\frac{d\beta}{d\alpha} = 0$. Behind the wing the downwash reduces the yawed flow; at the fuselage stern in the vicinity of stabilizer and elevator there is obtained:

$$\frac{d\beta}{d\alpha} = 1 - \frac{d\alpha_w}{d\alpha}$$

It is sufficiently exact, when assuming that $\frac{d\beta}{d\alpha}$ rises linearly from the wing trailing edge to this value. Before the wing $\frac{d\beta}{d\alpha}$ is always greater than 1 because of the prevalent uprush. Altogether the aspect is somewhat as shown in (fig. 7). To estimate the values $\frac{d\beta}{d\alpha}$ before the wing in lieu of an exact calculation (fig. 8) computed for $\Lambda = 8$ aspect ratio, or equivalent to a lift curve slope of $ca' = 4.5$ may serve as the basis. For other aspect ratios the values are converted approximately in proportion to the ca' values. Since $\frac{d\beta}{d\alpha}$ reaches a fairly high peak in wing proximity, this value itself is not reproduced but the integral from the wing leading edge to a certain point before it. The integration with respect to equation (3.7) is readily accomplished by means of these curves.

For the prediction of the zero moment $c_{m0} = c_m$ ($c_a = 0$) the same arguments hold true except that the

wing effect is usually considerably less. Given the exact zero lift direction of the airplane preceded by several lift distribution calculations, the respective β values are determined and the integration with respect to equation (3.5) carried out. The displacement flow due to finite wing thickness which heretofore played no part in the consideration may not be ignored altogether. This is especially true if engine nacelles are involved, where the c_{m0} value then is quite intimately associated with the location of the wing on the fuselage. The moment contribution from the fuselage drag is usually very small.

The arguments so far were largely patterned after the conditions at the airplane fuselage, that is, relatively long bodies compared to wing chord. But the conditions are somewhat different on engine nacelles because they usually extend only forward beyond the wing. By reason of the decrease in nacelle width along the wing chord the normal velocities, induced by the nacelle, themselves decrease along the chord. Since these induced velocities are proportional to the angle of setting of the nacelle, it implies a curvature of the wing inflow dependent on c_a , and in turn, additional wing moments dependent on value c_a . Hence there exists, besides the pure nacelle moment which is readily computable from equation (3.7), a wing moment due to the effect of the nacelle M_{ng} , which represents a further unstable contribution to the longitudinal moments. It is estimated as follows:

With β_v as the slope of the flow at wing leading edge, β_m at wing center, and β_h at trailing edge, two-dimensional airfoil theory (mean-line theory according to Prandtl-Birnbaum) gives:

$$c_{m0} = \frac{\pi}{16} (3\beta_h - \beta_v - 2\beta_m) \quad (3.8)$$

Integration of the β values over the entire wing, but the nacelle region itself excluded, approximates to

$$\int_{-b/2}^{b/2} \beta dy \approx \int_{-\infty}^{\infty} \beta dy = \alpha_q b_c \quad (3.9)$$

Hence a wing moment under the effect of the nacelle of the order of magnitude of

$$\frac{M_{FG}}{q} = - \frac{\pi}{16} \alpha_G \left[b_{Gv} + 2 b_{Gm} - 3 b_{Gh} \right] t_G^2 \quad (3.10)$$

where t_G is the wing chord in the nacelle region. It is readily seen that this moment contribution is far from negligible when practical nacelle and wing dimensions are involved. To illustrate: A nacelle not protruding beyond the trailing edge ($b_{Gh} = 0$) and the width of which at wing center amounts to about 3/4 of that at the wing leading edge, gives a moment contribution of

$$\frac{1}{q} \frac{dM_{FG}}{d\alpha} \approx 0.5 b_G t_G^2$$

The manner of moment distribution over the wings is not exactly predictable on the basis of this simple calculation, since the mutual induction of the separate wing sections produces various displacements, but little touches the total values as a rule. It is clear that this additional wing moment must also be included in the c_{mo} determination, when the nacelle is set at an angle with the wing.

Moreover it should be noted, when computing the nacelle effect on a complete airplane, that the transverse flow to the engine nacelle is already under the influence of the fuselage, so that the nacelle moments must be often increased in proportion.

In practical longitudinal stability studies it is always recommended to represent the stability contributions of separate aircraft components as displacements in neutral stability points; with Δx_n as forward displacement of the neutral stability point we get

$$\frac{\Delta x_n}{t} = - \frac{1}{c_a' q F t} \frac{dM_R}{d\alpha} \quad (3.11)$$

To check the practical use of these formulas, the author computed these values for a series of Fw types, on which the displacement of neutral stability point had

been determined from difference measurements in wind-tunnel tests. Table 1 gives the results of this check, with the note, however, that the measured displacements of neutral stability point, at the determination of which a certain uncertainty is inevitable for instrumental reasons, had been determined before the start of the calculation from the wind tunnel.

TABLE I.- DISPLACEMENT OF NEUTRAL STABILITY POINT DUE TO FUSELAGE AND NACELLE FOR SEVERAL Fw TYPES.

Design Type	$100 \frac{\Delta x_n}{t} = 100 \frac{\delta \Delta c_n}{d c_a}$	
	Measured	Computed
A Fuselage	2.0	2.3
Nacelles	2.2	2.4
B Fuselage	4.1	4.1
Inboard Nacelles	3.7	3.7
Outboard Nacelles	2.4	2.3
C Fuselage	9.2	9.4
Propeller Mount	0.8	0.6
D Fuselage	1.4	1.5
Nacelles	4.4	4.2
E Fuselage	2.0	2.0
Tail Boom	2.0	2.3
F Fuselage V_1	5.6	6.0
Fuselage V_S	4.0	4.4
G Fuselage	4.0	4.1
Nacelles	3.5	3.5

A similar check by Vandrey on a series of U.S. fuselage-wing combinations, also afforded a good confirmation of our theory. In further support are cited the works by Muttray (reference 6) on the design of ideal fuselage forms of minimum drag where the problems treated here, were not of such great significance. He dealt with the design of several fuselages the axes of which follow the wing flow completely at a certain c_a value, hence β_R is zero. Actually, there is also no additional moment relative to wing alone, at this c_a value. That it is of great significance for the matters dealt with here is readily apparent by comparison with the fuselage forms not so well faired into the flow. For the rest, Muttray's measurements show exactly as those of the NACA Report No. 540, that wing root fillets of normal size have scarcely any effect on the moments and can therefore be disregarded.

In conclusion it is pointed out that the formulas developed here for the stability contribution of fuselage and engine nacelles are not restricted to the midwing

monoplane; the dependence of $\frac{dM_R}{d\alpha}$ on the location of the

wing relative to the fuselage is very slight. This checks quite well with some NACA tests (Rep. No. 540), so far as separation phenomena especially on the low-wing arrangements do not falsify the records. Figure 22 of NACA Report No. 540 discloses very plainly that the curves of the moments plotted against the location of the wing relative to the fuselage moments are merely shifted parallel to each other for the different c_a values, which is not quite so plain in the tables at the end of the report. Ob-

viously the appraisal of the measured $\frac{dc_m}{dc_a}$ value depends

to a considerable extent upon the skill of the operator.

AIR LOAD DISTRIBUTION ALONG THE WING UNDER THE INFLUENCE OF THE FUSELAGE

The fuselage influences the wing chiefly through a change of flow velocity in quantity and direction at each wing section. In addition, it forms a fixed boundary, for all supplementary flows induced at the wing, which means

that no velocity components at right angles to its surface can exist. Any method for solving the fuselage effect must, of course, allow for these two actions. A further effect difficult to define mathematically arises from the boundary flow of the fuselage, which in many cases results in a lift decrease on the wing section close to the fuselage and on certain low-wing arrangements is responsible for a premature separation of the wing flow adjacent to the fuselage. However, this boundary layer effect should no longer be excessive on the aerodynamically clean fuselages of today.

The flow past the fuselage is suitably divided in a displacement flow parallel to the fuselage axis and one at right angles to it. The first usually affords slight increases of velocity in wing proximity, which are so much greater as the slenderness ratio of the fuselage is smaller. The velocities from the transverse flow of the fuselage, normal to the wing have the significance of an angle of attack change.

Then the circulation about a wing section is

$$\Gamma = c v t \alpha_{\text{eff}} \quad (4.1)$$

the effective angle of attack α_{eff} being the angle between the local flow direction and the zero lift direction of the wing section. With w_n as stream component at right angles to zero lift direction we get

$$\alpha_{\text{eff}} = \frac{w_n}{v} \quad (4.2)$$

whence

$$\Gamma = c t w_n \quad (4.3)$$

The normal speed w_n is built up from three contributions

$$w_n = \alpha_f v + w_{nR} + w_i \quad (4.4)$$

with α_f the local angle of attack of the wing section, that is, the angle between the flight path and its zero lift direction; w_{nR} the supplementary normal speed under

the effect of the fuselage and w_1 the usually negative induced speed from the vortex layer produced behind the wing.

The lift density per unit length is according to the Kutta-Joukowski law

$$\frac{dA}{dy} = \rho v \Gamma \quad (4.5)$$

hence

$$\frac{dA}{dy} = \rho v w_n ct \quad (4.6)$$

A comparison of the displacement flow of fuselages of very dissimilar slenderness ratio reveals the unusual fact that the product of inflow velocity V following from the longitudinal circulation and normal velocity w_n proportional to the fuselage angle of attack is almost independent of the slenderness ratio of the fuselage. So, since in this product the normal speed w_n resulting from the transverse flow is largely decisive for the course along the wing span, it seems justified to figure, instead of with a fuselage of finite length, with a very elongated cylinder having the same cross section as the fuselage at $3/4$ wing chord. Then the speed changes are eliminated, leaving only angle of attack changes. This approximate assumption affords the added possibility of computing the induced speeds along the wing span in rational manner. The extent of the error introduced hereby is reflected in figure 9, where the product $v w_n R$ for a fuselage of infinite length and for one of slenderness ratio $l/D = 4$ is illustrated.

The speeds w_{nR} normal to the wing are obtained by means of conformal transformation, so that the fuselage cross section changes into a vertical slit (fig. 10). Such a conformal transformation is readily applied to modern fuselage sections which usually are circles or ellipses or at least approach such very closely. But divergent forms can also be transformed to a circle or ellipse by any one of the known rectifying methods and then treated in the usual manner. With

$$u = z + iy \quad (4.7)$$

as complex coordinate in the plane at right angles to fuselage axis and

$$\bar{u} = \bar{x} + i\bar{y} \quad (4.8)$$

the coordinate in the plane where the fuselage is merely a vertical slit resulting from conformal transformation

$$\bar{u} = \bar{u}(u) \quad (4.9)$$

the z component of the supplementary displacement flow transverse to the fuselage is equal to

$$w_{nR} = \alpha_R v \left[\Re \left(\frac{d\bar{u}}{du} \right) - 1 \right] \quad (4.10)$$

where $\Re \left(\frac{d\bar{u}}{du} \right)$ is the real part of the derivation of the conformal function $\bar{u}(u)$ by reason of the presence of a pure parallel flow toward the \bar{x} axis of the order $\alpha_R v$ in the \bar{u} plane. The solution of the load distribution is further predicated on the knowledge of the induced speeds along the wing where the presence of the fuselage must also be taken into consideration.

Here the principal advantage of introducing a fuselage of infinite length is evident. No singularities within the fuselage need to be applied for the compliance of the boundary conditions at the fuselage surface. Conformal transformation brings the fuselage in a form where these conditions are of themselves satisfied. For this purpose we revert to Trefftz's formulas (reference 7), which reduce the lift distribution to a potential boundary-value problem. The introduction of a potential function Φ for the supplementary flow induced by the wing, affords two-dimensional conditions again sufficiently downstream from the wing if the effect of the rolling-up process of the vortices is disregarded. Denoting boundary values of Φ far downstream from the wing with

$$\varphi = \lim_{x \rightarrow -\infty} \Phi \quad (4.11)$$

the circulation about any wing section, after one integration above the wing and one below the wing along a streamline, is:

$$\Gamma(y) = \varphi_o(y) - \varphi_u(y) \quad (4.12)$$

And, with w_1 exactly half as great at the point of the wing, we get

$$w_1 = \frac{1}{2} \frac{\partial \varphi}{\partial z} \quad (4.13)$$

Since the presence of the fuselage must be taken into consideration again for the induced supplementary wing flow we now conformally transform the potential $\varphi(y, z)$ from plane U on plane \bar{U} , where, of course, the amounts of φ remain unchanged:

$$\varphi(y, z) = \varphi(\bar{y}(y, z), \bar{z}(y, z)) \quad (4.14)$$

while the conformal factor $\frac{d\bar{u}}{du}$ reenters the derivation

$$\frac{\partial \varphi}{\partial z} \approx \frac{\partial \varphi}{\partial \bar{z}} R \left(\frac{\partial \bar{u}}{\partial u} \right) \quad (4.15)$$

(The mean value of $\frac{\partial \varphi}{\partial y}$ above and below the wing is always close to zero.) Hence

$$w_1(y) = \bar{w}_1(\bar{y}) R \left(\frac{\partial \bar{u}}{\partial u} \right) \quad (4.16)$$

$\bar{w}_1(\bar{y})$ is readily defined; since no speed at right angles to the slit, representing the fuselage, remains for symmetrical air load distributions, the conventional formula of airfoil theory follows at

$$\bar{w}_1(\bar{y}) = \frac{-1}{4\pi} \int_{-\bar{b}/2}^{\bar{b}/2} \frac{d\Gamma}{d\bar{y}'} \frac{d\bar{y}}{\bar{y} - \bar{y}'} \quad (4.17)$$

so that the calculation in the $y - \bar{z}$ plane can be effected with the usual lift distribution method.

Altogether we get, when transforming equation (4.3) in the \bar{U} plane

$$\Gamma(\bar{y}) = ct(\bar{y}) \left\{ v \alpha_F(\bar{y}) + \alpha_R v \left[\frac{R}{R} \left(\frac{d\bar{u}}{du} \right) - 1 \right] - \frac{1}{4\pi} R \left(\frac{d\bar{u}}{du} \right) \int_{-\bar{b}/2}^{\bar{b}/2} \frac{d\Gamma}{d\bar{y}'} \frac{d\bar{y}}{\bar{y} - \bar{y}'} \right\} \quad (4.18)$$

whereby

$$\left. \begin{aligned} \Gamma(\bar{y}) &= \Gamma[y(\bar{y})] \\ t(\bar{y}) &= t[y(\bar{y})] \\ \alpha_F(\bar{y}) &= \alpha_F[y(\bar{y})] \end{aligned} \right\} \quad (4.19)$$

To simplify the calculation, we form

$$\bar{\gamma} = \frac{\Gamma}{b v} \quad (4.20)$$

$$\bar{\eta} = \frac{2\bar{y}}{b} \quad (4.21)$$

$$\bar{\alpha}_1 = \frac{1}{2\pi} \int_{-1}^1 \frac{d\bar{\gamma}}{d\bar{\eta}'} \frac{d\bar{\eta}'}{\bar{\eta} - \bar{\eta}'} = - \frac{\bar{w}_1}{v} \quad (4.22)$$

hence

$$\bar{\gamma} = \frac{ct}{b} (\bar{\eta}) \frac{R}{R} \left(\frac{d\bar{u}}{du} \right) \left\{ \frac{\alpha_F(\bar{\eta}) - \alpha_R}{\frac{R}{R} \left(\frac{d\bar{u}}{du} \right)} + \alpha_R - \bar{\alpha}_1(\bar{\eta}) \right\} \quad (4.23)$$

The advantage of dividing the lift distribution into that of the wing set at an angle with the fuselage axis and that of the wing and fuselage together set at the same angle is readily apparent:

$$\nabla = \nabla_0 + \alpha_R \nabla_R \quad (4.24)$$

Then:

$$\nabla_0 = \frac{ct}{b} R \left(\frac{dU}{du} \right) \left\{ \frac{\alpha_F(\bar{\eta}) - \alpha_R}{R \left(\frac{dU}{du} \right)} - \bar{\alpha}_{i0} \right\} \quad (4.25)$$

and

$$\nabla_R = \frac{ct}{b} R \left(\frac{dU}{du} \right) (1 - \bar{\alpha}_{iR}) \quad (4.26)$$

This method is no different from the other usual methods, except that the wing chord is multiplied by the correction factor $R \left(\frac{dU}{du} \right)$ while the twist $(\alpha_F - \alpha_R)$ is divided by it.

A little care must be exercised in locating the points on the wing where the lift distribution is to be determined. It is:

$$\begin{aligned} \bar{y} &= \underline{J} (\bar{u}) \\ &= \underline{J} [\bar{u} (z + iy)] \end{aligned}$$

and the span in the \bar{U} plane follows from

$$\frac{\bar{b}}{2} = \underline{J} \left[\bar{u} \left(z_F + i \frac{b}{2} \right) \right]$$

AIR LOAD DISTRIBUTION ON THE FUSELAGE

Since the distribution over the fuselage width is in closest relation with the lift distribution over the area it is determined first. With the potential Φ introduced previously for the additional velocity due to the action of the wing, the local flow velocity along the x-direction is

$$v = V + v_x \quad (5.1)$$

with

$$v_x = \frac{\partial \phi}{\partial x}$$

Then, according to Bernoulli's theorem:

$$p_0 + \frac{\rho}{2} V^2 = p + \frac{\rho}{2} [(V + v_x)^2 + v_y^2 + v_z^2] \quad (5.2)$$

which, with allowance for the small terms of the first order only affords

$$p - p_0 = -\rho V \frac{\partial \phi}{\partial x} \quad (5.3)$$

and, after integration along a strip of the fuselage wall:

$$\int_{-\infty}^{\infty} (p - p_0) dx = -\rho V \phi \quad (5.4)$$

Then the course of the potential ϕ far behind the wing even on the fuselage contour is an indication of the extent to which the single fuselage strip takes up air loads. Since for the forces taken up by the fuselage the difference of upper and lower side is of principal concern, it is easily seen that the omission of the quadratic terms $v_x^2 + v_y^2 + v_z^2$ in equation (5.2) is justified, since they are of the same order of magnitude above and below.

The determination of ϕ on the fuselage contour is easily accomplished by the same conformal transformation used in the prediction of the lift distribution. The fuselage is represented by a vertical slit in the U -plane, $\phi(\bar{z})$ is expanded in Taylor series from the height position of the wing \bar{z}_F :

$$\phi(\bar{z}) = \phi(\bar{z}_F) + (\bar{z} - \bar{z}_F) \frac{\partial \phi}{\partial \bar{z}}(\bar{z}_F) + \dots \quad (5.5)$$

The expansion can be stopped after the first two terms. Then we get for $\bar{x} > \bar{x}_F$, hence, for the zone below the wing

$$\varphi(\bar{x}_F) = -\frac{1}{2} \Gamma(\bar{y} = 0) \quad (5.6)$$

and for $\bar{x} < \bar{x}_F$

$$\varphi(\bar{x}_F) = +\frac{1}{2} \Gamma(\bar{y} = 0) \quad (5.7)$$

while in both cases

$$\frac{\partial \varphi}{\partial \bar{x}}(\bar{x}_F) = 2 \bar{w}_1(\bar{y} = 0) \quad (5.8)$$

The aspect of $\varphi(\bar{x})$ is then as shown in figure 11. The relationship of $y(\bar{x})$ being known, the transformation of this curve on the original fuselage contour in the U plane, then presents no difficulty.

For the solution of the air load distribution along the fuselage the air load is again divided into two parts, one giving a free moment, the other only a lift with the resultant at $t/4$ of the wing center section. For the distribution of the air loads upstream and downstream from the wing only the first porportion is involved. The distribution then follows immediately from the formula (3.3).

In the region of the wing the lift is distributed corresponding to the chordwise distribution of the wing portion which would lie in the fuselage zone if the fuselage were not there. The very high local lift coefficients produced in the neighborhood of the fuselage nose are, however, considerably compensated according to (3.3) - β and $\frac{d\beta}{d\alpha}$ drop very rapidly to zero at the wing nose. The

distribution so obtained along the entire fuselage needs to be a little compensated, but without particular care, since the transverse forces and moments in the fuselage follow only after integration from these distributions; hence are not very susceptible to small errors, so long as the total lift and the fuselage longitudinal moment assume the values

computed in the foregoing. The distributions are then as shown in figure 12.

PRACTICAL CALCULATION OF LIFT DISTRIBUTION
WITH ALLOWANCE FOR THE FUSELAGE

The application of the theoretical results of the previous sections is predicated on the following necessary data:

1. The wing chord and twist, the latter being appropriately measured or reduced relative to the fuselage axis in the zone of the wing as reference axis. Also of importance is the so-called aerodynamic twist, that is, the position of the zero lift direction of each wing section and not of the wing chord relative to the reference axis.
2. A sketch of the fuselage showing the exact location of the wing on the fuselage.

The first thing then is to obtain the function $\bar{u}(u)$ for the conformal transformation. To this end we plot the section through the fuselage at $3/4$ the wing root chord. For the fuselage of circular section with radius R we get

$$\bar{u} = u + \frac{R^2}{u} \quad (6.1)$$

$$\frac{d\bar{u}}{du} = 1 - \frac{R^2}{u^2} \quad (6.2)$$

The trace of the wing in the \bar{U} -plane follows at

$$\bar{y} = y \left[1 - \frac{R^2}{y^2 + z_F^2} \right] \quad (6.3)$$

the factor $\underline{R} \left(\frac{d\bar{u}}{du} \right)$ is:

$$E \left(\frac{d\bar{u}}{du} \right) = 1 + \frac{R^2 (y^2 - z_F^2)}{(y^2 + z_F^2)^2} \quad (6.4)$$

which for $z = 0$ (midwing arrangement) simplifies to:

$$\bar{y} = y - \frac{R^2}{y} \quad (6.5)$$

$$R \left(\frac{d\bar{u}}{du} \right) = 1 + \frac{R^2}{y^2} \quad (6.6)$$

The fuselage with elliptic cross section is transformed in two stages: The ellipse in the U-plane is first transformed into a circle in the U_1 -plane, and then transformed in a vertical slit (fig. 13). The intermediate transformation affords the function

$$u = u_1 + \frac{R_1^2}{u_1} \quad (6.7)$$

which transforms the connecting line of the centroids of the ellipse ($z = \pm E$) to a circle of radius

$$R_1^2 = \frac{E^2}{4} = \frac{A^2 - B^2}{4} \quad (6.8)$$

The ellipse with the semiaxes A and B then becomes a circle with radius

$$R_2 = \frac{A + B}{2} \quad (6.9)$$

This circle is then transformed into the vertical slit by

$$\bar{u} = u_1 + \frac{R_2^2}{u_1} \quad (6.10)$$

From equations (6.7) and (6.10) it then follows that

$$\bar{u} - u = \frac{1}{u_1} (R_2^2 - R_1^2) \quad (6.11)$$

and

$$\bar{u} R_1^2 - u R_2^2 = u_1 (R_1^2 - R_2^2) \quad (6.12)$$

which multiplied by each other, give

$$\bar{u}^2 R_1^2 - u \bar{u} (R_1^2 + R_2^2) + u^2 R_2^2 + (R_2^2 - R_1^2)^2 = 0 \quad (6.13)$$

or, because of (6.7) and (6.9):

$$\bar{u}^2 - \frac{2A}{A-B} \bar{u} u + \frac{A+B}{A-B} (u^2 + B^2) = 0 \quad (6.14)$$

hence

$$\bar{u} = \frac{1}{A-B} [A u - B \sqrt{u^2 - A^2 + B^2}] \quad (6.15)$$

This is the conformal function that changes the ellipse in the U -plane directly into the vertical slit in the U -plane. The correlation between the points of the U -plane, that is, especially the coordinates of the wing and those of the U -plane is obtained by elementary calculation by means of equation (6.15). It is best to put

$$u = z + i y = a \cos \varphi + i b \sin \varphi \quad (6.16)$$

where a is the arithmetic mean of the distances of the point from the two centroids of the ellipse, while $b = \sqrt{a^2 - E^2}$. Then

$$\sqrt{u^2 - a^2 + b^2} = b \cos \varphi + i a \sin \varphi \quad (6.17)$$

The \bar{y} -coordinate of the transformed wing needed for solving the lift distribution then becomes

$$\begin{aligned} \bar{y} = \underline{J}(u) &= \frac{1}{A - B} (A b \sin \varphi - B a \sin \varphi) \\ &= \frac{y}{A - B} \left(A - B \frac{a}{\sqrt{a^2 - E^2}} \right) \end{aligned} \quad (6.18)$$

It likewise affords in the same manner:

$$\frac{d\bar{u}}{du} = \frac{1}{A - B} \left[A - B \frac{u}{\sqrt{u^2 - E^2}} \right] \quad (6.19)$$

Herewith the conformal factor for the lift distribution reads

$$\underline{R} \left(\frac{d\bar{u}}{du} \right) = \frac{1}{A - B} \left[A - B \frac{\frac{a}{\sqrt{a^2 - E^2}}}{1 + \frac{E^2 y^2}{(a^2 - E^2)^2}} \right] \quad (6.20)$$

Fuselage sections diverging markedly from the elliptical form require a special conformal function.

Having established the correlation between y, \bar{y} and $\underline{R} \left(\frac{d\bar{u}}{du} \right)$, $\alpha_F(\bar{y})$ and $t(\bar{y})$ are readily obtained. Following this we again form

$$\frac{ct(\bar{y})}{b} \underline{R} \left(\frac{d\bar{u}}{du} \right)$$

and

$$\frac{\alpha_F(\bar{y}) - \alpha_R}{\underline{R} \left(\frac{d\bar{u}}{du} \right)}$$

as function of \bar{y} . For the ensuing calculation $\bar{\eta} = \frac{\bar{y}}{b/2}$

is introduced. Then the solution of the base distributions \bar{V}_0 and \bar{V}_R in equation (4.24) by means of the method proposed by the writer (reference 8) yields the equation systems:

$$\left[b_{\nu\nu} + \frac{\bar{b}}{c_{\nu} t_{\nu} R \left(\frac{d\bar{u}}{du} \right)} \right] \bar{\gamma}_{0\nu} = \frac{\alpha_{F\nu} - \alpha_R}{R \left(\frac{d\bar{u}}{du} \right)} + \sum_1^{\frac{n+1}{2}} B_{\nu n} \bar{\gamma}_{0n} \quad (6.21)$$

$$\left[b_{\nu\nu} + \frac{\bar{b}}{c_{\nu} t_{\nu} R \left(\frac{d\bar{u}}{du} \right)} \right] \bar{\gamma}_{R\nu} = 1 + \sum_1^{\frac{n+1}{2}} B_{\nu n} \bar{\gamma}_{Rn} \quad (6.22)$$

The $b_{\nu\nu}$ and $B_{\nu n}$, as well as η_{ν} and η_n can be read from the report (reference 8).

Applying the thus computed circulation values to the real wing, we first form

$$\gamma = \bar{\gamma} \frac{\bar{b}}{b} \quad (6.23)$$

Then γ decreases normally in the fuselage region; on a fuselage of elliptical section the distribution along the fuselage width then also has the form of a semiellipse, the value at fuselage center being, as easily found from equation (5.5):

$$\gamma_M = \gamma_{\frac{m+1}{2}} - \frac{h_R + b_R}{b/2} \bar{\alpha}_{i \frac{m+1}{2}} \quad (6.24)$$

with

$$\bar{\alpha}_{i0 \frac{m+1}{2}} = \frac{1}{R \left(\frac{d\bar{u}}{du} \right)} \left[\alpha_{F \frac{m+1}{2}} - \alpha_R - \frac{b \gamma_{0 \frac{m+1}{2}}}{c t_{\frac{m+1}{2}}} \right]$$

$$\bar{\alpha}_{iR \frac{m+1}{2}} = 1 - \frac{1}{R \left(\frac{d\bar{u}}{du} \right)} \frac{b \gamma_{R \frac{m+1}{2}}}{c t_{\frac{m+1}{2}}} \quad (6.25)$$

where h_R is the height and b_R the width of the fuselage.

A few model examples of solved lift distributions along wing and fuselage are shown in figures 14 and 15. No data are available for a comparison with measurements, and no measurements in which the lift distribution under influence of the fuselage has actually been determined. Even so, a certain confirmation of the solutions is afforded by a comparison of the experimental and the theoretical total c_a values, which, however makes it necessary to include the case of the wing alone in the calculation also. Plotting c_a against α_R gives a graph as shown in figure 16. At $\alpha_R = 0$ the c_a value of the combination is slightly below that for wing alone, while the slope $\frac{dc_a}{d\alpha}$ for medium high positions of the wing relative to the fuselage becomes greater. Hence at equal α the c_a values for the combination are smaller throughout near $c_a = 0$ than those for "wing alone." But according to the conventional method of computing the load distribution the difference obtained by constant α had been directly ascribed to the fuselage as negative fuselage lift. It so afforded lift distributions for the case C and for pull-out at high dynamic pressure (case B) the sole advantage of which consisted in obtaining very high bending moments in the wing structure and hence had the effect of a further safety margin to the load assumptions of the wing. But owing to the entirely different character of the correct lift distribution it does not always imply that this method leaves one on the safe side at all points as regards the local strength.

In a comparison of the calculations with the measurements the accuracy and reliability of both must, of course, be weighed more carefully. The greatest obstacle in the measurements is that the angle of attack in the wind tunnel cannot always be obtained with the care really necessary in this particular case. The weighing process itself must be very accurate because of the comparatively small differences involved. In small tunnels there is the added drawback that the usual airfoils manifest a somewhat unusual behavior at the Reynolds numbers of the tunnel, which is associated with the transition of the boundary layer flow from laminar to turbulent; and as these matters are also somewhat affected by the fuselage it widens the zone of scattering of the measurements.

As regards the theory itself one fundamental error hid in the assumption

$$w_1 = \frac{1}{2} w \quad x \rightarrow -\infty$$

can falsify the results of the whole airfoil theory. Actually the effective downwash for the lift is greater than half the downwash far behind the wing, since the angle of attack at $3/4 t$ is decisive for the flow conditions at the wing. This concerns, in particular, the cases of large amounts of induced angle of attack. Effects of this nature are therefore particularly to be expected in fuselage proximity on midwing arrangements, resulting in

lesser change of $\frac{dc_n}{d\alpha}$ due to fuselage than the calculation suggests.

A satisfactory, simple quantitative solution of these facts is as yet impossible; neither are the available measurements numerous enough to permit a prediction of the order of magnitude of the induced changes. For the time being, to the extent of the available and sufficiently reliable measurements, it is expedient to apply a suitable reduction factor to the total air load distribution or, what is probably better, to subtract a little from the lift near the fuselage. But this hits primarily the very wing-fuselage combinations which are preferably not being built because of the $c_{a\max}$ loss.

On the explored Fw types at any rate the accord respecting

$\frac{dc_a}{d\alpha}$ is far better than on the U.S. midwing type with

circular fuselage (fig. 14).

The engine nacelles must be dealt with somewhat differently. Although the flow is similar to that past the fuselage its effect on the wing is usually very small, since the nacelle width itself decreases considerably in the region of the wing and, as stated before, the flow conditions at the wing are governed by the $3/4 t$ region. In the case of low-placed nacelles a downwash independent of the angle of attack is anticipated near the nacelle from the longitudinal displacement flow at the wing, which results in a lift reduction at the wing. The accompanying change in lift distribution can be accurately defined to some extent by applying a modified angle of attack in the

nacelle zone and by so assuming this modification that the measured c_a difference is obtained. Since the effect of the nacelle on the lift distribution and the subsequent bending moments and transverse forces in the wing structure are, in general, small, it is not worth the effort to develop a more accurate method. As regards the air load distribution along the nacelle chord, the same method used on the fuselage can be followed. A minor change in the air load distribution under the effect of the nacelle may occur when the nacelle acts like a plate set on the wing. Then it may result in a small lift increase in the region of the wing between the nacelles and in a corresponding decrease of lift in the outer zone of the wing. Even if these factors are discounted it probably always leaves one on the safe side as regards the wing stresses.

EFFECT OF FUSELAGE ON ROLLING MOMENT DUE TO YAW

Up to now we dealt largely with symmetrical flow conditions of the fuselage and utilized these very symmetry characteristics of the flow repeatedly for our calculation. But no less noteworthy are the phenomena accompanying unsymmetrical flows of the fuselage. Their effects on the fuselage alone have been described in the foregoing; but the indirect effects are just as important. To begin with there is the rolling moment of the yawing airplane which as explained elsewhere (reference 9) is decisively associated with the location of wing on the fuselage.

Sideslip is of course, accompanied by a displacement flow proportional to the transverse component of the fuselage flow which, depending upon the location of the wing, produces velocity components normal to the wing, hence a change in angle of attack. As this phenomenon occurs with different signs on the two sides of the wing, an anti-symmetrical lift distribution results which is followed by a rolling moment. Although the angle of attack change seems at first solely restricted to the wing portions adjacent to the fuselage without sufficient lever arm, there is still an appreciable rolling moment in yaw for the total wing as a result of the compensating effect of the mutual interference of the individual wing sections.

To follow this effect mathematically requires first the solution of the angle of attack change under the effect of the transverse flow. As in the case of symmetrical

flow the flow transverse to the fuselage is assumed to be two-dimensional the section through the fuselage at 3/4 wing chord being decisive for the calculation. Then the conformal transformation affords the flow transverse to this fuselage section. So if

$$u = y + iz \quad (7.1)$$

is the complex coordinate for the plane about this fuselage section, then $\bar{u}(u)$ is its reflection on a knife edge, horizontal in this case. Then

$$\left(\frac{d\bar{u}}{du}\right) = \frac{v_y - i v_z}{v \tau} \quad (7.2)$$

is a measure of the flow velocity about the fuselage section. Sufficiently remote from the fuselage, we get

$$v_y = v \tau \quad (7.3)$$

whence the angle of attack change for the individual wing section follows at

$$\Delta\alpha = \frac{v_z}{v} = -\tau \int \left(\frac{d\bar{u}}{du}\right) \quad (7.4)$$

Thus $-\int \left(\frac{d\bar{u}}{du}\right)$ can be summarily regarded as a fictitious dihedral angle of the wing, supplementary to the geometrical dihedral angle.

Then a complete lift distribution could be achieved for the rolling moment. But it would also have to include two additional factors: first, the usual assumption

$$\alpha_i = \frac{1}{2} \alpha_w \quad x \rightarrow -\infty$$

would no longer be sufficiently valid in fuselage proximity, requiring a greater value, so that the lift values

in the inner region of the wing would be a little lower than by the customary method of computing the lift distribution. On top of that it would also require the disappearance of the velocity component normal to the fuselage for the induced flow, entailing a rise in the lift coefficients in fuselage vicinity. Fortunately the two phenomena are counteracting, whence it seems promising to ignore both for the time being. Then the rolling moment due to yaw of an elliptical wing is:

$$\frac{d c_L}{d \tau} = \frac{1}{\frac{\pi}{c'_{a\infty}} + \frac{2}{\Lambda}} \int_{-1}^1 \underline{J} \left(\frac{d\bar{u}}{du} \right) \eta \sqrt{1 - \eta^2} d\eta \quad (7.5)$$

and for any other wing

$$\frac{d c_L}{d \tau} = \int_{-1}^1 \underline{J} \left(\frac{d\bar{u}}{du} \right) \eta f(\eta) d\eta \quad (7.6)$$

the integration factor $f(\eta)$ being as yet dependent upon the contour of the wing. The factor f can be obtained by differentiation so far as aileron calculations on different aileron widths are available for the particular contour. But usually the modern airfoil forms approach an ellipse so closely that a more accurate solution seems superfluous.

Integration conformable to (7.5) is easier if carried out within the range

$$-\frac{2}{\pi} < \eta < \frac{2}{\pi}$$

instead of over the total wing span, while omitting the factor $\sqrt{1 - \eta^2}$ in the integration. The remaining error is very small, since $\underline{J} \left(\frac{d\bar{u}}{du} \right)$ decreases outwardly with the third power of y .

Hence by putting

$$\frac{d c_L}{d \tau} = \frac{1}{\frac{\pi}{c'_{2\infty}} + \frac{2}{\Lambda}} \int_{-b/\Lambda}^{b/\Lambda} \underline{J} \left(\frac{d\bar{u}}{du} \right) \eta d\eta \quad (7.7)$$

the integral

$$-\int \underline{J} \left(\frac{d\bar{u}}{du} \right) y dy$$

after evaluation of the complex integral

$$\int \frac{d\bar{u}}{du} u du$$

gives

$$-\int \underline{J} \left(\frac{d\bar{u}}{du} \right) y dy = \underline{J} \left(\int \bar{u} du \right) - y \underline{J}(u) \quad (7.8)$$

Then the elliptic fuselage section with the semiaxes A and B affords

$$\bar{u} = \frac{1}{A-B} [Au - B\sqrt{u^2 - (A^2 - B^2)}]$$

$$\int \bar{u} du = \frac{1}{A-B} \left\{ A \frac{u^2}{2} - \frac{B}{2} [u\sqrt{u^2 - (A^2 - B^2)} - (A^2 - B^2) \ln(u + \sqrt{u^2 - (A^2 - B^2)})] \right\} \quad (7.9)$$

With z_F as the location of the wing on the fuselage, the rolling moment in yaw finally reads

$$\frac{d c_L}{d \tau} = \frac{1}{\frac{\pi}{c'_{a\infty}} + \frac{2}{\Lambda}} \frac{h_R(h_R + b_R)}{b^2} \left[\frac{2z_F}{h_R} \sqrt{1 - \left(\frac{2z_F}{h_R}\right)^2} + (\sin^{-1}) \frac{2z_F}{h_R} - \frac{2\pi z_F}{b} \right]$$

for $-\frac{h_R}{2} < z_F < \frac{h_R}{2}$

or

$$\begin{aligned} \frac{d c_L}{d \tau} &= \frac{1}{\frac{\pi}{c'_{a\infty}} + \frac{2}{\Lambda}} \frac{h_R(h_R + b_R)}{b^2} \left[\frac{\pi}{2} - \frac{2\pi z_F}{b} \right] & z_F > \frac{h_R}{2} \\ &= \frac{1}{\frac{\pi}{c'_{a\infty}} + \frac{2}{\Lambda}} \frac{h_R(h_R + b_R)}{b^2} \left[-\frac{\pi}{2} - \frac{2\pi z_F}{b} \right] & z_F < -\frac{h_R}{2} \end{aligned}$$

. . . (7.10)

For a comparison of these data with measurement the amount of available material is, at the time, very scarce. The only appraisable data are those from the NACA Technical Note No. 730 which describes the rolling moments in yaw for a wing-fuselage combination at different height positions relative to the fuselage. For the dimensions of the model used by the NACA

$$-\frac{d c_L}{d \tau} = 0.032_4$$

is the difference between the rolling moments in yaw of high-wing and midwing and

$$-\frac{d c_L}{d \tau} = -0.035_2$$

between low-wing and midwing arrangement (fig. 17). Within $-4^\circ < \alpha < 4^\circ$, that is, in the zone where the flow in the region of the wing root fillets is certainly still completely

adherent, the mean value from the measurements gives the exact result of our calculations. Mr. Schlichting reported similar results. He found that the rolling moments in yaw show a definite course when the wing root is faired so as to prevent separation of flow at any point.

EFFECT OF FUSELAGE ON TAIL

Up to now the fuselage-tail interference effect has been very little explained. Theoretically the phenomena on the horizontal tail surface should be similar to those on the wing, that is, an increase in effective angle of attack due to fuselage flow and hence a change in $\frac{dc_n}{d\alpha}$ at the usual wing positions. This effect is naturally not discernible when, as so frequently is the case, the prediction of the tail efficiency is based upon wind-tunnel measurements at different tail settings relative to the fuselage. This phenomenon represents a further obstacle in the experimental solution of the flow conditions at the horizontal tail surface. Furthermore, a change in the downwash α_w or in the quantity

$$1 - \frac{d\alpha_w}{d\alpha}$$

defining the stability contribution of the horizontal tail surface is to be expected because of the changed air load distribution at the wing under the effect of the fuselage and which generally results in a reduction of this factor. However, since only the difference of the product

$$\frac{dc_n}{d\alpha} \left(1 - \frac{d\alpha_w}{d\alpha} \right)$$

relative to the $\frac{dc_n}{d\alpha}$ of the tail alone is defined in the wind tunnel, the modified downwash by fuselage will not be noticed at all, since two fuselage effects work against each other and practically cancel each other.

Seemingly, of much greater importance is the effect of the boundary layer of the fuselage, which is more pronounced in tail vicinity than at the wing, especially since a considerable strip of the tail is blanketed, as a result of the contraction of the fuselage. Naturally there is a considerable inroad into the air load distribution in this strip blanketed by the fuselage, which fact prompted Hoerner (reference 10) to treat the fuselage region as a cut-out section in the tail and which affords

quite rational $\frac{dc_n}{d\alpha}$ values in many cases.

The fuselage is of great influence on the $\frac{dc_n}{d\alpha}$ value for central tail arrangements. If the tail is divided the fuselage is usually ignored. By central arrangement the fact that a completely unsymmetrical system is involved, must be borne in mind. The fuselage and in many cases also the horizontal tail surface act like a one-sided end plate. It was found to be the best rule in an analysis of the effectiveness of lateral control surfaces to figure with the aspect ratio of the tail area doubled by a reflection on the upper fuselage surface.

But of special significance for the mechanics of asymmetrical flight motions is the fact that the wing produces not only a downwash on the horizontal tail surface but a similar sidewash also on the lateral control surfaces. The order of magnitude of this sidewash is governed by the wing-fuselage interference. Consider a wing with-out fuselage having a certain dihedral angle δ . In sideslip a lift distribution is then formed in such a way that the circulation increases on the advancing wing portion and decreases on the trailing portion. This signifies a

fairly large $\frac{d\Gamma}{dy}$ at wing center. And, knowing that $\frac{d\Gamma}{dy}$ is equal to the difference of induced spanwise velocities of upper and lower surface, the result is a fairly great sidewash in the center above the wing against the sidewash from the sideslip.

Denoting the angle formed by this induced sidewash and the plane of symmetry of the airplane with σ a rough estimation of the order of magnitude of this sidewash on a wing with dihedral δ at wing center above the wing is

$$\sigma \approx \tau \delta$$

As a result of the sideslip both sides of the wing manifest a change in angle of attack to the amount of $\tau \delta$, which is almost completely equalized by the induced flow. So for a cursory appraisal it can be assumed that the wing in the inside zone acts like a guide apparatus imparting a twist of this amount to the flow. A fictitious dihedral angle is created in the wing center section under the fuselage effect as explained elsewhere, which is predominantly dependent upon the location of the wing relative to the fuselage. Since the absolute amount of this fictitious dihedral is far greater for high- and low-wing arrangements than that customary on geometrical dihedral a very considerable influence of the fuselage on the sidewash is to be expected. On the high-wing arrangement the sidewash should, conformably to the great positive fictitious dihedral angle, reduce the contribution of the lateral control system toward directional stability considerably and increase it correspondingly on the low-wing arrangement. Suitable reference data for assessing the order of magnitude are as yet lacking. It might be possible to compare the sidewash with the fictitious dihedral at a distance from the wing center which can be correlated with the lateral tail surface dimensions. Much more promising at the moment appear systematic measurements in which first of all, the wing position relative to the fuselage, the ratio of tail height to fuselage height and the setting of the wing relative to the fuselage must be modified. Less significant are the effects of the wing form, of the ratio of wing chord to fuselage width and height, tail design and so forth.

A few first measurements are available in the aforementioned NACA Technical Note No. 730, which are reproduced in figure 18. Only the contribution of the lateral tail surface to the directional stability is indicated. It discloses the telling effect of the position of the wing relative to the fuselage, the conduct of the high-wing arrangement being fairly critical, while on the low-wing arrangement probably some separation phenomena at the wing root obliterate the picture a little. Figure 17 revealed something similar. For the high-wing arrangement the ef-

fect of the sidewash is approximately $\frac{d\sigma}{d\tau} = -0.4$, for the low-wing arrangement about $\frac{d\sigma}{d\tau} = -0.3$, so long as the flow in fuselage proximity appears adherent. For the effect of the dihedral there is an increment to $\frac{d\sigma}{d\tau}$ of the order of

magnitude of 0.09 which is equivalent to about 5° dihedral angle according to our estimates. The high-wing arrangement with dihedral falls somewhat outside the framework at negative angles of attack, probably due again to local flow separation. On the whole, all values show a slight increase with angle of attack, which is probably associated with the effect of sideslip on the downwash distribution along the wing span. The stability contribution of the lateral control surfaces of the same model without wing

amounted to $\frac{dc_N}{d\tau} = 0.09$, the same value as on the midwing

arrangement without dihedral near $\alpha = 0$, as is to be expected.

As concerns the mechanics of asymmetric flight motions the following should be noted in this respect: While the directional stability contribution of the lateral control surfaces is to be provided with the factor

$$1 - \frac{d\sigma}{d\tau}$$

the damping during yaw to the extent that it consists of a change in angle of yaw τ , must obtain the factor

$$1 + \frac{d\sigma}{d\tau}$$

because the sidewash from the wing arrives, exactly as the downwash at the horizontal tail surface, with a certain temporal displacement on the tail. This concurrent change in directional stability and damping in yaw should not be neglected especially for the appraisal of the yaw vibrations of the aircraft. In the static lateral stability, that is, the stability against spiral diving motions the effect on the directional stability is involved but not the effect of the sidewash on the damping in yaw, because this yawing motion is associated with a change in flight course of the aircraft. For the further lateral stability studies the standard conception of damping in yaw is therefore altogether unsustainable; two concepts in accord with the two different types of yawing motions must be introduced. Something similar obtains in the previous discussion of the rolling moments in yaw where two different values result, depending upon whether the flight path during yaw remains straight or curves (reference 9).

These problems should be considered in appropriate manner during the design of the lateral control surface. In a decision for or against a divided or a central tail, particularly, the sidewash conditions under the effect of the fuselage and of the wing should receive particular attention.

Translation by J. Vanier,
National Advisory Committee
for Aeronautics.

REFERENCES

1. Munk, Max M.: The Aerodynamic Forces on Airship Hulls. Rep. No. 184, NACA, 1924.
2. Abbott, Ira H.: Airship Model Tests in the Variable Density Wind Tunnel. Rep. No. 394, NACA, 1931.
3. Jacobs, Eastman M., and Ward, Kenneth E.: Interference of Wing and Fuselage from Tests of 209 Combinations in the N.A.C.A. Variable-Density Tunnel. Rep. No. 540, NACA, 1935.
4. Lonnortz, J.: Beitrag zur theoretischen Behandlung des gegenseitigen Einflusses von Tragfläche und Rumpf. Z.f.a.M.M., Bd. 7, Aug. 1927, pp. 249-276.
5. Vandroy, F.: Zur theoretischen Behandlung des gegenseitigen Einflusses von Tragflügel und Rumpf. Luftfahrtforschung, Bd. 14, July 20, 1937, pp. 347-355.
6. Nuttray, H.: The Aerodynamic Aspect of Wing-Fuselage Fillets. T.M. No. 764, NACA, 1935.
7. Trefftz, E.: Prandlische Tragflächen- und Propeller-Theorie. Z.f.a.M.M., Bd. 1, June 1921, pp. 206-218.
8. Multhopp, H.: Die Berechnung der Auftriebsverteilung von Tragflügeln. Luftfahrtforschung, Bd. 15, April 6, 1938, pp. 153-169.

9. Multhopp, H.: Die Anwendung der Tragflügeltheorie auf Fragen der Flugmechanik. In Vorbereitung.
10. Hoerner, S.: Einfluss von Rumpf und Luftschraube auf die Stabilität. Jahrbuch 1939 der Deutschen Luftfahrtforschung, p. 231.
11. Bamber, M. J., and House, R. O.: Wind-Tunnel Investigation of Effect of Yaw on Lateral-Stability Characteristics. Rectangular-NACA 23012-Wing with a Circular Fuselage and a Fin. T.N. No. 730, NACA, 1939.

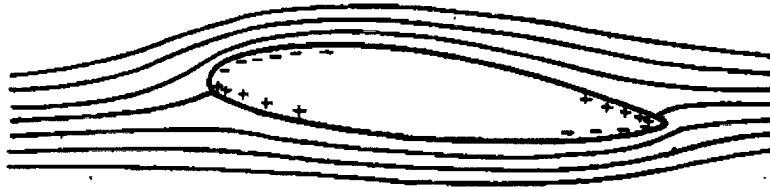

Figure 1.- Fuselage in ideal flow.
 + Positive pressure - Negative pressure

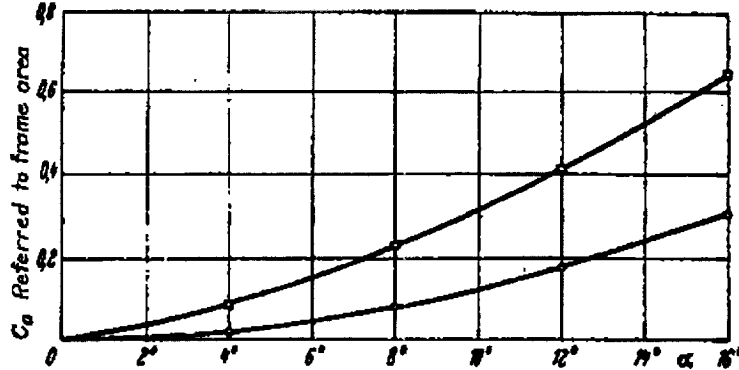

Figure 3.- Lift of the fuselage alone.
 o Normal } NACA-Report 540
 □ Rectangular }

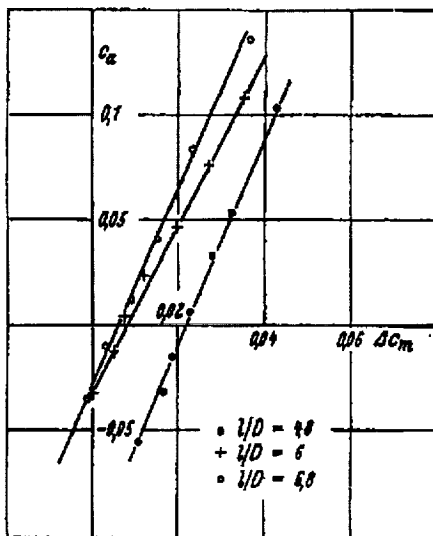

Figure 4.- Moment curves of frictional lift.
 Fuselage forms: NACA-Report 394

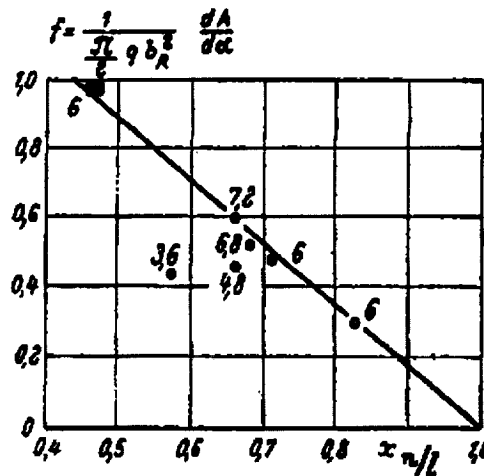

Figure 5 - Neutral stability point of frictional lift. Inscripted numbers indicate slenderness ratio.

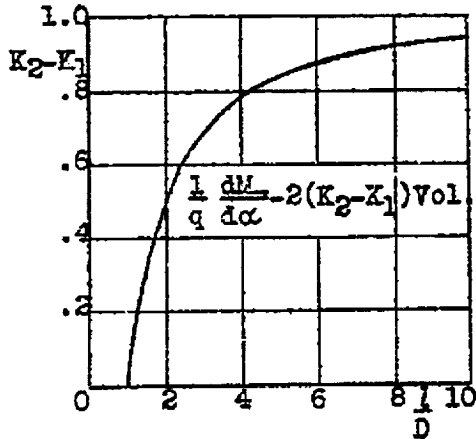

Figure 2.- Munk's correction factors for the unstable moments of surfaces of revolution.

(NACA Report 184)

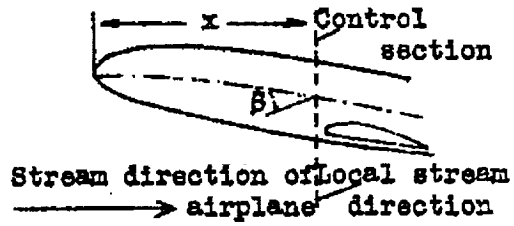

Figure 6.- Moment consideration for defining free fuselage moments.

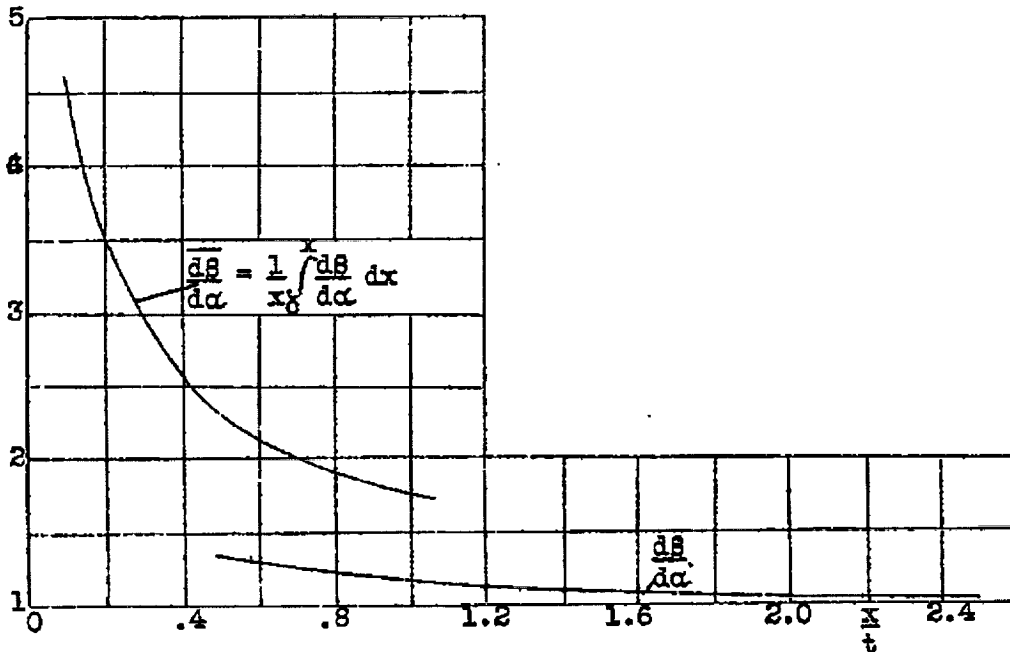

Figure 8.- Normal values for uprush before the wing. To the extent that the fuselage width is constant we put:

$$\int_0^x b_R^2 \frac{ds}{d\alpha} dx = x \cdot b_R^2 \cdot \frac{db}{d\alpha}.$$

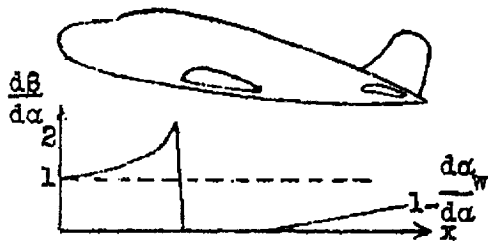

Figure 7.- Curve of $\frac{d\delta}{d\alpha}$ along fuselage.

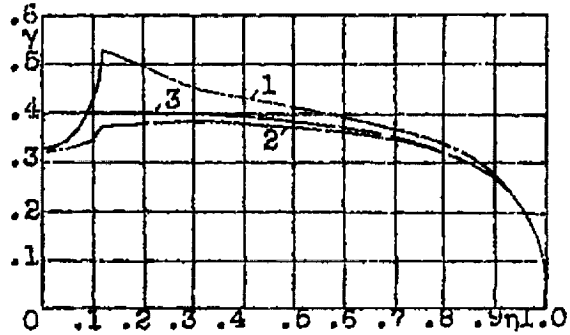

Figure 14.- Lift distribution of a mid-wing arrangement with circular fuselage and rectangular wing, $\Lambda = 6$. Dimensions correspond to the conditions in NACA Report 540.

1 Wing and fuselage (YR); $\alpha_R = 1$

$$\frac{\Delta c'_{L,R}}{c'_{L,R}} = 0.073 \text{ (averaged } 0.054)$$

2 Wing set at an angle, fuselage in flow direction $\alpha_T - \alpha_R = 1$

$$\frac{\Delta c_a}{c_{a,T}} = -0.050 \text{ (averaged } -0.049)$$

3 Wing alone $\alpha = 1$

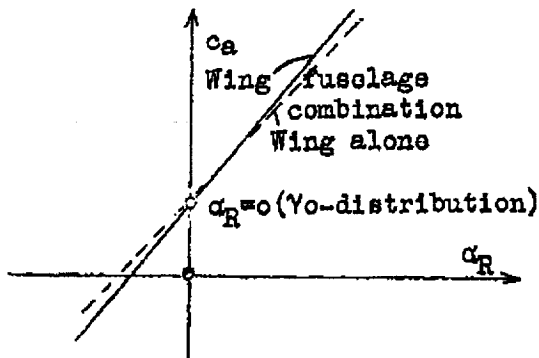

Figure 16.- Relation of lift to angle of attack.

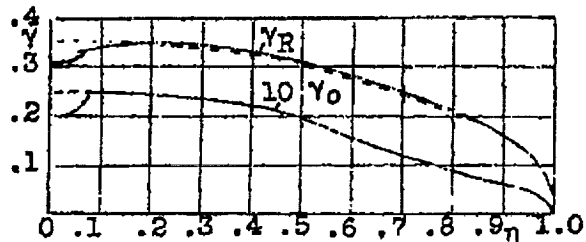

Figure 15.- Lift distribution of low-wing arrangement.

--- Wing alone
 $c'_{a,T} = 4.53$ $c'_{a,T+R} = 4.52$ $c_{a,T}(\alpha_R = 0) = .233$

$c_{a,T+R}(\alpha_R = 0) = .233$

Measured c_a values correspond to calculation differences within scope of instrumental accuracy.

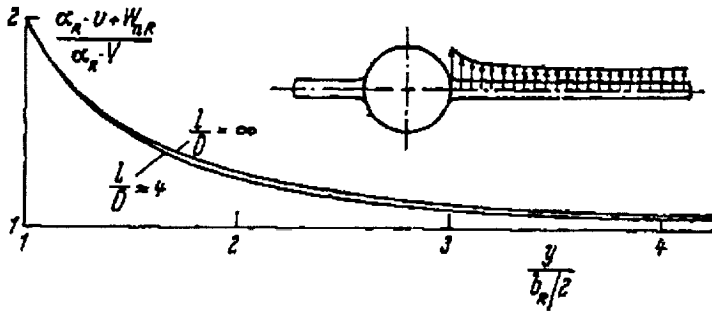

Figure 9.- Transverse flow about axially symmetrical fuselage ($l/D = 4$) and about circular cylinder ($l/D = \infty$).

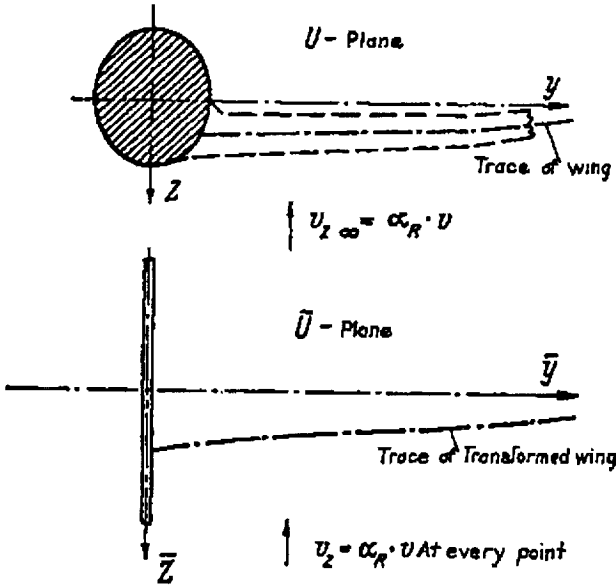

Figure 10.- Conformal transformation of fuselage cross section onto a vertical slit.

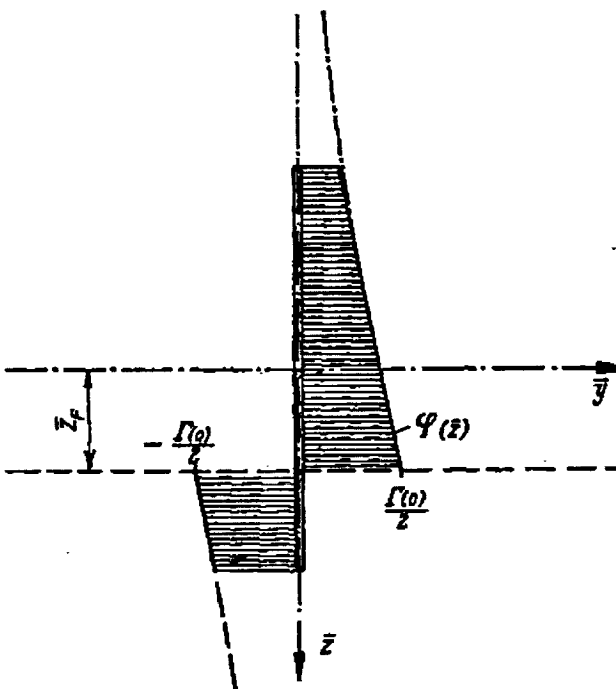

Figure 11.- Potential ϕ on the section of the conformally transformed fuselage.

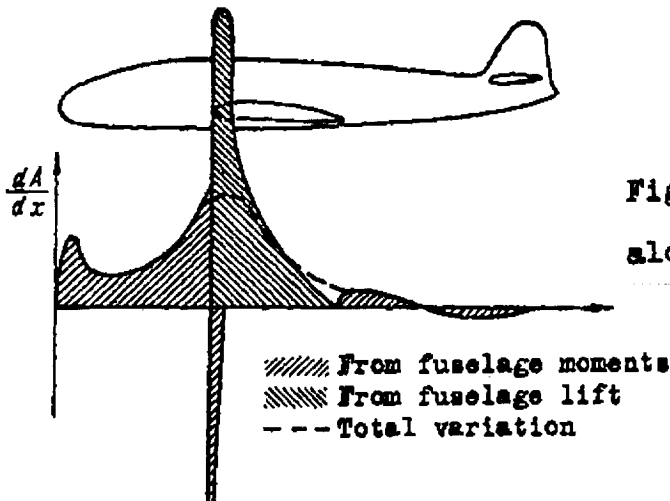

Figure 12.- Air load distribution along fuselage.

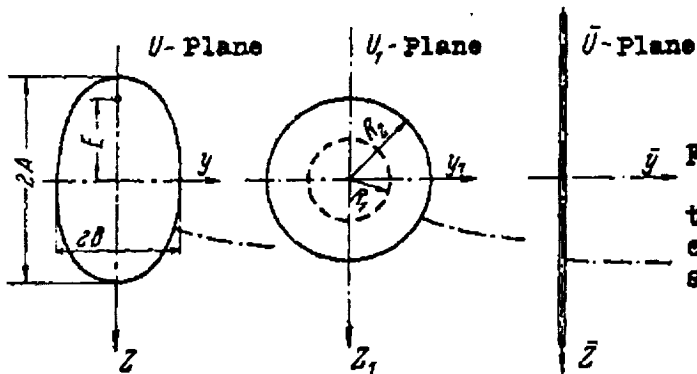

Figure 13.- Method of conformal transformation on elliptic fuselage sections.

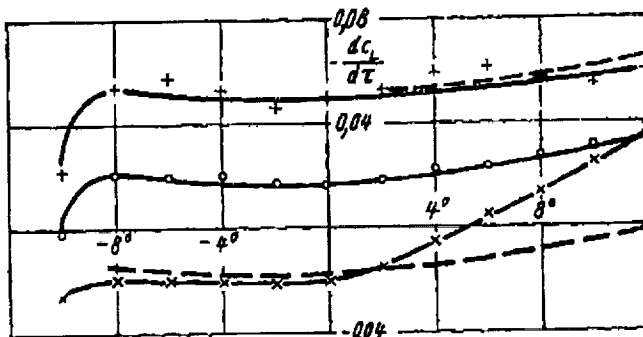

Figure 17.- Rolling moment in yaw under fuselage effect. (Tests from NACA-T.N. 730)
 + High wing arrangement
 o Mid wing arrangement
 x Low wing arrangement
 --- Theoretical values for high- and low-wing arrangement.

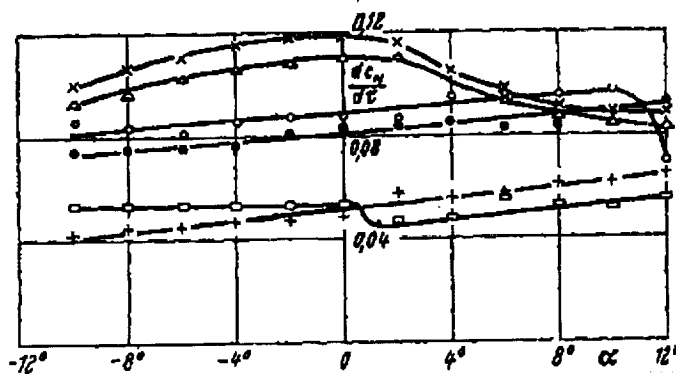

Figure 18.- Contribution of fin and rudder toward directional stability by fuselage effect.

(NACA-T.N. 730)
 Wing dihedral

- 0° { + High wing arrangement
- o Mid wing arrangement
- x Low wing arrangement
- 5° { □ High wing arrangement
- e Mid wing arrangement
- Δ Low wing arrangement