

NASA/TM-2000-209844

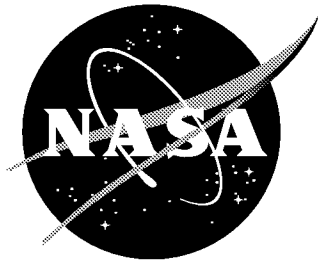

# The Influence of Modulated Signal Risetime in Flight Electronics Radiated Immunity Testing with a Mode-Stirred Chamber

*Jay J. Ely, Truong X. Nguyen, Stephen A. Scearce  
Langley Research Center, Hampton, Virginia*

---

January 2000

## The NASA STI Program Office ... in Profile

Since its founding, NASA has been dedicated to the advancement of aeronautics and space science. The NASA Scientific and Technical Information (STI) Program Office plays a key part in helping NASA maintain this important role.

The NASA STI Program Office is operated by Langley Research Center, the lead center for NASA's scientific and technical information. The NASA STI Program Office provides access to the NASA STI Database, the largest collection of aeronautical and space science STI in the world. The Program Office is also NASA's institutional mechanism for disseminating the results of its research and development activities. These results are published by NASA in the NASA STI Report Series, which includes the following report types:

- **TECHNICAL PUBLICATION.** Reports of completed research or a major significant phase of research that present the results of NASA programs and include extensive data or theoretical analysis. Includes compilations of significant scientific and technical data and information deemed to be of continuing reference value. NASA counterpart of peer-reviewed formal professional papers, but having less stringent limitations on manuscript length and extent of graphic presentations.
- **TECHNICAL MEMORANDUM.** Scientific and technical findings that are preliminary or of specialized interest, e.g., quick release reports, working papers, and bibliographies that contain minimal annotation. Does not contain extensive analysis.
- **CONTRACTOR REPORT.** Scientific and technical findings by NASA-sponsored contractors and grantees.
- **CONFERENCE PUBLICATION.** Collected papers from scientific and

technical conferences, symposia, seminars, or other meetings sponsored or co-sponsored by NASA.

- **SPECIAL PUBLICATION.** Scientific, technical, or historical information from NASA programs, projects, and missions, often concerned with subjects having substantial public interest.
- **TECHNICAL TRANSLATION.** English-language translations of foreign scientific and technical material pertinent to NASA's mission.

Specialized services that complement the STI Program Office's diverse offerings include creating custom thesauri, building customized databases, organizing and publishing research results ... even providing videos.

For more information about the NASA STI Program Office, see the following:

- Access the NASA STI Program Home Page at <http://www.sti.nasa.gov>
- E-mail your question via the Internet to [help@sti.nasa.gov](mailto:help@sti.nasa.gov)
- Fax your question to the NASA STI Help Desk at (301) 621-0134
- Phone the NASA STI Help Desk at (301) 621-0390
- Write to:  
NASA STI Help Desk  
NASA Center for AeroSpace Information  
7121 Standard Drive  
Hanover, MD 21076-1320

NASA/TM-2000-209844

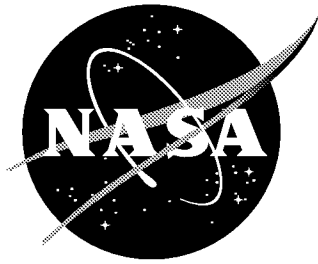

# The Influence of Modulated Signal Risetime in Flight Electronics Radiated Immunity Testing with a Mode-Stirred Chamber

*Jay J. Ely, Truong X. Nguyen, Stephen A. Scearce  
Langley Research Center, Hampton, Virginia*

National Aeronautics and  
Space Administration

Langley Research Center  
Hampton, Virginia 23681-2199

---

January 2000

## Acknowledgments

Special thanks is extended to Langley's HIRF laboratory personnel:

- Sandra Koppen: Instrumentation programming and control.
- Max Williams: Equipment setup and hardware configuration.
- Reuben Williams: HIRF laboratory manager

---

Available from:

NASA Center for AeroSpace Information (CASI)  
7121 Standard Drive  
Hanover, MD 21076-1320  
(301) 621-0390

National Technical Information Service (NTIS)  
5285 Port Royal Road  
Springfield, VA 22161-2171  
(703) 605-6000

## Abstract

*For electromagnetic immunity testing of an electronic system, it is desirable to demonstrate its functional integrity when exposed to the full range and intensity of environmental electromagnetic threats that may be encountered over its operational life. As part of this, it is necessary to show proper system operation when exposed to representative threat signal modulations. Modulated signal transition time is easily overlooked, but can be highly significant to system susceptibility.*

*Radiated electromagnetic field immunity testing is increasingly being performed in Mode Stirred Chambers. Because the peak field vs. time relationship is affected by the operation of a reverberating room, it is important to understand how the room may influence any input signal modulation characteristics.*

*This paper will provide insight into the field intensity vs. time relationship within the test environment of a mode stirred chamber. An understanding of this relationship is important to EMC engineers in determining what input signal modulation characteristics will be transferred to the equipment under test. References will be given for the development of this topic, and experimental data will be presented.*

## Introduction and Background

In an effort to provide safer, more reliable, and more affordable air travel, today's aircraft are continually being upgraded with state-of-the-art electronic systems. These systems provide improved aircraft stability, pilot awareness, reliability, fuel economy, and the ability to avoid unfavorable weather conditions.

### Avionics Certification

The certification process for new avionics is extensive, and includes subjecting representative components to all foreseeable environmental conditions, including electromagnetic threats. The effects of electromagnetic emissions from other onboard aircraft systems, communications and RADAR systems external to the aircraft, and even lightning phenomena must all be considered in determining the operational environment. Over the past two decades, much effort has been invested in quantifying these threats. The effort continues today, with

participation from international commercial and military organizations.

Currently, there are several standards containing information about electromagnetic environmental testing of electronic systems. The most widely recognized are:

- RTCA DO-160D [1] Airborne Equipment
- EUROCAE ED-14 [2]
- MIL-STD-461 [3] Critical Electronic
- MIL-STD-462 [4] Equipment
- IEC 61000 [5] Industrial and Consumer Products
- SAE J-1113 [6] Automobiles

While the first two are of primary importance in flight electronics certification, the others reflect growing international expertise and

commitment to product electromagnetic compatibility. They represent the most current and extensively recognized standards by which electronic systems may be declared “immune” to electromagnetic threats expected over their usable life.

### Modulation Transition Time: Is It Significant?

In general, four modulated signal characteristics are addressed when performing electromagnetic immunity testing. They are:

- Peak Amplitude
- Center Frequency
- Waveshape and Repetition Interval
- Average Power Considerations: Duty Factor and Modulation Index

The existing standards provide detailed explanations of how these characteristics may be accurately and repeatably generated. With this, it is expected that the electromagnetic environmental test conditions applied to the Equipment Under Test (EUT) are well quantified.

While the four characteristics are thorough and reasonable, none addresses the potential of varied susceptibility due to modulated signal transition time (ie. “risetime” or “falltime”). NASA Langley’s HIRF (High Intensity Radiated Fields) Laboratory has found a case where this factor is highly significant. Because radiating sources present in a typical aircraft environment include pulsed RADARs with multiple transition times measured in nanoseconds - much shorter than many typical laboratory setups, this may be an issue of concern.

It is the goal of this paper to call attention to the issue of modulated signal transition time in radiated susceptibility testing. There is very little published information as to whether typical

systems exhibit sensitivity to this factor.

## Modulation Transition Time Effect Upon Frequency Spectrum: Computational Analysis

If a required test signal is pulse or “square” amplitude modulated, the high/low transition time may vary widely before affecting the four modulation characteristics mentioned previously. We will begin with a computational analysis that demonstrates how transition time influences the frequency spectrum.

For our purposes, the modulation characteristic specified in RTCA DO-160D for compliance testing of airborne equipment was selected- a 1kHz “square” wave. Symmetrical trapezoidal time domain functions were used to approximate the variation in frequency spectrum due to modulation transition time. (See fig. 1.)

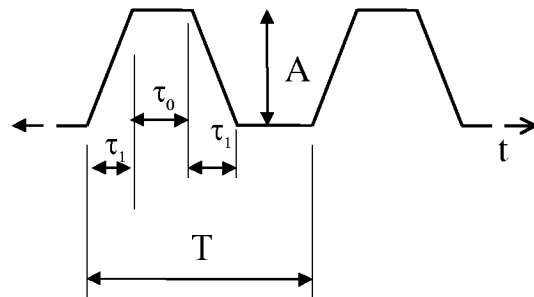

Figure 1: “Trapezoidal” pulse amplitude modulating waveform. (Note: risetime = falltime =  $\tau_1$ )

The symmetrical trapezoidal modulating waveform depicted in figure 1 provides a means of computationally estimating the frequency spectra of practical pulse waveforms, as compared to the ideal. From [7] the Fourier series coefficients were found for varying transition times. We selected 14ns and 630ns values for transition time ( $\tau_1$ ), to coincide with our capability to generate the waveforms experimentally. Also,  $\tau_1=0$  was computed as a baseline (something not possible experimentally).

The Fourier coefficients were then plotted to indicate the relative magnitude envelope of the infinite series of trapezoids in the frequency domain. A computational and visual tool (MATLAB) was used to graphically represent the resulting frequency spectrum (with a frequency resolution and bandwidth not possible with typical instrumentation).

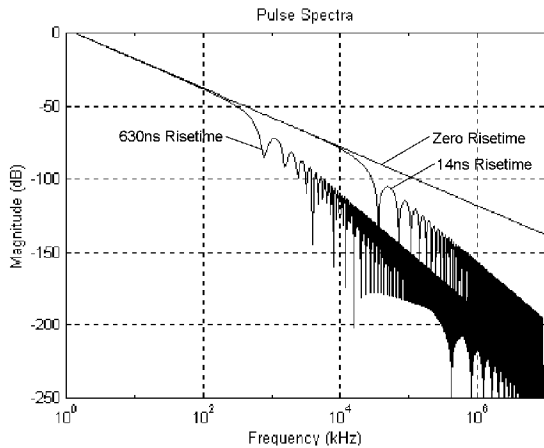

Figure 2: Single-sided frequency transformation comparison of Zero vs. 14ns vs. 630ns risetime trapezoidal pulse. (10 GHz "Span")

Figure 2 shows the computed frequency spectrum for the 3 different values of  $\tau_1$ . From this, it can be seen that the frequency spectrum for a perfect square wave (zero risetime) declines at a rate of 20dB magnitude per frequency decade (dB vs. log10 scale). However, when a finite transition time is applied, a null occurs at  $\frac{1}{2\tau_1}$  in the frequency spectrum. After this, the frequency spectrum declines at a rate of 40dB/decade.

For this type of analysis to be compared to measurements, it is useful to use the trapezoidal waveform to modulate a carrier frequency. We selected 1.87GHz for the carrier, to provide similarity with experimental data to be discussed later.

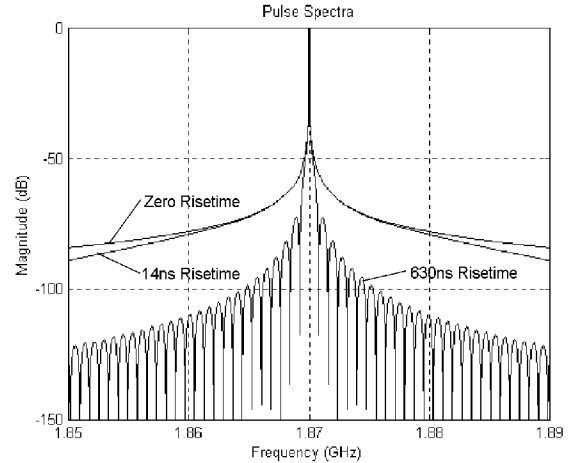

Figure 3: Modulated frequency transformation comparison of Zero vs. 14ns vs. 630ns risetime trapezoidal pulse. (40 MHz "Span")

Figure 3 is very much like what would be seen on a spectrum analyzer if it can display a span of 40MHz with 1kHz resolution bandwidth. It very clearly reveals how spectral content is reduced for longer risetime modulated signals.

Figures 2 and 3 characterize the frequency domain well enough to provide confidence that a smaller frequency span may be used to observe experimental perturbations of the modulation transition time (provided they are longer in duration than 14ns). This is useful in the subsequent analysis of chamber effects based upon spectrum analyzer measurements.

## Test Chamber Effect Upon Signal Characteristics

Once the effects of modulated signal transition time upon frequency spectrum are understood, it is important to identify factors within the test setup that may further modify the electromagnetic environment as seen by the EUT.

The test equipment shown in figure 4 was used to assess chamber effect upon a modulated waveform. A 1kHz “square” wave was used to amplitude modulate the carrier frequency (see figure 1), according to the RTCA DO160D Category “Y” requirement. To best illustrate the effect of the test chambers, we used a HP83620B signal generator with a ~14ns pulse modulated transition time (the fastest available to us). Data collected from the Digital Storage Oscilloscope and Spectrum Analyzer were compared to provide insight into how a “fast” modulated signal is affected by the test chamber. The carrier frequency was selected to be 1.87 GHz, for similarity to the experimental data to be discussed in the next section.

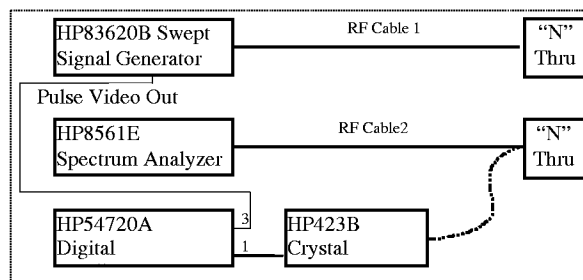
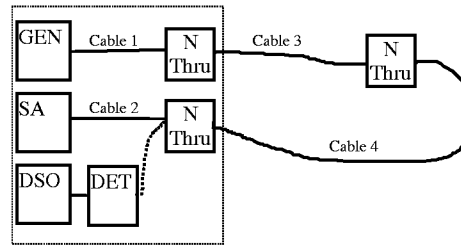
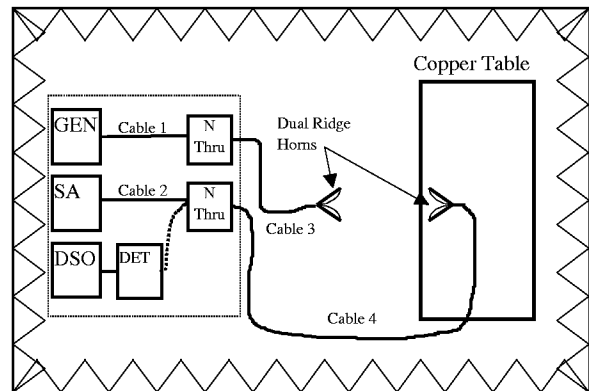

Figure 4: Test equipment configuration for measuring time and frequency domain effects of test chambers. RF Cable 2 was connected to either the spectrum analyzer or crystal detector depending upon whether time or frequency domain measurements were desired. (For our purposes, all RF cables have “N” type male connectors on each end, and may be interconnected with dual female “N Thru” adapters.)



Case A: Through Cabling Only (Control)



Case B: Through Semi-Anechoic Chamber

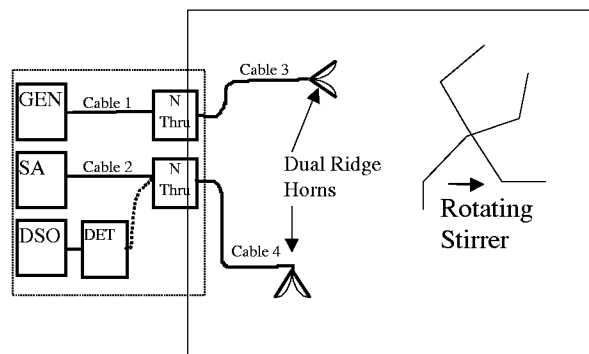

Case C: Through Langley’s Mode-Stirred Chamber “C”

Figure 5: Three Test Cases for comparison of pulse modulated time and frequency response due to test chamber.



## Semi-Anechoic Chamber Data

The goal behind using a semi-anechoic room for EMC testing is to simulate an infinite ground plane in free space. This should be operationally equivalent to a Open Area Test Site (OATS). While neither a semi-anechoic room or an OATS is as ideal as a full-anechoic room, they all meet the necessity of providing an environment where peak field intensity components may be accurately and repeatably characterized under controlled circumstances.

While performing radiated immunity testing in a semi-anechoic room, it is inevitable that reflection and loss will occur from a test article and its surroundings, lending some degree of uncertainty to the measured results. However, it is virtually inconceivable that reflection or re-radiation could be of sufficient magnitude and phase delay so as to significantly alter the time/frequency characteristics of a test signal. This is because of the likelihood that any such emissions would simply be absorbed by the room walls before traveling very far.

This reasoning is validated by the measurements taken in Langley's semi-anechoic chamber (figure 5, Case B). Figure 6 reveals the time response of the chamber (Case B) as compared with a direct cable connection with the oscilloscope (Case A). From the figure, it can be seen that the time response of the two test cases is nearly identical. The only measurable difference is a delay of roughly 5 nanoseconds (attributable to the added path length from the antenna separation). The measured frequency spectrum tells the same story. As can be seen from figure 7, the semi-anechoic chamber has virtually no effect upon the modulated signal spectral content.

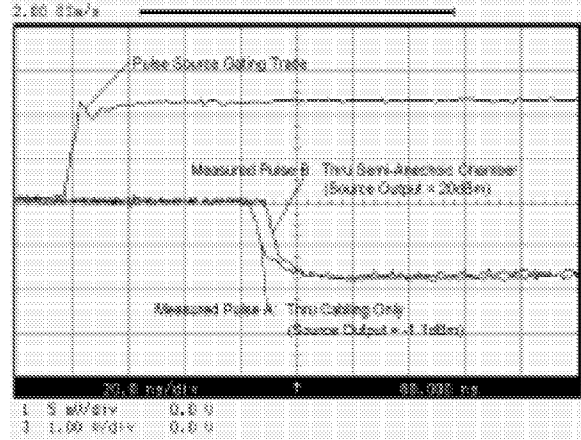

Figure 6: HP54720A Oscilloscope display of cabling-only vs. semi-anechoic chamber detected pulse risetime. (The HP423B detector provides a negative envelope output of the modulated waveform.) To obtain the same detected voltage level in Case 1, the source power needed to be reduced by 21.1dB in Case 2, which is the antenna and free space loss.

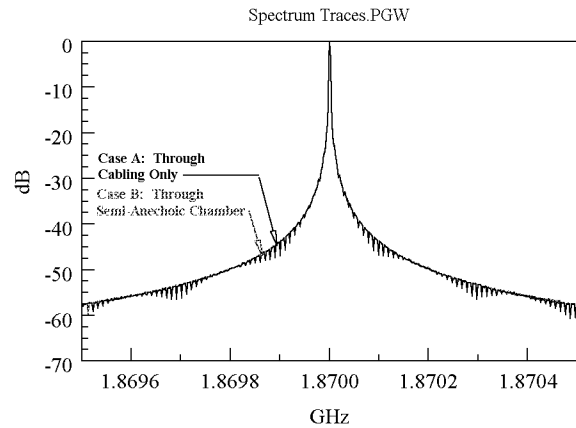

Figure 7: HP8561E measured spectrum, normalized to 0dBm at 1.87GHz for Case A vs. Case B. (Span=1MHz, Resolution Bandwidth=300Hz)

## Mode-Stirred Chamber Data

A Reverberation Chamber may be defined as a volume bounded by electrically conductive material, such that electromagnetic loss is minimized. In a typical reverberation chamber, hundreds (or thousands) of reflections will occur when an electromagnetic wave is introduced. These reflections will reverberate until resonant modes develop, based upon the electromagnetic boundary conditions present within the volume. If a dynamically changing boundary condition is introduced, the modal structure will be “stirred”, and it will thus become a “mode-stirred chamber.”

While mode-stirred chambers have many advantages for practical radiated immunity testing, the primary factor enabling their use is the ability to calculate peak electric field intensity incident upon a test article placed inside, as the chamber modal structure is stirred.

The operational characteristic of reverberation is the key difference between mode-stirred vs. anechoic test chambers. In anechoic (or semi-anechoic) rooms, reverberation is minimized to allow empirical determination of peak field intensity. In mode-stirred chambers, reverberation is maximized to provide statistical estimation of peak field intensity.

It is the operational characteristic of reverberation that directly influences modulated signal transition time. Because of reverberation, the signal observed by a test article may be composed of numerous time-shifted representations of the generated waveform, superimposed upon one another. This will obviously result in observed signal time/frequency characteristics that are dependent upon chamber electromagnetic boundary conditions.

### Chamber Time Constant

Chamber time constant may be defined as [1]:

$$\tau = \frac{Q}{2\pi f} \quad (1)$$

where  $f$ =frequency, and  $Q$  is the “Quality factor”:

$$Q = \frac{16\pi^2 V}{\lambda^3} \cdot \frac{P_{average\_received}}{P_{input}} \quad (2)$$

where  $V$  is the chamber volume (m<sup>3</sup>),  $\lambda$  is the free space wavelength (m) at the specific frequency, and  $(P_{average\_received} / P_{input})$  is the ratio of the average received power over one complete stirrer rotation to the input power.[1] Also see [8]

By definition, the chamber Quality Factor provides an indication of energy storage vs. energy dissipation per periodic cycle, for the whole chamber. The chamber time constant  $\tau$ , gives an indication of the exponential charge/decay characteristic of the whole chamber when given a “step” input stimulus.

Equations (1) and (2) were applied to power measurements collected in the mode-stirred chamber. With them, the time constant was found to be 240 ns at 1.87GHz. Figure 8 uses this to provide a graphical representation of the chamber charging characteristic.

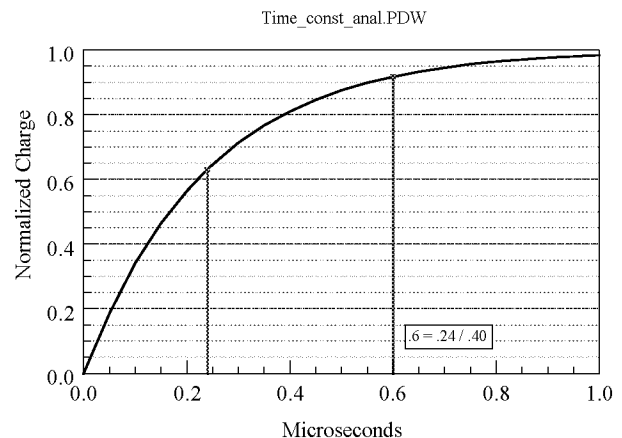

Figure 8: Reverberation chamber charging characteristic, as predicted by DO-160D procedure.

DO-160D and ED14D require that modulated pulse widths exceed  $\tau/0.4$ . This is to ensure that the chamber becomes fully charged during each cycle of the modulating waveform. It can be seen that the chamber should reach 92% of full charge within 600 ns, according to the DO-160D guideline.

***Instantaneous and Stirred Maximum Responses of Mode Stirred Chamber***

As with the semi-anechoic chamber, oscilloscope and spectrum analyzer measurements were taken with the equipment setup pictured in figure 5, Case C. These measurements however, were not as straightforward as with the other two cases.

For the time domain, the “infinite persistence” feature was used on the digital oscilloscope. This allowed hundreds of traces to be captured over a period of minutes, each one representing a different stirrer position. As time progressed, an “envelope” response was collected, depicting limitations imposed by the overall chamber charge characteristic. (See figure 9.) If the 600ns for 92% peak amplitude predicted from the chamber time constant is compared to this envelope, fairly good agreement can be seen.

Figure 9 also shows four “snapshot” waveforms, each representing single oscilloscope time sweeps. Essentially, each snapshot reveals the chamber modified time response for a single boundary condition (ie. stirrer position) of the source generated waveform. While no single waveform exceeds the chamber charging envelope, they reveal that the receive antenna was exposed to field intensity transition rates (dV/dt) faster than the chamber charge rate, although at lower peak amplitude.

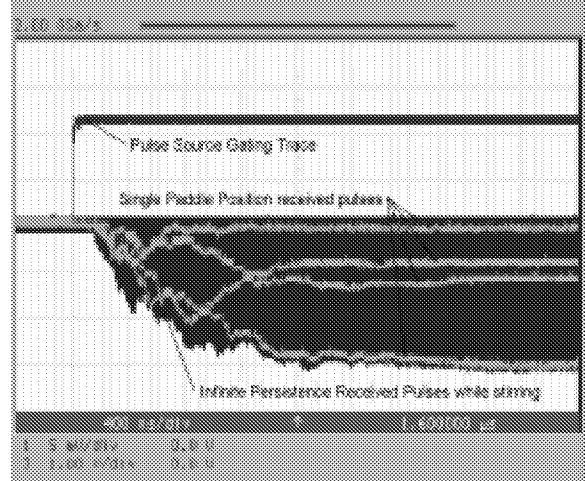

Figure 9: HP54720A Oscilloscope display of Mode-Stirred Chamber risetime data. (Crystal detector outputs negative voltage envelope for received pulses.)

For the frequency domain measurements, the “Max Hold” feature of the spectrum analyzer was used while continuously stirring. Because the sweep time for the desired resolution bandwidth was 28 seconds, the instrument needed to be run for nearly 2 hours to obtain in excess of the 200 desired samples. The results of this measurement are shown in figure 10, where Case C is superimposed upon the Case A and B frequency data.

It is most interesting to note how the signal frequency content in the mode-stirred chamber so closely resembles that of Cases A and B. (This was also verified for frequency spans up to 800MHz.) *If the chamber time constant were to limit the transition time of every pulse incident upon the receive antenna, some attenuation would be expected at the spectral edges. This was not the case.*

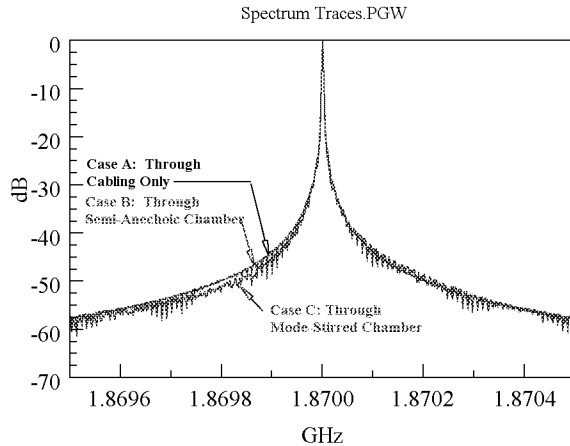

Figure 10: HP8561E measured spectrum, normalized to 0dBm at 1.87GHz for Case A vs. Case B vs. Case C. Case C data collected during continuous stirring, taking maximum of over 200 sweeps.

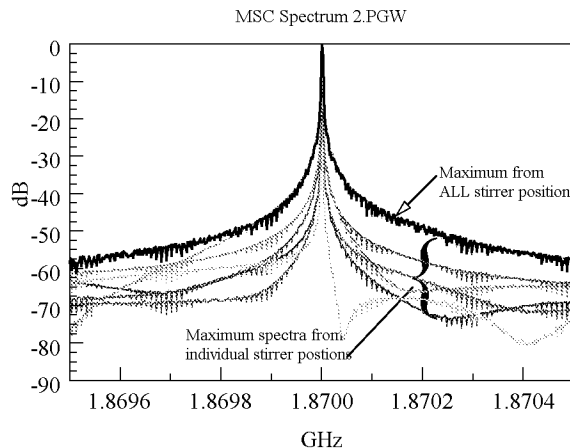

Figure 11: HP8561E measured spectrum. Several traces for individual paddle positions as compared to the continuous stirring maximum. All traces use same normalization factor as continuous stirring maximum. (Span=1MHz, Resolution Bandwidth=300Hz)

To further clarify our understanding, the spectrum analyzer measurements were repeated several times for individual, stationary stirrer positions, but with the same source input power as was used for the stirred case. (See figure 11.) Many similarities can be noted when comparing this information with the time domain data. Most importantly, a maximum “envelope” is created by mode-stirring, composed of

individual responses for every possible boundary condition created by changing stirrer position.

This data indicates that in the mode-stirred chamber, the additional peak frequency content due to modulation transition time may be spread out over a complete stirrer rotation, whereas in a semi-anechoic chamber the full amplitude frequency content is present during every periodic cycle.

## Experimental Data Showing Susceptibility Variation Due to Risetime

The previous analysis and measurement becomes valuable only if modulated signal transition time influences the radiated susceptibility of actual flight equipment. NASA Langley’s HIRF laboratory has discovered such a case.

The subject system is a Fly-by-Light Engine Data Processor system that has been flown on several revenue airplanes as part of a Boeing 757 Fiber Optic In-Service evaluation program. It was selected as a typical “off-the-shelf” system, to provide comparison between the radiated susceptibility threshold data produced by the newly released RTCA DO-160D Semi-Anechoic vs. Mode-Stirred chamber test methods. During the course of this comparison testing, ARINC 629 fiber optic data bus errors were found to occur just below 2 GHz. It was discovered (accidentally!) that the amplitude modulated square wave susceptibility threshold varied greatly depending upon the transition time output by the signal source.

## Semi-Anechoic Chamber Data

In figure 12, Engine Data Processor (EDP) susceptibility threshold data is shown, as collected in NASA Langley’s semi-anechoic facility. The shaded data-points bound the highest radiated peak electric field intensity the system could endure at a given frequency,

without excessive data errors. The unmodulated carrier, as well as three modulation options are shown. The two “Square 1kHz AM” options are both perfectly valid, and may be used interchangeably according to the DO-160D procedure.

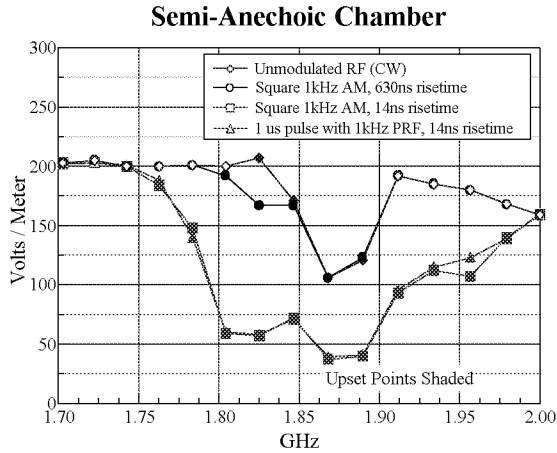

Figure 12: Engine Data Processor (EDP) peak electric field intensity susceptibility threshold data for different modulations and risetimes. All data shown is for Horizontal polarization. Unshaded test points show where maximum field intensity (up to 200 V/m or amplifier limit) was achieved without EDP upset.

Because the measurements are for peak electric field intensity, the average transmitted power is reduced by the duty factor of the transmitted signal. By the similarity in susceptibility threshold between the CW and “slow” (630ns) risetime square AM, it can be deduced that the failures were due to peak, not average power coupled into the system. (The square AM contained half the average power as CW.)

Most interestingly however, by simply changing the source to generate “squarer” pulses, a dramatic reduction in EDP immunity was observed. (Note the change in threshold from 630ns to 14ns risetime AM.)

An even more dramatic reduction in average power (1/500), still produced virtually no

difference in measured susceptibility threshold. (The only difference between the “fast” AM, and 1μs pulse signals were their duty factor: 50% vs. 0.1%.)

The data reveals, with absolute certainty that modulated signal transition time reduced system immunity by as much as 11dB!

### Mode-Stirred Chamber Data

To assess the influence of the charging characteristic of a reverberating room, figure 13 shows the same test data as measured in Langley’s mode-stirred chamber “A”.

As with the semi-anechoic chamber measurements, the trend of increased susceptibility with faster risetime is still evident.

It should be noted that different absorber loading was present for the mode-stirred chamber AM vs. pulse testing. The resulting chamber time constants were as follows:

- No absorber (CW & AM)  $\tau = 660\text{ns}$
- With absorber (Pulse Only)  $\tau = 270\text{ns}$

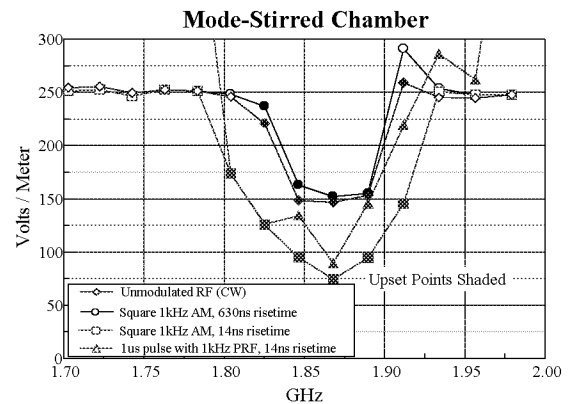

Figure 13: Same as figure 12, except data collected in Langley’s mode-stirred chamber “A”. Unshaded test points show where maximum field intensity (up to 250 V/m or amplifier limit) was achieved without EDP upset.

It is particularly interesting that even with a chamber time constant of 660ns, the EDP

susceptibility threshold was up to 6dB higher with the 14ns modulation risetime AM! Because the chamber time constant is roughly equal to the 630ns risetime AM, our 14ns data indicates that the chamber does not mask shorter transition times. This validates the previous assertion that chamber time constant does not fully determine the instantaneous signal characteristics subjected to the test article.

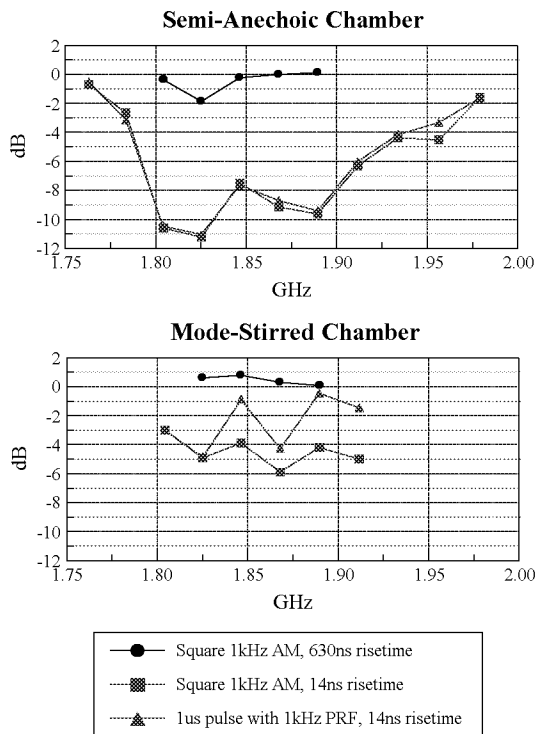

Figure 14: Comparison of Semi-Anechoic vs. Mode-Stirred Chambers. Modulation Susceptibility Thresholds relative to CW.

## Comparisons

To more fully appreciate the susceptibility threshold difference between the two chambers due to modulation, the ratio (dB Volts/meter) was taken between each modulated susceptibility threshold and that of CW (unmodulated). The results are shown in figure 14. It can readily be seen that modulation transition time resulted in up to an 11dB increase in threshold in the semi-anechoic

chamber, and up to 6dB increase in the mode-stirred chamber.

## Conclusions

### 1) Modulation Transition time proven to be a significant factor in EUT susceptibility threshold.

Experimental data was presented that establishes this fact. A computational analysis was also provided to quantify the effect of varying transition times upon the modulated frequency spectrum.

The most widely recognized standard procedures for verifying electronic system immunity to radiated fields do not specify guidelines for modulated signal transition time, thus further investigation may be warranted.

### 2) Mode-Stirred Chamber time constant does not fully determine the instantaneous signal characteristics subjected to the test article.

Mode-stirred chamber measurements reveal that the modulated signal frequency spectrum is essentially preserved, even when the transition time is shorter than the chamber time constant.

Experimental data proves that a risetime sensitive EUT can be evaluated in a mode-stirred chamber, even if the chamber time constant exceeds the region of EUT risetime sensitivity.

Our data indicates about a 5dB difference in risetime sensitivity between the semi-anechoic and mode-stirred methods. It was noted previously that in semi-anechoic chamber testing, the EUT is subjected to the full time/amplitude characteristic of each pulse repetition. For mode-stirred chamber tests with continuous stirring, the time/amplitude characteristic of every pulse will be different. Keeping this in mind, the following factors may contribute to the susceptibility difference:

- Mechanism of failure: If a specific EUT function is influenced by the full magnitude spectral content present in each pulse cycle, the mode-stirred method will reduce this spectral content for a percentage of the pulses. This may reduce the likelihood of failure.
- Detection of failure: If the criteria for determining EUT upset is based upon error rate, it is likely that a risetime sensitive EUT will exhibit errors less often in a mode-stirred chamber, because the full threat is not consistently present in each pulse period.

## Future Work

### Explore flight electronics sensitivity to risetime.

The reasons for increased sensitivity due to risetime in our test article remain unknown. The Engine Data Processor and associated system used in our experiment are owned by other organizations. Because parts of the system are proprietary, and because of the potential for damage, we are currently unable to further analyze the mechanism of failure. If there is enough interest and enthusiasm for continuing this investigation, further analysis may determine specific reasons for the risetime sensitivity in this case.

While it is possible that the test article used in our experimental data is unique in its sensitivity to risetime, more test articles should be investigated.

### Investigate EUT functional dependency upon mode-stirred chamber influences.

The only document we are currently aware of that addresses the need to further quantify modulation transition time for standard immunity testing is the draft ED14D User's Guide [9]. Our version of this document states that "for light loading conditions, the time constant of a mode-stirred chamber may be too

slow for tests requiring fast rise time waveforms". Our testing suggests that a more detailed guideline is required. A good starting point may be to suggest that whenever a pulse waveform susceptibility threshold is found to be lower than for the unmodulated case, the EUT be further evaluated for modulated signal transition time sensitivity. From this, it may be possible to establish guidelines for modifying mode-stirred test parameters (observation time, adjusted error rate criteria, paddle stepping, etc.) to more accurately quantify susceptibility threshold.

## References

- [1] RTCA DO-160D, Section 20 (Radio Technical Commission for Aeronautics Document), "Environmental Conditions and Test Procedures for Airborne Equipment", July, 1997.
- [2] EUROCAE ED-14D, Section 20 (European Organisation for Civil Aviation Equipment), "Environmental Conditions and Test Procedures for Airborne Equipment", 1997.
- [3] MIL-STD-461D (Military Standard), "Requirements for the Control of Electromagnetic Interference Emissions and Susceptibility", January, 1993.
- [4] MIL-STD-462D (Military Standard), "Measurement of Electromagnetic Interference Characteristics", January, 1993.
- [5] IEC 61000-4-3 (International Electrotechnical Commission), "Testing and measurement techniques-Section3: Radiated, radio-frequency, electromagnetic field immunity test", 1995.
- [6] SAE J1113 (Society for Automotive Engineers), "Electromagnetic Susceptibility Procedures for Vehicle Components (Except Aircraft)", June, 1984.
- [7] Edward C. Jordan, editor, "Reference Data for Engineers: Radio, Electronics, Computer, and Communications", 7th Edition, Howard W. Sams & Co., Inc., 1985.
- [8] M. L. Crawford and G. H. Koepke, "Design,

Evaluation, and use of a Reverberation Chamber for Performing Electromagnetic Susceptibility/Vulnerability Measurements”, NBS Technical Note 1092 (National Bureau of Standards), April, 1986.

- [9] EUROCAE ED-90, “Users Guide to ED14D Chapter 20: Radio Frequency Susceptibility (Radiated & Conducted)”, Draft, January 1998.



REPORT DOCUMENTATION PAGE			Form Approved OMB No. 0704-0188	
Public reporting burden for this collection of information is estimated to average 1 hour per response, including the time for reviewing instructions, searching existing data sources, gathering and maintaining the data needed, and completing and reviewing the collection of information. Send comments regarding this burden estimate or any other aspect of this collection of information, including suggestions for reducing this burden, to Washington Headquarters Services, Directorate for Information Operations and Reports, 1215 Jefferson Davis Highway, Suite 1204, Arlington, VA 22202-4302, and to the Office of Management and Budget, Paperwork Reduction Project (0704-0188), Washington, DC 20503.				
1. AGENCY USE ONLY (Leave blank)		2. REPORT DATE January 2000	3. REPORT TYPE AND DATES COVERED Technical Memorandum	
4. TITLE AND SUBTITLE The Influence of Modulated Signal Risetime in Flight Electronics Radiated Immunity Testing with a Mode-Stirred Chamber			5. FUNDING NUMBERS WU 522-14-21-02	
6. AUTHOR(S) Jay J. Ely Truong X. Nguyen Stephen A. Scarce				
7. PERFORMING ORGANIZATION NAME(S) AND ADDRESS(ES) NASA Langley Research Center Hampton, VA 23681-2199			8. PERFORMING ORGANIZATION REPORT NUMBER L-17943	
9. SPONSORING/MONITORING AGENCY NAME(S) AND ADDRESS(ES) National Aeronautics and Space Administration Washington, DC 20546-0001			10. SPONSORING/MONITORING AGENCY REPORT NUMBER NASA/TM-2000-209844	
11. SUPPLEMENTARY NOTES				
12a. DISTRIBUTION/AVAILABILITY STATEMENT Unclassified-Unlimited Subject Category 05      Distribution: Standard Availability: NASA CASI (301) 621-0390			12b. DISTRIBUTION CODE	
13. ABSTRACT (Maximum 200 words) For electromagnetic immunity testing of an electronic system, it is desirable to demonstrate its functional integrity when exposed to the full range and intensity of environmental electromagnetic threats that may be encountered over its operational life. As part of this, it is necessary to show proper system operation when exposed to representative threat signal modulations. Modulated signal transition time is easily overlooked, but can be highly significant to system susceptibility.  Radiated electromagnetic field immunity testing is increasingly being performed in Mode Stirred Chambers. Because the peak field vs. time relationship is affected by the operation of a reverberating room, it is important to understand how the room may influence any input signal modulation characteristics.  This paper will provide insight into the field intensity vs. time relationship within the test environment of a mode stirred chamber. An understanding of this relationship is important to EMC engineers in determining what input signal modulation characteristics will be transferred to the equipment under test. References will be given for the development of this topic, and experimental data will be presented				
14. SUBJECT TERMS Reverberation, mode-stirred, semi-anechoic, chamber, risetime, modulation, immunity, susceptibility, HIRF, EMC, time constant, quality factor			15. NUMBER OF PAGES 17	16. PRICE CODE A03
17. SECURITY CLASSIFICATION OF REPORT Unclassified	18. SECURITY CLASSIFICATION OF THIS PAGE Unclassified	19. SECURITY CLASSIFICATION OF ABSTRACT Unclassified	20. LIMITATION OF ABSTRACT UL	