

N O T I C E

THIS DOCUMENT HAS BEEN REPRODUCED FROM
MICROFICHE. ALTHOUGH IT IS RECOGNIZED THAT
CERTAIN PORTIONS ARE ILLEGIBLE, IT IS BEING RELEASED
IN THE INTEREST OF MAKING AVAILABLE AS MUCH
INFORMATION AS POSSIBLE

1999 EOS Reference Handbook

A Guide to NASA's
Earth Science Enterprise
and the
Earth Observing System

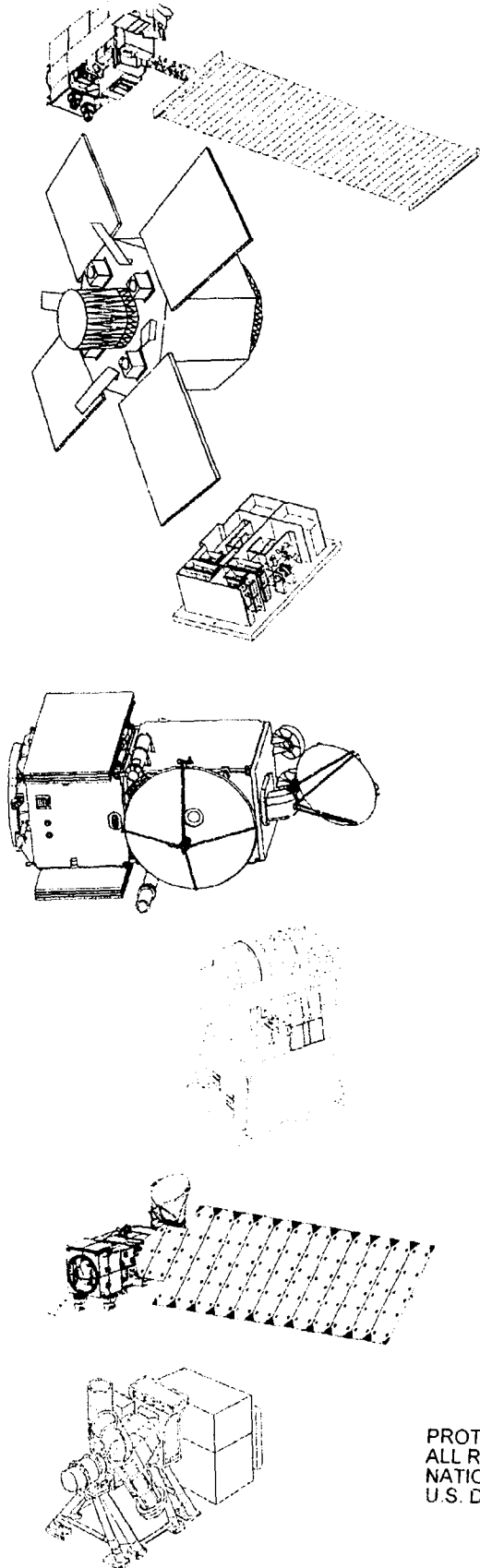

PROTECTED UNDER INTERNATIONAL COPYRIGHT
ALL RIGHTS RESERVED.
NATIONAL TECHNICAL INFORMATION SERVICE
U.S. DEPARTMENT OF COMMERCE

Editors

Michael D. King
Reynold Greenstone

Design and Production

Sterling Spangler

For Additional Copies:

EOS Project Science Office
Code 900
NASA/Goddard Space Flight Center
Greenbelt, MD 20771

Phone: (301) 441-4259
Internet: imcgrier@pop900.gsfc.nasa.gov

Acknowledgements

Special thanks are extended to the EOS Principal Investigators and Team Leaders for providing detailed information about their respective instruments, and to the Principal Investigators of the various Interdisciplinary Science Investigations for descriptions of their studies. In addition, members of the EOS Project at the Goddard Space Flight Center are recognized for their assistance in verifying and enhancing the technical content of the document. Finally, appreciation is extended to the international partners for providing up-to-date specifications of the instruments and platforms that are key elements of the International Earth Observing Mission.

Support for production of this document, provided by Winnie Humberson, William Bandeen, Carl Gray, Hannelore Parrish and Charlotte Griner, is gratefully acknowledged.

Table of Contents

Preface	5
Earth Science Enterprise	7
The Earth Observing System	15
EOS Data and Information System (EOSDIS)	27
Data and Information Policy	37
Pathfinder Data Sets	45
Earth Science Information Partners and the Working Prototype-Federation	47
EOS Data Quality: Calibration and Validation	51
Education Programs	53
International Cooperation	57
Interagency Coordination	65
Mission Elements	71
EOS Instruments	89
EOS Interdisciplinary Science Investigations	157
Points-of-Contact	340
Acronyms and Abbreviations	354
Appendix	361

List of Figures

1. Changes in Atmospheric Carbon Dioxide Concentration	7
2. NASA's Earth Science Enterprise	9
3. Earth Science Mission Profile	20
4. Earth Science Program and Flight Elements	21
5. EOSDIS Architecture	30
6. Geographic Distribution of EOSDIS DAACs	31
7. Terra Payload	71
8. U.S. and International Partner Earth Observing Missions	86-87
9. EOS Program-Level Architecture	88

List of Tables

1. ESE Phase I: NASA Contributions	10
2. ESE Pre-EOS: Non-NASA Contributions	11
3. EOS Era (First Series) Remote-Sensing Satellites	13-14
4. EOS Program History	15
5. EOS, NMP and ESSP Instrument Complement: Phase 1	22
6. EOS and NMP Platform Instrument Counts and Data Rates	23
7. Links to IPCC Areas of Uncertainty	24
8. EOS Distributed Active Archive Centers	28
9. Some of the Major Foreign Contributions to NASA's Earth Science Enterprise	60
10. Some of the Major Satellite Missions in the International Earth Observing System	61-63

Page intentionally left blank

Preface

This 1999 edition of the Earth Observing System (EOS) Reference Handbook has been prepared to present the latest status of this evolving program.

As will become clear through reading this Handbook, the Earth Science Enterprise has adopted a more-flexible approach to planning new missions in the period following 2002. This has become possible, in part, through the funding of technology development that supports more-efficient and cost-effective instrument implementation that shortens mission development cycles.

A special feature of this edition is the addition of the descriptions of new Interdisciplinary Science Investigations (IDS) that have been added to the EOS Program since the 1995 edition was published. The new investigations will significantly broaden the scope of the science that has been the province of the original IDS Investigations from the very beginnings of EOS. IDS Investigations have the special function of performing the scientific analyses that will benefit from the vast array of remote-sensing data that are now becoming available from various sources. The investigations are developing and applying the skills needed to take advantage of data from the highly sophisticated instruments that will be launched onboard EOS satellite platforms and onboard the complementary satellite platforms from the international community.

Functioning in an interactive mode, the various IDS investigations are testing the capabilities of NASA's new Earth Observing System Data and Information System (EOSDIS). Prior to launch of the first EOS spacecraft in 1999, they are using early versions of EOSDIS to perform their scientific studies. Their experiences in using the system now permit them to feed back suggestions for improvement to the EOSDIS developers.

The scientific investigations associated with EOS instruments play a major role in supporting overall EOS science objectives. The geophysical parameters that are supplied to the interdisciplinary investigations as EOS instrument products are themselves the products of considerable research by members of the many EOS instrument teams. Research by the instrument team members makes possible the conversion of instrument signals to the geophysical parameters that are then used by the interdisciplinary investigators as well as instrument investigators in their work. The instrument team members not only provide the geophysical parameters (standard instrument products), but also participate in the field experiments and mathematical analyses required to provide the necessary assurances of the validity of the data. They also conduct inter-instrument investigations that are the basis for multi-sensor products that would not be available from instruments flying alone.

An electronic version of this Handbook is available online at:
http://eos.nasa.gov/eos_homepage/misc_html/refbook.html.

I hope you will find this document informative as well as useful. I will be glad to respond to any comments or questions you may have.

Michael D. King
EOS Senior Project Scientist

Page intentionally left blank

Earth Science Enterprise

Background

In the next century, planet Earth faces the potential hazard of rapid environmental changes, including climate warming, rising sea level, deforestation, desertification, atmospheric ozone depletion, acid rain, and reduction in biodiversity. Such changes would have a profound impact on all nations, yet many important scientific questions remain unanswered. For example, while most scientists agree that global warming is likely, its magnitude and timing (especially at the regional level) are quite uncertain. Additional information on the rate, causes, and effects of global change is essential to develop the understanding needed to cope with it. The National Aeronautics and Space Administration (NASA) is working with the national and international scientific communities to establish a sound scientific basis for addressing these issues through research efforts coordinated under the U.S. Global Change Research Program (USGCRP), the International Geosphere-Biosphere Program (IGBP), and the World Climate Research Program (WCRP).

Scientific research shows that the Earth has changed over time and continues to change. Human activity has altered the condition of the Earth by reconfiguring the landscape, by changing the composition of the global atmosphere, and by stressing the biosphere in countless ways. There are strong indications that natural change is being accelerated by human intervention. In its quest for improved quality of life, humanity has become a force for change on the planet, building upon, reshaping, and modifying nature—often in unintended ways.

The byproducts of human activities, such as carbon dioxide, methane, nitrous oxide, and other gases, trap heat emitted from the Earth's surface, thus potentially warming the global atmosphere. Measurements over the past several decades have documented a rapid rise in concentrations of these greenhouse gases (e.g., Figure 1). Changes in other variables, such as global cloudiness, concentration of atmospheric dust particles, sea-ice concentrations, and ocean circulation patterns, also have an impact on Earth's climate. The existing space-based systems for global

monitoring lack the spatial, temporal, and spectral coverage needed to provide observations of the accuracy and precision desired to interpret the interactions among these variables and their individual and combined contributions to global climate. Furthermore, current modeling of these interactive processes does not represent them with sufficient accuracy to generate reliable predictions of the magnitude and timing of global climate change.

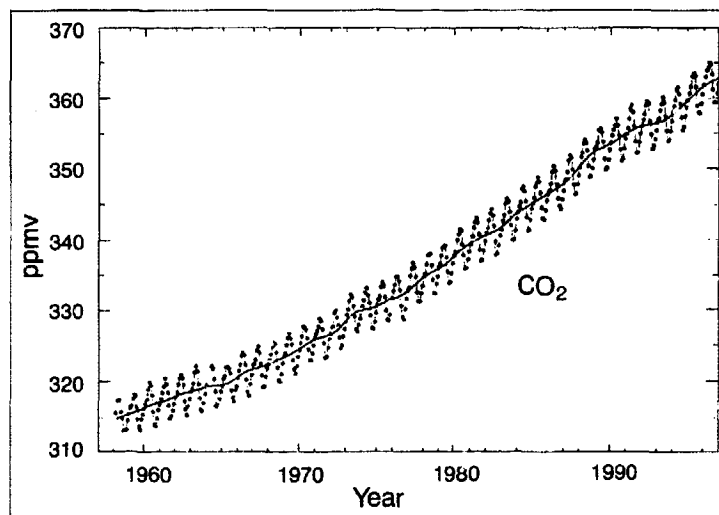

Figure 1. Atmospheric carbon dioxide monthly mean mixing ratios as observed by Tans and Keeling at Mauna Loa, Hawaii. Data prior to May 1974 are from the Scripps Institution of Oceanography, and data since May 1974 are from the National Oceanic and Atmospheric Administration (NOAA).

Only through systematic, comprehensive research can scientists further knowledge of Earth's climate and its variations, thereby providing guidance to policymakers, who must balance the needs of constituents with the welfare of the planet and the species that inhabit it. The study of ozone levels by the Upper Atmosphere Research Program (UARP) illustrates how Earth science research yields a clear picture of human-induced global change. In the 1970s, scientists first proposed the chemical processes by which human-made chlorofluorocarbons (CFCs) deplete stratospheric ozone. After a long-term research program

based on in situ and space-based observations, the international scientific community reached a consensus on global ozone depletion. The evidence and understanding gained from this research led to the 1987 Montreal Protocol for worldwide reduction in the production of CFCs.

Overview

The Earth Science Enterprise (ESE; Figure 2), formerly called Mission to Planet Earth, is a NASA-initiated concept that uses space-, ground-, and aircraft-based measurement systems to provide the scientific basis for understanding the climate system and its variations. NASA's contributions to ESE include ongoing and near-term satellite missions, new missions under development, planned future missions, management and analysis of satellite and in situ data, and a continuing basic research program focused on process studies, modeling, and data analysis. The space-based components of ESE will provide a constellation of satellites to monitor the Earth from space. Sustained observations will allow researchers to monitor Earth's climate variables over time to determine trends; however, space-based monitoring alone is not sufficient. A comprehensive data and information system, a community of scientists performing research with the data acquired, and extensive ground and airborne campaigns are all important components. More than any other factor, the commitment to make Earth science data easily available to the research community proves critical to mission success.

Satellites operating in a variety of orbits form the space component of ESE. No single orbit permits the gathering of complete information on Earth processes. For example, the medium-inclination orbit of the Upper Atmosphere Research Satellite (UARS) was chosen specifically because of UARP focus on the processes influencing ozone depletion. High-inclination, polar-orbiting satellites are needed to observe phenomena that require relatively detailed observations on a routine basis, often from a constant solar illumination angle. Geostationary satellites are needed to provide continuous monitoring of high-temporal-resolution processes; an international array of these platforms now provides coverage on a near-global basis. This coverage may be improved early in the next century by geostationary satellites with advanced instrumentation planned by NASA and its international partners.

Science Objectives

ESE science objectives address the fundamental physical, chemical, and biological phenomena that govern and integrate the Earth system. In pursuit of these overall objectives ESE has established five key science priority areas:

- *Biology and biogeochemistry of ecosystems and the global carbon cycle*, including terrestrial ecology, ocean biology and biogeochemistry, and land cover and land use change.
- *Global water and energy cycle*, including atmospheric circulation dynamics and thermodynamics, land surface processes and hydrology, clouds, aerosol and radiation in the Earth's climate, and atmospheric four-dimensional data assimilation.
- *Climate variability and prediction*, including radiative forcing factors, global ocean circulation and sea-ice, ice sheets and glaciers, and global modeling.
- *Atmospheric chemistry*, including atmospheric composition and ozone research.
- *Solid Earth science*, including space geodesy and the international terrestrial reference frame, gravity field, magnetic field, and global geology.

These five science priority areas are in general accord with the four environmental science issues that have been defined by the USGCRP as discussed below. A notable exception is the addition of "Solid Earth science, including natural hazards research and applications" to the list.

ESE observations will permit assessment of various Earth system processes, including the following:

- *Hydrologic processes* that govern the interactions of land and ocean surfaces with the atmosphere through the transport of heat, moisture, and momentum;
- *Biogeochemical processes* that contribute to the formation, dissipation, and transport of trace gases and aerosols, and their global distributions;
- *Atmospheric processes* that control the formation, dissipation, and distribution of clouds and aerosols and their interactions with solar radiation;
- *Ecological processes* that are affected by and/or will affect global change, and their response to such changes through adaptation; and
- *Geophysical processes* that have shaped or continue to modify the surface of the Earth through tectonics, volcanism, and the melting of glaciers and sea ice.

The goal of ESE is to advance scientific understanding of the entire Earth system by developing a deeper comprehension of the components of that system and the interactions among them. To quantify changes in the Earth

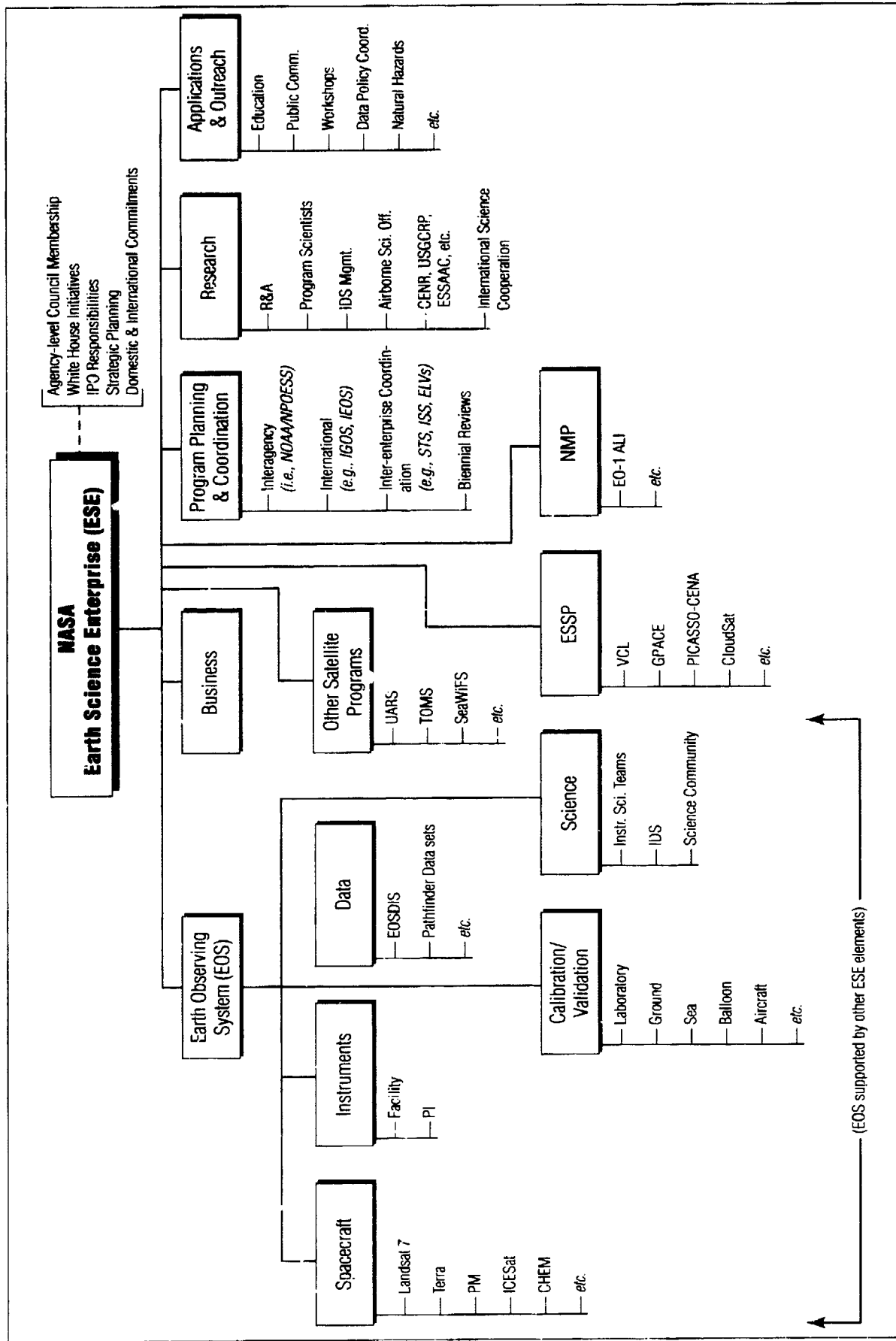

Figure 2. NASA's Earth Science Enterprise

system, ESE's principal element, the Earth Observing System (EOS), will provide systematic, continuous observations from low Earth orbit for a minimum of 15 years. EOS broad mission objectives in support of this goal are to:

- Create an integrated scientific observing system that will enable multidisciplinary study of the Earth's critical, life-enabling, interrelated processes involving the atmosphere, oceans, ice, and land surfaces, and the dynamic and energetic interactions among them.
- Develop a comprehensive data and information system, including a data retrieval and processing system, to serve the needs of scientists contributing to an integrated, multidisciplinary study of planet Earth.

- Support the overall USGCRP by acquiring and assembling a global database of remote-sensing measurements from space; priorities for acquiring these data will conform to the four priority environmental science issues identified by the USGCRP as key to understanding global climate change, including:

- 1) *Understanding the Earth's Climate System*, with a focus on improving our understanding of the climate system as a whole, rather than focusing on its individual components, and thus improving our ability to predict climate change and variability.
- 2) *Biology and Biogeochemistry of Ecosystems*, with a focus on improving understanding of the relationship between a changing biosphere and a changing climate and the impacts of global change on managed and natural ecosystems.

NASA Satellites/Instruments (Launch Status)	Mission Objectives
ERBS (<i>Operational</i>) Earth Radiation Budget Satellite	Earth radiation budget, aerosol, and ozone data from 57° inclination orbit
UARS (<i>Operational</i>) Upper Atmosphere Research Satellite	Stratospheric and mesospheric chemistry and dynamic processes
NASA Spacelab Series	A series of Shuttle-based experiments to measure atmospheric and solar dynamics (ATLAS), atmospheric aerosols (LITE), and surface radar backscatter, polarization, and phase information (SIR-C and X-SAR— <i>joint with Germany and Italy</i>)
TOPEX/Poseidon (<i>Operational</i>) Ocean Topography Experiment	Ocean circulation (<i>joint with France</i>)
SeaWiFS/OrbView-2 (<i>Operational</i>) Sea-viewing Wide Field-of-view Sensor	Purchase of ocean color data to monitor ocean productivity
TOMS/Earth Probe 96 (<i>Operational</i>) Total Ozone Mapping Spectrometer	Ozone mapping and monitoring
NSCAT/ADEOS (<i>1996-1997</i>) NASA Scatterometer	Ocean surface wind vectors (<i>joint with Japan</i>)
TOMS/ADEOS (<i>1996-1997</i>) Total Ozone Mapping Spectrometer	Ozone mapping and monitoring (<i>joint with Japan</i>)
TRMM (<i>Operational</i>) Tropical Rainfall Measuring Mission	Precipitation, clouds, lightning, and radiation processes over tropical regions (<i>joint with Japan</i>)

Table 1. ESE Phase I: NASA Contributions

Non-NASA Satellites/Instruments (Launch Status)	Mission Objectives
FOES (U.S. - Operational) NOAA Polar-orbiting Operational Environmental Satellites	Earth's surface and atmosphere visible and radiance/reflectance, infrared atmospheric sounding, and ozone measurements; space environmental monitoring
Landsat 5 (U.S. - Operational) Land Remote Sensing Satellite	High spatial resolution visible and infrared radiance/reflectance and terrestrial surfaces
DMSF (U.S. - Operational) Defense Meteorological Satellite Program	Visible, infrared, and passive microwave atmospheric and surface measurements
ERS-1 (ESA - On standby since June 1996) European Remote-Sensing Satellite	C-band SAR, microwave altimeter, scatterometer, and sea surface temperature
JERS-1 (Japan - 1992-1998) Japan's Earth Resources Satellite	L-band SAR backscatter and high spatial resolution surface visible and infrared radiance/reflectance
ERS-2 (ESA - Operational) European Remote-Sensing Satellite	Same as ERS-1, plus ozone mapping and monitoring
Radarsat-1 (Canada - Operational) Radar Satellite	C-band SAR measurements of Earth's surface (joint U.S./Canadian mission)
ADEOS (Japan, 1995-1997) Advanced Earth Observing Satellite	Surface visible and near-infrared radiance/reflectance scatterometry, and tropospheric and stratospheric chemistry (joint with Japan)

Table 2. ESE Pre-EOS: Non-NASA Contributions

- 3) *Composition and Chemistry of the Atmosphere*, with a focus on improving our understanding of the global-scale impacts of natural and human processes on the chemical composition of the atmosphere and determining the effect of such changes on air quality and human health.
- 4) *The Global Water Cycle*, with a focus on improving our understanding of the movement of water through the land, atmosphere, and ocean, and on how global change may increase or decrease regional water availability.

Pre-EOS: 1990 - 1998

Table 1 delineates NASA's contributions to Phase I of ESE (the period of Earth observations preceding the launch of NASA's first EOS satellites in 1999). Table 2 identifies other U.S. and international Earth observation satellites that will be in place during this period.

EOS First Series: 1999-2003

The Earth Observing System—consisting of a science segment, a data system, and a space segment made up of a series of polar-orbiting and low-inclination satellites for long-term global observations of the land surface, biosphere, solid Earth, atmosphere, and oceans—is the centerpiece of ESE. In concert with EOS, the polar-orbiting and mid-inclination platforms from Europe, Japan, and the U.S. National Oceanic and Atmospheric Administra-

tion (NOAA) form the basis for a comprehensive International Earth Observing System (IEOS). NASA, Japan, and the European Space Agency (ESA) programs will establish an international Earth-observing capability that will operate for at least 15 years. IEOS will allow scientists to obtain information at many levels of detail, covering all major Earth system processes.

Tables 3a and 3b identify the NASA, other U.S., and international contributions of Earth observing satellites during the EOS First Series period. Additional details on these satellites are presented in the Mission Elements section of this Handbook. EOS satellites will carry two classes of instruments: Facility Instruments supplied by NASA in response to general mission requirements, and Principal Investigator (PI) Instruments selected through a competitive process and aimed at the focused research interests of the selected investigators. Of course, the PI Instruments are also responsive to overall EOS objectives. The EOS Instruments section provides details on the science to be accomplished and the high-level engineering specifications for the instruments now included in the EOS Program.

The EOS Program has a number of major elements other than the EOS spacecraft and instruments. These essential elements—the EOS Data and Information System (EOSDIS), interdisciplinary science research, calibration and validation, education, and international cooperation—receive coverage later in this Handbook.

The data collection segment of ESE—EOS, Pathfinders, geostationary satellites, and aircraft- and ground-based programs—will provide the comprehensive global observations necessary to understand how the processes that govern global change interact as part of the Earth system. Through this refined knowledge, models will be developed to help predict future environmental change on local, regional, and global scales. For those who make observations of the Earth system and develop models of its operation, Earth system science involves the creation of interdisciplinary models that couple elements from formerly disparate sciences, such as terrestrial ecology and meteorology.

EOS Follow-on (Post 2003)

NASA's long-range planning calls for continuation of ESE beyond 2003. Plans include a new generation of satellites in geostationary orbit and additional small Pathfinder satellites addressing specific Earth science investigations. NASA also has initiated a technology program for developing a new generation of sensor technologies. These technologies will eventually migrate into future EOS flight programs. Of course, the data system aspects of ESE will continue throughout and beyond the lifetime of the EOS mission.

Several mission categories have been identified to provide critical Earth science measurements not provided

by the currently scheduled international constellation of satellites. NASA intends to pursue collaborations with domestic and/or international partners in the following disciplines: Gravity and magnetic fields, solid-Earth topography, and ocean topography. Specific instruments and platforms have yet to be identified for these missions. Additional Earth System Science Pathfinder (ESSP) and New Millennium Program (NMP) missions will be launched as particular observations are requested by the national and international science community, or as data gaps develop. The main driver behind this program is to provide focused missions in a faster, better, and cheaper manner, alleviating lengthy procurements. These small-to-moderate-sized satellites will have highly focused objectives and obtain measurements that are not provided by EOS or other instrument suites. NASA is currently examining alternative strategies for implementation of the second EOS missions, with some missions focused on long-term monitoring of key data sets initiated by the first series, some focused on process studies to improve our understanding of focused Earth system processes and some aimed at demonstrating operational capability. Emphasis will be on small satellite technology whenever appropriate.

EOS missions will provide high-spatial-resolution global information. The various orbits of these space-based elements of ESE will give Earth scientists a comprehensive, cohesive set of observations—providing a wide range of scales—on Earth system processes.

Contribution to the U.S. Global Change Research Program

ESE is NASA's contribution to the U.S. Global Change Research Program (USGCRP), which is the focal point of U.S. activities in support of the worldwide research collaboration now underway to study global change. USGCRP coordinates the efforts of numerous participating Federal agencies under the guidance of the Committee on the Environment and Natural Resources (CENR), itself one of nine standing research and development coordinating subcommittees under the National Science and Technology Council, which was established in November 1993 (see section on Interagency Coordination).

CENR has acknowledged the absolute necessity of the remote sensing from space of certain key Earth system variables, and reaffirmed the science strategy that had earlier been put forth by its predecessor organization, the Committee on Earth and Environmental Sciences (CEES). Thus, CENR, and thereby the National Science and Technology Council, affirm the relevance of ESE to national policy relating to global change.

The ESE science contributions can be viewed for convenience as a means of obtaining global measurements (with appropriate characteristics) of the 24 Earth system variables in the Appendix on page 361.

References

NASA, 1998: *Earth Science Strategic Enterprise Plan, 1998-2002*. NASA Headquarters, Code YS, 300 E Street, SW, Washington, DC 20546.

NASA 1999: *ESE Science Implementation Plan, October 1999*. NASA Headquarters, Code YS, 300 E Street, SW, Washington, DC 20546.

Our Changing Planet—the FY 2000 U.S. Global Change Research Program. a report by CENR. This publication

outlines all of the U.S. Federal Government activities consisting of both ground- and space-based efforts in research, data-gathering, and modeling activities, as well as economic research, with near- and long-term scientific and public policy benefits. Budgets are presented by agency and by scientific element. This publication is published annually.

Earth Science Enterprise URL

<http://www.earth.nasa.gov/>

Satellites (Launch Status)	Mission Objectives
QuikScat (1999) SeaWinds Scatterometer	Ocean surface wind vectors
Landsat 7 (1999) Land Remote-Sensing Satellite	High-spatial-resolution visible and infrared radiance/reflectance to monitor land surface (<i>joint with USGS</i>)
Terra (1999) Earth Observing System Morning Crossing (<i>Descending</i>)	Clouds, aerosols, and radiation balance, characterization of the terrestrial ecosystem; land use, soils, terrestrial energy/moisture, tropospheric chemical composition; contribution of volcanoes to climate, and ocean primary productivity (<i>includes Canadian and Japanese instruments</i>)
ACRIMSAT (1999) Advanced Cavity Radiometer Irradiance Monitor Satellite	Total solar irradiance
NMP/EO-1 (1999) First Earth science technology mission:	Provide paired scene comparisons between EO-1 Advanced Land Imager (ALI) and Landsat 7 Enhanced Thematic Mapper Plus (ETM+)
METEOR 3M-1 (Russia - 2000) Stratospheric Aerosol and Gas Experiment III	Retrieve global profiles of atmospheric aerosols, ozone, water vapor, other trace gases, temperature and pressure in the mesosphere, stratosphere, and troposphere
Jason-1 (2000) EOS Ocean Altimetry Mission	Ocean circulation (<i>joint with France</i>)
ENVISAT Series (ESA - 2000) Environmental Satellite	Environmental studies in atmospheric chemistry and marine biology and continuation of ERS mission objectives
ADEOS II (Japan - 2000) Advanced Earth Observing Satellite II	Visible-to-thermal-infrared radiance/reflectance, microwave imaging, scatterometry, ozone, aerosols, atmospheric temperature, winds, water vapor, SST, energy budget, clouds, snow and ice, ocean current, ocean color/biology (<i>includes French and U.S. instruments</i>)

Table 3a. EOS Era (First Series) Remote-Sensing Satellites

Satellites (Launch Status)	Mission Objectives
ESSP/VCL (2000) First Earth System Science Pathfinder mission	Measure heights of the vegetation canopy
EOS PM (2000) Earth Observing System Afternoon Crossing (<i>Ascending</i>)	Atmospheric temperature and humidity; clouds, precipitation, and radiative balance; characterization of terrestrial and oceanic processes including productivity; air-sea fluxes of energy and moisture; and sea-ice and snow-cover extents (<i>includes Brazilian and Japanese instruments</i>)
ESSP/GRACE (2001) Second Earth System Science Pathfinder mission	Measure Earth's gravity field
ICESat (2001) EOS Ice-Sheet Altimetry Mission	Ice sheet mass balance and cloud-top and land-surface topography and vertical profiles of aerosol and cloud properties
ALOS (Japan - 2001) Advanced Land Observational Satellite	Land surface, cartography, and disaster monitoring
SORCE (2002) Solar Radiation and Climate Experiment	Total and spectral solar irradiance
EOS CHEM (2002) EOS Chemistry Mission	Atmospheric chemical composition; tropospheric-stratospheric exchange of energy and chemicals; chemistry-climate interactions; air quality (<i>includes joint Netherlands/Finland and joint U.K./U.S. instruments</i>)
Space Station-SAGE III (2003) International Space Station	Mid-inclination, low-altitude flight of SAGE III for measuring atmospheric aerosols, ozone, water vapor, other trace gases, temperature and pressure in the mesosphere, stratosphere, and troposphere
ESSP/PICASSO-CENA (2003) Third Earth System Science Pathfinder mission	Vertical distribution of clouds and aerosols (<i>joint with France</i>)
ESSP/CloudSat (2003) Fourth Earth System Science Pathfinder mission	Increase the understanding of the role of optically thick clouds on the Earth's radiation budget (<i>joint with Canada</i>)
METOP Series (EUMETSAT/ESA - 2003) Meteorological Operational Satellite	Operational meteorology and climate monitoring, with the future objective of operational climatology (<i>joint with NOAA</i>)
ATMOS Series (Japan and NASA - Proposed for 2003) Precipitation Mission	Precipitation and related variables and Earth radiation budget in middle and higher latitudes; also trace gases

Table 3b. EOS Era (First Series) Remote-Sensing Satellites

The Earth Observing System

Planning for the EOS mission began in the early 1980s, and an Announcement of Opportunity (AO) for the selection of instruments and science teams was issued in 1988. 458 proposals were received in response to the AO. Early in 1990, NASA announced the selection of 30 instruments to be developed for EOS, along with their science teams; 29 Interdisciplinary Science Investigation teams were also selected at that time.

EOS was recognized in 1990 as part of the Presidential initiative, Mission to Planet Earth (now called the Earth Science Enterprise), receiving its "new start" from Congress in October. The EOS Program was funded under a continuing resolution, and ramped up to its full funding with the approval of the FY 91 budget in January 1991. At that time, plans called for the instruments to be divided into three groups—those on the EOS-A and EOS-B series spacecraft, and those for flight as attached payloads on Space Station Freedom. Instrument selections were also made for the proposed Japanese and European polar-orbiting satellites, then referred to as the Japanese Polar-Orbiting Platform (JPOP) and the European Polar-Orbiting Platform (EPOP). A NASA research announcement (NRA) for the selection of new investigations, instrument teams, and young investigators was issued in 1995. 309 proposals were received in response to the NRA. On July 1, 1996, NASA announced the selection of team members for 5 instrument teams, including Landsat 7, 31 Interdisciplinary Science Investigation Teams, and 21 New Investigators. Table 4 provides the major milestones of the EOS Program to date.

EOS Science Objectives

The overarching goal of the EOS Program is to determine the extent, causes, and regional consequences of global climate change. The extent (e.g., the change in average temperature and the time scale over which it will occur) is presently unknown. Causes can be either natural or human-induced. Both must be understood to determine how to alter human behavior appropriately to avoid climate changes that prove most detrimental to the environment. The regional consequences (e.g., changes in precipitation patterns, length of growing seasons, severity of storms, change of sea level) must be understood to determine which aspects of climate change are most harmful, and how to adapt to those changes that the human species cannot avoid.

Mission Planning	1982-87
Announcement of Opportunity	1988
Peer Review Process	1988-89
Letter Review (Academia/Government)	
Panel Review (Academia/Government)	
Prioritization Panel (Academia/Government)	
Definition Phase	1989-90
Announcement of Selection	1990
New Start	1990
Execution Phase	1990 on
Restructuring Process	1991-92
Restructuring Confirmation	1992
Rescoping Process	1992
National Space Policy Directive 7	1992
Rescoping Confirmation	1993
Rebasellning	1994
Reshaping	1995
NASA Research Announcement	1995
Landsat 7 Team	
Augmentation to MODIS, AIRS, AMSR Teams	
Interdisciplinary Science Teams	
Young Investigators	
Peer Review Process	1995-96
First Biennial Review	1997
NASA Research Announcement	1997
Jason-1 Science Team	
Terra/SAGE III Validation Program	
Peer Review Process	1997-98

Table 4. EOS Program History

The EOS Investigators Working Group (IWG) defined the following science and policy priorities for EOS observations, based on scientific recommendations by national and international programs such as the Intergovernmental Panel on Climate Change (IPCC) and the Committee on Earth and Environmental Sciences (CEES)/

Committee on the Environment and Natural Resources Research (CENR):

1) *Clouds and Radiation*

Cloud formation, dissipation, and radiative properties, which influence response of the atmosphere to greenhouse forcing.

Large-scale hydrology and moisture processes, including precipitation and evaporation.

2) *Oceans*

Exchange of energy, water, and chemicals between the ocean and atmosphere, and between the upper layers of the ocean and deep ocean (includes sea ice and formation of bottom water).

3) *Greenhouse Gases*

Links to the hydrologic cycle and ecosystems, transformations of greenhouse gases in the atmosphere, and interactions inducing climate change.

4) *Land Surface Hydrology and Ecosystem Processes*

Improved estimates of runoff over the land surface and into the oceans, sources and sinks of greenhouse gases, exchange of moisture and energy between the land surface and atmosphere, and changes in land cover.

5) *Glaciers and Polar Ice Sheets*

Predictions of sea-level change and global water balance.

6) *Ozone and Stratospheric Chemistry*

Chemical reactions, solar-atmosphere relations, and sources and sinks of radiatively important gases.

7) *Solid Earth*

Volcanoes and their role in climatic change.

The IWG—which includes all selected Interdisciplinary Science Investigation Principal Investigators (PIs) and Co-Investigators (Co-PIs), Instrument Investigators and Co-Investigators, and Facility Instrument Team Leaders and Team Members—establishes EOS science objectives in coordination with the national and international Earth science community.

The IWG and the following Panels and Working Groups provide NASA with recommendations related to the design and implementation of all elements of EOS:

Science Panels

Atmospheres

Biogeochemical Cycles

Land

Oceans

Physical Climate and Hydrology

Functional Panels

EOSDIS

Payload

Working Groups

SWAMP [Science Working Group for the AM (Terra) Platform]

PM Working Group

Cryosphere Working Group

Chemistry Working Group

The EOS Program provides resources to support the scientific research required to turn satellite measurements into science data products for inclusion in, or comparison with, model results; specifically, EOS supports scientific investigations through its Interdisciplinary Science Investigations and Instrument Teams.

EOS Interdisciplinary Science Investigations are scientific studies selected through a competitive process to develop and refine integrated Earth system models, which will use EOS instrument observations to help in understanding the Earth as a system (see the EOS Interdisciplinary Science Investigations section for details on the studies chosen as part of the EOS Program).

NASA issues NRAs every two-to-three years to allow broader participation in the EOS Program by members of the Earth science community.

EOS Instrument Teams, also selected through a competitive process, help define the scientific requirements for their respective instruments, and generate the algorithms that will be used to process the data into useful data products. (See the Algorithm Theoretical Basis Documents [ATBDs] on the World Wide Web for an in-depth presentation of the algorithms. Each ATBD may be downloaded at <http://eos.nasa.gov/atbd/pg1.html>).

In 1995 NASA solicited new investigations in support of other EOS facility instruments such as AIRS, MODIS, and AMSR-E. It is envisioned that this opportunity will be renewed once every two-to-three years to allow broader participation in the EOS Program by members of the Earth science community. NASA has also formed new Science Teams for the Landsat 7 and Jason-1 missions, and will form the OMI facility instrument team in 1999.

EOS investigations are intended to characterize the Earth system as an integrated whole, while also quantifying the regional processes that govern it. Research will be based initially on the existing sources of ground- and space-based observations (see Pathfinder Data Sets section) and will continue through and beyond the launch of the EOS satellites. Efforts to understand these Earth system elements will shed light on how the Earth functions as a coupled and integrated system, how it responds to human-induced perturbations, and how this response manifests itself as global climate change.

Discussion of the different types of products to be made available as EOSDIS evolves to a full operational

capability is included in the EOS Data and Information System section of this Handbook.

The EOS Program has undergone major revisions since the last edition of this Handbook was published in 1995. The following subsection provides, in bullet form, an overview of the successive reconfigurations of the program, which resulted initially from a Congressional mandate and Executive Branch requirements to reduce substantially the budget through 2000. The Pathfinder Data Sets section is intended to inform readers of what is being done now to further global change research. A section on Interagency Coordination presents the roles played by other Federal agencies, in cooperation with NASA, to make and analyze observations of the Earth. The Mission Elements section provides details of the international instrument suites that constitute the International Earth Observing System (IEOS). This section provides as comprehensive and up-to-date coverage as possible, given the transient nature of payload configurations imposed by constrained national budgets the world over. This section and the EOS Instruments section describe the current Earth remote-sensing satellite scenario and the instrumentation that will yield the observations needed to further global change research.

The section on EOS Interdisciplinary Science Investigations gives a broad picture of the many science investigations that are in place to perform Earth System Science, taking particular advantage of the unprecedented flow of Earth observations to be provided from a variety of sources.

The original extensive discussion going from the Restructuring Process through the Rebaselining Process (pages 14-23 of the 1995 Reference Handbook) has been deleted in this version. This material is replaced by the "bulleted" material that follows. In addition there is new bulleted material relating to the Reshape Study and the Biennial Review of 1997.

EOS Program Revisions

Starting in 1991 there has been a series of major revisions of the EOS Program, generally prompted by the need for substantial budget reductions. Key elements of each of these program revisions are presented in outline form in the subsections that follow. The successive revisions have been dubbed, "The Restructuring Process," "The Rescoping Process," "The Rebaselining Process," and "The Reshape Process." Further revisions of the EOS Program are occurring as a consequence of recommendations that were made in the first "Biennial Review" of ESE.

The Restructuring Process (1991)

Directed by the U.S. Congressional Committee on Appropriations

Purpose:

- focus on global climate change
- obtain flexibility by flying on multiple smaller platforms
- reduce EOS cost from \$17 billion to \$11 billion through FY 2000

Guiding Principles:

- ensure continuity of observations for 15 years
- prioritize policy-relevant science questions
- identify instruments whose measurements can be met by other programs
- deselect instruments as appropriate

Outcome:

- restructured program approved by U.S. Congress (March 1992) and formally endorsed by the National Space Council in National Space Policy Directive 7 (NSPD 7, June 1992)
- 17 instruments to fly before 2002; six later
- 7 instruments deselected
- series of smaller expendable launch vehicles (ELVs) adopted in lieu of Titan 4 class launch vehicle
- 6-month earlier launch of EOS AM spacecraft
- EOS AM* and EOS PM concept adopted, permitting study of diurnal variations
- NSPD 7 stipulates that NASA coordinate production of an interagency program plan entitled *The Space-Based Global Change Observation System (S-GCOS) Program Plan* to achieve integration of Earth remote-sensing activities of NASA, DoE, and DoD

The Rescoping Process (1992)

Purpose:

- respond to U.S. Congress reduction in EOS decadal budget from \$11 billion to \$8 billion (budget established in FY 1993 appropriations bill)

Guiding Principles:

- reduce program contingency funds
- preserve science requirements identified in restructuring process
- depend increasingly on international partners

Outcome:

- commitments to fly international instruments; June 1998 launch date for EOS AM-1 maintained
- common spacecraft to be developed for EOS PM, CHEM, AM-2/AM-3; EOS AM-1 spacecraft unique
- HIRIS instrument eliminated
- number of at-launch data products decreased
- TOPEX/Poseidon follow-on replaced by mission based on French instruments
- GGI instrument concept replaced by French DORIS instrument

* EOS AM (or EOS AM-1) has recently been renamed Terra.

- several flight of opportunity (FOO) instruments to be included in CHEM series
- number of instruments to fly on EOS platforms reduced to 22 (15 to fly before 2003)

The Rebaselining Process (1994)

Purpose:

- respond to administration budget request for FY 1995 representing approximately a 9% reduction in the EOS budget compared to the rescoped (\$8 billion) budget approved only one year before.

Guiding Principles:

- maintain AM-1 launch date at June 1998
- make available elements of EOSDIS needed to support AM-1 in June 1998 and TRMM in August 1997
- use common spacecraft as standard platform for at least PM-1 and CHEM-1 missions

Outcome:

- six-year launch centers adopted for AM and PM series
- combined radar/laser altimeter mission rephased as two separate missions; launch of laser mission slipped by 12 months
- move TES from AM-2 to CHEM-1
- remove ACRIM III, SAGE III, and SOLSTICE from CHEM-1
- add Landsat 7 to EOS Program
- fly ETM+ type instrument on AM-2 (avoiding cost of Landsat 8 launch and spacecraft)
- cancel EOS Color
- phase some of the processing and archiving of EOS standard products

The Reshape Process (June 1995)

Purpose:

- respond to need to redefine NASA's approach to accomplishing ESE objectives in the post-2000 era while maintaining cost cap

Guiding Principles:

- EOS program to fit within a \$1 billion annual cost cap
- EOS program to end in the year 2019
- NASA/NOAA cooperation to increase
- Some EOS missions to be designated "monitoring" and others "process study" missions
- establish 24 EOS measurement-set concept

Outcome:

- advanced MODIS and advanced MISR will fly on AM-2
- CHEM-2 mission will be split into a monitoring and a process study mission

- new PM-2A mission will be designed to complement the National Polar-orbiting Operational Environmental Satellite System (NPOESS) C-1 mission
- second series of EOS missions will incorporate advanced technology developments from the New Millennium Program (NMP)
- third series of EOS missions will be "continuity missions" and will also feature missions from NMP

The Biennial Review of ESE (1997)

Purpose:

- to institute regular assessments of the entire ESE, starting in 1997, with results in time to shape the development of the FY 1999 budget request

Guiding Principles:

- the scientific objectives of the Earth Observing System remain the same; what is evolving is the strategy for implementation and the integration of EOS with other elements of ESE
- better capitalize on advances in science and technology and identify opportunities for new and expanded collaborations with commercial, international, and interagency partners
- enable a fundamentally different and vastly more flexible means of planning and implementing Earth System Science missions

Outcome:

- Atmospheric Chemistry Review Panel established; recommended use of Common Spacecraft for CHEM-1 mission
- indefinite quantity, indefinite delivery or "catalog" policy adopted for procurement of small commercial spacecraft
- ICESat-1 mission spacecraft will be a "catalog" procurement with Geoscience Laser Altimeter System (GLAS) instrument developed on parallel path; this approach leads to acceleration of mission by nine months and cost saving of \$30 million

EOSDIS Core System

- enhanced role and responsibilities established for the Data Processing Resources Board
- EOSDIS Review Group (ERG) established; all satellite data to be processed to Level 1 with ramp up to Level 2/3 in a pattern of 25-50-75-100% over the first four years of EOS missions; production of interdependent data sets to be phased in over period of two years; prototype EOSDIS Federation Experiment to proceed as planned

Program Balance

- Research and Analysis (R & A) funding to be restored to about FY 94 level as part of decision to improve ESE program balance

- responsibility and budget for validation activities moved to Science Division at NASA Headquarters
- Science Implementation Plans are to be developed by responsible teams as the basis for planning future ESE missions and technology investments responsive to each of the ESE spheres of research activity

Technology Infusion Strategy

- new, more-flexible strategy adopted for planning post-2002 missions
- “just in time” implementation planning and decision-making strategy adopted for future EOS missions and the acquisition of data
- technology development efforts to be based on science needs
- technology development must support more-efficient and cost-effective instrument implementation that will shorten mission development cycles
- development and infusion of advanced technologies will be pursued through the ESE Core Technology Program, the ESE New Millennium Program (NMP), the ESE Instrument Incubator Program (IIP), and related NASA activities in High Performance Computing and Communications and Small Business and Innovative Research (SBIR)

Implementation of ESE Program after 2002

- instrument and spacecraft development can be decoupled, thus proceeding on parallel paths
- smaller launch vehicles commercially available can be used
- technology development efforts can be focused on advanced instruments
- specific mission identification not required until as late as three years prior to launch
- data from one mission can be evaluated in time to make decisions for a follow-on continuity mission
- different approaches can be adopted for “monitoring” vs. “process” measurement missions (monitoring missions require continuity of measurements over longer mission lifetimes whereas process measurements can be flown in quick-turnaround, shorter lifetime missions)
- new project management approaches are possible
- “catalog” spacecraft procurements may be made
- instrument development may be entrusted to a PI or a Team Leader (for Facility Instruments)
- science missions may be managed end-to-end (PI model) by a Principal Investigator responsible for implementing the complete mission
- partnerships for supplying instruments, spacecraft, launch vehicles, or entire missions can be established in conjunction with commercial, interagency, and international entities
- new instrument technologies can be funded through the Instrument Incubator Program (IIP), and instrument development can follow through the IIP, the ESE core program, the New Millennium Program, or SBIR

Outreach and Partnerships

- new partnership opportunities have been identified: several proposed industrial ventures involving commercially owned and operated satellite systems may supply some of the land cover and ocean productivity measurements required at the end of the lifetime of the Terra mission
- the tri-agency NPOESS may offer the best opportunity for long-term monitoring of some climate parameters

Conclusion

- the first Biennial Review brought closure to several program-level issues in the EOS 1st series, and it provided the first look into the future of ESE beyond 2002; the Biennial Review set the tone for a new ESE strategy for planning future missions—one more flexible, more responsive to science needs, and more accommodating of partnerships

The Current Status of the Program

Current mission schedules are illustrated in Figures 3 and 4 and Table 5 for the first series of Earth Science missions, including EOS, NMP, and ESSP missions. The resulting data communication requirements are shown in Table 6. Program flight elements to 2006 are illustrated in tables in the International Cooperation section. These illustrations show that AM-1 has been renamed Terra; the recommended split of altimetry missions between radar and laser has been adopted; TES is to be accommodated on EOS CHEM; an Advanced Land Imager (ALI) is to be flown in a technology-validation mode on the first NMP/EO-1 mission; and a flight of SAGE III on the International Space Station has been incorporated.

The rebaselining process introduced another category of risk to the EOS Program. The intended lifetime design of all EOS instruments is 5 years while the replacement cycle is 6 years. This means, barring any launch failures, EOS instruments must operate at least one year longer to provide continuity of observations throughout the 15-year period. (The calibration strategy requires an additional 6 months of overlap between instruments on different satellites to allow their intercalibration.)

More details concerning the status of the EOS and related Earth Science Program appear in the Mission Elements section of this Handbook.

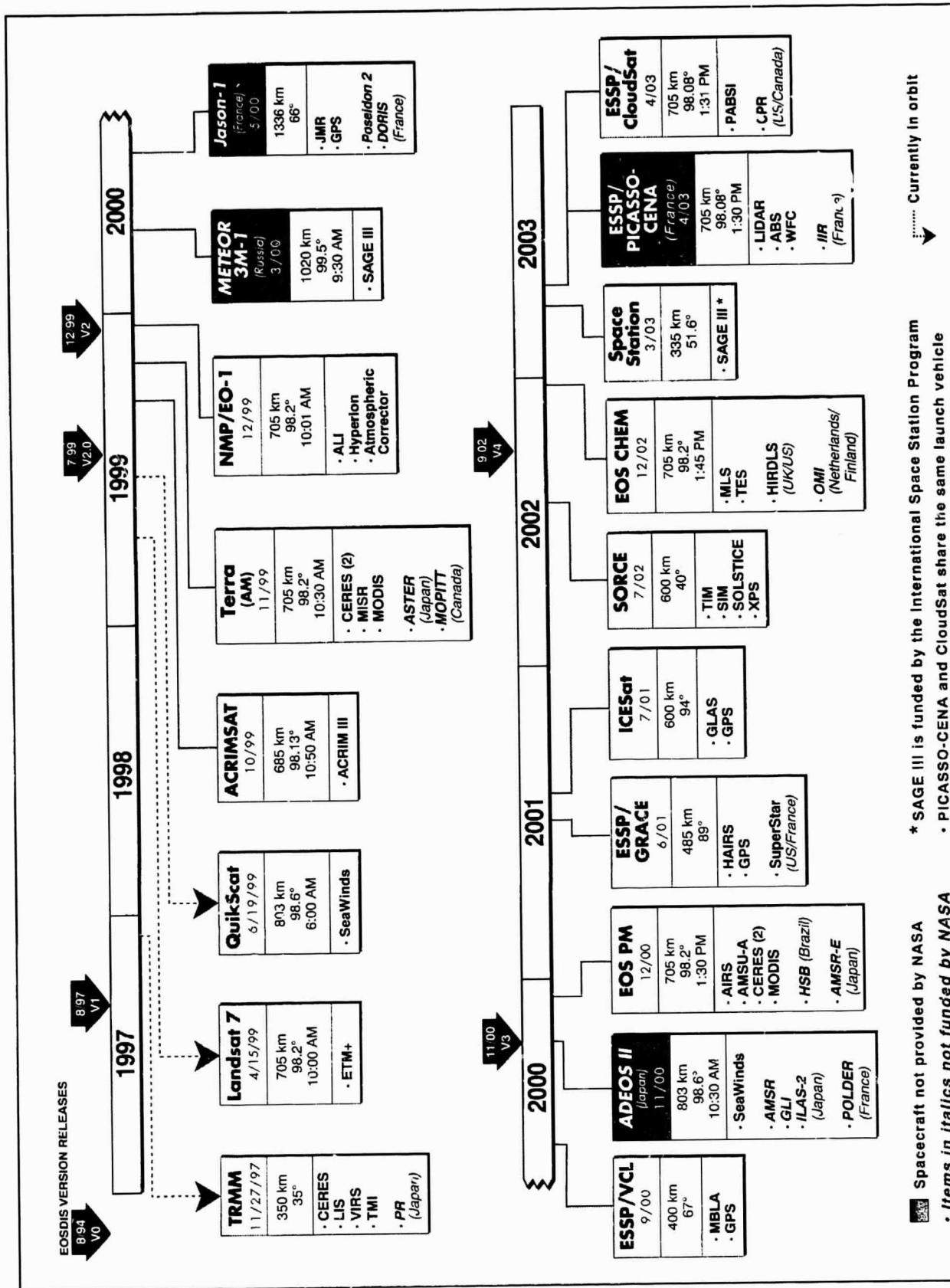
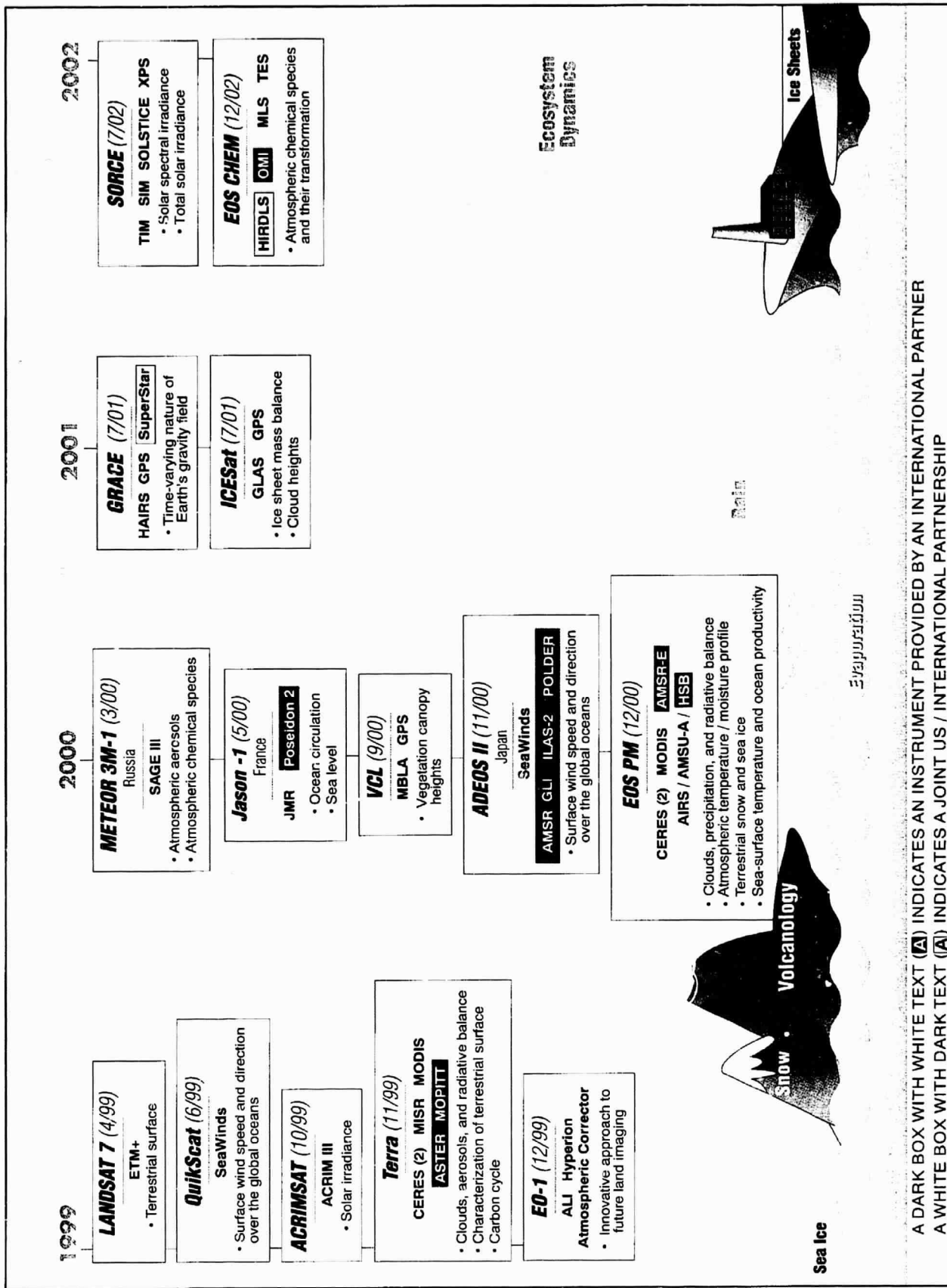

Figure 3. Earth Science Mission Profile



Launch	Spacecraft	Lifetime	EOS, NMP, and ESSP Instrument Complement	See Notes
1997	TRMM	3 yrs	CERES • LIS	1
1999	Landsat 7	5 yrs	ETM+	
1999	Terra	6 yrs	MODIS • MISR • CERES (2) • MOPITT • ASTER	2,3
1999	QuikScat	3 yrs	SeaWinds	
1999	ACRIMSAT	5 yrs	ACRIM III	5
1999	METEOR 3M-1	3 yrs	SAGE III	
1999	NMP/EO-1	1 yrs	ALI • Hyperion • Atmospheric Corrector	4
2000	Jason-1	5 yrs	JMR • Poseidon 2 • DORIS • GPS	
2000	ESSP-1/VCL	2 yrs	MBLA • GPS	6
2000	ADEOS II	5 yrs	SeaWinds	7
2000	EOS PM	6 yrs	MODIS • AMSR-E • CERES (2) • AIRS • AMSU-A • HSB	2
2001	ESSP-2/GRACE	5 yrs	HAIRS • GPS • SuperStar	6
2001	ICESat	3 yrs	GLAS • GPS	
2002	Space Station	5 yrs	SAGE III	
2002	SORCE	5 yrs	TIM • SIM • SOLSTICE • XPS	5
2002	EOS CHEM	6 yrs	MLS • TES • HIRDLS • OMI	
2003	ESSP-3/ PICASSO-CENA	3 yrs	LIDAR • ABS • WFC • IIR	6
2003	ESSP-4/ CloudSat	2 yrs	PABSI • CPR	6

Notes:

1. TRMM is a joint U.S./Japan mission, launched November 28, 1997. It also flies a Precipitation Radar (PR), TRMM Microwave Imager (TMI), and Visible/Infrared Scanner (VIRS).
2. AIRS, AMSU-A, HSB, AMSR-E, and MODIS data available via direct broadcast (X band).
3. ASTER data available via direct downlink.
4. The New Millennium Program (NMP) is charged to develop and flight-validate breakthrough technologies that will reduce the cost of high-priority science missions of the 21st Century while enhancing their scientific capability. During the first year, the Advanced Land Imager (ALI), including the Hyperion, will be subjected to a technology validation. If the results are promising, operations will continue for a second year of data utilization.
5. Series of ACRIM, SORCE, or similar missions planned to maintain continuity in the total solar irradiance data set for at least 15 years.
6. The Earth System Science Pathfinders (ESSP) program is designed to explore the Earth's dynamic systems and to achieve maximum science value while complementing existing or planned flight missions. The Principal Investigator is responsible for developing the flight mission hardware from selection to a launch-ready condition within 36 months, and along with the mission team is responsible for accomplishing the science objectives.
7. ADEOS II is a Japanese mission. It will also fly an Advanced Microwave Scanning Radiometer (AMSR), a Global Imager (GLI), a Polarization and Directionality of Earth's Reflectances (POLDER) instrument, and an Improved Limb Atmospheric Spectrometer (ILAS-2).

Table 5. EOS, NMP, and ESSP Instrument Complement: Phase I

EOS Instrument	1997	1998	1999	2000	2001	2002	2003	Platform Average Data Rates
ACRIM III								➤ Terra
AIRS								17.848 Mbps
ALI								➤ Landsat 7
AMSR-E								12.963 Mbps
AMSU-A								➤ EOS PM
ASTER								7.755 Mbps
CERES			3	3	5	4	4	➤ EOS Chem
CloudSat								5.856 Mbps
Poseidon-2								➤ ICESat
ETM+								0.450 Mbps
GLAS								➤ METEOR 3M
GRACE								(SAGE III)
HIRDLS								0.024 Mbps
HSB								➤ Space Station
JMR								(SAGE III)
LIS								0.024 Mbps
MISR								➤ ADEOS II (SeaWinds)
MLS								0.040 Mbps
MODIS					2	2	2	➤ QuikScat (SeaWinds)
MOPITT								0.040 Mbps
OMI								➤ TRMM (CERES & LIS)
PICASSO-CENA								0.016 Mbps
SAGE III					2	3	2	➤ Jason-1
SeaWinds				2	2			0.024 Mbps
SORCE								➤ SORCE
TES								0.007 Mbps
VCL								➤ ACRIMSAT
Average Data Rate Mbps	0.016	0.016	30.9	38.7	39.1	45.0	44.9	➤ NMP/EO-1
Instruments in Flight	2	2	13	21	24	28	28	105 Mbps (See Note 3)
								➤ ESSP (VCL, GRACE, PICASSO-CENA, CloudSat)
								(See Note 4)

Notes:

1. Numbers in timeline bars indicate copies in orbit once the instruments have commenced routine operations.
2. The "Instruments in Flight" entry is the maximum number of instruments operating at the same time during the year. For example, there will be 3 CERES instruments operating after the launch of Terra in 1999 when the following missions overlap: TRMM (1 CERES) and Terra (2 CERES). (See Figure 3.)
3. The average data rate of the ALI instrument is 105 Mbps. However, only 4 snapshots are taken each day and their total readout time is only about 30 minutes. Hence, this data rate is NOT included in the total Average Data Rate because it would present a grossly-distorted picture of the actual value over 24 hours.
4. The ESSP (VCL, GRACE, PICASSO-CENA, and CloudSat) missions are not formally part of the EOS Program and their data processing is performed at separate facilities.

Table 6. EOS and NMP Platform Instrument Counts and Data Rates

Contributions of ESE and EOS to National Objectives

In pursuit of U.S. policy relative to global change, ESE undertakes observations from space and performs interdisciplinary science studies to interpret and apply these observations. Integrated and conceptual models, substantiated by space-based observations, have already provided policymakers with a firm basis for making sound environmental policy decisions related to substances that deplete the ozone layer (e.g., the Montreal Protocol on Substances that Deplete the Ozone Layer adopted in 1987). In the EOS era, the corresponding challenges include prediction of El Niño events, the implications of increased emissions of greenhouse gases for global warming, and impacts of land-cover change on the carbon budget, biodiversity, and agricultural productivity. Fuller discussion of these challenges is found in the EOS Science Strategy document and the EOS Science Plan (see References at the end of this section).

A basic question that must be resolved before policy decisions can be reached has to do with determining whether changes now being observed throughout the world are systematic (relatively persistent long-term changes) or just part of normal climatic variability. If the changes being observed are in fact systematic, are they sufficiently significant in impact to warrant action by policymakers? Do we know well enough whether the observed changes are attributable to human activities? Are

appropriate technological alternatives or restrictions on human activities available to mitigate the changes or their impacts, and is it reasonable to impose such restrictions? Are the consequences of imposing restrictions more damaging to our quality of life (e.g., because of major disruptions in the world's economy) than the anticipated changes in the global climate system?

The physical-modeling and data-gathering activities over the planned 15 or more years of the EOS Program are intended to make a major contribution to establishing the distinction between natural variability in the Earth system and changes that are introduced by human activities. The choices of intervention strategies to mitigate possible undesirable changes or their impacts will have to be based at least in part on the findings of ESE- and EOS-supported scientists in the U.S. and their counterparts around the world.

ESE offers a new perspective on the functioning of planet Earth through coordinated, long-term, space-based and in situ observations, and a program of interdisciplinary research addressing priority issues of Earth system science. This Presidential Initiative is supported by Congress, which granted NASA a "new start" budget line item for the EOS Program in 1990. Following this mandate from the Administration and Congress, NASA has placed itself at the forefront of Earth observing satellite technology development and data management. The improved measurement and modeling capabilities that result directly support the U.S. and international global change research

IPCC Category	EOS Instrument Complement
Sources of greenhouse gases, which affect predictions of their future concentrations	AIRS/AMSU-A/HSB, HIRDLS, MLS, MODIS, MOPITT, OMI, SAGE III, and TES
Clouds and radiative balance, which strongly influence the magnitude of climate change at global and regional scales	ACRIM III, AIRS/AMSU-A/HSB, CERES, EOSP, AMSR-E, MISR, MODIS, and SORCE
Oceans, which influence the timing and patterns of climate change	JMR, AMSR-E, MODIS, SeaWinds, and Poseidon-2
Land surface hydrology, which affects regional climate change and water availability	AIRS/AMSU-A/HSB, ASTER, ALI, ETM+, AMSR-E, MISR, and MODIS
Polar ice sheets, which affect predictions of global sea level changes	ASTER, JMR, ETM+, GLAS, AMSR-E, MODIS, and Poseidon-2
Ecological dynamics, which is affected by, and responds to, climate change	AIRS/AMSU-A/HSB, ASTER, ETM+, ALI, MISR, and MODIS

Table 7. Links to IPCC Areas of Uncertainty

programs, and reinforce the U.S. position as a world leader in space-based remote sensing.

The successive reconfigurations of the EOS payloads have had both benefits and pitfalls; yet, in the prevailing budget environment, decisionmakers have had to balance the science return against costs incurred. Any further rearrangements will require review by the EOS IWG to determine if they represent an acceptable solution towards satisfying the identified IPCC science and policy priorities (see Table 7). Furthermore, the potential of achieving the international commitments assumed in the rebaselined program must be quantified to determine the consequences of data gaps should these collaborations not be realized.

References

EOS—Science Strategy for the Earth Observing System, by Ghassem Asrar and Jeff Dozier, published by AIP Press, July 1994. This publication provides a broad overview of the EOS Program, stressing the scientific considerations that led to the definition of the overall program as an essential element of the U.S. Global Change Research Program (USGCRP).

Science Data Plan for the EOS Data and Information System, 1994, Matthew Schwaller and Brian Krupp, editors. Available from the EOS Library, Code 505, Goddard Space Flight Center, Greenbelt, MD 20771. This publication describes the management approach as well as current and projected holdings of the EOS Data and Information System (EOSDIS) at the various Distributed Active Archive Centers around the United States.

The EOSDIS Data Products Handbook, Volume 1, provides high-level descriptions of the data sets that will be produced from instruments on the Tropical Rainfall Measuring Mission (TRMM) and Terra satellites. It highlights the significance, evolution, and application of the data products at a level intended for the general science public as well as for researchers. It is available from the Global Change Data Center, Code 902, Goddard Space Flight Center, Greenbelt, MD 20771.

Earth Observing System Output Data Products and Input Requirements, Version 4.0, May 1996. Available from the Earth Science Data and Information System Office, Code 505, Goddard Space Flight Center, Greenbelt, MD 20771. It lists all at-launch and post-launch data products planned by EOS instrument teams, gives information on the characteristics of each parameter, required input data, and processing load estimates. (<http://spsosun.gsfc.nasa.gov/eosdata.html>).

The EOS Contribution to National Goals (edited by E. Barron, D. Hartmann, D. Schimel, and M. Schoeberl), is a product of the EOS Investigators Working Group. It relates the activities, goals, and intended products of EOS

to the requirements for the scientific insights needed for national policy making.

The *EOS Science Plan*, also a product of the EOS Investigators Working Group, appears in two volumes: The Executive Summary (edited by Renny Greenstone and M.D. King) and the Science Plan, proper (edited by M.D. King). It is an in-depth presentation of the studies being conducted by the investigators who form the scientific core of EOS. The nature of the scientific problems is described; the plans for meeting these problems through acquisition of in situ and remote-sensing observations and through analyses are given; and there are expositions of the products that are anticipated as a result of the analyses. Both the "National Goals" document and the *EOS Science Plan*, as well as a CD-ROM version of the *EOS Science Plan*, are available through the EOS Project Science Office (EOSPSO).

The World Wide Web (WWW) is an excellent electronic source of EOS information. The following documents are currently available on the Web (<http://eos.nasa.gov/>) and others will be made available as they are published:

The Earth Observer is a bimonthly newsletter of the EOSPSO. It gives current reports on the status of various elements of the EOS Program.

Payload Panel Reports are a key source of understanding the recommendations that have been made by this key group of EOS scientists for devising the payloads of the various EOS spacecraft missions that will best meet scientific and budgetary requirements of the Program.

Algorithm Theoretical Basis Documents (ATBDs) are being developed for every EOS instrument standard product, although some ATBDs address more than one product, and some products are addressed by more than one ATBD. ATBDs typically provide the theoretical basis—both the physical theory and the mathematical procedures and possible assumptions being applied—for the calculations that have to be made to convert the radiances acquired by the instruments to geophysical quantities. The geophysical quantities are then available to the scientific community for studies of the various characteristics of the Earth system.

The EOS Directory lists the addresses, affiliations, phone numbers, and electronic mail addresses, as well as assignments of EOS-related personnel. It is searchable at the URL listed below and is not available in printed form.

EOS Project Science Office URL

<http://eos.nasa.gov/>

Page intentionally left blank

EOS Data and Information System (EOSDIS)

More than any other factor, the commitment to make Earth science data easily available to a wide community of users is critical to the success of NASA's Earth Science Enterprise. The EOS Data and Information System (EOSDIS) is being developed, with an initial version called Version 0 operating now to meet that commitment.

At present, EOSDIS manages data from NASA's past and current Earth science research satellites and field measurement programs, providing data archiving, distribution, and information management services. During the EOS era that started with the launch of the TRMM satellite in 1997, EOSDIS will command and control satellites and instruments, and will generate useful products from orbital observations. EOSDIS will also generate data sets made by assimilation of satellite and in situ observations into global climate models. Several steps are being taken to increase flexibility in EOSDIS by distributing the responsibility for provision of its various services. In the near-term, the data assimilation products, the data products from the EOS instruments on TRMM, from some of the Terra instruments, and from SAGE III will be generated either at the Principal Investigators' computing facilities or under their direct control. An adaptive approach will be used during the EOS PM-1 era to determine the best assignment of responsibility for product generation considering technical advantages, cost, and schedule. An experiment is now underway with a set of competitively selected "Working Prototype Earth Science Information Partners (WP-ESIPs)" to examine the feasibility of providing data services through a federation of ESIPs. Such a federation could provide an additional measure of flexibility in distributing the responsibilities during the EOS CHEM era.

Services Provided by EOSDIS

EOSDIS is a comprehensive data and information system designed to perform a wide variety of functions in support of a heterogeneous national and international user community. To this end, EOSDIS provides a spectrum of services: some services are intended for a diversity of casual users, some are intended only for a select cadre of research scientists chosen by NASA's peer-reviewed competitions, and many fall somewhere in between these extremes. The entities providing these services may vary

over time as a result of implementing the adaptive approach and the WP-ESIP federation experiment. The primary services provided by EOSDIS are summarized below:

User Support – The vast majority of people who interact with EOSDIS will do so via the EOSDIS Distributed Active Archive Centers (DAACs). The functions of the DAACs are described in more detail in a following section, and details about each DAAC are provided in a subsequent section. The DAACs have User Support Services to assist users in data acquisition, search, access, and usage. While most of the interaction by users with EOSDIS is through human-computer interfaces, occasional consultation will be needed with the User Support Services staff for assistance with specialized questions regarding the data or the system. EOSDIS expects to provide support services to users from the public and private sectors, including research scientists, educators, students, users in public agencies responsible for operational applications such as weather forecasts and environmental monitoring, policymakers, and the public in general (see Table 8 for a listing of DAAC contact information).

Data Archive, Management, and Distribution – A list of current and projected EOSDIS data holdings is available in the EOSDIS Science Data Plan (see References at the end of this section). Overall, this list includes data products derived from the satellite missions and scientific campaigns, plus other related data and information. In the EOS era, EOSDIS will store all the standard and special products computed from the EOS instruments during the mission life, and distribute requested subsets to users either electronically (via networks) or on appropriate media. In addition, EOSDIS will store and distribute data from non-EOS sources that are needed for EOS standard product generation. Also, product generation algorithms, software, documentation, calibration data, engineering, and other ancillary data will be stored and provided to users upon request. Sufficient information will be stored about the system configuration history to be able to regenerate products in case of accidental or catastrophic loss. Access to the current suite of EOSDIS data holdings may be obtained via the DAACs.

Preceding Page Blank

DAAC & Discipline	Address	User Support Office Contact Information
ASF Sea Ice, Polar Processes, Synthetic Aperture Radar Imagery (SAR)	Alaska SAR Facility, User Services PO Box 757320 University of Alaska Fairbanks, AK 99775-7320	<i>E-mail:</i> asf@eos.nasa.gov, usof@asf.alaska.edu <i>Tel:</i> 907-474-6166 <i>Fax:</i> 907-474-5195 <i>URL:</i> http://www.asf.alaska.edu/
EDC Land Processes	United States Geological Survey EROS Data Center Sioux Falls, SD 57198	<i>E-mail:</i> edc@eos.nasa.gov <i>Tel:</i> 605-594-6116 <i>Fax:</i> 605-594-6963 <i>URL:</i> http://edcwww.cr.usgs.gov/landdaac/
GSFC Upper Atmosphere, Global Biosphere, Atmospheric Dynamics	NASA/Goddard Space Flight Center Code 902.2 Greenbelt, MD 20771	<i>E-mail:</i> gsfcc@eos.nasa.gov <i>Tel:</i> 301-614-5224 <i>Fax:</i> 301-614-5268 <i>URL:</i> http://daac.gsfc.nasa.gov/
JPL Physical Oceanography	Jet Propulsion Laboratory M/S Raytheon-299 4800 Oak Grove Drive Pasadena, CA 91109	<i>E-mail:</i> jpl@eos.nasa.gov, podaac@jpl.nasa.gov <i>Tel:</i> 626-744-5508 <i>Fax:</i> 818-393-2718 <i>URL:</i> http://podaac.jpl.nasa.gov/
LaRC Radiation Budget, Clouds, Aerosols, Tropospheric Chemistry	NASA/Langley Research Center Mail Stop 157D 2 South Wright Street Hampton, VA 23681-2199	<i>E-mail:</i> larc@eos.nasa.gov <i>Tel:</i> 757-864-8656 <i>Fax:</i> 757-864-8807 <i>URL:</i> http://eosweb.larc.nasa.gov/
NSIDC Snow and Ice, Cryosphere and Climate	National Snow and Ice Data Center CIRES, Campus Box 449 University of Colorado Boulder, CO 80309-0449	<i>E-mail:</i> nsidc@eos.nasa.gov, nsidc@kryos.colorado.edu <i>Tel:</i> 303-492-6199 <i>Fax:</i> 303-492-2468 <i>URL:</i> http://www.nsidc.colorado.edu
ORNL Biogeochemical Dynamics	Oak Ridge National Laboratory (ORNL) Environmental Sciences Division PO Box 2008, MS 6407, Bldg. 1507 Oak Ridge, TN 37831-6407	<i>E-mail:</i> ornl@eos.nasa.gov, ornlcaac@ornl.gov <i>Tel:</i> 423-241-3952 <i>Fax:</i> 423-574-4665 <i>URL:</i> http://www-eosdis.ornl.gov
SEDAC Human Impact on Global Change	Socioeconomic Data and Applications Center Columbia Univ./Lamont-Doherty Earth Observatory P.O. Box 1000, 61 Rt. 9W Palisades, NY 10964	<i>E-mail:</i> ciesin.info@ciesin.org <i>Tel:</i> 914-365-8988 <i>Fax:</i> 914-365-8922 <i>URL:</i> http://www.ciesin.org http://sedac.ciesin.org , http://www.ciesin.org

Table 8. EOS Distributed Active Archive Centers

Information Management – EOSDIS provides convenient mechanisms for locating and accessing (either electronically or via orders for data on media) products of interest. The ‘look and feel’ of the system is intuitive and uniform across the multiple nodes from which EOSDIS will be accessed. EOSDIS will facilitate collaborative science by providing extensible sets of tools and capabilities such that investigators may provide access to special products (or research products) from their own computing facilities. EOSDIS has a currently operational EOS Data Gateway that provides “one-stop-shopping” access to the data holdings at all the EOSDIS DAACs and participating data centers from other U.S. and international agencies. The services of the V0 IMS can be accessed on the World Wide Web at <http://eos.nasa.gov/imswelcome>. The V0 IMS permits users to access EOSDIS archives, browse data holdings, select data products or their subsets (for products where the capability is available), and place data orders. In addition, specialized services at each of the EOSDIS DAACs can be accessed via their individual interfaces. The latest information about the features of, and access to, Version 0, and links to information about individual DAACs, is available through the following World Wide Web location: <http://eos.nasa.gov/v0ims>.

Product Generation – Beginning with the TRMM launch in 1997, EOSDIS has started supporting data product generation from EOS instrument observations. Algorithms and software for EOS data products are generated by EOS investigators as a part of their scientific studies. Specifications for standard products are reviewed by NASA and the EOS Investigators Working Group (IWG) to ensure completeness and consistency to satisfy the goals of the EOS mission. The physical, chemical, and biological bases for these products and soundness of approach for their generation are peer reviewed independently by non-EOS Earth scientists prior to the launch of each instrument. Priorities for the processing and reprocessing needed to generate standard products depend on scientific requirements, technical considerations, and cost. Such priorities are determined by the EOS Project Scientists based on recommendations from the IWG and the national and international Earth science community.

Spacecraft Command and Control – EOSDIS will perform spacecraft and instrument planning and scheduling, and command and control. These functions include processing data acquisition requests, coordination of multi-instrument observations, ensuring that the commands generated are valid and within resource constraints, monitoring and maintenance of the health and safety of spacecraft and instruments, engineering analysis of spacecraft data, and maintaining history of spacecraft and instrument operations. EOSDIS will also provide appropriate interfaces to ensure command and control of International

Partners’ instruments onboard EOS spacecraft, and EOS instruments onboard non-EOS spacecraft.

Data Capture and Telemetry Processing – In the EOS era, EOSDIS will capture data from all EOS spacecraft and process them to remove telemetry errors, eliminate any artifacts, and create Level 0 data products that are “raw” data as measured by the instruments (see the end of this section for data level definitions). Several of the EOS instruments are designated as prototype operational environmental monitoring instruments. The data from those instruments will be made available to NOAA within three hours of observation to support operational weather forecasts. For EOS instruments flying on non-EOS spacecraft, the EOS instrument data are captured by the respective ground systems and received by EOSDIS for higher-level data processing, archiving, and distribution.

EOSDIS Components

NASA is implementing EOSDIS using a distributed, open system architecture. This permits allocation of EOSDIS elements to various locations to take best advantage of different institutional capabilities and science expertise. EOSDIS consists of six major components—Distributed Active Archive Centers, Science Investigator-led Processing Systems, the EOSDIS Core System, Networks, EOS Data and Operations System, and EOS Polar Ground Stations. These components and their relationship to other elements are illustrated in Figure 5.

The following paragraphs provide details of each of the major components. The sequence of presentation does not imply prioritized ranking. Each component is essential in the successful implementation of EOSDIS.

Distributed Active Archive Centers (DAACs) – Seven DAACs representing a wide range of Earth science disciplines have been selected by NASA to carry out the responsibilities for processing, archiving, and distributing EOS and related data, and for providing a full range of user support. An eighth DAAC acts as a link between the EOS Program and the socio-economic and educational user community. The geographic distribution of the DAACs is illustrated in Figure 6. These institutions are custodians of EOS mission data, and ensure that data will be easily accessible to users. Acting in concert, DAACs provide reliable, robust services to users whose needs may cross traditional discipline boundaries, while continuing to support the particular needs of their respective discipline communities. DAAC assignments were based primarily on the current distribution of scientific expertise, institutional heritage, and capability. The DAACs are currently serving a broad user community using the capabilities of Version 0 EOSDIS (see subsection below) developed collaboratively with the Earth Science Data and

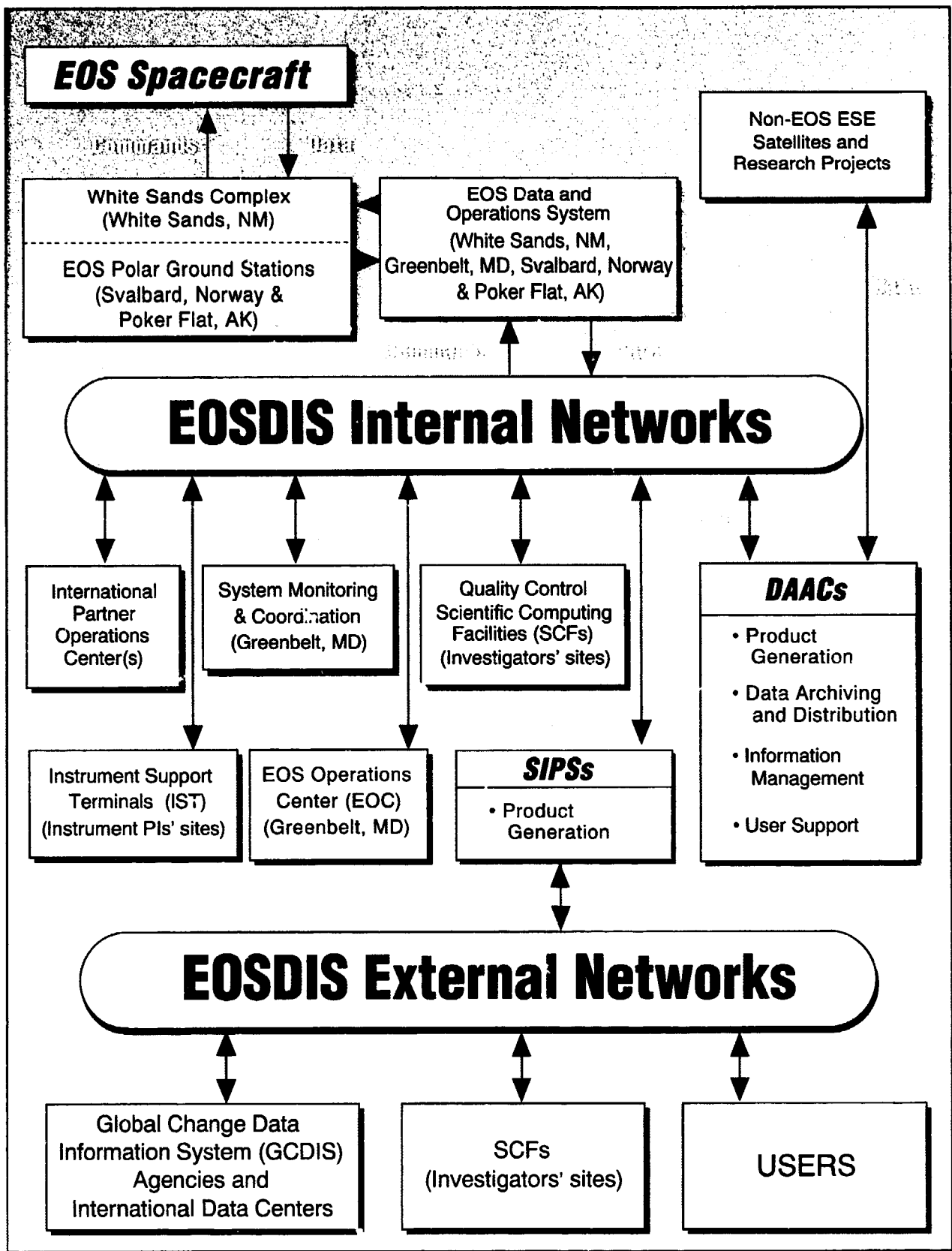

Figure 5. EOSDIS Architecture

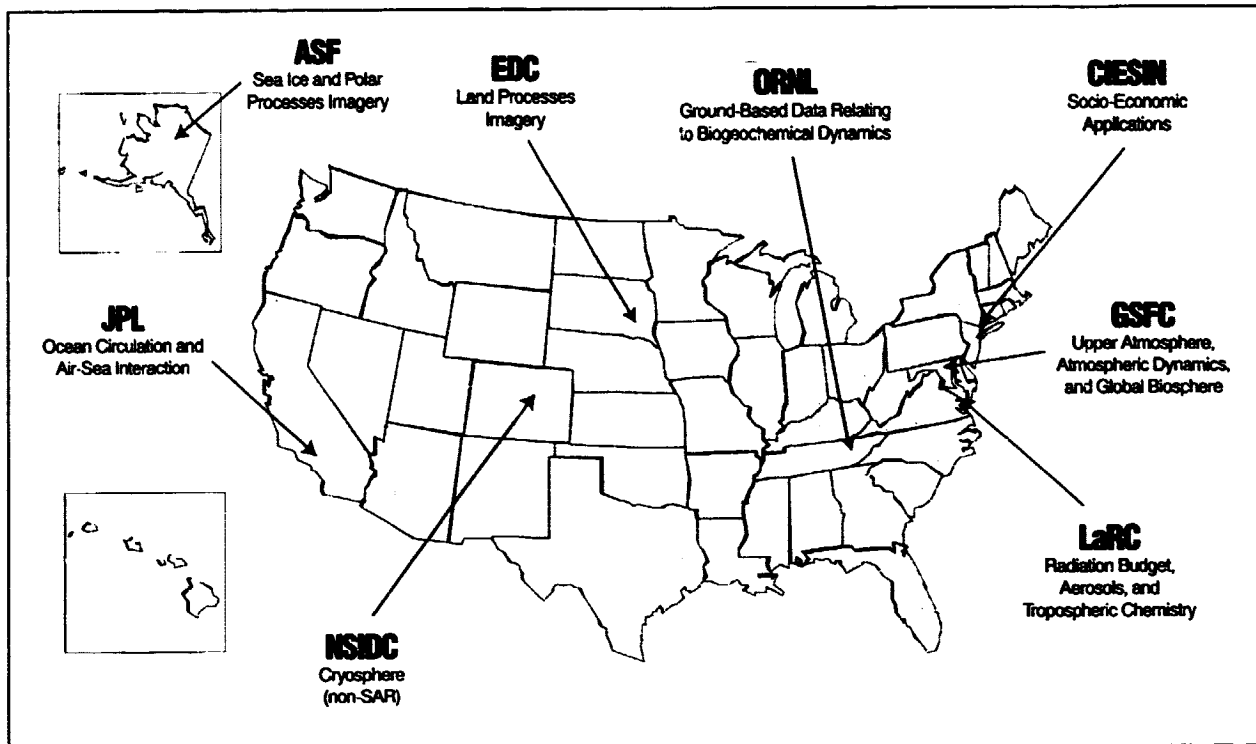

Figure 6. Geographic Distribution of EOSDIS DAACs

Information System (ESDIS) Project. As future versions of EOSDIS are developed, the DAACs will continue to provide their services to the user community using capabilities of the Science Data Processing Segment of the EOSDIS Core System (see subsection below) and may develop unique capabilities to augment them. Each DAAC has a working group of users to provide advice on priorities for scientific data, levels of service, and the needed capabilities. The DAACs actively participate in the design, implementation, and operation of EOSDIS.

Science Investigator-led Processing Systems (SIPs) – In addition to the DAACs, there are other facilities at which EOS standard products are produced. These facilities are under the direct control of the instrument Principal Investigators/Team Leaders or their designees and are referred to as Science Investigator-led Processing Systems. The SIPs are generally, but not necessarily, collocated with the PI's/TL's Scientific Computing Facilities. Under the recently adopted "adaptive approach" to data processing, the production of standard data products is allocated among DAACs (using the EOSDIS Core System) and SIPs based on cost-benefit analyses. Products produced at the SIPs using investigator-provided systems and software will be sent to appropriate DAACs for archival and distribution.

EOSDIS Core System (ECS) – ECS provides the "core" common capabilities and infrastructure required for performing planning and scheduling, command and control, product generation, information management, data archiving and distribution, and user access to data held by EOSDIS. ECS consists of three segments described below: the Science Data Processing Segment, the Flight Operations Segment, and the Communications and System Management Segment.

Science Data Processing Segment (SDPS) – SDPS supports product generation, data archiving and distribution, and information management. The SDPS hardware and software, developed as a part of ECS, will reside and operate at the DAACs. SDPS supports the integration and testing of software for product generation algorithms developed by the EOS investigators. It provides for planning of data product generation, taking into account interdependencies among them, and the distribution of computational resources. It provides for ingest and storage (temporary or permanent, depending on data type) of data sets needed from other data centers for supporting the generation of standard data products. It generates standard products in a timely manner using the investigator-provided software. It supports the extraction of appropriate subsets of stan-

standard data products to assist in scientific quality control by the respective investigators. It supports reprocessing as required.

Flight Operations Segment (FOS) – FOS controls all of the EOS spacecraft, provides mission planning and scheduling, and monitors health and safety of the spacecraft and instruments. It provides tools to coordinate observations from multiple instruments and develop conflict-free schedules, validate commands to assure safety, accommodate unplanned schedule changes, develop and provide mission timelines, and develop and implement contingency plans. It interacts with the various elements of the ground systems and space network as necessary to send commands to the EOS spacecraft and to receive health and safety data from the spacecraft. It interacts with the International Partners' instrument control centers for exchange of planning and command and control information. The FOS is presently being implemented using a combination of a commercial mission control system and custom software to constitute the EOS Mission Operations System (EMOS).

Communications and System Management Segment (CSMS) – CSMS provides the communications, networking, and system management functions needed by the SDPS and FOS. It provides the capabilities for the DAACs to perform local system management functions and the capabilities for cross-DAAC coordination and monitoring to ensure autonomous, yet coordinated, operation of SDPS. It provides for monitoring and maintaining status information about EOSDIS. It provides common services such as request brokering, client/server communications, electronic mail, bulletin boards, local-area and wide-area networks, system security, accounting, user registration, and report generation.

EOS Data and Operations System (EDOS) – EDOS transmits commands to the EOS spacecraft, captures science and engineering data from the spacecraft and instruments, processes telemetry to generate Level 0 products, and maintains a backup archive of Level 0 products. It removes telemetry artifacts, creates sets of non-overlapping raw data as sensed by the individual instruments over specific time intervals, and sends them to the appropriate DAACs for generation of higher level products. In the case of a data loss at any of the DAACs, the data can be recovered from the backup archive within EDOS. In the case of loss of a part of the backup Level 0 data within EDOS, the corresponding data can be recovered from the appropriate DAAC.

EOS Networks – Effective access to EOSDIS depends on network connectivity between users and data sources. Existing and evolving network capabilities in the U.S.

and abroad will be used to satisfy the connectivity needs. These capabilities include the NASA Integrated Services Network (NISN), its connections to the National Science Foundation (NSF) Internet, and the NASA Research and Education Network (NREN) as it develops. Connectivity to the EOS investigators' scientific computing facilities (SCFs) is being established, based on existing connectivity and need. The SCFs that are involved in the quality control of standard data products will be provided the appropriate connectivity and bandwidth to ensure timely data transfers to meet their requirements. The DAACs, ECS, and EDOS are connected through the EOS Backbone Network (EBNet) to assure security, timeliness, and predictable response. The EBNet is a dedicated EOS resource that interconnects the DAACs to support inter-DAAC data flows for generation of interdependent EOS products and to provide secure, reliable communications to uplink commands to the EOS spacecraft and to move Level 0 instrument data to the DAACs.

EOS Polar Ground Stations – The EOS Polar Ground Stations (EPGS) provide X-band capabilities for receiving science data dumps and S-band Tracking, Telemetry and Commanding (TT&C) capabilities for Landsat 7, EOS, and other ESE spacecraft. There are two polar ground stations, one in Svalbard, Norway and the other in Poker Flat, Alaska. These stations include several major architectural components: the radio-frequency subsystem, base-band data-processing subsystem, monitor and control subsystem, and commercial telecommunication subsystem. The stations also house ground-system interface facilities that are a part of EDOS.

EOSDIS Architecture

Since EOSDIS will be NASA's central Earth science data system for at least the next two decades, it must evolve to accommodate changes in technology, user requirements, and user interactions with data and data systems. To reach this end, EOSDIS planning has been significantly influenced by reviews from the EOSDIS Panel, the National Research Council's (NRC) Panel to Review EOSDIS plans, the NRC Committee on Global Change Research (CGCR), and the NRC Board on Sustainable Development (BSD). Some of the key science goals in the design of the system have been the need to support data search and access, dynamic product life cycle and extensible product sets, interactive investigations, information-rich logical data collections, integration of independently developed investigators' tools and software, user-to-user collaboration, distributed administration and control, and site autonomy.

To reach its joint goals for science support and evolution, EOSDIS is designed as a logically distributed system. It will have sufficient modularity and standard interfaces to enable migration and/or replacement of compo-

nents. It will be built with a selection of subsystems and services tailored to particular data types and other specific needs. It will permit autonomy for service providers and the required amount of coordination among them.

A basic feature of the EOSDIS architecture is its reliance on the "client-server" model. A client is an individual or group that requests a service. A server provides the requested service. Some servers, called "agents", may call upon other servers while processing a client's request. The EOSDIS architecture permits easy introduction of new technologies and addition of servers that may provide subsets of the services offered by EOSDIS. Such servers are not necessarily designed, built, or provided by the EOS Program. It is important to note, however, that non-EOS data servers will still be able to interact with EOSDIS.

Some of the key features of the distributed EOSDIS architecture are provided below. Greater detail on the EOSDIS architecture can be found in the references at the end of this section.

Directory Services – Each component of ECS advertises the availability of its services through the ECS Advertising Service. This is the mechanism that ECS uses for its internal subsystems to inform each other of their respective services. The Global Change Master Directory (see <http://gcmd.gsfc.nasa.gov/>) will be used by EOSDIS to advertise its data holdings at the directory level.

Service Classes – The services and data offered by a given system component are accessed via defined "service interfaces." The services are grouped into "service classes," and each service class has a defined interface that can be accessed locally or remotely.

Application Programming Interfaces (APIs) – For the interoperation of software components with each other, each of the services defines an API called the Client API. Programs call the Client API to obtain a service. The CSMS provides services needed for the software components to communicate with each other. Both the definitions of service classes and APIs provide modularity in the system.

Data Collections and Data Servers – The Earth science data are organized in collections of related data. Each collection is managed by a data server. The data servers can be tailored to the data types, thus permitting different designs and organizations of data, depending, for example, on whether the data are multispectral images or atmospheric soundings. The physical location of the data collections is transparent to users.

Data Production – The functions in the system used for product generation are treated like any other service. The site that offers the service advertises it and can be found

regardless of its location. Distributed planning permits making optimal use of distributed computing resources. The design also permits flexibility in decisions on whether a product should be produced routinely or on-demand, and whether it should be produced at a DAAC or SIPS.

Data Ingest – The data ingest service is distributed such that data can be ingested routinely or ad hoc. The ingest services can be found through the advertising service and contacted via the CSMS without regard to their location.

Data Search and Access – The search and access services are found through the advertising service. Users can issue search and access requests directly to the data servers or use a distributed search service to find data from multiple data collections and combine the results. The distributed information management across multiple sites and the local information management for a given site are provided as separate services to provide sites with autonomy in making changes to their local components.

EOSDIS Evolution

User needs for EOSDIS will become more clearly understood as researchers work with, and respond to, early versions of the system; user needs will undoubtedly change over time. New information systems technology will emerge continually, including new database and information management technology applicable to Earth science data, faster processors, and more-capable networks. To succeed over its lifetime, EOSDIS must respond to change; its design and the implementation process must foster change while supporting ongoing operations and user services. Development and prototyping will continue throughout the life of the system. EOSDIS evolution begins with V0, and will continue with subsequent versions as described below. Also, as indicated in the opening section of this chapter, the allocation of responsibilities for EOSDIS functions will evolve over time to lead to a more-distributed system.

EOSDIS V0 – A working prototype with some operational elements, this initial version of EOSDIS interconnects existing Earth science data systems via electronic networks, interoperable catalogs, and common data distribution procedures to provide better access to existing and pre-EOS data. Starting with existing, heterogeneous Earth science data systems, V0 has been developed to evolve toward the full EOSDIS by taking maximum advantage of existing experience and by ensuring that no disruption in current user services occurs. Through the interconnection of the existing systems, V0 serves as a functional prototype of selected key EOSDIS services. As a prototype, it does not have all the capabilities, fault tolerance, or reliability of the later versions; however, EOSDIS V0 supports use by the scientific community in

day-to-day research activities. Such use tests existing services to determine the additional or alternative capabilities required of the full EOSDIS. Development of V0 began in 1991 as a collaborative effort between the Earth Science Data and Information System (ESDIS) Project, all the DAACs* and the NOAA Satellite Active Archive (SAA). V0 became operational in August 1994. Since then V0 has been serving a user community of over tens of thousands of users, supporting over 900 datasets in a growing archive presently over 125 Tbytes, and each month fills data orders to provide over 10 Tbytes of data to users. The current DAAC usage statistics can be found at the World Wide Web location – <http://eos.nasa.gov/eosdis/daacstats>.

The operational experience with V0 has been invaluable in the evolution of the V0 IMS and the local systems within the DAACs. It has also provided very significant lessons for the development of components within ECS to be used for the future versions of EOSDIS. Version 0 will continue to operate until the data from Version 0 are migrated into a subsequent version of the system, and the Version 0 hardware components become obsolete. During this period, the two versions of the system will interoperate.

EOSDIS V1 – Version 1, consisting of extensions of the Version 0 at the Goddard and Langley DAACs, has been providing full support for TRMM since its launch in November 1997. The Langley TRMM Information System (LaTIS) provides the capability for product generation, archiving, and distribution of the standard products from CERES instrument data. The Goddard DAAC's TRMM Support System (TSS) supports archiving and distribution of all products from TRMM except those from the CERES and LIS instruments. The products from the LIS instrument are generated and archived at, and distributed from, the LIS Principal Investigator's Computing Facility at the Global Hydrology Resource Center in Huntsville, Alabama.

EOSDIS V2.0 – Version 2.0, now planned to be operational in July 1999, will provide all the launch-critical functions needed to support Terra. These functions include: Spacecraft command and control, data capture and back-up archive, production of at-launch standard products and support for their quality assessment at the SCFs, and their archiving and distribution to users. A subset of capabilities critical to launch has been available since March 1999. An incremental release will be made in late 1999 with an increased set of capabilities prioritized in consultation with the user community.

* Including the previous DAAC at the Marshall Space Flight Center, which has since been closed. Some of its functions have been taken over by the Global Hydrology Resource Center, other DAACs, and the NOAA SAA.

Subsequent versions of EOSDIS will supplement capacity and services as required by EOS spacecraft launches. EOSDIS capabilities will evolve, based on continuing evaluation by the research community, and the system will be enhanced as the need arises, inserting the latest technologies appropriate to meeting the users' requirements. Also, the allocation of responsibilities for EOSDIS functions will evolve over time to lead to a more-distributed system.

By the end of the EOS mission, plans call for the data held by EOSDIS to be transferred to the control of long-term archival agencies that have vested interest and responsibility for management and distribution of such data. Examples include, but are not limited to, NOAA and the U.S. Geological Survey (USGS). The transfer is planned to occur gradually, starting approximately 3 years after the launch of each spacecraft. EOSDIS will ensure provision of seamless access to the full stream of data for users, although data pricing policies may differ.

Key EOSDIS Terminology

Standard Data Products – Data products that are generated as part of a research investigation using EOS data, are of wide research utility, are routinely generated, and in general are produced for spatially and/or temporally extensive subsets of the data, are to be considered standard data products. All EOS instruments must have standard Level 1 data products, and most will have standard Level 2 data products. Some EOS Interdisciplinary Science Investigations will also generate standard data products. Specifications for the set of standard data products to be generated will be reviewed continually by the EOS IWG and NASA Headquarters to ensure completeness and consistency in providing a comprehensive science data output for the EOS mission. Standard data products will be produced at the DAACs or SIPs.

Special Data Products – Data products that are generated as part of a research investigation using EOS data, and that are produced for a limited region or time period, or products that are not accepted as standard by the EOS IWG and NASA Headquarters, are referred to as special data products. Special data products will normally be generated at the investigators' SCFs. Upon review and approval by independent peer review, EOS IWG, and NASA Headquarters, special products may be reclassified later as standard products, in which case the algorithms and processing may migrate to the DAACs or SIPs and be placed under the appropriate configuration controls.

Level Definitions – The various levels of data referred to in this document are identical to those defined by the EOSDIS Data Panel in its report, and are consistent with the Committee on Data Management, Archiving, and Computing (CODMAC) definitions. For some instru-

ments, there will be no Level 1B product that is distinct from the Level 1A product. In these cases, the reference to Level 1B data can be assumed to refer to Level 1A data. Brief definitions follow:

- *Level 0* - Reconstructed, unprocessed instrument/payload data at full resolution; any and all communications artifacts (e.g., synchronization frames, communications headers, duplicate data removed).
- *Level 1A* - Reconstructed, unprocessed instrument data at full resolution, time-referenced, and annotated with ancillary information, including radiometric and geometric calibration coefficients and georeferencing parameters (e.g., platform ephemeris computed and appended but not applied to the Level 0 data).
- *Level 1B* - Level 1A data that have been processed to sensor units (not all instruments will have a Level 1B equivalent).
- *Level 2* - Derived geophysical variables at the same resolution and location as the Level 1 source data.
- *Level 3* - Derived geophysical variables mapped on uniform space-time grid scales, usually with some completeness and consistency.
- *Level 4* - Model output or results from analyses of lower level data (e.g., variables derived from multiple measurements).

References

Asrar, G., and H.K. Ramapriyan, 1995: Data and Information System for Mission to Planet Earth. *Remote Sensing Reviews*, **13**, 1-25.

National Research Council, 1994: Panel to Review EOS-DIS Plans: Final Report, National Academy Press, Washington D.C.

National Research Council, 1995: A Review of the U.S. Global Change Research Program and NASA's Mission to Planet Earth/Earth Observing System, National Academy Press, Washington D.C.

Price, R.D., M.D. King, J.T. Dalton, K.S. Pedelty, P.E. Ardanuy, and M.K. Hobish, 1994: Earth Science Data for all: EOS and the EOS Data and Information System. *Photogrammetric Engineering and Remote Sensing*, **60**, 277-285.

Schwaller, M.R., B. Krupp, and W. North, 1996: Science Data Plan for EOSDIS, Document Version 4. (See URL: <http://spsosun.gsfc.nasa.gov/spsosdp/sdp/homepage.html> for updates.)

EOSDIS URL

<http://eos.nasa.gov/eosdis>

Page intentionally left blank

Data and Information Policy

NASA Earth Science Enterprise Statement on Data Management

Preamble

The Earth Science Enterprise (formerly Mission to Planet Earth) was established to use the advanced technology of the National Aeronautics and Space Administration (NASA) to understand how the land, oceans, atmosphere, ice caps, and life forms interact as a system in influencing climate change. To accomplish this, NASA is flying a series of Earth Observation System (EOS) satellites that will take 24 different measurement suites important to Earth Science research. Additional data will be taken from smaller, more narrowly focused satellite missions. The unprecedented volume of data expected from these missions will be collected, processed, and distributed by NASA's EOS Data and Information System (EOSDIS).

It is the intent of the Enterprise to promote open access to its data by the general public, including the academic and industry communities. This is a fundamental feature of the program. Allowing open and timely availability to Enterprise data is expected to accelerate the progress of climate-change research. As a consequence, more information will be available to policymakers to make critical decisions relating to environmental quality, land-use management, and other key policy areas. In addition, this approach should also help promote the development of practical applications and commercial products and services derived from Enterprise-related data and technology.

This Statement on Data Management (Statement) is intended to guide the management of scientific data from the Enterprise. The principles set forth in this Statement are intended to advance the goals, mission, and vision of the Enterprise and encourage consistent treatment of data management issues across the Enterprise. They are consistent with existing statutes, federal executive orders, and NASA's own established policies.

For the purposes of this Statement, the term "data" shall mean the research data generated or acquired by the Earth Science Enterprise to meet Enterprise goals as outlined in the NASA Strategic Plan. This term shall not include so-called technical data, i.e., specific information required for the design, development, production, manu-

facture, assembly, operation, use, repair, testing, maintenance, or modification of a product, such as a data collection system (e.g., a satellite, aircraft, or ground system).

Principles

This Statement elaborates on Executive Branch and other legal guidance for data management by the Earth Science Enterprise. The following eleven statements summarize the main principles drawn from that guidance.

1. NASA shall plan and follow data acquisition policies that ensure the collection of long-term data sets that will satisfy the research requirements of the Earth Science Enterprise.
2. NASA is committed to the full and open sharing of Earth Science data obtained from U.S. Government-funded and -owned systems with all users as soon as such data become available. All Earth System Enterprise missions, projects, and grant proposals shall include data management plans to facilitate implementation of this principle.
3. For data from government-owned or -funded systems, NASA will enforce a principle of non-discriminatory access so that all users within the same data-use category will be treated equally. Preferential treatment for U.S. government users and their affiliates will be allowed only where expressly permitted by law.
4. NASA shall make data from the Earth Science Enterprise available at a reasonable price to facilitate access and encourage use. Data from NASA and its U.S. government partners shall be priced at the cost of dissemination or, in cases where such pricing would unduly inhibit use, below that cost. For data from industry and foreign partners in the Earth Science Enterprise, pricing and access policies shall be established by negotiation between NASA and the relevant Earth Science Enterprise provider and system operator. NASA will seek to ensure pricing and

access policies consistent with the principles in this Statement.

5. All data required for long-term global change research shall be archived. Data archives shall include easily accessible information about the data holdings, including quality assessments, supporting relevant information, and guidance for locating and obtaining data.
6. Where cost-effective, NASA shall make purchases of commercial data to meet the scientific objectives of the Earth Science Enterprise. Data purchase arrangements should, at a minimum, permit appropriate use, distribution, and duplication of the data for Earth Science Enterprise purposes by all researchers affiliated with the Earth Science Enterprise. NASA may purchase data on behalf of, and through, other federal agencies for research and investigation purposes.
7. For each cooperative activity with industry, domestic or foreign, NASA shall seek agreement on all major data-management and distribution issues during the project-definition phase. The respective contributions of the parties to the activity shall be considered in allocating rights and control over results from the activity. NASA shall seek to ensure meaningful use of the data for Earth Science Enterprise purposes by all researchers affiliated with the Enterprise.
8. NASA shall engage in ongoing cooperation with other federal agencies, particularly those involved with space-based activities or Earth Science research, to increase the effectiveness and reduce the cost of the Earth Science Enterprise. This interagency cooperation shall include: sharing of data from satellites and other sources, mutual validation and calibration of data, and consolidation of duplicative capabilities and functions.
9. NASA shall, in compliance with applicable federal law and policy, negotiate and implement arrangements with its international partners, with an emphasis on meeting the Nation's own data acquisition, distribution, and archival needs.
10. NASA may allow for exceptions to the guidance contained in this Statement on a case-by-case basis where permitted by law and in furtherance of the public interest.
11. NASA shall review and, if warranted, update this Statement as part of the biennial review of the Earth System Enterprise.

Statement of Principles and Explanation

1. *NASA shall plan and follow data acquisition policies that ensure the collection of long-term data sets that will satisfy the research requirements of the Earth Science Enterprise.*

The success of the Earth Science Enterprise depends on data acquisition practices that will enable the collection of a comprehensive global, long-term data set to address the research requirements of the Earth Science Enterprise. NASA adheres to the following principles regarding data acquisition:

- Data from satellites and other data sources will be acquired according to priorities recommended by Earth Science Enterprise participants and confirmed by the Associate Administrator for the Earth Science Enterprise.
- Where site-specific (rather than global) observations are made, data acquisitions will be conducted on a demand basis. In these cases, data will only be taken where there is: a) an identified user who has requested and will analyze the data or b) recognition of a future Earth Science Enterprise need for the data.
- The level of processing and preprocessing will be dictated by the scientific requirements of the Earth Science Enterprise, using peer-reviewed algorithms.

2. *NASA is committed to the full and open sharing of Earth Science Data obtained from U.S. Government-funded and -owned sensors with all users as soon as such data become available. All Earth System Enterprise missions, projects, and grant proposals shall include data-management plans to facilitate implementation of this principle.*

NASA's Earth Science Enterprise is a bold effort to apply advanced satellite and computing technologies to answer fundamental questions about how the land, seas, air, and life interact as a system and how human activity impacts our environment. To meet this challenge, there must be full and open sharing of the data from the Earth Science Enterprise with the research community, private industry, academia, and the general public. The greater the availability of the data, the more quickly and effectively the user community can utilize the information to address basic Earth Science questions and provide the basis for developing innovative practical applications to benefit the general public.

Under most circumstances, the full suite of government-owned data sets within the Earth Science Enterprise shall be made available to all users, with no user or group

of users receiving a period of exclusive access. Access will not be limited to the scientists, managers, or principal investigators working within the Earth Science Enterprise, but will be extended to the full scientific community and the general public. This principle applies to all Earth Science Enterprise activities, including satellite missions, field campaigns, and grants.

There may be practical impediments to providing timely access to Earth Science Enterprise data held by certain user groups, particularly data used in smaller projects at the principal investigator level. These projects may lack the time, staff, and resources to ensure the earliest public availability of their data product. Nevertheless, even in such difficult cases, NASA is committed to providing the earliest feasible data distribution, provided that the requester pays for the marginal cost of dissemination. Further, NASA shall require, in advance, data-management plans for all Earth Science Enterprise missions, projects, and grant proposals to help assure that sufficient resources are available for data management at all Earth Science Enterprise levels.

3. *For data from government-owned or -funded systems, NASA will enforce a principle of non-discriminatory access so that all users within the same data-use category will be treated equally. Preferential treatment for U.S. government users and their affiliates will be allowed only where expressly permitted by law.*

NASA is committed to providing access on a non-discriminatory basis to all types of scientific data from the Earth Science Enterprise, neither favoring or disfavoring any user or class of users. Non-discriminatory access shall be a requirement for any mission in which NASA resources are invested. That principle is already specifically mandated for unenhanced data from government satellite systems by the Land Remote Sensing Policy Act of 1992, 15 U.S.C. §5601 et seq., which specifically requires that such data be made available to all users on a non-discriminatory basis. Section 501(a) of that Act states:

Except as provided in subsection (b) of this section, any unenhanced data generated by the Landsat system or any land remote-sensing system funded and owned by the U.S. Government shall be made available to all users without preference, bias, or any other special arrangement [except on the basis of national security concerns] regarding delivery, format, pricing, or technical considerations which would favor one customer or class of customers over another.

However, subsection (b) of Section 501 does allow for preferential treatment for the U.S. government and its affiliated users provided that the data from these government satellite systems are used for non-commercial purposes.

For the purposes of this Statement, the term "non-discriminatory basis" shall mean that all users in a clearly

defined data-use category can obtain data on the same terms and conditions, and the categories are defined in a such a way that potential users will be included in each category.

4. *NASA shall make data from the Earth Science Enterprise available at a reasonable price to facilitate access and encourage use. Data from NASA and its U.S. government partners shall be priced at the cost of dissemination or, in cases where such pricing would inhibit use, below that cost. For data from industry and foreign partners in the Earth Science Enterprise, pricing and access policies shall be established by negotiation between NASA and the relevant Earth Science Enterprise provider and system operator. NASA will seek to ensure pricing and access policies consistent with the principles in this Statement.*

Cost can be one of the greatest barriers to broad access to data by the general scientific community, as well as the public and private sectors. For that reason, making data available at a reasonable cost is necessary to facilitate scientific and other uses of the agency's Earth Science data. Accordingly, within the limits of current law, NASA will endeavor to make data available at a price that does not unduly inhibit its use.

For all data from NASA and other U.S. government sources, the data will be made available, without restriction, at not more than the cost of dissemination, without regard to the intended use of the data. Applicable federal law and policy allow the federal government to charge less than the cost of dissemination if the true cost inhibits use of the data. NASA may, under special circumstances as determined by the Associate Administrator or his designee, provide data to users at a nominal cost or no cost where at-cost pricing would inhibit use. NASA appreciates that below-cost pricing may, in some cases, have the potential to impair the ability of federal agencies to defray their operational costs and encourage users to request more data than they actually need. Therefore, in deciding whether to permit below-cost pricing in particular cases or situations, the Associate Administrator shall carefully weigh the benefits of the discount pricing to the user community against the potential costs to affected federal agencies.

It should be emphasized that, since data must be distributed on a non-discriminatory basis, all data products must be available to all persons in the same data-use category at the same price. However, this requirement does not preclude traditional pricing arrangements, such as volume discounts, so long as these arrangements are offered on a non-discriminatory basis.

For data acquired from industry and foreign partners in Earth Science Enterprise activities, a pricing and access policy will be negotiated with the relevant data provider and system operator. NASA will seek to ensure con-

sistency in negotiated pricing and access policies. In that regard, pricing of data from commercial and international partners shall be guided by the applicable provisions of this Statement concerning commercial data purchases, cooperative activities with industry, and international cooperation.

5. *All data required for long-term global-change research shall be archived. Data archives shall include easily accessible information about the data holdings, including quality assessments, supporting relevant information, and guidance for locating and obtaining data.*

The archiving of long-term sets of global climate data is critical for the meaningful study of Earth science and the understanding of important environmental and climate questions. Archives must provide easily accessible information about data holdings, including descriptive metadata, quality assessments, supporting ancillary information, and assistance in locating and obtaining the data.

Each Earth Science Enterprise data set shall be subject to peer review to determine its merit for long-term archiving. In the event that long-term archiving is deemed appropriate, NASA shall seek guidance from Government agency partners to determine if such requirements can be most effectively met through interagency cooperation.

Consideration for long-term archiving shall include: a) all data acquired by, or in support of, Earth Science Enterprise-funded research projects; b) all data acquired systematically by Earth Science Enterprise-funded missions for the purpose of documenting long term variability; and c) all accessible data concerning natural disasters and other extraordinary events identified by the Earth Science Enterprise (e.g., volcanic eruptions, floods, and forest fires).

The Earth Science Enterprise shall not normally archive data taken systematically for the purpose of documenting long-term variability if those data are already being archived by a partnering agency such that long-term access by NASA is assured. This principle shall apply to data from NASA missions as well as joint missions undertaken with another agency or institution, either domestic or foreign. However, NASA may decide to archive such data if it receives a specific request and, upon agency review of the request against NASA's mission, that request is granted. Further, should the archiving institution decide to close its archive, the Earth Science Enterprise may consider the acquisition of all or part of the archived data, but shall not make such acquisition unless it is cost-effective and satisfies NASA's scientific requirements.

6. *Where cost-effective, NASA shall make purchases of commercial data to meet the scientific objectives of the Earth Science Enterprise. Data purchase arrangements should, at a minimum, permit appropriate use, distribution, and duplication of the data for Earth Science Enterprise purposes by all researchers affiliated with the Earth Science Enterprise. NASA may purchase data on behalf of, and through, other federal agencies for research and investigation purposes.*

NASA's Commercial Strategy for the Enterprise states that the agency shall "seek cost-effective science data opportunities that meet the science objectives of the Earth Science Enterprise." In implementing this goal, NASA shall—

- establish rights to distribute proprietary science data purchased from commercial sources (rather than acquired through Earth Science Enterprise capabilities) according to terms mutually acceptable to NASA and the commercial sources coming as close to NASA's goal of non-discriminatory access as possible
- seek out data purchase arrangements with commercial sources where NASA is not the dominant customer over the long term
- act as a data purchasing agent for other federal agencies for research and investigation purposes and encourage other agencies to serve as purchasing agents for NASA for such purposes

These principles will serve the scientific goals of the agency and the federal government as well as the public interest. In the long run, such commercial data purchases could potentially reduce agency costs by precluding the need to design, develop, and launch spacecraft to collect needed Earth science data from space and streamlining data acquisition procedures and procurement processes. Eventually, the evolution of a vigorous commercial space data industry may enable the collection and access of more Earth Science data than is gathered today, with benefits for NASA and other potential customers derived from more-competitive pricing and broader data selection.

In entering into data purchase arrangements, NASA shall negotiate data purchase arrangements which, at a minimum, permit appropriate use, distribution, and duplication by Earth Science Enterprise researchers for science purposes. Such researchers include: a) researchers affiliated with the Earth Science Enterprise through interagency data exchanges, grants, and other formal mechanisms and b) researchers in the international community with whom NASA has formal data-exchange arrangements or informal understandings. NASA shall also seek

to negotiate terms that would allow the release of data to users outside the Earth Science Enterprise researcher community, particularly for scientific, educational, and other non-commercial uses, at the cost of dissemination. NASA shall seek agreement with the data provider on the degree to which the public will be allowed access to data via the Internet.

The government has a duty to facilitate access to publicly funded data—the more the federal investment, the greater is the government's duty to preserve or retain broad access to data. Where the U.S. taxpayers, through the federal government, have made a considerable investment in the observing system or the data product, unreasonable restrictions on use or availability by federal government agencies or their affiliates will not be accepted.

7. For each cooperative activity with industry, domestic or foreign, NASA shall seek agreement on all major data management and distribution issues during the project definition phase. The respective contributions of the parties to the activity shall be considered in allocating rights and control over results from the activity. NASA shall seek to ensure meaningful use of the data for Earth Science Enterprise purposes by all researchers affiliated with the Enterprise.

The Enterprise regularly engages in cooperative activities with industry partners, domestic and foreign, which may take many forms. From the perspective of the Earth Science Enterprise, the ultimate goal of such cooperation is to obtain cost-effective, scientifically meaningful data to help meet Enterprise objectives. Therefore, the management and distribution of data from such cooperative projects must be a central issue in the project definition phase, and agreement on these matters should be achieved before the projects are undertaken.

With these interests in mind, NASA shall adhere to the following principles regarding data from joint missions and projects with industry:

All matters pertaining to data management, particularly data rights and data distribution responsibilities, shall be resolved between NASA and the industry partner prior to undertaking the cooperative NASA-industry activity. NASA shall endeavor to negotiate agreements with the industry partner to assure as broad an access to data from the cooperative activity as possible. NASA shall define the distribution, use, and archiving requirements for each mission in advance and ensure that the agreement with the commercial partner meets those needs. The respective contributions of the partners should be taken into account in allocating rights and control to the results of the cooperative activity. In cases where data are provided on different terms for commercial and non-commercial use, NASA should encourage the commercial partner to be responsible for meeting the needs for commercial use

and should focus agency resources on meeting the research and applications community requirements associated with the Earth Science Enterprise's mission. NASA shall assure meaningful use of data from the cooperative activity for Earth Science Enterprise purposes by all researchers affiliated with the Earth Science Enterprise. This includes access to raw data as part of the scientific peer review process.

8. NASA shall engage in ongoing cooperation with other federal agencies, particularly those involved with space-based activities or Earth Science research, to increase the effectiveness and reduce the cost of the Earth Science Enterprise. This interagency cooperation shall include: sharing of data from satellites and other sources, mutual validation and calibration of data, and consolidation of duplicative capabilities and functions.

NASA continues to join with other federal agencies in cooperative activities that advance the goals of the Earth Science Enterprise. To maximize the benefit of this cooperation, NASA seeks input from cooperating agencies when determining requirements and priorities for data acquisition. In advancing the interests of the Earth Science Enterprise, NASA provides its federal agency partners with access to Earth Science Enterprise data. Further, NASA supports interoperability of systems and compatibility of standards to facilitate data sharing and exchanges. Finally, NASA cooperates with other federal agencies in developing the most cost-effective policies for long-term data archiving.

9. NASA shall, in compliance with applicable federal law and policy, negotiate and implement arrangements with its international partners, with an emphasis on meeting the Nation's own data acquisition, distribution, and archival needs.

Cooperative activities with international partners often present unique circumstances because of the different laws and policies that govern each country. The management of the data resulting from international cooperative projects is ultimately determined by respective project participants, whose goals, policies, and constraints may be quite different. Nevertheless, in negotiating with its foreign partners, NASA will seek to reach agreements and understandings that are in harmony with applicable federal law and policy, as well as the principles contained in this Statement, and meet the needs of the agency.

When entering into any international project, NASA must ensure that its own data acquisition, distribution, and archival needs are defined and met by the terms of the agreement. In general, international agreements in-

involve no exchange of funds, with each party making in-kind contributions of products or services. The benefits to NASA from these arrangements may come in several forms, but typically access to valuable scientific data is one of the primary incentives for agency involvement. Accordingly, it is critical that these agreements explicitly address data policy, specifically each party's rights and responsibilities for data acquisition (including tasking and operations), distribution, and archiving.

All international agreements should clearly address basic questions regarding the rights and responsibilities of the parties with respect to:

- *Data acquisition and tasking.* If data acquisition is not global and continuous, who decides when the instruments are on, and where the data are transmitted to the ground and collected? Who pays for the operational activities?
- *Data distribution and use.* Who may access the data, on what terms, through what facilities, using what standards? Whose consent is required, if any, for access?
- *Data archival.* What data will be archived and for how long, at whose expense, in what facilities, and under what conditions? Who has access, and on what terms, to data in the long-term archive? How are data eventually disposed of?

Given the investment of federal government resources in cooperative missions, NASA should endeavor to ensure that all data are available to all users under defined conditions (i.e., any user should be able to determine what data exist and to access them in a reasonable manner, whether directly or through a third-party distributor). This principle should ensure nondiscriminatory access in the sense that no user is denied access to data (except for reasons of national security or public safety). In general, for missions involving significant NASA investment, NASA shall insist that a long-term archive for mission data be defined and that provisions are made for its funding.

As a minimum requirement for any mission, NASA-affiliated users should be able to obtain and use data from cooperative missions. Their rights should be defined broadly enough to include applications demonstrations as well as more basic research investigations, and should not be limited to NASA-funded investigations, since NASA conducts cooperative science with foreign scientists and with investigators funded by other U.S. Government agencies such as the National Science Foundation. The relevant Earth Science Enterprise and project science leaders need to be part of the agreement and negotiating process to ensure that specific terms are included in the international agreements to promote the realization of mission objectives. Furthermore, access to data should

be made as broad and inexpensive as possible to facilitate maximum utilization by the scientific community.

10. *NASA may allow for exceptions to the guidance contained in this Statement on a case-by-case basis where permitted by law and in furtherance of the public interest.*

The guidance in this Statement with regard to open, non-discriminatory public access to Earth Science Enterprise data is fundamental to the mission of the Enterprise. Nevertheless, NASA recognizes that, to the extent permitted by law, it may be in the public interest for the Associate Administrator to grant exceptions from the principles in this Statement on a case-by-case basis. Past experience suggests most cases in which exceptions might be entertained would likely involve either: a) data acquisitions from commercial sources or joint missions with industry or b) international partnerships. In these categories of cases, it is sometimes determined that the departures from agency policy are outweighed by the value of the data, foreign policy, or public policy considerations.

With regard to acquiring data from commercial sources, it may be necessary to accept seller-imposed restrictions on the use and distribution of acquired data that would not be appropriate for government-generated data. For example, in one past case, a commercial provider contracted to sell remote-sensing data to NASA on the condition that: a) the data be used exclusively for research purposes and b) the data be provided to NASA on a two-to-four week delay (to protect commercial sales of real-time data) except where there is a compelling research requirement for real-time use by specified users.

Data acquired through data exchanges or joint missions with foreign partners may also require acceptance of restrictions on data use and distribution in conflict with NASA policy. In international arrangements, where the non-U.S. party has made a substantial investment in the joint activity, that party may have more negotiating leverage to insist on a restrictive data policy than NASA desires. In such situations, if, on balance, the activity still advances NASA's mission goals, a decision could be made to proceed nonetheless. To that end, past agency practice can be instructive in reviewing individual cases. For instance, in one joint satellite mission involving NASA and a foreign space agency, the governing Memorandum of Understanding gave designated mission investigators a period of three months of exclusive access to the satellite data. Following the period of exclusive access, the data would be placed in an archive and made available to the general public at no more than the cost of filling the user request.

In every case where an exception is requested, NASA will attempt to adhere to the principles in this Statement as closely as possible and will balance the right of the public to open non-discriminatory access to scientific in-

formation from federal agencies against the asserted interests of the parties requesting the exception.

11. *NASA shall review and, if warranted, update this Statement as part of the biennial review of the Earth System Enterprise.*

NASA will regularly review and, if warranted, update this Statement as part of NASA's comprehensive biennial review of the Earth System Enterprise. Review of this Statement will examine whether its principles require revision to reflect changes in applicable law, Administration policy, NASA policy, or relevant facts and circumstances. The review shall also examine possible revisions to this Statement that might improve the Earth Science Enterprise's data management and its ability to carry out its goals and missions. The Associate Administrator must approve any revisions to the Statement.

References

- The National Aeronautics and Space Act of 1958, as amended, 42 U.S.C. §2451, et seq.
- The Land Remote Sensing Policy Act of 1992, 15 U.S.C. §5601, et seq.
- The Paperwork Reduction Act, 44 U.S.C. §3501, et seq.
- The Freedom of Information Act, as amended, 5 U.S.C. §552 (1994), amended by P.L. 104-231.
- OMB Circular A-130 (February 8, 1996)
- National Space Policy (NSTC-8, September 19, 1996)
- Presidential Directive (NSPD-7). Space-Based Global Change Observation (May 28, 1992)
- Statements on Data Management for Global Change Research (Office of Science and Technology Policy, July 1991)
- Mission to Planet Earth Commercial Strategy (March 1997)
- IEOS Data Exchange Principles

Page intentionally left blank

Pathfinder Data Sets

The Pathfinder data set concept was initiated very early in the EOS Program by NASA Headquarters in answer to the question "What can be done now to further global change research?" Pathfinders were intended to provide unprecedented access to consistent, large remote-sensing data sets applicable to global change research prior to the availability of data from the EOS satellites. From these long time series of global and/or regional data sets, higher level geophysical products were or could be derived in support of U.S. Global Change Research Program (USGCRP) objectives.

The main goal of the Pathfinder Program is to make research-quality global change data sets easily available to the Earth science community. In addition, experience gained in processing/reprocessing, archiving, and distributing standard scientific data products was expected to prove a boon as well. As scientific understanding developed and product retrieval algorithms were improved, it was thought that the data sets might require additional reprocessing, which would be provided by this program.

Phase 1: 1990-1994

In October 1990, NOAA and NASA signed an agreement establishing three joint NASA/NOAA Pathfinders to be generated from existing NOAA data sets, as follow:

- Advanced Very High Resolution Radiometer (AVHRR) Global Area Coverage (GAC) data held by NOAA.
- Television and Infrared Observation Satellite (TIROS) Operational Vertical Sounder (TOVS) data held jointly by NOAA and NASA.
- Geostationary Operational Environmental Satellite (GOES) data held by the University of Wisconsin under contract with NOAA.

In 1991, the Special Sensor Microwave/Imager (SSM/I) data set was added as a NASA/NOAA Pathfinder. SSM/I data are currently archived by NOAA under a Shared Processing Agreement with the Navy and the Air Force.

Landsat Multispectral Scanner (MSS) and Thematic Mapper (TM) data held primarily by USGS/EDC were added to the Pathfinder activity in 1992. The Landsat Path-

finder effort involves NASA, Environmental Protection Agency (EPA), and USGS.

Also in 1992, NASA's Scanning Multichannel Microwave Radiometer (SMMR) data set was added as the first NASA-only Pathfinder.

All initial Pathfinder data sets involved space-based observations, and were subject to the following requirements:

- 1) stable calibration of the raw data should be attainable;
- 2) when data from multiple copies of instruments are involved, consistent calibration among instruments in a series should be possible; and
- 3) archiving may include transferring the data to a more accessible medium.

One or more Science Working Groups (SWGs) were formed for each of the identified interagency data sets to provide recommendations for specific Pathfinder activities. SWG reports to the involved partner agencies consist of the following:

- Determination of the scientific needs for Pathfinder data and how these needs translate into specific products.
- Identification of community-consensus algorithms for generating Pathfinder products and determination of the data required to generate these products.
- Recommendation on how these products are to be generated, validated, stored, and maintained.
- Identification of the data services required by users of Pathfinder data (including catalog and browse functions, metadata, and data access).

Initial Pathfinder reprocessing of the above data sets was completed using community-consensus algorithms as recommended by the applicable designated SWGs or a similar process. The resultant data sets were then made available at responsible DAACs, and through the EOSDIS Version 0.

Phase 2: 1995-2000

A NASA Pathfinder Research Announcement was issued in December 1994 in order to continue, rationalize, and strengthen ESE's support of data product generation activities. Interagency cooperation and international coordination were encouraged. Proposals received in March 1995 were evaluated through a scientific and technical peer review, and also were reviewed for scientific and programmatic relevance to the research interests of NASA's ESE and the USGCRP. The continuation of the Pathfinder program reflected the ESE view that data quality and availability are key to successful Earth system science.

The Pathfinder NRA included a call for algorithm development proposals as well as product generation proposals. ESE used the NRA as a mechanism to fill a perceived enterprise development gap between research analysis with satellite data and a robust completed algorithm, including delivery of the completed science application software.

The second phase of the Pathfinder program underlined the importance of building long-time-series data sets, and, in particular, of developing the concept of obtaining measurement continuity through a change of primary instrumentation. The NRA narrative laid out the instrument follow-on relationships of initial Pathfinder data sets and data sets from other then-available instruments with then-upcoming NASA EOS and other ESE missions.

The second phase of Pathfinder Data Sets continues the ongoing series of multidisciplinary AVHRR, TOVS, GOES, and SMMR-SSM/I products. Second-phase projects are also implementing transitional continuity in algorithms and/or data sets for AVHRR and MODIS, and SMMR-SSM/I and TRMM. Ocean heights are provided from the multiple satellite-borne altimetry series from SeaSat through TOPEX/Poseidon. The long-standing International Satellite Cloud Climatology Project (ISCCP) won support, and a new initiative providing Antarctic mapping from Radarsat. Landsat land-cover initiatives have also been continued through the land-cover program. The Pathfinder Phase 2 will continue through fiscal year 2000 in order to make possible continuity of precursor data sets with the Landsat 7, Terra, and EOS PM instrument data sets.

Beyond the Year 2000

Pathfinder Data Sets currently comprise the backbone of available large volume, consistent satellite records. Innovative research using these data sets continues to appear in the peer-reviewed literature. The ESE Research Division is currently (as of this printing) exploring launching an updated extra-mission-specific data program beyond the year 2000, perhaps newly named.

Earth Science Information Partners and the Working Prototype Federation

Scientists of the future will be both producers and users of data—from their desktops. This long-term vision is perhaps the impetus for the 1995 National Research Council (NRC) idea of Federation.

The move to interdisciplinary Earth science interests is expected to lead increasingly to innovative, multi-sensor and multi-source product generation for both science and applications. A model to facilitate best the public availability of data and information from these geographically dispersed providers, including intermediate availability of multi-source products to higher-level data producers, is needed to effect the emergence of an Environmental Information Economy. The Environmental Information Economy can be defined as the collective enhancements needed within the National Information Infrastructure to render it capable of providing for the routine exchange of environmental data and information. This may imply a concerted agreement and evolution process within the community of environmental information providers and users.

ESE embarked upon the data and information system-related Working Prototype Federation in response to the NRC recommendation that the Agency shift appropriate data and information functions to a federation of competitively selected Earth Science Information Partners (ESIPs), a concept which NASA endorses.

NASA concluded that ESIPs can best be described as belonging to three types. Type 1 ESIPs are responsible for standard data and information products whose production, publishing/distribution, and associated user services require considerable emphasis on reliability and disciplined adherence to schedules. Type 2 ESIPs are responsible for data and information products and services in support of Earth system science (other than those provided by the Type 1 ESIPs) that are developmental or research in nature, where emphasis on flexibility and creativity is key to meeting the advancing research needs. Type 3 ESIPs are those providing data and information products and services to users beyond the global change research community who enter into joint endeavor agreements with OES.

NASA and the NRC agreed in 1996 that the appropriate way to initiate a federation of ESIPs was through an evolutionary, prototyping process. ESE's response was to invest in a Working Prototype Federation (WP-Federation) of Working Prototype ESIPs (WP-ESIPs). The objective of the WP-Federation is to experiment with and

evolve processes to make Earth system science data easy to preserve, locate, access, and use for all beneficial applications, including research, education, and commercial, many of which may cross Federation membership.

Through twelve Type 2 and twelve Type 3 WP-ESIP projects selected under two Cooperative Agreement Notices in December 1997, ESE, with the community, is exploring new and innovative approaches to ESE's data and information system and services in support of Earth system science, and is endeavoring to contribute to the implementation of an increased functionality for environmental data and information search, access, order, and retrieval within the National Information Infrastructure. The evaluation of the federation concept has been initiated beginning with this limited set of prototype projects operating in a federated, rather than a centrally-managed architecture. This future-oriented strategy is just becoming possible because of the tremendous pace of information technology innovation, and can be seen as comparable to the move toward Principal Investigator-driven spacecraft.

The Type 2 ESIPs concept is, in a way, a further development of the evolution of the Pathfinder Data Sets concept, with the additional feature of providing the stewardship for the near-term storage, distribution, and user services portion of the data-product management cycle. The present Type 2 WP-ESIPs also have the objective of enhancing innovation and creativity in the provision of environmental information services, and of identifying and testing new or emerging information technologies, techniques and/or approaches which offer promise of significantly reducing the future costs of ESE's data and information system and services. It is hoped that marrying these science and technology objectives within the Type 2 WP-ESIPs will promote very close teamwork and interactions between scientists and system designers and implementers, resulting in highly effective science data centers.

Type 3 ESIPs will be responsible for extending the benefits of NASA Earth science data and information beyond basic research to a broader user community including private industry, value-added companies, state and local governments, and non-profit organizations. NASA required that all for-profit organizations must cost-share to at least the 50% level. Successful Type 3 ESIP organizations are expected to become financially self-sustaining by the end of their nominally 5-year projects. The participation of Type 3 WP-ESIPs in the Working Proto-

type Federation will test the flexibility and extensibility of such a system.

ESE has resolved to make peer-review and competition a more-recurrent feature in all our projects, including our data centers' activities. Because it is expected that ESE will be moving to a more-distributed and flexible data system approach, it is both timely and useful to examine where the best levels within the organization are for making different types of salient decisions concerning data management. By their submission of proposals, these projects expressed an interest in prototyping how a move to a federated environmental data system might occur.

WP-ESIPs attended an NRC Federation Workshop in February of 1998. At that time, the Type 2 and Type 3 WP-ESIPs voted to invite the EOSDIS Distributed Active Archive Centers to join them in the WP-Federation as Type 1 ESIPs.

WP-ESIP projects officially got underway in April 1998. The WP-Federation convened for the first time in May of 1998. Early activities of the WP-Federation indicate that, rather than seeking wholesale system-wide solutions, WP-ESIPs plan to self-organize in partnerships, to develop more-custom approaches to data access and user services for associated more-targeted user communities. Clusters of Type 1, 2, and/or 3 ESIPs will form to share data, scientific expertise and tools relevant to a particular science or application question. Since this initiative is implemented through working prototype data centers, which are all mandated to make their services available to all on a non-discriminatory basis, it is an initiative in which ESE's user communities can all participate.

Type 2 WP-ESIP Projects' Titles and Project Leaders

- "The Distributed Oceanographic Data System: A Framework for Access to Scientific Data in the EOS Federation," led by Peter Cornillon, University of Rhode Island, Narragansett.
- "The Earth System Science Workbench: A Scalable Infrastructure for ESIPs," led by James Frew, University of California, Santa Barbara.
- "Seasonal to Interannual Earth Science Information Partner (SIESIP)," led by Menas Kafatos, George Mason University, Fairfax, VA.
- "Progressive Mining of Remotely Sensed Data for Environmental and Public Health Applications," led by Chung-Sheng Li, International Business Machines, Yorktown Heights, NY.
- "A Web-Based System for Terrestrial Environmental Research," led by Berrien Moore, University of New Hampshire, Durham.

- "ESP2Net: Earth Science Partners' Private Network," led by Richard Muntz, University of California, Los Angeles.
- "Evolution of Snow Pack in the Southwestern United States: Spatial and Temporal Variability from a Remotely Sensed and In Situ Data Set," led by James J. Simpson, Scripps Institute of Oceanography, University of California, San Diego.
- "Tropical Rainforest Information Center," led by David L. Skole, Michigan State University, East Lansing.
- "An On-Demand Data Processing and Delivery System for Climate Studies Using Passive Microwave Data Sets," led by Roy W. Spencer, Marshall Space Flight Center, Huntsville, AL.
- "A Landcover Earth Science Information Partnership," led by John R. G. Townshend, University of Maryland, College Park.
- "GPS Environmental & Earth Science Information System: GENESIS," led by Thomas P. Yunck, Jet Propulsion Laboratory, Pasadena, CA.
- "Improved Ocean Radar Altimeter and Scatterometer Data and Atmosphere-Ocean Model Simulation for Coastal and Global Change Studies," led by Victor Zlotnicki, Jet Propulsion Laboratory, Pasadena, CA.

Type 3 WP-ESIP Projects' Titles and Project Leaders

- "Institutionalizing MTPE Data for Land and Environmental Management," led by Thomas Burk, University of Minnesota, St. Paul.
- "California Land Science Information Partnership," led by Gary Darling, California Resources Agency, Sacramento.
- "Performing a Regional Assessment and Prototyping Internet Accessible MTPE Products for the Upper Rio Grande Basin," led by Stanley Morain, University of New Mexico, Albuquerque.
- "Integrating Environmental and Legal Information Systems," led by Konstantinos Kalpakis, University Space Research Association (USRA), Greenbelt, MD.
- "A Public Access Resource Center (PARC) Empowering the General Public to Use EOSDIS Phase III Operations," led by George Seielstad, Upper Midwest

Aerospace Consortium (UMAC), University of North Dakota, Grand Forks.

- “WeatheRoute,” led by Kevin Meagher, Reading Information Technology, Inc., Reading, PA.
- “MTPE Education Series,” led by Catherine Gautier, Planet Earth Science, Inc., Santa Barbara, CA.
- “Integration and Application of MTPE Data and Information to the San Francisco Bay Area and Monterey Bay Region,” led by David Etter, Bay Area Shared Information Consortium (BASIC), Mountain View, CA.
- “Museums Teaching Planet Earth,” led by Patricia Reiff, Rice University, Houston, TX.
- “Terrain Intelligence Products from EOS Sensor Data,” led by Douglas Kliman, MRJ Associates, Tucson, AZ.
- “NBC News and Information: Extending MTPE Data to the World,” led by David Jones, WRC-TV4, Washington, DC.
- “MTPE-Derived Data Products for the Fisheries,” led by Patrick Simpson, Scientific Fishery Systems, Inc., Anchorage, AK.

Page intentionally left blank

EOS Data Quality: Calibration and Validation

Data quality for EOS is sought and checked through comprehensive calibration and validation programs. The primary objectives of these programs are to characterize and document the accuracy and precision of EOS observations and derived geophysical and biophysical products over all relevant temporal and spatial scales. More specifically these two programs include: 1) radiometric calibration and characterization of EOS instruments; and 2) validation of the observations and state variables, fluxes, and parameters derived directly from EOS observations or in conjunction with the data assimilation method(s) and integrated Earth system models. These programs are guided and coordinated by the EOS Calibration and Validation Scientists residing within the EOS Project Science Office at Goddard Space Flight Center.

Calibration Program

In order to achieve the EOS goal of understanding the Earth as a natural system, EOS will produce global, long time series of remote-sensing data sets from multiple instruments on multiple platforms. The correct interpretation of scientific information from these data sets requires the ability to discriminate between satellite instrument on-orbit changes and changes in the Earth physical processes being monitored. The ability to make this discrimination on a pre-launch, post-launch, inter-instrument, and inter-platform basis crucially depends on the calibration of the instruments with respect to a set of recognized physical standards or processes and on the careful characterization of instrument performance at the subsystem and system levels.

In EOS, calibration is the set of operations or processes used to determine the relationship between satellite instrument output values (i.e., voltages or counts) and corresponding known values of a standard, expressed in Systeme Internationale (SI) units. Characterization is the set of operations or processes used to quantitatively understand the operation of an instrument and its response as a function of the gamut of operating and viewing conditions experienced by the instrument on-orbit. The complete calibration of an EOS instrument requires and implies that the instrument be well-characterized. EOS instrument calibration and characterization are performed both pre-flight and on-orbit.

There are three types of radiometric calibration activities currently being conducted as part of the EOS Calibration Program: 1) laboratory calibration prior to launch, 2) in-flight calibration with onboard calibrators, and 3) vicarious calibration during the post-launch period. The laboratory calibration activities focus on calibration of individual instruments with traceability to radiometric standards accepted by the national and international metrology community and implemented by organizations such as the U.S. National Institute of Standards and Technology (NIST). This step also includes the intercalibration of instruments that operate in the same region of the electromagnetic spectrum and that measure similar characteristics of the Earth system. For example, transfer radiometers are being used in round-robin intercomparisons that enable the transfer of metrology scales, maintained at national standards laboratories, to surface-imaging instruments such as ASTER, MODIS, and MISR that will be launched on the Terra satellite. The in-flight calibration will utilize calibration lamps, reference panels with known reflectivity/emissivity, deep space, and ratioing radiometers. The vicarious methods include the use of bright and dark target scenes on Earth, coincident sub-orbital flights of well-calibrated spectroradiometers over well-characterized Earth surfaces, and the use of the Moon as a stable reference target that will be characterized from high-spectral-and-spatial-resolution measurements made from ground-based observatories over the libration cycle of the Moon.

The key components of the EOS Calibration Program are:

Pre-flight EOS Instrument Calibration

- Instrument Calibration Plans
- Calibration Peer Reviews
- Radiometric Measurement Comparisons
- EOS Calibration Panel
- Artifact Round-robins

Post-launch EOS Instrument Calibration

- On-orbit Platform Maneuvers (e.g., calibration attitude maneuvers)
- The USGS- Lunar Radiometric Measurement Program
- Level 1B Validation (e.g., vicarious calibration) Campaigns

Current information concerning the EOS Calibration Program is available at the following website:

<http://eos.nasa.gov/calibration/calpage.html>

Validation Program

The goal of the EOS Validation Program is the comprehensive assessment of all EOS science data products. Specifically, validation is the process of assessing, by independent means, the uncertainties of the data products derived from the measurement system outputs. These products are derived either directly from calibrated instrument measurables or in conjunction with data assimilation and Earth system models. Achievement of this goal requires information related to the accuracy and precision of the instrument product and the knowledge of the scales and conditions of interest to the users of the derived geophysical and biophysical data products.

In general, validation is accomplished by direct comparisons with independently obtained correlative measurements and by intercomparisons with independently derived satellite retrievals. Correlative measurements for direct comparisons are obtained from ground-based networks, comprehensive ground-based test sites, and field campaigns involving detailed studies of the geophysical and biophysical processes. Airborne measurements using specifically designed EOS instrument simulators and community airborne instruments play an essential role in the field campaigns. Independently derived satellite retrievals for intercomparisons are obtained from observations by instruments on the same EOS platforms or by instruments on other EOS platforms or non-EOS platforms.

The EOS instrument science teams are responsible for validation of the algorithms and data products they produce. Thus, members of the instrument science teams identify the necessary steps required to validate their respective data products on specific space and time scales and for various phenomenological/environmental settings. Intercomparison of similar data products developed by different instruments based on different techniques is planned and conducted by the respective instrument science teams. For example, cross-comparison and validation of cloud products developed by CERES, MISR, and MODIS instruments require close collaboration among the responsible members of those science teams. The end users of these products, e.g., interdisciplinary investigators, participate in validation activities to ensure that uncertainties and associated statistics provided for each product meet their requirements. In addition, the interdisciplinary and four-dimensional data assimilation teams will validate their model results, based on remotely sensed and in situ observations. Each Level-1 through Level-3 prod-

uct will have an associated uncertainty estimate; this is expected to include both a basic error estimate for that product (long-term radiometric spectral and spatial resolution and accuracy) and time-based indications of larger uncertainties that result from unusual conditions such as volcanic eruptions and major desert-dust events.

The team validation activities occur in two basic phases: pre-launch and post-launch. Pre-launch activities include development and verification of algorithms and characterization of uncertainties resulting from parameterizations and their algorithmic implementation. Post-launch activities include refinement of algorithms and uncertainty estimates based on near-direct comparisons with correlative measurements and selected, controlled analyses or application implementations.

The EOS Validation Scientist organizes and coordinates the project-wide validation program and defines guidelines, policies, and milestones. To facilitate effective communications and stimulate collaborative activities, timely workshops and scientific meetings are conducted. The Validation Scientist provides coordination with other NASA and non-NASA programs, conducts community reviews of team validation plans, and advocates the direct and supplemental support of team validation tasks. Examples of tasks that may require supplemental support include development of airborne simulators, participation in field experiments, acquisition of correlative measurements, and enhancement of databases such as HITRAN. When necessary, NASA Research Announcements are issued to solicit the supporting and/or enhancing activities.

Current information concerning the EOS Validation Program is available at the following website:

<http://eos.nasa.gov/validation/valpage.html>

Educational Programs

While the goal of NASA's Earth Science Enterprise (ESE) is increased scientific understanding, an important outcome of the program is education, in its broadest form. One of the four goals of the program, as cited in its Strategic Plan, is to "foster the development of an informed and environmentally aware public." Within this context, contributions by ESE to the advancement of public knowledge about the Earth are key to measuring the success of the program.

NASA's Education Framework

All formal NASA education activities are part of the NASA Education Framework. This framework includes three components: program content, education levels, and implementation approaches. Program content reflects the science and engineering efforts underway within NASA and the enabling capabilities that support them. Education levels are divided between kindergarten through fourth grade, fifth through eighth grade, ninth through twelfth grade, and undergraduate, community college, and graduate levels. The implementation approach defines the purpose of the activity. The following categories represent the various implementation approaches used in NASA:

Teacher preparation and enhancement – Programs are designed to enhance teacher/faculty knowledge and research skills through exposure to the NASA mission, facilities, and resources for use in the teaching enterprise.

Curriculum support – Efforts here create, utilize, and disseminate instructional products based on NASA's unique mission and resources in the areas of science, mathematics, and technology.

Student support – Student support provides research experiences for students at NASA and related sites, provides experiences and exposure to NASA's mission, including science, mathematics, engineering, and technology, and provides support to train students in the areas of science, mathematics, and engineering.

Educational technologies – These are programs and products that develop and use advanced technologies for education including, but not limited to: Internet services, CD-

ROM databases, live or taped video, computer software, multimedia systems, virtual reality, educational technology research and development, databases, and dissemination systems.

Systemic change – Systemic activities typically involve collaborative efforts with a range of partners, seeking to enhance multiple aspects of the educational process.

Earth Science Enterprise Education Strategy

In support of the NASA education initiative, the Office of Earth Science has worked with the Education Division to establish a focused, sustainable education strategy. The strategy includes all education programs and activities at all ESE field centers and NASA Headquarters. Principles, objectives, priority elements, and an implementation plan are part of the overall strategy to insure that ESE has a solid education program with the ability to grow.

Overriding principles have been established to consider when working to meet specific ESE education objectives:

- Education, in the broadest sense, is the ultimate product of ESE.
- We must, through our efforts, demonstrate relevance to society.
- We must operate and work within NASA's strategy for education.
- We must focus implementation of a sustainable Earth system science education program that is consistent with externally imposed education standards.
- Scientists must continue and increase their involvement in education.
- Teachers must be involved in the development and decision-making aspects of education activities.
- NASA strategy and programs must be coordinated (and perhaps integrated) with other agencies/organizations.

- Attention to equity and diversity must be a component in all ESE education activities.
- NASA provides the first level of translation for science information and, when appropriate, leverages resources of external groups for further translation.

These guiding principles define our approach to achieve the following objectives:

- Train the next generation of Earth scientists to use an interdisciplinary, Earth system science approach.
- Continue to educate and train educators as research evolves and capabilities change.
- Raise awareness of policymakers and citizens to enable prudent policy determination regarding global change.
- Improve science and math literacy.
- Improve interface between educators and scientists and secure greater support by scientists for broad education efforts.
- Explore mechanisms to leverage the development of materials and products, where reasonable, to increase resources availability; increase the Earth-System-Science knowledge base; and encourage the development of an external capability to translate scientific research into usable forms for a continuum of customers.

Prioritization of educational activities is not a clear-cut procedure. In order to meet the above objectives, a complement of activities, using the various implementation approaches, must be performed. However, there are certain priority elements to consider when implementing a focused, sustainable program. We must maintain support for graduate students and the establishment of curricula in universities that pursue an interdisciplinary Earth system science concept, in the hope of establishing an educated community in the near term to analyze data from the EOS missions and provide accurate information on global change to policymakers. ESE must also educate present and future educators if its efforts are to reach a national, diverse population of students. A further priority will be continued encouragement to use technology in pre-college activities as technology allows for increased hands-on, interactive learning.

In order to prioritize education activities in ESE in concert with the strategy objectives, a peer review process has been established to involve scientists and educators in the review of all proposals for educational activities submitted to ESE. ESE has also incorporated educa-

tional requirements in recent, relevant research announcements, such as:

- NASA Research Announcement: The Establishment of Regional Earth Science Applications Centers (RESACS) Triana - Concept for Earth-Viewing Satellite (AO-98-OES-02), and
- NASA Research Announcement: New Investigator Program (NIP) in Earth Science (NRA-98-OES-10)

In 1998, ESE sponsored the third annual Earth science education product review. This review provides consistent assessment criteria for NASA Earth science education products and determines which new Earth science education products are appropriate for production and distribution by NASA for national audiences, and whether for broad distribution or through targeted teacher workshops during 1998/1999. The review includes panels consisting of teachers, curriculum and instructional design specialists, teacher trainers, and Earth system scientists. It is not intended to replace testing and evaluation that should be built into the product's development; rather, this review is one of the final steps before an ESE education product goes into national distribution by NASA.

NASA Centers, grantees, contractors and other NASA-sponsored organizations are strongly encouraged to include their outstanding ESE education products in this annual review, which enables Earth science education products to be distributed throughout the NASA Educators Resource Center Network (ERCN) and at national education conferences—reaching far greater audiences than a single Center or organization would be able to undertake alone.

Successful completion of this review is also a requirement for a listing in the NASA ESE Catalog of Education Programs and Resources, as well as a requirement for the product's inclusion in the ESE Education Products Training Workshop. A key principle of NASA's ESE Education Strategy is that ESE education activities are developed within the broader context of NASA's overall education program and strategy. A major component of NASA's education program is the Educator Resource Center Network (ERCN), formerly known as the Teacher Resource Center Network (TRCN). This annual workshop brings together representatives from the ERCN, Aerospace Education Services Program (AESP), and the Teaching from Space Program. Participants receive training in NASA ESE education products and commit to conducting a minimum of three teacher workshops using NASA ESE education products. Their workshops introduce ESE education products to thousand of teachers across the country.

Other NASA ESE education activities that support the ESE Education Strategy are teacher and faculty enhancement activities such as:

Faculty: Remote Sensing Core Curriculum Project and the ACTES (Associate of Arts in Community Colleges for Training in Earth Science) Project. (In-service) – Discover Earth teacher workshop for teachers of grades 5-12 and the Classroom of the Future's graduate courses in Earth system science, which have been developed for K-12 teachers.

Pre-service – Pre-college teacher enhancement grants, which were awarded to 12 colleges and universities to develop and offer Earth system science workshops for teachers-in-training.

Sponsoring student fellowships and other research opportunities, including graduate students – Earth System Science Fellowships (see next section).

Undergraduate students – Undergraduate student enhancement grants, which were awarded to six colleges and universities which are developing student research opportunities in Earth system science for undergraduate students.

Pre-college – Global Learning and Observations to Benefit the Environment (GLOBE) Program, in which students internationally are collecting environmental measurements, and the EarthKam Project, in which students operate an Earth-observing camera onboard the Space Shuttle. Systemic Change, including curriculum development at precollege and university levels, including the Earth System Science Education (ESSE) Program for undergraduate curriculum development and the NASA-sponsored U.S. Global Change Education State Team Projects, which are conducting K-12 curriculum development activities in twenty states.

Technology-based programs – Including developing CD-ROMs and WWW sites for disseminating information and data from ESE missions.

NASA's Earth Science Enterprise: 1998 Education Catalog – Information on NASA ESE education programs and resources for all education levels. This publication is available at:

http://www.earth.nasa.gov/education/ESE_Ed_Catalog_98/index.html

Earth System Science Fellowships

A primary student support activity at the higher education level is the Earth System Science Fellowship Program. This is the third year that NASA is combining the financial support for the Earth science portion of its Graduate Student Researchers Program (GSRP), supported by the NASA Education Division, and the Graduate Student Fellowship in Global Change Research, supported by the Office of Earth Science, to fund both M.Sc. and Ph.D. applicants pursuing their graduate studies in the field of Earth system science. The NASA Education Division awarded a total of 51 Global Change Fellowships for the 1998/1999 academic year.

The program provides support for the following scientific areas: Seasonal-to-Interannual Climate Variability and Prediction; Long-term Climate Natural Variability and Change Research; Land-Cover and Land-Use Change Research; Atmospheric Ozone Research; and Natural Hazards Research and Applications. Applications will be considered for research in atmospheric chemistry and physics, ocean biology and physics, ecosystem dynamics, hydrology, cryospheric processes, geology, and geophysics, provided that the specific research topic is relevant to NASA's Earth remote-sensing science, process studies, modeling and analysis in support of the U.S. Global Change Research Program (USGCRP). NASA discourages submission of paleo-climate related applications to this program.

Awards are made initially for one year and may be renewed annually, no more than two additional years for a total of three years, based on satisfactory progress as reflected in academic performance and evaluations by the faculty advisor. Three years is the maximum support a student may receive in pursuing M.Sc. and/or Ph.D. degree(s). For example, a student who has been supported for three years to obtain her/his M.Sc. degree cannot apply for an additional three years of Ph.D. support. However, students who are in the second or third year of their M.Sc. program may use the balance of the three years of support remaining to complete their M.Sc. degree and to initiate their Ph.D. research. In either case, the maximum period of support is three years. The amount of the award is \$22,000/annum, which may be used to defray student's stipend, living and educational expenses, travel expenses to scientific conferences, tuition, and fees.

Students admitted to or already enrolled in a full-time M.Sc. and/or Ph.D. program at accredited U.S. universities are eligible to apply. Students may enter the program at any time during their graduate work. Students may also apply in their senior year prior to receiving their baccalaureate degree, but must be admitted and enrolled in a M.Sc. and/or Ph.D. program at a U.S. university at the time of the award. An individual accepting this award may not concurrently receive other Federal funds, including funds from other Federal fellowships, traineeships,

or employment. However, NASA may allow an applicant receiving Fellowship Supplements from other U.S. Federal agencies to cover expenses not covered by NASA's educational fellowships. A notable example is the purchase of equipment, which is not permitted by NASA Fellowships but is covered by the National Science Foundation Graduate Student Supplemental Fellowships. United States citizens and resident aliens will be given preference, although the program is not restricted to them. Students with disabilities and from underrepresented minority groups are urged to apply. No applicant shall be denied consideration or appointment as a NASA Earth System Science Fellow on grounds of race, creed, color, national origin, age, or sex.

Earth System Science Fellowship information packets are available each January, and must be completed by a mid-March deadline to be considered for the following academic year. One original and seven copies of the application package need to be forwarded to the address below. Incomplete packages and/or those received after the March deadline are not considered in the selection process.

Applications are reviewed on a competitive basis through a two-step process. The first step involves a mail review, which weeds out deficient proposals by assessing the caliber of student, quality of research, and relevance to the NASA Global Change Research Program. Those applications that pass the initial screening are then evaluated by a panel composed of members of professional scientific societies, academic institutions, NASA Centers, and NASA Headquarters. Results of the competition are announced by June 30, with September 1 as the anticipated starting date of awarded fellowships.

Competition for a Graduate Student Fellowship in Global Change Research is quite fierce. Over 234 applications were submitted this year. 51 successful candidates were selected, with the chosen students representing 86 universities and 33 countries. To date, more than 400 fellowships have been awarded.

A student receiving support under the Global Change Fellowship Program does not incur any formal obligation to the Government of the United States; however, the objectives of this program will clearly be served best if the student is encouraged to actively pursue global change research after completion of graduate studies. By offering the opportunity to participate in this prestigious program, NASA hopes to attract the world's most outstanding scientists, both in the role of graduate fellows and faculty advisors. The ultimate goal is to increase the number of well-trained Earth scientists in the EOS era.

For more information write to:

Earth System Science Fellowship Program
Code Y
400 Virginia Avenue SW, Suite 700
Washington, DC 20024

Earth Science Enterprise URL

<http://www.earth.nasa.gov/education/index.html>

Global Change Fellowship Listings

http://eos.nasa.gov/eos_homepage/directory.html

International Cooperation

International Cooperation

Contributions from international partnerships are a vital piece of NASA's Earth Science Enterprise. In order to tackle the global challenge of understanding the total Earth system, neither NASA nor even the entire U.S. Government, acting through the U.S. Global Change Research Program (USGCRP) of which NASA is a part, can do it alone. We rely heavily on international partners who, through space agencies and other organizations abroad, are making financial and hardware commitments to space-based Earth science comparable to those of NASA. These international partnerships can typically range anywhere from NASA's providing an instrument for flight on another country's satellite and launch vehicle (or vice versa) to an exchange of scientific data resulting from independent U.S. and non-U.S. missions. The goal is to share as much useful scientific information as possible in order to answer as quickly as possible some of the most pressing questions facing humanity today—questions about how our planet is changing and what we are doing to contribute to those changes. International partnerships and data sharing also promote efficiency by eliminating the need for different nations to fly multiple copies of the same (or virtually the same) scientific instrument. Furthermore, they enhance the scientific return of research missions by involving more trained minds in the analysis of the resulting scientific data.

A primary vehicle for promoting international cooperation among countries with space-based Earth observation research programs is the Committee on Earth Observation Satellites (CEOS). CEOS brings together the space-faring nations of the world to coordinate their planned Earth observation activities, promote the sharing of data and researchers, foster the interoperability of information systems and services, and ensure the quality and accuracy of Earth observation research data through a focus on data calibration and validation. CEOS is also taking a lead in addressing the space component of a broader integrated global observing strategy (IGOS) that will encourage coordination among space and in situ observations. Even countries without space programs can contribute through providing access to ground-based or other in situ data and through analysis of the results of shared information from spacecraft. Ultimately, if the nations of the world are to take steps to address global

change, they must have confidence in the research data. And there is no better way to engender this confidence in the data than through involvement in its production.

The following paragraphs offer brief synopses of some of the major foreign contributions to NASA's Earth Science Enterprise (see Table 9).

Western Europe

NASA is cooperating with France's Centre National d'Etudes Spatiales (CNES) on Jason-1 (a follow-on ocean radar altimetry mission to TOPEX/Poseidon), which is scheduled for launch in 2000. NASA and CNES are also cooperating on the Pathfinder Instruments for Cloud and AeroSol Spaceborne Observations-Climatologie Etendue des Nuages et des Aerosols (PICASSO-CENA) mission, which was selected for development under NASA's second Earth System Science Pathfinder (ESSP-2) Announcement of Opportunity (AO). PICASSO-CENA is scheduled for launch in 2003.

NASA cooperation with Germany's German Aerospace Center (DLR) includes collection and analysis of ocean-color data from a German instrument, the Modular Optoelectronic Scanner (MOS), launched aboard the Indian Remote Sensing Satellite P3 (IRS-P3) in March 1996; the Shuttle Radar Topography Mission (SRTM), scheduled for launch in 1999; the Challenging Mini-satellite Payload (CHAMP), scheduled for launch in late 1999, and the Gravity Recovery and Climate Experiment (GRACE) mission, scheduled for launch in 2001.

The United Kingdom is working with NASA to provide the Resolution Dynamics Limb Sounder (HIRDLS) as well as making crucial contributions to the Microwave Limb Sounder (MLS), which will fly on the EOS CHEM mission, scheduled for launch in 2002.

The Netherlands is providing the Ozone Monitoring Instrument (OMI) for EOS CHEM. NASA arranged and funded a launch of Denmark's Oersted satellite, which included a NASA-provided Global Positioning System TurboRogue (GPS-TR) receiver. Oersted was launched in February 1999.

The European Space Agency (ESA) has launched its first Earth Remote Sensing satellite (ERS-1) in 1991 and its second, ERS-2, in April 1995. NASA has agreements with ESA to receive, process, and distribute Synthetic Aperture Radar (SAR) data from both missions.

ERS-1 is no longer operational, but NASA continues to receive SAR data from ERS-2. In 2000, ESA plans to launch its Envisat-1 mission, which includes nine instruments to study coastal zones, oceans, ice and land surface processes, and atmospheric chemistry processes. NASA is currently working with ESA on an arrangement to receive data from Envisat-1.

In addition, European scientists are members of EOS instrument science and Interdisciplinary Investigation teams, and are supporting EOS validation activities within Europe (see EOS Instruments and Interdisciplinary Science sections).

Russia

The Russian Space Agency is providing the spacecraft, the 1999 launch, and operations for NASA's Stratospheric Aerosol and Gas Experiment III (SAGE III). Russia is also participating in the full range of SAGE III science team activities. The Russian Academy of Sciences is interoperable with NASA's EOSDIS.

Canada

NASA and the Canadian Space Agency (CSA) are continuing cooperation on the Radarsat-1 mission, which was successfully launched in November 1995. Since its launch, this cooperative mission has provided an archive of uniform global SAR data by means of the satellite's multi-mode imaging capabilities including high-resolution satellite coverage of the Antarctic continent.

CSA is also providing MOPITT for flight on Terra, with a reflight possible on a flight of opportunity. This instrument will measure atmospheric carbon monoxide and methane. CSA is also sponsoring two of the EOS Interdisciplinary Science Investigations. CSA and NASA are also cooperating on a Canadian science small-satellite mission, SciSat, scheduled for launch in December 2001 on a NASA-provided Pegasus XL launch vehicle. NASA and the Department of Natural Resources of Canada (NRC) are currently leading a joint study to evaluate the interactions between the boreal forest and the atmosphere to understand their role in global change. This study includes intensive ground, air, and space observations, and participation from a variety of U.S. and Canadian Government agencies with an interest in the environment.

Japan

Japanese contributions to NASA's Earth science activities include NASA's participation in the National Space Development Agency (NASDA)'s ADEOS missions and co-sponsorship with NASA of the TRMM mission and possible TRMM follow-on mission. The Japanese Ministry of International Trade and Industry (MITI) is also

participating through its provision of the Advanced Spaceborne Thermal Emission and Reflection Radiometer (ASTER) for the Terra platform, scheduled for launch in 1999. NASDA is providing an Advanced Microwave Scanning Radiometer (AMSR-E) for EOS PM, scheduled for launch in 2000.

The objectives of the ADEOS missions include Earth surface, atmospheric, and oceanographic remote sensing. The U.S. supplied two instruments for flight onboard ADEOS—a NASA Scatterometer (NSCAT) and a Total Ozone Mapping Spectrometer (TOMS). The French contributed one instrument to the mission—the Polarization and Directionality of Earth's Reflectances (POLDER). Due to technical difficulties, the ADEOS satellite ceased operation in June 1997, ten months after launch. ADEOS-II is a post-ADEOS polar-orbiting Earth observation satellite whose mission is to obtain Earth science data related to the global water cycle. ADEOS-II, which will also carry an NSCAT follow-on instrument (SeaWinds) and a French POLDER instrument, is due for launch in the year 2000.

TRMM is a joint NASA/NASDA mission with a major objective of measuring precipitation in the Earth's tropical regions. Japan supplied the launch vehicle and precipitation radar for TRMM, and NASA provided a TRMM Microwave Imager (TMI), a Visible Infrared Scanner (VIRS), a Clouds and the Earth's Radiant Energy System (CERES), a Lightning Imaging Sensor (LIS), and the TRMM spacecraft. TRMM was launched on a Japanese H-II launch vehicle in November 1997.

Finally, Japan is sponsoring one Interdisciplinary Science Investigation (see Interdisciplinary Science section).

Latin America

Argentina is developing the Scientific Applications Satellite-C (SAC-C), which is scheduled for launch in December 1999 on a NASA-provided expendable launch vehicle and will provide important information about land use/land cover change for forest, agricultural, desert, and marine coastal areas in Argentina, as well as contribute to NASA's Earth science efforts. SAC-C will also be one of a suite of satellites to carry a new GPS receiver, provided by NASA, for atmospheric, oceanic, and spacecraft navigation studies.

Brazil will provide the Humidity Sounder-Brazil (HSB) instrument for flight on NASA's EOS PM spacecraft. The HSB is a measurement system for atmospheric humidity and will contribute to the significant enhancement of meteorological and climatic forecasts. Brazil will also provide the CIMEX instrument for flight on the Space Shuttle. CIMEX is an infrared camera designed to study geology and the environment. The Brazilian-led Large-Scale Biosphere-Atmosphere Experiment in Amazonia (LBA) is a multi-disciplinary, international research effort designed to improve our understanding of the Ama-

zon and its interaction with global change. NASA also intends to contribute significant research activities to LBA.

Finally, Brazil is sponsoring an EOS Interdisciplinary Science Investigation (see Interdisciplinary Science section), and several countries in Latin America are supporting EOS validation activities.

India

In late 1997, India's Departments of Space Science and Technology signed a Memorandum of Understanding (MOU) with NASA and NOAA that is targeted at cooperation in the areas of Earth and atmospheric sciences and also allows for the exchange of associated scientific data. Specific areas of scientific cooperation called out in the MOU include, but are not limited to: weather analysis and forecasting techniques (short-range to seasonal); evaluation of DMSP SSM/I data for use in flood forecasting, drought monitoring, and snow-melt runoff modeling; TRMM; satellite product development and improvement; surface and precipitation parameters (ocean and land); calibration of 1-kilometer resolution AVHRR data received in India with global land 1-kilometer AVHRR data and 4-kilometer GAC data from the U.S.; inter-comparison studies of SSM/I Pathfinder data for use in land surface studies (classification, temperature, vegetation); and activities in the atmospheric sciences/International Geosphere-Biosphere Program. This MOU with India also enabled the establishment of communication lines for the exchange of Earth and environmental science data. For the United States, the chief intent of the communication links is to provide the U.S. Government with real-time access to Indian geostationary satellite (INSAT) data, a scientific objective for 15 years. The improved severe weather forecasting ability that will be developed under this cooperation will save lives in the entire Indian Ocean region and will improve global data inputs to U.S. regional forecast models.

Australia and New Zealand

Australia is supporting one EOS Interdisciplinary Science Investigation (see Interdisciplinary Science section), as well as surface validation sites. In addition, Australia is supporting two scientists as members of the MODIS science team. New Zealand also supports EOS validation activities in collaboration with the University of Denver.

Africa

NASA is currently in discussions with South Africa, Botswana, Malawi, Mozambique, Namibia, Zambia, and Zimbabwe in support of the Southern African Regional Science Initiative 2000 (SAFARI 2000) program. This program includes a series of ground-based and airborne experiments throughout Southern Africa to be conducted in the 1999 and 2000 time frame. This science initiative

will study the effects of biomass burning and industrial and biogenic emissions on the southern African ecosystem and climate and validate these observations using ground-based and airborne measurements. In addition, NASA's EOS satellites, scheduled for launch in 1999 and 2000, will provide satellite-based measurements to complement the ground-based and airborne data collected for SAFARI 2000; and, in turn, SAFARI 2000 will provide validation for EOS satellite data.

NASA and South Africa are also cooperating on SUNSAT, a South African satellite that was launched on a NASA-provided expendable launch vehicle in February 1999. SUNSAT is carrying South African student-developed experiments and environmental monitoring instruments. SUNSAT is also carrying a NASA-provided satellite laser tracking retro-reflector and is another one of the suite of satellites to carry a NASA-provided GPS receiver for atmospheric, oceanic, and spacecraft navigation studies.

Major Satellite Missions in the International Earth Observing System

Some of the major satellite missions in the International Earth Observing System are shown in Tables 10a, 10b, and 10c.

Project	Partner	Contribution Type
SAC-C	Argentina Denmark	Spacecraft, instrument, mission operations and data analysis (MO&DA) Magnetic mapping payload
SOLCON	Belgium	Instrument on ATLAS, now flying as a Hitchhiker on the Space Shuttle
HSB	Brazil	EOS PM humidity sounder
CIMEX	Brazil	CCD Imaging Camera for Earth observation and technology demonstration
LBA	Brazil	NASA aircraft overflight support and in situ measurements
BOREAS	Canada	Satellite data collection; instruments; aircraft; PIs
MOPITT	Canada	Instrument on Terra spacecraft
Radarsat-1	Canada	SAR instrument/spacecraft
Oersted	Denmark France	Spacecraft; instruments; MO&DA
ERS-1/ERS-2	ESA	Spacecraft; instruments; launch; MO&DA
TOPEX/Poseidon	France	Instruments; launch; ongoing MO&DA
Jason-1	France	Spacecraft; instruments; validation; science; MO&DA
CHAMP	Germany	Spacecraft & launch
GRACE	Germany	ESSP mission; spacecraft and launch (a German-procured Russian launch)
SRTM	Germany	X-SAR instrument on Shuttle
ADEOS	Japan	Spacecraft; some instruments; launch
AMSR-E	Japan	Instrument on EOS PM
ASTER	Japan	Instrument on Terra spacecraft
TRMM	Japan	Launch; precipitation radar
JERS	Japan	Spacecraft; instruments; launch
OMI	Netherlands	Instrument on EOS CHEM
SAGE III/METEOR-3M	Russia	Spacecraft; launch
SUNSAT	South Africa	Spacecraft; instruments; MO&DA
SAFARI 2000	South Africa, Zimbabwe, Namibia, Botswana, Zambia	NASA aircraft overflight support; surface and in situ measurements
HIRDLS	UK	Subsystems for instrument on EOS CHEM
MLS	UK	Aspects of data algorithms, validation and analyses
INSAT	India	Access (with NOAA) to data from meteorological sensors on Indian INSAT satellites and in situ measurements
IRS-P3/MOS	India Germany	Spacecraft and launch MOS ocean color sensor
NASA-led Space Geodesy Program	Over 80 countries	VLBI/SLR/GPS system investment and operation
SCISAT *	Canada	Space science payload
ENVISAT *	ESA	Spacecraft; instruments; launch; MO&DA
PICASSO-CENA *	France	Platform; portions of instrument; spacecraft operations

* Potential cooperative initiatives currently under discussion

Table 9. Some of the Major Foreign Contributions to NASA's Earth Science Enterprise

ACTUAL/PROPOSED INSTRUMENT CONFIGURATION 1996 - 1999									
OBJECTIVES	RadarSat-1 November 1995	TOMS/EP June 1996	OrbView-2 705 km 98.2° Incl. 12:00 PM August 1997	TRMM 350 km 35° Incl. November 1997	NOAA-15 653 km 98.7° Incl. 7:30 AM May 1998	LandSat 7 705 km 98.2° Incl. 10:00 AM April 1999	QuikScat 803 km 98.6° Incl. 6:00 AM June 1999	ACRIMSAT 685 km 98.13° Incl. 10:50 AM October 1999	Terra 705 km 98.2° Incl. 10:30 AM November 1999
STATUS	APPROVED								
VS/R Imagers			SeaWiFS	VIRS	AVHRR-3	ETM+			ASTER MISR MODIS
Radiation Budget				CERES					CERES (2)
Passive Atmospheric Sounding					AMSU-A 1/2 AMSU-B HIRS-3				
Passive Microwave				TMJ					
Active Microwave				PR			SeaWinds		
Tropospheric Chemistry									MOPITT
Stratospheric Chemistry		TOMS							
Radar Altimeter									
Laser Altimeter									
Other				UIS	SEM ARGOS SAR			ACRIM III	
Operational Instruments					All Sensors				
Tropospheric Wind Lidar									

Solid-state laser technology development is under way in support of this objective

Table 10a. Some of the Major Satellite Missions in the International Earth Observing System

ACTUAL/PROPOSED INSTRUMENT CONFIGURATION 1999 (Continued) - 2000								
OBJECTIVES	IMPED-1 705 km 98.2° Incl. 10:00 AM December 1999	NOAA-L 870 km 98.7° Incl. 2:00 PM February 2000	METER 3M-1 1020 km 99.5° Incl. 9:15 AM March 2000	ENVISAT-1 800 km 98.6° Incl. 10:00 AM May 2000	Jason-1 1336 km 66° Incl. May 2000	ESSP-1/INCL 400 km 67° Incl. August 2000	ADEOS-II 803 km 94.6° Incl. 10:30 AM November 2000	EOS PM 705 km 98.2° Incl. 1:30 PM December 2000
STATUS	APPROVED							
VIS/IR Imagers	ALL Hyperion	AVHRR-3		AATSR MERIS			GLI POLDER	MODIS
Radiation Budget				SCARAB				CERES (2)
Passive Atmospheric Sounding		AMSU-A 1/2 AMSU-B HIRS-3						AIRS AMSU-A HSB
Passive Microwave				MWR	JMR		AMSR	AMSR-E
Active Microwave				ASAR			SatWinds	
Tropospheric Chemistry			SAGE III	SCIAMACHY				
Stratospheric Chemistry		SBUV-2	SAGE III	GOMOS MIPAS SCIAMACHY			ILAS-2	
Radar Altimeter				RA-2	Poseidon 2			
Laser Altimeter						MBLA		
Other		SEM ARGOS S&R		DORIS	DORIS GPS	GPS		
Operational Instruments		All Sensors						
Tropospheric Wind LiDAR								

Solid-state laser technology development is under way in support of this objective

Table 10b. Some of the Major Satellite Missions in the International Earth Observing System

ACTUAL/PROPOSED INSTRUMENT CONFIGURATION 2001 - 2003									
OBJECTIVES	NOAA-MI 833 km 10:00 AM 95.7° Incl. May 2001	ESSP-2/BRACE 485 km 89° Incl. June 2001	ICESat 600 km 94° Incl. July 2001	SORICE 600 km 40° Incl. July 2002	EOS CHEM 705 km 98.2° Incl. 1:45 PM December 2002	METOP-1 850 km 98.8° Incl. 9:00 AM 10/2003	International Space Station 51.6° Incl. March 2003	ESSP-3/ PICAARD-CENA 705 km 98.08° Incl. 1:30 PM March 2003	ESSP-4/ Cassini 705 km 98.08° Incl. 1:31 PM March 2003
STATUS	APPROVED								
VIS/IR Imagers	AVHRR-3					AVHRR-3		ABS WFC HIR	PABSI
Radiation Budget									
Passive Atmospheric Sounding	AMSU-A 1/2 AMSU-B HIRS-3				TES HIRDLS MLS OMI	IASI HIRS-4 AMSU-A MHS			
Passive Microwave									
Active Microwave						ASCAT			CPR
Tropospheric Chemistry					HIRDLS TES OMI		SAGE III		
Stratospheric Chemistry					HIRDLS OMI MLS	GOME	SAGE III		
Radar Altimeter									
Laser Altimeter			GLAS					LIDAR	
Other	SEM ARGOS S&R	HAIRS GPS SuperStar	GPS	TIM, SIM SOLSTICE XPS		ARGOS SEM S&R			
Operational Instruments	All Sensors					AVHRR-3 MHS, SEM AMSU-A HIRS-4, S&R ARGOS			
Tropospheric Wind Lidar									

Table 10c. Some of the Major Satellite Missions in the International Earth Observing System

Page intentionally left blank

Interagency Coordination

Interagency cooperation in the development and implementation of EOS continues to be extensive, especially among those agencies with space programs and/or significant responsibilities for archiving Earth science data. The National Space Policy revision issued September 19, 1996 requires NASA to undertake "a program of long-term observation, research and analysis of the Earth's land, oceans, and atmosphere and their interactions, including continual measurements from the Earth Observing System." The Policy also assigns related roles to the Departments of Commerce, Defense, Energy and Interior, to be performed in cooperation with NASA. NASA collaborates with these agencies and others in a variety of bilateral, trilateral, and multilateral arrangements. These and other agencies partner with NASA in the conduct of the U.S. Global Change Research Program (USGCRP). NASA's Earth Science Enterprise comprises approximately two-thirds of the USGCRP budget. EOS and the other programs of the Earth Science Enterprise have been planned to benefit from, and to complement, the capabilities of its Federal agency partners. The largest agency partners, with key roles defined in the following paragraphs, are:

- Department of Commerce/National Oceanic and Atmospheric Administration (DoC/NOAA),
- Department of Defense (DoD),
- Department of Energy (DoE), and
- Department of the Interior/U.S. Geological Survey (DoI/USGS).

Department of Commerce

NOAA conducts U.S. civil programs for operational Earth remote sensing. Since 1960, satellite observations of the global environment have been provided by NOAA's Polar-orbiting Operational Environmental Satellite (POES) system. Coverage of the Western Hemisphere has been provided by NOAA's Geostationary Operational Environmental Satellite (GOES) system since 1974. The current and future satellites of the POES and GOES systems are an essential part of the USGCRP. These satellites provide valuable precursor data, and will yield complementary

observations during the EOS mission lifetime. Furthermore, NOAA's long-term data record will be used to establish baseline conditions and to detect trends.

The present POES Program maintains two operational satellites in polar orbit—one providing morning (AM) coverage and the other afternoon (PM) coverage. The U.S. and Europe, the latter through EUMETSAT and ESA, have agreed in principle that Europe will take over responsibility for the AM global coverage mission in the 2003 time frame with the launch of the first Meteorological Operational (MetOp) satellite. NOAA will provide AM coverage through 2003, and will continue PM coverage. Through NOAA, the U.S. will provide a suite of four primary sensors for the European AM mission. EUMETSAT and others will reciprocate by supplying sensors and subsystems for flight on both the AM and PM satellites.

Planning for the cooperative program of global coverage by the U.S. and Europe includes arrangements to fly the NOAA/EUMETSAT operational payload in morning orbit and EUMETSAT's establishment of a high-latitude ground station to read out data from both the AM and PM platforms. This latter agreement ensures that data are downlinked each orbit, minimizing data latency and dependence on data averaging. With one European and two U.S. high-latitude stations, NOAA and EUMETSAT will essentially eliminate data delays associated with the recording of multiple or "blind" orbits. NOAA and EUMETSAT have agreed to establish systems and procedures to ensure the timely and full exchange of operational mission data.

Long-term improvements in NOAA satellite, instrument, and space subsystem design are expected to result from technology advances associated with the EOS Program. To this end, coordination in technology development extends to NASA's designating some EOS instruments as "prototypes" for future operational environmental satellites. In addition, teams have been established to look at the common requirements of research and operational programs and identify areas where further collaboration would be of mutual benefit in hardware, software, and algorithm development. Furthermore, NASA has been designated by the President as playing a lead role in the identification and promotion of new technology for the future converged National Polar-orbiting Operational Environmental Satellite System (NPOESS), working with DoD and NOAA in the Integrated Program Office.

Data products derived from POES and GOES observations are provided to users in near real-time and from archived data sets by NOAA; in addition, Pathfinder data sets are provided jointly by NASA and NOAA (see the Pathfinder Data Sets section). As a participant in the EOSDIS Program, NOAA will serve as the long-term archive for a major portion of EOS and other NASA mission oceanic and atmospheric data, and will continue to make available in situ data from its data centers. NOAA actively participates in the Committee on Earth Observation Satellites (CEOS) and in the U.S. Subcommittee on Global Change Research's Global Change Data Management Working Group (DMWG), where interagency data exchange arrangements and policies are planned and coordinated.

Department of Defense

DoD's Defense Meteorological Satellite Program (DMSP) maintains satellites in polar orbit to gather global environmental data. DMSP data and derived products have been made available to non-DoD users through NOAA. DMSP data will be available to global change researchers in standard formats via global change data networks.

DoD plans future satellites and instruments that will provide additional Earth system observations. Missions under consideration address ocean conditions, ozone and trace gas distributions, ionospheric airglow, and solar energy interactions with the atmosphere. DoD participates in planning for USGCRP and its associated data systems. In cooperation with the other Federal agencies involved in EOSDIS and related data systems, DoD is seeking workable approaches to make more of its relevant data available. Other working groups are being established to explore potential environmental remote-sensing collaborations between NASA and DoD.

NASA and the DoD's National Imagery and Mapping Agency (NIMA) are jointly undertaking the Shuttle Radar Topography Mission (SRTM) to be flown in 1999. SRTM consists of an interferometric capability added to the Space Radar Laboratory flown twice on the Space Shuttle in 1994. SRTM will produce the first Digital Terrain Model of the Earth's land surface between 60°N and 54° S.

Department of Energy

DoE develops and uses remote-sensing technology in many of its programs. The agency develops and tests climate models, and assesses the impacts associated with incidental environmental forcing functions. For instance, DoE has conducted a decade-long program to improve general circulation models and to provide reliable predictions of regional climate change in response to increases in atmospheric greenhouse gases. DoE holds da-

tabases acquired from a multitude of sources as tools for conducting its modeling and climate-prediction activities.

With respect to hardware, DoE has successfully miniaturized key components of space-based instrumentation, which adds a great deal of flexibility to Earth remote-sensing programs. Recent developments now enable the deployment of low-mass, low-volume sensors on conventional or small satellites. Miniaturization technology contributes to the effectiveness of USGCRP by allowing early deployment of small satellites. In an effort to exploit such technology advances, NASA and DoE have created a Joint Development and Demonstration Program in Advanced Remote-Sensing Technology, which has the objective of lowering the cost and improving the performance of remote sensors. The ultimate goal involves the development of remote-sensing technologies and concepts for space-based environmental applications. Four areas are currently under investigation: Laser detection of winds, high-resolution multispectral imaging, synthetic aperture radar, and unmanned aerospace vehicle (UAV) sensing.

The DoE'S Atmospheric Radiation Measurement (ARM) program presents an important opportunity for collaboration between DoE and EOS. The role of ARM is to provide intensive ground-based measurements of atmospheric properties at a few selected heavily instrumented sites. This DoE activity then presents a significant source of "ground truth" for calibration and validation of EOS space-based observations.

The Southern Great Plains site in Oklahoma was the first to be occupied and has now achieved a mature operational status. A second site in the tropical Western Pacific will comprise three island stations. The first (Manus) and second (Nauru) have been implemented with a third to be implemented in 1999 at Christmas Island. A site in Alaska is presently under development and supported field experiment activity there in 1998—NSF's Surface Heat Budget of the Arctic (SHEBA) experiment and the Arctic Cloud Experiment of NASA's Radiation Sciences Program. The ARM sites have been chosen to provide a sampling of continental (Southern Great Plains) and tropical oceanic (Tropical Western Pacific) conditions of clouds and radiation, and the radiation environment and the influence of clouds under polar conditions (North Slope of Alaska). These sites increasingly attract first-class experiments concerned with atmospheric processes and remote sensing with support from a variety of U.S. agencies.

ARM is supporting a program of unmanned aircraft (UAVs) that will serve as the platforms for relatively inexpensive instruments whose measurements will validate the radiation modeling for the atmosphere at the various ground-instrumented sites.

Along with the involved U.S. agencies, DoE is developing the networking capabilities to make its current and future global change archives more conveniently accessible to users. In the EOSDIS framework, DoE has agreed to manage the EOS biogeochemical dynamics

database and data from coordinated field experiments. This database will reside at the Oak Ridge National Laboratory (ORNL).

Department of the Interior

Management responsibility for the Nation's natural ecosystem, energy and water resources, and public lands is vested in DoI. Within DoI, the U.S. Geological Survey (USGS) is addressing the collection, maintenance, analysis, and interpretation of in situ short- and long-term land, water, biological, and other natural resource data and information. USGS is developing advanced information systems to provide enhanced access to existing and future archives of Earth science data through its primary archive for global change data—the Earth Resources Observation System (EROS) Data Center (EDC).

EDC houses the world's largest collection of space- and aircraft-based imagery of the Earth's land surface, including over 2 million images acquired from Landsat and other satellites, and over 8 million aerial photographs. EDC participates in the EOS Program by:

- operating the data center responsible for land processes information,
- communicating with the EOS science and instrument teams to ensure delivery of land-related products required for EOS investigations, and
- linking the USGS Global Land Information System (GLIS) to the EOSDIS Information Management System (IMS).

GLIS—an on-line data directory, guide, and inventory system—has been developed by EDC to respond to the land data and access needs of the global change research community.

Landsat data housed at EDC provide a 25-year baseline of information about land surface conditions and changes. As the operator of the National Satellite Land Remote-Sensing Data Archive, EDC has embarked upon a major program to convert the Landsat data archive to next-generation durable storage media, thereby avoiding loss of data stored on deteriorating magnetic tapes. In addition, EDC will serve as the processing, distribution, and archival facility for Landsat 7 and ASTER data.

Landsat 7 program management was restructured for a second time in 1999 to become a joint program between NASA and the U.S. Geological Survey (USGS), Department of the Interior. The 1992 Land Remote Sensing Policy Act initiated the Landsat 7 program as a joint DoD and NASA program. A Presidential Decision Directive, NSTC-3, dated May 5, 1994, reassigned responsibility for the development, launch, and operation of Landsat 7 to a joint NASA, NOAA, USGS program. In 1999, the

responsibility for management of post-launch operations was transferred from NOAA to the USGS. The program objectives are to provide data continuity with previous Landsat satellites, to make Landsat 7 data available to all users at the cost of fulfilling user requests, to capture a U.S.-held archive of Landsat 7 data providing global coverage of the Earth's continental and coastal surfaces, updated seasonally, and to develop a plan for acquiring follow-on Landsat-type data as a part of the EOS Program.

The USGS is participating with NASA and NIMA in the SRTM mission to be flown in 1999.

Interagency Convergence

Presidential Decision Directive/NSTC-2, signed on May 5, 1994, directed the convergence of the civil and military polar-orbiting environmental programs into a single integrated system. This consolidation was a key recommendation of the National Performance Review. The goal of the converged program is to reduce the cost of acquiring and operating polar-orbiting operational environmental satellites, while continuing to satisfy U.S. operational civilian and national security requirements.

Convergence of the follow-on satellite programs of the Department of Commerce/National Oceanic and Atmospheric Administration's (NOAA) Polar-orbiting Operational Environmental Satellite (POES) program, and the Department of Defense's (DoD) Defense Meteorological Satellite Program (DMSP) has already begun under the aegis of an Integrated Program Office (IPO), jointly staffed by NOAA, DoD, and NASA personnel. As part of the goal of reducing costs while enhancing the ability of the converged system to meet its operational requirements, the operational program will incorporate aspects of NASA's Earth Observing System where and as appropriate. The converged satellite system has been named the National Polar-orbiting Operational Environmental Satellite System (NPOESS).

The POES satellites currently provide civilian environmental monitoring. Key aspects of the POES mission include collecting atmospheric data to be used in conjunction with computer models for weather forecasting, measuring global ozone levels for climate change research, and monitoring emergency beacons for search and rescue operations. The purpose of the DMSP program is to collect and disseminate global visible and infrared cloud data and other specialized meteorological, oceanographic, and solar geophysical data to provide a survivable capability in support of military operations. Some of these observations form the bases of the NASA-NOAA Pathfinder Data Set Program (see Pathfinder Data Sets section of this Handbook).

The U.S. currently operates two NOAA POES and two DMSP meteorological satellites in polar orbit. Through convergence, the U.S. will transition to an on-orbit architecture of three low-Earth orbiting satellites.

Current plans call for the on-orbit constellation to comprise two U.S. satellites as well as a third European satellite (Metop) carrying U.S. and European operational and research instruments. The Metop series is a joint undertaking of the European Organization for the Exploitation of Meteorological Satellites (EUMETSAT) and the European Space Agency (ESA). Significant savings will be gained through the reduction of the required number of U.S. satellites from four to two, the transition to a converged U.S. spacecraft, and the near-term efficiencies of consolidating the command and control activities of the current operational spacecraft at NOAA's Suitland, Maryland, Satellite Operations Control Center (SOCC) in 1998.

The NPOESS program was formally approved for entry into the design and risk-reduction phase in March 1997. Competitive Phase B contracts were awarded on July 30, 1997 for five planned NPOESS payload sensors including a Visible and Infrared Imaging Radiometer Suite (VIIRS), Conical Microwave Imager Sounder (CMIS), Cross Track Infrared Sounder (CRIS), Ozone Mapper and Profiler Suite (OMPS), and a Global Positioning Sensor Occultation System (GPSOS). The IPO is also working with NASA and other agencies to implement acquisition plans for additional sensors to include an advanced, research quality atmospheric sounder, a total solar irradiance sensor, an Earth radiation budget sensor, and a dual-frequency altimeter. Studies are also underway to explore the development of instruments which could satisfy both NASA's research needs, and the IPO's operational needs (e.g., the IPO VIIRS instrument and the NASA MODIS instrument).

The first NPOESS spacecraft must be ready for launch in 2007 in order to back up the last satellites in the DMSP and POES series. The planning launch date for NPOESS C1 is 2009 and for NPOESS C2 is 2010, assuming no failures of the predecessor satellites. Current plans call for early flight of selected NPOESS sensors on DMSP and POES, to include an advanced sounder on NOAA N'. More information on NPOESS can be obtained from the NPOESS web site at: <http://www.laafb.mil/SMC/PK/NPOESS/rfp.htm>.

The National Science and Technology Council

The National Science and Technology Council (NSTC) is a standing, cabinet-level body chaired by the President and composed of the Vice President, the Assistant to the President for Science and Technology, the cabinet secretaries and agency heads with responsibilities for significant science and technology programs, and other White House officials. The principal purposes of the NSTC are to define clear national goals for federal science and technology investments and ensure that science, space, and technology policies and programs contribute effectively to the national goals.

In 1994, NSTC committees identified R&D priorities, and the NSTC, through the Office of Science and

Technology Policy and the Office of Management and Budget, provided federal agencies with coordinated budget guidance for Research and Development.

In recent years, there have been a number of thoughtful criticisms of the way the federal government has historically conducted environmental R&D. The piecemeal, single-issue-by-single-issue, agency-by-agency research programs once thought to be adequate to deal with the environment have been widely recognized as inadequate to deal with the complex air, land, sea, economic, and social issues associated with regional, national, and global concerns such as ocean transport of pollutants, atmospheric deposition, climate change and ozone-layer depletion, biodiversity, and sustainable development. Ensuring economic development in concert with environmental protection makes the need for stronger integration of social, economic, and environmental sciences critical as all stakeholders are drawn into the process of environmental decision making. The NSTC Committee on Environment and Natural Resources (CENR) was created as a new way to conduct coordinated, cost-effective, interdisciplinary research to address the important environmental issues of our time.

CENR has emphasized research to understand the potential consequences of long-term environmental change and to promote the efficient use of natural resources while sustaining ecosystems for future generations. Increased emphasis has been placed on the integration of social sciences and assessment end points into research planning in all of the CENR issue areas.

Efforts are being made throughout the CENR, with coordination by the Task Force on Observations and Data Management, to increase the efficiency with which the vast array of monitoring and other forms of data generated within the federal system are made available. This process will help to define better where true gaps in long-term monitoring exist and need to be filled.

The CENR consists of seven issue subcommittees created because they represent areas of important policy that transcend the interest of a single agency: Global Change; Biodiversity and Ecosystem Dynamics; Resource Use and Management; Water Resources and Coastal and Marine Environments; Air Quality; Toxic Substances and Hazardous and Solid Waste; and Natural Disaster Reduction.

The CENR has three crosscutting subcommittees: Risk Assessment, Social and Economic Sciences, and Environmental Technology (a joint subcommittee of CENR and the NSTC Committee on Civilian and Industrial Technology). The crosscutting subcommittees focus on themes common to the areas covered by the seven issue subcommittees and provide an additional mechanism for inter-agency coordination. Risk assessment, for example, plays an important role in issues such as the effects of toxic substances, biodiversity, loss of ecosystem integrity, natural disaster reduction, and effects of global change on

human health and ecosystem function. Social and economic sciences are critical to evaluating the impacts of human activities on local, regional, and global environments and human responses to natural disasters and environmental change. The Task Force on Observations and Data Management coordinates requirements and capabilities in these areas across the CENR research issues.

The CENR has identified the following five priority areas that cross all environmental R&D:

- *Ecosystem research* – to promote efficient use of natural resources while sustaining ecosystem integrity for future generations.
- *Observations and data management* – to ensure that the necessary measurements are made efficiently and that the data are widely available to all stakeholders in easily usable forms.
- *Socioeconomic dimensions of environmental change* – to understand the underlying human influences on the environment and the potential responses of society to change.
- *Environmental technology* – to protect the environment while stimulating economic growth and capturing emerging global markets.
- *Science policy tools* – to provide the tools (e.g., integrated assessment and risk models) required by policymakers for informed decisions on complex environmental and societal issues.

Page intentionally left blank

Mission Elements

TRMM	72
Landsat 7	72
QuikScat	75
Terra	75
ACRIMSAT	76
SAGE III Series	76
NMP/EO-1	77
Jason-1	77
ESSP Missions	77
VCL	
GRACE	
PICASSO-CENA	
Cloudsat	
ADEOS	78
ADEOS	
ADEOS II	
EOS PM	80
ICESat	80
EOS CHEM	81
EOS Follow-On Missions	81
POES Series	83
SORCE	84
NPP	84

Introduction

This section provides specifics on the space-based elements that make up the International Earth Observing System (IEOS). Refer to Figures 8a and 8b on pages 86 and 87 for a schedule of ongoing and planned U.S. and international partner Earth-observing missions. This timeline is not confined to IEOS; rather, it provides a fairly comprehensive listing of relevant Earth remote-sensing satellites, many of which do not receive attention in the following pages. The timeline intentionally encompasses missions beyond the scope of IEOS to show how IEOS fits into the larger scheme of Earth observations satellites. Given the long planning schedule (over ten years shown), this chart should be considered more of a planning document, accurate through the beginning of 1999. For reference, Figure 9 on page 88 illustrates the EOS program-level architecture.

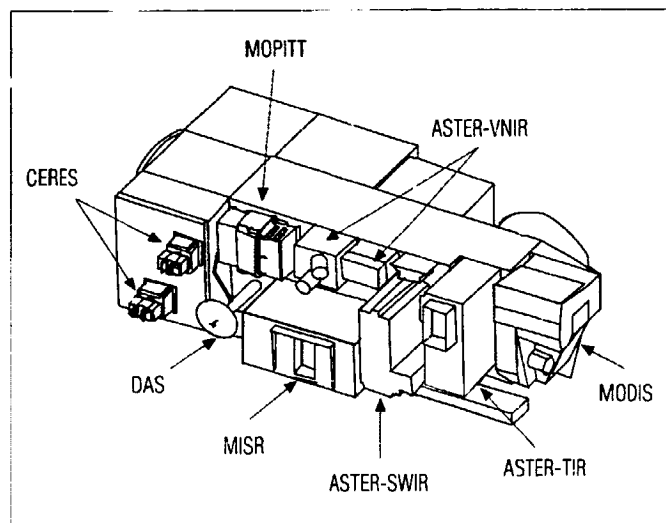
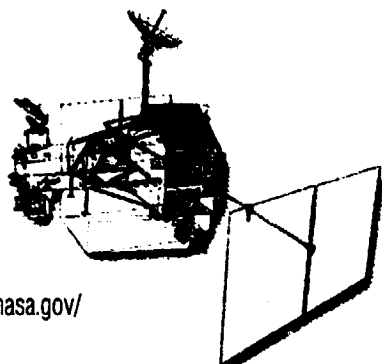

Figure 7. Terra Platform and Payload.

TRMM



<http://trmm.gsfc.nasa.gov/>

The Tropical Rainfall Measuring Mission (TRMM) is a joint U.S./Japan mission which was successfully launched on November 27, 1997 aboard a Japanese H-II rocket. The TRMM orbit is non-sun-synchronous at an altitude of 350 km. The objectives of TRMM are to measure rainfall and energy (i.e., latent heat of condensation) exchange of tropical and subtropical regions of the world. The primary rainfall instruments on TRMM are the TRMM Microwave Imager (TMI), the Precipitation Radar (PR), and the Visible and Infrared Radiometer System (VIRS). Additionally, the TRMM satellite will carry two related EOS instruments: The Clouds and the Earth's Radiant Energy System (CERES) and the Lightning Imaging Sensor (LIS).

The combination of satellite-borne passive and active sensors is beginning to provide critical information regarding the three-dimensional distributions of precipitation and heating in the tropics. Coincident measurements from the TRMM Microwave Imager (TMI) and the Precipitation Radar (PR) are complementary: Passive microwave radiometers measure the integrated effects of liquid and ice along the instrument viewing direction while active microwave sensors (radars) provide specific height information on liquid and ice within the cloud.

The Visible and Infra-Red Scanner (VIRS) on TRMM adds cloud top temperatures and structures to complement the descriptions from the radar and radiometer. While direct precipitation information from VIRS is less reliable than that obtained by the microwave sensors, VIRS serves an important role as a bridge between the high quality but infrequent observations from TMI and PR with the more-available data and longer time series data available from the geostationary VIS/IR satellite platforms.

The Clouds and the Earth's Radiant Energy System (CERES), and the Lightning Imaging System (LIS), while designated as EOS instruments, still play an important role in the TRMM mission to round out the scientific objectives. LIS, aside from mapping the global frequency of lightning events, will play an important role in coupling the occurrence of lightning to the precipitation, thus enhancing our overall understanding both of lightning and of precipitation processes. CERES allows for determination of the total radiant energy balance. Together with the

latent heating derived from the precipitation, a significantly improved picture of the atmospheric energy system can emerge.

TRMM data are sent to GSFC via TDRSS and the White Sands Receiving Station. The TRMM Data and Information System (TDIS) at GSFC is responsible for all science data processing and data distribution to the TRMM algorithm development team. After an initial checkout period, the data are sent to the Goddard DAAC for archival and distribution to the general user community. Preliminary Level 1 data were released to the public on June 1, 1998.

Landsat 7

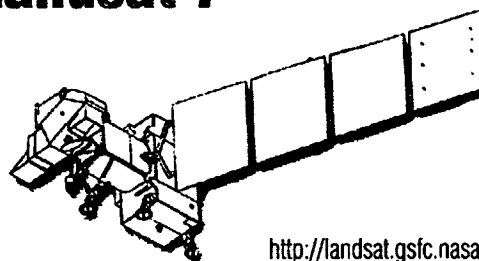

<http://landsat.gsfc.nasa.gov/>

Landsat 7 is the latest in a series of satellites that have provided a continuous set of calibrated Earth science data to both national and international users since 1972.

Landsat Chronology

The first Landsat, originally called Earth Resources Technology Satellite (ERTS-1), was developed and launched by NASA in July 1972. Subsequent Landsat launches occurred in January 1975 and March 1978. In the meantime, a second generation of Landsat satellites was developed. Landsat 4 was launched in July 1982 and Landsat 5 in March 1984. Landsat images are still being received from Landsat 5. As a result, a continuous set of Landsat remotely sensed images of the Earth's land surface and surrounding coastal regions from mid-1972 until the present is available.

Over the past 27 years scientists have developed a wide range of applications using Landsat data for global-change research, regional environmental studies, national security, and other civilian and commercial purposes. For example, Landsat data have been used to monitor agricultural productivity, urban growth, and land-cover change, and are used widely for oil, gas, and mineral exploration. Other science applications include monitoring volcanoes, glacier dynamics, agricultural productivity, and coastal conditions.

Authorized by Public Law 102-555 in October 1992, Landsat 7 continues the Landsat tradition as part of NASA's Earth Science Enterprise. The science mission of Landsat 7 is targeted to regional and global assessments of land-cover dynamics. For the first time, Landsat 7 will systematically acquire imagery from across the globe using a Long-term Acquisition Plan. This will insure a data archive recording the full seasonal and inter-annual changes in the vegetation patterns of the planet, while minimizing the effects of cloud cover.

While NASA's other EOS instruments MODIS and MISR will acquire frequent, coarse views of land-cover change, the spatial resolution of ETM+ data from Landsat will allow researchers to determine the actual causes of observed landcover changes. These changes have important implications, both for local habitability and for the global cycling of carbon, nitrogen, and water.

In 1994 President Clinton originally assigned management of the Landsat Program jointly to NASA, the National Oceanic and Atmospheric Administration (NOAA), and the United States Geological Survey (USGS). However, in March 1999, this management structure was streamlined to include NASA and USGS only. Currently, NASA is responsible for the development and launch of the satellite and the development of the ground system, and USGS is responsible for operating the satellite, distributing the data, and maintaining an archive of Landsat 7 and other remotely sensed data.

With Landsat 5 recently surpassing 15 years of continuous operation on orbit, Landsat 7 will provide much-needed continuation of land remote-sensing data critical to understanding environmental change and will support a broad range of other important Earth science and Earth resource applications.

The Landsat 7 Program objectives are:

- To maintain Landsat data continuity by providing data that are consistent in terms of data acquisition, geometry, spatial resolution, calibration, coverage characteristics, and spectral characteristics with previous Landsat data.
- To generate and periodically refresh a global archive of substantially cloud-free sun-lit land-mass imagery.
- To continue to make Landsat-type data available to U.S. and international users at the cost of fulfilling users requests, and expand the use of such data for global change research and commercial purposes.

Landsat 7 Flight Segment

Landsat 7 was launched from Vandenberg Air Force Base by a Delta-II Expendable Launch Vehicle on April 15, 1999. The Landsat 7 satellite consists of a spacecraft bus

and a single instrument, the Enhanced Thematic Mapper Plus (ETM+) (see the EOS Instruments section of this Handbook).

Like its predecessors, Landsat 7 will produce Landsat scenes based on the World Wide Reference System, a catalogue of 57,784 land mass and coastal scenes, each 185-km wide by 170-km long. The orbit altitude is approximately 705 km, with a sun-synchronous 98° inclination and a descending equatorial crossing time of 10:00 a.m. and a 16-day repeat cycle.

A state-of-the-art solid-state recorder capable of storing 380 gigabits of data (100 scenes) is used to store selected scenes from around the world for playback over the U.S. ground station at the EROS Data Center in Sioux Falls, South Dakota. Additional U.S. ground stations are operated in Alaska and Svalbard, Norway. In addition, real-time data from the ETM+ can be transmitted to co-operating international ground stations or to U.S. ground stations on command.

Landsat 7 Ground Segment

The ground system includes the spacecraft Mission Operations Control Center, which has been built and is operational at the Goddard Space Flight Center (GSFC) in Greenbelt, Maryland. This Landsat 7-unique facility, augmented by other existing NASA institutional facilities, are utilized to control all spacecraft and instrument operations for at least two years after launch. Flight operations are controlled from GSFC with commands uplinked via the Landsat Ground Station in Sioux Falls and NASA TDRSS.

In addition to the Mission Operations Control Center, NASA has built all data processing and distribution components of the Landsat 7 system. These components have been integrated into the USGS EDC in South Dakota. After launch and on-orbit activation and verification of the satellite and data processing and distribution components, the data processing, archive and distribution portions of the ground system will be turned over by NASA to USGS for operation. NASA will continue to operate the Mission Operations Center at Goddard Space Flight Center on USGS' behalf through fiscal year 2000.

Landsat 7 scientific data are being downlinked, processed, and distributed by the USGS EDC in Sioux Falls, South Dakota. The ground system at EDC is capable of capturing and processing 250 Landsat scenes per day and delivering at least 100 scenes to users each day via the EDC Distributed Active Archive Center (DAAC).

Landsat 7 data will be available for ordering within 24 hours after they have been received at EDC. Users query metadata and browse images to determine if the archive contains data files suitable for their use. Data requested can be delivered either electronically or in a digital format on electronic tape or CD-ROM by common carrier.

Landsat 7 Calibration and Validation

Calibration is essential to the role of Landsat 7 in the EOS era. In order to realize the full potential of the integrated remote sensing systems under development by the Office of Earth Science, Landsat 7 data must be used in concert with data from the other satellites.

Special solar calibrators on Landsat 7 will allow much improved ETM+ calibrations relative to the earlier Thematic Mapper (TM) and Multi-Spectral Scanner (MSS) sensors on Landsats 4 and 5. These new full- and partial-aperture solar calibrators will permit use of the sun, with its known exo-atmospheric irradiance, as an absolute radiometric calibration source.

The data provided by the on-board solar calibrators will be augmented by an internal calibration lamp and occasional ground-based validation experiments. These calibration procedures will permit the Landsat 7 data to be radiometrically corrected to within 5 percent and to geometrically locate the scene on the Earth to within 250 m. This level of accuracy is consistent with the radiometric requirements for the other EOS sensors, allowing easier integration with data from other EOS satellites.

Landsat 7 Level 0R Products

The primary user product is Level 0R data—an essentially raw data form that is marginally useful prior to radiometric and geometric correction. A Landsat 7 0R product contains all the ancillary data required to perform these corrections including a Calibration Parameter File (CPF) generated by the Landsat 7 Image Assessment System.

The Landsat 7 Processing System (LPS) spatially reformats Earth imagery and calibration data into Level 0R data. This involves shifting pixels by integer amounts to account for the alternating forward-reverse scanning pattern of the ETM+ sensor, the odd-even detector arrangement within each band, and the detector offsets inherent to the focal-plane-array engineering design. All LPS Level 0R corrections are reversible; the pixel shift parameters used are documented in the CPF.

Landsat 7 Level 1R Products

The Level 1R product is a radiometrically corrected 0R product. Radiometric correction is performed using either gains in the Calibration Parameter File or gains computed on the fly from the Internal Calibrator (IC). The choice is available to a user when the product is ordered. The biases used are always calculated from the IC data. Image artifacts such as banding, striping, and scan-correlated shift are removed prior to radiometric correction. Radiometric corrections are not reversible. The Level 1R product geometry is identical to the input Level 0R data.

During Level 1R product rendering, image pixels are converted to units of absolute radiance using 32-bit float-

ing point calculations. Pixel values are then multiplied by 100 and converted to 16-bit integers prior to media output. Two digits of decimal precision are thus preserved. The 16-bit 1R product has twice the data volume of a like 0R product.

Landsat 7 Level 1G Products

The Level 1G product is a radiometrically and systematically corrected 0R image. The correction algorithms model the spacecraft and sensor using data generated by onboard computers during imaging events. Primary inputs are the PCD, which includes the attitude and ephemeris profiles, and the mirror scan correction data. Refined parameters from the CPF are also used to improve the overall geometric fidelity of the Level 1G product.

During processing the Level 0R image data undergoes two-dimensional resampling according to user-specified parameters including output map projection, rotation angle, pixel size, and resampling kernel. The following seven map projections are supported:

- Universal Transverse Mercator
- Lambert Conformal Conic
- Transverse Mercator
- Polyconic
- Oblique Mercator
- Polar Stereographic
- Space Oblique Mercator

The end result is a geometrically rectified product free from distortions related to the sensor (e.g., jitter, view-angle effects), satellite (e.g., attitude deviations from nominal), and Earth (e.g., rotation, curvature).

The systematic Level 1G correction process does not employ ground control or relief models to attain absolute geodetic accuracy. Residual error in the systematic Level 1G product will be approximately 250 meters (1 sigma) in flat areas at sea level. Precision correction employs ground control points to reduce geodetic error of the output product to approximately 30 meters. This accuracy is attained in areas where relief is moderate.

Terrain-correction processing, employing both ground control points and digital elevation models, can further reduce geodetic error of the output product to less than 30 meters in areas where terrain relief is substantial. Users requiring higher level products of this accuracy would be best served ordering Level 0R data for in-house processing or contacting a value-added service organization with such capabilities.

Landsat 7 Data Product Formats

Landsat 7 Level 0R and 1R data products are packaged in Hierarchical Data Format (HDF)—an open standard selected by NASA for Earth Observing System (EOS) data

products. HDF is a self-describing format that allows an application to interpret the structure and contents of a file without outside information. HDF allows Landsat 0R and 1R products to be shared across different computer platforms without modification and is supported by a public-domain software library consisting of access tools and various utilities.

Product users are directed to the Landsat 7 0R Distribution Product Data Format Control Book, Volume 5 (PDF) for details regarding the HDF design used for the 0R product. Included are references to NCSA-authored documentation. New users should begin with "Getting Started with HDF" while the HDF User's Guide and HDF Reference Manual are excellent resources for the HDF programmer.

The HDF Level 0R and Level 1R formats are nearly identical. Exceptions include the united PCD and MSCD files and an enhanced product-specific metadata file that reflects Level 1R correction characteristics. Additional information unique to the Level 1R product can be found in the ESDIS Level 1 Product Generation System Output Files DFCB.

Level 1G data products are available in HDF, FAST, and GeoTIFF formats. The Level 1G HDF product is also described in the Landsat 7 0R Distribution Product Data Format Control Book, Volume 5 (PDF) and the ESDIS Level 1 Product Generation System Output Files DFCB.

A derivative of the Fast Format (Fast-L7) used by Space Imaging, formerly EOSAT, for Landsat (FAST-B) and Indian Remote Sensing products (Fast-C) was created for Landsat 7 Level 1G products. A full description of the Fast L-7 Format can be found in the the ESDIS Level 1 Product Generation System Output Files DFCB.

Level 1G Geographic-tagged-image file format (GeoTIFF) is based on Adobe's TIFF—a self-describing format developed to exchange raster images such as clipart, logotypes, and scanned images between applications and computer platforms. For detailed information regarding the Landsat 7 GeoTIFF format please refer to the the ESDIS Level 1 Product Generation system Output Files DFCB. For GeoTIFF details, please refer to the GeoTIFF Format Specification.

QuikScat Mission

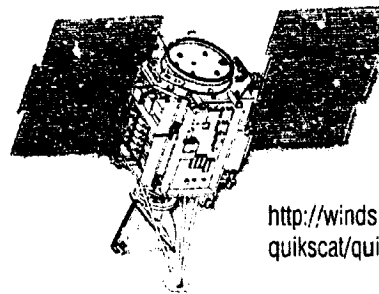

<http://winds.jpl.nasa.gov/missions/quikscat/quikindex.html>

QuikScat is a rapid response mission designed to acquire global radar backscatter and ocean surface wind speed and direction data using the SeaWinds scatterometer instrument. Flight of QuikScat minimizes the gap in broad-swath vector wind data caused by the loss of the ADEOS spacecraft and its NASA Scatterometer (NSCAT) in June, 1997. A second SeaWinds instrument will fly on the ADEOS-II mission, planned for launch in late 2000. The QuikScat spacecraft was built by Ball Aerospace and the mission was ready for flight in November, 1998. QuikScat was successfully launched on June 19, 1999 onboard a Titan-II launch vehicle (the mission was delayed for 7 months owing to a series of Titan launch failures). QuikSCAT is in a sun-synchronous (803 km altitude) orbit. Following initial validation, SeaWinds/QuikScat will provide ocean vector wind data with an accuracy and resolution equivalent to NSCAT. The broad-swath measurements will allow nearly 90% of the global oceans to be covered on a daily basis. QuikScat is planned to operate continuously for at least two years, thereby acquiring unique vector wind data and providing at least a 6 month overlap with the ADEOS-II/SeaWinds mission.

Terra

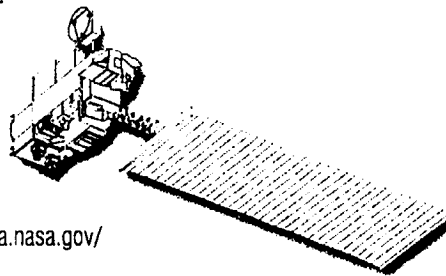

<http://terra.nasa.gov/>

Planned for launch in 1999, the Terra flight includes five instruments to be placed into a polar, sun-synchronous, 705-km orbit by an Intermediate Expendable Launch Vehicle (IELV) Atlas IIAS. The launch will take place from the U.S. Air Force Western Space and Missile Center

(WSMC). The payload consists of ASTER, CERES (dual scanner), MISR, MODIS, and MOPITT.

Terra will have a descending equatorial crossing time of 10:30 a.m., when daily cloud cover is typically at a minimum over land such that surface features can be more easily observed. The instrument complement is intended to obtain information about the physical and radiative properties of clouds and aerosols (ASTER, CERES, MISR, MODIS); air-land and air-sea exchanges of energy, carbon, and water (ASTER, MISR, MODIS); measurements of important trace gases (MOPITT); and volcanology (ASTER, MISR, MODIS). CERES, MISR, and MODIS are provided by the U.S., MOPITT is provided by Canada, and ASTER is provided by Japan. The Terra spacecraft design (see Figure 7 on pg. 71) will support an instrument mass of 1,155 kg, an average power for spacecraft and instruments of 2.5 kW (3.5 kW peak), and an average data rate of 18 Mbps (109 Mbps peak). Onboard solid-state recorders will collect at least one orbit's data for playback through TDRSS, even though a playback on each orbit is planned.

Follow-on missions are planned to continue the key measurements to be made by Terra. The objective is to benefit from technological advances being made in the small-satellite arena to reduce the overall life-cycle cost of the program, while maintaining the commitment to provide continuity of critical observations made by the Terra mission.

The Terra spacecraft will also include the Direct Access System (DAS), which is composed of the Direct Playback (DP) subsystem, the Direct Broadcast (DB) subsystem, and the Direct Downlink (DDL) subsystem. Terra data will be recorded and played back via TDRSS, and DAS will provide a backup option for direct transmittal of onboard data to ground receiving stations via an X-band transmitter (DP subsystem) should the satellite lose its TDRSS link. DAS will also support transmission of data to ground stations of qualified EOS users around the world who require direct data reception. These users fall into three categories:

- EOS team participants and interdisciplinary scientists who require real-time data to conduct or validate field observations, to plan aircraft campaigns, or to observe rapidly changing conditions in the field;
- International meteorological and environmental agencies that require real-time measurements of the atmosphere, storm and flood status, water temperature, and vegetation stress; and
- International partners who require receipt of data from their high-volume EOS instruments at their own analysis centers for engineering quality checks and scientific studies.

The DB subsystem will broadcast MODIS data at 13 Mbps. At this rate, properly equipped ground stations can receive, process, and display the swath data as the EOS spacecraft passes within range.

ACRIMSAT

<http://acrim.jpl.nasa.gov/>

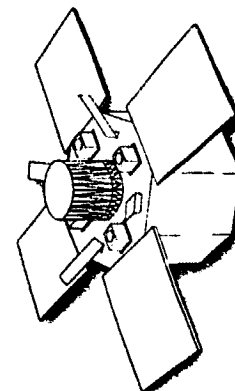

The ACRIMSAT spacecraft is scheduled for launch in October 1999 carrying the Active Cavity Radiometer Irradiance Monitor (ACRIM) III. The intent of the experiment is to monitor the Total Solar Irradiance (TSI) with maximum precision and provide an important link in the long-term TSI database. The ACRIM III experiment will provide all solar-maximum TSI results in solar cycle 23.

The science objectives of the mission are to extend the TSI database accumulated by Nimbus7/ERB, SMM/ACRIM I, UARS/ACRIM II, and SOHO/VIRGO and to contribute data to the U.S. Global Change Research Program to understand solar influences on climate.

SAGE III Series

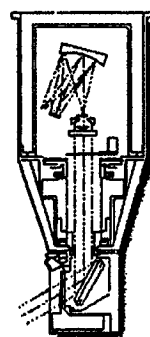

<http://aesd.larc.nasa.gov/GL/GLE/text/sage.html>

A SAGE III instrument will be placed into a high-inclination orbit on a Russian Meteor 3M-1 spacecraft in 1999 and into a mid-inclination orbit (51.6°) on the International Space Station (ISS) in 2003. Plans are underway to identify a flight platform for this mission. A combination of high- and low-inclination orbits is required to optimize collection of occultation data at all latitudes. SAGE III

will make long-term trend measurements of aerosols, ozone, water vapor, and clouds from the middle troposphere through the stratosphere—important parameters for radiative and atmospheric chemistry models.

NMP/EO-1

<http://eo1.gsfc.nasa.gov/>

Earth Observing-1 (EO-1), planned for launch in late 1999, is the first of the NMP Earth science technology missions. One of the key objectives of this mission is to ensure the continuity of future Landsat data. EO-1 will validate advanced technologies contributing to the reduction in cost of Landsat follow-on missions. EO-1 will fly at an altitude of 705 km at an inclination of 98.2° in a sun-synchronous orbit with an equatorial crossing of nominally 10:01 a.m. EO-1 orbit will be a sun-synchronous orbit at the same altitude but slightly offset from that of Landsat 7, such that the EO-1 spacecraft will fly over the same ground track as Landsat 7 but approximately one minute behind. This mission will provide paired scene comparisons between the EO-1 Advanced Land Imager (ALI) and the Landsat 7 Enhanced Thematic Mapper Plus (ETM+) imager. ALI employs a pushbroom data acquisition method and has multispectral capabilities ranging from 0.4 to 2.5 μm . In addition to ALI, EO-1 carries Hyperion, a hyperspectral scanner. The required mission life is one year, with possible extended operation.

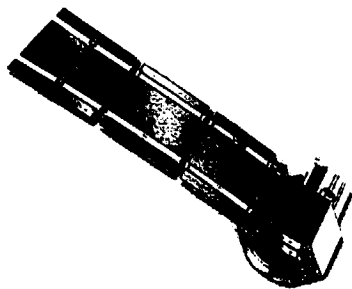

Jason-1

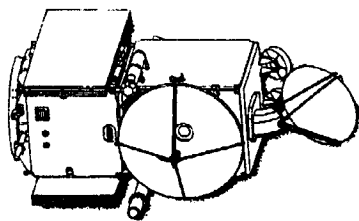

<http://topex-www.jpl.nasa.gov/jason1/>

The global sea-surface topography measurements currently being provided by the TOPEX/Poseidon mission

are of unparalleled accuracy and are providing a critically needed ability to monitor accurately the global ocean circulation at a temporal resolution of 10 days. These data provide new opportunities for monitoring ocean phenomena and developing models to predict long-term global change.

The need for continuing these measurements has been jointly recognized by NASA and CNES, with the result of a follow-on cooperative mission called Jason-1. Jason-1 is intended to be the first in a series of semi-operational satellites for oceanographic applications and research. Jason-1 will be flown in the same 66° inclination non-sun-synchronous orbit as TOPEX/Poseidon, flying in formation with TOPEX for the first 6 months (or as long as TOPEX lasts). The primary instrument on Jason-1 will be the CNES solid-state altimeter, a dual-frequency altimeter, Poseidon-2, based on the currently flying Poseidon altimeter. The altimeter instrument suite includes the Jason Microwave Radiometer, a new technology radiometer utilizing MMIC technology and reduced in mass from the TOPEX radiometer by an order of magnitude. The Precision Orbit Determination package includes the GPS Receiver, DORIS, and a Laser Retroreflector Array. The instruments will be integrated with the new PROTEUS smallsat spacecraft from CNES/Aerospatiale, and launched in 2000.

ESSP Missions

<http://essp.gsfc.nasa.gov/>

The Earth System Science Pathfinder (ESSP) program provides a new Office of Earth Science (OES) capability for addressing global-change research. It provides a periodic “window of opportunity” to accommodate new scientific priorities and infuse new scientific participation into the OES program. The ESSP program will consist of small, quick-turnaround, low-cost missions launched on a yearly basis. Four missions have been selected from proposals submitted in response to the two ESSP Announcements of Opportunity: Vegetation Canopy Lidar (VCL), Gravity Recovery and Climate Experiment (GRACE), Pathfinder Instruments For Cloud And Aerosol Spaceborne Observations-Climatologie Etendue des Nuages et des Aerosols (PICASSO-CENA), and Cloudsat with an advanced cloud-profiling radar.

VCL

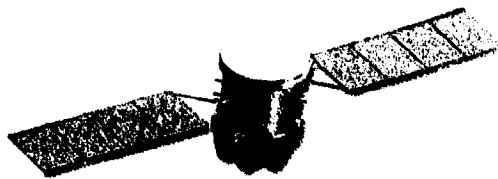

VCL will characterize the three-dimensional structure of the Earth by using a multi-beam laser to measure vegetation-canopy height and vertical distribution, and ground-surface topographic elevations to within one meter. These data will be used for two main science objectives:

- Landcover characterization for terrestrial ecosystem modeling, monitoring and prediction, and climate modeling and prediction; and
- global reference data sets of topographic spot heights and transects.

GRACE

GRACE, to be launched in July 2001, will produce a new model of the Earth's gravity field with unprecedented accuracy every 12-to-15 days for 5 years. GRACE unravels global climatic issues by:

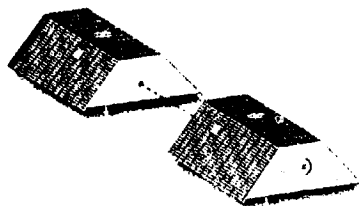

- Measuring the meanderings of ocean bottom currents;
- enabling a better understanding of ocean surface currents and ocean heat transport;
- watching the mass of the oceans change;
- watching the varying size of ice sheets and glaciers; and
- monitoring soil moisture and the state of major aquifers.

PICASSO-CENA

PICASSO-CENA, which is to be launched in March 2003, will employ light detection and ranging (lidar) instru-

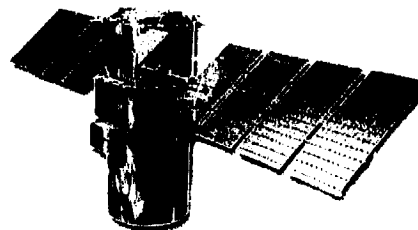

mentation to profile the vertical distribution of clouds and aerosols, while another instrument will simultaneously image the infrared (heat) emission of the atmosphere. During the daylight half of its orbit, PICASSO-CENA will measure the reflected sunlight in an oxygen absorption band and take images of the atmosphere with a wide-field camera. PICASSO-CENA, together with EOS satellites, will establish the scientific basis for understanding the dynamics and energetics of the Earth's atmosphere in support of short-term weather and long-term climate forecasts.

Cloudsat

Cloudsat, which will fly in 2003, is a mission focused on understanding the role of optically thick clouds on the Earth's radiation budget. It will use

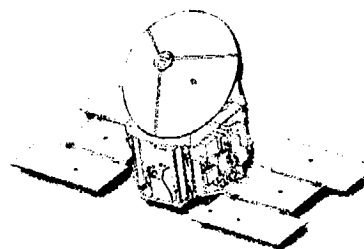

an advanced cloud-profiling radar to provide information on the vertical structure of highly dynamic tropical cloud systems. This new radar will enable measurements of cloud properties for the first time on a global basis, revolutionizing our understanding of cloud-related issues.

ADEOS Missions

Japan launched the polar-orbiting ADEOS mission in August 1996. It was designed for a 3-year mission lifetime. Early termination of ADEOS in June 1997 resulted from solar-array failure. ADEOS II is expected to be launched in December 2000. The objectives of ADEOS include Earth surface, atmospheric, and oceanographic remote sensing. ADEOS II will be launched into a sun-synchronous, 98.6° inclination orbit with an 800-km altitude, and an equatorial crossing time of 10:30 a.m. The

ADEOS satellite had a ground-track repeat cycle of 41 days, providing global OCTS coverage every 3 days and daily coverage (sampled) for AVNIR.

ADEOS

<http://echo.gsfc.nasa.gov/adeos/adeos.html>

ADEOS, launched in 1996, flew the following instruments:



- AVNIR – Five visible/near-infrared bands (0.42-0.89 μm); 16- or 8-m resolution; 80-km swath; $\pm 40^\circ$ across-track pointing; stereo capability; observation of sunlight reflected by the Earth's surface (developed by NASDA).
- ILAS – Infrared occultation device; one visible band at 0.753-0.784 μm , and one infrared band at 6.21-11.77 (16-cm^{-1} resolution); 2-km IFOV; observations from 10-60 km, approximately 2-km vertical resolution; retrieval of stratospheric ozone and related species at high latitudes (provided by Japan's Environmental Agency).
- IMG – Nadir-looking Fourier transform infrared spectrometer; range 3.3-14.0 μm , with a spectral resolution of 0.1 cm^{-1} ; $\sim 8\text{ km}^2$ foot print; vertical resolution $\sim 2\text{-}6\text{ km}$ depending on species; observation of carbon dioxide, methane, and other greenhouse gases (provided by MITI).
- NSCAT – 14 GHz (Ku band) scatterometer; resolution of 25 km; two 600-km swaths; used for retrieval of wind speed and direction over the oceans (provided by NASA).
- OCTS – Six visible bands centered on 0.412, 0.443, 0.490, 0.520, 0.565, and 0.670 μm , 20-nm bandwidth, S/N = 450-500; two near-infrared bands centered on 0.765 and 0.865 μm , 40-nm bandwidth, S/N = 450-500; four thermal-infrared bands centered on 3.7, 8.5, 11.0, and 12.0 μm , 330- to 1,000-nm bandwidth, NEDT 0.15 to 0.20 K at 300 K; 700-m resolution; 1,400-km swath; $\pm 20^\circ$ along-track tilting; measurement of ocean color and sea-surface temperature (developed by NASDA).
- POLDER – Views $\pm 55^\circ$ (cross- and along-track); $7 \times 6\text{-km}$ nadir footprint; nine bands in the visible and near-infrared, 0.443 to 0.910 μm with 10- to 20-nm bandwidth; all-polarization measurements in three of the nine bands (provided by CNES).

- RIS – 0.5-m diameter corner-cube retro-reflector to derive column density of ozone and trace species from laser absorption measurements. A ground station in the Kanto area transmitted and received laser pulses in the wavelength region from 0.4 to 14 μm (provided by Japan's Environmental Agency).
- TOMS – Six wavelength bands in the region from 0.3086-0.360 μm , with 1-nm bandpass; IFOV 92 km at nadir; cross-track scan 108° (37.3° steps); retrieved daily global ozone (provided by NASA).

ADEOS-II

http://yyy.tksc.nasda.go.jp/Home/Projects/ADEOS-II/index_e.html

ADEOS II, to be launched in December 2000, will be the main Japanese contribution to IEOS, since the prior ADEOS mission falls more within the framework of ESE Phase I than the EOS era (see Earth Science Enterprise section of this Handbook). The basic design of ADEOS II is under way. It will have orbital specifications similar to those of the ADEOS mission. AMSR-E and GLI will be the core facility instruments, to be complemented by ILAS-2, POLDER, and SeaWinds.

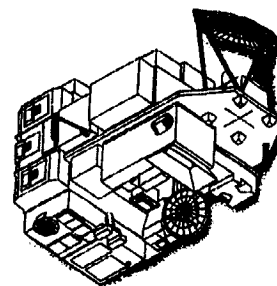

- AMSR-E – Advanced Microwave Scanning Radiometer designed to observe atmospheric and oceanic water vapor profiles, precipitation, water vapor distribution, cloud water, sea surface temperature, sea ice, and sea surface wind speed; employs six frequencies in the 6 to 90 GHz range, with vertical and horizontal polarization, to secure a temperature resolution of 0.2-to-1 K, at 1 K (goal) radiometric accuracy; instrument design employs a 2-m antenna aperture.
- GLI – Imaging spectrometer for global monitoring of biological and physical processes in the spectral range from the ultraviolet to the thermal infrared; 36 bands, with a bandwidth of 10 nm to 1 μm and a signal-to-noise ratio of less than 1,000; 1,600-km swath; instantaneous field-of-view of less than 1 km (some bands are 250 m); instrument design based on OCTS (ADEOS) and MODIS heritage.
- ILAS-II – Consists of two channels additional to those on ILAS

- **POLDER** – Views $\pm 55^\circ$ (cross- and along-track); 7x6-km nadir footprint; nine bands in the visible and near-infrared, 0.443 to 0.910 μm with 10- to 20-nm bandwidth; all-polarization measurements in three of the nine bands (provided by CNES).
- **SeaWinds** – The SeaWinds scatterometer will provide high accuracy wind speed and direction measurements over at least 90% of the ice-free global oceans every 2 days. SeaWinds will provide a continuing set of long term wind data for studies of ocean circulation, climate, air-sea interaction and weather forecasting. SeaWinds is a follow-on to the NASA Scatterometer (NSCAT) which is a sensor on ADEOS and will, like NSCAT, provide measurements of ocean surface winds in all weather and cloud conditions. SeaWinds improves on NSCAT by using scan-beam rather than fan-beam technology. For more information about SeaWinds see the Instruments Section.

craft will include the Direct Broadcast (DB) and Direct Playback (DP) capabilities of DAS (see the Terra write-up), with the DB subsystem transmitting all instrument data.

The EOS PM spacecraft design will support an instrument mass of 1,100 kg, average power for the instruments of 1,200 W (1,630 W peak), and an average data rate of 7.7 Mbps (12.5 Mbps peak).

As with Terra, follow-on missions are planned to continue the key measurements to be made by EOS PM. In addition, discussions are underway with the Integrated Program Office (IPO) to identify common observational capabilities between EOS PM and the National Polar-orbiting Operational Environmental Satellite System (NPOESS). To the extent that such common capabilities can be identified, the EOS PM follow-on mission may be modified; however, the continuity of basic observations beyond the EOS PM mission remains a major priority of NASA.

EOS PM

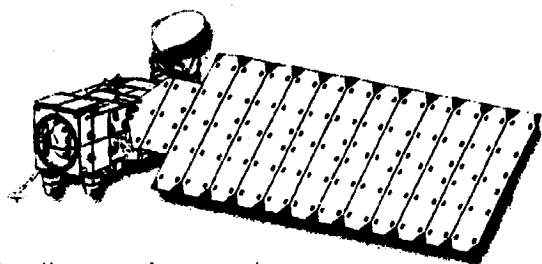

<http://eos-pm.gsfc.nasa.gov/>

Current plans call for EOS PM to be launched on December 21, 2000. This satellite will include six instruments to be placed into a polar, sun-synchronous, 705-km orbit. The EOS PM instrument complement will be integrated onto the EOS common spacecraft described earlier, with the spacecraft boosted into orbit by a Medium Expendable Launch Vehicle (MELV) launched from WSMC. The payload consists of AIRS, AMSU-A, HSB, CERES, AMSR-E, and MODIS. The EOS PM spacecraft will have an afternoon equatorial crossing time to enhance collection of meteorological data by the atmospheric sounders onboard. The instrument complement is designed to provide information on cloud formation, precipitation, water vapor, air temperature, and radiative properties (AIRS, AMSU-A, HSB, CERES, MODIS) and sea-ice concentration and temperature, sea-surface temperature, snow cover, and soil moisture (AMSR-E, MODIS). AIRS, AMSU-A, CERES, and MODIS are provided by the U.S.; HSB and AMSR-E will be provided by the Brazilian Space Agency and NASDA, respectively. The EOS PM space-

ICESat

<http://icesat.gsfc.nasa.gov/>

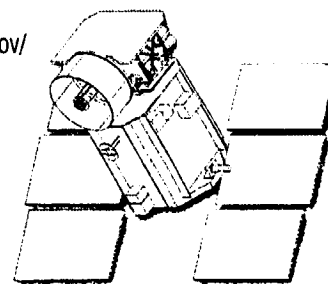

The EOS ICESat mission will fly the Geoscience Laser Altimeter System (GLAS) instrument. GLAS is a solid-state neodymium:yttrium-aluminum-garnet (Nd:YAG) laser altimeter, including integral star trackers and GPS for precise altitude and orbit determinations. The GLAS science objectives are ice-topography and mass-balance measurements. In addition, the GLAS instrument, with a minor modification to double the laser frequency to produce visible pulses as well as near-infrared pulses, will provide cloud property information not otherwise available from passive sensors, especially the high ice clouds common over polar areas. Finally, the third science objective of the ICESat mission will be to provide a land-topography data set by processing the altimeter data throughout its orbit, in addition to the polar coverage over ice sheets.

The planned launch date for ICESat was advanced one year during the Biennial Review when the implementation approach for the mission took advantage of the Rapid Spacecraft Procurement initiative. Using the commercial spacecraft bus, ICESat's launch readiness date is now mid-2001.

EOS CHEM

<http://eos-chem.gsfc.nasa.gov/>

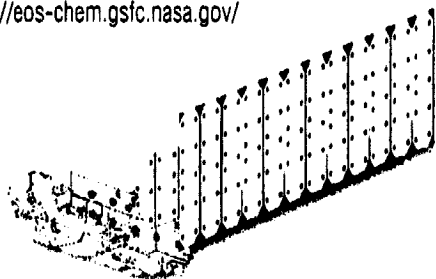

The EOS Chemistry mission, planned for a December 2002 launch, consists of four instruments on a common spacecraft that will be launched into a 705 km, 98.2° inclination, polar sun-synchronous orbit. The mission is designed for a 5-year life with a goal of 6 years of operation. The spacecraft will have an ascending-node equatorial crossing time of 1:45 p.m. The objective of the EOS Chemistry mission is to study the chemistry and dynamics of the Earth's atmosphere, with emphasis on the upper troposphere and lower stratosphere (5-20 km). The mission will measure ozone, aerosols, and several key atmospheric constituents that play an important role in atmospheric chemistry, air quality, and climate. This mission will help in understanding the chemical and pollutant transport phenomena that are essential ingredients in evaluating the environmental policies and international agreements on chlorofluorocarbon (CFC) phase out.

The Chemistry satellite is based on the EOS Common Spacecraft, the same platform hosting the PM mission. The spacecraft total weight is 2967 kg, of which 1200 kg is the instrument weight. The spacecraft is modular in design and is easily adaptable to the mission-specific needs.

The High Resolution Dynamics Limb Sounder (HIRDLS) is an infrared limb-scanning radiometer designed to sound the upper troposphere, stratosphere, and mesosphere to determine temperature; the concentrations of O₃, H₂O, CH₄, N₂O, NO₂, HNO₃, N₂O₅, CFC11, CFC12, ClONO₂, and aerosols; and the locations of polar stratospheric clouds and cloud tops. HIRDLS is a joint venture between NASA and the U.K. Natural Environment Research Council. The U.S. portion of the instrument is being built by the University of Colorado with Lockheed Martin as the system integration contractor.

The Microwave Limb Sounder (MLS) is designed to measure the stratospheric temperature and numerous chemical species (i.e., O₃, H₂O, ClO, HCl, OH, HO₂, N₂O, CO, HOCl, BrO and HNO₃). The scientific priorities and objectives of the MLS investigation are to study and monitor the chemistry of the lower stratosphere and upper troposphere. In the middle and upper stratosphere, MLS monitors ozone chemistry by measuring radicals, reservoirs, and source gases in chemical cycles that destroy ozone. SO₂ is also measured by the MLS instrument to

assess the effects of volcanoes. The instrument is designed and built by JPL.

The Tropospheric Emission Spectrometer (TES) is a high-resolution infrared-imaging Fourier transform spectrometer that has the capability to make both limb and nadir observations. TES is a pointable instrument and can access any target within 45 degrees of the local vertical, or produce regional transects up to 1700-km in length without any gaps in coverage. TES employs both the natural thermal emission of the surface and atmosphere and reflected sunlight, thereby providing day-night coverage anywhere on the globe. Observations from TES will further understanding of long-term variations in the quantity, distribution, and mixing of minor gases in the troposphere, including sources, sinks, troposphere-stratosphere exchange, and the resulting effects on climate and the biosphere. TES will provide global maps of carbon monoxide and its photochemical precursors. TES is also being designed and built by JPL.

The fourth instrument is primarily dedicated to the measurement of ozone. The Ozone Monitoring Instrument (OMI) will complement the measurements made by the other EOS Chemistry instruments. OMI is an ultraviolet grating spectrometer specifically designed for the global mapping of ozone. This instrument will continue the TOMS ozone data record begun in 1978, but will employ new technology. In addition to global total-ozone mapping, the instrument will be capable of deriving surface UVB radiation and aerosol data over land and oceans on a global scale. The instrument will also detect column amounts of NO₂ that will be highly complementary to the other EOS Chemistry instruments. OMI will be furnished by the Netherland's agency for aerospace programs (NIVR), with major contributions from Finland.

EOS Follow-On Missions

During FY 1997, the Earth Science Enterprise completed its first Biennial Review. The intent of this review was to reassess the Enterprise's strategic direction in response to improved scientific understanding, evolving technology, new opportunities in the commercial, international, and interagency arenas, and budget constraints.

Our understanding of global climate change has evolved, and will continue to evolve. The measurement sets currently defined as part of the EOS Program are appropriate for addressing the science questions as we understand them today. However, it is likely that as new information emerges, changing science priorities will result in additions and/or deletions to our desired measure-

ment set. In addition, technology continues to evolve, making possible a transition to smaller, more-focused science missions. Opportunities for partnerships with other U.S. and international agencies as well as with the private sector will continue to grow, particularly as other nations continue to develop their own space programs and the commercial remote-sensing market continues to expand.

In order to respond effectively to these changes, we are modifying our technology and implementation strategies for the follow-on missions (beyond Terra, PM-1, and Chemistry). Key characteristics of the new paradigm include enhanced scientist-technologist interaction, ongoing evaluation of our measurement strategies, evolution to smaller, more-focused missions, seeking new partnering opportunities, and learning from past experience before committing to a follow-on measurement set.

The first step in defining the follow-on missions was the convening of a Science Workshop for the Land Cover and Land-Use science theme, which was held in May 1998. This workshop defined the measurement strategies for acquiring global spaceborne data needed to support this theme in 2004 and beyond (after the end of the Terra mission). This Workshop was held in anticipation of the release of a Request for Information (RFI) that was subsequently issued to the scientific community in May 1998. This RFI resulted in 100 mission concepts that were reviewed by six discipline panels that prioritized them from the perspective of scientific research or application requirements:

- Atmospheric Chemistry
- Atmospheric Climate Physics & General Circulation
- Global Water Cycle, Hydrology, & Mesoscale Weather
- Oceanography & Polar Research
- Land Cover, Land Use, & Terrestrial Ecosystems
- Geodynamics, Geology, & Natural Hazards

Twenty-three high-priority mission concepts were identified among the proposed measurement ideas, and passed to an industrial contractor for study and cost estimation. These mission concepts were subsequently subdivided into three distinct flight mission programs: (i) Systematic EOS measurement program, consisting of consistent measurements of critical Earth system parameters over the time period needed to achieve the science objective, (ii) Earth Probe program, consisting of original and conclusive information on specific Earth system processes of major significance for global change research or phenomena heretofore inaccessible to global observation, and (iii) New Millennium Program, consisting of demonstration missions involving innovative techniques that allow the reduction in cost of existing measurements or testing of new capabilities that have the potential of enabling new science, if successful.

Following the discipline panel review, ten systematic measurement concepts were consolidated into a nomi-

nal EOS Follow-On Mission Scenario, and seven exploratory research concepts were taken as illustrative examples of the Earth System Science Pathfinder/Earth Probe program.

The results of this process were subsequently reviewed at a workshop held in Easton, Maryland in August 1998. This workshop refined and enhanced the definition of follow-on missions, which are being further scoped at the present time.

A whole spectrum of implementation options is possible, ranging from the traditional mode of missions integrated by NASA Project Managers, to purchases of commercial remote-sensing data, to science missions managed and developed entirely by individual Principal Investigators. In this last option (which was endorsed by the Biennial Review panel), the PI would be responsible for implementing the complete mission. Limited oversight, "light-touch" management principles would be applied, and standard industry procedures and practices would be encouraged.

Alternatively, the PI could be responsible for just the instrument development. This development would proceed independent of the eventual spacecraft or mission assignment (thus avoiding having the mission schedule driven by the slowest instrument development). A streamlined Project Office would be created late in the instrument development cycle and would oversee the build of the flight model instrument(s), procurement of the spacecraft bus (through a recently established "catalog" procurement mechanism), and procurement of launch services.

A Science Implementation Plan, which will specify the long-term science measurement priorities for the EOS program, is being developed by the Office of Earth Science at Headquarters. Prior to the finalization of this plan, a strawman set of follow-on missions and their cost estimates has been developed, based on the RFI process and Easton workshop described above. This EOS follow-on budget profile assumes that new technology development efforts can be applied to minimize instrument costs and that the application of rapid spacecraft procurements from established spacecraft production lines can be used to create a flexible collection of small missions to fulfill the objectives of the Implementation Plan. While a strawman flight schedule was created, the actual flight schedule (which will later form the program's commitment) will depend upon the outcome of the Science Implementation Plan's measurement priorities.

POES Series

<http://poc2.gsfc.nasa.gov/>

NOAA's primary agency directive is to provide daily global data for operational forecasts and warnings, with very high reliability. NOAA normally has two POES spacecraft in operation at the same time, one in a morning and one in an afternoon orbit; each is replaced upon failure or significant degradation of one of its primary sensors or subsystems. Over 120 countries depend on the data from the POES direct broadcast.

The present two-satellite POES system will continue through 2002. The core instruments for the POES missions are AVHRR-3 and HIRS-3—an imager and an infrared sounder, respectively. POES spacecraft are also equipped with the ARGOS data collection system, S&R, and S&R. POES satellites in afternoon orbit (i.e., NOAA-14, L, N/N') also carry SBUV. The stratospheric and microwave pair of sounders previously in use (i.e., SSU and MSU) have recently been upgraded, beginning with NOAA-15; NOAA-15 through -M will employ the AMSU-A1/2 and AMSU-B sounder pair. NOAA-N/N' will carry an MHS instrument instead of the AMSU-B.

The United States and Europe have agreed in principle that Europe will take over responsibility for the morning satellite of the POES global-coverage mission in the 2002 time frame. Planning for this cooperative program includes flight of the NOAA/EUMETSAT operational meteorological payload aboard the Metop series. Also, EUMETSAT will establish a high-latitude European ground station to read out data from both the European and U.S. (NOAA) satellites. Full exchange of data, in a timely manner consistent with operational objectives, will be conducted between NOAA and EUMETSAT. Current plans are for these two agencies to provide morning (EUMETSAT) and afternoon (NOAA) polar-satellite global coverage, with each using the same basic instrument complements. The U.S. will provide the AMSU-A1/2, AVHRR-3, HIRS-3, and SEM instruments to be flown on Metop-1; EUMETSAT will provide the AMSU-B instruments for NOAA's POES series; France will provide the ARGOS systems for both the NOAA and EUMETSAT missions; and Canada and France will jointly provide the S&R systems for both NOAA and European polar missions. Each meteorological agency may add other instruments suitable to its particular orbit time and needs.

Direct broadcast of POES data will continue, with European polar satellites also providing direct data broadcast services. In addition, data from potential operational instruments on the EOS satellites will be accessed and disseminated by NOAA.

The establishment and use of a high-latitude European ground station under the cooperative NOAA-EUMETSAT agreement will eliminate blind orbits in cov-

erage by polar-orbiting meteorological satellites. This enhanced ground network will eliminate orbits wherein the satellite fails to pass within line-of-sight for data transmission to its ground station. Both NOAA and EUMETSAT's meteorological payloads will be able to downlink a full orbit's worth of data at full resolution each orbit. As such, there will no longer be a need for low-resolution Global Area Coverage (GAC) data to conserve POES onboard data storage capacity. All POES data in the cooperative program will be full-resolution Local Area Coverage (LAC) data. The low-resolution, analog Automatic Picture Transmission (APT) as well as the Direct Sounding Broadcast (DSB) of the current NOAA system will be replaced with Low-Resolution Picture Transmission (LRPT) broadcasts. The High-Resolution Picture Transmission (HRPT) data rate will be changed from 667 kbps to 3.5 Mbps, and the HRPT frequency will be changed to 1704.5 MHz.

NOAA-15/L/M/N/N' Instruments

- ARGOS – Relays messages from data collection platforms at 401.0 and 136.77 MHz; receives platform and buoy transmissions on 401.65 MHz; monitors over 4,000 platforms worldwide; outputs data via VHF link and stores them on tape.
- AMSU-A1/2 – 15 channels (23-90 GHz) to measure temperature profiles from ground level to 45 km, with 45-km nadir resolution (14-bit resolution); scan line time of 8 sec includes full aperture calibration.
- AVHRR-3 – Six spectral channels (five full-time) at 0.58-0.68 μm , 0.72-1.0 μm , 1.58-1.64 μm (sun-side readout)/3.55-3.93 μm (dark-side readout), 10.3-11.3 μm , and 11.5-12.5 μm , with an image resolution of 1-4 km (effective 11-bit resolution); infrared calibration capability, but no visible calibration.
- AMSU-B (NOAA-15 thru -M only) – Measures precipitation and water vapor profiles with two channels at 89 and 157 GHz and three channels at 183.31 GHz ($\pm 1, 3,$ and 7 GHz); scan line time is 8/3 sec; 15-km nadir resolution (14-bit resolution) and full-aperture calibration capability.
- HIRS-3 – 20 channels at 0.2-15 μm to cover the ground to the troposphere, with 21-km nadir resolution (12-bit resolution), a scan line time of 0.4 sec, and full aperture calibration.
- SBUV-2 (NOAA-L thru N/N' only) – 12 spectral channels to measure from 0.257-0.322 μm , with a 1-nm bandpass; 256-sec spectral scan; 11.33° \times 11.33° instantaneous field-of-view; 14-bit resolution; diffuser-

plate calibration accomplished with an onboard spectral reflectance/transmittance measurement system; operates only on the day side of the orbit, and performs spectral calibration on the night side.

- S&R – Receives beacon signals at 121.5, 243, and 406.05 MHz (-154 dBm signal detection level); transmits in real-time at 1544.5 MHz to ground stations around the world.
- SEM – Monitors particles and fields to measure and predict solar events.
- MHS (NOAA-N, N' only) – 5-channel, self-calibrating microwave scanning radiometer. The channels in the frequency range 89 to 183 GHz provide a humidity profiling capability.

SORCE

<http://lasp.cc/orado.edu/sorce>

The Solar Radiation and Climate Experiment (SORCE) consists of a small, free-flying satellite carrying four instruments to measure solar radiation incident at the top of the Earth's atmosphere. It is scheduled for launch in mid-2002, carrying the Total Irradiance Monitor (TIM), Spectral Irradiance Monitor (SIM), Solar Stellar Irradiance Comparison Experiment (SOLSTICE), and the XUV Photometer System (XPS).



Solar irradiance is the dominant energy source in the Earth's atmosphere, establishing much of the atmosphere's chemistry and dynamics, and becomes the dominant term in the global energy balance and an essential determinant of atmospheric stability and convection. The SORCE measurements will provide the requisite understanding of one of the primary climate system variables. SORCE will provide daily measurements of total solar irradiance (TSI) and spectral solar irradiance from 1 nm to 2000 nm and, in the case of the ultraviolet measurements, will maintain calibration by comparison to bright, early-type stars. SIM will measure spectral irradiance from 200 nm to 2000 nm with a resolution varying from 1 nm to 35 nm, SOLSTICE will measure spectral irradiance from 115 nm to 300 nm with a resolution of 1 nm, and XPS will measure six broad-

band samples from 1 nm to 31 nm and at Lyman α (121.6 nm).

NPOESS PREPARATORY PROJECT (NPP)

NPP is a proposed joint space-flight mission of the NASA Earth Science Enterprise and the National Polar-orbiting Operational Environmental Satellite System (NPOESS) Integrated Program Office (IPO). The two main objectives of this proposed mission are to provide risk reduction for NPOESS through pseudo-operational demonstration and validation of instruments and algorithms prior to the first NPOESS flight, and to provide NASA and the broad Earth-science community with the continuation of calibrated, validated, and geo-located global imaging and sounding observations beyond the Earth Observing System (EOS) Terra and PM missions. In this manner, the proposed mission bridges between the EOS Terra and PM missions, and the NPOESS mission, supporting the transition of selected long-term systematic Earth-science measurements from EOS to operational systems.

NPP, planned for launch in 2005 with a mission duration of 5 years, is being formulated using an end-to-end mission-life-cycle methodology. Three instruments are planned for NPP: Visible Infrared Imaging Radiometer Suite (VIIRS) (including augmentations to support additional research observations and capabilities) provided by the IPO, Cross-track Infrared Sounder (CrIS) provided by the IPO, and Advanced Technology Microwave Sounder (ATMS) provided by NASA. The ATMS instrument will combine the passive-microwave observation capability of three heritage instruments (AMSU A1/A2 and MH) into a single instrument of approximately the size of one of the three heritage instruments, using advanced microwave-receiver electronics technologies.

The spacecraft for NPP, provided by NASA, will accommodate the three instruments, provide direct-to-ground transmission of stored mission instrument data, and also provide direct broadcast of real-time instrument data. Spacecraft flight operations and the spacecraft operations control center, provided by IPO, will provide the operations of the spacecraft and instruments, including on-orbit instrument-calibration activities.

The ground stations for NPP, provided by IPO, will receive stored mission-instrument data, and route this data to the continental United States using IPO-provided communications networks for processing. The planned NPOESS Interface Data Processing Segment (IDPS), provided by IPO, will provide pseudo-operational process-

ing of NPP instrument data for use by the operational community to assess NPP instrument and operational algorithm performance. Additional ground-processing capability, to provide additional support to the research community, will also be available for the generation of additional research products, such as calibration/validation products and higher level products. Short- and long-term archival and distribution capabilities to support research funded through the Announcement of Opportunity process will also be provided.

The proposed NPP mission is currently in the formulation phase, and, should NASA and IPO agree to proceed to implementation, would enter into the implementation phase in 2001. The ATMS instrument, being the subject of a separate NASA-IPO agreement, will proceed to implementation in 2000 in order to support delivery to the NPP mission in 2004.

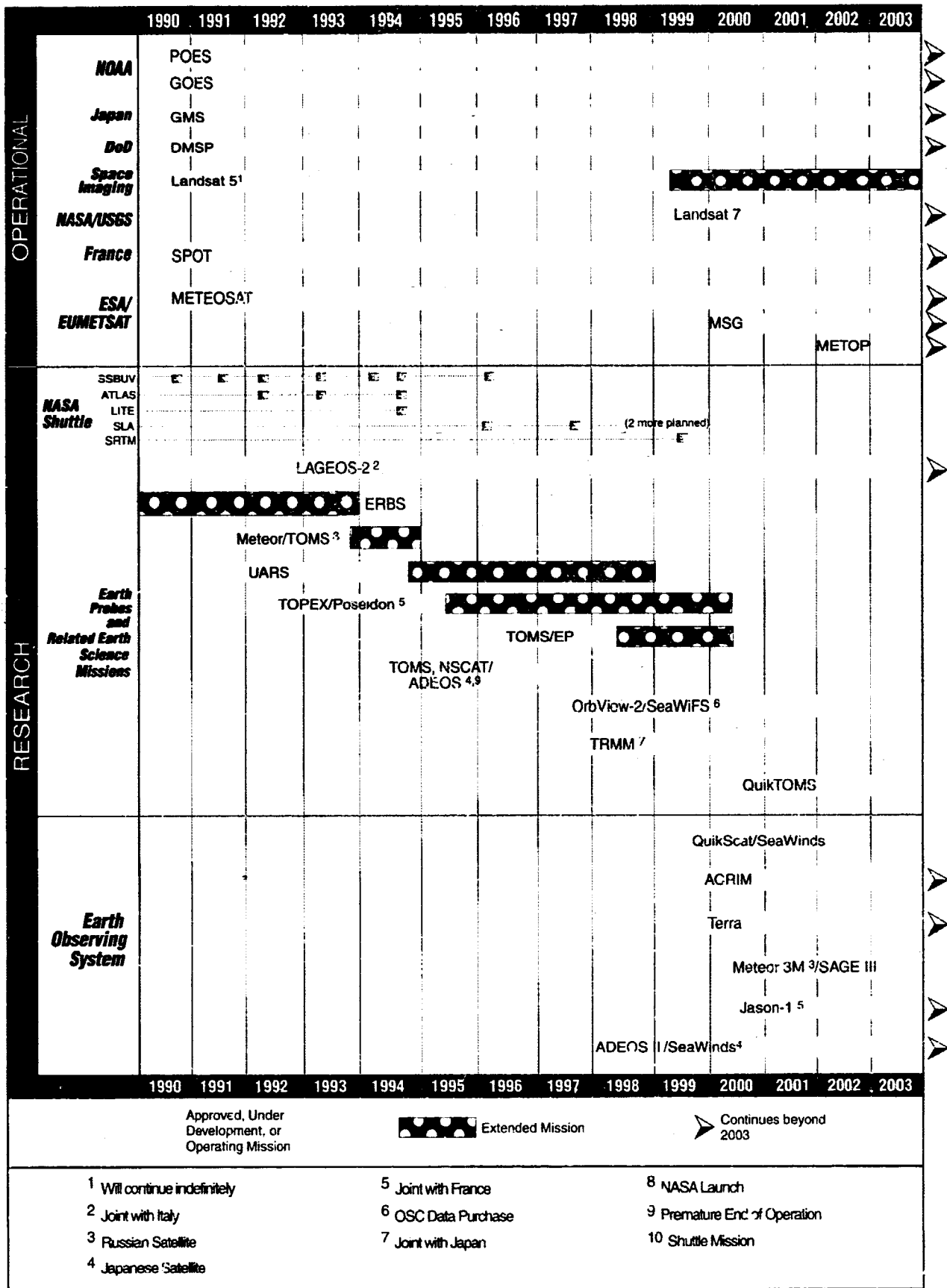

Figure 8a. U.S. and International Partner Earth-Observing Missions

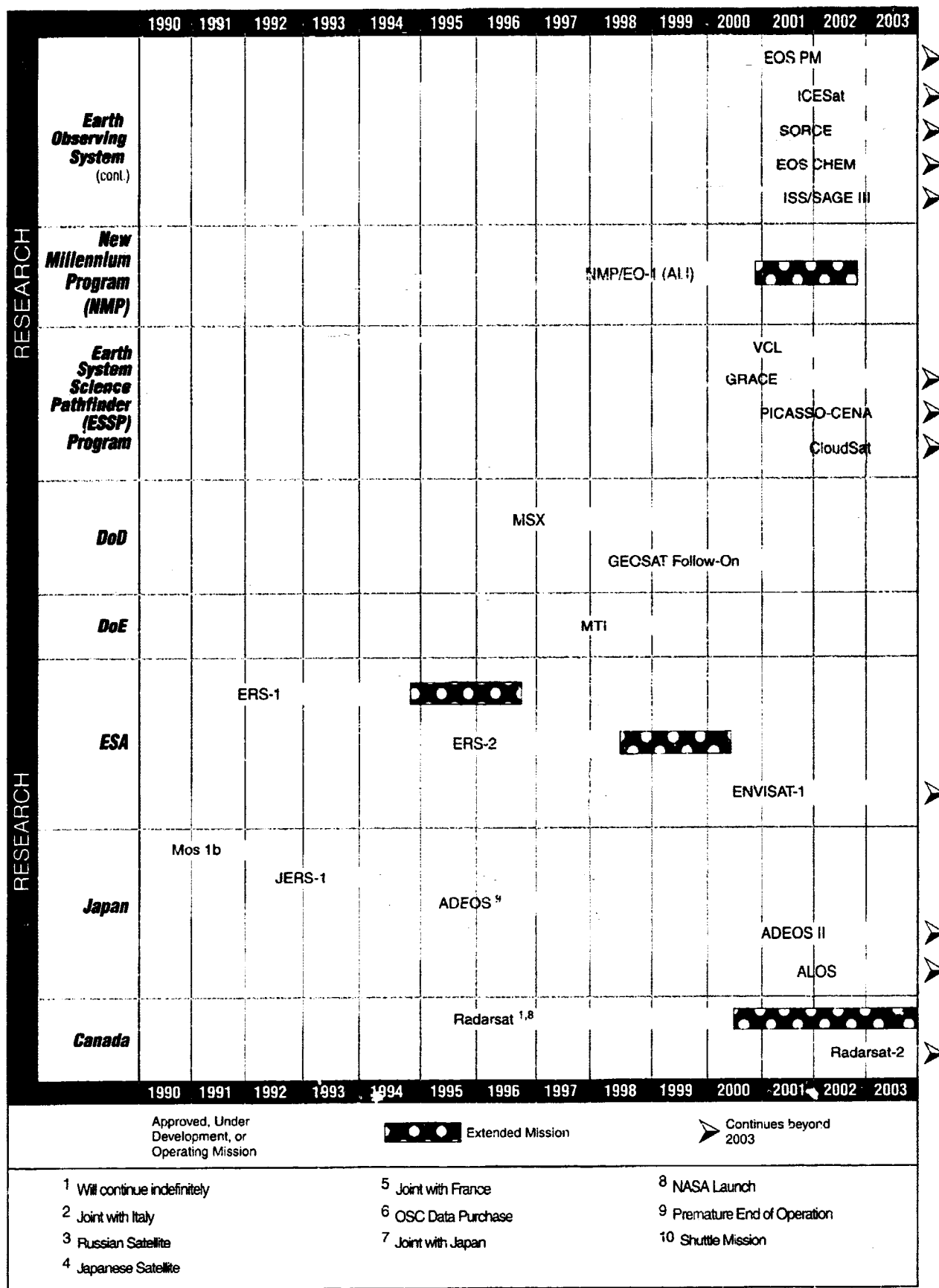

Figure 8b. U.S. and International Partner Earth-Observing Missions

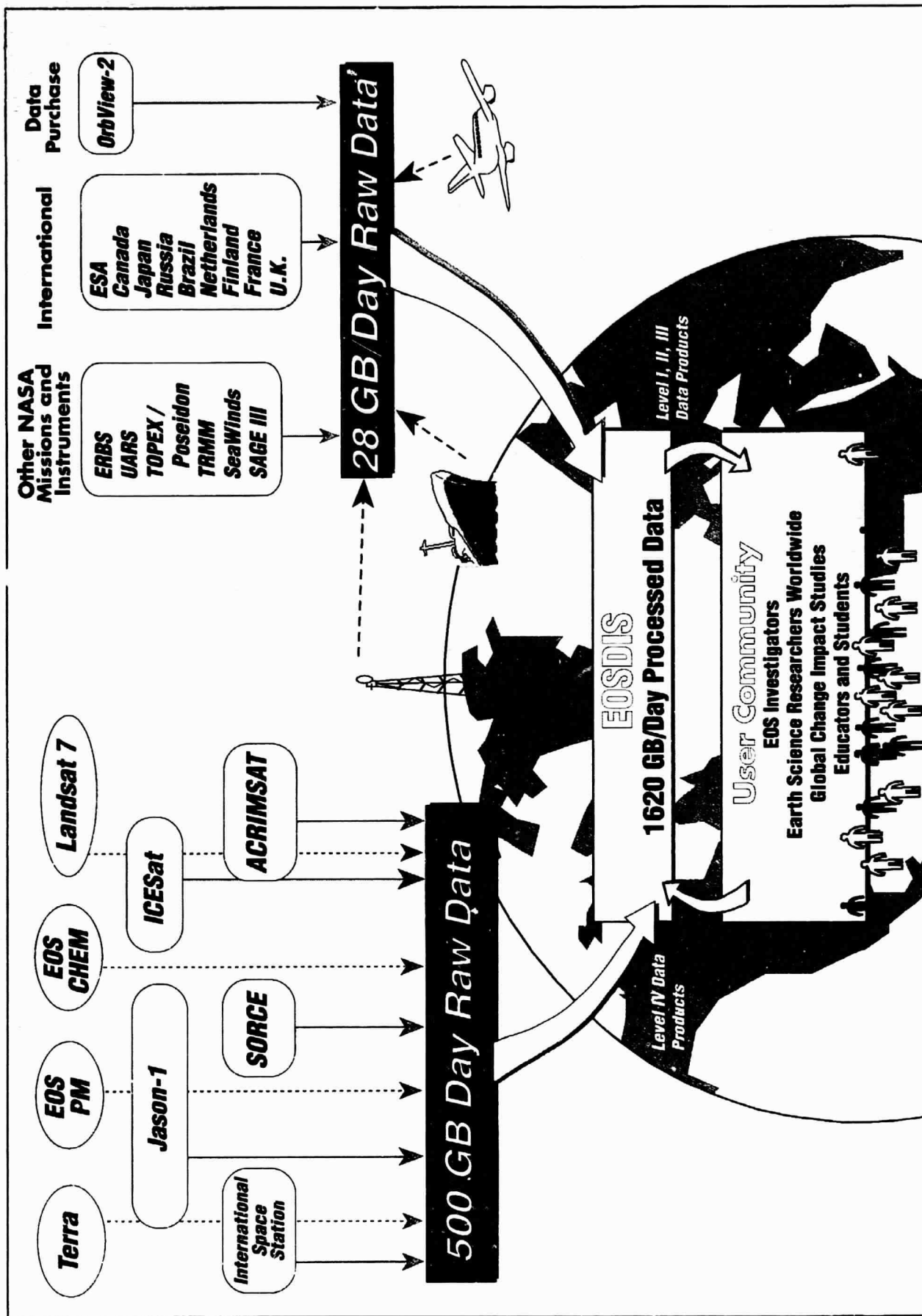

Figure 9. EOS Program Level Architecture

EOS Instruments

ACRIM III	90
AIRS•AMSU-A•HSB	93
AMSR-E	98
ASTER	102
CERES	106
EOSP	109
ETM+	112
GLAS	114
HIRDLS	117
Jason-1	121
LIS	125
MISR	128
MLS	131
MODIS	134
MOPITT	138
OMI	141
SAGE III	143
SeaWinds	146
SORCE	149
TES	152

The EOS facility instruments were major instruments defined in the Announcement of Opportunity (AO) for EOS as being developed and managed by various NASA Centers. The Centers were to take charge of the engineering aspects and costs involved in the development of the instruments. The AO invited proposals by scientists who wanted to serve as Team Leader or Team Member (for facility instruments) of science teams that would provide oversight and guidance to the development of the facility instruments. The science teams would be the source of the algorithms that would lead to the products for each facility instrument. They would also support instrument calibration and validation activities.

U.S. facility instruments that are now part of the EOS Program are AIRS (JPL), AMSU-A (GSFC), MODIS (GSFC), and GLAS (GSFC). In addition to the U.S. facility instruments, the Japanese partners in the Earth Science Enterprise have correspondingly provided the ASTER facility instrument (Japanese Ministry of International Trade and Industry, MITI) and the AMSR-E facility instrument (National Space Development Agency of Japan, NASDA). Brazilian partners (Brazilian National Institute for Space Studies, INPE) have provided the HSB instrument. A coalition of Finnish and Dutch partners has supplied the OMI facility instrument. The French Centre National d'Etudes Spatiales (CNES) is providing the radar altimetry instrument, Poseidon 2.

The EOS Principal Investigator (PI) instruments were understood to be instruments that would be the responsibility of the proposer and the proposer's institution to develop and manage. The selected proposers became the PIs for their own instruments and assembled their own teams of co-investigators to provide the algorithms for the products. The PI's institution took responsibility for the engineering and cost aspects of the instrument's development.

EOS Instrument Teams help define the scientific requirements for their respective instruments and generate the algorithms that will be used to process the data into useful data products. For in-depth presentation of these algorithms, see the Algorithm Theoretical Basis Documents (ATBDs) page on the World Wide Web. The entire document can be viewed using a PDF reader such as Adobe Acrobat, by accessing the following location:

<http://eosps0.gsfc.nasa.gov/atbd/pg1.html>

ACRIM III

Active Cavity Radiometer Irradiance Monitor

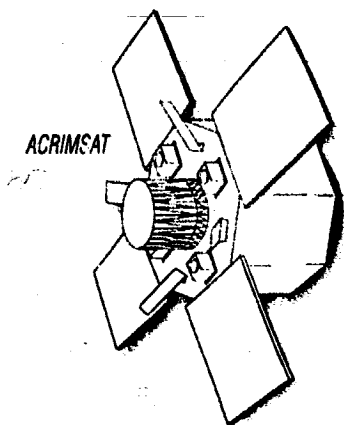

Key ACRIM III Facts

Monitors Total Solar Irradiance (TSI) with state-of-the-art precision and accuracy

Dedicated small-satellite/ACRIM III Instrument combination (ACRIMSAT)

Redundant satellite design for 85% probability of 5-year mission success

Launch scheduled for late 1999 as Pegasus secondary payload

Heritage: ACRIM I (SMM) and ACRIM II (UARS)

Uses Active Cavity Radiometer type IV sensors

Three-fold sensor redundancy: one monitors TSI, others used in phased mode to calibrate degradation of monitoring sensor

Solar irradiance uncertainty - 0.1%; long-term precision - 5 ppm per year

Sampling interval - 2 minutes

Science objectives of EOS/ACRIM III experiment are in the fields of climatology and solar physics

ACRIMSAT URL

<http://acrim.jpl.nasa.gov/>

Sustained changes in the total solar irradiance (TSI) of as little as a few tenths of one percent per century could be primary causal factors for significant climate change. It is clear from paleo-climate research that solar-irradiance-driven climate changes have occurred in the past. There is compelling evidence that some of these may have been at least partially driven by intrinsic solar variability. A precise, long-term record of TSI is required to provide empirical evidence of the sun's role in climate change and to separate its effect from other climate forcings such as greenhouse warming. The same record, together with other solar observations, will also yield an improved understanding of the physics of the sun and the causes of luminosity variations, and could eventually lead to a predictive capability for solar-driven climate change.

The National Research Council recently published its findings regarding research priorities for Solar Influences on Global Change, one of the seven science elements of the U.S. Global Change Research Program. Their recommendations include "monitoring total and spectral solar irradiance from an uninterrupted, overlapping series of spacecraft radiometers employing in-flight sensitivity tracking" as this element's highest priority and most urgent activity. The EOS/ACRIM III experiment is designed to be a cost-effective, small-satellite approach to meeting that priority during the first phase of the Earth Observation System program (EOS) of the Earth Science Enterprise (ESE).

The sun is a variable star. Its luminosity has been found to vary by 0.1 percent over a solar cycle in phase with the level of solar magnetic activity. Photometric observations of many solar-type stars have revealed that brightness variations correlated with magnetic activity like the sun's are a common phenomenon. Many demonstrate higher variability than the sun, leading to speculation that the sun's variability may have been greater in the past and may be greater again in the future. This would clearly have significant implications for climate change.

A precision TSI database, with resolution adequate to relate centuries of systematic TSI variation to climate change, must be compiled from the results of many flight experiments. With a nominal lifetime of 5 years per experiment, their contiguous results must be related with the maximum precision accessible to current technology, on the order of 10 ppm. This far exceeds the capability of current "ambient temperature" flight instrumentation to define the "absolute uncertainty" of the TSI (>1000 ppm) and even that of cryogenic instrumentation currently under development (>100 ppm). Modeling TSI, using ground-based observations of proxy solar emission features, is orders of magnitude less precise.

The single approach capable of providing the required precision for the long-term TSI database with current measurement technology employs an "overlap strategy" in which successive ambient temperature TSI satellite experiments are compared in flight, transferring their operational precision to the database. The

current generation of ambient temperature ACRIM flight instrumentation has demonstrated a capability of providing annual precision ~ 5 ppm of the TSI.

The EOS/ACRIM III experiment was selected to provide the TSI database during the EOS mission. Observations during the first 5-year phase of EOS will be provided by an ACRIM III instrument, a miniaturized version of the technology flown successfully on NASA's Solar Maximum Mission, Upper Atmosphere Research Satellite, Spacelab 1, and ATLAS missions. ACRIM III will be flown on a dedicated small satellite, placed into orbit as a secondary payload aboard a Pegasus launch vehicle. The resulting 'ACRIMSAT' will be spin stabilized with the instrument's solar-viewing axis aligned with the sun-center within 0.25 deg. using magnetic torquers. The on-orbit operation and data down-linking will be accomplished using a dedicated ground station supplied by the satellite manufacturer.

The objective of an early launch of ACRIMSAT is the comparison of overlapping EOS/ACRIM III results with results from the UARS/ACRIM II and SOHO/VIRGO experiments. Results for the second phase of EOS will be made by an experiment to be selected from responses to AO-97-MTPE-01. This launch, scheduled for late 2001, combines the TSI database maintenance function with a new technology initiative designed to develop a prototype instrument for both total and limited spectral solar monitoring on an operational basis in the National Polar-orbiting Operational Environmental Satellite System (NPOESS) program. Additional EOS TSI experiments will be required to bridge the gap between the second EOS phase and the launch of the first NPOESS satellite (2009).

Principal Investigator

Richard C. Willson

Richard C. Willson holds a doctoral degree in Atmospheric Sciences from the University of California-Los Angeles, and B.S. and M.S. degrees in Physics from the University of Colorado. He is a Senior Research Scientist in the employ of Columbia University's Center for Climate Systems Research. His work in this field, which began at the University of Colorado and continued at the Jet Propulsion Laboratory and Columbia University, has been in the area of development of state-of-the-art solar irradiance measurement techniques for both total and spectral irradiance. He developed prism, grating, and interference spectroscopy instrumentation for spectral observations in both laboratory and flight environments. He developed the Active Cavity Radiometer instrumentation for total irradiance observations and has conducted

flight experiments on balloons, sounding rockets, the Space Shuttle, and satellite platforms. He has served as the Principal Investigator for the Solar Maximum Mission ACRIM I, Space Shuttle Spacelab I and Atmospheric Laboratory for Applications and Science (ATLAS) ACRIM's, Upper Atmosphere Research Satellite (UARS) ACRIM II and EOS/ACRIM III experiments.

Co-Investigators

James Hansen - NASA/GISS

Hugh Hudson - University of California, San Diego

Alex Mordvinov - Institute of Solar-Terrestrial Physics, Russia

ACRIM III Parameters

Three ACR type IV sensors, individual shutters, differential operation

Phased use of sensors for degradation calibration

Monitor total solar irradiance: 5 ppm/year precision, 99.9% accuracy

Mass: 12 kg

Duty cycle: 55 minutes on sun each orbit

Power: 8 W (average)

Data rate: < 1 kbps

Thermal control by: Host spacecraft and instrument heater

Thermal operating range: 10-30°C

FOV: ±2.5°

Requires pointing to be provided by spacecraft

Solar Pointing: Spin stabilization about axis of symmetry

Pointing requirement: +/- 0.25 deg

References

Willson, R.C., 1997: Total solar irradiance trend during solar cycles 21 and 22. *Science*, **277**, 1963-1965

Board on Global Change, National Research Council, 1994: *Solar Influences on Global Change*. National Academy Press, Washington, DC.

Willson, R.C., 1993: Irradiance observations of SMM, Spacelab 1, UARS and ATLAS experiments. *The Sun as a Variable Star*, J. Pap, C. Fröhlich, H. Hudson, and S. Solanki, Eds., Cambridge University Press, 54-62.

Willson, R.C., and H.S. Hudson, 1991: The sun's luminosity over a complete solar cycle. *Nature*, **351**, 42-44.

Willson, R.C., 1979: Active cavity radiometer type IV. *J. Applied Optics*, **18**, 179-188.

ACRIM III Data Products

Product Name	Accuracy		Temporal Resolution	Horizontal Resolution :: Coverage		Vertical Resolution :: Coverage	
	Absolute :: Relative						
Total Solar Irradiance	0.1% :: 0.0005%		2 minutes			N/A :: Top of Atmosphere	

AIRS • AMSU-A • HSB

Atmospheric Infrared Sounder

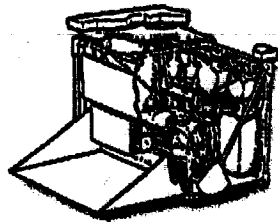

Key AIRS Facts

Selected for flight on EOS PM

Heritage: AMTS study

Infrared sounder

Measures the Earth's outgoing radiation at 0.4 to 1.0 μm and 3.7 to 15.4 μm

Phase C/D start March 1991

Instrument Delivery: June 1999

Prime Contractor: Lockheed Martin

Responsible Center: Jet Propulsion Laboratory

Humidity Sounder for Brazil

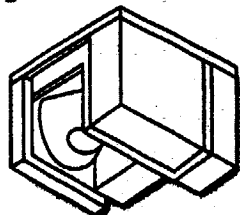

Key HSB Facts

Selected for flight on EOS PM

Heritage: AMSU-B

Microwave radiometer

Provides atmospheric water vapor profile measurements

Phase C/D start March 1997

Instrument Delivery: August 1999

Prime Contractor: Matra Marconi

Responsible Center: Brazilian National Institute for Space Studies (INPE)

Advanced Microwave Sounding Unit

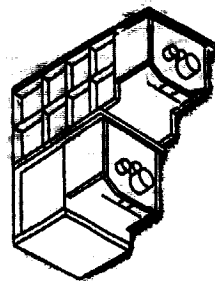

Key AMSU-A Facts

Selected for flight on EOS PM

Heritage: MSU

Microwave radiometer

Provides atmospheric temperature measurements from the surface up to 40 km

Onboard NOAA-K/L/M

Phase C/D start December 1992

Instrument Delivery: December 1998

Prime Contractor: Aerojet General Corporation

Responsible Center: NASA/Goddard Space Flight Center

AIRS URL

<http://www-airs.jpl.nasa.gov/>

AIRS has been selected to fly on the EOS PM satellite with two operational microwave sounders: AMSU and HSB. AIRS, AMSU-A, and HSB measurements will be analyzed jointly to filter out the effects of clouds from the IR data in order to derive clear-column air temperature profiles with high vertical resolution and accuracy, plus high-accuracy surface temperatures. Together, these instruments constitute an advanced sounding system, relative to the High-Resolution Infrared Sounder/Microwave Sounding Unit (HIRS/MSU) system that currently operates on NOAA satellites.

The data retrieved from the AIRS/AMSU-A/HSB instrument complement will improve global modeling efforts, numerical weather prediction, study of the global energy and water cycles, detection of the effects of greenhouse gases, investigation of atmosphere-surface interactions, and monitoring of climate variations and trends. These objectives will be met through improvements in the accuracy of several weather and climate parameters, including atmospheric temperature and water vapor, land and ocean surface temperature, cloud distribution and spectral properties, and outgoing longwave radiation. Simultaneous observations of the atmosphere and clouds from AIRS will allow characterization of the spectral properties of clouds for enhanced understanding of their role in modulating the greenhouse effect; and the increased resolution and number of infrared sounding channels (an increase of two orders of magnitude beyond current operational sounders) will improve the accuracy of weather forecasting.

AIRS, AMSU-A, and HSB together constitute a single facility instrument program, so AIRS products are often the result of joint calculations. Standard and research data products for the complement are:

Standard Products

- For the atmosphere, AIRS/AMSU-A will provide a temperature profile, humidity profile, total precipitable water, fractional cloud cover, cloud-top height, and cloud-top temperature.
- For the land, AIRS/AMSU-A will provide skin surface temperature, plus day and night land-surface temperature difference. AIRS will provide outgoing day/night longwave surface flux.
- For the ocean, AIRS/AMSU-A will provide skin surface temperature. AIRS will provide outgoing day/night longwave surface flux.

Research Products

- For the atmosphere, AIRS/AMSU-A/HSB will provide a precipitation estimate, and tropopause and stratopause heights. AIRS will provide outgoing longwave spectral radiation and cloud optical thickness. AMSU-A will provide cloud thermodynamic phase (ice/water) and cloud water content.
- For the land, AIRS/AMSU-A will provide surface spectral emissivity, surface albedo, and net shortwave flux.
- For the ocean, AIRS will provide net shortwave flux. AMSU-A will provide sea-ice cover (old/new) and surface (scalar) wind speed.
- Standard products are distinguished from research products in that the latter will require post-launch verification.

AIRS

AIRS is designed to meet the NOAA requirement of a high-resolution infrared (IR) sounder to fly on future operational weather satellites.

AIRS is a high-resolution sounder covering the spectral range between 0.4 and 15.4 μm , measuring simultaneously in over 2,300 spectral channels. The spectral resolution ($\lambda/\Delta\lambda$) is 1,200. The high spectral resolution enables the separation of the contribution of unwanted spectral emissions and, in particular, provides spectrally clean "super windows," which are ideal for surface observations. All channels will be downlinked on a routine operational basis.

Temperature profiles will be derived in the presence of multiple cloud layers without requiring any field-of-view to be completely clear. Humidity profiles will be derived from channels in the 6.3- μm water vapor band and the 11- μm windows, which are sensitive to the water vapor continuum. Determination of the surface temperature and surface spectral emissivity is essential for obtaining low-level water vapor distribution.

Land skin surface temperature and the corresponding IR emissivity are determined simultaneously with the retrieval of the atmospheric temperature and water profiles. Shortwave window channels are used to derive the surface temperature and corresponding spectral emissivity, and to account for reflected solar radiation. Once the surface temperature is determined, the longwave surface emissivity for the 11- μm region can be determined, then used to retrieve the water distribution near the surface.

Cloud-top heights and effective cloud amount are determined, based on the calculated atmospheric temperature, humidity, and surface temperature, combined

with the calculated clear-column radiance and measured radiance. The spectral dependence of the opacity of the clouds will distinguish various cloud types (including cirrus clouds). Ozone retrieval is performed simultaneously with the retrievals of the other parameters using the 9.6- μm ozone band.

AIRS visible and near-IR channels between 0.4 and 1.0 μm will be used primarily to discriminate between low-level clouds and different terrain and surface covers, including snow and ice. In addition, the visible channels will allow the determination of cloud, land, and ocean surface parameters simultaneously with atmospheric corrections. Current implementation calls for four channels. One broadband channel from 0.4 to 1.0 μm will be used for the estimation of reflected shortwave radiation, i.e., albedo. Other channels will be used for surface properties such as ice and snow amount and vegetation index. Simultaneous observations of the atmo-

sphere and clouds from AIRS will allow characterization of the spectral properties of clouds for enhanced understanding of their role in modulating the greenhouse effect and the increased resolution and number of infrared sounding channels (an increase of two orders of magnitude beyond current operational sounders) will improve the accuracy of weather forecasting.

AMSU-A and HSB

AMSU-A is designed primarily to obtain profiles of stratospheric temperature and to provide a cloud-filtering capability for tropospheric observations. HSB is designed to obtain profiles of atmospheric humidity and to detect precipitation under clouds with 15-km (nadir) resolution. AMSU-A and HSB have a total of 19 channels: 15 are assigned to AMSU-A, each having a 3.3° beamwidth, and four are assigned to HSB, each having a 1.1° beamwidth. Channels 3 to 14 on AMSU-A are situated on the low-frequency side of the oxygen resonance band (50-60 GHz) and are used for temperature sounding. Successive channels in this band are situated at frequencies with increasing opacity, therefore responding to radiation from increasing altitudes. Channel 1 [located on the first (weak) water vapor resonance line] is used to obtain estimates of total column water vapor in the atmosphere. Channel 2 (at 31 GHz) is used to indicate the presence of rain.

Channel 15 on AMSU-A, at 89 GHz, is used to indicate precipitation, using the fact that at 89 GHz ice more strongly scatters radiation than it absorbs or emits. Channels 16 to 19 are located on the wings of the strongly opaque water vapor resonance line at 183.3 GHz. Successive channels in this group have decreasing opacity and consequently their data correspond to humidities at decreasing altitudes. Channels 16 to 19 of HSB, along with inputs from channels 1 to 15 of AMSU-A, together with the temperature profile from AIRS/AMSU- ν /HSB, are used to obtain profiles of atmospheric humidity, i.e., water vapor.

Team Leader

Moustafa Chahine

Moustafa Chahine was awarded a Ph.D. in Fluid Physics from the University of California at Berkeley in 1960. He is Chief Scientist at the Jet Propulsion Laboratory (JPL), where he has been affiliated for 30 years. From 1978 to 1984, he was Manager of the Division of Earth and Space Sciences at JPL; as such, he was responsible for establishing the Division and managing the diverse activities of its 400 researchers.

For 20 years, Dr. Chahine has been directly involved in remote-sensing theory and experiments. His resume

AIRS Parameters

High spectral resolution, multispectral infrared sounder
Operates with AMSU for all-weather capability

1 K temperature retrieval accuracy

0.05 emissivity accuracy

Array grating spectrometer (3.74 to 15.4 μm), with a spectral resolution of 1,200 ($\lambda/\Delta\lambda$)

Swath: 1,650 km

Spatial resolution: 13.5 km horizontal at nadir, 1 km vertical

Mass: 156 kg

Duty cycle: 100%

Power: 256 W

Data rate: 1.44 Mbps

Thermal control by: Redundant 60 K Stirling cycle coolers, heater, mini thermal bus, two-stage radiator

Thermal operating range: 20-25° C

FOV: $\pm 49.5^\circ$ cross-track

Instrument IFOV: 1.1° circular

Pointing requirements (platform + instrument, 3 σ):

Control: 360 arcsec

Knowledge: 180 arcsec

Stability: 360/60 sec

Jitter: TBD

Physical size: 139.7 \times 77.5 \times 76.2 cm (stowed);
139.7 \times 151.2 \times 76.2 cm (deployed)

reflects roles as Principal Investigator, designer and developer, and analyst in remote-sensing experiments. He developed the Physical Relaxation Method for retrieving atmospheric profiles from radiance observations. Subsequently, he formulated a multispectral approach using infrared and microwave data for remote sensing in the presence of clouds. These data analysis techniques were successfully applied in 1980 to produce the first global distribution of the Earth surface temperature using data from the HIRS/MSU sounders.

Dr. Chahine was integrally involved in the AMTS study, which laid the basis for the current AIRS spectrometer. Dr. Chahine served as a member of the NASA Earth System Sciences Committee (ESSC), which developed the program leading to EOS, and currently is Chairman of the Science Steering Group of a closely related effort, the World Meteorological Organization's Global Energy and Water Cycle Experiment (GEWEX). Dr. Chahine is a Fellow of the American Physical Society and the British Meteorological Society. In 1969, he was awarded the NASA Medal for Exceptional Scientific Achievement and, in 1984, the NASA Outstanding Leadership Medal.

Science Team Members

Hartmut H. Aumann - *Jet Propulsion Laboratory*

Alain P. Chedin - *Centre National de la Recherche Scientifique, Paris, France*

Catherine Gautier - *University of California, Santa Barbara*

Mitch Goldberg - *NOAA/National Environmental Satellite, Data, and Information Service*

Eugenia Kalnay - *NOAA/National Centers for Environmental Prediction*

John F. Le Marshall - *Bureau of Meteorology, Melbourne, Australia*

Larry M. McMillin - *NOAA/National Environmental Satellite, Data, and Information Service*

Henry E. Revercomb - *University of Wisconsin*

Rolando Rizzi - *University of Bologna, Italy*

Philip Rosenkranz - *Massachusetts Institute of Technology*

William L. Smith - *NASA/Langley Research Center*

David H. Staelin - *Massachusetts Institute of Technology*

L. Larrabee Strow - *University of Maryland, Baltimore*

Joel Susskind - *NASA/Goddard Space Flight Center*

AMSU-A Parameters

Passive microwave radiometer that measures atmospheric temperature

Swath: 1,650 km

Spatial resolution: 40 km horizontal at nadir

Mass: 100 kg

Duty cycle: 100%

Power: 125 W

Data rate: 3.2 kbps

Thermal control by: Heater, central thermal bus, radiator

Thermal operating range: 0-20° C

FOV: ±49.5°

Instrument IFOV: 3.3°

Pointing requirements (platform + instrument, 3σ):

Control: 720 arcsec

Knowledge: 360 arcsec

Stability: 360 arcsec/sec

Jitter: 360 arcsec/sec

Physical size: 65.5 × 29.9 × 59.2 cm (A1);
54.6 × 64.9 × 69.7 cm (A2)

HSB Parameters

Passive microwave radiometer for humidity profiling, consisting of four channels: 1 at 150 GHz, 3 at 183 GHz.

Swath: 1,650 km

Spatial resolution: 13.5 km horizontal at nadir

Mass: 66 kg

Duty cycle: 100%

Power: 85 W (average), 154 W (peak)

Data rate: 4.2 kbps

Thermal control by: Radiator

Thermal operating range: 0-40° C

FOV: ±49.5° cross-track from nadir
(+90° to -49.5° for calibration)

Instrument IFOV: 1.1°

Pointing requirements (platform + instrument, 3σ):

Control: 3,600 arcsec

Knowledge: 360 arcsec

Stability: 74 arcsec/sec

Jitter: TBD

Physical size: 73 × 69 × 47 cm

AMSR-E

Advanced Microwave Scanning Radiometer

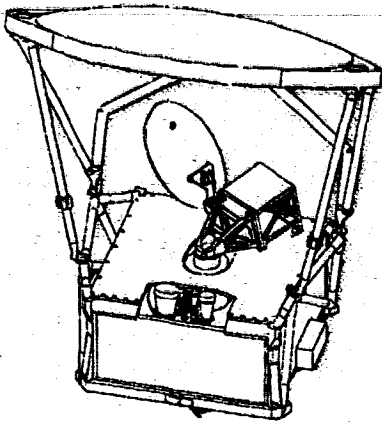

Key AMSR-E Facts

Selected for flight on EOS PM

Heritage: SMMR (Nimbus-7 and Seasat), SSM/I (DMSP), AMSR (ADEOS II)

Measures precipitation rate, cloud water, water vapor, sea surface winds, sea surface temperature, ice, snow, and soil moisture

Passive microwave radiometer, twelve channels, six frequencies, dual polarization

All-weather measurements of geophysical parameters supporting several global change science and monitoring efforts

Responsible Agency: National Space Development Agency of Japan (NASDA)

AMSR-E URL

<http://wwwghcc.msfc.nasa.gov/AMSR/>

The EOS PM AMSR-E will measure geophysical parameters supporting several global change science and monitoring efforts. Of particular importance to its success is an external calibration design, which has proved suitable in other satellite microwave instrumentation for long-term monitoring of subtle changes in temperature and other variables.

Precipitation and evaporation have extremely important roles, through provision of water to the biosphere via precipitation and as an air conditioning agent that removes excess heat from the surface (via evaporation), thereby contributing toward making Earth habitable. AMSR-E will measure rain rates over both land and ocean. Over the ocean, the AMSR-E microwave frequencies can probe through smaller cloud particles to measure the microwave emission from the larger raindrops. The AMSR-E will provide sensitivity to oceanic rain rates as high as 50 mm/hr (about 2 inches per hour). Over land, AMSR-E can measure the scattering effects of large ice particles, which later melt to form raindrops. These measurements, though less direct a measure of rainfall intensity, are converted to rain rates with the help of cloud models.

Over the ocean, in addition to rain rates, AMSR-E will provide sea surface temperatures (SST) through most types of cloud cover, supplementing infrared-based measurements of SST that are restricted to cloud-free areas. SST fluctuations are known to have a profound impact on weather patterns across the globe, and AMSR-E's all-weather capability could provide a significant improvement in our ability to monitor SSTs and the processes controlling them.

The total integrated water vapor of the atmosphere will also be measured over the ocean. This variable is important for the understanding of how water is cycled through the atmosphere. Since water vapor is the Earth's primary greenhouse gas, and it contributes the most to future projections of global warming, it is critical to understand how it varies naturally in the Earth system.

Measurements by AMSR-E of ocean surface roughness can be converted into near-surface wind speeds. These winds are an important determinant of how much water is evaporated from the surface of the ocean. Thus, the winds help to maintain the water vapor content of the atmosphere while precipitation continually removes it.

AMSR-E cloud-water estimates over the ocean will help studies of whether clouds, with their ability to reflect sunlight, increase or decrease under various conditions. This could be an important feedback mechanism that either enhances or mitigates global warming, depending on whether clouds increase or decrease with warming.

Monitoring of sea-ice parameters, such as ice concentration, type, and extent, is necessary to understand how this frozen blanket over the ocean affects the larger climate system. Sea ice has the ability to insulate the water against heat loss to the frigid at-

mosphere above it, and at the same time the ability to reflect sunlight that would otherwise warm the ocean. AMSR-E measurements will allow the derivation of sea ice concentrations in both polar regions, through taking advantage of the marked contrast in microwave emissions of sea ice and liquid water.

In much the same way as AMSR-E can see large ice particles in the upper reaches of rain systems, it also measures the scattering effects of snow-cover depth. These measurements are empirically related to snow-cover depth and water content based upon field measurements. Like sea ice, snow cover has a large influence on how much sunlight is reflected from the Earth. It also acts as a blanket, keeping heat from escaping from the underlying soil and allowing deep cold air masses to develop during the winter. It further provides an important storage mechanism for water during the winter months, which then affects how much surface wetness is available for vegetation and crops in the spring. AMSR-E monitoring of snow cover will allow studies and monitoring of how snow-cover variations interplay with other climate fluctuations.

Wet soil can be identified in the AMSR-E observations if not too much vegetation is present. AMSR-E will provide the most useful satellite data yet for determination of how well low-frequency (6.9 GHz) microwave observations can be used to monitor surface wetness. Surface wetness is important for maintaining crop and vegetation health, and its monitoring on a global basis would allow drought-prone areas to be checked for signs of drought.

Science Team Leaders

Roy W. Spencer

Dr. Spencer received his B.S. in Atmospheric Sciences from the University of Michigan in 1978 and his M.S. and Ph.D. in Meteorology from the University of Wisconsin in 1980 and 1982. He then continued at the U. of Wisconsin through 1984 in the Space Science and Engineering Center as a research scientist. In his current position at NASA Marshall Space Flight Center (MSFC) Dr. Spencer serves as Principal Investigator on the Global Precipitation Studies with Nimbus-7 and DMSP SSM/I, and the Advanced Microwave Precipitation Radiometer High Altitude Studies of Precipitation Systems. He has been a member of several science teams: the Tropical Rainfall Measuring Mission (TRMM) Space Station Accommodations Analysis Study Team, Science Steering Group for TRMM, TOVS Pathfinder Working Group, and NASA HQ Earth Science and Applications Advisory Subcommittee.

Since 1992 Dr. Spencer has been the U.S. Team Leader for the Multichannel Imaging Microwave Radi-

AMSR-E Parameters

External cold load reflector and a warm load for calibration

Offset parabolic reflector, 1.6 m in diameter, and rotating drum at 40 rpm

Multiple feedhorns (6) to cover six bands from 6.9 to 89 GHz with 0.3 to 1.1 K radiometric sensitivity; vertical and horizontal polarization

Accuracy: 1 K or better

Swath: 1445 km

Spatial resolution: 6 × 4 km (89.0 GHz), 14 × 8 km (36.5 GHz), 32 × 18 km (23.8 GHz), 27 × 16 km (18.7 GHz), 51 × 29 km (10.65 GHz), 75 × 43 km (6.925 GHz)

Incidence angle: 55 degrees

Sampling interval: 10 km for 6-36 GHz channels, 5 km for the 89 GHz channel

Mass: 324±15 kg

Duty cycle: 100 %

Power: 350±35 W

Data rate: 87.4 kbps avg, 125 kbps peak

Thermal control by: Passive radiator, thermostatically controlled heaters

Thermal operating range: -5 to 40°C

FOV: Forward-looking conical scan

Pointing requirements, design value (instrument only, 3σ):

Accuracy: 600 arcsec/axis for roll and pitch; NA for yaw

Stability: 80 arcsec/sec/axis for roll and pitch; NA for yaw

Knowledge: 300 arcsec/axis for roll and pitch; NA for yaw

Physical size:

Sensor Unit: 1.95 × 1.5 × 2.2 m (stowed);

1.95 × 1.7 × 2.4 m (deployed)

Control Unit: 0.8 × 1.0 × 0.6 m

ometer (MIMR) team and the follow-on AMSR-E team. In 1994 he became the AMSR-E Science Team leader.

He received the NASA Exceptional Scientific Achievement Medal in 1991, the MSFC Center Director's Commendation in 1989, and the American Meteorological Society's Special Award in 1996.

Akira Shibata

Dr. Akira Shibata, co-leader of the Joint AMSR Science Team, received his B.S., M.S. and Ph.D. from Waseda University, in the Science and Engineering Department.

Before moving to the Meteorological Research Institute (MRI) in 1983, he was a technical officer at the Nagasaki Marine Observatory. At MRI he worked as a research scientist. In 1996, Dr Shibata moved to the Earth Observation Research Center as an Associate senior scientist. He also serves as the ADEOS II AMSR Science Team leader.

Co-Investigators

Robert Adler - NASA/Goddard Space Flight Center

Donald J. Cavalieri - NASA/Goddard Space Flight Center

Alfred T.C. Chang - NASA/Goddard Space Flight Center

Josefino Comiso - NASA/Goddard Space Flight Center

Ralph Ferraro - NOAA/National Environmental Satellite, Data, and Information Service

Christian Kummerow - NASA/Goddard Space Flight Center

Eni G. Njoku - Jet Propulsion Laboratory

Frank Wentz - Remote Sensing Systems

Thomas Wilheit - Texas A&M University

References

Cavalieri, D.J., P. Gloersen, C.L. Parkinson, J.C. Comiso, and H.J. Zwally, 1997: Observed hemispheric asymmetry in global sea ice changes. *Science*, **272**, 1104-1106.

Chang, A.T.C., J.L. Foster, and D.K. Hall, 1997: Effects of forest on the snow parameters derived from microwave measurements during the BOREAS winter field campaign. *Hydrological Processes*, **10**, 1565-1574.

Chang, A.T.C., J.L. Foster, D.K. Hall, B.E. Goodison, A.E. Walker, J.R. Metcalfe, and A. Harby, 1997: Snow parameters derived from microwave measurements during the BOREAS winter field campaign. *J. Geophys. Res.*, **102**, 29,663-29,671.

Ferraro, R.R., 1997: SSM/I derived global rainfall estimates for climatological applications. *J. Geophys. Res.*, **102**, 16,715-16,735.

Hong, Y., C. Kummerow, and W.S. Olson, 1998: Separation of convective/stratiform precipitation using microwave brightness temperature. *J. Appl. Meteorol.*, submitted.

Kummerow, C., 1998: Beamfilling errors in passive microwave rainfall retrievals. *J. Appl. Meteorol.*, **37**, 356-370.

Markus, T., and D.J. Cavalieri, 1998: Snow depth distribution over sea ice in the southern ocean from satellite passive microwave data, in Antarctic sea ice: Physical processes, interactions and variability. *Antarctic Research Series*, **74**, 19-39, American Geophysical Union, Washington, DC, 1998.

Njoku, E., and L. Li, 1998: Retrieval of land surface parameters using passive microwave measurements at 6 to 18 GHz. *IEEE Trans. Geosci. Remote Sens.*, in press.

Njoku, E.G., and D. Entekhabi, 1996: Passive microwave remote sensing of soil moisture. *J. Hydrology*, **184**, 101-129.

Olson, W., C.D. Kummerow, and Y. Hong, 1998: Atmospheric latent heating distributions in the tropics derived from satellite passive microwave radiometer measurements. *J. Appl. Meteorol.*, submitted.

Roberti, L., and C. Kummerow, 1998: Monte Carlo calculations of polarized microwave radiation emerging from cloud structures. *J. Geophys. Res.*, submitted.

Wang, Y., J.C. Alishouse, R.R. Ferraro, and R. Song, 1998: Estimation of midlatitude rainfall parameters from satellite microwave radiometers using the area-time integral concept. *Radio Science*, in press.

Wentz, F.J., and R.W. Spencer, 1998: SSM/I rain retrievals within a unified all-weather ocean algorithm. *J. Atmos. Sci.*, **55**, 1613.

Wentz, F. J., 1998: A well-calibrated ocean algorithm for SSM/I. *J. Geophys. Res.*, **102**, 8703.

AMSR-E Level 2 Data Products

Product Name	Accuracy Absolute :: Relative	Horizontal Resolution :: Coverage	Vertical Resolution :: Coverage
Brightness Temperature	0.2 - 0.7 K ::	5-61 km :: Global	N/A ::
Rainfall: Over Land Over Ocean	2 mm/hr or 20% 1 mm/hr or 20%	12 km :: Global 12 km :: Global	N/A :: Surface N/A :: Surface
Ocean Cloud Water	0.02 mm ::	24 km :: Ocean	N/A :: Troposphere
Ocean Water Vapor	0.6 mm ::	24 km :: Ocean	Column :: Troposphere
Ocean Surface Wind Speed	0.9 m/s ::	24 km :: Ocean	N/A :: Surface
Sea Surface Temperature	≤ 0.5 K ::	61 km :: Ocean	N/A :: Surface
Sea Ice: Concentration	≤ 5% ::	24 km :: Ocean Ocean/Cryosphere	N/A :: Surface
Sea Ice: Temperature	≤ 4K ::	24 km :: Ocean/Cryosphere	N/A :: Surface
Snow Depth on Ice	≤ 5 cm ::	24 km :: Ocean/Cryosphere	N/A :: Surface
Land Surface Soil Moisture	0.06g/cm³ ::	61 km (EASE grid)	N/A :: Surface
Snow Water Equivalent	10 mm or 20% ::	24 km (EASE grid)	N/A :: Surface

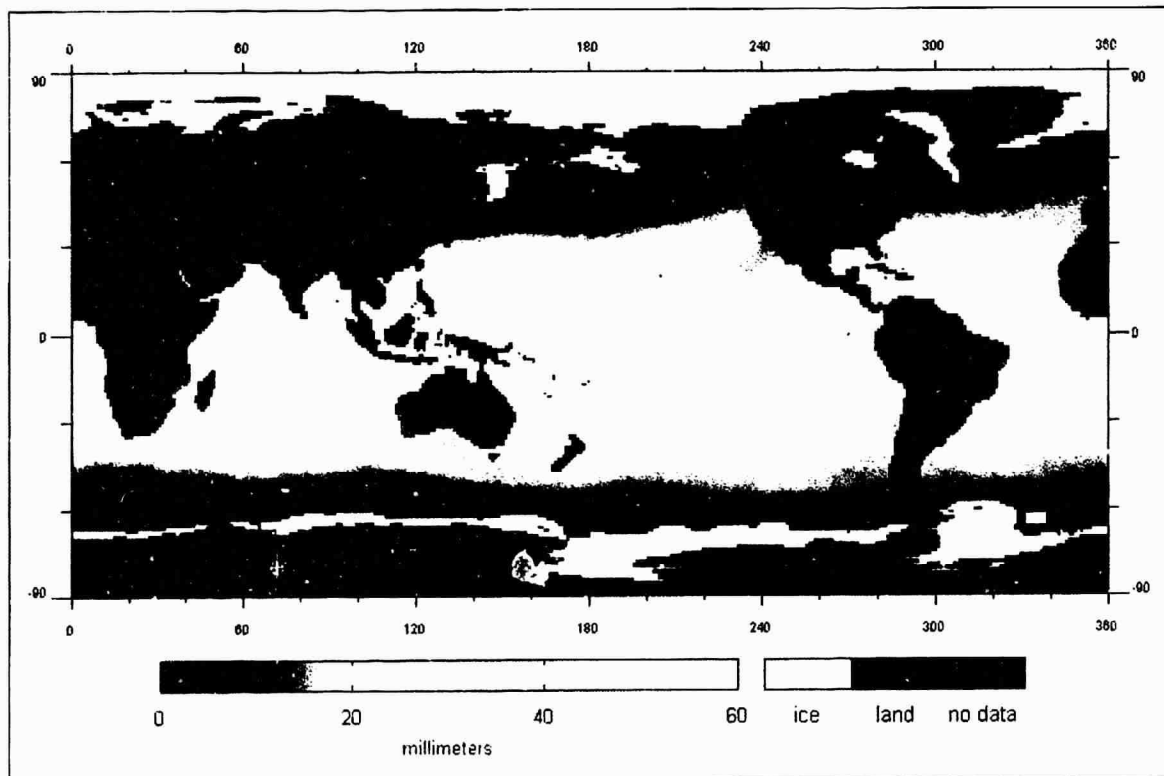

Total integrated water vapor over the global oceans as retrieved from DMSP Special Sensor Microwave/Imager (SSM/I) data during January 1998.

ASTER

Advanced Spaceborne Thermal Emission and Reflection Radiometer

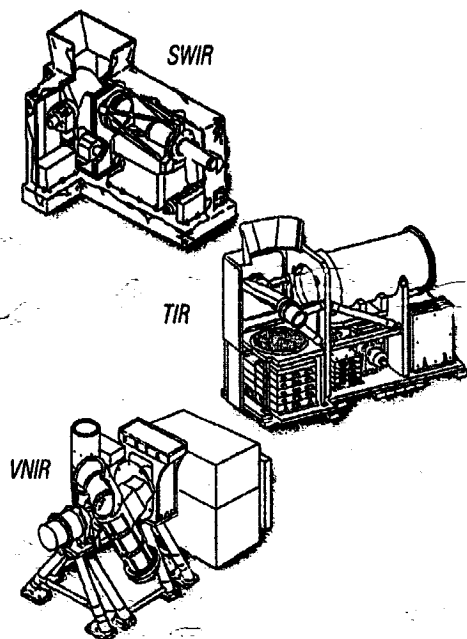

Key ASTER Facts

Selected for flight on Terra

Heritage: JERS-1 OPS and Landsat

Imaging radiometer

Provides high-resolution images of the land surface, water, ice, and clouds

Same-orbit stereo capability

14 multispectral bands from visible through thermal infrared

Not scheduled for further flights other than Terra

Japan (MITI) to provide the instrument

Prime Contractor: NEC (systems integration, VNIR, and Common Signal Processor)

Subcontractors: MELCO (SWIR and cryocooler), Fujitsu (TIR and cryocooler), and Hitachi (master power supply)

ASTER URL

<http://asterweb.jpl.nasa.gov>

ASTER is a facility instrument provided for the Terra platform by the Japanese Ministry of International Trade and Industry (MITI). It will provide high-spatial-resolution (15- to 90-m) multispectral images of the Earth's surface and clouds in order to better understand the physical processes that affect climate change. While the Moderate-Resolution Imaging Spectroradiometer (MODIS) and Multi-Angle Imaging Spectro-Radiometer (MISR) will monitor many of the same variables globally and on a daily basis, ASTER will provide data at a scale that can be directly related to detailed physical processes. These data will bridge the gap between field observations and data acquired by MODIS and MISR, and between process models and climate and/or forecast models. ASTER data will also be used for long-term monitoring of local and regional changes on the Earth's surface, which either lead to, or are in response to, global climate change, e.g., land use, deforestation, desertification, lake and playa water-level changes, and other changes in vegetation communities, glacial movement, and volcanic processes.

Clouds are one of the most important variables in the global climate system. With its high spatial resolution, broad spectral coverage, and stereo capability, ASTER will provide essential measurements of cloud amount, type, spatial distribution, morphology, and radiative properties.

ASTER will provide radiative (brightness) temperature, and the multispectral thermal infrared (TIR) data can be used to derive surface kinetic temperature and spectral emissivity. Radiative temperature is an element in the surface heat balance. Surface kinetic temperature can be used to determine elements of surface process models, sensible heat flux, latent heat flux, and ground heat conduction. Surface temperatures are also related to thermophysical properties (such as thermal inertia), vegetation health, soil moisture, temporal land classification, e.g., wet vs. dry, vegetated vs. bare soil, and evapotranspiration.

ASTER will operate in three visible and near-infrared (VNIR) channels between 0.5 and 0.9 μm , with 15-m resolution; six short-wave infrared (SWIR) channels between 1.6 and 2.43 μm , with 30-m resolution; and five TIR channels between 8 and 12 μm , with 90-m resolution. The instrument will acquire data over a 60-km swath whose center is pointable cross-track $\pm 8.55^\circ$ in the SWIR and TIR, with the VNIR pointable out to $\pm 24^\circ$. An additional VNIR telescope (aft pointing) covers the wavelength range of Channel 3. By combining these data with those for Channel 3, stereo views can be created, with a base-to-height ratio of 0.6. ASTER's pointing capabilities will be such that any point on the globe will be accessible at least once every 16 days in all 14 bands and once every 5 days in the three VNIR channels.

ASTER data products will exploit combinations of VNIR, SWIR, and TIR for cloud studies, surface mapping, soil and geologic studies, volcano monitoring, and surface temperature, emissivity, and reflectivity determination. VNIR and SWIR bands will be used for investigation of land-use patterns and vegetation, VNIR and TIR combinations for the study of coral reefs and glaciers, and VNIR for digital elevation models (DEMs). TIR channels will be used for study of evapotranspiration and land and ocean temperature. The stereoscopic capability will yield local surface DEMs and allow observations of local topography, cloud structure, volcanic plumes, and glacial changes.

Team Leaders

Hiroji Tsu

Anne B. Kahle

Hiroji Tsu, the ASTER Science Team Leader, received B.S., M.S., and Ph.D. degrees from the University of Tokyo. He joined the Geological Survey of Japan (GSJ) as a researcher of Geophysics in 1970. He moved on to the Earth Remote Sensing Data Analysis Center (ERSDAC) in 1993, and was general manager of the R&D Department. In 1996 he returned to GSJ as Deputy Director General.

Anne Kahle, the U.S. Science Team Leader, received her B.S. and M.S. in Geophysics from the University of Alaska and her Ph.D. from UCLA in Meteorology. She worked at the RAND Corp. from 1962 as a Senior Physical Scientist and joined JPL in 1974, where she is a Senior Research Scientist.

Science Team Members

Kohei Arai - *Saga University, Japan*

Yoshio Awaya - *Forestry and Forest Products Research*

Francois Becker - *Pare D'Innovation*

Phillip Christensen - *Arizona State University*

Teruya Ezaka - *JAPEX Geoscience Institute, Inc.*

Hiroyuki Fujisada - *Electrotechnical Laboratory, Japan*

Keiichi Fukui - *Meteorological Research*

Kiyonari Fukue - *Tokai University, Japan*

Yoshikazu Fukushima - *Geographical Survey Institute*

Andy Gabell - *CSIRO, Australia*

Alan Gillespie - *University of Washington*

Ikahiro Hayashil - *Earth Remote Sensing Data Analysis Center*

Yoshiaki Honda - *Chiba University*

Simon Hook - *Jet Propulsion Laboratory*

Jonathan Huntington - *CSIRO, Australia*

Yoshinori Ishii - *National Institute for Environmental Studies*

Takashi Ishiyama - *Chiba University*

Akira Iwasaki - *Electrotechnical Laboratory*

Motoharu Jinguuji - *National Institute for Resources and Environment*

Manabu Kaku - *Mitsubishi Materials Natural Resources Development Corp.*

Hajime Kayanne - *University of Tokyo*

Hugh Kieffer - *U.S. Geological Survey*

Masakuni Kikuchi - *Japan Resources Observation System Organization*

Motoaki Kishino - *Institute of Physical and Chemical Research, Japan*

Kazuhiko Masuda - *Meteorological Research Institute*

Shoichi Masuda - *Fujitsu Ltd.*

Tsuneo Matsunaga - *Tokyo Institute of Technology*

Tadakuni Miyazaki - *Yamanashi Institute of Environmental Sciences, Japan*

Yoshinori Miyazaki - *Geological Survey of Japan*

Masao Moriyama - *Nagasaki University*

Hiroshi Murakami - *Geographical Survey Institute*

Takatoshi Namikawa - *Japan Petroleum Exploration Co., Ltd*

Yoshiki Ninomiya - *Geological Survey of Japan*

Akira Ono - *National Research Laboratory of Metrology*

Hiromi Ono - *Japan Resources Observation System Organization*

Takashi Ooka - *Metal Mining Agency of Japan*

Frank Palluconi - *Jet Propulsion Laboratory*

David Pieri - *Jet Propulsion Laboratory*

Shuichi Rokugawa - *Tokyo University, Japan*

Lawrence Rowan - *U.S. Geological Survey*

Genya Saito - *National Institute of Agro-Environmental Sciences*

Shinichi Sakai - *Central Research Institute of Electric Power Industry*

Fumihiko Sakuma - *National Research Laboratory of Metrology*

Isao Sato - *Geological Survey of Japan*

Thomas Schmugge - *USDA/Hydrology Laboratory*

Ryouhei Tada - *Teikoku Oil Co., Ltd*

Tsutomu Takashima - *Meteorological Research Institute, Japan*

Yozo Takayama - *Meteorological Research Institute*

Masayuki Tamura - *National Institute for Environmental Studies*

Kurt Thome - *University of Arizona*

Hideyuki Tonooka - *Ibaraki University*

Hiroji Tsu - *Shikoku National Industrial Research Institute*

Satoshi Tuchida - *Geological Survey of Japan*

Minoru Urai - *Geological Survey of Japan*

Hiroshi Watanabe - *ERS Data Analysis Center*

Takahiro Watanabe - *Japan National Oil*

Ronald Welch - *University of Alabama*

Yasushi Yamaguchi - *University of Nagoya, Japan*

Tadashi Yamakawa - *Mitsubishi Materials Natural Resources Development Corp.*

Yoshifumi Yasuoka - *National Institute for Environmental Studies, Japan*

References

Fujisada, H., and A. Ono, 1991: Overview of ASTER Design Concept, Future European and Japanese Remote-Sensing Sensors and Programs. Proceedings of the SPIE - The International Society for Optical Engineering, 1-2 April 1991, Orlando, Florida, Vol. 1490, P. Slater, Ed., Society of Photo-Optical Instrumentation Engineers, Bellingham, Washington, 244-254.

Fujisada, H., and A. Ono, 1992: Observational performance of ASTER instrument on EOS AM-1 spacecraft. Advances in Remote Sensing of Earth's Surface and Atmosphere, A.B. Kahle, E.J. Njoku, F.D. Palluconi, A.R. Gillespie, S.J. Hook, C.M. Hayden, K. Tsuchiya and J. Dozier, Eds., Pergamon Press, New York, 147-150.

ASTER Parameters

Multispectral imager for reflected and emitted radiation measurements of the Earth's surface

4% absolute radiometric accuracy in VNIR and SWIR bands

Absolute temperature accuracy is 3 K in 200-240 K range, 2 K in 240-270 K range, 1 K in 270-340 K range, and 2 K in 340-370 K range for TIR bands

Swath: 60 km at nadir, swath center is pointable cross-track ± 106 km for SWIR and TIR, and ± 314 km for VNIR

Spatial resolution: VNIR (0.5-0.9 μm), 15 m [stereo (0.7-0.9 μm), 15 m horizontal, 25 m vertical]; SWIR (1.6-2.43 μm), 30 m; TIR (8-12 μm), 90 m

Mass: 421 kg

Duty cycle: 8% (VNIR and SWIR, daylight only), 16% (TIR)

Power: 463 W (average), 646 W (peak)

Data rate: 8.3 Mbps (average), 89.2 Mbps (peak)

Thermal control by: 80 K Stirling cycle coolers, heaters, cold plate/capillary pumped loop, and radiators

Thermal operating range: 10-28° C

FOV (all pointing is near nadir, except VNIR both nadir and 27.6° backward from nadir): VNIR = 6.09° (nadir), 5.19° (backward), SWIR = TIR = 4.9°

Instrument IFOV: VNIR = 21.5 μrad (nadir), 18.6 μrad (backward), SWIR = 42.6 μrad (nadir), TIR = 128 μrad (nadir)

Pointing requirements (platform+instrument, 3 σ):

Control: 1 km on ground (all axes)

Knowledge: 342 m on ground (per axes)

Stability: 2 pixels per 60 sec (roll = 8.8, pitch = 8.8, yaw = 15 arcsec)

Jitter: 1-2 pixel per 9 sec (roll = 8.8, pitch=4.4, yaw = 52 arcsec)

(Requirements vary with telescope)

Physical size: VNIR = 57.9 \times 65.1 \times 83.2 cm, SWIR = 72.3 \times 134 \times 90.6 cm, TIR = 73 \times 183 \times 110 cm, CSP/VEI (electronics) = 33.4 \times 54 \times 31.5 cm, MPS (electronics) = 30 \times 50 \times 32 cm

ASTER Data Products

Product Name	Accuracy Absolute :: Relative	Temporal Resolution	Horizontal Resolution :: Coverage	Vertical Resolution :: Coverage
Reconstructed, Unprocessed Instrument Data		1/(16 day)	15, 30, 90 m :: Global	N/A :: of Sensor
Registered Radiance at Sensor	2-4% :: 1	1/(16 day)	15, 30, 90 m :: Global	N/A :: of Sensor
Decorrelation Stretch	N/A :: N/A	1/(16 day)	15, 30, 90 m :: Land/Regional, Global	N/A :: Surface
Brightness Temperature	1-2 K :: 0.3 K	1/(16 day)	90 m :: Global	N/A :: Surface
Surface Reflectance	4% :: 1%	1/(16 day)	15, 30 m :: Land/Regional, Global	N/A :: Surface
Surface Radiance	2% :: 1%	1/(16 day)	15, 30, 90 m :: Land/Regional, Global	N/A :: Surface
Surface Emissivity	0.05-0.1 :: 0.005	1/(16 day)	90 m :: Local	N/A :: Surface
Surface Kinetic Temperature	1-4 K :: 1%	1/(16 day)	90 m :: Local	N/A :: Surface
Digital Elevation Model	7 m (w/GCPs) :: 10 m (no GCPs)	1/(16 day)	30 :: Land/Regional, Global	1 m :: Surface

CERES

Clouds and the Earth's Radiant Energy System

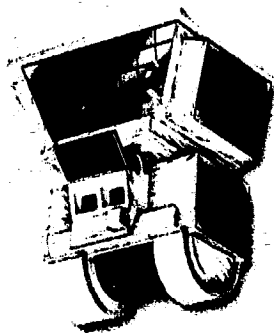

Key CERES Facts

Selected for flight on TRMM, Terra, and EOS PM

Heritage: ERBE

Two broadband, scanning radiometers: One cross-track mode, one rotating plane (bi-axial scanning)

Measures Earth's radiation budget and atmospheric radiation from the top of the atmosphere to the surface

First instrument (cross-track scanning) will essentially continue the ERBE mission and the second (bi-axially scanning) will provide angular radiance information that will improve accuracy of angular models used to derive the Earth's radiative balance

Single scanner on TRMM mission (launched November 1997)

Dual scanners on Terra (1999), EOS PM-1 (2000), and single thereafter

Prime Contractor: TRW

Responsible Center: NASA/Langley Research Center

CERES URLs

EOS Data Products Handbook (CERES data product descriptions):

http://eos.nasa.gov/eos_homepage/misc_html/data_prod.html

CERES Algorithm Theoretical Basis Documents (ATBDs):

<http://eos.nasa.gov/atbd/cerestables.html>

CERES Validation Plan:

<http://eos.nasa.gov/validation/valplans.html>

The instruments of the CERES investigation will provide EOS with accurate cloud and radiation flux measurements that are fundamental inputs to models of oceanic and atmospheric energetics, and will also contribute to extended-range weather forecasting. These data have been requested for international programs of the World Climate Research Program (WCRP), including the Tropical Ocean Global Atmosphere (TOGA) campaign, World Ocean Circulation Experiment (WOCE), Global Energy and Water Cycle Experiment (GEWEX), and the Indian Ocean Experiment (INDOE). Understanding the role of clouds and radiation in the climate system is one of the highest priorities of the U.S. Global Change Research Program.

Clouds are generally regarded as the largest source of uncertainty in understanding climate. Not only are clouds highly variable and difficult to measure, but they have competing heating and cooling effects on the Earth-atmosphere system. Clouds cool the Earth by modulating the large flow of incoming radiative energy from the Sun through the atmosphere, and warm the planet by enhancing the atmospheric greenhouse effect. CERES will measure the radiative flows at the top of the atmosphere (TOA), and will combine these data with that from higher resolution imagers (VIRS on TRMM, MODIS on Terra/EOS PM) to produce cloud properties and radiative fluxes through the atmosphere as well as the radiative energy budget at the Earth's surface. The imagers allow determination of cloud top height, fractional area, cloud liquid water path, droplet size, and other cloud properties that are consistent with the radiative fluxes. CERES will provide, for the first time, a critical tie between the measurements of the radiation budget and synchronous measurements of cloud properties.

The CERES instruments use a scanner very similar to the Earth Radiation Budget Experiment (ERBE) scanner to determine top-of-atmosphere fluxes. Key developments in meeting the CERES goal to double the accuracy of existing estimates of radiative fluxes include new models of the anisotropy of the Earth's reflected and emitted radiation (using the CERES bi-axial scanner) as well as improved time-sampling methodologies.

CERES will also provide improved measurements of clear-sky radiative fluxes. Improvements in clear-sky fluxes require near-simultaneous measurements of both well-calibrated cloud-imager and broadband radiation measurements. Highly accurate clear-sky radiative fluxes are critical in assessing the land/ocean heat budget, as well as understanding the role of clouds in the climate system.

Finally, CERES produces Level 3 data products derived by time interpolation and integration of the Level 2 data into monthly averages. The time interpolation process will be aided by data from geostationary imagers. Thus, CERES will determine the structure of the atmospheric energy budget over the life of its mission with a time resolution of three hours in its synoptic data product. For long-term climate understanding, CERES also produces

data products that contain monthly averages of the cloud and radiation fields on a uniform spatial grid.

Principal Investigator
Bruce Barkstrom

Bruce Barkstrom received a B.S. in Physics from the University of Illinois. He received an M.S. and Ph.D. in Astronomy from Northwestern University. Following a position as Research Associate with the National Center for Atmospheric Research, he had a 5-year teaching assignment with George Washington University.

In 1979, Dr. Barkstrom joined the NASA Langley Research Center. He served as the ERBE Experiment Scientist and Science Team Leader. As such, he was directly responsible for the ERBE instrument design and calibration, as well as the ERBE data interpretation. He was also responsible for science project management of the ERBE team of 17 Principal and 40 Co-Investigators.

Dr. Barkstrom has received NASA medals for Exceptional Scientific Achievement (1989) and Exceptional Achievement (1998).

Co-Investigators

Bryan A. Baum - *NASA/Langley Research Center*

Donald R. Cahoon, Jr. - *NASA/Langley Research Center*

Robert D. Cess - *State University of New York, Stony Brook*

Lin H. Chambers - *NASA/Langley Research Center*

Thomas P. Charlock - *NASA/Langley Research Center*

James A. Coakley - *Oregon State University*

Dominique Crommelynck - *Royal Meteorological Institute, Belgium*

Leo J. Donner - *NOAA/Geophysical Fluid Dynamics Laboratory*

Richard N. Green - *NASA/Langley Research Center*

Robert S. Kandel - *Ecole Polytechnique, France*

Michael D. King - *NASA/Goddard Space Flight Center*

David P. Kratz - *NASA/Langley Research Center*

Robert B. Lee III - *NASA/Langley Research Center*

Norman G. Loeb - *Hampton University*

Alvin J. Miller - *NOAA/National Centers for Environmental Prediction*

Patrick Minnis - *NASA/Langley Research Center*

Kory J. Priestley - *NASA/Langley Research Center*

Veerabhadran Ramanathan - *Scripps Institution of Oceanography*

David A. Randall - *Colorado State University*

G. Louis Smith - *Virginia Polytechnic Institute and State University*

Larry L. Stowe - *NOAA/National Environmental Satellite, Data, and Information Service*

Ronald M. Welch - *University of Alabama/Huntsville*

Bruce A. Wielicki - *NASA/Langley Research Center*

Takmeng Wong - *NASA/Langley Research Center*

David F. Young - *NASA/Langley Research Center*

References

Barkstrom, B.R., (Ed.), 1990: Long-Term Monitoring of the Earth's Radiation Budget, 17-18 April 1990, Orlando, Florida—Proceedings of the SPIE - The International Society for Optical Engineering, Vol. 1299. Society of Photo-Optical Instrumentation Engineers, Bellingham, Washington, 265 pp.

Lee, R.B., III, B.R. Barkstrom, H.C. Bitting, D.A.H. Crommelynck, J. Paden, D.K. Pandey, K.J. Priestley, G.L. Smith, S. Thomas, K.L. Thornhill, and R.S. Wilson, 1998:

CERES Parameters

Three channels in each radiometer: Total radiance (0.3 to >100 μm); Shortwave (0.3 to 5 μm); Window (8 to 12 μm)

Swath: Limb to limb

Spatial resolution: 20 km at nadir

Mass: 50 kg per scanner

Duty cycle: 100%

Power: 47 W (average), 104 W (peak: biaxial mode) per scanner

Data rate: 10 kbps per scanner

Thermal control by: Heaters, radiators

Thermal operating range: 37-39° C (detectors)

FOV: $\pm 78^\circ$ cross-track, 360° azimuth

Instrument IFOV: 14 mrad

Pointing requirements (platform+instrument, 3 σ):

Control: 720 arcsec

Knowledge: 180 arcsec

Stability: 79 arcsec/6.6 sec

Physical size: 60 x 60 x 57.6 cm/unit (stowed),
60 x 60 x 70 cm/unit (deployed)

Prelaunch calibrations of the Clouds and the Earth's Radiant Energy System (CERES), Tropical Rainfall Measuring Mission (TRMM), and Earth Observing System Morning Spacecraft Thermistor Bolometer Sensors. *IEEE Trans. Geosci. Remote Sens.*, **36**, 1173-1185.

Wielicki, B.A., B.R. Barkstrom, B.A. Baum, T.P. Charlock, R.N. Green, D.P. Kratz, R.B. Lee III, P. Minnis, G.L. Smith, T. Wong, D.F. Young, R.D. Cess, J.A. Coakley Jr, D.A.H. Crommelynck, L. Donner, R. Kandel, M.D. King, A.J. Miller, V. Ramanathan, D.A. Randall, L.L. Stowe, and R.M. Welch, 1998: Clouds and the Earth's Radiant Energy System (CERES): Algorithm overview. *IEEE Trans. Geosci. Remote Sens.*, **36**, 1127-1141.

Wielicki, B.A., B.R. Barkstrom, E.F. Harrison, R.B. Lee III, G.L. Smith, and J.E. Cooper, 1996: Clouds and the Earth's Radiant Energy System (CERES): An Earth Observing System Experiment. *Bull. Amer. Meteor. Soc.*, **77**, 853-868.

Wielicki, B.A., R.D. Cess, M.D. King, D.A. Randall, and E.F. Harrison, 1995: Mission to Planet Earth: Role of Clouds and Radiation in Climate. *Bull. Amer. Meteor. Soc.*, **76**, 2125-2153.

CERES Data Products

Product Name	Accuracy Absolute :: Relative	Temporal Resolution :: Coverage	Horizontal Resolution :: Coverage	Vertical Resolution :: Coverage
Instantaneous Instrument Scans (BDS)	1-2% :: 0.005	N/A :: 1 hr	20 km :: Global	N/A :: Top of Atmosphere
Instantaneous Top of Atmosphere Fluxes (ES8)	15 W/m ² LW; 40 W/m ² SW	N/A :: 1 hr	20 km :: Global	N/A :: Top of Atmosphere
Regionally Averaged Top of Atmosphere Fluxes (ES9)*	15 W/m ² LW; 40 W/m ² SW	N/A :: 1 hr	2.5 x 2.5 deg Region :: Global	N/A :: Top of Atmosphere
Regionally and Monthly Averaged Top of Atmosphere Fluxes (ES4)*	3 W/m ² LW; 5 W/m ² SW	N/A :: 1 month	2.5 x 2.5 deg Region :: Global	N/A :: Top of Atmosphere
Monthly and Regionally Averaged Top of Atmosphere Fluxes (ES4G)*	3 W/m ² LW; 5 W/m ² SW	N/A :: 1 month	2.5 x 2.5 deg Region :: Global	N/A :: Top of Atmosphere
Single Satellite Footprint Top of Atmosphere and Surface Fluxes and Clouds (SSF)	5 W/m ² LW; 15 W/m ² SW; depends on cloud parameters	N/A :: 1 hr	20 km :: Global	N/A :: Top of Atmosphere
CERES Radiative Fluxes and Clouds (CRS)	Depends on cloud or flux parameters	N/A :: 1 hr	20 km :: Global	4-18 levels :: Top to Surface
Hourly Gridded Fluxes and Clouds (FSW)	Depends on cloud or flux parameters	N/A :: 1 hr	1.0 x 1.0 deg :: Global	4-18 levels :: Top to Surface
Synoptic Gridded Fluxes and Clouds (SYN)**	Depends on cloud or flux parameters	3 hr :: N/A	1.0 x 1.0 deg :: Global	4-18 levels :: Top to Surface
Monthly and regional Fluxes and Clouds to Surface (AVG)**	2 W/m ² LW; 3 W/m ² SW; variable for clouds and other fluxes	1 hr :: 1 month	1.0 x 1.0 deg :: Global	4-18 levels :: Top to Surface
Zonal Monthly regional Fluxes and Surface to Clouds (ZAVG)**	1 W/m ² LW; 2 W/m ² SW; variable for clouds and other fluxes	N/A :: 1 month	1.0 deg zone :: Global	4-18 levels :: Top to Surface
Surface Radiation Budget (SRB)**	Depends on cloud or flux parameters	N/A :: 1 hr	1.0 x 1.0 deg :: Global	4-18 levels :: Top to Surface
Monthly Top of Atmosphere and Surface Radiation Budget Averages (SRBAVG)**	Depends on cloud or flux parameters	N/A :: 1 month	1.0 x 1.0 deg :: Global	N/A :: Top and Surface

NOTE: *Data products constructed with three-satellite CERES observations using ERBE analysis methods for retrospective climate analysis
 **Data products constructed with three-satellite CERES observations using two scanners and cloud imager data (VIRS, MODIS) for improved accuracy

EOSP

Earth Observing Scanning Polarimeter

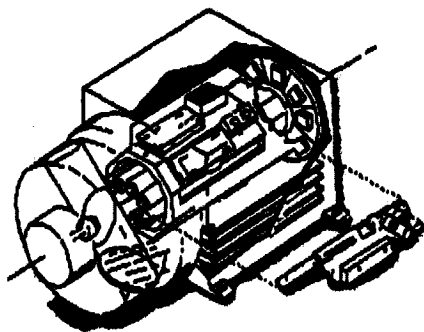

Key EOSP Facts

Heritage: Pioneer Venus CPP, Galileo PPR

Provides global aerosol distribution and cloud properties such as optical thickness and phase

Flights of aircraft version of instrument continuing

Algorithm development to continue

Responsible Center: NASA/ Goddard Space Flight Center

EOSP will provide global maps of cloud and aerosol properties from retrievals of 12-channel radiance and polarization measurements in the visible and near-infrared (0.41 to 2.25 μm). The EOSP will scan its 10-km nadir instantaneous field-of-view from limb to limb in either the cross-track or along-track direction. Polarization and radiance measurements as a function of the specific scattering geometries will be used to retrieve aerosol and cloud properties including optical thickness, particle size, liquid/ice phase, and cloud-top pressure. A primary objective is the characterization of the global aerosol distribution, its spatial and temporal variability, and the corresponding impact on climate through direct radiative effects and indirect effects as cloud condensation nuclei. EOSP data will also be used to provide atmospheric corrections for clear-sky ocean and land observations and to investigate the potential for obtaining information on vegetation and land-surface characteristics.

By measuring the polarization as well as the radiance of the sunlight scattered by the atmosphere and surface, EOSP can exploit the much greater sensitivity of the linear polarization degree to the particular physical characteristics of the scattering particles or surface. For observations of cloudy regions, the relative contributions to the polarization by the scattering from the cloud particles as compared to the highly wavelength-dependent Rayleigh scattering by the atmosphere can be used to infer the cloud-top pressure. Because of the significant differences in the linear polarization corresponding to the spherical versus non-spherical particles with sizes on the order of those typical for clouds, EOSP observations will permit the identification of the cloud-top particle phase as liquid water or ice. The dependence of the polarization on particle size will allow its retrieval using algorithms that also utilize the multispectral radiance information.

For observed regions that are essentially cloud free, the objective is to retrieve aerosol characteristics. A crucial step in this retrieval process is the discrimination of truly cloud-free scenes from those that have optically thin, or subvisible clouds. The substantial differences in the polarization signatures for the cloud particles in contrast to the much smaller aerosol particles will be employed to distinguish these cases. While the optically thin conditions corresponding to cloud-free scenes present an advantage for polarization observations owing to the higher degree of polarization associated with less multiple scattering, there is the increased complexity of the contribution by the surface to the observed polarization and radiance. The separation of surface and aerosol contributions will rely upon techniques using both wavelength-dependent characteristics and sensitivity to observer zenith angle.

EOSP products will fall into three major categories: Atmospheric cloud properties, aerosol properties, and atmospheric correction radiances to be furnished to the other surface imagers on the EOS platform. EOSP data products will include the following:

- Cloud-top pressure, with 30-m vertical resolution and 40-km horizontal resolution
- Cloud particle phase at cloud top, with 100-km horizontal resolution
- Cloud particle size at cloud top, with 100-km horizontal resolution
- Cloud optical thickness, with 40-km horizontal resolution
- Aerosol optical thicknesses at an altitude range of 0 to 35 km, with 40-km horizontal resolution
- Atmospheric correction radiances covering the spectral region from 0.41 to 2.25 μm , with 40-km horizontal resolution.

Principal Investigator

Larry D. Travis

Larry D. Travis received a Ph.D. from Pennsylvania State University in 1971. He is currently the Associate Chief at the NASA Goddard Institute for Space Studies. His research interests include radiative transfer, single and multiple scattering theory, theoretical interpretation of planetary polarization, and satellite platform measurements of planetary polarization. Dr. Travis served as Principal Investigator for the Pioneer Venus Cloud Photopolarimeter Experiment and is a Co-Investigator for the Galileo Photopolarimeter Radiometer Experiment.

Co-Investigators

F. Gerald Brown - *Santa Barbara Remote Sensing*

Andrew Lacis - *NASA/Goddard Institute for Space Studies*

William B. Rossow - *NASA/Goddard Institute for Space Studies*

Edgar E. Russell - *Santa Barbara Remote Sensing*

References

Brown, F.G., and E.E. Russell, 1990: Earth Observing Scanning Polarimeter, Phase B Final Report. Contract #NAS5-30756, DM LB870016, Santa Barbara Research Center (December).

Mishchenko, M.I., and L.D. Travis, 1997: Satellite retrieval of aerosol properties over the ocean using polarization as well as intensity of reflected sunlight. *J. Geophys. Res.*, **102**, 16,989-17,013.

Mishchenko, M.I., and L.D. Travis, 1997: Satellite retrieval of aerosol properties over the ocean using measurements of reflected sunlight: Effect of instrumental errors and aerosol absorption. *J. Geophys. Res.*, **102**, 13,543-13,553.

EOSP Parameters

Simultaneous measurement of radiance and linear polarization degree in 12 spectral bands from 0.41 to 2.25 μm

Spectral bidirectional reflectance distribution function accurate to 5%

Polarization accurate to 0.2%

Swath: $\pm 65^\circ$ (limb-to-limb scan)

Spatial resolution: 10 km at nadir

Mass: 19 kg

Duty cycle: 100%

Power: 14 W (normal), 22 W (peak)

Data rate: 44 kbps (orbit average), 88 kbps (peak, daylight only)

Thermal control by: Heaters and radiators; 185 K radiator for SWIR detector cold focal plane

Thermal operating range: 0-40°C

FOV: $\pm 65^\circ$ limb to limb

Instrument IFOV: 14.2 mrad

Pointing requirements (platform+instrument, 3 σ):

Control: 3,600 arcsec

Knowledge: 150 arcsec

Stability: 100 arcsec per 10 sec

Jitter: 100 arcsec per 10 sec

Physical size: 51 \times 25 \times 81 cm (stowed);
51 \times 56 \times 81 cm (deployed)

EOSP Data Products

Product Name	Accuracy		Temporal Resolution	Horizontal		Vertical	
	Absolute :: Relative			Resolution :: Coverage	Resolution :: Coverage		
Level-1B Polarization	0.2% :: 0.1%		1/day [d]	10-70 km :: Global		N/A :: N/A	
Level-1B Radiance	5% :: 1%		1/day [d]	10-70 km :: Global		N/A :: N/A	
Aerosol Optical Thickness	0.05 :: 10%		1/day [d]	40 km :: Global		Column :: Atmosphere	
Cloud Product			1/day [d]	40-100 km :: Global		30 mb, Column :: Cloud	

ETM+ *Enhanced Thematic Mapper Plus*

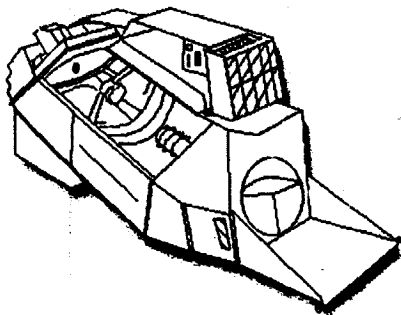

Key ETM+ Facts

Selected for flight on Landsat 7

Heritage: Landsat 4, 5 and 6

Imaging radiometer

Provides high spatial, multispectral images of the sunlit land surface

16-day repeat cycle

7 spectral bands from visible to thermal infrared plus panchromatic band

Launched 15 April 1999

Prime Contractor: Raytheon SBRS

Responsible Center: NASA/Goddard Space Flight Center

Landsat 7 / ETM+ URL

<http://landsat.gsfc.nasa.gov/>

The Enhanced Thematic Mapper Plus (ETM+) has flown on the Landsat 7 satellite as of 15 April, 1999, and provides synoptic, repetitive, multispectral, high-resolution, digital imagery of the Earth's land surfaces. Since 1972, the Landsat Program has provided calibrated land-surface digital imagery to a broad user group including the agricultural community, global change researchers, state and local governments, commercial users, international users, and the military. The Landsat 7 mission will extend the database of the Earth's surface into the next century.

The ETM+ instrument is an improved version of the Thematic Mapper instruments that flew on Landsat 4 and 5. Like the earlier instruments, the ETM+ will acquire data for six visible, near-infrared, and shortwave infrared spectral bands at a spatial resolution of 30 meters (see Spectral Band Summary table).

The ETM+ instrument also incorporates a 15-meter resolution panchromatic band as well as improved ground resolution for the thermal infrared band (60 m vs. 120 m). Incorporation of in-flight full- and partial-aperture solar calibration will improve the overall radiometric accuracy to 5 percent. The ETM+ will provide data that are sufficiently consistent in terms of acquisition geometry, spatial resolution, spectral characteristics, and calibration with previous Landsat data to meet requirements for global change research.

The Landsat 7 satellite operates in a circular, sun-synchronous orbit with an inclination of 98.2°, and altitude of 705 km, and a descending node equatorial crossing time of 10:00 AM plus or minus 15 minutes. This orbit will allow Landsat 7 to precede the Terra satellite by 30 minutes along a common ground track. The 185 km swath of coverage provided by the ETM+ field-of-view affords a global view every 16 days.

ETM+ data will be used primarily to characterize and monitor change in land-cover and land-surface processes. The high spatial resolution and seasonal global coverage of ETM+ will allow improved assessment of both the rates of land-cover change, and the local processes responsible for those changes. Deforestation, ecosystem fragmentation, agricultural productivity, glacier dynamics, coastal hazards, and volcano monitoring are all science targets for ETM+. The common orbit with Terra offers additional opportunities for data fusion with the ASTER, MISR, and MODIS sensors.

The mission will generate and periodically refresh a global archive with substantially cloud-free, sunlit data. To facilitate this objective, a long-term acquisition plan has been devised to ensure maximal global data acquisition, taking into account vegetation seasonality, cloud cover, and instrument gain.

Data stored onboard, as well as real-time continental U.S. data, will be downlinked to the Landsat 7 ground station located at the EROS Data Center (EDC) in South Dakota. Data received

at the EDC will be processed for archiving and distribution by the Land Processes DAAC. All data received at EDC will be available at LOR (no radiometric calibration; limited geometric correction). In addition, a subset of these scenes can be processed to Level 1 (radiometric and geometric corrections applied).

Team Leader

Samuel N. Goward

Samuel Goward received his Ph.D. in Geography from Indiana State University in 1979, and holds A.B. and M.A. degrees from Boston University. Dr. Goward has been involved with the analysis of Landsat data since the 1970's. More recently, Dr. Goward has focused on the extraction of vegetation biophysics from both Landsat and AVHRR data, and on the interactions between global land cover and climate. He is currently Chair of the Department of Geography at the University of Maryland, College Park.

Science Team Members

Robert Bindshadler - *NASA/Goddard Space Flight Center*

Robert F. Cahalan - *NASA/Goddard Space Flight Center*

Luke P. Flynn - *University of Hawaii*

Alexander Goetz - *University of Colorado*

Susan Moran - *U.S. Department of Agriculture*

Frank Muller-Karger - *University of South Florida*

Frank D. Palluconi - *Jet Propulsion Laboratory*

John C. Price - *U.S. Department of Agriculture*

John R. Schott - *Rochester Institute of Technology Center for Imaging*

David L. Skole - *Michigan State University*

Kurtis J. Thome - *University of Arizona*

James E. Vogelman - *Raytheon ITSS*

Curtis E. Woodcock - *Boston University*

Landsat 7 Project

Philip Sabelhaus - *Landsat 7 Project Manager*

Darrel Williams - *Landsat 7 Project Scientist*

James Irons - *Deputy Project Scientist*

References

Goward, S.N., and D.L. Williams, 1997: Landsat and Earth systems science: Development of terrestrial monitoring. *Photogrammetric Engineering & Remote Sensing*, **63**, 887-900.

ETM+ Parameters	
Whiskbroom scanning radiometer	
3 VIS, 1 NIR, 2 SWIR, 1 TIR, 1 pan spectral bands 30 m resolution in VIS, NIR, SWIR; 60 m TIR; 15 m pan	
Periodic (seasonal) global coverage of land surfaces	
Swath: 185 km ($\pm 7.5^\circ$)	
Mass: 425 kg	
Power: 590 W (imaging), 175 W (Standby)	
Duty cycle: 15% imaging	
Thermal control: 90 K Radiative cooler	
Pointing requirements:	
Control:	60 arcsec (1 sigma)
Knowledge:	45 arcsec (1 sigma)
Jitter:	4 arcsec (1 sigma)
Physical Size:	
Scanner Assembly:	196 x 114 x 66 cm
Auxiliary Electronics:	90 x 66 x 35 cm

ETM+ Spectral Band Summary

Spectral Band	Half-Amplitude Bandwidth (μm)	IFOV Size (μr)	Nominal Ground Sample Size (m)
Panchromatic	0.50-0.90	18.5 x 21.3	15
1 (VIS)	0.45-0.52	42.6	30
2 (VIS)	0.52-0.60	42.6	30
3 (VIS)	0.63-0.69	42.6	30
4 (NIR)	0.76-0.90	42.6	30
5 (SWIR)	1.55-1.75	42.6	30
6 (TIR)	10.42-12.50	85.2	60
7 (SWIR)	2.08-2.35	42.6	30

GLAS

Geoscience Laser Altimeter System

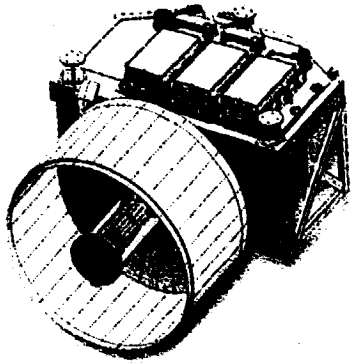

Key GLAS Facts

EOS Facility Instrument

Selected for ICESat (Ice, Clouds and land Elevation Satellite) flight

Heritage: Airborne and Spaceborne Laser Altimetry and Lidar Systems; Satellite Laser Ranging Systems

GLAS completed PDR in January 1998

GLAS CDR in March 1999

ICESat MDR in December 1998

Nadir-pointed laser altimeter at 600-km altitude, 94° inclination

Measures ice-sheet topography and temporal changes in topography; cloud heights, planetary boundary heights, and aerosol vertical structure; and land and water topography

ICESat spacecraft delivery order signed February 1998, with Ball Aerospace, Boulder, Colorado.

NASA/Goddard Space Flight Center in-house development of GLAS

Scheduled for launch in July 2001

3-year lifetime with 5-year goal

GLAS-related URLs

<http://www.csr.utexas.edu/glas/> (Science)

<http://icesat.gsfc.nasa.gov> (ICESat)

<http://ftpwww.gsfc.nasa.gov/eib/glas.html/> (Instrument)

<http://glas.wff.nasa.gov> (Data System)

GLAS is a laser altimeter to be carried on ICESat (Ice, Clouds and land Elevation Satellite), which is scheduled to launch in July 2001. The ICESat mission will measure ice-sheet topography and associated temporal changes, cloud and atmospheric properties, and along-track topography over land and water. For ice-sheet applications, the laser altimeter will measure height from the spacecraft to the ice sheet, to a precision of better than 10 cm with a 66-m surface spot size. The height measurement, coupled with knowledge of the radial orbit position, will provide the determination of surface topography. Characteristics of the return pulse will be used to determine surface roughness. Changes in ice-sheet thickness at a level of a few tens of cm (anticipated to occur on a subdecadal time scale) will provide information about ice-sheet mass balance and will support prediction analyses of cryospheric response to future climatic changes. The ice-sheet mass balance and contribution to sea-level change will also be determined. The accuracy of height determinations over land will be assessed using ground slope and roughness. The surface echoes will be digitized over a total dynamic range of 30 m over the oceans and 80 m elsewhere.

Along-track cloud and aerosol height distributions will be determined with a vertical resolution of 75 to 200 m. The horizontal resolution will vary from 150 m for dense clouds to 50 km for aerosol structure and planetary boundary layer height. Unambiguous measurements of cloud height and the vertical structure of thin clouds will support studies on the influence of clouds for radiation balance and climate feedbacks. Polar clouds and haze will be detected and sampled with much greater sensitivity, vertical resolution, and accuracy than can be achieved by passive sensors. Planetary boundary layer height will be directly and accurately measured for input into surface flux and air-sea and air-land interaction models. Direct measurements of aerosol vertical profiles will contribute to understanding of aerosol-climate effects and aerosol transport.

The GLAS instrument is being developed by a Goddard-led instrumentation team, and the ICESat spacecraft will be supplied by Ball Aerospace. GLAS uses a diode pumped, Q-switched Nd:YAG laser with energy levels of 75 mJ (1.064 μm) and 35 mJ (0.532 μm). Three lasers will be flown to cover the lifetime of the mission. The pulse repetition rate is 40 pulses/sec, and the beam divergence is approximately 0.11 mrad. The infrared pulse is used for surface altimetry and cloud-top measurements, and the green pulse is used for measurements of thin clouds and aerosols. The pointing angle of the laser pulse is measured with an accuracy of about 1.5 arcseconds. The altimeter uses a 100-cm-diameter telescope.

In the 120 days following launch, the ground track will repeat in 8 days to provide multiple overflights of ground verification/validation sites. The main mission will use a 183-day repeat track.

Team Leader
Bob E. Schutz

Bob Schutz received a Ph.D. in 1969. Currently, he is Professor of Aerospace Engineering and Engineering Mechanics at the University of Texas-Austin, and holds the FSX Professorship in Space Applications and Exploration. He is also Associate Director of the Center for Space Research and a member of the Applied Research Laboratory staff, both of which are components of the University of Texas-Austin.

Dr. Schutz is active in research pertaining to the application of satellite data to the areas of geodesy, geophysics, and oceanography. He has extensive experience in the analysis of laser-ranging measurements from the Laser Geodynamics Satellite (LAGEOS) and other satellites, radar-altimeter measurements collected from Seasat and Geosat, and measurements obtained from the Global Positioning System (GPS). He has been instrumental in the development of software for studies in crustal motions, sea-surface topography, orbital dynamics, variations in Earth rotation, and temporal changes in the Earth gravity field.

Dr. Schutz serves as the President of the American Geophysical Union Geodesy Section and on various committees in the International Association of Geodesy.

Science Team Members

Charles R. Bentley - *University of Wisconsin-Madison*

Jack L. Bufton - *NASA/Goddard Space Flight Center*

Thomas A. Herring - *Massachusetts Institute of Technology*

Jean-Bernard Minster - *Scripps Institution of Oceanography*

James D. Spinhirne - *NASA/Goddard Space Flight Center*

Robert H. Thomas - *EG&G/Wallops Flight Facility*

H. Jay Zwally - *NASA/Goddard Space Flight Center*

References

Geoscience Laser Altimeter System GLAS: Science Requirements, Prepared by GLAS Science Team, Version 2.01, October 1997.

GLAS Parameters

Uses Nd:YAG laser with 1.064- and 0.532- μm output

Primary cloud and aerosol data are extracted from the green pulse

Height measurements: Determined from the round-trip pulse time of the infrared pulse flight

Swath: Nadir viewing

Spatial Resolution: At 40 pulses per second, the centers of 66-m spots are separated in the along-track direction by 170 m for a 600-km altitude orbit; the cross-track resolution is determined by the 183-day ground-track repeat cycle which yields 15-km track spacing at the equator and 2.5 km at 80° latitude. The orbit inclination is 94°

Mass: 300 kg

Duty cycle: 100%

Power: 330 W average

Data rate: ~ 450 kbps

Thermal control by: Radiators supplemented by heaters, heat pipes

Thermal operating range: 20° \pm 5° C

Telescope FOV: Nadir only, 375 μrad and 160 μrad (0.532 μm)

Instrument IFOV: ~66 m laser footprint at nadir

Pointing Requirements (platform + instrument):
Control (3 σ): 30 arcsec roll, 30 arcsec pitch, 1° yaw

Post-processed pointing knowledge (1 σ): 1.5 arcsec (roll and pitch axes, to be provided by instrument-mounted star trackers, gyro system and laser reference sensor (LRS))

Post-processed position requirements: radial orbit for ice sheet to <5 cm and along-track/cross-track position to <20 cm (to be provided by spacecraft-mounted GPS receiver and SLR array)

Physical size: telescope diameter is 100 cm, height is ~175 cm

GLAS Data Products

PRODUCT NAME	ACCURACY Absolute :: Relative	TEMPORAL Resolution	HORIZONTAL Resolution :: Coverage	VERTICAL Resolution :: Coverage
Level-1A Product				
Level-1B Non-instrument Correction		continuous	:: Global	:: Global
Aerosol Vertical Structure	20% (profile), 150 m (Boundary Layer Height) ::	1/(2-25 days)	2-100 km :: Global	150 m (profile), N/A (Boundary Layer Height) :: Atmosphere
Cloud Height for Multiple Layers	75 m ::	1/(2-25 days)	0.2 - 10 km :: Global	N/A :: Cloud
Ice Sheet Elevation	130 mm (single measurement up to 1 deg surface slope) ::	2/year	170 m (Along Track) × 2.5 km avg. (Cross Track) :: Land/Cryosphere	N/A :: Cryosphere
Ice Sheet Roughness	10% ::	2/year	50 km :: Land/Cryosphere	N/A :: Cryosphere
Thin Cloud/Aerosol Optical Depth	20% ::	1/(2-25 days)	2-100 km :: Global	N/A :: Atmosphere
Land Topography	1-5 m ::	2/year	170 m (Along Track) × 15 km (equator) (Cross Track) :: Land	N/A :: Surface
Vegetation Topography	1-5 m ::	2/year	170 m (Along Track) × 15 km (equator) (Cross Track) :: Land	N/A :: Surface

HIRDLS

High Resolution Dynamics Limb Sounder

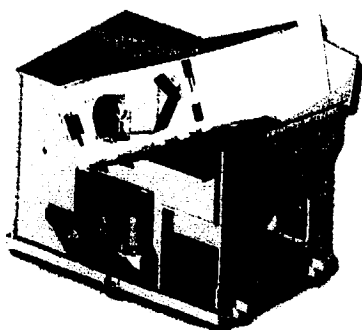

Key HIRDLS Facts

Selected for flight on EOS CHEM

Heritage: LRIR (Nimbus-6), LIMS and SAMS (Nimbus-7), ISAMS and CLAES (UARS)

Observes global distribution of temperature and concentrations of O₃, H₂O, CH₄, N₂O, NO₂, HNO₃, N₂O₅, CFC11, CFC12, ClONO₂, and aerosols in the upper troposphere, stratosphere, and mesosphere

Scanning infrared limb sounder

21 photoconductive HgCdTe detectors cooled to 65 K; each detector has a separate band-pass interference filter

Joint program between University of Colorado and Oxford University

Prime Contractors: Lockheed Martin (U.S.) and Matra-Marconi Space (U.K.)

HIRDLS URL

<http://web.eos.ucar.edu/hirdls/>

HIRDLS is an infrared limb-scanning radiometer designed to sound the upper troposphere, stratosphere, and mesosphere to determine: temperature; the concentrations of O₃, H₂O, CH₄, N₂O, NO₂, HNO₃, N₂O₅, CFC11, CFC12, ClONO₂, and aerosols; and the locations of polar stratospheric clouds and cloud tops. The goals are to provide sounding observations with horizontal and vertical resolution superior to that previously obtained; to observe the lower stratosphere with improved sensitivity and accuracy; and to improve understanding of atmospheric processes through data analysis, diagnostics, and use of two- and three-dimensional models.

HIRDLS performs limb scans in the vertical at multiple azimuth angles, measuring infrared emissions in 21 channels ranging from 6.12 to 17.76 μm . Four channels measure the emission by CO₂. Taking advantage of the known mixing ratio of CO₂, the transmittance is calculated, and the equation of radiative transfer is inverted to determine the vertical distribution of the Planck black body function, from which the temperature is derived as a function of pressure. Once the temperature profile has been established, it is used to determine the Planck function profile for the trace-gas channels. The measured radiance and the Planck function profile are then used to determine the transmittance of each trace species and its mixing-ratio distribution.

Winds and potential vorticity are determined from spatial variations of the height of geopotential surfaces. These are determined at upper levels by integrating the temperature profiles vertically from a known reference base. HIRDLS will improve knowledge in data-sparse regions by measuring the height variations of the reference surface with the aid of a gyro package. This level (near the base of the stratosphere) can also be integrated downward using nadir temperature soundings to improve tropospheric analyses.

Overall science goals of HIRDLS are to observe the global distributions of temperature and several trace species in the stratosphere and upper troposphere at high vertical and horizontal resolution. Specific issues to be investigated include:

- Fluxes of mass and chemical constituents between the troposphere and stratosphere [stratosphere-troposphere exchange (STE)];
- chemical processes, transport, and mixing [particularly in the upper troposphere/lower stratosphere (UT/LS)];
- momentum, energy, heat, and potential vorticity balances of the upper troposphere and middle atmosphere;

- geographically and seasonally unbiased long-term climatologies and interannual variability of middle-atmosphere temperature, constituents, dynamical fields, and gravity waves;
- global distributions and interannual variations of aerosols, cirrus, and PSCs;
- tropospheric cloud-top heights;
- tropospheric temperature and water vapor retrievals (by providing high-resolution limb data for joint retrieval with EOS nadir sounders); and
- diagnostic studies of atmospheric dynamics, chemistry, and transport processes, down to small spatial scales, to test and improve models of these processes.

The instrument has a long heritage extending back to Nimbus-4, and will obtain profiles over the entire globe, including the poles, both day and night. Complete Earth coverage (including polar night) can be obtained in 12 hours. High horizontal resolution is obtained with a commandable azimuth scan that, in conjunction with a rapid elevation scan, provides profiles up to 3,000 km apart in an across-track swath. Vertical profiles are spaced every 5° in latitude and longitude. Observations of the lower stratosphere and upper troposphere are improved through the use of special narrow and more-transparent spectral channels. The instrument is programmable; thus, a variety of observation modes can be used, and may be adapted in flight to observe unpredicted geophysical events.

Co-Principal Investigators

John Barnett

Dr. Barnett received an M.A. in Natural Sciences, with first-class honors, from Cambridge University and a Ph.D. in Atmospheric Physics from Oxford University. He is currently a University Research Lecturer for the Department of Physics at Oxford. Dr. Barnett served as a member of data-processing teams for the suite of Nimbus instruments, as Co-Investigator for Improved Stratospheric and Mesospheric Sounder (ISAMS), and as co-chairman of the COSPAR group on the Reference Middle Atmosphere. He is the recipient of the COSPAR William Nordberg Award and the Royal Meteorological Society L. F. Richardson Award.

John Gille

John Gille received a B.S. in Physics, magna cum laude, from Yale University, an M.A. in Physics from Cambridge University, and a Ph.D. in Geophysics from MIT. He has served as Head of the Global Observations, Modeling, and Optical Techniques Section of NCAR. Dr. Gille

was Co-Sensor Scientist on LIMS, launched on Nimbus-7, and was Principal Investigator on LRIR, which flew on Nimbus-6. He has been involved in CLAES collaboration, with NOAA's development of GOMR, and on several investigations analyzing satellite data. He is a Fellow of the American Meteorological Society and the American Association for the Advancement of Science, and was the recipient of the NCAR Technology Advancement Award and the NASA Exceptional Scientific Achievement Medal.

Co-Investigators

David Andrews - *Oxford University, United Kingdom*

Linnea Avallone - *University of Colorado*

Byron Boville - *National Center for Atmospheric Research*

Guy Brasseur - *National Center for Atmospheric Research*

Michael Coffey - *National Center for Atmospheric Research*

Robert S. Harwood - *University of Edinburgh, United Kingdom*

James R. Holton - *University of Washington*

Conway B. Leovy - *University of Washington*

William Mankin - *National Center for Atmospheric Research*

Michael E. McIntyre - *University of Cambridge, United Kingdom*

Heinz G. Muller - *University of Sheffield, United Kingdom*

Christopher T. Mutlow - *Rutherford Appleton Laboratory, United Kingdom*

Alan O'Neill - *University of Reading, United Kingdom*

John A. Pyle - *Cambridge University, United Kingdom*

Clive D. Rodgers - *Oxford University, United Kingdom*

Frederic Taylor - *Oxford University, United Kingdom*

O. Brian Toon - *University of Colorado*

Geraint Vaughan - *University College of Wales, United Kingdom*

Robert J. Wells - *Oxford University, United Kingdom*

John G. Whitney - *Oxford University, United Kingdom*

E.J. Williamson - *Oxford University, United Kingdom*

References

Barnett, J.J., A.G. Darbyshire, C.L. Hepplewhite, C.W.P. Palmer, F. Row, P. Venters, R.E.J. Watkins, J.G. Whitney, J.C. Gille, and B.R. Johnson, 1998: Pre-launch calibration of the HIRDLS instrument. *SPIE*, **3437**, 137-146.

Barnett, J.J., P. Venters, and J.C. Gille, 1998: Direct Measurement of Geopotential Height by the HIRDLS Instrument. *Adv. Space Res.*, **22**, 1497-1500.

Dials M.A., J.C. Gille, J.J. Barnett, and J.G. Whitney, 1998: Description of the High Resolution Dynamics Limb Sounder (HIRDLS) instrument. *SPIE*, **3437**, 84-91.

Edwards, D., J. Gille, P. Bailey, and J. Barnett, 1995: Selection of the sounding channels for the High Resolution Dynamics Limb Sounder. *Appl. Optics*, **34**, 7006-7017.

Gille, J., and J. Barnett, 1992: The High-Resolution Dynamics Limb Sounder (HIRDLS). An instrument for the study of global change. The Use of EOS for Studies of Atmospheric Physics, J. Gille and G. Visconti, Eds., North-Holland, 433-450.

Gille, J., J. Barnett, M. Coffey, W. Mankin, B. Johnson, M. Dials, J. Whitney, D. Woodard, P. Arter, and W. Rudolf, 1994: The High Resolution Dynamics Limb Sounder (HIRDLS) for the Earth Observing System. *SPIE*, **2266**, 330-339.

Gille, J., and J. Barnett, 1996: Conceptual design of the High Resolution Dynamics Limb Sounder (HIRDLS) for the EOS Chemistry Mission. *SPIE*, **2830**, 190-201.

Gille, J.C., and J.J. Barnett, 1996: Conceptual design of the High Resolution Dynamics Limb Sounder (HIRDLS) for the EOS Chemistry Mission. *SPIE*, **2830**, 190-201.

Johnson, B.R., W.G. Mankin, and J.C. Gille, 1998: Description of the HIRDLS Radiometric Model (HIRAM). *SPIE*, **3437**, 147-155.

Palmer, C., and J. Whitney, 1996: The radiometric calibration budget for the High-Resolution Dynamics Limb Sounder. *J. Atmos. Ocean. Tech.*, **13**, 336-348.

HIRDLS Parameters

Spectral range: 6 to 18 μm

Standard profile spacing: 5° longitude \times 5° latitude, and 1-km vertical resolution; programmable to other modes and resolutions

Swath: Typically six profiles across 2,000- to 3,000-km-wide swath

Spatial resolution: Profile spacing 500 \times 500 km horizontally (equivalent to 5° long \times 5° lat) \times 1 km vertically; averaging volume for each data sample 1 km vertical \times 10 km across \times 300 km along line-of-sight

Mass: 220 kg

Duty cycle: 100%

Power: 220 W (average), 239 W (peak)

Data rate: 65 kbps

Thermal control by: Stirling cycle cooler, heaters, sun baffle, radiator panel

Thermal operating range: 20-30° C

Scan range: Elevation, 22.1° to 27.3° below horizontal, Azimuth, -21° (sun side) to +43° (anti-sun side)

Detector IFOV: 1 km vertical \times 10 km horizontal

Platform pointing requirements (platform+instrument, 3 σ):

Control and Knowledge: Such that scan range will allow all channels to observe from 0.25° below the hard horizon to 3.25° above it

Stability: 30 arcsec/sec per axis

Jitter: 84-Hz sample spacing uniform to ± 7 arcsec

Physical size: 154.5 \times 113.5 \times 130 cm

HIRDLS Data Products

Product Name	Accuracy Absolute :: Relative	Temporal Resolution :: Coverage	Horizontal Resolution :: Coverage	Vertical Resolution :: Coverage
Level-1B Product	.5-1% :: 1-8 x 10 ⁻⁴ Wm ⁻² sr	12 msec :: Continuous	500 km :: Global	200 m :: 0-150 km
Aerosol Extinction Coef (4 channels)	5-10% :: 1-10%	2/day [d,n]	500 km :: Global	1 km :: 5-60 km (given accuracies for 7-30 km)
CFC-11 (CFC1 ₁) Conc	5-10% :: 1-10%	2/day [d,n]	500 km :: Global	1 km :: 5-50 km (given accuracies for 7-30 km)
CFC-12 (CF ₂ Cl ₂) Conc	5-10% :: 1-10%	2/day [d,n]	500 km :: Global	1 km :: 5-55 km (given accuracies for 7-30 km)
CH ₄ Conc	5-10% :: 1-10%	2/day [d,n]	500 km :: Global	1 km :: 5-65 km (given accuracies for 7-65 km)
ClONO ₂	5-10% :: 3-15%	2/day [d,n]	500 km :: Global	1 km :: 15-65 km (given accuracies for 15-80 km)
Cloud Top Altitude	1 km :: 400 m	2/day [d,n]	500 km :: Global	1 km :: 5-20 km
Geopotential Height-Gradient	0.04 m/km :: 0.04 m/km	2/day [d,n]	500 km :: Global	1 km :: 5-100 km (given accuracies for 15-30 km)
H ₂ O Conc	5-10% :: 1-10%	2/day [d,n]	500 km :: Global	1 km :: 5-70 km (given accuracies for 7-65 km)
HNO ₃ Conc	5-10% :: 1-10%	2/day [d,n]	500 km :: Global	1 km :: 5-50 km (given accuracies for 10-40 km)
N ₂ O Conc	5-10% :: 1-10%	2/day [d,n]	500 km :: Global	1 km :: 5-70 km (given accuracies for 7-60 km)
N ₂ O ₅ Conc	5-10% :: 1-10%	2/day [d,n]	500 km :: Global	1 km :: 10-65 km (given accuracies for 15-45 km)
NO ₂ Conc	5-10% :: 1-10%	2/day [d,n]	500 km :: Global	1 km :: 5-65 km (given accuracies for 15-55 km)
O ₃ Conc	5-10% :: 3-10%	2/day [d,n]	500 km :: Global	1 km :: 5-85 km (given accuracies for 7-80 km)
Temperature/Pressure Profile	1-2 K :: 0.4-1 K	2/day [d,n]	500 km :: Global	1 km :: 5-100 km (given accuracies for 8-80 km)

Jason-1

POSEIDON-2 • JMR • DORIS*

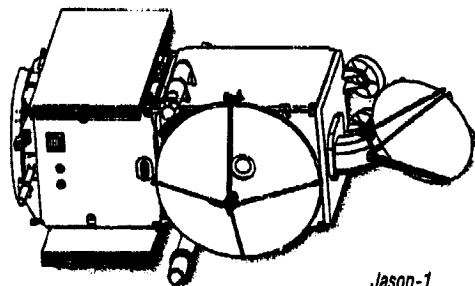

Jason-1

Key Poseidon-2 Facts

Heritage: Poseidon-1 radar altimeter

Dual-frequency radar altimeter

Maps the topography of the sea surface for calculating ocean surface current velocity

Measures ocean wave height and wind speed

Prime contractor: Alcatel Espace

Responsible center: Centre Nationale d'Etudes Spatiales (France)

Key DORIS Facts

Heritage: TOPEX/Poseidon, SPOT-2, SPOT-3, SPOT-4

Precision orbit determination system

Provides orbital positioning information

Prime contractors: Dassault Electronique (onboard instrument), CEIS Espace and SOREP (ground beacons).

Responsible center: Centre Nationale d'Etudes Spatiales (France)

Key Jason Microwave Radiometer (JMR) Facts

Heritage: TOPEX/Poseidon, Seasat, Nimbus-7

Tri-frequency microwave radiometer

Provides total water vapor along the path viewed by the altimeter for range correction

In-house Jet Propulsion Laboratory development

Jason-1 URL

<http://topex-www.jpl.nasa.gov/jason1/>

* Collectively, DORIS, Poseidon-2, JMR, LRA, and TRSR make up the instrumentation for the radar altimetry Jason-1 mission

Poseidon-2

Poseidon-2 is a nadir-looking radar altimeter that maps the topography of the sea surface. The shape and strength of the radar return pulse also provide measurements of ocean wave height and wind speed, respectively. Through the mapping of sea-surface topography, Poseidon-2 provides information on the ocean-surface current velocity which, when combined with ocean models, can lead to a four-dimensional description of ocean circulation. The heat and biogeochemical fluxes carried by ocean currents hold the key to understanding the ocean's role in global changes in climate and biogeochemical cycles. Secondary research contributions include the study of the variations in sea level in response to global warming/cooling and hydrological balance; the study of marine geophysical processes (such as crustal deformation) from the sea-surface topography; and the monitoring of global sea state from the wave height and wind-speed measurement.

Poseidon-2 was developed by Alcatel Espace Systems (ATES) under contract from CNES Toulouse Space Center. A single-frequency version of this altimeter (Poseidon-1) is being flown on TOPEX/Poseidon as an experimental instrument to allow validation of the accuracy, operation, and signal processing of a small-volume, lightweight, low-power altimeter. It uses the same antenna as the NASA Altimeter (ALT) aboard TOPEX/Poseidon, but operates at the single frequency of 13.6 GHz. Both the operating principles and the performance of the NASA and CNES altimeters are similar; however, Poseidon-1 has only one-fourth the mass, volume, and power consumption of the NASA instrument. Moreover, the telemetry data rate is reduced by a factor of seven because of more-extensive onboard processing.

Poseidon-2 is a version of Poseidon-1, improved by adding a second frequency at 5.3 GHz, as well as changing to digital technology and using a new, more-powerful rad-hard microprocessor, while keeping the same mass and size as the single-frequency altimeter.

JMR

Altitude accuracy (as determined by the altimeter aboard Jason-1) is affected by the variable water content of the atmosphere, mainly the troposphere. The primary JMR objective involves measuring the radiometric brightness temperature related to water vapor and liquid water in the same field-of-view as the altimeter. In turn, these brightness temperatures are converted to path-delay information required

by the altimeter for precise topography measurements. In order to achieve the required 1.2-cm path delay, the absolute accuracy required of JMR is 1 K.

JMR will passively measure microwave radiation continuously, and derived data will be used to determine water vapor and liquid water content in the altimeter field-of-view. JMR consists of a collecting aperture, a multi-frequency feed assembly that illuminates the collecting aperture; multichannel microwave receivers; a data unit; power supplies; and ground support equipment.

Developed by the Jet Propulsion Laboratory (JPL), JMR operates at frequencies of 18.7, 23.8, and 34 GHz to provide estimates of total atmospheric water-vapor content. By operating simultaneously on three frequencies, the columnar path delay is derived from microwave brightness temperature. The 23.8 GHz frequency is the primary measurement channel; the 18.7 and 34 GHz channels are used to remove the effects of wind speed and cloud cover, respectively. The 23.8 GHz channel is redundant. These data allow reduction of the water vapor delay error to 1 cm, permitting an overall altimetric accuracy of 3 cm. In-flight calibration is provided by three cross-calibrated noise diodes.

DORIS

DORIS is based upon the accurate measurement of the doppler shift of radiofrequency signals transmitted from ground-based beacons and received on board the spacecraft when it passes over. Measurements are made on two frequencies: 2.03625 GHz for precise doppler measurement and 401.25 MHz for ionospheric correction. The 401.25 MHz is also used for measurement time tagging and auxiliary data. Approximately 50 global all-weather radio beacons are currently in operation.

The separation of the two transmitting frequencies makes it possible to reduce the ionospheric effect to around the centimeter level. Tropospheric refraction is modeled using surface meteorological data which are directly transmitted to the satellite from the ground stations.

DORIS was validated by a prototype flown on the Systeme pour l'Observation de la Terre-2 (SPOT-2) satellite, launched in January 1990. It provides over six thousand measurements per day, which are used to refine data-processing methods and to improve models of the Earth's gravity field. A DORIS instrument now operates aboard the Ocean Topography Experiment (TOPEX/Poseidon) spacecraft, a joint mission between the U.S. and France launched in August 1992. A new capability has been validated onboard SPOT-4 (launched in 1998). It is the real-time onboard orbit determination.

The DORIS instruments slated for the Jason series will be upgraded versions of those aboard TOPEX/Poseidon. Experience with SPOT-2, SPOT-4, and TOPEX/Poseidon has shown that the instrument oper-

Poseidon-2 Parameters

Transmitted pulse width of 105 μ sec

Pulse repetition frequency of 2100 Hz (1800 for Ku band and 300 for C band)

Maximum radio frequency output power to antenna of 40 dBm (Ku band) and 46 dBm (C band)

Mass: 52 kg for a dual frequency, dual configuration with one antenna

Duty cycle: 100%

Power: 66 W (43 W RFU, 23 W PCU)

DC supply bus: Unregulated 21-32 V

Transmission frequency: 13.575 GHz, 5.3 GHz

Data rate: 22.5 kbps (including wave form data and on-board estimated parameters)

Thermal control by: Heat transfer by conduction to mounting surface and by radiation within the instrument module

Thermal operating range: -5-35° C

IFOV: 20° cone (centered on nadir)

Pointing requirements (platform+instrument, 3 σ):

Control (Satellite): 0.33° (3 σ)

Knowledge: <0.1°

Physical size: 42.2 x 24.6 x 24.5 cm (RFU);
26.8 x 20.5 x 24.9 cm (PCU)

ates most efficiently at an altitude between 750 and 1,500 km. However, DORIS can operate from 300 km to several thousand km.

Team Leader

Since Jason-1 is essentially a follow-on to TOPEX/Poseidon as a collaborative effort between NASA and CNES, it was decided that the organization and management of its Science Working Team (SWT) should follow the model of TOPEX/Poseidon. The SWT is co-chaired by a French Project Scientist and an American Project Scientist. As co-leaders of the SWT, the two Project Scientists will fulfill the role of the Team Leader. The current American Project Scientist is Dr. Lee-Lueng Fu of the Jet Propulsion Laboratory of California Institute of Technology, and the French Project Scientist is Dr. Yves Menard of CNES's Toulouse Space Center. To facilitate the participation of the members of the SWT in important mission decisions, two members of the SWT (one from the US and one from France) will be selected to be part of the mission's top management team (the Joint Steering Group).

Team Members

Rodrigo Abarca - *University of Chile*
Sabine Arnault - *LODYC, France*
David V. Arnold - *Brigham Young University*
Pierre Bahurel - *SHOM/CMO, France*
Mike Bell - *U.K. Met Office*
George H. Born - *University of Colorado*
Jean-Philippe Boulanger - *LODYC, France*
Derek M. Burrage - *Australian Institute of Marine Science*
Antonio Busalacchi - *NASA/Goddard Space Flight Center*
Stephane Calmant - *ORSTOM, France*
Anny Cazenave - *LEGOS/GRGS/UMR5566, France*
Peter Challenor - *SOC, U.K.*
Benjamin Fong Chao - *NASA/Goddard Space Flight Center*
Dudley B. Chelton - *Oregon State University*
Robert E. Cheney - *NOAA/NESDIS/NODC*
John A. Church - *CSIRO, Australia*
David Cotton - *SOC, U.K.*
Philippe Courtier - *LODYC, France*
Pierre De Mey - *LEGOS/GRGS/UMR5566, France*
Richard J. Eanes - *University of Texas, Austin*
William J. Emery - *CSIRO, Australia*
Pierre Exertier - *OCA/CERGA, France*
Laurence Eymard - *CETP/IPSL/CNRS, France*
Nelson M. Frew - *Woods Hole Oceanographic Institution*
Ichiro Fukumori - *Jet Propulsion Laboratory*
Sarah Gille - *University of East Anglia, U.K.*
Roman E. Glazman - *Jet Propulsion Laboratory*
Bruce J. Haines - *Jet Propulsion Laboratory*
David W. Hancock - *NASA/Goddard Space Flight Center*
Shiro Imawaki - *Kyushu University, Japan*
Gregg A. Jacobs - *NASA/Stennis Space Flight Center*
Per Knudsen - *NSC, Denmark*
Chester J. Koblinsky - *NASA/Goddard Space Flight Center*
Christian Le Provost - *LEGOS/GRGS/UMR5566, France*
Pierre-Yves Le Traon - *CLS, France*
Jean-Michel Lefevre - *Météo-France*
Daniel S. MacMillan - *NVI, Inc.*
Mark A. Merrifield - *University of Hawaii*
Gary T. Mitchum - *University of South Florida*
Philip Moore - *Aston University, U.K.*

DORIS Parameters

Onboard DORIS receiver accurately measures the Doppler shift on both transmitted frequencies (401.25 and 2,036.25 MHz) received from an orbit determination beacon (ODB) station

Network of ~50 ODBs located worldwide

Receiver: 5.6 kg

USO: 1.2 kg (Total mass for a dual-string configuration is 17 kg)

Antenna: 2 kg

USO Shielding: 8 kg (Depending on magnetic environment.)

Duty Cycle: 100%

Power: 24 W (28 W peak)

Data rate: 500 bps (including the raw doppler data; 360 bps for the science operational data)

Thermal control: Heat transfer by conduction to mounting surface and by radiation within the instrument module

Thermal operating range: -10-50° C

IFOV: 125° cone (centered on nadir)

Pointing requirements (platform+instrument, 3 σ):

- Control: 1.5°
- Knowledge: 0.2° (depending on the distance between the antenna phase center and the satellite center of mass)

Physical size: 32 x 27 x 10 cm (receiver);
9 x 7 x 11 cm (Ultra Stable Oscillator (USO));
32 x 27 x 22 cm (USO magnetic shielding)
Antenna: 40 cm height x 16 cm diameter cone

JMR Parameters

Measures brightness temperatures in the nadir column at 18.7, 23.8, and 34 GHz.

Beamwidth: 1.8° at 18.7 GHz, 1.5° at 23.8 GHz, and 0.9° at 34 GHz

Temperature resolution: <1 K

System temperature: <650 K

Mass: 27 kg

Duty cycle: 100%

Power: 24 W

DC supply bus: Unregulated 23-36 V

Data rate: 1024 bps

Thermal control by: Thermal control on the JMR is by radiation to the satellite structure. The JMR box is internally mounted, with no direct exposure to space.

Thermal operating range: 10-35° C

Physical size: 75 x 86 x 137 cm

Rosemary Morrow - *LEGOS/GRGS/UMR5566, France*
 Steven R. Nerem - *University of Texas, Austin*
 James J. O'Brien - *Florida State University*
 Young-Hyang Park - *LOP Museum, France*
 Michel Petit - *ORSTOM, France*
 Joel Picaut - *ORSTOM, France*
 Rui M. Ponte - *TR, Inc.*
 Christine Provost - *LODYC, France*
 Bo Qui - *University of Hawaii, Manoa*
 Richard D. Ray - *Raytheon ITSS*
 John C. Ries - *University of Texas, Austin*
 Ernesto Rodriguez - *Jet Propulsion Laboratory*
 Dean Roemmich - *University of California, San Diego*
 Philippe Rogel - *CERFACS, France*
 Christopher S. Ruf - *Pennsylvania State University*
 Ernst Schrama - *DEOS, The Netherlands*
 Jens Schroeter - *AWI, Germany*
 David Smith - *NASA/Goddard Space Flight Center*

Detlef Stammer - *Massachusetts Institute of Technology*
 Robert H. Stewart - *Texas A&M University*
 P. Ted Strub - *Oregon State University*
 Robin T. Tokmakian - *Naval Postgraduate School*
 Jean Tournade - *IFREMER, France*
 Douglas C. Vandemark - *Wallops Flight Facility*
 Jacques Verron - *LEGI, France*
 Michael M. Watkins - *Jet Propulsion Laboratory*
 Warren B. White - *University of California, San Diego*
 Pascal Willis - *IGN, France*
 Philip Woodworth - *POL, U.K.*

Reference

Coullon, G., E. Thouvenin, N. Armand, C. Goldstein, P. DeChateau-Thierry, L. P. "Jason Mission Poseidon-2 Radar Altimeter Design." CNES Technical Note.

Radar Altimetry Data Products

Product Name	Accuracy Absolute :: Relative	Temporal Resolution	Horizontal Resolution :: Coverage	Vertical Resolution :: Coverage
Altimetry Sensor Data Record	0.7 :: 0.2 dB	20/second	0.35 km :: Earth	N/A :: Surface
Altimetry Geophysical Data Record	4 cm :: 2 cm	1/second	7 km :: Ocean	N/A :: Surface
Sea_surface Topography Map	10 cm :: 2 cm	1/(10 day)	25 km :: Ocean	N/A :: Surface

LIS

Lightning Imaging Sensor

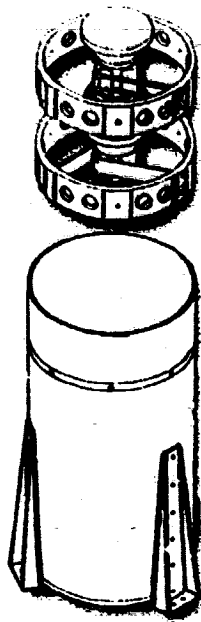

Sensor Head Assembly and Telescope

Key LIS Facts

EOS-funded instrument selected for flight on TRMM

Staring telescope/filter imaging system that detects the rate, location, and radiant energy of lightning flashes

Investigates the distribution and variability of lightning over the Earth with storm-scale spatial resolution

90% detection efficiency under both day and night conditions using background remover and event processor

In-house NASA/Marshall Space Flight Center development

Phase C/D start January 1991

Prototype for geostationary orbit

LIS URL

<http://thunder.msfc.nasa.gov/lis.html>

LIS is currently on orbit investigating the global incidence of lightning, its correlation with convective rainfall, and its relationship with the global electric circuit. Conceptually, LIS is a simple device, consisting of a staring imager optimized to locate both intracloud and cloud-to-ground lightning with storm-scale resolution over a large region of the Earth's surface, to mark the time of occurrence, and to measure the radiant energy. It will monitor individual storms within the field-of-view (FOV) for 80 seconds, long enough to estimate the lightning flashing rate. Location of lightning flashes is determined to within 5 km over a 600 x 600 km FOV.

The LIS design uses an expanded optics wide-FOV lens, combined with a narrow-band interference filter that focuses the image on a small, high-speed, charge-coupled-device focal plane. The signal is read out from the focal plane into a real-time data processor (rtdp) for event detection and data compression. The particular characteristics of the sensor design result from the requirement to detect weak lightning signals during the day when the background illumination, produced by sunlight reflecting from the tops of clouds, is much brighter than the illumination produced by the lightning.

A combination of four methods is used to take advantage of the significant differences in the temporal, spatial, and spectral characteristics between the lightning signal and the background noise. First, spatial filtering is used to match the instantaneous FOV of each detector element in the LIS focal-plane array to the typical cloud-top area illuminated by a lightning event (about 5 km). Second, spectral filtering is applied, using a narrow-band interference filter centered about the strong OI (1) emission multiplet in the lightning spectrum at 777.4 nm. Third, temporal filtering is applied. The lightning pulse duration is of the order of 400 μ sec, whereas the background illumination tends to be constant on a time scale of seconds. The lightning signal-to-noise ratio improves as the integration time approaches the pulse duration. Accordingly, an integration time of 2 msec is chosen to minimize pulse splitting between successive frames and to maximize lightning detectability. Finally, a modified frame-to-frame background subtraction is used to remove the slowly varying background signal from the raw data coming off the LIS focal plane. If, after background removal, the signal for a given pixel exceeds a specified threshold, that pixel is considered to contain a lightning event.

LIS investigations are striving to understand processes related to, and underlying, lightning phenomena in the Earth/atmosphere system. These processes include the amount, distribution, and structure of deep convection on a global scale, and the coupling between atmospheric dynamics and energetics as related to the global distribution of lightning activity. The investigations will contribute to a number of important EOS mission objectives, in-

cluding cloud characterization and hydrologic cycle studies. Lightning activity is closely coupled to storm convection, dynamics, and microphysics, and can be correlated to the global rates, amounts, and distribution of convective precipitation, to the release and transport of latent heat, and to the chemical cycles of carbon, sulfur, and nitrogen. LIS standard products include intensities, times of occurrence, and locations of lightning events.

LIS was launched as part of the Tropical Rainfall Measuring Mission (TRMM) in November 1997. Since that time its performance has exceeded specifications. It has been returning unprecedented data on lightning activity. LIS on the TRMM spacecraft is enabling investigators to quantify relationships between lightning, convection, and ice production. Check the Web site at <http://thunder.msfc.nasa.gov/> for the latest results.

Principal Investigator
Hugh Christian

Hugh Christian is a graduate of the University of Alaska, and received M.S. and Ph.D. degrees in Space Physics and Astronomy from Rice University. He has served in various government, private industry, and academic capacities, primarily within his area of expertise: thunderstorms, atmospheric electricity, lightning data acquisition systems, and airborne instrumentation. Since 1980, Dr. Christian has been a space scientist at the Marshall Space Flight Center.

Co-Investigators

Richard Blakeslee - NASA/Marshall Space Flight Center

Steven J. Goodman - NASA/Marshall Space Flight Center

Douglas M. Mach - University of Alabama

References

Christian, H.J., R.J. Blakeslee, and S.J. Goodman, 1989: The detection of lightning from geostationary orbit. *J. Geophys. Res.*, **94**, 13,329-13,337.

Christian, H.J., R.J. Blakeslee, and S.J. Goodman, 1992: Lightning Imaging Sensor (LIS) for the Earth Observing System. NASA Technical Memorandum 4350, MSFC, Huntsville, AL.

Goodman, S.J., and H.J. Christian, 1993: Global observations of lightning. Atlas of Satellite Observations Related to Global Change, Edited by R. Gurney, J. Foster, and C. Parkinson. Cambridge University Press, New York, 191-219.

LIS Parameters

Storm-scale (5-km) spatial resolution; 2-msec temporal resolution
Spectral filter to image at 0.777 μm onto a 128 x 128 CCD array detector
Event processor to subtract out the bright background during daylight (instrument taking data day and night)
Swath: 600 x 600 km
Spatial resolution: 5 km
Mass: 20 kg
Duty cycle: 100%
Power: 33 W
Data rate: 6 kbps
Thermal control by: Heater, radiator
Thermal operating range: 0 - 40° C
FOV: 80° x 80°
Instrument IFOV: 0.7°
Pointing requirements (platform+instrument, 3 σ):
Control: None
Knowledge: 1 km on ground
Stability: TBD
Jitter: TBD
Physical size:
Sensor head assembly (cylindrical): 20 x 30 cm;
Electronics assembly: 30 x 20 x 30 cm

LIS Data Products

PRODUCT/ COMPONENT NAME	ACCURACY Absolute :: Relative	TEMPORAL Resolution	HORIZONTAL Resolution :: Coverage	Vertical Resolution :: Coverage
Raw Data	:: 2.4×10^{-4}	2 ms	3.5 km :: Global	N/A
Lightning				
Background Images (Level 1-8 Component)	:: 2.4×10^{-4}	2 ms	3.5 km :: Global	N/A
Events (Level 1-8 Component)	:: 7.8×10^{-3}	2 ms	3.5 km :: Global	N/A
Groups (Level 2 Component)	:: 7.8×10^{-3}	2 ms	3.5 km :: Global	N/A
Flashes (Level 2 Component)	:: 7.8×10^{-3}	2 ms	3.5 km :: Global	N/A
Areas (Level 2 Component)	:: 7.8×10^{-3}	2 ms	3.5 km :: Global	N/A
Vector Data (Level 2 Component)	:: 1	1 orbit	500 km :: Global	N/A
Browse Data (Level 3 Component)	:: 1	1 orbit	3.5 km :: Global	N/A
Orbit Stats (Level 3 Component)	:: N/A	1 orbit	3.5 km :: Global	N/A

MISR

Multi-angle Imaging SpectroRadiometer

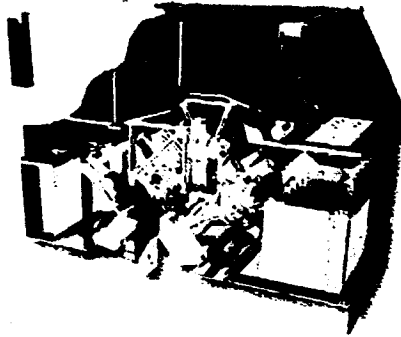

Key MISR Facts

- Selected for flight on Terra
- Heritage: GLL, Wide-Field/Planetary Camera
- Provides top-of-atmosphere, cloud, and surface angular reflectance functions
- Provides global maps of planetary and surface albedo, and aerosol and vegetation properties
- In-house Jet Propulsion Laboratory development
- Phase C/D start January 1991

MISR URL

<http://www-misr.jpl.nasa.gov/>

MISR will routinely provide multiple-angle, continuous sunlight coverage of the Earth with high spatial resolution. The instrument will obtain multidirectional observations of each scene within a time scale of minutes, thereby under virtually the same atmospheric conditions. MISR uses nine individual charge-coupled device (CCD)-based pushbroom cameras to observe the Earth at nine discrete view angles: One at nadir, plus eight other symmetrical views at 26.1, 45.6, 60.0, and 70.5° forward and aftward of nadir. Images at each angle will be obtained in four spectral bands centered at 446, 558, 672, and 866 nm. Each of the 36 instrument data channels (4 spectral bands \times 9 cameras) is individually commandable to provide ground sampling of 275 m, 550 m, or 1.1 km. The swath width of the MISR imaging data is 360 km, providing global multi-angle coverage of the entire Earth in 9 days at the equator, and 2 days at the poles.

The instrument design and calibration strategies have the goal of maintaining absolute radiometric uncertainty to less than $\pm 3\%$ over bright surfaces and $\pm 6\%$ over dark surfaces, with smaller uncertainties in relative band-to-band and angle-to-angle radiances. These objectives will be met through the use of state-of-the-art detector-based calibration, using on a monthly basis an on-board calibrator consisting of deployable solar diffuser panels and an array of radiation-resistant and high-quantum-efficiency diodes. Semi-annual field calibration exercises are planned to provide a ground-truth verification of the diode performance.

MISR images will be acquired in two observing modes: Global and Local. Global Mode provides continuous planet-wide observations, with most channels operating at moderate resolution and selected channels operating at the highest resolution for cloud screening and classification, image navigation, and stereo-photogrammetry. Local Mode provides data at the highest resolution in all spectral bands and all cameras for selected 300 km \times 300 km regions. In addition to data products providing radiometrically calibrated and geo-rectified images, Global Mode data will be used to generate two standard Level 2 science products during ground data processing: the Top-of-Atmosphere (TOA)/Cloud Product and the Aerosol/Surface Product.

The purpose of the TOA/Cloud Product is to enable study, on a global basis, of the effects of different types of cloud fields (classified by their heterogeneity and altitude) on the solar radiance and irradiance reflected to space, and to determine their effects on the Earth's climate. Additionally, this product provides a cloud screen for MISR aerosol and surface retrievals.

The aerosol parameters contained within the Aerosol/Surface Product will enable study, on a global basis, of the magnitude and natural variability in space and time of sunlight absorption and scattering by aerosols in the Earth's atmosphere, particularly in the troposphere, and to determine their effects on climate; to improve our knowledge of the sources, sinks, and global budgets of

natural and anthropogenic aerosols, and to provide atmospheric correction inputs for surface-imaging data acquired by MISR and other instruments (e.g., MODIS and ASTER) that are simultaneously viewing the same portion of the Earth. The surface parameters within the Aerosol/Surface Product are designed to enable improved measures of land-surface characteristics, particularly bidirectional and hemispherical reflectances, leaf area index, surface-cover type, and fractional absorbed photosynthetically active radiation, on a global basis; to provide, in conjunction with MODIS, improved measures of land-surface classification, dynamics, and over vegetated terrain, canopy photosynthesis and transpiration rates; and to supplement MODIS studies of the biogeochemical cycle in the tropics by providing atmospherically corrected ocean color data.

Principal Investigator **David J. Diner**

David J. Diner received a B.S. in Physics with honors from the State University of New York at Stony Brook, and an M.S. and Ph.D. in Planetary Science from the California Institute of Technology. He joined the Jet Propulsion Laboratory as a National Research Council Resident Research Associate in 1978, and is currently an Element Leader in the Earth and Space Sciences Division. He has been involved in numerous NASA planetary and Earth remote-sensing investigations, as Principal and Co-Investigator. He is a member of the American Astronomical Society, Division for Planetary Sciences.

Co-Investigators

Thomas P. Ackerman - *Pacific Northwest National Laboratory*

Carol J. Bruegge - *Jet Propulsion Laboratory*

James E. Conel - *Jet Propulsion Laboratory*

Roger Davies - *University of Arizona*

Siegfried Gerstl - *Los Alamos National Laboratory*

Howard R. Gordon - *University of Miami*

Ralph Kahn - *Jet Propulsion Laboratory*

John V. Martonchik - *Jet Propulsion Laboratory*

Jan-Peter Muller - *University College London*

Ranga Myneni - *Boston University*

Bernard Pinty - *Joint Research Centre*

Piers Sellers - *NASA/Johnson Space Center*

Michel Verstraete - *Joint Research Centre*

References

Diner, D.J., C.J. Bruegge, J.V. Martonchik, G.W. Bothwell, E.D. Danielson, E.L. Floyd, V.G. Ford, L.E. Hovland, K.L. Jones, and M.L. White, 1991: A Multi-angle Imaging SpectroRadiometer for terrestrial remote sensing from the Earth Observing System. *Int. J. Imaging Systems and Technology*, **3**, 92-107.

Diner, D.J., J.C. Beckert, T.H. Reilly, C.J. Bruegge, J.E. Conel, R. Kahn, J.V. Martonchik, T.P. Ackerman, R. Davies, S.A.W. Gerstl, H.R. Gordon, J-P. Muller, R. Myneni, P.J. Sellers, B. Pinty, and M.M. Verstraete, 1998: Multi-angle Imaging SpectroRadiometer (MISR) description and experiment overview. *IEEE Trans. Geosci. Remote Sens.*, **36**, 1072-1087.

MISR Parameters

Nine CCD cameras fixed at nine viewing angles out to 70.5° at the Earth's surface, forward and aftward of nadir, including nadir

Four spectral bands discriminated via filters bonded to the CCDs

Global coverage in 9 days

Swath: 360 km viewed in common by all nine cameras

Spatial sampling: 275 m, 550 m, or 1.1 km, selectable in-flight

Mass: 149 kg

Duty cycle: 50%

Power: 83 W (average), 131 W (peak)

Thermal control by: Passive cooling and active temperature stabilization

Thermal operating range: 0-10° C

FOV: ±60° (along-track) × ±15° (cross-track)

Data rate: 3.3 Mbps (orbit average), 9.0 Mbps (peak)

Pointing requirements (spacecraft):

Control: 150 arcsec

Knowledge: 90 arcsec

Stability: 5 arcsec/1 sec; 14 arcsec/420 sec

Physical size: 0.9 m (W) × 0.9 m (H) × 1.3 m (L)

MISR Data Products

Product Name	Accuracy Absolute :: Relative	Temporal Resolution	Horizontal Resolution :: Coverage	Vertical Resolution :: Coverage
Level 1A Reformatted Annotated Product	3% :: 1% (@ equivalent reflectance of 1.0), 6% :: 2% (@0.05)	1/(2-9 day)	275 m-1.1 km :: Global; 275 m :: Regional	N/A :: Top of Atmosphere
Level 1B1 Radiometric Product	3% :: 1% (@ equivalent reflectance of 1.0), 6% :: 2% (@0.05)	1/(2-9 day)	275 m-1.1 km :: Global; 275 m :: Regional	N/A :: Top of Atmosphere
Level 1B2 Geo-rectified Radiance Product	3% :: 1% (@ equivalent reflectance of 1.0), 6% :: 2% (@0.05)	1/(2-9 day)	275 m-1.1 km :: Global; 275 m :: Regional	N/A :: Top of Atmosphere
Level 2 Top of Atmosphere/Cloud Product	Parameter Dependent	1/(2-9 day)	1.1, 2.2, 17.6, 35.2 km :: Global	N/A :: Troposphere, Top of Atmosphere
Level 2 Aerosol/Surface Product	Parameter Dependent	1/(2-9 day)	1.1, 17.6 :: Global	N/A :: Troposphere, Surface
Level 3 Gridded Radiation Product	Parameter Dependent	1/(9 day, 16 day, month, season, year)	1.1, 2.2, 17.6, 35.2 km :: Global	N/A :: Surface, Top of Atmosphere
Level 3 Gridded Cloud Product	Parameter Dependent	1/(9 day, 16 day, month, season, year)	1.1, 2.2, 17.6, 35.2 km :: Global	N/A :: Troposphere
Level 3 Gridded Aerosol Product	Parameter Dependent	1/(9 day, 16 day month, season, year)	17.6 km :: Global	N/A :: Troposphere
Level 3 Gridded Surface Product	Parameter Dependent	1/month	1.1 km :: Global	N/A :: Surface
Level 1B2 Ancillary Geographic Product	Parameter Dependent	Updated infrequently	1.1 km :: Global	N/A :: Surface
Level 1B2 Ancillary Radiometric Product	Parameter Dependent	Updated 1/month	N/A :: N/A	N/A :: N/A
Level 2 Aerosol Climatology Product	Parameter Dependent	Updated infrequently	N/A :: N/A	N/A :: Atmosphere

MLS

Microwave Limb Sounder



Key MLS Facts

Selected for flight on EOS CHEM

Heritage: UARS MLS

Passive microwave limb-sounding radiometer/
spectrometer

Measures thermal emission from the atmospheric
limb

Spectral bands at millimeter and submillimeter
wavelengths

Provides reliable measurements even in presence
of cirrus and dense volcanic aerosols

In-house JPL development with subsystems from
industry

MLS URL

<http://mls.jpl.nasa.gov>

The scientific priorities and objectives of the MLS investigation are to improve understanding of the following processes and parameters vital to global change research and environmental policy:

- *Chemistry of the lower stratosphere and upper troposphere* – MLS measures lower stratospheric temperature and concentrations of H₂O, O₃, ClO, BrO, HCl, OH, HO₂, HNO₃, HCN, and N₂O, for their effects on (and diagnoses of) ozone depletion, transformations of greenhouse gases, and radiative forcing of climate change. These measurements will be especially valuable for diagnosing the potential for severe loss of Arctic ozone during the critical period following the turn of the century when abundances of stratospheric chlorine will still be high, and slight cooling of the stratosphere could exacerbate ozone loss due to chlorine chemistry. The measurements will help determine whether the stratosphere is responding as expected to the effects of the Montreal Protocol agreements for phasing out ozone-depleting substances. MLS also measures upper tropospheric H₂O, O₃, CO, and HCN for their effects on radiative forcing of climate change and for diagnoses of exchange between the troposphere and stratosphere.
- *Chemistry of the middle and upper stratosphere* – MLS observes the details of ozone chemistry by measuring many radicals, reservoirs, and source gases in chemical cycles which destroy ozone. This set of measurements will provide stringent tests on understanding of global stratospheric chemistry, will help explain observed trends in ozone, and can provide early warnings of any changes in the chemistry of this region.
- *Water in the upper troposphere* – the Upper Atmosphere Research Satellite (UARS) has demonstrated the MLS capability of measuring upper tropospheric water vapor profiles, knowledge of which is essential for understanding climate variability and global warming but which previously has been extremely difficult to observe reliably on a global scale. MLS is unique in its ability to provide these measurements in the presence of dense tropical cirrus, where important processes affecting climate variability occur. MLS also provides unique measurements of cirrus ice content. The simultaneous MLS measurements of upper tropospheric water vapor, ice content, and temperature, under all conditions and with good vertical resolution, will be of great value for improving our understanding of processes (such as El Niño) affecting the distribution of atmospheric water, climate variability, and tropospheric-stratospheric exchange. The simultaneous measurements of dynamical tracers CO and N₂O enhance the value of this data set by helping identify source regions of the air masses being observed.

- *The effect of volcanoes on global change* – MLS measures SO₂, and other gases mentioned above, in volcanic plumes to investigate the effects of volcanic injections into the atmosphere.

EOS MLS objectives address three priority science areas of the U.S. Global Change Research Program:

1. Changes in ozone, UV radiation, and atmospheric chemistry;
2. decade-to-century climate change; and
3. seasonal-to-interannual climate variability.

EOS MLS continues the successful effort started on UARS MLS, and uses advanced technology to provide important new measurements. Particularly noteworthy in this regard are its capabilities for OH, HO₂, and BrO; measurements of these species have never before been possible on a global scale, but are essential for a comprehensive understanding of stratospheric chemistry. The instrument observes in spectral bands centered near the following frequencies:

- 118 GHz, primarily for temperature and pressure;
- 190 GHz, primarily for H₂O, HNO₃, and continuity with UARS MLS measurements;
- 240 GHz, primarily for O₃ and CO;
- 640 GHz, primarily for N₂O, HCl, ClO, HOCl, BrO, HO₂, and SO₂; and
- 2.5 THz, primarily for OH.

Principal Investigator

Joe W. Waters

Dr. Waters has led the development of microwave limb sounding since its inception in 1974. His Ph.D. from MIT focused on microwave sensing of the upper atmosphere. He has been at JPL since 1973, where he is currently a senior research scientist and leader of Microwave Atmospheric Science and Upper Atmosphere Microwave Experiment Development groups. Dr. Waters is author of more than 100 peer-reviewed scientific publications, most of which are on atmospheric measurements with microwave techniques, and has twice received the NASA Medal for Exceptional Scientific Achievement.

Co-Investigators

The following are from the University of Edinburgh:

Mark J. Filipiak
Robert S. Harwood
Hugh C. Pumphrey

The following are from the Jet Propulsion Laboratory:

Richard E. Cofield
Lucien Froidevaux
Robert F. Jarnot
Nathaniel J. Livesey
Herbert M. Pickett
William G. Read
Michelle L. Santee
Peter H. Siegel
Dong L. Wu

References

Froidevaux, L., et al., 1996: Validation of UARS Microwave Limb Sounder ozone measurements. *J. Geophys. Res.*, **101**, 10,017-10,060.

Jarnot, R.F., et al., 1996: Calibration of the Microwave Limb Sounder on the Upper Atmosphere Research Satellite. *J. Geophys. Res.*, **101**, 9957-9982.

Manney, G.L., et al., 1994: Chemical depletion of ozone in the Arctic Lower Stratosphere during winter 1992-1993. *Nature*, **370**, 429-434.

MLS Parameters

Spectral bands: At millimeter and submillimeter wavelengths.

Spatial resolution: Measurements are performed along the suborbital track, and resolution varies for different parameters; 5 km cross-track × 500 km along-track × 3 km vertical are typical values.

Mass: 430 kg

Duty cycle: 100%

Power: 530 W full-on; 460 W time-shared

Data rate: 100 kbps

Thermal control: Via radiators and louvers to space as well as heaters

Thermal operating range: 10 to 35° C

FOV: Boresight 60-70° relative to nadir

Instantaneous field-of-view at 640 GHz: 1.5 km vertical × 3 km cross-track × 300 km along-track at the limb tangent point

Pointing requirements (platform+instrument, 3 σ):

Control: 36 arcsec

Knowledge: 1 arcsec per second

Stability: 72 arcsec per 30 seconds

Jitter: 2.7 arcsec per 1/6 second

Size: 1.5 × 1.9 × 1.8 m (GHz sensor);

0.8 × 1 × 1.1 m (THz sensor);

1.6 × 0.5 × 0.3 m (spectrometer)

Morrey, M.W., and R.S. Harwood, 1998: Interhemispheric differences in stratospheric water vapour during late winter, in version 4 MLS measurements. *Geophys. Res. Lett.*, **25**, 147-150.

Newell, R.E., et al., 1997: Relationship between tropical upper tropospheric moisture and eastern tropical Pacific sea surface temperature. *Geophys. Res. Lett.*, **24**, 25-28.

Pumphrey, H.C., 1998: Nonlinear retrievals of water vapour from the UARS Microwave Limb Sounder (MLS). *Adv. Space Res.*, **21**, 389-392.

Read, W.G., et al., 1993: Microwave Limb Sounder (MLS) measurements of SO₂ from Mt. Pinatubo volcano. *Geophys. Res. Lett.*, **20**, 1299-1302.

Read, W.G., et al., 1995: Upper tropospheric water vapor from UARS MLS. *Bull. Amer. Met. Soc.*, **76**, 2381-2389.

Sandor, B.J., et al., 1998: Seasonal behavior of tropical to mid-latitude upper tropospheric water vapor from UARS MLS. *J. Geophys. Res.*, **103**, 25,935-25,947.

Santee, M.L., et al., 1995: Interhemispheric differences in HNO₃, H₂O, ClO and O₃. *Science*, **267**, 849-852.

Waters, J.W., et al., 1993: Stratospheric ClO and Ozone from the Microwave Limb Sounder on the Upper Atmosphere Research Satellite. *Nature*, **362**, 597-602.

Waters, J.W., et al., 1999: The UARS and EOS Microwave Limb Sounder (MLS) Experiments. *J. Atmos. Sci.*, **56**, 194-218.

Wu, D.L., 1998: Equatorial diurnal Variations observed in UARS MLS temperature during 1991-1994 and simulated by the Canadian Middle Atmosphere Model. *J. Geophys. Res.*, **103**, 8909-8917.

MLS Data Products

Product Name	Accuracy	Temporal Resolution	Horizontal	Vertical
	Absolute :: Relative		Resolution :: Coverage	Resolution :: Coverage
MLS radiances	absolute accuracy is 2K or better; precision varies, with -0.01K achieved on long-term averages	2/day (d,n)	500 km :: global	0.1-1 km :: 0-120 km
temperature	1-2K :: 0.3-1K (5-40 km)	daily global map	500 km :: global	3 km :: 5-120 km
geopotential height	30-100 m :: 10-30 m (10-50 km)	daily global map	500 km :: global	3 km :: 5-120 km
cirrus ice content	5-10% :: 0.005 g/m ³	monthly global map	200 km :: global	3 km :: 10-20 km
H ₂ O concentration	3-5% :: 2-10% (5-50 km)	daily global map	500 km :: global	3 km :: 5-100 km
N ₂ O concentration	3-5% :: 0.02-0.05 ppmv (10-45 km)	daily global map	500 km :: global	3 km :: 10-60 km
CO concentration	3-5% :: 8-20 ppbv (8-30 km)	monthly global map	500 km :: global	3 km :: 8-100 km
O ₃ conc. (strat)	3-5% :: 0.5-10% (15-50 km)	daily global map	500 km :: global	3 km :: 15-100 km
O ₃ conc. (trop)	3-5% :: 2-10 ppbv (8-15 km)	monthly global map	500 km :: global	3 km :: 8-15 km
OH conc. (lower strat)	3-10% :: 0.2-0.5 pptv (18-35 km)	monthly zonal mean	500 km :: global	3 km :: 18-30 km
OH conc. (upper strat)	3-10% :: ~10% (35-60 km)	daily global map	500 km :: global	3 km :: 30-80 km
HO ₂ concentration	3-10% :: 5-50 pptv (20-50 km)	monthly zonal mean	500 km :: global	3 km :: 20-60 km
BrO concentration	3-10% :: 3-6 pptv (20-40 km)	monthly zonal mean	500 km :: global	5 km :: 20-40 km
ClO concentration	3-5% :: 0.1-0.5 ppbv (15-45 km)	daily global map	500 km :: global	3 km :: 15-60 km
HCl concentration	3-5% :: 0.06-1 ppbv (10-55 km)	daily global map	500 km :: global	3 km :: 10-100 km
HOCl concentration	3-10% :: 0.01-0.1 ppbv (20-50 km)	monthly zonal mean	500 km :: global	3 km :: 20-50 km
HNO ₃ concentration	3-5% :: 2-5 ppbv (10-30 km)	daily global map	500 km :: global	3 km :: 10-60 km
HCN concentration	3-10% :: 0.05-0.2 ppbv (8-40 km)	daily zonal mean	500 km :: global	5 km :: 8-50 km
SO ₂ concentration	3-10% :: 2 ppbv (10-40 km)	daily global map	500 km :: global	3 km :: 10-40 km

NOTE: MLS measurements are made only along suborbital track. A vertical profile is obtained every 1.5 degrees great circle (165 km) along the track, and data products above are retrieved routinely with standard data processing software and archived with this full resolution. The resolutions and accuracies given here are for the products produced from these data which are likely to have the most widespread scientific use. Global maps have approximately 5 degrees latitude resolution and 10-20 degrees longitude resolution at mid-latitudes. There are trade-offs between resolution and precision: useful upper tropospheric water vapor measurements, for example, are expected to be obtained with approximately 1-km vertical resolution, and ClO monthly zonal means will have approximately 0.01 pptv precision. Values for accuracy and precision given here are current estimates and may be refined with further study. The height ranges in parentheses in column two are those over which the precisions stated there apply and are the primary height range of interest; measurements are, however, obtained over the full vertical range stated in the righthand column. Some time-sharing of MLS measurements may be required because of spacecraft power limitations. The SO₂ maps will likely be useful only after volcanic eruptions.

MODIS

Moderate-Resolution Imaging Spectroradiometer

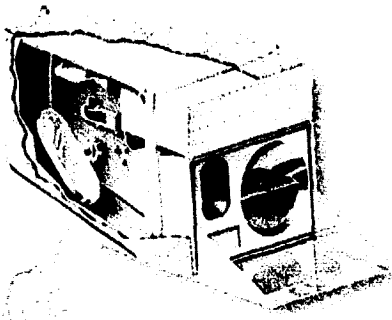

Key MODIS Facts

Selected for flight on Terra and EOS PM

Heritage: AVHRR, HIRS, LANDSAT TM, and
Nimbus-7 CZCS

Medium-resolution, multi-spectral, cross-track
scanning radiometer

Measures biological and physical processes

Launch in 1999

Prime Contractor: Raytheon Santa Barbara Remote
Sensing

Responsible Center: NASA/Goddard Space Flight
Center

MODIS URL

<http://ftpwww.gsfc.nasa.gov/MODIS/MODIS.html>

MODIS is an EOS facility instrument designed to measure biological and physical processes on a global basis every 1-to-2 days. Slated for both the Terra and EOS PM satellites, the instrument will provide long-term observations from which an enhanced knowledge of global dynamics and processes occurring on the surface of the Earth and in the lower atmosphere can be derived. This multidisciplinary instrument will yield simultaneous, congruent observations of high-priority atmospheric (aerosol and cloud properties, water vapor and temperature profiles), oceanic (sea-surface temperature and chlorophyll), and land-surface features (land-cover changes, land-surface temperature, snow cover, and vegetation properties). The instrument is expected to make major contributions to understanding the global Earth system, including interactions among land, ocean, and atmospheric processes.

The MODIS instrument employs a conventional imaging spectroradiometer concept, consisting of a cross-track scan mirror and collecting optics, and a set of linear arrays with spectral interference filters located in four focal planes. The optical arrangement will provide imagery in 36 discrete bands between 0.4 and 14.5 μm selected for diagnostic significance in Earth science. The spectral bands will have spatial resolutions of 250, 500, or 1,000 m at nadir. Signal-to-noise ratios are greater than 500 at 1-km resolution (at a solar zenith angle of 70°), and absolute irradiance accuracies are $< \pm 5\%$ from 0.4 to 3 μm (2% relative to the sun) and 1 percent or better in the thermal infrared (3.7 to 14.5 μm). MODIS instruments will provide daylight reflection and day/night emission spectral imaging of any point on the Earth at least every 2 days, operating continuously. MODIS will provide specific global data products, which include the following:

- Surface temperature with 1-km resolution, day and night, with absolute accuracy of 0.3 K-0.5 K for oceans and 1 K for land;
- water-leaving radiance to within 0.2 percent from 415 to 653 nm;
- chlorophyll fluorescence within 50 percent at surface concentrations of 0.5 mg m^{-3} ;
- concentration of chlorophyll-a within 35 percent, net ocean primary productivity, other optical properties;
- vegetation/land-surface cover, conditions, and productivity:
 - Net primary productivity, leaf area index, and intercepted photosynthetically active radiation

- land cover type, with change detection and identification;
- vegetation indices corrected for atmosphere, soil, and directional effects; and
- snow cover and reflectance;
- cloud mask containing confidence of clear sky (or, alternatively, the probability of cloud), shadow, fire, and heavy aerosol at 1-km resolution;
- cloud properties characterized by cloud phase, optical thickness, droplet size, cloud-top pressure, and temperature;
- aerosol properties defined as optical thickness, particle size, and mass loading;
- fire occurrence, temperature, and burn scars;
- global distribution of total precipitable water; and
- cirrus cloud cover

MODIS will fly on both the Terra and EOS PM satellites to maximize cloud-free remote sensing of the Earth's surface and to exploit synergism with other EOS sensors.

Team Leader

Vincent V. Salomonson

Dr. Salomonson brings substantial experience to his role as Team Leader of MODIS. He has functioned as the MODIS Team Leader for the past 11 years. He also served for 12 years as the Landsat 4 and 5 Project Scientist, including leadership and management of the Landsat Image Data Quality and Analysis (LIDQA) Investigator Team and Thematic Mapper Research in the Earth Sciences Investigator Team. Additional experience includes over 25 years as a line manager of research groups at Goddard Space Flight Center and leadership of the NASA Water Resources Subdiscipline Panel and Program for several years in the 1970s. He has published research materials directly relevant to the investigation, and has over 120 refereed publications, conference proceedings, and NASA reports to his credit.

Cited on numerous occasions for his outstanding research and scientific achievement, Dr. Salomonson is the recipient of several NASA awards for exceptional scientific achievement, service, and performance; the Distinguished Achievement Award of the IEEE Geoscience and

Remote Sensing Society; the William T. Pecora Award; and the Distinguished Alumnus Award from Colorado State University. In addition to his present duties as Director of Earth Sciences at Goddard, he served as President of the American Society for Photogrammetry and Remote Sensing (ASPRS) in 1992. He was made a Fellow of ASPRS in 1994, and was elected a Fellow of IEEE in 1998.

Science Team Members

Mark R. Abbott - *Oregon State University*

William L. Barnes - *NASA/Goddard Space Flight Center*

Ian Barton - *Commonwealth Scientific and Industrial Research Organization, Australia*

Otis B. Brown - *University of Miami*

Janet W. Campbell - *University of New Hampshire*

Kendall L. Carder - *University of South Florida*

Dennis K. Clark - *NOAA/National Environmental Satellite, Data, and Information Service*

Wayne Esaias - *NASA/Goddard Space Flight Center*

Robert H. Evans - *University of Miami*

Bo-Cai Gao - *Naval Research Laboratory*

Howard R. Gordon - *University of Miami*

Frank E. Hoge - *Wallops Flight Facility*

Alfredo R. Huete - *University of Arizona*

Christopher O. Justice - *University of Virginia*

Yoram J. Kaufman - *NASA/Goddard Space Flight Center*

Michael D. King - *NASA/Goddard Space Flight Center*

W. Paul Menzel - *NOAA/NESDIS, University of Wisconsin-Madison*

Jan-Peter Muller - *University College London*

Ranga B. Myneni - *Boston University*

John Parslow - *Commonwealth Scientific and Industrial Research Organization, Australia*

Steven W. Running - *University of Montana*

Kurtis Thome - *University of Arizona*

Alan H. Strahler - *Boston University*

Didier Tanré - *Centre National d'Etudes Spatiales/Laboratoire d'Optique Atmosphérique, France*

John R.G. Townshend - *University of Maryland*

Eric Vermote - *University of Maryland*

Zhengming Wan - *University of California-Santa Barbara*

References

Barnes, W.L., T.S. Pagano, and V. Salomonson, 1998: Prelaunch characteristics of the Moderate Resolution Imaging Spectroradiometer (MODIS) on EOS AM-1. *IEEE Trans. Geosci. Remote Sens.*, **36**, 1088-1100.

Esaias, W., M. Abbott, O. Brown, J. Campbell, K. Carder, D. Clark, R. Evans, F. Hoge, H. Gordon, W. Balch, R. Letelier, and P. Minnett: 1998: An overview of MODIS capabilities for ocean science observations. *IEEE Trans. Geosci. Remote Sens.*, **36**, 1250-1265.

Guenther, B., G.D. Godden, X. Xiong, E.J. Knight, S. Qiu, H. Montgomery, M.M. Hopkins, M.G. Khayat, and Z. Hao, 1998: Pre-launch algorithm and data format for the Level 1 calibration products for the EOS AM-1 Moderate Resolution Imaging Spectroradiometer (MODIS). *IEEE Trans. Geosci. Remote Sens.*, **36**, 1142.

Justice, C., E. Vermote, J. Townshend, R. Defries, D. Roy, D. Hall, V. Salomonson, J. Privette, G. Riggs, A. Strahler, W. Lucht, R. Myneni, Y. Knjazihhin, S. Running, R. Nemani, Z. Wan, A. Huete, W. van Leeuwen, R. Wolfe, L. Giglio, J. Muller, P. Lewis, and M. Barnsley, 1998: The Moderate Resolution Imaging Spectroradiometer (MODIS): Land remote sensing for global change research. *IEEE Trans. Geosci. Remote Sens.*, **36**, 1228-1249.

King, M.D., Y. Kaufman, W. Menzel, and D. Tanré, 1992: Remote sensing of cloud, aerosol, and water vapor properties from the Moderate Resolution Imaging Spectrometer (MODIS). *IEEE Trans. Geosci. Remote Sens.*, **30**, 2-27.

Masuoka, E., A. Fleig, R. Wolfe, and F. Patt, 1998: Key characteristics of MODIS data products. *IEEE Trans. Geosci. Remote Sens.*, **36**, 1313-1323.

MODIS Parameters

36 spectral bands—21 within 0.4-3.0 μm ; 15 within 3-14.5 μm

Continuous global coverage every 1 to 2 days

Polarization sensitivity: 2% from 0.43 μm to 2.2 μm and $\pm 45^\circ$ scan

Signal-to-noise ratios from 900 to 1300 for 1-km ocean color bands at 70° solar zenith angle

NEDT's typically < 0.05 K at 300 K

Absolute irradiance accuracy of 5% for < 3 μm and 1% for > 3 μm

Daylight reflection and day/night emission spectral imaging

Swath: 2,300 km at 110° ($\pm 55^\circ$) from 705-km altitude

Mass: 229 kg

Duty cycle: 100%

Power: 162.5 W (average), 225 W (peak)

Data rate: 6.2 Mbps (average), 10.5 Mbps (day), 3.2 Mbps (night)

Thermal control by: Radiators

Thermal operating range: 268 K \pm 5 K

Instrument IFOV: 250 m (2 bands), 500 m (5 bands), 1,000 m (29 bands)

Pointing requirements (platform+instrument, 3σ):

Control: 3,600 arcsec

Knowledge: 141 arcsec

Stability: 28 arcsec/sec

Jitter: 1.031 arcsec/sec (yaw and roll), 47 arcsec/sec (pitch)

Physical size: 1.044 \times 1.184 \times 1.638 m

MODIS Data Products

Product Name	Accuracy Absolute :: Relative	Temporal Resolution	Horizontal Resolution :: Coverage	Vertical Resolution :: Coverage
Level -1A Radiance	N/A	1 - 2/day*	0.25, 0.5, 1 km :: Global	N/A
Level-1B Radiance, Calibrated Geolocated	5% (1σ) ::	1 - 2/day*	0.25, 0.5, 1 km :: Global	N/A :: N/A
Aerosol Product	<0.05	1/day	10 km	N/A :: Atmosphere
Cloud Product —Cloud Top Temperature —Optical Thickness & Effective Radius	2 - 5 K :: 10% ::	1/day	1 km :: Global	N/A :: Cloud
Surface Reflectance	0.03 ::	1 - 9/day	0.25, 0.5, 1 km :: Land	N/A :: Surface
Snow Cover	<10% ::	1/day	1 km :: Land	N/A :: Surface
Land-surface Temperature/ Emissivity	1 K :: 0.02 ::	1/day, 1/week, 1/month	1 km :: Land/Regional	N/A :: Surface
Land-cover Type	N/A	1/(3 months)	1 km :: Land	N/A :: Surface
Chlorophyll-a Pigment Concentration	35%	1/day, 1/week, 1/month	1 km :: Ocean Regional, Local	N/A
Chlorophyll Fluorescence	0.017 W m ⁻² sr ⁻¹ μm ⁻¹ at 1 km	1/day, 1/week, 1/month	1, 5 km :: Ocean	N/A :: Surface
Water-leaving Radiance	0.002 ::	1/day, 1/week, 1/month	1 km :: Local	N/A :: Surface
Instantaneous PAR	5 - 10% ::	1/day	1 km :: Ocean/Global	N/A :: Surface, Atmosphere
Sea Surface Temperature (SST)	0.3 - 0.5 K ::	1/day, 1/week, 1/month	1 km :: Ocean/Local	N/A :: Surface
Cloud Mask	N/A	1 - 2/day	0.25, 1 km :: Global	N/A :: Cloud

*Thermal bands 2/day; VIS/NIR/SWIR bands 1/day.

MOPITT

Measurements Of Pollution In The Troposphere

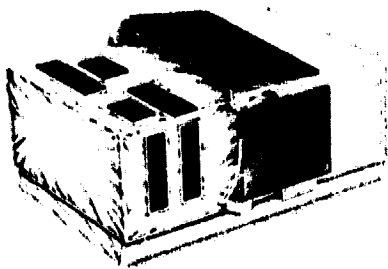

Key MOPITT Facts

Selected for flight on Terra

Heritage: Pressure-modulated cell elements used in the PMR, SAMS, and ISAMS instruments, using similar correlation spectroscopy techniques

Four-channel correlation spectrometer with cross-track scanning

Flight on EOS AM-2 to be confirmed

Canadian Space Agency to provide the instrument

Prime Contractor: COM DEV

MOPITT URL

University of Toronto:

<http://www.atmosp.physics.utoronto.ca/MOPITT/home.html>

The MOPITT experiment is provided under a Memorandum of Understanding with the Canadian Space Agency (CSA). MOPITT will measure emitted and reflected infrared radiance in the atmospheric column which, when analyzed, permits retrieval of tropospheric CO profiles and total column CH₄.

Both CO and CH₄ are produced by biomass systems, oceans, and human activities. CO is intimately connected with the OH chemical cycle in the troposphere, and moves both vertically and horizontally within the troposphere. CH₄ is a greenhouse gas and is increasing on an annual basis. MOPITT measurements will allow studies of the global and temporal distributions that drive budget and source/sink studies. Since human activities have a significant influence on both CO and CH₄ concentrations, a better understanding of the role of these constituents is essential in understanding anthropogenic effects on the environment.

MOPITT operates on the principle of correlation spectroscopy, i.e., spectral selection of radiation emission or absorption by a gas, using a sample of the same gas as a filter. The instrument modulates sample gas density by changing the length or the pressure of the gas sample in the optical path of the instrument. This modulation changes the absorption profile in the spectral lines of the gas in the cell as observed by a detector. The modulated gas sample acts as an optical filter which selectively picks out the parts of the atmospheric absorption lines of that gas in the atmosphere. The detector thus observes a signal highly correlated with the abundance of the sample gas in the atmosphere.

Atmospheric sounding and column CO are mapped by using thermal and reflected solar channels in the regions of 4.7 and 2.3 μm , respectively. Column CO and CH₄ are measured using solar channels viewed through modulation cells to sense solar radiation reflected from the surface. The solar channels are duplicated in the instrument at different correlation cell pressures, to allow a failure in one channel without compromising the column measurement.

MOPITT is designed as a scanning instrument. The field of 4 pixels, aligned along the direction of motion, and each 1.8 degrees (or 22 km) on a side, is scanned through a cross-track scan angle of 26.1 degrees, or 29 pixels, to give a swath width of 640 km. This swath leaves gaps in coverage between successive orbits using the nominal 705-km altitude and 98.2° inclination orbit.

MOPITT data products will include total column retrievals of CH₄ with a horizontal resolution of 22 km and a precision of 1 percent. CO soundings will be retrieved with 10% accuracy provided by three independent pieces of information, and represented by values on 7 pressure levels between 0 and 14 km. These soundings will be taken at laterally scanned sampled locations with 22-km horizontal resolution. Column CO abundance will be retrieved

with 22-km horizontal resolution. Scientific studies will employ these data to derive three-dimensional global maps as part of an effort to model global tropospheric chemistry.

Principal Investigator
James Drummond

James Drummond studied at Oxford University where he obtained his B.Sc. and D.Phil. degrees in Physics. He has taught in the Physics Department at the University of Toronto since 1979, as a Full Professor since 1992, and as a holder of an Industrial Research Chair in Atmospheric Remote Sounding from Space since 1996.

His major research interests are in the field of atmospheric remote-sounding measurements, modeling and molecular spectroscopy. He has participated in many balloon, aircraft, and spacecraft experiments over nearly 30 years of his career, and is currently involved in several such programs as well as running an extensive laboratory program in line-shape measurements and instrument development.

Co-Investigators

Guy Brasseur - *National Center for Atmospheric Research*

G.R. Davis - *University of Saskatchewan, Canada*

John C. Gille - *National Center for Atmospheric Research*

Gurpreet S. Mand - *University of Toronto*

Jack McConnell - *York University, Canada*

Guy Peskett - *Oxford University, United Kingdom*

Henry G. Reichle - *North Carolina State University*

N. Roulet - *McGill University, Canada*

References

Drummond, J.R., 1992: Measurements of Pollution in the Troposphere (MOPITT). The Use of EOS for Studies of Atmospheric Physics, J. Gille and G. Visconti, Eds., North Holland, 77-101.

Drummond, J.R., and G.S. Mand, 1996: The Measurements of Pollution in the Troposphere (MOPITT) instrument: Overall performance and calibration requirements. *J. Atmos. Ocean. Tech.*, **13**, 314-320.

Pan, L., D. Edwards, J.C. Gille, M.W. Smith, and J.R. Drummond, 1995: Satellite remote sensing of tropospheric CO and CH₄. *Appl. Opt.*, **34**, 6976.

Pan, L., J.C. Gille, D.P. Edwards, P.L. Bailey, and C.D. Rodgers, 1998: Retrieval of tropospheric carbon monoxide for the MOPITT experiment. *J. Geophys. Res.*, **103**, 32,277-32,290.

Wang, J., J. Gille, P.L. Bailey, J.R. Drummond, and L. Pan, 1999: Instrument sensitivity and error analysis for the remote sensing of tropospheric carbon monoxide by MOPITT. *J. Atmos. Ocean. Tech.*, **16**, 465-474.

MOPITT Parameters

Correlation spectroscopy utilizing both pressure- and length-modulated gas cells, with detectors at 2.3, 2.4, and 4.7 μm

Uses pressure modulation and length modulation to obtain CO concentrations with three independent pieces of information represented by values on seven pressure levels, as well as CO and CH₄ columns

CO concentration accuracy is 10%

CH₄ column abundance accuracy is 1%

Swath: 640 km (29 fields of view)

Spatial resolution (each pixel): 22 × 22 km

Mass: 192 kg

Power: 250 W (average), 260 W (peak)

Duty cycle: 100%

Data rate: 28 kbps

Thermal control by: 80 K Stirling cycle cooler, capillary pumped coldplate and passive radiation

Thermal operating range: 25° C (instrument), 100 K (detectors)

Instrument IFOV: 22 km across track × 88 km along track (1.8° × 7.2° - 4 pixels)

Pointing requirements (platform+instrument, 3 σ):

Control: 500 arcsec

Knowledge: 300 arcsec

Stability: 322 arcsec/12.47 sec

Physical size: 115 × 93 × 57 cm (stowed),
115 × 105 × 71 cm (deployed)

MOPITT Data Products

Product Name	Accuracy Absolute :: Relative	Temporal Resolution	Horizontal Resolution :: Coverage	Vertical Resolution :: Coverage
Level-1B Radiance (= Ancillary Data including CR pressure)		1 view/0.4 seconds	22 km :: Global	:: Atmosphere
CH ₄ Column (Total Burden)	1% :: 1%*	1 view/0.4 seconds	22 km :: Global	Column :: Atmosphere
CO Profiles	10% :: 10%	1 view/0.4 seconds	22 km :: Global	4 km :: 0 - 15 km
CO Column (Total Burden)	10% :: 10%	1 view/0.4 seconds	22 km :: Global	Column :: Atmosphere

* Limited by knowledge of spectroscopic parameters; requires post-launch verification

OMI

Ozone Monitoring Instrument

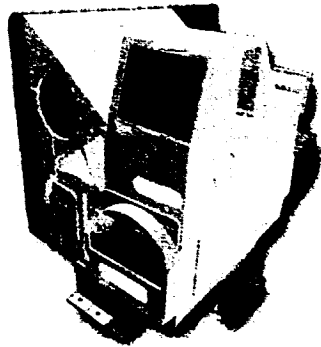

Key OMI Facts

A Netherlands contribution to EOS CHEM in collaboration with Finland

Heritage: TOMS, SBUV, GOME, SCIAMACHY, GOMOS

Nadir-viewing wide-field-imaging spectrometer

Daily global coverage

Continues TOMS data record for total ozone, aerosols, UVB, and SO₂

Enhanced mapping capability for ozone profiles, NO₂, BrO, and OCIO columns, cloud pressure and coverage

13 km × 24 km nominal IFOV

Capable of mapping pollution products on urban-to-super-regional scales.

Prime Contractor: Fokker Space (Netherlands)

Contributing Contractors: TNO-TPD (Netherlands), Patria Finavitec (Finland), VTT (Finland)

OMI is a contribution of the Netherlands agency for aerospace programs (NIVR) in collaboration with Finland to the EOS CHEM mission. It will continue the TOMS record for total ozone and other atmospheric parameters related to ozone chemistry and climate. OMI measurements will be highly synergistic with the other instruments on the EOS CHEM platform. The OMI instrument employs hyperspectral imaging in a push-broom mode to observe solar backscatter radiation in the visible and ultraviolet. The Earth will be viewed in 740 wavelength bands along the satellite track with a swath large enough to provide global coverage in 14 orbits (1 day). The nominal 13 × 24 km spatial resolution can be zoomed to 13 × 13 km for detecting and tracking urban-scale pollution sources. The hyperspectral capabilities will improve the accuracy and precision of the total ozone amounts. The hyperspectral capabilities will also allow for accurate radiometric and wavelength self calibration over the long term. The expanded wavelength characteristics will provide the following features.

- Continue global total ozone trends from satellite measurements beginning in 1970 with BUUV on Nimbus-4.
- Map ozone profiles at 36 × 48 km, a spatial resolution never achieved before.
- Measure key air quality components such as NO₂, SO₂, BrO, OCLO, and aerosol characteristics.
- Distinguish between aerosol types, such as smoke, dust, and sulfates.
- Measure cloud pressure and coverage, which provide data to derive tropospheric ozone.
- Map global distribution and trends in UV-B radiation.
- A combination of algorithms including TOMS version 7, Differential Optical Absorption Spectroscopy (DOAS), Hyperspectral BUUV Retrievals and forward modeling will be used together to extract the various OMI data products.

Science Team

The OMI international science team will be led by the principal investigator from the Netherlands, in collaboration with the co-investigator and science team leader from Finland and the United States. The team will have the responsibility for developing algorithms, calibration, data processing, validation, and analysis. The international team draws experience from TOMS, SBUV, GOME on ERS-2, SCIAMACHY and GOMOS flying on Envisat.

**Principal Investigator
Pieternel Levelt**

Pieternel Levelt is with the Royal Dutch Meteorological Institute's (KNMI) Atmospheric Composition section, which has a research program that includes an analysis of ground based and satellite data and chemical-transport models. Dr. Levelt has conducted research on the use of ozone data in data assimilation models and has participated in GOME data validation and the planning for SCIAMACHY validation.

**Co-Investigator
Gilbert W. Leppelmeier**

Gilbert W. Leppelmeier is Research Professor at Finnish Meteorological Institute's (FMI) Geophysical Research center. FMI has overall responsibility for weather and climate, air quality, and geophysics in Finland. The center conducts planetary, geomagnetic, aeronomic, and space plasma physics research. The Geophysical Research center develops sensor technology for interplanetary missions. Dr. Leppelmeier is also a co-investigator on the GOMOS instrument.

U.S. Science Team

The U.S. Science Team consists of the EOS CHEM Project Scientist and team members who will be selected through a NASA Research Announcement in 1999. The team leader will be responsible for developing the EOSDIS TOMS-based standard data products with enhancements employing OMI's hyperspectral capabilities. The team leader will also be responsible for integrating algorithms for producing other OMI data products for archiving in the DAAC.

OMI Parameters

The instrument observes Earth's backscattered radiation with a wide-field telescope feeding two imaging grating spectrometers, with each spectrometer employing a CCD detector

Onboard calibration includes a white light source, LEDs, and a multi-surface solar-calibration diffuser; a depolarizer removes the polarization from the backscattered radiation

Wavelength

Visible: 350 to 500 nm

UV: UV-1, 270 to 314 nm, UV-2 306 to 380 nm

Spectral resolution: 1.0-0.45 nm FWHM

Spectral sampling: 2-3 for FWHM

Telescope FOV: 114° (2600 km on ground)

IFOV: 3 km, binned to 13 x 24 km

Detector: CCD: 780 x 576 (spectral x spatial) pixels

Mass: 65 kg

Power: 66 W

Data rate: 0.8 Mbps (average)

Duty cycle: 60 minutes on daylight side

Pointing requirements (arcseconds)

(Platform+instrument, pitch:roll:yaw, 3 σ):

Accuracy: 866:866:866

Knowledge: 87:87:87

Stability (6 sec): 87:87:87

Physical Size: 50 x 40 x 35 cm

OMI Data Products

Product Name	Accuracy Absolute:Relative	Temporal Resolution	Horizontal Resolution:Coverage	Vertical Resolution:coverage
Radiance	<5% :: <1%	1 view/2 sec	13 x 24 km :: Global, daylight	N/A
Total Ozone	5% :: 2%	1 view/2 sec	13 x 24 km :: Global, daylight	Column
Ozone Profile	15% :: 8%	1 view/4 sec	36 x 48 km :: Global, daylight	8 km :: 0-60 km
UV-B	10% :: 10%	1 view/2 sec	13 x 24 km :: Global, daylight	N/A
Aerosol Index	0.1 (0-5)	1 view/2 sec	13 x 24 km :: Global, daylight	N/A
Aerosol Optical Thickness	T50	1 view/2 sec	13 x 24 km :: Global, daylight	N/A
Cloud Height (and coverage)	30 mb :: 0-15 km	1 view/2 sec	13 x 24 km :: Global, daylight	1 km
SO ₂	20% :: 10%	1 view/4 sec	TBD	Column
NO ₂	TBD	TBD	TBD	Column
BrO	TBD	TBD	TBD	Column
OCLO	TBD	TBD	TBD	Column

Data products are preliminary pending approval of the OMI Science Team and peer review.

SAGE III

Stratospheric Aerosol and Gas Experiment III

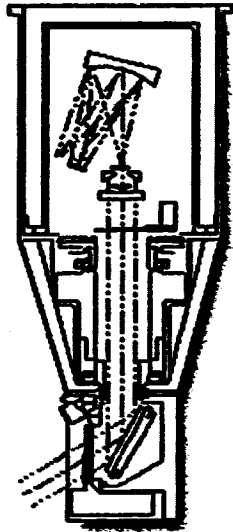

Key SAGE III Facts

Selected for flight on Russian Meteor 3M and International Space Station

Heritage: SAM II, SAGE I and SAGE II

Earth limb-scanning grating spectroradiometer

Phase C/D start November 1994

First flight aboard Meteor 3M in 1999

Prime Contractor: Ball Aerospace

Responsible Center: NASA/Langley Research Center

SAGE III is an improved extension of the successful Stratospheric Aerosol Measurement II (SAM II), SAGE I, and SAGE II experiments. The additional wavelengths and operation during both lunar and solar occultation that SAGE III provides will improve aerosol characterization; improve the gaseous retrievals of O₃, H₂O, and NO₂; add retrievals of temperature, pressure, NO₃ and OClO; extend the vertical range of measurements; provide a self-calibrating instrument independent of any external data needed for retrieval; and expand the sampling coverage. The science objectives are:

- Retrieve global profiles (with 1-to-2-km vertical resolution) of atmospheric aerosols, O₃, H₂O, NO₂, NO₃, OClO, temperature, and pressure in the mesosphere, stratosphere, and troposphere
- Investigate the spatial and temporal variability of the measured species in order to determine their role in climatological processes, biogeochemical cycles, the hydrologic cycle, and atmospheric chemistry
- Characterize tropospheric and stratospheric aerosols and upper tropospheric and stratospheric clouds, and investigate their effects on the Earth's environment, including radiative, microphysical, and chemical interactions
- Extend the SAM II, SAGE I, and SAGE II self-calibrating solar-occultation data sets (begun in 1978), enabling the detection of long-term trends
- Provide atmospheric data essential for the calibration and interpretation/correction of other satellite sensors, including EOS- and ground-based sensors.

SAGE III takes advantage of both solar and lunar occultations to measure aerosol and gaseous constituents of the atmosphere. Most of the objectives rely on the solar-occultation technique, which involves measuring the effects of extinction of solar energy by aerosol and gaseous constituents in the spectral region from 0.29 to 1.55 μm during spacecraft sunrise and sunset events. For example, during a sunset event, exoatmospheric solar limb data are obtained when the sun-satellite vector is high above the Earth's atmosphere. As the sun sets, a series of scans through the atmosphere is performed during which measurements of the solar transmission through the atmosphere are made. Because all atmospheric measurements are ratioed to the exoatmospheric solar limb profiles taken during the same event, the instrument is nearly self-calibrating, and the retrieved data are not susceptible to long-term instrument degradation.

The moon will be used as another source of light for occultation measurements. In the spectral region from 0.4 to 0.95 μm , the moon has a relatively flat, i.e., grey, albedo. A determination of the average lunar spectral albedo is obtained by ratioing the exoatmospheric scans of the moon to an appropriate set of exoatmospheric scans of the sun, thereby ratioing out the structure in the solar spectrum. This average lunar spectral albedo can then be used along with the extinction cross sections of all absorbing species in an optimal fit to the measurements.

Present plans call for concurrent flight of at least two instruments—one in an inclined orbit on the International Space Station (51.6°) and one in a sun-synchronous orbit on Meteor 3M (~9:15 a.m.)—to obtain near-global coverage. This comprehensive approach will allow SAGE III to make long-term measurements and to provide the congruent aerosol and gaseous data important to radiative and atmospheric chemistry studies.

Principal Investigator

M. Patrick McCormick

M. Patrick McCormick received an M.A. and Ph.D. in Physics from the College of William & Mary. After 30 years of service, he retired from NASA's Langley Research Center in 1996, joining the staff of Hampton University as a Professor in the Physics Department. Dr. McCormick is Principal Investigator of the SAM II, SAGE I, SAGE II, SAGE III, and LITE spaceflight experiments, as well as numerous other atmospheric remote-sensing instrument and data analysis experiments and is Co-Principal Investigator of the Pathfinder Instruments For Cloud And Aerosol Spaceborne Observations-Climatologie Etendue des Nuages et des Aerosols (PICASSO-CENA) mission. He received the Arthur S. Flemming Award for Outstanding Young People in Federal Service in 1979, the NASA Exceptional Scientific Achievement Medal in 1981, the American Meteorological Society's Jule G. Charney Award in 1991, the William T. Pecora Award in 1996, and numerous NASA Group or Special Achievement Awards. In addition, he received an Honorary Doctor of Science degree from Washington & Jefferson College in 1981, and has served on their Board of Trustees. Dr. McCormick is a member of the International Radiation Commission, the American Meteorological Society, and the American Geophysical Union, and was past chairman of the International Coordination group on Laser Atmospheric Studies. He was a member of the National Academy of Sciences Panel on Aerosol Radiative Forcing, the Committee on Meteorological Analysis, Prediction, and Research, the Panel on Climate Variability on Decade-to-Century time scales, and presently he is on the Committee on Earth Studies.

SAGE III Parameters

Self-calibrating solar and lunar occultation, with measurements within nine spectral regions between (290-1,550 nm), to study aerosols, O₃, OCIO, NO₂, NO_x, H₂C, temperature, and pressure

Swath: n/a (looks at sun and/or moon through Earth's limb)

Spatial resolution: 1-2 km vertical

Mass: 40 kg excluding unique hardware

Duty cycle: During solar and lunar Earth occultation

Power: 30 W (average), 75 W (peak)

Data rate: 100 kbps for 8 min, three times per orbit

Thermal control by: Passive, heaters, and thermal electric cooler

Thermal operating range: 10-30° C

FOV: $\pm 185^\circ$ azimuth, 13-31° elevation, dependent on orbital altitude

Instrument IFOV: <0.5 km vertical at 20-km tangent height

Pointing requirements (platform+instrument, 3 σ):

Control: 1°

Knowledge: 0.25°/axis

Stability: 30 arcsec/sec per axis

Physical size: 25 x 25 x 42 cm

34-cm diameter x 74 cm

Co-Investigators

Albert A. Chernikov - *Central Aerological Observatory, Russia*

William P. Chu - *NASA/Langley Research Center*

Derek M. Cunnold - *Georgia Institute of Technology*

John J. DeLuisi - *NOAA/Environmental Research Laboratory*

Philip A. Durkee - *Naval Postgraduate School*

Nikolai P. Elansky - *Institute of Atmospheric Physics, Russia*

Benjamin M. Herman - *University of Arizona*

Peter V. Hobbs - *University of Washington*

Geoffrey S. Kent - *Science and Technology Corporation*

Jacqueline Lenoble - *Universite des Sciences et Techniques de Lille, France*

Alvin J. Miller - *NOAA/National Weather Service*

Volker Mohren - *State University of New York-Albany*

Venkatachalam Ramaswamy - *Princeton University*

David H. Rind - *NASA/Goddard Institute for Space Studies*

Philip B. Russell - *NASA/Ames Research Center*

Vinod K. Saxena - *North Carolina State University*

Eric P. Shettle - *Naval Research Laboratory*

Gabor Vali - *University of Wyoming*

Steven C. Wofsy - *Harvard University*

Joseph M. Zawodny - *NASA/Langley Research Center*

Reference

McCormick, M.P., 1991: SAGE III capabilities and global change. Paper 91-0051, 29th Aerospace Sciences Meeting, 7-10 January 1991, Reno, Nevada, American Institute of Aeronautics and Astronautics; Washington, DC.

SAGE III Data Products

Product Name	Accuracy Absolute :: Relative	Temporal Resolution	Horizontal Resolution :: Coverage	Vertical Resolution :: Coverage
Level 1B Transmission (≥80 wavelengths) Solar Events	0.05% :: 0.05%	1/(2 minutes), 30/day	Solar 1.5 km :: Global Lunar 3.5 km :: Global	0.5 km :: 0-100 km
Aerosol Extinction Strat. Optical Depth (at 8 wavelengths), Aerosol to molecular extinction ratio at 1020 nm (solar only)	5% :: 5%	1/(2 minutes), 30/day	Solar 1.5 km :: Global Lunar 3.5 km :: Global	0.5 km :: 0-40 km
H ₂ O Concentration (Alt.) Mixing Ratio (Pressure)	10% :: 15%	1/(2 minutes), 30/day	Solar 1.5 km :: Global Lunar 3.5 km :: Global	0.5 km :: 0-50 km 24 levels/decade :: 1000-0.8 hPa
NO ₂ Concentration (Alt.) Mixing Ratio (Pressure) Slant Path Col. Amt. (Alt.)	10% :: 15%	1/(2 minutes), 30/day	Solar 1.5 km :: Global Lunar 3.5 km :: Global	0.5 km :: 10-50 km 24 levels/decade :: 250-0.8 hPa 0.5 km :: 10-50 km
NO ₃ (Lunar Only) Concentration (Alt.) Mixing Ratio (Pressure)	10% :: 10%	1/(2 minutes), 30/day	Solar 1.5 km :: Global Lunar 3.5 km :: Global	0.5 km :: 20-55 km 24 levels/decade :: 50-0.4 hPa
O ₃ Concentration (Alt.) Mixing Ratio (Pressure) Slant Path Col. Amt. (Alt.)	6% :: 5%	1/(2 minutes), 30/day	Solar 1.5 km :: Global Lunar 3.5 km :: Global	0.5 km :: 6-85 km 24 levels/decade :: 500-0.004 hPa 0.5 km :: 50-85 km
OCIO (Lunar Only) Concentration (Alt.) Mixing Ratio (Pressure)	25% :: 20%	1/(2 minutes), 30/day	Solar 1.5 km :: Global Lunar 3.5 km :: Global	0.5 km :: 15-25 km 24 levels/decade :: 121-25 hPa
Pressure	2% :: 2%	1/(2 minutes), 30/day	Solar 1.5 km :: Global Lunar 3.5 km :: Global	0.5 km :: 0-85 km
Temperature Profile (solar only)	2 K :: 2 K	1/(2 minutes), 30/day	Solar 1.5 km :: Global Lunar 3.5 km :: Global	0.5 km :: 0-85 km 24 levels/decade :: 1000-0.004 hPa
Cloud Presence	N/A	1/(2 minutes), 30/day	Solar 1.5 km :: Global Lunar 3.5 km :: Global	0.5 km :: 6-30 km

SeaWinds

NASA Scatterometer for Flight on ADEOS II

SeaWinds on ADEOS II

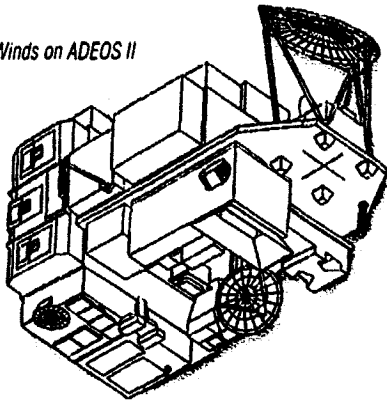

Key SeaWinds Facts

Flights on QuikScat and ADEOS-II missions.

Heritage: SEASAT, NSCAT.

Ku-band scatterometer with rotating antenna to measure global radar scattering cross-section and ocean near-surface wind velocity.

All-weather global ocean surface wind speed and direction measurements used for research studies and operational weather prediction.

Non-ocean scattering cross-sections used for vegetation classification/monitoring and ice edge/type investigations.

Continues cooperative efforts between the U.S. and Japan to evaluate and monitor global change.

Follow-ons to NSCAT, which flew on ADEOS-I in 1996-1997.

Instrument is in-house Jet Propulsion Laboratory development, subcontracts for major subsystems. QuikScat spacecraft is procured by GSFC for JPL.

Overall instrument Phase C/D started in 1992. QuikScat started in 1997 and fills the gap between the failure of the ADEOS-I spacecraft (6/97) and the launch of ADEOS-II.

SeaWinds URL

<http://winds.jpl.nasa.gov/>

The SeaWinds instruments are designed to acquire accurate, high-resolution, continuous, all-weather measurements of global (land, ice, and ocean) radar cross-section and near-surface vector winds over the ice-free global oceans. As the only instruments capable of measuring wind velocity—both speed and direction—under all-weather conditions, SeaWinds data are crucial for studies of tropospheric dynamics, upper-ocean circulation, and air-sea interaction. SeaWinds data will also be provided in near-real-time to the U.S. National Centers for Environmental Prediction (NCEP) for use in global and regional operational weather prediction.

SeaWinds transmits pulses of microwave radiation at 13.4 GHz and measures the backscattered signal from the Earth over a continuous, 1800-km-wide swath centered on the subsatellite track. The surface normalized radar cross-section is calculated from the backscatter measurements and knowledge of the viewing geometry and instrument characteristics. Over the ocean, the received power results primarily from scattering from centimetric ocean roughness elements whose amplitudes and directional distributions are in equilibrium with the local wind; thus backscattered power varies as a function of wind speed and direction relative to the radar beam. Multiple, near-simultaneous measurements of normalized radar cross-section obtained from the same location, but from different viewing directions and incidence angles, are combined with an empirical model function relating backscatter cross-section to wind conditions to allow calculation of near-surface wind speed and direction over the ice-free oceans.

The SeaWinds instruments are follow-ons to the NASA scatterometer (NSCAT), which flew on NASA's Advanced Earth Observation Satellite (ADEOS) from August 1996 until the failure of the ADEOS spacecraft in June 1997. The QuikScat mission was developed rapidly following the premature demise of ADEOS. QuikScat was launched on June 19, 1999 and is expected to operate for at least two years, overlapping the launch and validation of the SeaWinds instrument on ADEOS-II (currently planned for late 2000). The SeaWinds/ADEOS-II mission will operate for 3 years after launch with a 5-year lifetime goal. The dual-scanning-pencil-beam design of the SeaWinds instruments replaces the 6, 3-m-long antenna array used for NSCAT with a single 1-m diameter rotating-dish antenna. This compact design allows SeaWinds to be accommodated on both the QuikScat and ADEOS-II spacecraft, and provides a contiguous measurement swath (eliminating the 329-km nadir gap in the NSCAT data).

NASA's SeaWinds scatterometers will acquire high-accuracy wind speed and direction measurements over nearly 90% of the ice-free global oceans each day (exceeding the temporal resolu-

tion requirements in the data product table found at the end of this section). SeaWinds measurements will be provided in near-real time to NCEP for use in marine forecasting, operational global numerical weather prediction, and climate forecasting. SeaWinds data will play a crucial role in interdisciplinary scientific investigations of global weather patterns and marine meteorology, wind-driven ocean circulation, and air-sea interaction and climate dynamics. Raw backscatter measurements from land and ice are also used to classify vegetation type, monitor large-scale land use and productivity changes, and identify and monitor ice type and extent. Post-launch validation of the NSCAT measurements showed that they exceeded the pre-launch science accuracy requirements. Research studies and operational analyses using NSCAT data confirm the utility and impact of the scatterometer vector winds and demonstrate the scientific potential of the scatterometer measurements over land and ice.

SeaWinds data products will consist of global, multi-azimuth normalized radar cross-section measurements with $\sim 6 \times 25$ -km spatial resolution, and 25-km resolution ocean vector winds ($\sim 12\%$ speed and 20-deg direction accuracies for wind speeds of 3-30 m/s) in the measurement swath. Cross-section measurements obtained by the ADEOS-II instrument will be rain-flagged and corrected for atmospheric attenuation effects using ADEOS-II AMSR data where available.

Principal Investigator **Michael Freilich**

Michael Freilich received degrees in Physics (honors) and Chemistry from Haverford College, and a Ph.D. in Oceanography from Scripps Institution of Oceanography in 1982. He joined the Jet Propulsion Laboratory in 1983 as a member of the Oceanography Group. He served as the NSCAT Project Scientist from 1983 to 1992, and was a Principal Investigator and Coordinating Investigator for the European Space Agency's ERS-1 and ERS-2 missions. Currently, he is an associate professor in the College of Oceanic and Atmospheric Sciences at Oregon State University.

Co-Investigators

Robert M. Atlas - *NASA/Goddard Space Flight Center*

Robert A. Brown - *University of Washington*

Peter Cornillon - *University of Rhode Island*

David Halpern - *Jet Propulsion Laboratory*

SeaWinds Parameters

Mass: 220 kg

Power: 220 W

Duty Cycle: 100%

Data Rate: 40 kbps

Thermal control by: radiators

Thermal operating range: 5-40° C

FOV: Rotating (at 18 rpm) pencil beam antenna with dual feeds pointing 40° and 46° from nadir

iFOV: $\pm 51^\circ$ from nadir

Swath: 1800 km ($\pm 51^\circ$) from 705 km altitude

Pointing requirements (3σ):

Control: $< 0.3^\circ$ (~ 1000 arcsec)

Knowledge: $< 0.05^\circ$ (~ 167 arcsec)

Stability: $< 0.008^\circ/\text{sec}$ (30 arcsec/sec)

Physical Size: 32 x 46 x 34 cm (CDS)

81 x 91 x 43 cm (SES)

100 cm diameter antenna dish on

60 cm diameter x 60 cm pedestal

Total height is ~ 150 cm (SAS)

Ross Hoffman - *Atmospheric and Environmental Research*

W. Timothy Liu - *Jet Propulsion Laboratory*

David G. Long - *Brigham Young University*

Richard K. Moore - *University of Kansas*

James J. O'Brien - *Florida State University*

References

Naderi, F.M., M.H. Freilich, and D.G. Long, 1991: Spaceborne radar measurement of wind velocity over the ocean—An overview of the NSCAT Scatterometer System. *Proc. Ins. IEEE*, 79, 850-866.

Wu, C., J. Graf, M. Freilich, D. Long, M. Spencer, W. Tsai, D. Lisman, and C. Winn, 1994: *The Sea Winds scatterometer instrument. International Geoscience and Remote Sensing Symposium*, Volume 3, 8-12 August 1994, Pasadena, CA, T.I. Stein, Ed., Institute of Electrical and Electronic Engineers, Piscataway, N.J., 1511-1515.

SeaWinds Data Products

Product Name	Accuracy Absolute :: Relative	Temporal Resolution	Horizontal Resolution :: Coverage	Vertical Resolution :: Coverage
Level-1B Product			6 × 25 km :: Global	
Global Backscatter Cross-section	:: 0.25 dB	70% daily, 90% every 2 days	6 × 25 km :: Global (Land, Ocean, & Ice)	N/A :: Surface
Ocean Vector Winds	-12% speed :: 20° direction ::	90% oceans every 2 days	25 km :: Ocean	N/A :: Surface

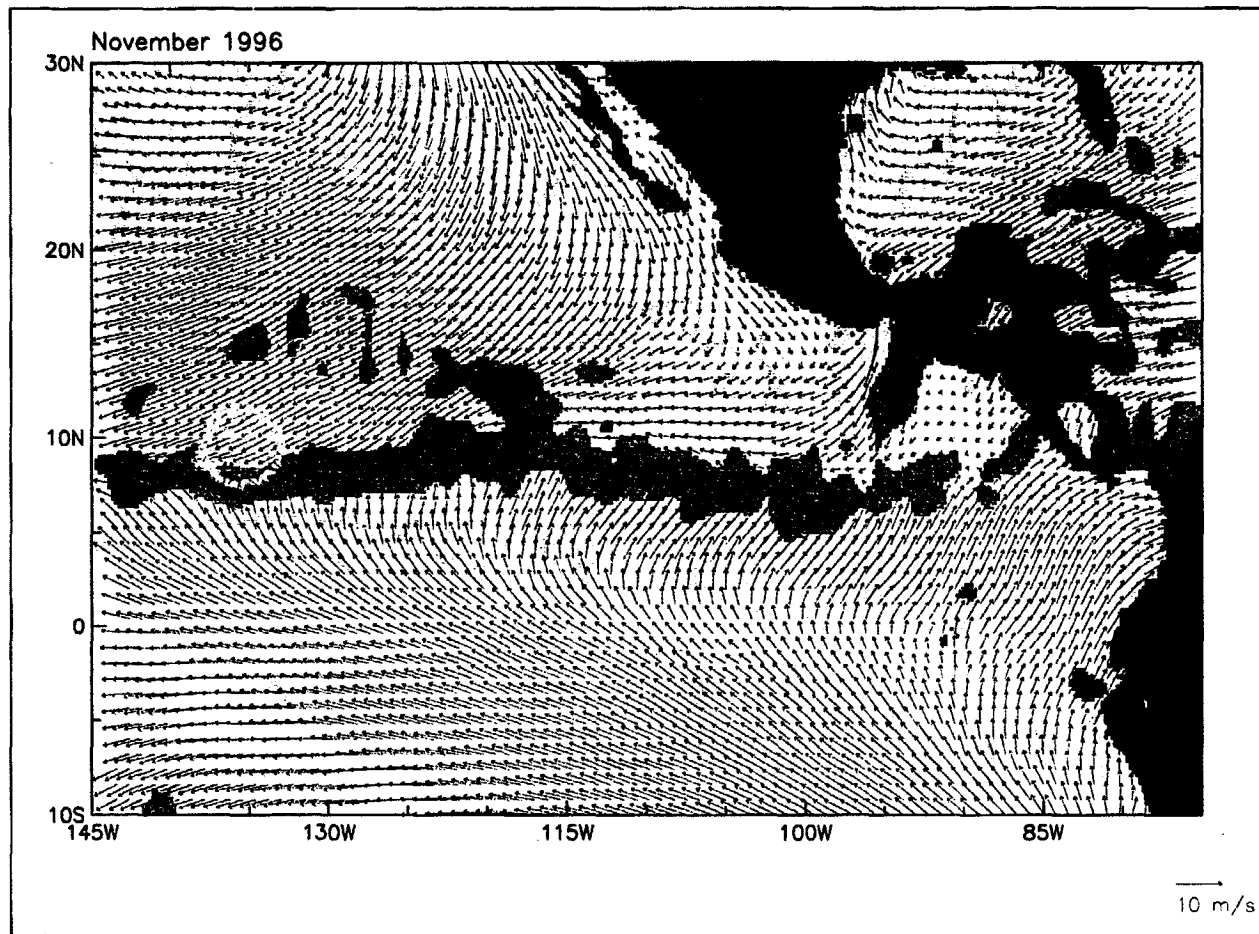

Monthly mean wind velocity and wind stress curl in the tropical Pacific during November 1996, as measured by the NASA Scatterometer. Arrows indicate monthly mean near-surface wind velocity. Instantaneous NSCAT velocity measurements were transformed to wind stress, and the vertical component of wind stress curl was calculated from the monthly mean stress field. Dark shading indicates regions of mean wind stress curl greater than $1 \times 10^{-7} \text{ N/m}^2$; light shading delimits mean curls less than $-1 \times 10^{-7} \text{ N/m}^2$.

The zonally coherent bands of intense positive curl near the intertropical Convergence Zone and negative curl to the south drive the complex zonal North Equatorial Current and North Equatorial Counter Current systems.

During November 1996, winds over the Gulf of Tehuantepec (15° N , 95° W) were dominated by a few short but intense northerly wind events. The white line of zero wind stress curl (separating the intense negative curl to the northwest and the similarly large positive curl to the southeast) defines the monthly mean core of the jet.

SORCE

Solar Radiation and Climate Experiment

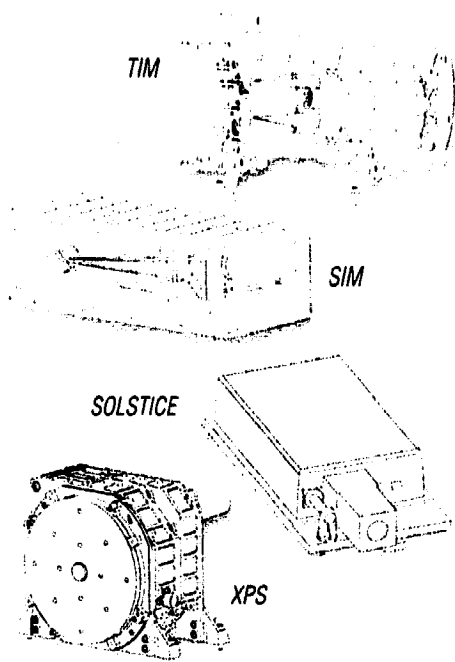

Key SORCE Facts

PI Mode Mission

Heritage: UARS SOLSTICE

Four instruments on a solar/stellar pointed spacecraft:

- 1) four-channel active cavity radiometer (TIM);
- 2) visible and near-infrared prism spectrometer (SIM);
- 3) two-channel ultraviolet grating spectrometer (SOLSTICE);
- 4) extreme ultraviolet and soft X-ray photometer (XPS)

Provides daily measurements of total solar irradiance (TSI) and spectral solar irradiance between 1 nm and 2000 nm, incorporating absolute sensors, in-flight calibration and, in the case of the UV observations, comparison to bright early-type stars

Responsible Center: Laboratory for Atmospheric and Space Physics (LASP)/University of Colorado at Boulder

SORCE URL

<http://lasp.colorado.edu/sorce>

The Solar Radiation and Climate Experiment (SORCE) consists of a small, free-flying satellite carrying four instruments to measure solar radiation incident at the top of the Earth's atmosphere. It is scheduled for launch in mid-2002 carrying the Total Irradiance Monitor (TIM), Spectral Irradiance Monitor (SIM), Solar Stellar Irradiance Comparison Experiment (SOLSTICE), and the XUV Photometer System (XPS).

The total solar irradiance, or TSI, along with Earth's global average albedo, determines Earth's global average equilibrium temperature. Because of selective absorption and scattering processes in the Earth's atmosphere, different regions of the solar spectrum affect Earth's climate in distinct ways. Approximately 20-25% of the TSI is absorbed by atmospheric water vapor, clouds, and ozone, by processes that are strongly wavelength dependent. Ultraviolet radiation at wavelengths below 300 nm is completely absorbed by the Earth's atmosphere and contributes the dominant energy source in the stratosphere and thermosphere, establishing the upper atmosphere's temperature, structure, composition, and dynamics. Even small variations in the Sun's radiation at these short wavelengths will lead to corresponding changes in atmospheric chemistry. Radiation at the longer visible and infrared wavelengths penetrates into the lower atmosphere, where the portion not reflected is partitioned between the troposphere and the Earth's surface, and becomes a dominant term in the global energy balance and an essential determinant of atmospheric stability and convection. Thus it is important to accurately monitor both the TSI and its spectral dependence.

Variations of the solar radiation field are still largely unknown, but in the visible they are likely far less than one percent. The observations therefore require precision and accuracy that can only be achieved from space. Although the shortest wavelength ultraviolet radiation from the Sun varies by much larger factors, its measurement also requires access to space since the radiation does not penetrate the atmosphere. Precise space measurements obtained during the past 20 years imply that TSI varies on the order of 0.1% over the solar cycle, but with greater variations on a short-term basis. For example, the passage of sunspots over the disk produces 2-4 times that amount. The variation apparently occurs over most time scales, from day-to-day variations up to and including variations over the 11-year solar cycle. How TSI variations are distributed in wavelength is still poorly understood. The largest relative solar variations are factors of two or more at ultraviolet and shorter wavelengths, but the greater total energy available at visible and longer wavelengths makes their small variations of potential importance.

Assuming climate models include a realistic sensitivity to solar forcing, the record of solar variations implies a global surface temperature change on the order of only 0.2° C. However, global energy balance considerations may not provide the entire story. Some recent studies suggest that the cloudy lower atmosphere ab-

sorbs more visible and near infrared radiation than previously thought (25% rather than 20%), which impacts convection, clouds, and latent heating. Also, the solar ultraviolet, which varies far more than the TSI, influences stratospheric chemistry and dynamics, which in turn controls the small fraction of ultraviolet radiation that leaks through to the surface.

SORCE provides precise daily measurements of the total solar irradiance with the TIM instrument, and also the solar spectral irradiance at wavelengths extending from the far ultraviolet to the near infrared with the SOLSTICE, SIM, and XPS instruments. The TIM instrument will continue the precise measurements of total solar irradiance that began with the Nimbus-7/ERB instrument in 1979 and have continued to the present with the ACRIM series of measurements as well as ERBS/ERBE, which began in 1984. The Sun has both direct and indirect influences on the terrestrial system, and SORCE's total and spectral solar measurements provide the requisite understanding of one of the primary climate system variables.

TIM incorporates four cavities (cones) and adheres to the basic concepts of Electrical Substitution Radiometers (ESRs), but employs modern, state-of-the-art electronics and materials. The four cavities provide multiple redundancy and added duty-cycling capability. It will provide an absolute accuracy of 300 ppm, and a precision and long-term relative accuracy of 10 ppm per year.

SIM is a doubly-redundant, prism spectrometer covering the full spectral range 200-2000 nm with a resolving power greater than 30 (bandwidth < 34 nm). Its optical design is a variant of a prism spectrometer first described by Féry in 1910—the prism has a concave front surface and a convex, aluminized rear surface, and is therefore self-focusing. The optical system uses two quartz prisms, each with a separate optical path, providing complete redundancy. The two paths can also be coupled, whereby one prism delivers monochromatic light to the other for in-flight calibration. Using a miniature electrical substitution radiometer (ESR) as a detector, SIM will provide an absolute accuracy of 0.03%, and long-term relative accuracy of 0.01% per year.

SOLSTICE consists of a two-channel grating spectrometer capable of being pointed at the Sun or at selected stars and measures from 115-300 nm. The stellar targets, observed with the same optics and detectors employed for the solar measurements, are essential because they establish long-term corrections to the instrument calibration. The ensemble average flux from these 20 or so bright, early-type stars should remain absolutely constant—intrinsic variability of less than one part in ten thousand over thousands of years. The unique in-flight calibration technique of SOLSTICE thereby establishes the instrument response as a function of time throughout the SORCE mission, and yields time series of solar data corrected for instrumental effects to an accuracy of about 1 percent. Moreover, the SOLSTICE technique provides the unique ability to directly compare solar irradiance measurements

made during the SORCE mission with previous and future observations. Since the stellar irradiance remains essentially constant, stellar measurements provide a stable in-flight reference that is readily transferred between missions, provided each mission makes observations of the same stars.

The SORCE investigation will also model the penetration of solar radiation into the Earth's atmosphere to establish the radiation field as a function of location and altitude. The standard SORCE data product will provide four measurements per day of the total solar irradiance and of the spectral solar irradiance from 1 nm to 2000 nm. More specifically, spectral data products will consist of solar ultraviolet irradiance from 115-300 nm with a spectral resolution of 1 nm, the visible and near-infrared irradiance from 200-2000 nm with a varying resolution of 1-34 nm, and six broadband samples of the XUV from 1-31 nm and at Lyman- α (121.6 nm).

Principal Investigator **Gary Rottman**

Gary Rottman holds an M.S. and Ph.D. in Physics from the Johns Hopkins University. He is the Associate Director of the Laboratory for Atmospheric and Space Physics of the University of Colorado, Boulder. His space research includes roles as Principal or Co-Investigator on numerous solar and atmospheric investigations, including Solar-Mesosphere Explorer, the Upper Atmosphere Research Satellite (UARS) SOLSTICE Program, and the Solar Extreme Ultraviolet Experiment on the TIMED mission.

Co-Investigators

Thomas N. Woods - *University of Colorado*

George M. Lawrence - *University of Colorado*

Jerry Harder - *University of Colorado*

Bill McClintock - *University of Colorado*

Julius London - *University of Colorado*

Judith Lean - *Naval Research Laboratory*

Oran R. White - *National Center for Atmospheric Research*

Peter Fox - *National Center for Atmospheric Research*

Paul C. Simon - *Belgian Institute of Space Aeronomy*

Dominique Crommelynck - *Royal Meteorological Institute of Belgium*

SORCE Project

William Ochs - *SORCE Project Manager*

Robert Cahalan - *SORCE Project Scientist*

References

Rottman, G.J., T.N. Woods, and T.P. Sparr, 1993: Solar Stellar Irradiance Comparison Experiment I: 1 Instrument Design and Operation. *J. Geophys. Res.*, **98**, 10,667-10,677.

Woods, T.N., G.J. Rottman, and G. Ucker, 1993: Solar Stellar Irradiance Comparison Experiment I: 2 Instrument Calibration. *J. Geophys. Res.*, **98**, 10,679-10,694.

Woods, T.N., D.K. Prinz, G.J. Rottman, J. London, P.C. Crane, R.P. Cebula, E. Hilsenrath, G.E. Brueckner, M.D. Andrews, O.R. White, M. E. VanHoosier, L.E. Flyod, L. C. Herring, B.G. Knapp, C.K. Pankratz, and P.A. Reiser, 1996: Validation of the UARS Solar Ultraviolet Irradiances: Comparison with the ATLAS - 1, - 2 Measurements. *J. Geophys. Res.*, **101**, 9541-9569.

Rottman, G.J., G. Mount, G. Lawrence, T. Woods, J. Harder, and S. Tournois, 1997: Solar spectral irradiance measurements: Visible to near infrared, NEWRAD'97. *Metrologia*, **35**, 707-712.

Lawrence, G.M., J. Harder, G. Rottman, T. Woods, J. Richardson, and G. Mount, 1998: Stability considerations for a solar Spectral Intensity Monitor (SIM). *SPIE*, **3427**, 477-485.

SORCE Parameters

Spectral range from 1-2000 nm

TIM: Total Irradiance Monitor

SIM: Spectral Irradiance Monitor (200-2000 nm)

SOLSTICE: Solar Stellar Irradiance Comparison Experiment (115-300 nm)

XPS: XUV Photometer System (1-31 nm)

Photometric accuracy: TIM will provide an absolute accuracy of 300 ppm with a relative accuracy of 10 ppm per year; SIM an absolute accuracy of 0.03% and a relative accuracy of 0.01% per year; SOLSTICE an absolute accuracy better than 5%, and relative accuracy better than 1%, and XPS an absolute accuracy of 12% and a relative accuracy of 4%.

Spectral resolution: varying from 1-34 nm

Swath: n/a

Spatial resolution: n/a

Mass: 78 kg

Duty cycle: 83% data taking

Power: 113 W (Orbit average)

Data rate: 6.8 kbps (average)

Thermal control by: Passive radiator/actively heated detectors

Thermal operating range: -10 to +20° C (15° average)

FOV: 2 π unobstructed from spacecraft

Instrument IFOV: TIM 12.8°, SOLSTICE 1.5° x 1.5°, SIM 1.5° x 1.5°, and XPS 6°

Pointing requirements:

Control: +/- 1 arcmin

Knowledge: 30 arcsec

Stability: 1 arcmin/min

Jitter: 15 arcsec per sec

Physical size: TIM 16 x 21 x 30 cm;

SIM 16 x 18 x 81 cm; SOLSTICE 18 x 39 x 85 cm;

XPS 16 x 19 x 18 cm

SORCE Data Products

Product Name	Accuracy Absolute :: Relative	Temporal Resolution	Horizontal Resolution :: Coverage	Vertical Resolution :: Coverage
Total Solar Irradiance (TSI)	300 ppm :: 10 ppm/year	4/day	N/A :: N/A	N/A :: Top of Atmos
Solar Spectral Irradiance, (1-2000 nm)	3-5% :: 1% UV 0.03% :: 0.01%/year visible/ near IR 12% :: 4% XUV	4/day	N/A :: N/A	N/A :: Top of Atmos
Level-1B Radiance	0% :: N/A	On demand	2 deg :: Global	1 km :: 40-100 km

TES

Tropospheric Emission Spectrometer

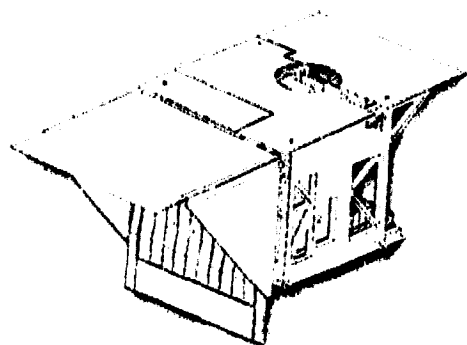

Key TES Facts

Selected for flight on EOS CHEM

Heritage: ATMOS, SCRIBE, AES

High-spectral-resolution infrared-imaging Fourier transform spectrometer

Generates three-dimensional profiles on a global scale of virtually all infrared-active species from Earth's surface to the lower stratosphere

In-house Jet Propulsion Laboratory development

TES URL

<http://tes.jpl.nasa.gov/>

TES is a high-resolution infrared-imaging Fourier transform spectrometer with spectral coverage of 3.2 to 15.4 μm at a spectral resolution of 0.025 cm^{-1} , thus offering line-width-limited discrimination of essentially all radiatively active molecular species in the Earth's lower atmosphere. TES has the capability to make both limb and nadir observations. In the limb mode, TES has a height resolution of 2.3 km, with coverage from 0 to 34 km. In the down-looking modes, TES has a spatial resolution of $0.53 \times 5.3\text{ km}$ with a swath of $5.3 \times 8.5\text{ km}$. TES is a pointable instrument and can access any target within 45° of the local vertical, or produce regional transects up to 885-km length without any gaps in coverage.

TES employs both the natural thermal emission of the surface and atmosphere and reflected sunlight, thereby providing day-night coverage anywhere on the globe.

Observations from TES will further understanding of long-term variations in the quantity, distribution, and mixing of minor gases in the troposphere, including sources, sinks, troposphere-stratosphere exchange, and the resulting effects on climate and the biosphere. TES will provide global maps of tropospheric ozone and its photochemical precursors. These observations will serve as primary inputs to a database of the three-dimensional distribution (on global, regional, and local scales) of gases important to tropospheric chemistry, troposphere-biosphere interactions, and troposphere-stratosphere exchange. Other objectives include:

- Simultaneous measurements of NO_y , CO , O_3 , and H_2O for use in the determination of the global distribution of OH, an oxidant of central importance in tropospheric chemistry;
- measurements of SO_2 and NO_y as precursors to the strong acids H_2SO_4 and HNO_3 , which are the main contributors to acid deposition;
- measurements of gradients of many tropospheric species in order to understand troposphere-stratosphere exchange; and
- determination of long-term trends in radiatively active minor constituents in the lower atmosphere to investigate effects on global radiative balance and atmospheric dynamics.

TES measurements will help determine local atmospheric temperature and humidity profiles, local surface temperatures, and local surface reflectance and emittance. TES observations will also be used to study volcanic emissions for hazard mitigation, indications of the chemical state of the magma, eruption prediction, and quantification of the role of volcanoes as sources of atmospheric aerosols.

The aforementioned database will calibrate models of the present and future state of the Earth's lower atmosphere. These models will investigate topics such as:

- Biogeochemical cycles between the lower atmosphere and biosphere (primarily carbon monoxide and methane);
- global climate modification caused by an increase in radiatively active gases;
- distribution and lifetimes of chlorofluorocarbons (CFCs) and halons, which contribute substantially to the depletion of stratospheric ozone;
- changes in the oxidizing power of the troposphere and the distribution of tropospheric ozone caused by urban and regional pollution sources, particularly carbon monoxide, nitrogen oxides, methane, and other hydrocarbons;
- acid deposition precursors;
- sources and sinks of species important to the generation of tropospheric and stratospheric aerosols; and
- natural sources of trace gases such as methane from organic decay, nitrogen oxides from lightning, and sulphur compounds from volcanoes.

Principal Investigator
Reinhard Beer

Dr. Beer received a B.Sc. and Ph.D. in Physics from the University of Manchester, United Kingdom. He has been associated with the Jet Propulsion Laboratory since 1963; his current position is that of Senior Research Scientist and Leader of the Tropospheric Emission Spectrometry Flight Team. Dr. Beer was chairman of the NASA Infrared Experiments Working Group and now serves as Principal Investigator for the Airborne Emission Spectrometer (AES). He has been awarded the NASA Exceptional Scientific Achievement Medal for the discovery of extraterrestrial deuterium, three NASA group achievement awards, and numerous certificates of recognition.

Co-Investigators

Shepard A. Clough - *Atmospheric and Environmental Research*

Daniel J. Jacob - *Harvard University*

Jennifer A. Logan - *Harvard University*

Frank Murcray - *University of Denver*

David Rider - *Jet Propulsion Laboratory*

Curtis P. Rinsland - *NASA/Langley Research Center*

Clive D. Rodgers - *Oxford University*

Stanley P. Sander - *Jet Propulsion Laboratory*

Fredric W. Taylor - *Oxford University*

Helen Worden - *Jet Propulsion Laboratory*

TES Parameters	
Maximum sampling time of 16 sec, with a signal-to-noise ratio of up to 600:1	
<i>Limb mode:</i> Altitude coverage = 0-34 km	
Nadir and limb viewing (fully targetable)	
<i>Spectral region:</i> 3.2 to 15.4 μm , with four single-line arrays optimized for different spectral regions	
<i>Swath:</i> 5.3 \times 8.5 km	
<i>Spatial resolution:</i> 0.53 \times 5.3 km	
<i>Mass:</i> 385 kg (allocation)	
<i>Duty cycle:</i> Variable	
<i>Power:</i> 334 W (allocation)	
<i>Data rate:</i> 6.2 Mbps (peak); 4.9 Mbps (average)	
<i>Thermal control by:</i> 2 Stirling cycle coolers, heater, radiators	
<i>Thermal operating range:</i> 0-30 $^{\circ}$ C	
<i>FOV:</i> +45 $^{\circ}$ to -72 $^{\circ}$ along-track, \pm 45 $^{\circ}$ cross-track	
<i>Instrument IFOV:</i> 12 \times 7.5 mrad	
<i>Pointing requirements (platform+instrument, 3 σ):</i>	
Control: 156 arcsec (pitch)	
Knowledge: 124 arcsec	
Stability: 156 arcsec (over 50 sec)	
<i>Physical size:</i> 140 \times 130 \times 135 cm (stowed); 304 \times 130 \times 135 cm (deployed)	

Reference

Glavich, T.A., and R. Beer, 1991: Tropospheric Emission Spectrometer for the Earth Observing System Infrared Technology XVII, 22-26 July 1991, San Diego, California-Proceedings of SPIE - The International Society for Optical Engineering, Vol. 1540, Society of Photo-Optical Instrumentation Engineers, Bellingham, Washington, 148-159.

TES Data Products

Product Name	Accuracy Absolute :: Relative	Temporal Resolution	Horizontal Resolution :: Coverage	Vertical Resolution :: Coverage
Level-1B Radiance, TES (IR spectra in selected bands 3.2 - 15.4 μ m)	1% :: 1%	1/(16 day) measured over a 4-day period	5.3 x 8.5 km Global	
CH ₄ Mixing Ratio	3% :: 14 ppbv	1/(16 day) measured over a 4-day period	5.3 x 8.5 km Global	2-6 km :: 0-34 km
CO Mixing Ratio	3% :: 3-10 ppbv	1/(16 day) measured over a 4-day period	5.3 x 8.5 km Global	2-6 km :: 0-34 km
HNO ₃ Mixing Ratio	5% :: 3 pptv	1/(16 day) measured over a 4-day period	5.3 x 8.5 km Global	2-3 km :: 0-34 km
NO Mixing Ratio	3% :: 15-25 pptv	1/(16 day) measured over a 4-day period	5.3 x 8.5 km Global	2-3 km :: 5-34 km
NO ₂ Mixing Ratio	5% :: 100 pptv	1/(16 day) measured over a 4-day period	5.3 x 8.5 km Global	2-3 km :: 5-34 km
O ₃ Mixing Ratio	3% :: 3-20 ppbv	1/(16 day) measured over a 4-day period	5.3 x 8.5 km Global	2-6 km :: 0-34 km
H ₂ O/HDO Mixing Ratio	2 K :: 0.2 K	1/(16 day) measured over a 4-day period	5.3 x 8.5 km Global	4-6 km :: 0-34 km
Temperature Profile	3% :: 0.5-50 ppmv	1/(16 day) measured over a 4-day period	5.3 x 8.5 km Global	2-6 km :: 0-34 km
Land-Surface Brightness Temperature	1 K :: 0.1 K	1/(16 day) measured over a 4-day period	5.3 x 8.5 km Global	N/A :: Surface
Level 2 Detection Flags			5.3 x 8.5 km Global	



This is a sequence of frames, beginning at the top, from an animation depicting the launch and deployment of the Earth Observing System's Terra platform from an ATLAS II AS rocket. This and other animations can be found at <http://terra.nasa.gov/>

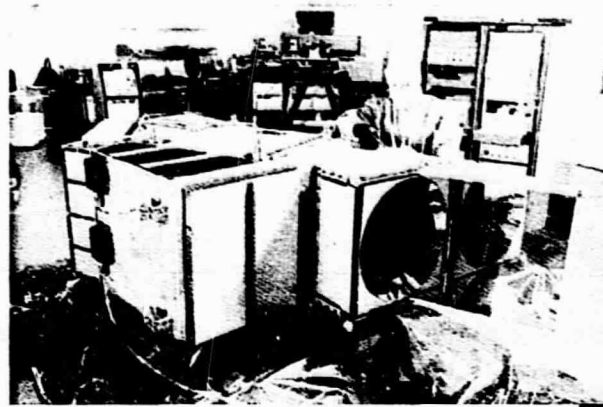

The ETM+ scanner (above) being prepared prior to shipment for installation on the Landsat 7 platform (right). Landat 7 was successfully launched from Vandenberg Air Force Base on April 15, 1999.

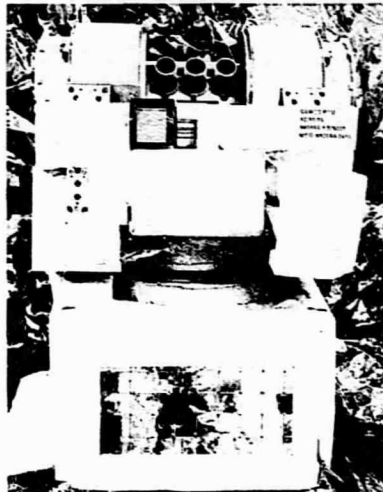
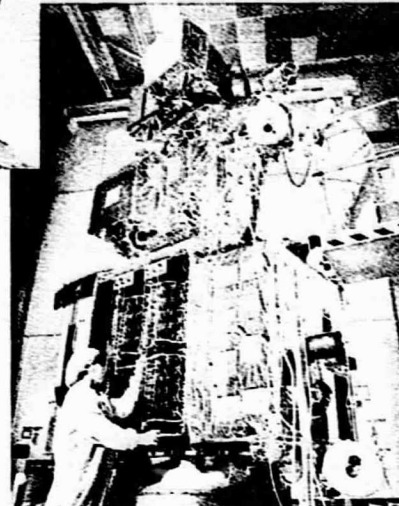

This is a photograph of the Clouds and the Earth's Radiant Energy System (CERES) instrument. CERES measures both solar-reflected and Earth-emitted radiation from the top of the atmosphere to the surface. It will also determine cloud properties including the amount, height, thickness, particle size, and phase of clouds using simultaneous measurements by other instruments. One CERES scanner (left) was successfully launched on the TRMM spacecraft on November 27, 1997. Two more CERES scanners will fly on the Terra as well as the EOS PM spacecraft.

The Moderate-resolution Imaging Spectroradiometer (MODIS) instruments—built to NASA specifications by Santa Barbara Remote Sensing—represent the finest in engineering of spaceflight hardware for remote sensing of the atmosphere, land, and ocean. MODIS is scheduled for flight on Terra and EOS PM.

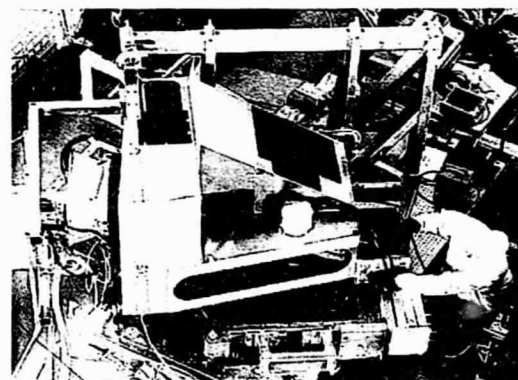

Interdisciplinary Science Investigations

In 1988, NASA issued an Announcement of Opportunity (AO) for the selection of instruments, science teams, and interdisciplinary investigation teams in support of the Earth Observing System (EOS). A total of 458 proposals were received in response to the AO, and early in 1990 NASA announced the selection of 29 Interdisciplinary Science (IDS) investigations. The IDS teams were selected to conduct basic research, develop methods and models for analysis of EOS observations, develop and refine models of Earth system processes, and forge new alliances among scientific disciplines fostering a unique perspective into how the Earth functions as an integrated system. As the program has evolved, the number of IDS investigations has been increased to 71.

Many of the important scientific questions to be studied by EOS require analyses by interdisciplinary teams using data and information from multiple EOS and international instruments and in situ observations. The IDS investigation teams bring together highly talented experts from diverse fields to tackle specific areas of uncertainty regarding the functioning of the Earth as a coupled system. All investigations will exploit the newly accessible EOS data, with research results being made available through EOSDIS to enhance broad participation by the science community at large.

The list on this and the following pages provides the names of the IDS Principal Investigators, the title of their investigations, and the pages on which descriptions of their investigations can be found.

Mark Abbott 162
Coupled Atmosphere-Ocean Processes and Primary Production in the Southern Ocean

Kevin R. Arrigo 165
Validation of MODIS Primary Productivity Algorithms

Marcia Baker 168
Water Transport to the Upper Troposphere by Convective Systems, as Inferred from Global Lightning Data

Eric J. Barron 170
Global Water Cycle: Extension Across the Earth Sciences

Ian J. Barton 172
Interdisciplinary Studies of the Relationships Between Climate, Ocean Circulation, Biological Processes, and Renewable Marine Resources

G. Robert Brakenridge 175
River Flooding and Global Environmental Change: A Multi-Sensor Approach

Douglas G. Capone 178
Collaborative Research: Modeling of N₂ and CO₂ Fixation by the Oceanic Diazotroph *Trichodesmium*

Mary-Elena Carr 180
An Historical and Modeling Comparison Study of Four Coastal Upwelling Systems

William L. Chameides 182
The Yangtze Delta of China as an Evolving Metro-Agro-Plex (China-MAP)

Josef Cihlar 185
Northern Biosphere Observation and Modeling Experiment (NBIOME)

Jean O. Dickey 188
Retrieval, Assimilation, and Modeling of Atmospheric Water Vapor from Ground- and Space-Based GPS Networks: Investigation of the Global and Regional Hydrological Cycles

- Robert E. Dickinson** 191
Project to Interface Modeling on Global and Regional Scales with EOS Observations
- Paul A. Dirmeyer** 193
The Global Soil Wetness Project
- Jeff Dozier** 195
Hydrology, Hydrochemical Modeling, and Remote Sensing In Seasonally Snow-covered Alpine Drainage Basins
- Ralph Dubayah** 198
Combining Remote Sensing and Hydrological Modeling for Applied Water and Energy Balance Studies
- Dara Entekhabi** 201
Direct Use of Satellite Remote Sensing in the Estimation of Hydrologic Transports
- Paul G. Falkowski** 202
Representing Key Phytoplankton Groups in Ocean Carbon Cycle Models
- Jonathan Foley** 204
Integrating Biogeochemical, Ecological, and Hydrological Processes in a Dynamic Biosphere
- Inez Fung** 208
Biosphere-Atmosphere Interactions
- Steven J. Ghan** 210
Aerosols, Clouds, Chemistry, and Radiative Forcing
- Barry E. Goodison** 213
Use of the Cryospheric System (CRYSYS) to Monitor Global Change in Canada
- Sirpa Hakkinen** 216
Freshwater Cycle in the Global Ocean
- James E. Hansen** 218
Interannual Variability of the Global Carbon, Energy, and Hydrologic Cycles
- Dennis Hartmann** 220
Climate Processes Over the Oceans
- Eileen Hofmann** 222
Evaluation of Marine Productivity in the Tropical Pacific and Atlantic Oceans Using Satellite Ocean Color and Numerical Models
- Brent Holben** 224
Characterizing Aerosol Forcing Over the Atlantic Basin
- Marc Lee Imhoff** 226
Assessing the Impact of Expanding Urban Land Use on Agricultural Productivity Using Remote Sensing Data and Physically Based Soil Productivity Models
- Thomas J. Jackson** 228
Soil Moisture Mapping at Satellite Temporal and Spatial Scales

- Daniel J. Jacob** 230
Investigation of the Coupling Between Tropospheric Ozone, Sulfate Aerosols, and Climate Using a General Circulation Model
- Prasad Kasibhatla** 233
A Study of Carbon Monoxide Using Trace Constituent Data Assimilation: A New Approach in Global Tropospheric Chemistry Analysis
- R. F. Keeling** 235
Southern Ocean Seasonal Net Production From Atmosphere and Ocean Data Sets
- Yann Kerr** 238
Soroosh Sorooshian
The Hydrologic Cycle and Climatic Processes in Arid and Semi-Arid Lands
- Jeffrey T. Kiehl** 241
Climate and Chemical Cycles: The Role of Sulfate and Ozone in Climate Change
- Charles E. Kolb** 243
Urban Metabolism and Trace Gas Respiration
- Randal D. Koster** 246
The Land Surface Component of the Climate System: (i) Improved Representation of Subgrid Processes and (ii) Analysis of Land Surface Effects on Climate Variability
- William K. M. Lau** 248
Regional Land-Atmosphere Climate Simulation System (RELACS) for the Asian Monsoon Region
- W. Timothy Liu** 251
The Role of Air-Sea Exchanges and Ocean Circulation in Climate Variability
- Yongqiang Liu** 253
Spatial and Temporal Variability of Soil Moisture and Its Relation to Water and Energy Balances in a Monsoon Region
- John C. Marshall** 255
Interannual Variability of Ocean Color: A Synthesis of Satellite Data and Models and Participation in the Ocean Carbon Cycle Model Intercomparison
- Charles R. McClain** 256
Physical-Biological Interactions in the Tropical Pacific & Atlantic Equatorial Surface Layers
- Dennis McGillicuddy** 259
Modeling Mesoscale Biogeochemical Processes in a TOPEX/Poseidon Diamond Surrounding the U.S. JGOFS Bermuda Atlantic Time-series Study
- Linda O. Mearns** 260
Analysis of the Effect of Changing Climate Variability on Crop Production in the Southeastern United States: An Integration of Stochastic Modeling, Regional Climate Modeling, Crop Modeling, and Remote Sensing Techniques

- Massimo Menenti** 263
Observation and Modeling of Heat and Water Fluxes Over Heterogeneous Land Surfaces at Mesoscale
- Norman L. Miller** 265
Global Climate Impact on Regional Hydro-Climate and its Effect on Southeastern Asian Agro-Ecosystems
- Berrien Moore** 267
Changes in Global Biogeochemical Cycles
- Peter J. Mouginiis-Mark** 269
A Global Assessment of Active Volcanism, Volcanic Hazards, and Volcanic Inputs to the Atmosphere
- Frank E. Muller-Karger** 272
Synoptic Analysis of Factors Influencing Carbon Fluxes at a Continental Margin Time Series: CARIACO
- Masato Murikami** 275
Investigation of the Atmosphere-Ocean-Land System Related to Climate Processes
- Raymond G. Najjar** 277
Evaluation and Comparison of Global Three-dimensional Marine Carbon Cycle Models
- Kenneth E. Pickering** 278
Tropospheric Convection and Stratosphere-Troposphere Exchange: Effects on Photochemistry, Aerosols, and Climate
- Roger Pielke, Sr.** 281
Coupling Atmospheric, Ecological, and Hydrologic Processes in a Regional Climate Model
- John A. Pyle** 285
Chemical, Dynamical, and Radiative Interactions Through the Middle Atmosphere and Thermosphere
- Dale A. Quattrochi** 287
Project ATLANTA (ATlanta Land use ANalysis: Temperature and Air quality)
- John O. Roads** 292
Variability and Predictability of Land-Atmosphere Interactions: Observational and Atmosphere Interactions: Observational and Modeling Studies
- Richard B. Rood** 294
The Development and Use of a Four-Dimensional Atmospheric-Ocean-Land Data Assimilation System for EOS
- Cynthia Rosenzweig** 2987
Impacts of Interannual Climate Variability on Agricultural and Marine Ecosystems and Fisheries
- D. Andrew Rothrock** 300
POLar Exchange at the Sea Surface (POLES)

- David S. Schimel** 302
Using Multi-Sensor Data to Model Factors Limiting Carbon Balance in Global Arid and Semiarid Land
- Mark R. Schoeberl** 304
Investigation of the Chemical and Dynamical Changes in the Stratosphere
- Christopher A. Shuman** 306
Interdisciplinary Determination of Snow Accumulation Patterns on the Greenland Ice Sheet: Combined Atmospheric Modeling and Field and Remote Sensing Studies
- W. James Shuttleworth** 308
Influence of Subgrid-Scale Heterogeneity on Remotely-Sensed Surface Temperature
- David A. Siegel** 277
Development and Application of the Next Generation of Ocean Color Models for the Understanding of Marine Processes on Regional and Global Scales
- Ronald B. Smith** 312
Climate Change and Human Response in the Semi-arid Near East
- Joao V. Soares** 314
Thomas Dunne
Long-Term Monitoring of the Amazon Ecosystems Through EOS: From Patterns to Processes
- Meric Srokosz** 317
Middle And High Latitude Oceanic Variability Study (MAHLOVS)
- Graeme Stephens** 320
Water Vapor in the Climate System
- Byron D. Tapley** 323
Earth System Dynamics: The Determination and Interpretation of the Global Angular Momentum Budget Using EOS
- Ina Tegen** 326
Modeling of Distribution and Interannual to Interdecadal Variations of Aerosols
- Owen B. Toon** 328
The Role of Natural and Anthropogenic Aerosols in Earth's Radiation Budget and Climate: Microphysical Simulations with the NCAR Community Climate Model
- John J. Walsh** 330
A Numerical Analysis of New Nitrogen Sources of NO₃ and N₂ Affecting Carbon Cycling in the Southern Caribbean Sea: A Key to CDOC Contamination of Satellite Color Signals
- Bruce A. Wielicki** 333
An Interdisciplinary Investigation of Clouds and the Earth's Radiant Energy System: Analysis (CERES-A)
- Eric F. Wood** 335
Terrestrial Hydrology and Climate Studies Using EOS-Era Data

Coupled Atmosphere-Ocean Processes and Primary Production in the Southern Ocean

Principal Investigator – **Mark Abbott**

Science Background

The Southern Ocean plays a critical role in the physical and biogeochemical dynamics of the ocean/atmosphere system through its role in carbon cycling and heat exchange with the atmosphere. The Antarctic Circumpolar Current, which links all of the major ocean basins, regulates the oceanic component of the southward/poleward heat flux. Most ventilation of the deep ocean occurs in the Southern Ocean where density layers outcrop at the sea surface. Through cooling, mixing, and sea-ice formation, new water masses are produced, which sink into the ocean interior and replenish the deep and intermediate waters of the global ocean.

Carbon fluxes in the Southern Ocean are a significant component of the global carbon cycle. Since individual subsystems within the Southern Ocean can act as either sources or sinks of carbon dioxide, and our sampling is so poor, it is not known if the region as a whole is a source or sink for atmospheric carbon dioxide. Measurements of carbon dioxide in the atmosphere and in the upper ocean suggest that the Southern Ocean is one of the primary sinks for atmospheric carbon dioxide. Yet recent models suggest that the Southern Hemisphere has no net uptake of carbon dioxide by the ocean. One explanation for this discrepancy between field measurements and modeling is the sparse sampling in the Southern Ocean. As this region is noted for its intense spatial and temporal variability in nearly all processes, it is possible that either the field measurements are not sampling these processes adequately or that the models have not resolved them.

Of perhaps greater importance, processes in the Southern Ocean that regulate carbon fluxes are especially sensitive to the impacts of climate change. Numerical models suggest that subtle latitudinal shifts in the core of the westerly winds will greatly affect processes related to intermediate-water formation and hence ocean circulation. Changes in water vapor transport can affect air/sea fluxes, thus impacting the rate of deep convection and deep-water ventilation. Such changes in atmospheric forcing will have complex feedbacks with sea-ice formation which, in turn, impact deep-water formation and stratification.

Our research focuses on the dynamics of the Southern Ocean and how changes in atmospheric forcing and

ocean circulation regulate the growth rates, abundances, and distributions of phytoplankton. Our approach is based on a foundation of satellite- and field-data analysis and data-assimilation models that will provide a predictive capability to understand the response of the Southern Ocean ecosystem to climate change. Our focus is on the large meanders of ocean fronts in the Antarctic Polar Frontal Zone (APFZ) and their impacts on secondary circulation and their time-dependent impacts on chlorophyll concentrations and primary productivity. The ecosystem in the APFZ behaves much like a coastal upwelling system which is characterized by episodic diatom blooms. These blooms result in high rates of new production, high preservation rates of biogenic silica, and relatively low vertical flux of particulate biogenic material. However, the APFZ has carbon burial rates that are about 3-to-5 times those of the Equatorial Pacific, and, during glacial periods, these burial rates were nearly 20 times those of the Equatorial Pacific. The lack of meridional barriers leads to a recirculation of diatoms associated with frontal meanders. Phytoplankton alternately upwell and then downwell in these meanders, creating a helical circulation path. Such bloom events may be unimportant in the total productivity of the system but play a disproportionate role in carbon fluxes. The critical element in this process is mesoscale variability in ocean circulation. Mesoscale processes are closely linked to both topographic and wind-stress forcing. Thus, changes in atmospheric forcing may significantly affect this important region of the world ocean.

Our approach is to combine field observations, analysis of various satellite data sets, and numerical modeling to study this set of ocean and atmosphere processes. The tight coupling between ocean physics and biology in the APFZ requires such a multi-faceted approach, as well as multiple data sets that will be available in the EOS era. The APFZ is an important component of the Southern Ocean, both in terms of biogeochemistry and ecosystem function. Shifts in the patterns of wind stress or sea-ice formation will change ocean circulation in the APFZ, which in turn will affect primary productivity. The APFZ is thus especially sensitive to climate change. The intense mesoscale variability (Rossby radius on the order of 15 km) and the storminess of the region requires a combination of observing strategies in order to resolve the critical scales.

Science Goal

Our focus is to develop coupled physical/biological models that can eventually be used in a predictive mode to understand the effects of changes in physical forcing of the ocean.

Current Activities

Our current activities are divided into modeling, satellite-data analysis, and field measurements. We have developed and implemented a 1/6°-resolution circulation model of the Southern Ocean. This model now runs with full and accurate eddy dynamics to provide a good simulation of mesoscale processes. We have developed a robust model of the upper ocean ecosystem, using data-assimilation techniques to tune the model parameters. This model is now being coupled with the mixed-layer model which is part of the high-resolution circulation model. We also are continuing our research on isopycnal circulation models, and the development of state-of-the-art techniques in ocean-data assimilation.

In the area of satellite-data analysis, we have mapped the path of the Polar Front using 10 years of sea-surface temperature imagery from the AVHRR Pathfinder data set. The intensity of meandering (and hence vertical circulation) is damped where gradients in planetary potential vorticity are large, such as near ocean ridges. We are reanalyzing air/sea heat and freshwater fluxes from various general circulation models and comparing them with satellite passive microwave radiometer measurements. These improved data sets will be used to force the circulation model. Lastly, we have combined altimeter and AVHRR data to estimate the ocean circulation field. These data have been compared with model results as well.

Our field work is focused on the impacts of mesoscale processes on phytoplankton biomass and primary productivity. Bio-optical drifters have been deployed in Drake Passage and in the APFZ. The first deployments in Drake Passage revealed the importance of small, mesoscale eddies in supplying nutrients to the upper ocean. The second deployments in the APFZ revealed large meanders in the Polar Front and the dramatic impacts of bottom topography on the Antarctic Circumpolar Current. Our primary focus is now on the U.S. Joint Global Ocean Flux Study (JGOFS) in the APFZ, where we will deploy moorings and drifters as well as high-resolution ship surveys of the biological and physical processes.

Use of Satellite Data

Satellite data are used in several ways in this program. First, analysis of specific data sets through the use of long time series and ensembles of specific processes helps guide model development. For example, if a particular relationship between phytoplankton biomass and wind stress curl is apparent, can the models reproduce this be-

havior? Second, data are used to validate model output and quantify model accuracy. In essence, data analysis will provide the control points with which to evaluate the progress of the model development activities. Third, data are assimilated into a variety of predictive models ranging from limited process models to comprehensive ocean/atmosphere models.

We rely on all of the ocean-related satellite sensors. TOPEX/Poseidon and the EOS radar altimeter will be used to study large-scale changes in ocean circulation. Coupling the EOS altimeter data sets with other altimeter data (such as Geosat Follow-On) will allow us to construct higher resolution circulation fields to study mesoscale processes. Infrared observations from MODIS and the NOAA infrared imagers will be used to study sea-surface temperature for studies of air/sea fluxes. Coupled infrared/altimeter observations will be used to calculate high-resolution ocean circulation fields. Scatterometers (SeaWinds and the ESA scatterometer series) will provide measurements of the basic wind-forcing fields. Higher level fields, such as wind stress curl, provide critical information for models of ocean circulation. Passive microwave radiometer (SSM/I and AMSR-E on EOS) measurements are to be used to calculate latent heat fluxes. These data will be combined with observations from CERES to improve estimates of boundary-layer fluxes.

We will rely on MODIS (as well as other ocean color sensors such as SeaWiFS, OCTS, MERIS, and GLI) to provide basic information on ocean biological processes. These sensors will be used to estimate phytoplankton abundance as well as growth rates (based on models that incorporate biomass, fluorescence, and incoming solar radiation). Concentrations of dissolved organic matter (derived from MODIS) are an essential component of upper ocean carbon cycling. MODIS-derived estimates of water transparency will be combined with estimates of air/sea heat and momentum fluxes to calculate mixed-layer depths.

These data sets, when combined with a suite of assimilation models, will allow us to investigate the effects of a changing environment on the structure and functioning of the upper ocean ecosystem. We expect that large-scale changes, such as decreasing stratospheric ozone (which will increase surface UV radiation) and changing patterns of wind forcing as a result of climate change, will greatly affect the patterns of upper-ocean heat flux and carbon cycling. Our models will enable us to systematically examine the response of the upper ocean to these changes, and these predictions will be made with known error bounds.

Participation in Field Programs

Using funding from the National Science Foundation and NASA/EOS, we will participate in the JGOFS Antarctic Environment Southern Ocean Process Study (AESOPS). We will deploy twelve bio-optical moorings in the APFZ

at 60°S, 170°W. These moorings will provide a time record of phytoplankton biomass, productivity, and ocean circulation for six months. Thirty drifters will also be deployed to study the surface divergence field and its impact on phytoplankton. High-resolution ship surveys will map the vertical structure of the physical/biological fields around the mooring array, and surface silica production rates will also be measured. Together, these in situ data will be combined with available satellite data to provide a view of the three-dimensional mesoscale fields in the APFZ and how they vary in time. These data will be crucial for evaluation of the coupled biological/physical model. We expect to continue a reduced set of mooring deployments in collaboration with Australian researchers.

Principal Investigator **Mark Abbott**

Mark Abbott has been involved in the fields of oceanography and ecology for 12 years. He received his undergraduate degree in Conservation of Natural Resources from the University of California—Berkeley, and a Ph.D. in Ecology from the University of California—Davis. He has been affiliated with Oregon State University since 1988, currently as Professor in the College of Oceanic and Atmospheric Sciences. Dr. Abbott has served on numerous EOS-related committees, including the EOS Science Executive Committee and the Moderate-Resolution Imaging Spectroradiometer (MODIS) Panel. His research interests include studies of coupled biological/physical processes in the upper ocean and phytoplankton photosyntheses. He has been selected as a MODIS Team Member, and currently chairs the Committee on Earth Studies of the National Research Council.

Co-Investigators

John Moisan - *Long Island University*

Leonard J. Walstad - *University of Maryland*

The following are from Oregon State University:

Andrew Bennett
Timothy J. Cowles
Dudley B. Chelton
Roland deSzoeki
Steven Esbensen
Michael Freilich
David Nelson
Cynthia Paden
James Richman
P. Ted Strub
Richard Walstad

References

- Abbott, M.R., and R.M. Letelier, 1997: Going with the flow—The use of drifters to study phytoplankton dynamics. *Monitoring Algal Blooms: New Techniques for Detecting Large-Scale Environmental Change*, M. Kahru and C. Brown, Eds., R.G. Landes Co., New York, 145-170.
- Bennett, A.F., B.S. Chua, and L.M. Leslie, 1996: Generalized inversion of a global numerical weather prediction model. *Meteorol. Atmos. Physics*, **60**, 165-178.
- Bennett, A.F., B.S. Chua, and L.M. Leslie, 1997: Generalized inversion of a global numerical weather prediction model II: analysis and implementation. *Meteorol. Atmos. Physics*, **62**, 129-140.
- Bennett, A.F., B.S. Chua, D.E. Harrison, and M.J. McPhaden, 1998: Generalized inversion of Tropical Atmosphere-Ocean (TAO) data and a coupled model of the tropical Pacific. *J. Climate*, **11**, 1768-1792.
- Chelton, D.B., R. de Szoeki, and others, 1998: Geographical variability of the first baroclinic Rossby radius of deformation. *J. Phys. Oceanogr.*, **28**, 433-460.
- Higdon, R.L., and R.A. de Szoeki, 1997: Barotropic-baroclinic time splitting for ocean circulation modeling. *J. Comp. Phys.*, **135**, 30-53.
- Letelier, R.M., M.R. Abbott, and D.M. Karl, 1997: Chlorophyll natural fluorescence response to upwelling events in the Southern Ocean. *Geophys. Res. Lett.*, **24**, 409-412.
- Moore, J.K., M.R. Abbott, and J.G. Richman, 1997: Variability in the location of the Antarctic Polar Front (90° W to 20° W) from satellite sea surface temperature data. *J. Geophys. Res.*, **102**, 27,825-27,833.
- Moore, J.K., M.R. Abbott, and J.G. Richman: Location and dynamics of the Antarctic Polar Front from satellite sea surface temperature data, *J. Geophys. Res.*, in press.
- Spitz, Y.H., J.R. Moisan, M.R. Abbott, and J.G. Richman, 1998: Data assimilation and a pelagic ecosystem model: Parameterization using time series observations. *J. Mar. Systems*, **16**, 51-68.

Validation of MODIS Primary Productivity Algorithms

Principal Investigator – Kevin R. Arrigo

Science Background

Human activities such as fossil-fuel burning and deforestation have led to a marked increase in atmospheric CO₂ concentrations during the last century. However, only a portion of the CO₂ released from these and other related processes has remained in the atmosphere; the rest has entered the oceans and the terrestrial biosphere. Unfortunately, the capacity of the oceans to take up additional CO₂ is not well understood, a fact which underscores our need to better understand the global carbon (C) cycle. An important component of the oceanic C cycle is the so-called “biological pump.” Simply put, the biological pump is controlled by the activity of phytoplankton, which take up CO₂ during photosynthesis. Phytoplankton grow near the ocean surface where light is most abundant. Consequently, their removal of CO₂ from surface waters (primary productivity) helps to maintain a CO₂ gradient between the ocean and the atmosphere allowing additional CO₂ to diffuse into the ocean from the atmosphere. As the phytoplankton cells die or are grazed, their biomass may sink to great depths, potentially removing this C from the atmosphere for thousands of years.

The efficiency of the biological pump depends on the magnitude of primary productivity as well as the rate of removal of this fixed C from surface waters to depth. The more CO₂ the phytoplankton take up and the faster their biomass sinks from the ocean surface, the stronger the ocean/atmosphere gradient will be. It has been suggested, however, that because phytoplankton appear to be in steady state on timescales longer than a year, they play little if any role in the global C cycle. Steady-state populations of phytoplankton would be unable to ameliorate increasing atmospheric CO₂ concentrations since they would have no added capacity to take up additional CO₂.

Unfortunately, there is not nearly enough in situ primary productivity data available to assess, at global spatial scales and interannual time scales, whether the annual cycle of phytoplankton growth is in steady state or not. What is needed is a long time series of globally-synoptic estimates of primary productivity; estimates which can best be generated from satellite observations of a number of relevant oceanic parameters, including ocean color (an indicator of phytoplankton biomass), sea-surface temperature (controls algal growth rates and may be used as

an indicator of nutrient supply), wind speed (determines mixed layer depths), cloud cover (controls light levels), and sea-ice distributions (important for determining ocean surface area in polar regions). These parameters are being used in a variety of algorithms to estimate primary productivity over large spatial scales. Our need to understand the temporal and spatial variability in rates of oceanic primary productivity is the main reason why this parameter was selected as one of the MODIS-Ocean Level 2 data products. However, the accuracy of these algorithms must be rigorously assessed by comparing algorithm-derived primary productivity estimates with in situ estimates at the same time and location. At the present time, no investigators associated with either SeaWiFS or MODIS are responsible for this type of crucial primary productivity algorithm validation.

Science Goals

The primary objective of this work will be to evaluate the daily SeaWiFS/MODIS Primary Productivity Algorithm(s) by performing a global point-by-point comparison between in situ primary productivity measurements and the output of the SeaWiFS/MODIS Primary Productivity Algorithm(s). This would fill a serious gap in the MODIS-Ocean validation effort.

Related objectives of this proposal include:

- Making matched satellite and in situ primary productivity data available to the community via an internet-accessible database
- Quantification of regional differences in global primary productivity algorithm performance
- Tracking of primary productivity algorithm performance over time
- Quantification of errors in primary productivity estimates
- Comparison and intercalibration of primary productivity estimates from different ocean color platforms
- Constant re-evaluation of primary productivity algorithms (both old and new).

Current Activities

- In situ primary productivity data are being collected, quality controlled, and archived for algorithm validation purposes
- Primary productivity 'maps' are being generated from Level 2 or 3 ocean color data (SeaWiFS initially, then MODIS) using the SeaWiFS/MODIS Primary Productivity Algorithm(s)
- Software to perform productivity "match-ups" between in situ measurements and algorithm output is being developed
- Productivity algorithm performance will be critically evaluated according to the criteria outlined in the MODIS-Ocean Validation Plan

Participation in Field Activities

As Principal Investigator (PI) on the NSF-funded ROAVERRS (Research on Ocean-Atmospheric Variability and Ecosystem Response in the Ross Sea) cruises to the Antarctic, I have been making a variety of high-latitude data available to the MODIS validation effort, in terms of validating both phytoplankton biomass and satellite-derived estimates of primary productivity. The first cruise took place from December 1996 through January 1997 and the second cruise from December 1997 through January 1998. The final cruise was planned for November through December 1998.

Bio-optical characterization of the water column. Light transmission through the water column is measured using the PRR 600 Spectroradiometer. This instrument measures downwelling irradiances and upwelling radiances at 412, 443, 490, 510, 555, and 665 nm and measures downwelling photosynthetically active radiation (PAR) and upwelling natural fluorescence. The optical characteristics of Antarctic waters are determined by absorption by both phytoplankton pigments and chromophoric dissolved organic matter (CDOM) and detritus. The degree to which phytoplankton pigments are packaged within the cell is also an important consideration. We are using measured particulate absorption spectra in conjunction with estimates of pigment concentrations (via High Performance Liquid Chromatography [HPLC]) to determine the absorption characteristics of the various phytoplankton assemblages we observe. Detrital absorption is measured using the Kishino method. Assemblages are characterized by taxonomic analyses. CDOM absorption spectra are determined spectrophotometrically from water samples we collect during the cruises. The relative influence of phytoplankton pigments and CDOM on the observed light field is determined for a variety of water types (e.g., high vs. low algal biomass, Phaeocystis vs. diatom dominance).

Ocean color calibration/validation. Satellite sensors designed to measure concentrations of phytoplankton pig-

ments in surface waters (e.g., MODIS, SeaWiFS, ADEOS/OCTS) must be calibrated and validated regionally. To do this we are characterizing and measuring the optical constituents within the water column and relating these to measured downwelling irradiances and upwelling radiances at 6 wavelengths. Water-leaving radiances at each wavelength are calculated from vertical light profiles and are related to the amount of absorbing material in the surface waters (e.g., algal pigments and CDOM concentrations). The relationships between surface chlorophyll, CDOM, and water-leaving radiance are used to fine-tune algorithms designed to measure these quantities from space. This allows the production of accurate high-resolution maps of surface chlorophyll within our study area from SeaWiFS/MODIS imagery.

Phytoplankton distributions determined from satellite imagery will be used to fill in the spatial and temporal gaps in our ROAVERRS sampling grid and will be used to help interpret other measurements, including hydrography, pCO₂, dimethyl sulfide concentrations, particle flux, and sediment chlorophyll, faunal abundance, and productivity.

Phytoplankton productivity. During ROAVERRS, primary productivity is calculated in a variety of ways to determine the most appropriate and efficient method. Standard simulated in situ (on-deck) incubations are performed along the 76° 30' S and 75° S transects. Photosynthesis versus irradiance incubations are also performed at these same sites and at numerous others and are being used in conjunction with in situ radiometric data to estimate depth-integrated primary production. Two more experimental approaches also are being tested to determine their appropriateness in the Antarctic environment. Vertical profiles of natural fluorescence have been shown to be a promising technique for estimating primary production at high spatial resolution. Estimates of productivity calculated by this method will be compared to standard methods to determine its efficacy. Finally, ¹⁴C-labeled pigments should provide an estimate of algal growth rate which can be used to estimate rates of production. Productivity estimates will be used to constrain bio-optical primary productivity models currently being developed.

Principal Investigator

Kevin R. Arrigo

Kevin R. Arrigo is a biological oceanographer with the Oceans and Ice Branch at NASA/Goddard Space Flight Center. He received his Ph.D. in biological oceanography from the University of Southern California in 1992 working with Cornelius W. Sullivan on sea-ice ecosystems in the Southern Ocean. After graduation, he came to NASA/GSFC under a Department of Energy Global Change Distinguished Post-Doctoral Fellowship to work with Charles R. McClain and Josephino C. Comiso, between 1992 and 1994. In 1994 he received a faculty ap-

pointment as Assistant Research Scientist at the Joint Center for Earth System Science, Department of Meteorology, University of Maryland. In 1995, he was hired by NASA/GSFC where he is now employed. His area of emphasis has been the study of biogeochemical processes in the Southern Ocean, particularly the Ross Sea, using in situ measurements, numerical modeling, and satellite remote sensing. His most-recent activities have dealt with the use of CZCS, OCTS, SeaWiFS, and SSM/I data to study the interactions between primary production and sea-ice distribution in the Southern Ocean.

Co-Investigator

Paul Falkowski - *Rutgers University*

Dale Robinson - *Rutgers University*

References

Arrigo, K.R., A. Schnell, D.L. Worthen, and M.P. Lizotte. 1998: Primary production in Southern Ocean waters. *J. Geophys. Res.*, **103**, 15,587-15,600. U.S. JGOFS Contribution Number 459.

Behrenfeld, M.J., and P.G. Falkowski, 1997: Photosynthetic rates derived from satellite-based chlorophyll concentration. *Limnol. Oceanogr.*, **42**, 1-20.

Behrenfeld, M.J., and P.G. Falkowski, 1997: A consumer's guide to phytoplankton primary productivity models. *Limnol. Oceanogr.*, **42**, 1479-1491.

Antoine, D., J.M. Andre, and A. Morel, 1996: Oceanic primary production 2. Estimation at global scale from satellite (coastal zone color scanner) chlorophyll. *Global Biogeochem. Cycles*, **10**, 57-69.

Longhurst, A., S. Sathyendranath, T. Platt, and C. Caverhill, 1995: An estimate of global primary production in the ocean from satellite radiometer data. *J. Plankton Res.*, **17**, 1245-1271.

Water Transport to the Upper Troposphere by Convective Systems, as Inferred from Global Lightning Data

Principal Investigator – **Marcia Baker**

Science Background

Water in the upper troposphere (UT) is supplied largely by vertical advection in convective systems. The climatology and composition (liquid-to-ice ratio) of this convective water flux are poorly known and difficult to monitor directly.

We have proposed an exploratory study of the distribution of this flux in space and time, as inferred from satellite observations of lightning flashes. The proposed method is based on physical reasoning, numerical modeling, and in situ observations that suggest a strong correlation between the rate of water lofting in a convective thunderstorm and the lightning flash rate from the storm, particularly in continental locations.

Science Goals

The goal of this investigation is to make estimates of the climatology of liquid water and ice fluxes to the UT from satellite lightning data. The focus will be on continental storms. The condensate data will be useful as a source term for stratiform anvils where horizontal advection of condensate from convective cells accounts for 60-75% of the stratiform condensate.

Current Activities

Mass flux, water content, and lightning observational data are being used together with our 1.5-dimensional numerical thunderstorm model to investigate the vertical water flux—lightning flash rate correlations. Current investigations are utilizing data collected at the New Mexico (1984) and Convection and Precipitation Electrification (CaPE) (1991) field projects. From this combination of observations and model results, we will develop regional algorithms relating flash rate to the water fluxes in these regions and will expand the study to other continental regions where lightning is commonly present.

The results will be compared with published climatologies and independent modeling studies.

The numerical model utilizes cloud dynamics, a simple representation of turbulent mixing and entrainment, explicit microphysics, electrification, and a lightning parameterization to model a single-cell thunderstorm. The

lightning parameterization is being expanded to include the impacts of microphysics on lightning initiation based on the results of our recent theoretical study of lightning initiation from hydrometeors.

Use of Satellite Data

Global lightning data are being acquired by both the Optical Transient Detector (OTD) aboard the Microlab-1 satellite as well as the Lightning Imaging Sensor (LIS) on the TRMM observatory. Both instruments are able to give estimates of the flash rates of storms they observe. Using the appropriate regional algorithm, these flash rates will then be used to produce a regional map of estimated water flux in each season.

Participation in Field Programs

We plan to participate in the Cloud Electrification Studies using Aircraft and Radar (CESAR) project now being planned for the year 2000.

Principal Investigator

Marcia Baker

Marcia Baker received her Ph.D. in Physics from the University of Washington in 1971 and is a Professor of Atmospheric Sciences and Geophysics at the University of Washington. She and her students have worked on various aspects of cloud physics. These include projects concerning the role of entrainment in modifying cumulus cloud properties, aerosol impacts on the albedo of marine stratocumulus, laboratory, and numerical studies of ice particle microphysics, and theoretical, laboratory and field studies of cloud electrification. She is a Fellow of the American Meteorological Society.

References

- Baker, M., H. Christian, and J. Latham, 1995: *Quart. J. Roy. Meteor. Soc.*, **121**, 1525-1549.
- Gamache, J.F., and R.A. Houze, 1983: Water budget of a Mesoscale Convective System in the Tropics. *J. Atmos. Sci.*, **40**, 1835-1850.

Schroeder, V., M.B. Baker, and J. Latham, 1998: Corona initiation from colliding hydrometeors. *Quart. J. Roy. Meteor. Soc.*, submitted.

Solomon, R., and M.B. Baker, 1996: *J. Geophys. Res.*, **101**, 14983-14990.

Solomon, R., and M.B. Baker, 1998: *J. Geophys. Res.*, in press.

Udelhofen, P., and D.L. Hartmann, 1995: The influence of tropical cloud systems on the relative humidity in the upper troposphere. *J. Geophys. Res.*, **100**, 7423-7440.

Investigation URL

<http://www.geophys.washington.edu/Surface/Atmospheric/>

Global Water Cycle: Extension Across the Earth Sciences

Principal Investigator – **Eric J. Barron**

Science Background

This Interdisciplinary Science Investigation focuses on the global water cycle to determine the scope of its interactions with all components of the Earth system, and to understand how it stimulates, regulates, and responds on both global and regional scales. The primary research strategy involves generating a hierarchy of simulation models—from general circulation models of the atmosphere, to mesoscale models, to basin-scale hydrologic models—and validating them against EOS and other global observational data. The coarse spatial resolution of current global climate models is frequently cited by the U.S. Global Change Research Program (USGCRP) as one of the major limitations in global-change predictions.

The hierarchy of models, in conjunction with EOS observations, will make it possible to extend the predictive capability across a wide spectrum of spatial scales for different regions of the Earth's surface. The EOS observations will contribute to the development of an improved understanding of key processes, including cloud cover and radiative transfer characteristics, and energy and moisture fluxes at the interface of the atmosphere with the oceans, cryosphere, and land surface.

Science Goals

The goals are to simulate future climate change on a global scale and, through coupling or "nesting" with higher spatial resolution models, to develop predictions of climate change on the scales appropriate to human activity. In linking climate and hydrologic forecast models, this investigation also strives to address a critical area of uncertainty—changes in the water balance associated with natural variability and climate change. The intent is to produce regional-scale predictions of changes in water balance and river flow as a function of climate change. Such predictions are characterized by many uncertainties, and initially the investigation may only produce a better assessment of the areas of uncertainties in producing regional-scale predictions. However, this understanding will undoubtedly lead to a better capability to do high-resolution climate-model predictions on a global scale.

Current Activities

The focus of this effort is currently on the Susquehanna River Basin of Pennsylvania, but the methodology is being developed for applications for any region of the globe. Near-term plans include the Ohio River Basin and the Tennessee River Basin. These efforts will allow us to contribute significantly to the GEWEX Continental International Project (GCIP) centered within the Mississippi Valley. Future research efforts will expand to additional regional foci, including oceanic and polar regions.

Use of Satellite Data

ASTER and MODIS surface radiance, reflectance, surface temperature, and vegetation measures will provide inputs for the soil, vegetation, and atmosphere models (SVATs) to be used in the model predictions of energy and water fluxes. A major focus of the investigation will be improved cloud parameterizations in mesoscale and global atmospheric models, for which CERES and MISR measurements will be a key for both cloud properties and cloud radiative transfer.

EOS PM observations such as temperature, humidity, and precipitable water profiles from AIRS, AMSU, and HSB will be utilized in model development and later as a part of a regional 4-dimensional assimilation and global analysis of multiphase water and temperature and diabatic heating.

Scatterometry from SeaWinds will aid substantially in the determination of air/sea energy and moisture fluxes, and GLAS altimetry will be of considerable significance in assessing model predictions of ice-sheet mass balance.

Participation in Field Programs

Participation in two field programs has added an important element to model development and validation. Participation in the CaPE Experiment (Convection and Precipitation Electrification) focused on methods to diagnose large-scale land and atmosphere water budget components with the objective of applying these techniques over regional-scale areas in conjunction with GEWEX. MAC (Multi-sensor Airborne Campaign) Hydro '90 was conducted over the Mahantango watershed in Pennsylvania,

the central test area for this investigation. The objective of the campaign was to improve our ability to remotely determine the near-surface soil moisture.

The development and verification of the nested hierarchy of simulation models is strongly tied to field programs, such as MAC Hydro and CaPE.

Co-Investigators

Bruce Albrecht - *University of Miami*

John Christy - *University of Alabama Huntsville*

Steven Goodman - *NASA/Marshall Space Flight Center*

Timothy Miller - *NASA/Marshall Space Flight Center*

Franklin (Pete) Robertson - *NASA/Marshall Space Flight Center*

Thomas Warner - *National Center for Atmospheric Research*

Peter Webster - *University of Colorado*

The following are from Pennsylvania State University:

Thomas Ackerman

Richard Alley

Toby Carlson

Robert Crane

Thomas Gardner

Lee Kump

Arthur Miller

Gary Petersen

Donna Peuquet

Rudy Slingerland

Brent Yarnal

References

Capehart, W.J., and T.N. Carlson, 1997: Decoupling of surface and near-surface soil water content: A remote sensing perspective. *Water Resour. Res.*, **33**, 1383-1395.

Carlson, T.N., and D.A.J. Ripley, 1997: On the relation between NDVI, fractional vegetation cover, and leaf area index. *Remote Sens. Environ.*, **62**, 241-252.

Christy, J.R., R.W. Spencer, and W.D. Braswell, 1997: How accurate are satellite 'thermometers'? *Nature*, **389**, 342-343.

Jenkins G.S., and E.J. Barron, 1997: Global climate model and coupled regional climate model simulations over the Eastern United States: GENESIS and RegCM2 simulations. *Glob. and Planet. Change*, **15**, 3-32.

Lakhtakia, M.N., B. Yarnal, D.L. Johnson, R.A. White, D.A. Miller, and Z. Yu, 1998a: A simulation of river-basin response to mesoscale meteorological forcing: The Susquehanna River Basin Experiment (SRBEX). *J. Am. Water Resour. Assoc.*, in press.

Investigation URL

<http://www.essc.psu.edu>

Interdisciplinary Studies of the Relationships Between Climate, Ocean Circulation, Biological Processes, and Renewable Marine Resources

Principal Investigator – **Ian J. Barton**
International Sponsor – **Australia**

Science Background

The CSIRO Marine Laboratories employs physical, chemical, and biological oceanographers and fisheries scientists in its new Division of Marine Research. The recent amalgamation of the Divisions of Fisheries and Oceanography has strengthened the interaction between these scientists, especially in the fields of this Interdisciplinary Investigation. Funding for the Cooperative Research Center (CRC) at the University of Tasmania is now secure for the next six years, and the close collaboration between the CSIRO and the CRC continues. This investigation aims to integrate current and new research projects that use existing satellite data in a way that ensures the expected benefit from the application of the data to flow through the EOS program. The projects will benefit from the Laboratories' substantial capability in satellite-data acquisition and processing. This capability includes L- and X-band direct data reception coupled with the ability to process these data in near-real-time.

In its initial phases, the investigation was largely observationally based, but now the activities are being complemented by the use of numerical models that can assimilate EOS remotely sensed and other data. Satellite data from current and future programs will be used to develop tools for the management of Australia's Exclusive Economic Zone (EEZ). These will be available for use by resource managers in studies of a wide variety of problems, including pollution, dispersion of fish and pest larvae, and search and rescue. They will be used for Goals 2 and 3 below of our EOS Interdisciplinary Investigation. A second global model is used to study the Indian Ocean, and is intended to become part of a global coupled model (in collaboration with other Australian institutions) for studying climate change and variability, with particular emphasis on the Australian region. It will be used to further our work on Goals 1 and 3 below.

Science Goals

We have three goals:

- 1) To improve the quantification of air-sea interaction and oceanic heat storage, for the purposes of determining the ocean's role in climate variability and change. EOS satellite data are imperative to extend these studies to regional and global scales
- 2) To examine the carbon cycle in the waters surrounding Australia and its influence on the global carbon cycle.
- 3) To address the implications of interannual variability and long-term change in the regional oceanography for marine ecosystems, and commercial fisheries in particular.

Current Activities

Recent activities have included:

- Continuing validation of satellite-derived products using ground-based data. These include the verification of TOPEX/Poseidon sea levels using tide gauges in northern Tasmania and the Pacific and Indian Oceans, sea-surface temperature using ship-borne radiometers, and ocean-color products using a suite of ship instruments.
- Validation of net heat flux measurements during TOGA-COARE by explicit ocean heat budget closure, to an accuracy of better than 10 W/m^2 over a few days (Godfrey et al., 1998). These activities have now extended to studies over the tropical Indian Ocean.
- Optimal interpolation techniques have been developed for application to NOAA/NASA Pathfinder SST data sets. These techniques are being further developed to allow interpolation in both space and time for combined altimeter and SST data sets. Analyzed data will be ap-

plied to studies of the East Australian and Leeuwin Currents.

- Participation in the TOPEX Extended Mission to use altimeter and other satellite data to improve our understanding and prediction of climate variability and change in the Australian region.
- Completion of several deep hydrographic sections for the World Ocean Circulation Experiment (WOCE), including seven from Tasmania to Antarctica. Thirty occupations of a high-density expendable bathythermograph (XBT) line between Tasmania and Antarctica have been obtained since 1992.
- Continuation of a series of voyages to determine the spatial and temporal variability in carbon sources and sinks in the Southern Ocean.
- Three ocean-color/optics voyages have been completed in the Southern Ocean. These studies will be used to relate remotely sensed data to measurement of ocean biological and production parameters, as well as to assist in the development of primary production models. Such models are being developed using historic CZCS data as well as the new data from SeaWiFS. A regular coastal ocean-color ground-truth collection program has commenced. These measurements will also assist in the assimilation of MODIS ocean-color data into carbon-cycle models.
- Development of a new research program into impacts of climate variability in marine ecosystems and fisheries, making use of ongoing field research in southeastern Australia and northern Australia.
- Development of techniques to assist in the understanding and management of Australia's Exclusive Economic Zone. This includes techniques for assimilating altimeter and other satellite data into numerical models. Preliminary results indicate that combining satellite data from altimeters, scatterometers, and AVHRR-type instruments should revolutionize our ability to keep track of the copious eddies found around Australia. We anticipate that this project will provide a major integrating tool for the work of the Marine Laboratories.
- Development of "synthetic XBTs," in which we use XBT data along existing lines in the Indian Ocean to estimate temperature anomaly profiles from surface steric height and SST alone. It is proposed to use these to complement the (very sparse) XBT data set throughout the Indian Ocean, using altimeter and AVHRR data.
- Use of optimal interpolation techniques in the development of sea-level maps (and associated synthetic XBTs) in the eddy-rich Tasman and Coral Sea region, for use in understanding, modeling, and management of the EEZ in this region.
- Use of CSIRO-generated AVHRR maps in studies of interannual variability of current systems around Australia, and in the application of SST and ocean color to commercial fisheries.
- Analysis of seasonal and interannual variation in the low-resolution historical CZCS pigment data for the Australian region has been essentially completed. A similar analysis of the high-resolution data for the areas of the East Australia and Leeuwin currents is planned. These data will now be complemented by locally received SeaWiFS data. CZCS pigment data are also being used to model seasonal variability in the Southern Ocean carbon cycle.
- Data from geostationary and polar-orbiting satellites have been used to map solar radiation in Australian ocean regions including fields of UV-B radiation for biological studies.
- Southern Ocean Assimilation modeling, aimed at assimilating the time-varying TOPEX/Poseidon altimeter data into a prognostic primitive equation model, and diagnosing the role of eddies on the transport of momentum, heat, and freshwater. Our archive of AVHRR data will be used to assess the heat transport of eddies in the East Australian Current.
- Development of improved techniques for the derivation of SST from satellite data. These studies are combined with a joint validation study with the Australian Institute of Marine Sciences.

Use of Satellite Data

The development of the new models greatly increases our use of satellite data, particularly from AVHRR and from the TOPEX/Poseidon and ERS-1 altimeters. Our studies are also now using wind scatterometer data from ERS and other satellites. We so far work on a range of projects using remotely-sensed data:

Participation in Field Programs

Since 1990, the investigators in this study have led many voyages using the three research vessels based in Hobart; namely, the Franklin, Southern Surveyor, and Aurora Australis. Most recently these have included voyages to the tropical Indian Ocean and Indonesia to study ocean heat fluxes, voyages to the Southern Ocean for ocean-color/optical measurements, and regular hydrographic sections both in the Indian and Southern Oceans in support of WOCE and other international programs.

Principal Investigator

Ian J. Barton

Ian Barton graduated with B.Sc. and Ph.D. degrees from the University of Melbourne in 1972. He joined the CSIRO Division of Meteorological Physics the following year and worked on the use of airborne microwave radiometry to determine soil-moisture content. During a year at Oxford University, in 1979-80, as a Research Fellow, his attention turned to satellite data—especially the measurement of sea-surface temperatures from infrared radiometers. This initial sojourn at Oxford University saw the start of the European ATSR program, and subsequent extended visits to the Rutherford Appleton Laboratory in the UK during 1986 and 1993 consolidated the joint UK-Australia Program in ATSR. Ian Barton has published widely on the analysis and application of infrared satellite data, and he currently collaborates in the scientific programs of Japan's NASDA and Europe's ESA, as well as with NASA. The latter collaboration includes membership of the MODIS Science Team, where he has a responsibility for the development of algorithms for the determination of sea-surface temperatures.

Co-Investigators

Graeme Pearman - *CSIRO Atmospheric Research*

John Wilkin - *University of Auckland, New Zealand*

The following are from the Marine Laboratories of the Commonwealth Scientific and Industrial Research Organization:

John Church
George Cresswell
Peter Craig
Chris Fandry
Stuart Godfrey
Vince Lyne
Denis Mackey
Gary Meyers
John Parslow
Chris Rathbone
Ken Ridgway
Steve Rintoul
Bronte Tilbrook
Paul Tildesley
Susan E. Wijffels

The following are from the University of Tasmania:

Nathan Bindoff
Richard Coleman
Manuel Nunez
Jeorg Wolff

References

Barton, I.J., 1995: Satellite-derived sea surface temperatures: current status. *J. Geophys. Res.*, **100** (C5), 8777-8790.

Godfrey, J.S., R.A. House, R.H. Johnson, R. Lukas, J.-L. Redelsperger, A. Sumi, and R. Weller, 1998: The Coupled Ocean Atmosphere Response Experiment (COARE): an interim report. *J. Geophys. Res.*, in press.

Mackey, D.J., J. Parslow, H.W. Higgins, F.B. Griffiths, and J.E. O'Sullivan, 1995: Plankton productivity and biomass in the western equatorial Pacific: biological and physical controls. *Deep Sea Res.*, **42**, 499-533.

Michael, K.J., M. Nunez, and G.A. Meyers, 1994: Validation of tropical ocean-atmosphere heat fluxes from marine data against a satellite-based method. *Int. J. Climatology*, **14**, 429-437.

Nilsson, C.S., and P.C. Tildesley, 1995: Imaging of oceanic features by ERS 1 synthetic aperture radar. *J. Geophys. Res.*, **100**, 953-967.

Rintoul, S.R., J.-R. Donguy, and D. Roemmich, 1997: Seasonal evolution of upper ocean thermal structure between Tasmania and Antarctica. *Deep Sea Res.*, **44**, 1185-1202.

Walker, A.E., and J.L. Wilkin, 1998: Optimal averaging of NOAA/NASA Pathfinder satellite sea surface temperature data. *J. Geophys. Res.*, in press.

White, N.J., Coleman, R., Church, J.A., Morgan, P.J., and Walker, S.K., 1994: A southern hemisphere verification for the TOPEX/Poseidon satellite altimeter mission. *J. Geophys. Res.*, **99** (C12), 24505-24516.

Wilkin, J.L., J.V. Mansbridge, and J.S. Godfrey, 1995: Pacific Ocean heat transport at 24°N in a high resolution global model. *J. Phys. Oceanogr.*, **25**, 2204-2214.

Investigation URL

<http://www.marine.csiro.au>

River Flooding and Global Environmental Change: A Multi-Sensor Approach

Principal Investigator - **G. Robert Brakenridge**

Science Background

Extreme floods occur when the incoming water discharge to a river reach greatly exceeds the system's normal conveyance capacity. At such times, and along some but not all valley reaches, discharge cross-sections broaden to include extensive floodplains, tens of kilometers in width. This direct runoff component of the Earth's hydrological cycle can be directly observed and measured by a variety of orbital remote sensors.

Despite their direct effects on human affairs, the geographic location, extent, frequency, and magnitude of extreme river floods are poorly measured at present. Compared to meteorological data, international streamflow data sharing is far from complete, and flood peak discharges are either unmeasured or are unavailable for many nations. Even within the technologically developed nations, large floods commonly exceed gaging station design, or destroy the stations. However, the assessment of flood risk is directly dependent on such flood-discharge measurements and also on inundation-limit mapping, and both can be carried out or assisted by remote sensing.

There also is utility in obtaining a global record of such events, because, as the Earth's climate changes, the geographic patterns and frequency of extreme meteorological events will also change.

Flooding in both monsoonal and extra-tropical regions of the world is sensitive to air-sea interactions such as those associated with the El Niño/Southern Oscillation teleconnection. Such linkages indicate the eventual feasibility of interannual prediction of extreme floods, but, at present, it is not possible to characterize temporal trends or validate model predictions because the required systematic observations of flooding at the global scale are lacking. Socio-economic data also indicate that some years are more flood-prone than others, but consistent physical measurements of these same events are needed in order to understand the climatic causation. This EOS IDS project is using the era of sustained multi-sensor Earth observation from space to observe and measure extreme floods on a global basis, and to analyze their causation. The research will employ Terra and other remote-sensing data sources to provide basic information about flooding as a global-change phenomenon, and it will thereby allow testing of hypotheses and validation of model predictions that

concern interannual-to-interdecadal global variations in flooding and their resulting societal effects.

Science Goal

Much of the EOS science agenda concerns the Earth's hydrological cycle. At least the large flood event outliers in most river flow series can be measured by EOS Terra and other spacecraft. Very large floods commonly overwhelm engineering control structures, so, along some or all river reaches, floodwater spills through or over levees onto the floodplain. Along many less-regulated rivers, the entire floodplain temporarily becomes the river's channel. Even at coarse spatial resolution (e.g., AVHRR's 1 km), many river floods are observable and, when remote sensing is combined with auxiliary data sets, flood magnitudes can be assessed. At higher spatial resolution, aspects of flow dynamics can be observed. Finally, if adequate topographic data for the floodplain and channel are available, flood flow modeling can be validated by remote sensing and peak discharge estimates can be obtained.

Our primary goal is to produce an annual set of globally consistent observational data concerning very large flood events. These data will then be used to characterize and to classify such events, to assess their magnitude, and to analyze their causation. By accumulating consistent data each year, we expect to also compute global and regional flood indices, and thereby to determine on both a large region and global basis the year-to-year changes in extreme flood frequency. The investigation thereby complements projects focusing on changes in the mean state of the Earth's hydrosphere

Current Activities

Late in 1997, several months after project initiation, we began employing AVHRR for flood inundation mapping. This methodology has been designed as preparation for the MODIS data stream, which will increase spatial and spectral resolution and thus improve water/land discrimination.

Our WWW site currently provides daily updates of flooding worldwide. For each new flood event, AVHRR multispectral image data are corrected for sun-angle ef-

fects, calibrated according to current sensor information, and geometrically rectified to a latitude and longitude map coordinate system. A variety of image enhancement and classification techniques are then used to identify flooded areas. The enhanced image data are imported into a Geographic Information System (GIS) and co-registered to the GTOPO (updated global topography in digital format) digital topography; these layers are then, in turn, overlain by the Digital Chart of the World vector data for streams and rivers, roads, railroads, utilities, and human settlements. For example, images and maps were created for the late 1997 extreme flooding in Somalia and adjacent regions, and the UN-supported Relief Web site made available these outcomes for the international disaster relief effort. Sample image maps are found at:

http://www.reliefweb.int/mapc/afr_horn/cnt/som/somdfo1.html

http://www.reliefweb.int/mapc/afr_horn/cnt/som/somdfo2.html

http://www.reliefweb.int/mapc/afr_horn/cnt/som/somdfo3.html

We are actively involved in studies of 1998 El Niño-induced flooding in California and other locations in the Western U.S. Radarsat SCANSAR data are being obtained, and a fast-delivery pathway from the Prince Albert, Canada, receiving station to the Alaska SAR Facility and thence to us has been developed. Two of us are performing field investigations of 1998 flooding in the Central Valley and in support of the remote-sensing data acquisitions.

We have established a formal collaboration with a group of Chinese scientists based at the Chinese Remote Sensing Satellite Ground Station in Beijing. Radarsat SCANSAR data are being obtained for the summer monsoon/tropical storm season of 1998 for a set of 7 critical rivers in southern and eastern China. These data will be downloaded to their station at our request, and the SAR image data will be made immediately available to both groups. After a December, 1997 meeting, we also requested early ASTER imaging of these same valley reaches for 1999. The Chinese side is also providing much in situ, field-based data for these river reaches.

This IDS project includes flood geomorphology and hydrology, flood climatology, and remote sensing expertise. Extreme river floods are a synthetic outcome from a panoply of meteorological and ground surface variables, including: unusual rainfall events, antecedent soil moisture, snow-melt contributions, frozen-ground status, watershed soil composition, vegetation cover and land use, watershed topography, watershed geometry, and drainage density. Some large floods are associated with very temporary and perhaps stochastic anomalies in atmospheric circulation patterns; others are related to more-

persistent atmospheric changes and to phenomena such as El Niño. Still others are, on occasion, the nearly direct results of drastic watershed modifications. As an example, and along one critical river reach in China (the Dong Ting lakes region), the frequency of large floods is increasing due to channel bed and lake aggradation; this increased flooding will continue to occur with or without climate change. The IDS team is employing its different but complementary disciplinary skills around the common focus of understanding the causation of extreme flood events in a global context.

Uses of Satellite Data

A multisensor approach is needed for three reasons:

- 1) Floods occur across a range of spatial scales, and large-ground-coverage sensors are needed in order to provide consistent overall magnitude estimates for geographically extensive events. We are currently using AVHRR data for this purpose, but will eventually move to MODIS.
- 2) For floods along many river floodplains, that range in widths from tens of kilometers to only few kilometers, the 1-km resolution of AVHRR is barely adequate for flood-limit mapping, or is inadequate. Thus higher-resolution sensors, such as Landsat ETM, ASTER, or Radarsat are useful, and can also help to validate measurements obtained by the lower resolution sensor.
- 3) Floods are temporally limited and cloud cover is a severe constraint: the sensor must either have a frequent revisit capability (e.g., AVHRR and MODIS) and thus utilize gaps in cloud cover, or a radar sensor may be required.

Although issues of sensor calibration are important to some aspects of our work (e.g., retrieval of sediment concentration data), we also can make use of many different sensors, calibrated or not, and in different orbits, as flood events are followed in time. Finer temporal sampling also facilitates the determination and acquisition of peak overbank flooding conditions and thus better peak magnitude estimates.

We also require global terrain and hydrological data sets. ESA and the Joint Canadian-American research and applications program using radarsat data (called ADRO) are currently providing selected orbital SAR data, including some interferometric data useful for river-reach topography. A global hydrology data facility in Germany is being tapped for available in situ records of extreme floods, and our Chinese collaborators are assisting us in obtaining in situ data for the study sites in their nation.

With support from the National Science Foundation, Dartmouth will soon install a high-speed network connection between its campus in Hanover, New Hampshire, and the NSF-funded Very-high-speed Backbone Network Service (vBNS). Dartmouth has joined a consortium of New England colleges and universities that will access the vBNS and Internet 2 through the Boston University POP. The DS-3 line from the Boston University POP will terminate at a router or switch in the Kiewit Computation Center at Dartmouth. The upgraded campus backbone includes extra fiber, so dedicated 100-Mb fiber paths will become available to individual laboratories such as the Flood Observatory. This will place this IDS project's computers just two network hops from the vBNS POP.

Participation in Field Programs

Most of the six co-investigators are field-based scientists. K. Prestegaard has been working since 1994 in the Raccoon Creek drainage that was severely affected by the 1993 Mississippi Valley flood. She also conducted a field study in the Red River Valley of North Dakota in 1997, in cooperation with USGS workers, and the team has selected the Great Flood of 1997 as the topic of its first group-authored research paper. L. Mertes continues field studies supporting flood remote sensing in Amazonia, in Georgia, and in Iceland. Brakenridge is investigating an extreme flood event in southern Vermont that occurred in the early summer of 1997, as well as late Holocene records of extreme flood events preserved in this region. He also continues work on the Mississippi Valley flood of 1993 in collaboration with Jim Knox of the University of Wisconsin. The Dartmouth workers are collaborating with the nearby Remote Sensing/GIS facility of the U.S. Army Corps of Engineers Cold Regions Research and Engineering Laboratory, who are using AIRSAR/TOPSAR data obtained at our request for the Illinois River Valley as validation for agency watershed models.

With our Chinese colleagues, a small watershed, already heavily instrumented, has been selected for combined field/remote sensing study, and much information has been compiled concerning its long-term hydrological history. We plan to expand collaboration in this regard, with an emphasis on flood responses.

Principal Investigator

G. Robert Brakenridge

G. Robert Brakenridge received his M.S. and Ph.D. degrees from the Geosciences Department of the University of Arizona in 1979 and 1982. He held a German Academic Exchange Service postdoctoral award at the University of Duesseldorf in 1982 and taught at Wright State University from 1983-1987. He joined the faculty of Dartmouth College in 1987, was a Jet Propulsion Laboratory Visiting Senior Scientist at NASA Headquarters in

1991-1992, and was made a Fellow of the Geological Society of America in 1992. His research is presently focused on the emerging discipline of flood remote sensing.

Co-Investigators

Victor R. Baker - *University of Arizona*

Katherine K. Hirschboeck - *University of Arizona*

Leal A. K. Mertes - *University of California, Santa Barbara*

Karen Prestegaard - *University of Maryland*

William S. Warner - *Jordforsk, Centre for Soil and Environmental Research, Norway*

References

Brakenridge, G.R, B.T. Tracy, and J.C. Knox, 1998: Orbital remote sensing of a river flood wave. *Int. J. Remote Sens.*, **19**, 1439-1445.

Ely, L.L., Y. Enzel, and D.R. Cayan, 1994: Anomalous North Pacific atmospheric circulation and large winter floods in the southwestern United States. *J. Climate*, **7**, 977-987.

Mertes, L.A.K., G.R. Brakenridge, K.K. Hirschboeck, K. Prestegaard, and W.S. Warner, 1996: River Flooding and Global Environmental Change: A Multi-Sensor Approach. *EOS, Transactions, American Geophysical Union*.

Mertes, L.A.K., M. Smith, and J.B. Adams, 1993: Quantifying sediment concentration in surface waters of the Amazon River wetlands from Landsat images. *Remote Sens. Environ.*, **43**, 281-283.

Seeley, K.C., L.A.K. Mertes, and B. Laurent, 1997: Field Measurements of Hydraulic Roughness on the Altamaha River Floodplain, Georgia. *EOS, Transactions, American Geophysical Union*.

Bingyuan, Z., and L. Donghang, 1988: The relationship between the El Niño events and the drought or excessive rain of Northwest China during 1845 to 1988. *Scientia Atmospherica Sinica*, **16**, 185-192.

Investigation URL

<http://www.dartmouth.edu/artsci/geog/floods/>

Collaborative Research: Modeling of N₂ and CO₂ Fixation by the Oceanic Diazotroph *Trichodesmium*

Principal Investigators – **Douglas G. Capone**
Edward J. Carpenter

Science Background

N₂ fixation by the marine cyanobacterium *Trichodesmium* has recently been recognized to provide an important source of new nitrogen in oligotrophic open-ocean waters. Along with atmospheric deposition of combined N, N₂ fixation supports net uptake and export to depth of atmospheric CO₂. In contrast, new NO₃, which enters the euphotic zone from below the thermocline, is limited in its ability to sequester atmospheric CO₂ because it is accompanied by an influx of dissolved inorganic carbon from depth.

Science Goals

Our synthesis and modeling effort has the following primary research objectives: 1) develop a global database that incorporates all existing and accumulating field observations on *Trichodesmium*; 2) use this database to improve existing algorithms for estimating *Trichodesmium* biomass from satellite ocean-color measurements and for developing a new analytical model for predicting rates of N₂ and CO₂ fixation from satellite-derived data; 3) use the analytical model to provide global estimates of CO₂ and N₂ fixation and thereby new production by *Trichodesmium*; 4) compare satellite-derived estimates of surface winds, temperature, chlorophyll, and atmospheric dust (as a surrogate for iron) with satellite-derived *Trichodesmium* biomass estimates, in order to examine the role of these factors as determinants for the distribution, abundance, and bloom formation of *Trichodesmium* population; and 5) to interface our model as an input to the global marine carbon model being developed by Falkowski and Sarmiento.

Current Activities

We have undertaken quantitative field studies of the importance of the *Trichodesmium* as a primary producer and major source of new nitrogen in the tropical oligotrophic ocean in the South Pacific, North Atlantic, and Indian Oceans collecting data on biomass, depth distribution, and N₂ and CO₂ fixation by *Trichodesmium* along with standard oceanographic data. Relevant data are also available

from the western Pacific, Caribbean, and Sargasso Seas. We are currently incorporating satellite remote sensing in our *Trichodesmium* program, specifically to develop and verify (using spectroradiometer measurements) algorithms to estimate *Trichodesmium* biomass by ocean-color sensors (e.g., OCTS, SeaWiFS, MODIS). A database will be compiled from these studies and made available to other workers. We will use the database to develop an analytical model for estimating *Trichodesmium*-specific N₂ and CO₂ fixation rates from satellite-derived *Trichodesmium* biomass estimates. This model will be analogous to the productivity algorithms which are being developed by Falkowski et al. as part of the current SeaWiFS science team efforts, but it will be based upon measured *Trichodesmium*-specific production and N₂ fixation versus irradiance relationships and observed *Trichodesmium* distributions.

The ultimate objective of our synthesis and modeling efforts will be to provide quantitative global estimates of N₂ fixation rates as well as *Trichodesmium*-specific production, which will be coordinated, and intended to interface with, the efforts of Falkowski and Sarmiento, who are developing a global oceanic productivity model, as well as efforts of Siegel and co-investigators, who are modeling nitrogen and carbon cycles in the north Atlantic.

Co-Principal Investigators

Douglas G. Capone

Douglas Capone is currently a professor at the University of Maryland Center for Environmental Science at the Chesapeake Biological Laboratory. He will join the faculty of the University of Southern California Wrigley Institute for Environmental Studies in September, 1999. He received his Ph.D. in Marine Sciences from the Rosenstiel School of Marine and Atmospheric Sciences, University of Miami in 1978.

Edward J. Carpenter

Edward J. Carpenter is a professor in the Marine Sciences Research Center at the State University of New York in Stony Brook. He received his Ph.D. from North Carolina State University in 1969 and had postdoctoral and Re-

search Scientist experience at Woods Hole Oceanographic Institution between 1969 and 1975. He has been at Stony Brook since 1975.

Co-Investigators

Raleigh R. Hood - *Horn Point Environmental Lab*

References

Capone, D.G., A. Subramaniam, J.P. Montoya, M. Voss, C. Humborg, A. Johannsen, R. Siefert, and E.J. Carpenter, 1998: An extensive bloom of the diazotrophic cyanobacterium, *Trichodesmium erythraem*, in the central Arabian Sea. *Mar. Ecol. Prog. Series*, **172**, 281-292.

Carpenter, E.J., H.R. Harvey, B. Fry, and D.G. Capone, 1997: Biogeochemical tracers of *Trichodesmium*. *Deep-Sea Research I*, **44**, 27-38.

Capone, D.G., J. Zehr, H. Paerl, B. Bergman, and E.J. Carpenter, 1997: *Trichodesmium*: A globally significant marine cyanobacterium. *Science*, **27**, 1221-1229.

Carpenter, E.J., and D.G., Capone, 1992: Nitrogen fixation in *Trichodesmium* blooms. Chapter 13, pp. 211-217. In: *Marine Pelagic Cyanobacteria: Trichodesmium and Other Diazotrophs*. E.J. Carpenter, D.G. Capone and J.G. Rueter (eds.) Kluwer Academic Publishers, Dordrecht, Boston, London.

Capone, D.G., J.M. O'Neil, E.J. Carpenter, and J. Zehr, 1991: Basis for diel variation in nitrogenase activity in the marine planktonic cyano-bacterium, *Trichodesmium thiebautii*. *Appl. Environ. Microbiol.*, **56**, 3532-3536.

Carpenter, E.J., J.P. Montoya, J. Burns, M. Mulholland, A. Subramaniam, and D.G. Capone, 1999: Extensive bloom of N_2 fixing symbiotic association in the tropical Atlantic ocean. *Mar. Ecol. Prog. Series*, submitted.

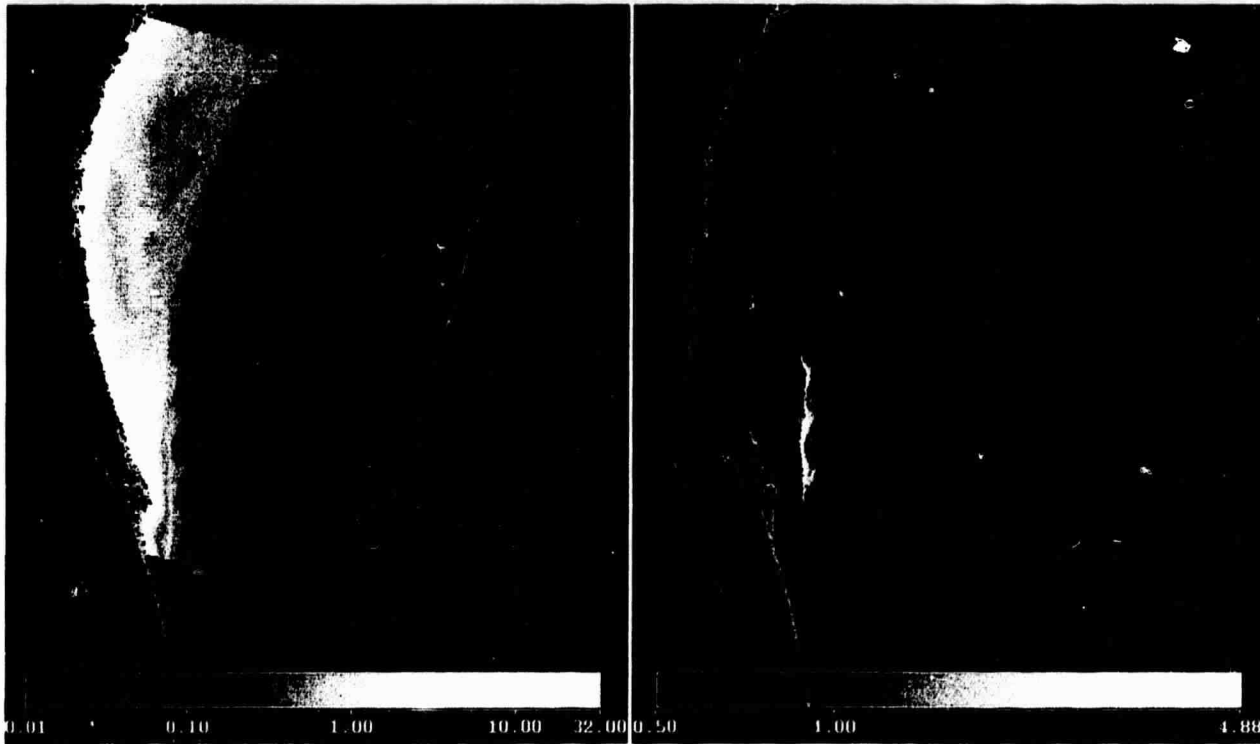

(A) SeaWiFS image of total chlorophyll concentration in the Georgia Bight off the coasts of Florida and Georgia on October 30, 1998. The chlorophyll concentration was calculated using the standard SeaWiFS Project OC2 algorithm. (B) *Trichodesmium* specific chlorophyll concentration from the same image derived using our algorithm.

An Historical and Modeling Comparison Study of Four Coastal Upwelling Systems

Principal Investigator – **Mary-Elena Carr**

Science Background

Although coastal upwelling regions of the Eastern Boundary Currents (EBC) cover less than 0.5% of the world ocean, it is estimated that they account for 11% of global new production (Chavez and Toggweiler 1995) and 20% of global fish catch (Pauly and Christensen 1995). Consequently, these regions play a disproportionate role in the oceanic carbon budget. The high productivity of the EBCs is due to the upwelling of cold nutrient-rich water in response to seasonal equatorward winds along the north-south continental margins. Additionally, the California Current and Peru-Humboldt Current systems are characterized by strong interannual variability associated with El Niño. The yield of 12 million metric tons of anchoveta fishery off coastal Peru in 1971 accounted for one-sixth of global fish catch between 1963 and 1972, prior to collapse of the stock in 1972 due to the combined effect of El Niño and excessive fishing pressure (Bakun 1996). This project consists of comparing the Canary, Benguela, California, and Peru-Humboldt Current regions using an integrated approach of satellite and in situ measurements and modeling. We aim to understand the physical forcing of biological productivity in these regions. An internally consistent, simultaneous study of all sites can be done only from space.

Modeling is integral to a study of this kind as it enables us to incorporate measurements of various aspects of the system into a dynamical framework. Since we want to characterize the biological response to physical forcing, increasingly complex parameterizations of the system allow us to identify relevant processes and compartments. For example, seasonal variation in chlorophyll concentration depends to first order on the seasonal cycle in wind forcing, but there is also a latitudinal and seasonal variation of the characteristics of the source water. Therefore the circulation of sub-thermocline waters is also relevant to understanding the observed patterns of phytoplankton abundance. Models of the biological system alone provide upper and lower constraints for various rate processes, such as photosynthesis, and especially those involving trophic levels which are not at all accessible via satellite, such as grazing.

An integrated approach of modeling and satellite observations is only effective when there is sufficient knowledge of in situ parameters. For example, ocean-color measurements from space provide an estimate of near-

surface pigment concentration, but we rely on a combination of in situ measurements and models to extend this estimate to one of euphotic zone biomass and productivity. The applicability of these models changes on short space and time scales due to physical processes, as upwelled waters stratify or mix when transported off-shore or when upwelling favorable winds cease. Likewise, if the nutrient content or species composition of the upwelling source water change, the algorithms for primary productivity will be affected. Thus, the highest possible resolution of in situ conditions for different forcing regimes is needed to properly utilize and interpret satellite measurements. On another level, although quasi-synoptic, the satellite data set is restricted in space and time. For most parameters, there is no long-term historical time series. This limitation of the satellite time series is compounded by the problem of coverage because of orbit characteristics and the presence of clouds. In situ measurements are necessary to complement, complete, and validate those made from spaceborne sensors. Additionally, many parameters vital to the understanding of the environment cannot be measured from space: physical characteristics such as water column structure (e.g., mixed-layer depth and shear), chemical characteristics (e.g., concentration of nutrients), and biological characteristics (e.g., phytoplankton community composition or biomass of the non-pigmented organisms).

Science Goals

There are two major goals to this project. The first goal is to generate a historical database of atmospheric, physical, chemical, and biological oceanographic parameters. This climatology will be placed on the World Wide Web for community access. This climatology will be integrated with the satellite climatology and will be the foundation for a regional carbon-balance study for each coastal upwelling region. The second goal is to utilize the in situ and satellite climatologies to develop and implement statistical and modeling studies of the controlling factors of biological productivity and of the pathways of carbon flow.

Current Activities

We are in the process of collecting historical data to construct the climatological fields. The data available through NOAA's National Oceanographic Data Center (NODC)

have already been integrated and we are now adding data from the Benguela region, provided by the South African Data Center for Oceanography (SADCO) and for the Peru-Humboldt Current region from the Instituto del Mar de Peru (IMARPE). The programs to estimate averages on pressure or density surfaces are already in place, as well as to those carry out quality control. Likewise, there is a prototype web page (still only for internal use) that provides easy access to plots and data. The present focus is on the California Current region, where the most complete datasets are presently available. We are working on a statistical budget of carbon and nutrients for the system.

The modeling studies are proceeding. The first approach uses a size-based ecosystem model (Moloney and Field 1991) with parameterized physics. In our first study, we compared the effect of periodic upwelling events on two different parameterizations of the ecosystem (Carr 1999). We found that a more-complex food-web structure is less vulnerable to strong and frequent physical forcing than a model with a single phytoplankton and zooplankton compartment. The size-based model is fairly complex from a biological standpoint, which, although relatively realistic, makes it inefficient in terms of coupling to a circulation model. Thus, we are exploring alternative ways to incorporate size information into simpler ecosystem parameterizations. We have recently coupled the size-based model successfully to a mixed-layer model and plan to start integrating it, or a simpler version, with a circulation model.

Use of Satellite Data

We use a combination of ocean-viewing satellite observations, as the basic variables are measurable from space: TOPEX/Poseidon to provide the large-scale flow fields, wind direction and speed from NSCAT and/or ERS-1/2 for past periods and QuikSCAT in the near future; sea-surface temperature from the Advanced Very High Resolution Radiometer (AVHRR); and ocean color from SeaWiFS (and OCTS for the 1996-1997 period). We look forward to the launch of MODIS to provide concurrent estimates of temperature and ocean color.

Participation in Field Activities

Although we do not participate actively in field programs, we rely heavily on data collected through international JGOFS and other past and ongoing sampling programs of the study regions.

Principal Investigator

Mary-Elena Carr

Mary-Elena Carr has been a Research Scientist at the Jet Propulsion Laboratory since 1996 where she studies bio-

logical oceanography with a focus on the interaction of biological and physical processes in the upper ocean. Her investigations are based on remotely sensed observations of biological and physical oceanographic variables and numerical simulations of the ecosystem and of the physical environment. She received her Ph.D. in Oceanography at Dalhousie University in 1991, where she researched the physical constraints of primary production in the equatorial Pacific. She was awarded a Postdoctoral Fellowship at Oregon State University (1991-1993) to investigate the coupling of physical forcing and biological structure on very small vertical scales. As Marine Scientist at the University of Rhode Island (1993-1996), she worked with Tom Rossby on the pathways of transport and exchange in the North Atlantic Current. She is a member of the SeaWiFS Science Team and of the Executive Council of the SeaWiFS Science Team.

Co-Investigator

Edward J. Kearns - *University of Miami*

References

- Bakun, A., 1996: Patterns in the ocean: ocean processes and marine population dynamics. California Sea Grant College System in cooperation with Centro de Investigaciones Biologicas del Noroeste, La Paz, BCS Mexico, 323 pp.
- Carr, M.-E. 1998: A numerical study of the effect of periodic nutrient supply on pathways of carbon in a coastal upwelling regime. *J. Plankton Res.*, **20**, 491-516.
- Chavez, F., and J.R. Toggweiler, 1995: Physical estimates of global new production: the upwelling contribution. In Summerhayes, C.P., Emeis, K.-C., Angel, M. V., Smith, R. L., and Zeitzschel, B., editors, *Upwelling in the ocean: modern processes and ancient records*, pp. 314-320. John Wiley and Sons.
- Moloney, C.L., and J.G. Field, 1991: The size-based dynamics of plankton food webs. 1. A simulation-model of carbon and nitrogen flows. *J. Plankton Res.*, **13**, 1003-1038.
- Pauly, D., and V. Christensen, 1995: Primary production required to sustain global fisheries. *Nature*, **374**, 255-257.

Investigation URL

<http://oceans-www.jpl.nasa.gov>

The Yangtze Delta of China as an Evolving Metro-Agro-Plex (China-MAP)

Principal Investigator – **William L. Chameides**

Science Background

A social and environmental experiment of unprecedented proportions is taking place in China. The world's most populous nation is also its most rapidly developing. Moreover, the pace of China's economic development is astounding. Economic and technological infrastructure that took western nations centuries to realize, the Chinese hope to develop in mere decades.

Will China be able to sustain this rate of development, while also absorbing the 15 million people added to its population each year? This is a question of critical importance to the Chinese and the world. With its Gross Domestic Product (GDP) growing ~10% each year and projected to exceed the GDP of the United States by the turn of the century, China has become a major global economic force. The sustainability of China's economy is thus an issue of critical importance to us all. A key aspect of this issue is food and nutrition. China's population growth alone will require significant increases in food supplies. Determining how this demand for food will be met is a complex calculus whose parameters are the subject of intense discussion and debate. A study provided by China's Information Office of the State Council projects continued food self-sufficiency for the nation by increasing grain production at a rate of about 1% per year. However, this and other similar studies have yet to consider the effect of environmental change on China's agriculture. The unprecedented economic and population growth in China are bringing about profound changes in the nation's landscape and pollutant emissions. These will significantly affect China's regional climate and air quality. How will these environmental changes affect China's rice- and wheat-based agriculture? This is China-MAP's main focus.

Through a ten-year program of research and field study, the China-MAP project will focus on four key and interrelated issues:

Issue 1: An assessment of the effects of ground-level ozone pollution and photochemical smog from gaseous emissions of nitrogen oxides and volatile organic compounds on present-day and future agricultural yields of rice and wheat in China.

Issue 2: An assessment of the effects of gaseous sulfur oxide and nitrogen oxide emissions on acid deposition in China and its concomitant impact on present-day and future agricultural yields of rice and wheat in China.

Issue 3: An assessment of the effects of gaseous sulfur oxide and particulate carbon or soot emissions on regional climate in China and its concomitant impact on present-day and future agricultural yields of rice and wheat in China.

Issue 4: An assessment of the effects of land-use change in China on regional climate and its concomitant impact on future agricultural yields of rice and wheat in China.

These assessments will be carried out using a coupled climate-atmospheric-chemistry-crop-yield modeling system driven by a geographically disaggregated database of the socio-economic drivers of environmental change. Both the modeling system and the database will be developed by the China-MAP Science Team and evaluated using environmental data gathered in China from a China-MAP monitoring network as well as a series of intensive field studies in the Yangtze Delta of China. By evaluating the environmental and agricultural effects of various scenarios for economic growth in China, the modeling system can eventually be used to help identify the most promising paths for sustainable economic development in China.

Science Goals

The China-MAP research strategy is based on two guiding principles. The first is a multidisciplinary approach to understanding the processes that affect China's economy and environment. The other is a focus on the regional or mesoscale, the scale where environmental change is most critically coupled to economic viability, but with consideration of the couplings of the mesoscale-to-smaller scales (i.e., the microscale) and larger scales (i.e., the global scale).

Our objective is to elucidate how environmental factors in China are affected by and coupled to the underlying socio-economic drivers of environmental change.

Thus, our research strategy starts with the socio-economic factors as a given and then attempts to assess their impact on the environmental and agricultural ecosystems of China. More specifically, we will adopt existing databases and models to first quantify the socio-economic drivers of the environmental change in China, and then develop, evaluate, and apply a hierarchy of models and field observations to assess the impact of these drivers on China's climate and environment, and, in turn, the impact of these environmental perturbations upon agriculture in China.

Current Activities

China-MAP is currently in the first 3-year phase of an anticipated 10-year lifespan. During this phase, the China-MAP Science Team is focusing on archiving a basic environmental Geographical Information System for China, the development and evaluation of a coupled atmospheric chemistry/climate/crop-response modeling system for China, and the design and implementation of an atmospheric chemistry/terrestrial-ecosystem intensive field study in the Yangtze Delta region scheduled to run from the summer of 1999 through the summer of 2000 with funding from the National Natural Science Foundation of China. Satellite data are used in the study to document land-use and land-cover changes in the study area and to characterize meteorological fields needed to drive our modeling system.

Use of Satellite Data

China is a huge country of diverse physical, chemical, and ecological characteristics. Significant pollutant emissions, as well as agricultural production of China's two main staple crops—wheat and rice—abound throughout. To attempt a comprehensive study of the interactions between economic development, environmental change, and agriculture over the entire nation would prove a daunting and, likely, unrealistic task. Hence, we have chosen the Yangtze Delta, located in the southeastern corner of the nation, as a region for more-intense study. The Yangtze Delta contains approximately 85 cities and townships in addition to its one megacity—Shanghai. With a population of ~200 million, it is the most densely populated area of eastern Asia. The Yangtze Delta region is also growing by leaps and bounds and has been responsible for 25% of China's growth in GDP in the 1990's and has become a prime target for foreign investment. Perhaps not surprisingly in view of its recent economic growth, the role of agriculture in the Yangtze Delta has changed significantly. Historically a major supplier of grains to the provinces in the north of China, the region is now barely food self-sufficient.

Principal Investigator **William L. Chameides**

Chameides received his Ph.D. in 1974 from Yale University. After Yale, he spent two years as a Research Scientist at the University of Michigan and four years on the faculty at the University of Florida. In 1980 he joined the faculty at the Georgia Institute of Technology. He served as Director of the School of Earth and Atmospheric Sciences from 1989-1994 and is currently Regents Professor of Earth and Atmospheric Sciences.

Chameides' research focuses on atmospheric chemistry with emphasis on global biogeochemical cycles, biospheric/atmospheric interactions, air pollution, global change, and urbanization. Through the development and application of numerical algorithms and models and the design and implementation of field studies, he endeavors to elucidate the coupled chemical, physical, and biological processes that determine the chemical environment, and thereby help identify pathways toward a sustainable future. Dr. Chameides has authored or co-authored over 80 scientific publications, as well as a textbook on Biogeochemical Cycles and a National Academy of Sciences book on Rethinking the Ozone Problem in Urban and Regional Air Pollution.

In addition to his academic appointments, Chameides plays a lead role in two multi-institutional, multidisciplinary research programs concerned with regional environmental change and the strategies for sustainable economic development. He is the Chief Scientist of the Southern Oxidants Study (SOS) and Director of SOS' Southern Center for the Integrated Study of Secondary Air Pollutants (SCISSAP). Collectively, SOS and SCISSAP focus on understanding the causes and remedies for ground-level ozone and fine-particle pollution in the Southern United States. Chameides is the U.S.A. Study Director of China-MAP, an international research program studying the effects of environmental change on agriculture in China, the world's most populous and rapidly developing nation.

Among his various committee assignments, Chameides also serves as Chair of: 1) the NARSTO Synthesis Team, a group of Canadian, Mexican, and U.S. scientists charged with writing the 1998 Assessment Document for the North American Research Strategy for Tropospheric Ozone; and 2) the National Research Council's Committee on Ozone Forming Potential of Reformulated Gasoline, which is addressing the environmental effects of ethanol and other oxygenates in reformulated gasoline.

Co-Investigators

- C. S. Kiang - *Georgia Institute of Technology*
- G. Carmichael - *University of Iowa*
- F. Giorgi - *National Center for Atmospheric Research*
- Thomas Heller - *Stanford University*
- L. Mearns - *National Center for Atmospheric Research*
- Rosamond Naylor - *Stanford University*
- V. Ramaswamy - *GFDL, Princeton University*

References

Brown, L., 1995: Who will feed China? Wake-up call for a small planet, New York, Norton.

Chameides, W.L., P.S. Kasibhatla, J. Yienger, and H. Levy, 1994: Growth of continental-scale metro-agro-plexes, regional ozone pollution, and world food production. *Science*, **264**, 74-77.

Dentener, F., G. Carmichael, and Y. Zhang, 1996: The role of mineral aerosol as a reactive surface in the global troposphere. *J. Geophys. Res.*, **101**, 22,869- 22,889.

Elliott, S., et al., 1997: Motorization of China implies changes in Pacific air chemistry and primary production. *Geophys. Res. Letts.*, **24**, 2671-2674.

Giorgi, F., M.R. Marinucci, G. DeCanio, and G.T. Bates, 1993: Development of a second generation regional climate model (RegCM2). Part II: Cumulus cloud and assimilation of lateral boundary conditions. *Mon. Wea. Rev.*, **121**, 2814-2832.

Kasibhatla, P., W.L. Chameides, and J. St. John, 1997: A three-dimensional global model investigation of seasonal variations in the atmospheric burden of anthropogenic sulfate aerosols. *J. Geophys. Res.*, **102**, 3737-3759.

Mearns, L.O., and C. Rosenzweig, 1995: Formation of climate change scenarios incorporating changes in daily climate variability and application to crop models, In W. Howe and A. Henderson-Sellers (eds.), *Assessing climate change: The story of the model evaluation consortium for climate assessment*, Chap. 15, Harwood Academic.

Streets, D., C. Cung, J. Krummel, and S. Haiping, Remote sensing of global change: Growth in China's Jiangsu Province. *Int. J. Sustainable Development and World Ecology*, **2**, 1-10, 1995.

Investigation URLs

- <http://www-wlc.eas.gatech.edu>
- <http://www-wlc.eas.gatech.edu/chinamap.html>

Pollutant emissions and crop production in China by region. China-MAP is investigating the conflicts and synergism between industrial activity and agriculture in China with a special focus on the Yangtze (Region 6), a region with plentiful agriculture and pollutant emissions.

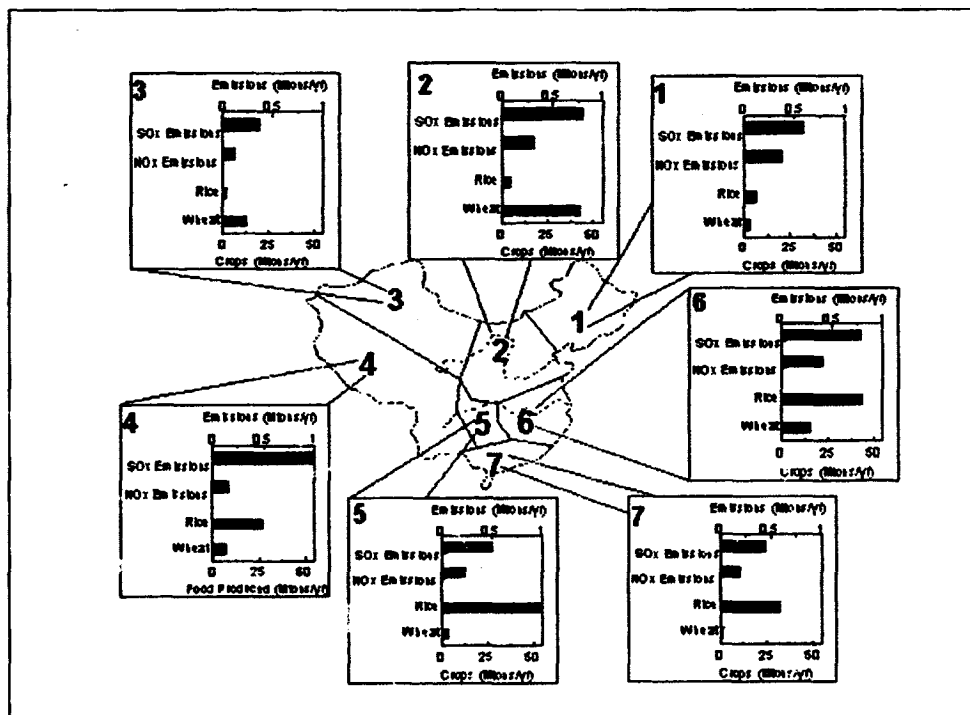

Northern Biosphere Observation and Modeling Experiment (NBIOME)

Principal Investigator – **Josef Cihlar**
International Sponsor – **Canada**

Science Background

Numerous studies using general circulation models (GCMs) have concluded that significant climate change is likely to occur during the next century, principally as a result of the rising concentration of anthropogenic greenhouse gases. Air temperature is predicted to increase more at northern latitudes, and appreciable mid-continent drying has also been postulated. Such changes would strongly influence the functioning of northern terrestrial ecosystems as well as, over time, their structure and geographic distribution. They would in turn affect the climate because of the biosphere-climate feedbacks, at both mesoscale and GCM grid scales. The types and degree of likely ecosystem responses are not well understood but they will vary with the biome under consideration (forest, agroecosystems, wetlands, tundra) and the particular processes. In addition to climate change, natural ecosystems are increasingly affected by human activities. A critical issue in understanding the impact of climate change on ecosystems is the relationship between processes operating at various spatial scales, from leaves to landscapes. Satellite observations combined with flux data provide the key measurement techniques to allow bridging this range of scales for process studies and change monitoring.

Science Goal

The goal of the Northern Biosphere Observation and Modeling Experiment (NBIOME) is to improve the understanding of the relationship between the climate and the northern ecosystems, including their seasonal and interannual dynamics and their role in the global carbon and hydrological cycles. The objectives of NBIOME are: 1) to develop and validate methods for the extraction of biophysical parameters from optical and microwave satellite data for major Canadian biomes; 2) to develop methods for extending observations and model outputs across a range of spatial scales, from stand to landscape and the Canadian landmass; and 3) to use the satellite-derived parameters with data from other sources as input process models for the assessment of ecosystem performance. Particular emphasis is being given to climate-related processes such as carbon uptake through photosynthesis; for-

est fire dynamics; the effect of climate on the terrestrial carbon budget, especially in forests; and the changing radiation regime over the landmass of Canada (e.g., surface radiation budget, UVB radiation, photosynthetically active radiation, etc.)

Regarding Objective 1, the parameters of interest are those which most closely characterize vegetation and its functioning: land-cover type, land-cover change, leaf-area index, absorbed photosynthetically active radiation, and newly burned areas. Methods are being developed using present satellite data, especially Advanced Very High Resolution Radiometer (AVHRR) data over Canada as a precursor of EOS MODIS data, and include refinements of the processing techniques to compensate for subpixel clouds and bidirectional effects. This work will enable production of derived data sets for Canada during the pre-launch EOS period, using daily AVHRR coverage during the growing season. Objective 2 addresses the problem of scaling for dynamic processes, such as carbon uptake and loss through fires, where temporal and spatial dynamics are intrinsically linked. This task has been approached through a combination of satellite-data-derived products and spatially explicit models. The principal ecosystem variable of interest in Objective 3 is terrestrial primary productivity. To be practical, productivity models should require a minimum of data that cannot be obtained from satellites or cannot be cost-effectively obtained over large areas. The focus of this study is on satellite data sources and techniques that may be used to apply findings from the study areas at the regional level.

Current Activities

NBIOME Co-Investigators are engaged in activities related to all three objectives above. Regarding Objective 1, research has been carried out to develop and validate algorithms for the extraction of leaf-area index, absorbed photosynthetically active radiation, and land cover from satellite optical data. Canada-wide products with a spatial resolution of 1 km have been produced from AVHRR data for one or more years in the 1993-1998 period. They include land cover (in 31 classes), leaf-area index and the fraction of photosynthetically active radiation (at 10-day intervals during the growing season), and forest fires (daily hot spots during the growing season as well as total an-

nual fire scars). Various numerical simulation and inversion models have been developed in support of these products, including: an advanced bidirectional reflectance model capable of capturing radiative-transfer processes within a tree canopy and its generalized version suitable for AVHRR data; a new technique for quantifying vegetation leaf area based on sub-canopy light penetration regime; theoretically-based models for the estimation of photosynthetically active and UVB radiation at the land surface from satellite data; new procedures for extracting land-cover information by optimally combining satellite optical data at various resolutions; etc.

Objective 2 is being approached through a combination of satellite data at various resolutions (from ~30 m to 1 km), observation periods from 1 day to a growing season, and the use of the above satellite-derived products. The third objective is pursued in two ways. Primary productivity is estimated using a detailed biogeochemical cycling model (Boreal Ecosystem Productivity Simulator, BEPS), which computes daily net carbon uptake for each 1 km² of the landscape using some of the above products as well as meteorological and ancillary vegetation data. The net forest ecosystem productivity (NEP) is estimated by considering two different conditions, old forests in which NEP is only due to climate change effects (observed changes in the growing season length and air temperature; observed changes in nitrogen deposition) and disturbed forests (due to fire, insects, harvest).

Use of Satellite Data

The entire project is firmly based on the use of satellite data. To date, the use of data from AVHRR has been emphasized. The GEOcoding and COMPositing system (GEOCOMP) was built to produce full-resolution 10-day composites over Canada's landmass during the growing season (every year since 1993), and methods have been developed to reduce the noise resulting from the compositing process. Higher level products have been developed from the AVHRR data. The algorithms are structured so that they can be transferred to EOS MODIS. A new processing system has been constructed that will routinely generate the above higher level products. Landsat is the principal source of fine-resolution data.

Participation in Field Programs

NBIOME Co-Investigators have actively participated in BOREAS field campaigns (1993, 1994, 1996). In 1998 they carried out an LAI and FPAR validation program which included 10 sites across Canada. Validation of NPP outputs was carried out in 1997-1998 using BOREAS flux tower measurements, and spatial validation of NPP commenced in 1999 at three sites (Quebec, Manitoba, Alberta). A new effort is the development and validation of net ecosystem productivity data sets. Data from BOREAS and

both existing and new spatially explicit data sets are being used for this purpose.

Principal Investigator

Josef Cihlar

Josef Cihlar holds degrees in Soil Science, Physical Geography, and Remote Sensing. He is a senior research scientist at the Canada Centre for Remote Sensing where he heads research activities in satellite data applications to environmental issues at both large (landscape to global) and local scales. His primary research interest has been satellite monitoring of the characteristics and temporal dynamics of the terrestrial biosphere.

Co-Investigators

Jean Beaubien - *Canada Forest Service*

Raymond Desjardins - *Agriculture and Agri-Food Canada*

Alain Royer - *Universite de Sherbrooke*

Brian Stocks - *Canada Forest Service*

The following are from the Canada Centre for Remote Sensing:

Jing Chen
Wenjun Chen
Terry Fisher
Zhangqing Li
Philip Teillet

References

- Chen, J.M., and J. Cihlar, 1995: Plant canopy gap size analysis theory for improving optical measurements of leaf area index of plant canopies. *Appl. Opt.*, **34**, 6211-6222.
- Chen, J.M., and J. Cihlar, 1995: Quantifying the effect of canopy architecture on optical measurements of leaf area index using two gap size analysis methods. *IEEE Trans. Geosci. Remote Sens.*, **33**, 777-787.
- Chen, J.M., and J. Cihlar, 1996: Retrieving leaf area index in boreal forests using Landsat TM images. *Rem. Sens. Environ.*, **55**, 153-162.
- Cihlar, J., 1996: Identification of contaminated pixels in AVHRR composite images for studies of land biosphere. *Rem. Sens. Environ.*, **56**, 149-163.
- Li, Z., J. Cihlar, X. Zhang, L. Moreau, and H. Ly, 1996: The bidirectional effects of AVHRR measurements over boreal regions. *IEEE Trans. Geosci. Remote Sens.*, **34**, 1308-1322.

Chen, J.M., and J. Cihlar, 1997: A hotspot function in a simple bidirectional reflectance model for satellite applications. *J. Geophys. Res.*, **102**, 25,907-25,913.

Cihlar, J., H. Ly, Z. Li, J. Chen, H. Pokrant, and F. Huang, 1997: Multitemporal, multichannel AVHRR data sets for land biosphere studies: artifacts and corrections. *Rem. Sens. Environ.*, **60**, 35-57.

Cihlar, J., J. Chen, and Z. Li, 1997: Seasonal AVHRR multichannel data sets and products for studies of surface-atmosphere interactions. *J. Geophys. Res. - Atmospheres*, **102**, 29,625-29,640.

Cihlar, J., J. Beaubien, Q. Xiao, J. Chen, and Z. Li, 1997: Land cover of the BOREAS Region from AVHRR and Landsat data. *Canadian J. Rem. Sens.*, **23**, 163-175.

Li, Z., L. Moreau, and J. Cihlar, 1997: Estimation of photosynthetically active radiation absorbed at the surface. *J. Geophys. Res.*, **102**, 29,717-29,727.

Liu, J., J.M. Chen, J. Cihlar, and W. Park, 1997: A process-based boreal ecosystem productivity simulator using remote sensing inputs. *Remote Sens. Environ.*, **62**, 158-175.

Beaubien, J., J. Cihlar, G. Simard, and R. Latifovic, 1999: Land cover from multiple Thematic Mapper scenes using a new enhancement - classification methodology. *J. Geophys. Res.*, in press.

Cihlar, J., J. Chen, Z. Li, F. Huang, R. Latifovic, and R. Dixon, 1998: Can interannual land surface signal be discerned in composite AVHRR data? *J. Geophys. Res. - Atmospheres*, **103**, 23,163-23,172.

Cihlar, J., Q. Xiao, J. Beaubien, K. Fung, and R. Latifovic, 1998: Classification by Progressive Generalization: a new automated methodology for remote sensing multichannel data. *Int. J. Remote Sens.*, **19**, 2685-2704.

Cihlar, J., R. Latifovic, J. Chen, and Z. Li, 1999: Near-real time detection of contaminated pixels in AVHRR composites. *Canadian J. Remote Sens.*, in press.

Cihlar, J., J. Beaubien, R. Latifovic, and G. Simard, 1998: Land Cover of Canada 1995 Version 1.1. Digital data set documentation. Natural Resources Canada, Ottawa, Ontario.

Cihlar, J., R. Latifovic, J. Chen, J. Beaubien, and Z. Li, 1999: Selecting high resolution sample in land cover studies. Part 1: algorithm. *Remote Sens. Environ.*, accepted.

Cihlar, J., R. Latifovic, J. Chen, J. Beaubien, and Z. Li, 1999: Selecting high resolution sample in land cover studies. Part 2: application to estimating land cover composition. *Remote Sens. Environ.*, accepted.

Li, Z., S. Nadon, and J. Cihlar, 1999: Satellite detection of boreal forest fires, Part I: Algorithm development and application. *Int. J. Remote Sens.*, in press.

Li, Z., S. Nadon, J. Cihlar, and B.J. Stocks, 1999: Satellite detection of boreal forest fires, Part II: Algorithm validation and comparison. *Int. J. Remote Sens.*, in press.

Li, Z., P. Wang, and J. Cihlar, 1999: A simple and accurate algorithm for retrieving surface UV-B irradiance from satellite, Part I: Model development and simulation results. *J. Geophys. Res.*, accepted.

Chen, J.M., S.G. Leblanc, J. Cihlar, R. Desjardins, and J.I. MacPherson, 1999: Extending aircraft and tower-based CO₂ flux measurements to a boreal region using a Landsat TM landcover map. *J. Geophys. Res. - Atmospheres*, in press.

Chen, J.M., J. Liu, J. Cihlar, and M.L. Goulden, 1999: Daily canopy photosynthesis model through temporal and spatial scaling for remote sensing applications. *Ecological Modeling*, accepted.

Chen, W., J.M. Chen, D.T. Price, J. Cihlar, and J. Liu, 1999: Potential carbon benefit and cost of forest management options in Canada. *Mitigation and Adaptation Strategies for Global Change*, submitted.

Liu, J., J.M. Chen, J. Cihlar, and W. Chen, 1999: Net primary productivity distribution in the BOREAS study region from a process model driven by satellite and surface data. *J. Geophys. Res.*, accepted.

Investigation URL

The results of NBIOME research have been published in various international journals. A partial list can be found at:

<http://www.ccrs.nrcan.gc.ca/ccrs/eduref/ref/biblio.html>

Examples of products derived by NBIOME Co-Investigators can be found at:

<http://www.ccrs.nrcan.gc.ca/ccrs/tekrd/rd/apps/em/cchange/ccemse.html>

Retrieval, Assimilation, and Modeling of Atmospheric Water Vapor from Ground- and Space-Based GPS Networks: Investigation of the Global and Regional Hydrological Cycles

Principal Investigator – Jean O. Dickey

Science Background

Uncertainty over the response of the atmospheric hydrological cycle (particularly the distribution of water vapor and cloudiness) to anthropogenic forcing is a primary source of doubt in current estimates of global climate sensitivity (e.g., Lindzen 1994); conversely, the lack of detailed information regarding the effects of global change on regional land-surface hydrology raises severe difficulties in evaluating its likely societal impact. Current satellite observations of the atmospheric water vapor field suffer from a number of restrictions which limit their usefulness for hydrological studies. At the same time, the lack of a suitable global database forces assimilation schemes to fall back on model-adjusted moisture fields which incorporate idealized physical parameterizations, greatly limiting their value for climate research (e.g., Trenberth and Guillemot 1995). For these reasons an intensive investigation of the hydrological cycle has become a centerpiece of the Earth Science Enterprise (ESE) and EOS, both to acquire a robust database for theoretical and modeling studies of the relevant physical processes, and to detect and monitor critical ongoing changes in the functioning of the climate system.

Fortunately, a variety of advanced techniques and sensors are beginning to shed new light on the atmospheric hydrological cycle. One of the most promising of these new approaches makes use of the sensitivity of the Global Positioning System (GPS) to the thermodynamic state, and in particular the water vapor content, of the atmosphere through which the radio signals propagate (e.g., Bevis et al., 1992; Businger et al., 1996). This decade has seen an explosion in the number of applications of GPS, ranging from precise surveying (at the millimeter level) to the landing of airplanes with positioning uncertainty of a few centimeters. GPS offers a unique opportunity to the atmospheric sensing community in that the extensive system of satellites, receivers, and software has been put in place primarily for purposes of geodetic positioning, navigation, and tectonic studies. Thus, a large part of the expense of installing and operating these networks is shared with the geodetic community, sharply reducing the marginal cost of atmospheric data obtainable from GPS

relative to that incurred by dedicated sensing systems. Determinations from down-looking receivers and dedicated satellites placed in low Earth orbit (LEO) can also be used to increase the vertical resolution and global coverage of the meteorological database provided by GPS.

Science Goal

The goal of this proposal is to lay the groundwork for the successful exploitation of this unique resource by the atmospheric-sensing and modeling communities during the lifetime of the EOS mission. Previous studies have shown the ability of ground-based (e.g., Bevis et al., 1994; Businger et al., 1996; Duan et al., 1996) and space-based (Hajj et al., 1994; Ware et al., 1996) receivers to derive accurate atmospheric data from GPS signals, and their potential value to atmospheric analysis and forecasting has been demonstrated by the assimilation of synthetic GPS determinations into mesoscale models (Kuo et al., 1993, 1995; Zou et al., 1995). Our strategy to derive the maximum benefit for hydrological studies from the rapidly increasing GPS data stream will proceed in three stages. Specifically, we propose to: 1) use GPS networks on both regional and global scales, and from LEO receivers when they become available, using state-of-the-art techniques; 2) employ both currently available and innovative assimilation procedures to incorporate these determinations into advanced regional and global atmospheric models, and assess their effects on the simulation of the hydrological cycle; and 3) apply the results from parts (1-2) to investigate selected scientific issues of relevance to regional and global hydrological studies.

Current Activities

The advent of the Global Positioning System offers a unique opportunity to increase our knowledge of the atmospheric moisture budget through its sensitivity to the water vapor content along the ray path. Our regional modeling effort will initially utilize data from all sites (40 at the time of writing) of the Southern California Integrated GPS Network (SCIGN), as well as down-looking receivers

ers to be situated on topographic features above the boundary layer (where most of the water vapor resides).

We plan to retrieve and assimilate estimates of the tropospheric zenith path delay at each SCIGN site as well as occultations of rising and setting GPS satellites from down-looking receivers, together with surface meteorology from suitably equipped sites, into a version of the fifth-generation Penn State/NCAR mesoscale model (MM5) adapted to Southern California to: 1) optimize retrievals of precipitable water vapor (PWV), i.e., water vapor integrated through the atmosphere, as well as vertical water vapor profiles; 2) assess the improvement in the modeling of water vapor and other atmospheric variables that will result from the inclusion of the GPS measurements into the mesoscale model; and 3) enhance our understanding of the regional dynamics of precipitation and water vapor transport, and their interaction with topographic and surface features.

The first year saw the establishment of an archive of GPS-based estimates of total zenith delay (TZD) data and water vapor where applicable; the development of an automated quality-control capability is underway. The accuracy of the GPS estimates is being monitored, and the investigation of systematic errors is ongoing using comparisons with water vapor radiometers. Meteorological packages have been purchased and implementation is underway. The accuracy and utilization of the TZD estimates has been improved by implementing a troposphere gradient model. Development of an algorithmic capability to extract path-delay information from the downward-looking space-based receivers is underway; two codes, a ray-tracing code and an inversion code, are now being tested with synthetic data sets. The MM5 mesoscale model is being adapted for Southern California and OSSE experiments are underway. A forward model for the computation of TZD from the model's prognostic variables has been developed, and testing of the direct assimilation of TZD into a version of MM5 incorporating the orthometric heights of the GPS ground-based receivers has begun, using the linearized adjoint of the forward model. These results will be compared with the assimilation of zenith wet delay (ZWD) and PWV data, which will become available once the meteorological packages are installed at the GPS sites.

In our application of GPS determinations to global hydrological studies, we will make use of the Goddard Space Flight Center's (GSFC) Data Assimilation Office's (DAO) physical space statistical-assimilation scheme (PSAS) to assimilate retrievals of ground-based GPS data from the global IGS and regional networks as well as occultation data from GPS low-Earth orbiters into GSFC's GEOS-1 global general circulation model. The current IGS network consists of over 150 globally distributed sites, whose number is rapidly increasing. The low-Earth orbiters which track GPS in an occultation geometry are expected to retrieve accurate refractivity profiles in regions where water vapor is dense. Missions currently

planned which include space-GPS capabilities are Oersted, SAC-C, CHAMP, Sunsat and GRACE. The development of a quality-controlled database from these determinations will allow us to assimilate water-vapor-sensitive data with high vertical resolution into GEOS-2, to optimize the retrieval of precipitable water as well as water vapor and boundary-layer profiles, and to investigate the ability of current climate models to simulate the global hydrological cycle. Concomitant retrievals of temperature profiles in the upper troposphere, where water vapor is scarce, will also benefit the GEOS-2 analysis.

Use of Satellite Data

The optimum use of satellite-derived data is the central feature of the investigation. We will be utilizing the Global Positioning System, which consists of a constellation of 24 Earth-orbiting satellites, global and regional networks of ground resources, and hardware, software, and infrastructure for retrieving and analyzing the data collected by both ground- and space-based receivers. Traditionally used for high-precision geodesy, the GPS system has recently emerged as an equally powerful tool in atmospheric studies, in particular climatology and meteorology. In fact, the geodetic applications and the atmospheric applications of the GPS system cannot be separated; in order to get the precise location of the receiver, the delay suffered by the GPS signal while traversing the atmosphere must be accurately known. The GPS-based estimate of PWV, i.e., the total amount of water vapor in the atmospheric column above a ground-based receiver, can be inferred from a direct estimate of the TZD, with the help of some ancillary information. We also plan to access determinations from down-looking receivers and dedicated satellites placed in low Earth orbit to increase the vertical resolution and global coverage of the meteorological database provided by GPS. The refractivity profile can be derived using the assumption of hydrostatic equilibrium, and calculated as a function of height. Temperature can be derived from density and pressure using the equation of state for dry air. In regions where water vapor is appreciable, some independent knowledge of temperature can be used to derive a water-vapor profile. Intercomparisons of GPS products with those derived from GOES/GMS, AIRS, MODIS, and AMSU-B are planned.

Participation in Field Activities

To more-carefully investigate systematic errors in the measurement of atmospheric water vapor by GPS and water vapor radiometer (WVR) instruments, a long-term comparison of these two techniques was begun in June of 1996 at the Goldstone Deep Space Network tracking station located in the Mojave desert north of Barstow, CA. During the course of this test, a GPS receiver equipped with a high-precision pressure sensor recorded data continuously along-side a state-of-the-art WVR. This test has

so far yielded over 10,000 independent measurements of atmospheric water vapor by the two techniques over a wide range of atmospheric conditions. This large data set represents an invaluable testbed for investigation of improved analysis strategies for both techniques. Systematic comparisons have also been made at an additional number of sites. Particular emphasis is being placed on the sites in SCIGN.

Principal Investigator

Jean O. Dickey

Jean O'Brien Dickey earned a Ph.D. in Physics from Rutgers University (New Brunswick, NJ) and is currently a Principal Member of the Technical Staff and Technical Group Supervisor of the Space Geodetic Science and Applications Group at the Jet Propulsion Laboratory (JPL) California Institute of Technology. She has held research positions at Caltech since 1977 [Research Faculty Appointment (1977-1980) on campus, JPL since 1980, Group Supervisor beginning 1983]. Areas of interest include interdisciplinary studies involving the application of the geodetic data to atmospheric problems, Space Geodesy, Geodynamics and Atmospheric Dynamics, Angular Momentum Budget Studies of the Earth, Solid Earth-Atmosphere Interactions, Climate Studies, Earth Rotation and Polar Motion. She has published over 100 articles. She has served as the Chair on the National Research Council Committee, Earth's Gravity from Space, as President of the Geodesy Section of the AGU, and as a member of several editorial boards. She is active in international affairs and is currently the second Vice-President of the International Association of Geodesy (IAG). Honors include Fellowships, in both AGU and IAG, Invited Discourse (XXIInd International Astronomical Union General Assembly), Bowie Lecture (AGU), and Invited Lecture, Frontiers in Geophysics (AGU).

Co-Investigators

John R. Anderson - *University of Wisconsin, Madison*

Yoaz Bar-Sever - *Jet Propulsion Laboratory*

Michael G. Bevis - *University of Hawaii*

Steven Businger - *University of Hawaii*

George Hajj - *Jet Propulsion Laboratory*

Arthur Y. Hou - *NASA/Goddard Space Flight Center*

Y.-H. Kuo - *National Center for Atmospheric Research*

E. Robert Kursinski - *Jet Propulsion Laboratory*

Steven L. Marcus - *Jet Propulsion Laboratory*

John Porter - *University of Hawaii*

David A. Randall - *Colorado State University*

Siegfried D. Schubert - *NASA/Goddard Space Flight Center*

Xiaolei Zou - *National Center for Atmospheric Research*

References

Bevis, M., S. Businger, T.A. Herring, C. Rocken, R.A. Anthes, and R.H. Ware, 1992: GPS Meteorology: Remote sensing of atmospheric water vapor using the global positioning system. *J. Geophys. Res.*, **97**, 15,787-15,801.

Bevis, M., S. Businger, S. Chiswell, T.A. Herring, R.A. Anthes, C. Rocken, and R.H. Ware, 1994: GPS Meteorology: mapping zenith wet delays onto precipitable water. *J. Appl. Meteor.*, **33**, 379-386.

Businger, S., S.R. Chiswell, M. Bevis, J. Duan, R.A. Anthes, C. Rocken, R.H. Ware, M. Exner, T. VanHove, and F.S. Solheim, 1996: The promise of GPS in atmospheric monitoring. *Bull. Amer. Meteor. Soc.*, **77**, 5-18.

Duan, J., M. Bevis, P. Fang, Y. Bock, S. Chiswell, S. Businger, C. Rocken, F. Solheim, T. Van Hove, R. Ware, S. McClusky, T. Herring, and R.W. King, 1996: GPS Meteorology: Direct Estimation of the Absolute Value of Precipitable Water. *J. Appl. Meteor.*, **35**, 830-838.

Hajj, G.A., K.R. Hardy and E.R. Kursinski, 1994: Assessment of GPS occultations for atmospheric profiling, 7th conference on satellite meteorology and oceanography, June 6-10, Monterey, CA, American Meteorology Society.

Kuo, Y.-H., Y.-R. Guo, and E.R. Westwater, 1993: Assimilation of Precipitable Water into a Mesoscale Numerical Model. *Mon. Weather Rev.*, **121**, 1215-1238.

Lindzen, R.S., 1994: Climate dynamics and global change, *Annu. Rev. Fluid Mech.*, **26**, 353-378.

Trenberth, K.E., and C.J. Guillemot, 1995: Evaluation of the global atmospheric moisture budget as seen from analyses. *J. Climate*, **8**, 2255-2272.

Ware, R., M. Exner, D. Feng, M. Gorbunov, K. Hardy, B. Herman, Y. Kuo, T. Meehan, W. Melbourne, C. Rocken, W. Schreiner, S. Sokolovskiy, F. Solheim, X. Zou, R. Anthes, S. Businger, and K. Trenberth, 1996: GPS sounding of the atmosphere from low Earth orbit: Preliminary results. *Bull. Amer. Meteor. Soc.*, **77**, 19-40.

Zou, X., Y.-H. Kuo, and Y.-R. Guo, 1995: Assimilation of atmospheric radio refractivity using a nonhydrostatic adjoint model. *Mon. Wea. Rev.*, **123**, 2229-2249.

Project to Interface Modeling on Global and Regional Scales With EOS Observations

Principal Investigator – **Robert E. Dickinson**

Science Background

Climate models have several important roles that require their further improvement. They are the major tool in projecting future climate change from increasing greenhouse gases, thus providing a basis for planning adaptation to future climate change and possible limitations on the production of greenhouse gases by international convention. They also provide useful predictions of interannual climate variability resulting from El Niño and other mechanisms. Finally, they are the scientific basis for the 4-dimensional data assimilation technology used for analysis of many of the EOS remote-sensing products. Land processes and their interaction with the atmosphere are important elements of climate models and EOS observations. The various activities in this investigation are directed toward improving the interaction of land processes with the atmosphere in climate models, hence improving the use of climate models for the prediction of global change and for data assimilation through the application of EOS data. The analysis and comparison of these data to model results improve the formulation of processes in current climate models and give a better understanding of the underlying physical processes.

Science Goals

The primary foci of this investigation are to: 1) develop new methods for using EOS observations to assess and improve climate-model treatments of surface-atmosphere interactions and the hydrological cycle; 2) develop and apply methods to obtain, archive, and enhance geophysical parameters from EOS sensors that will improve those components of climate models; and 3) analyze and improve those aspects of climate models most related to the coupling between land and the atmosphere, including the numerical simulations required to design and test such improvements.

Current Activities

Specific tasks currently being addressed to help meet the overall objectives are:

Development of algorithms and data sets: Appropriate treatments are being developed for: an hourly skin temperature from the twice-daily MODIS skin-temperature product; a roughness-length data set which will use

MODIS land cover information along with observations of past field studies to estimate the aerodynamic roughness length and displacement height; a fractional vegetation-cover product based on the observed skin temperatures along with NDVI, LAI, and vegetation type; and an albedo for use in climate models derived from the MODIS albedo and BRDF products and allowing for required spectral and solar-zenith dependencies. Questions related to the most suitable methods for scaling-up of the various surface parameters to the resolution of climate models are being addressed.

Modeling issues: Data sets needed for climate model boundary conditions are being developed from EOS observations on a 0.1° spatial mesh. Prior to the availability of such observations, preliminary such data are derived from the 1-km AVHRR product of the land DAAC and from intermediate products derived by various EOS participants. Software is developed that scales the observations on the 0.1° grid to various resolutions used by climate models. Studies are done with versions of the NCAR Community Climate Model to test the boundary conditions so derived, to determine what model resolutions can make most effective use of EOS observations, to establish the nature of climate-simulation improvement provided by EOS data, and to prototype the use of EOS observations for model improvement. Working in the context of the BATS and other land models, specific parameterizations are being improved related to the use of EOS observations that involve model surface temperatures and water and energy fluxes.

Use of Satellite Data

Various data (including snow cover, surface skin temperature, land cover, surface BRDF, surface albedo, LAI, and NDVI) from EOS Terra instruments (especially MODIS and MISR) will be used to derive skin-temperature diurnal cycle, roughness length, albedo, and vegetation fractional cover. These EOS data will also be used to validate and improve surface processes in climate models. Currently, one year global 10-day average 1-km AVHRR data (including all channels and derived NDVI) and global 1-km land cover data (with a total volume of about 200 GB) have been obtained from EROS DAAC to prototype our research efforts and to test our scientific computing facility.

Participation in Field Activities

We are contributing to various field activities (e.g., BOREAS, SALSA, CASES, and EOS instrument validation efforts) by providing modeling guidance and applications (e.g., selection of sites and timing, measurement accuracy requirements, use of the data for modeling parameterization) through presentations at related workshops/meetings and research involvement.

Product Dissemination

In collaboration with other groups, we are developing web-based archival systems to provide the products of our investigation to any users that may require them.

Principal Investigator

Robert Dickinson

Robert Dickinson has been contributing to the fields of climate modeling and global change research for over 30 years. He received his Ph.D. from the Massachusetts Institute of Technology in 1966 and shortly thereafter joined the staff of NCAR. In 1975, he became Head of the Climate Section and, in 1981, Deputy Director of the Climate and Global Dynamics Division. He joined the faculty of the Department of Atmospheric Sciences at the University of Arizona in 1990 and currently holds the position of Regents Professor. He has been active in many capacities as a member of the U.S. National Academy of Sciences, the American Geophysical Union, and the American Meteorological Society, as an editor for the *Journal of Climate* and through active participation in committees, panels, and working groups of the National Research Council, the International Geosphere Biosphere Programme, the World Climate Research Programme, and the Intergovernmental Panel on Climate Change. Awards received by Dr. Dickinson include: the AMS Meisinger Award in 1973, the AMS Julie G. Charney Award in 1988, the AMS Walter Orr Roberts lecturer in Interdisciplinary Sciences in 1995, the AMS Rossby Award in 1996, the AGU Roger Revelle Medal in 1996 and the G. Unger Vetlesen Prize from the Lamont-Doherty Earth Observatory of Columbia University in 1995.

Co-Investigators

William Emery - *University of Colorado*

References

Arain, A.M., W.J. Shuttleworth, Z.-L. Yang, J. Michaud, and A.J. Dolman, 1997: Mapping surface cover parameters using aggregation rules and remotely-sensed cover classes. *Quart. J. Roy. Meteor. Soc.*, **123**, 2325-2348.

Dickinson, R.E., 1999: Interannual Variability of Climate - A Review. *Global Biogeochem. Cycles-Special Issue*, in press

Dickinson, R.E., M. Shaikh, R. Bryant, and L. Graumlich, 1998: Interactive canopies for a climate model. *J. Climate*, **11**, 2823-2836.

Jin, M., and R.E. Dickinson, 1999: Interpolation of surface radiation temperature measured from polar orbiting satellites to a diurnal cycle, Part 1: Without clouds. *J. Geophys. Res.*, **104**, 2105-2116.

Dickinson, R.E., and K.J. Schaudt, 1998: Analysis of timescales of response of a simple climate model. *J. Climate*, **11**, 97-106.

Schaudt, K.J., 1998: A new method for estimating roughness parameters and evaluating the quality of observations. *J. App. Meteor.*, **37**, 470-476.

Seth, A., R. Baies, and R.E. Dickinson, 1999: A framework for the study of seasonal snow hydrology and its interannual variability in the alpine regions of the Southwest. *J. Geophys. Res.*, in press.

Seth A., and F. Giorgi, 1999: The effects of domain choice on summer precipitation simulation and sensitivity in a regional climate model. *J. Climate*, in press.

Shuttleworth, W.J., Z.-L. Yang, and A.M. Arain, 1997: Aggregation rules for surface parameters in global models. *Hydro. Earth Sys. Sci.*, **2**, 217-226.

Yang, Z.-L., R.E. Dickinson, W.J. Shuttleworth, and M. Shaikh, 1999: Treatment of soil, vegetation and snow in land-surface models: A test of the Biosphere-Atmosphere Transfer Scheme with the HAPEX-MIBILHY, ABRACOS and Russian data. *J. Hydrol.*, in press.

Zeng, X., and R.E. Dickinson, 1998: Effect of surface sublayer on surface skin temperature and fluxes. *J. Climate*, **11**, 537-550.

Zeng, X., Y.-J. Dai, R.E. Dickinson, and M. Shaikh, 1998: The role of root distribution for land climate simulation over land. *Geophys. Res. Lett.*, **25**, 4533-4536.

Zeng, X., 1999: The relationship between precipitation cloud-top temperature, and precipitable water over the tropics. *J. Climate*, in press.

Investigation URL

http://www.atmo.arizona.edu/land/uofa_land.html

The Global Soil Wetness Project

Principal Investigator – **Paul A. Dirmeyer**

Science Background

The Global Soil Wetness Project (GSWP) is an ongoing modeling activity of the International Satellite Land-Surface Climatology Project (ISLSCP), a contributing project of the Global Energy and Water Cycle Experiment (GEWEX). The GSWP is charged with producing a 2-year global data set of soil moisture, temperature, runoff, and surface fluxes by integrating one-way uncoupled land-surface process models (LSPs) using externally specified surface forcings and standardized soil and vegetation distributions, namely, the ISLSCP Initiative I CD-ROM data (Sellers et al. 1996a). Approximately one dozen participating LSP groups in five nations have taken the common ISLSCP forcing data to execute their state-of-the-art models over the 1987-1988 period to generate global data sets. See IGPO (1995) or Dirmeyer et al. (1999) for further details.

The motivation for GSWP stems from the paradox that soil wetness is an important component of the global energy and water balance, but it is unknown over most of the globe. Soil wetness is the reservoir for the land-surface hydrologic cycle, it is a boundary condition for the atmosphere, it controls the partitioning of land-surface heat fluxes, affects the status of overlying vegetation, and modulates the thermal properties of the soil. Knowledge of the state of soil moisture is essential for climate predictability on seasonal-to-annual time scales. However, soil moisture is difficult to measure in situ, remote-sensing techniques are only partially effective, and few long-term climatologies of any kind exist.

Science Goals

The goals of GSWP are fourfold. The project will produce state-of-the-art global data sets of soil moisture, surface fluxes, and related hydrologic quantities. It is a means of testing and developing large-scale validation techniques over land. It serves as a large-scale validation and quality check of the ISLSCP Initiative I data sets. GSWP is also a global comparison of a number of LSPs, and includes a series of sensitivity studies of specific parameterizations which should aid future model development.

Current Activities

The GSWP consists of three components: the Production Group, the Validation Group, and the Inter-Comparison Center. The Production Group consists of land-surface modelers who conduct offline integrations of land-surface models over a global 1° grid for 1987-1988 using prescribed atmospheric forcing based on observations, remote sensing, and analyses. Each member of the production group produces global time-mean and instantaneous fields of surface-energy and water-balance terms three times per month using his/her model. These data are produced in a standard format and sent to the Inter-Comparison Center. In addition, each model is used to perform specific sensitivity studies. The sensitivity experiments are intended to evaluate the impact of uncertainties in model parameters and forcing fields on simulation of the surface-water and energy balances.

There is also a Validation Group which assembles data sets and coordinates studies to validate the global products, either directly (by comparison to field studies or soil-moisture measuring networks) or indirectly (e.g. use of modeled runoff to drive river-routing schemes for comparison to streamflow data). The soil-wetness data produced are being tested within a general circulation model (GCM) to evaluate their quality and their impact on seasonal-to-interannual climate simulations. The Winand Staring Centre has volunteered to lead the validation process.

An Inter-Comparison Center (ICC) has been established at the Center for Climate System Research, University of Tokyo, for evaluating and comparing data from the different models. Comparison among the model results is used to assess the uncertainty in estimates of surface components of the moisture and energy balances at large scales, and as a quality check on the model products themselves.

Use of Satellite Data

The project relies heavily on the ISLSCP Initiative I data sets, produced and stored at the NASA/Goddard DAA. Many aspects of these data are based on remote-sensing data. Virtually all of the vegetation-cover data are derived from Fourier-adjustment, solar-zenith-angle-corrected, In

terpolated Reconstructed (FASIR) Normalized Difference Vegetation Index (NDVI) products derived from the Advanced Very High Resolution Radiometer (AVHRR), as described by Sellers et al. (1996b). In addition, the high-resolution surface shortwave and longwave radiation fluxes used to drive the models were calculated from a hybrid of ISCCP-C1 data (Darnell et al. 1992) and ECMWF analyses, prepared at NASA/Langley Research Center.

Principal Investigator
Paul A. Dirmeyer

Dr. Dirmeyer received his Ph.D. from the University of Maryland in 1992 and joined the research staff at the Center for Ocean-Land-Atmosphere Studies shortly thereafter. He has conducted research into the role of the land surface in climate variability and predictability, as well as in land-surface model development. He is chair of the GEWEX Global Soil Wetness Project (GSWP), a member of the International Satellite Land-Surface Climatology Project (ISLSCP) Science Panel, and the NCAR Climate System Model - Land Model Working Group. He has been a member of the American Meteorological Society since 1985, and a member of the American Geophysical Union since 1990. He has served on panels of the NOAA Office of Global Programs, GEWEX Continental-scale International Project (GCIP), NASA Earth Science Enterprise, and the Intergovernmental Panel on Climate Change.

Co-Investigators

Pavel Kabat - *Winand Staring Centre*

A. J. Dolman - *Winand Staring Centre*

References

Darnell, W.L., W.F. Staylor, S.K. Gupta, N.A. Ritchey, and A.C. Wilber, 1992: Seasonal variation of surface radiation budget derived from ISCCP-C1 data. *J. Geophys. Res.*, **97**, 15,741-15,760.

Dirmeyer, P.A., A.J. Dolman, and N. Sato, 1999: The Global Soil Wetness Project: A pilot project for global land surface modeling and validation. *Bull. Amer. Meteor. Soc.*, **80**, 851-878.

International GEWEX Project Office, 1995: Global Soil Wetness Project, 47 pp.

Sellers, P.J., B.W. Meeson, J. Closs, J. Collatz, F. Corprew, D. Dazlich, F.G. Hall, Y. Kerr, R. Koster, S. Los, K. Mitchell, J. McManus, D. Myers, K.-J. Sun, and P. Try, 1996: The ISLSCP Initiative I global datasets: Surface boundary conditions and atmospheric forcings for land-atmosphere studies. *Bull. Amer. Meteor. Soc.*, **77**, 1987-2005.

Sellers, P.J., S.O. Los, C.J. Tucker, C.O. Justice, D.A. Dazlich, G.J. Collatz, and D.A. Randall, 1996: A revised land surface parameterization (SiB2) for atmospheric GCMs. Part II: The generation of global fields of terrestrial biophysical parameters from satellite data. *J. Climate*, **9**, 706-737.

Investigation URL

<http://www.iges.org/gswp/>

Hydrology, Hydrochemical Modeling, and Remote Sensing In Seasonally Snow-covered Alpine Drainage Basins

Principal Investigator – Jeff Dozier

Science Background

Seasonally snow-covered areas of the Earth's mountain ranges are an important component of the Earth's hydrologic cycle, even though they cover only a small fraction of the Earth's surface. These alpine regions are a major source of water for runoff, ground-water recharge, and agriculture. Moreover, these regions are sensitive to changes in climate and to the amount and chemistry of snowfall, because of their small ground-water reservoirs, the predominance of intrusive igneous rocks that weather slowly, thin acidic soils, the large amount of precipitation, and typical basin low-buffering ability. Because of this sensitivity, changes in precipitation chemistry translate into changes in stream chemistry more rapidly than in basins with deeper soils.

Knowledge of the hydrologic cycle in these areas is limited by poor understanding of the processes that determine the cycle. We have imprecise knowledge about the spatial and temporal distribution of the rate of snow melt, water flow in the snow and its chemical concentrations, and the routing of water from the snow pack through the drainage basin. Because of the topographically complex terrain in alpine basins, it is difficult to collect sufficient data to characterize and model these processes.

Science Goals

In an attempt to gain better understanding of Alpine Basin Hydrology, this investigation will use remotely-sensed data from several EOS-era instruments in conjunction with field data to study hydrologic conditions in watersheds and to drive hydrologic models. It seeks a fundamental understanding of the cycling of water, chemical species, and nutrients in alpine basins, and thus an ability to identify changes caused by changing climate or changing precipitation chemistry.

Current Activities

Snow mapping at subpixel resolution with Landsat TM and NOAA AVHRR data: We have developed automated,

unsupervised spectral-mixture analysis techniques for mapping snow-covered area at subpixel resolution. The mixture analysis permits estimation of fractional snow cover for 30-m or 1.1-km pixels. The technique was verified with high-resolution (<1 m) aerial photos, is as accurate as the photos, but can be used over much larger areas at much lower cost. The technique is being extended to MODIS data.

Snow and grain-size mapping at subpixel resolution and estimation of surface liquid water with AVIRIS (Airborne Visible and Infrared Imaging Spectrometer): Spectral-mixture analysis with a library of modeled snow spectral reflectances and measured spectral reflectances (vegetation, rock, soil, lake ice) facilitates estimation of the fraction of snow in each 20-m pixel and the surface grain size of that snow. Knowledge of the grain size allows calculation of the spectral albedo of the snow, independent of the albedo of the other constituents in the pixel. The algorithm is now automatic and will be portable to MODIS data. Modeling results show that we can derive liquid-water content of a thin surface layer.

Synthetic aperture radar (SAR) investigations with data from AIRSAR and SIR-C/IX-SAR: With an airborne or spaceborne SAR, snow can be mapped in any weather condition with an accuracy of about 85%. Although instruments in the optical wavelengths, e.g., Landsat, provide more-accurate snow maps, they are restricted to clear weather. The liquid-water content in the top layer of the snow pack can be estimated with an accuracy of about 2% by volume from SAR. It provides the information on melting status of snow pack. SAR data can also estimate the snow-water equivalence (SWE), which is the most important parameter for hydrologic applications. Combining this information into a distributed snow-melt model that predicts the timing and magnitude of snow-melt runoff from energy-balance parameters is one of our future challenges. Such a model could be a powerful management tool for forecasting runoff, and, hence, maximizing water yield and minimizing the impacts of floods.

Biogeochemical modeling: Biogeochemical modeling of 3 catchments in the Sierra Nevada has been completed and continues at two catchments in the Rocky Mountains. The completed modeling shows that alpine

catchments are sensitive to changes in climate and atmospheric deposition. The modeling also shows that areas of rock in alpine catchments, that were previously considered unreactive, are reactive and produce cations and immobilize nitrogen in alpine basins. In building a model for an alpine catchment, snow-covered area (SCA) is the most crucial data type. SCA dominates the hydrology of alpine basins and also has an effect on the biogeochemistry of alpine basins by insulating and thus warming the soil during the cold winter season.

Developing data-centric information management systems: Our studies of hydrology and hydro-chemistry systems result in an accumulation of massive amounts of scientific data. We are addressing the need to manage these large, complex data sets, so that the data are effectively and efficiently ingested, stored, maintained, retrieved, and analyzed. Evolving systems are being used for handling imagery, managing field data, and creating scientific products. Some capabilities of the systems include the ability to store and retrieve data from disparate computing environments in a "seamless" fashion; generate scientific products; access a variety of analysis tools; track processes applied to data; view imagery, field notes, and maps; browse and select data of interest over the Internet; and provide an intuitive user interface.

Use of Satellite Data

In the EOS era, techniques initially carried out with Landsat TM, NOAA AVHRR, and AVIRIS data will be extended to subpixel snow extent and grain-size mapping from MODIS and ASTER. With such analyses, MODIS will be useful in alpine regions. SAR investigations that are now being pursued with advanced aircraft-mounted systems may be continued using simplified techniques with single-frequency, single-polarization SAR instruments such as those on ERS-2, JERS-1, and Radarsat to provide useful snow-mapping data.

Participation in Field Programs

Examination of the biogeochemistry of mixed-conifer catchments in the Sierra Nevada using 12 years of data on precipitation inputs, stream discharge, and stream chemistry has shown that precipitation over the period varied widely, but that chemistry precipitation was similar. Solute concentrations were higher in rain than in snow, and dry deposition constituted a major portion of the nitrogen and sulfur inputs. Although soil alkalinity buffered acidic inputs from wet deposition, brief decreases in stream pH occurred during larger storms. These data show that the close relationship between precipitation chemistry and stream chemistry occurs in the subalpine forested zone, as well as in the high alpine zone with only sparse trees and thin soils.

In the Tokopah drainage of the Sierra Nevada range, measurements were obtained of depth and density of the snowpack suitable for estimating the distribution and ablation of SWE throughout the 1997 melt season. The survey data, in combination with remotely sensed data (TM and AVIRIS), are currently being used in the application and comparison of various methods of determining SWE; the development of basin water balances; an investigation of the relationship between SWE accumulation and terrain attributes; the initialization, calibration, and validation of distributed hydrological and hydrochemical models; and the development of methods for distributed snowmelt model validation.

Field measurements in the Rocky Mountains have investigated nitrogen-cycling processes under the snow pack. The data show a trend in the last decade toward nitrogen saturation in the high-elevation catchments. Normally these basins do not export nitrogen; the biota consume all the nitrogen before it leaves the basin. However, deposition of extra nitrogen in the precipitation has apparently caused these basins to become nitrogen saturated.

A large, collaborative remote-sensing and field campaign was conducted in Spring 1996 in the Rocky Mountain National Park. Immediate uses of the campaign include snow-water-equivalence and snowmelt modeling, and further development of algorithms to retrieve snow surface information from remotely sensed imagery.

Principal Investigator

Jeff Dozier

Jeff Dozier, Dean of the Donald Bren School of Environmental Science and Management, University of California, Santa Barbara, received his B.A. from California State University, Hayward in 1968 and his Ph.D. from the University of Michigan in 1973. He has taught at UC Santa Barbara since 1974. From 1990-1992 he served as the EOS Senior Project Scientist. He has published extensively in diverse fields of research including snow hydrology, Earth system science, radiative transfer in snow, remote sensing and data systems, image processing, and terrain analysis. With Dr. Ghassem Asrar he is the co-author of EOS: Science Strategy for the Earth Observing System (American Institute of Physics, 1994). He is a Fellow of the American Geophysical Union, a Distinguished Visiting Scientist at the Jet Propulsion Laboratory, and an Honorary Professor of the Chinese Academy of Sciences. From 1990-1993 he was Editor of Geophysical Research Letters. For the National Research Council, he is a member of the Climate Research Committee and also serves on the Scientific and Technical Advisory Panel of the National Intelligence Council. In 1993 he received the NASA Public Service Medal, was the 1997 Moe I. Schneebaum Lecturer at NASA GSFC, and now serves on the Earth System Science and Applications Advisory Committee (ESSAAC).

Co-Investigators

Roger Bales - University of Arizona

John Melack - University of California

Kathy Tonnessen - National Biological Service/National Park Service

Mark Williams - University of Colorado

References

- Aizen, V., E. Aizen, J.M. Melack, and J. Dozier, 1997: Climatic and hydrologic changes in the Tien Shan, central Asia. *J. Climate*, **10**, 1393-1404
- Brooks, P.D., M.W. Williams, and S.K. Schmidt, 1996: Microbial activity under alpine snowpacks, Niwot Ridge, Colorado. *Biogeochemistry*, **32**, 93-113.
- Brooks, P.D., S.K. Schmidt, M.W. Williams, 1997: Winter production of CO₂ and N₂O from alpine tundra: environmental controls and relationship to intersystem C and N fluxes. *Oecologia*, **110**, 403-413.
- Melack, J.M., J. Dozier, C.R. Goldman, D. Greenland, A. Milner, and R.J. Naiman, 1997: Effects of climate change on inland waters of the Pacific coastal mountains and western Great Basin of North America. *Hydrological Processes*, **11**, 971-992.
- Painter, T.H., D.A. Roberts, R.O. Green, J. Dozier: Improving spectral mixture analysis of snow-covered area with AVIRIS data. *Remote Sens. Environ.*, in press.
- Rosenthal, W., and J. Dozier, 1996: Automated mapping of montane snow cover at subpixel resolution from the Landsat Thematic Mapper. *Water Resour. Res.*, **32**, 115-130.
- Shi, J., and J. Dozier, 1995: Inferring snow wetness using C-Band data from SIR-C's polarimetric Synthetic Aperture Radar. *IEEE Trans. Geosci. Remote Sens.*, **33**, 905-914.
- Shi, J., and J. Dozier, 1997: Mapping Seasonal Snow with SIR-C/X-SAR in Mountainous Areas. *Remote Sens. Environ.*, **59**, 294-307.
- Williams, M.W., J.S. Baron, N. Caine, R.A. Sommerfeld, and R. Sanford Jr., 1996: Nitrogen saturation in the Rocky Mountains. *Environ. Sci. Technol.*, **30**, 640-646.
- Williams, M.W., M.V. Losleben, N. Caine, and D. Greenland, 1996: Changes in climate and hydrochemical responses in a high-elevation catchment in the Rocky Mountains, USA. *Limnology and Oceanography*, **41**, 939-946.
- Williams, M., and J.M. Melack, 1997: Atmospheric deposition, mass balances, and processes regulating streamwater solute concentrations in mixed conifer catchments of the Sierra Nevada, California. *Biogeochemistry*, **37**, 111-144.
- Wolford, R.A., and R.C. Bales, 1996: Hydrochemical modeling of Emerald Lake watershed, Sierra Nevada, California: Sensitivity of stream chemistry to changes in fluxes and model parameters. *Limnology and Oceanography*, **41**, 947-954.
- Wolford, R.A., R.C. Bales, and S. Sorooshian, 1996: Development of a hydrochemical model for seasonally snow-covered alpine watersheds: Application to Emerald Lake watershed, Sierra Nevada, California. *Water Resour. Res.*, **32**, 1061-1074.
- Zurk, L.M., L. Tsang, J. Shi, and R.E. Davis, 1997: Electromagnetic scattering calculated from pair distribution functions retrieved from planar snow sections. *IEEE Trans. Geosci. Remote Sens.*, **35**, 1419-1428.

Investigation URL

<http://www.icess.ucsb.edu/hydro/hydro.html>

Combining Remote Sensing and Hydrological Modeling for Applied Water and Energy Balance Studies

Principal Investigator – **Ralph Dubayah**

Science Background

An improved understanding of the continental and global water and energy cycle is crucial to our ability to predict and plan for global change in the next century. Of particular importance is the role of the land surface in controlling the spatial and temporal dynamics of these cycles, and the resulting effects on surface hydrology. Consequently, there has been intense research activity aimed at improving the representation of the land surface in models used for climate simulation, weather prediction, and water management. However, performing large-scale applications of these models is greatly complicated by the scarcity of land-surface observations. In many areas of the world, the data needed to drive such models do not exist, so that water management and forecasting are fraught with uncertainty. Many of the most data-deficient areas are underdeveloped regions of the world that are at high risk for water-related disasters, such as floods and droughts.

The use of remote-sensing data from existing space platforms, as well as those from the planned EOS suite of sensors, promises to revolutionize our knowledge by providing alternatives to the ground observations upon which hydrological modeling is presently based.

Science Goal

The major science goal of this investigation is to improve hydrologic prediction capabilities for water-resource management at continental scales through the development of coupled hydrologic and land-surface models that are driven by remotely sensed data. As a consequence, our research objectives involve the development and assessment of remote-sensing methods to provide input forcings for hydrologic models, as well as strategies for using remote-sensing data to update hydrologic state variables in these models. Through these efforts we also hope to obtain a better understanding of the spatial and temporal variability of the water and energy balances, and the contributing role of land-surface characteristics and near-surface atmospheric dynamics.

Current Activities

In collaboration with other EOS IDS investigators, we have undertaken an initial study of the Red River-Arkansas basin of the Mississippi, the focus of a recent project for the Intercomparison of Land Surface Parameterization Schemes (PILPS) model intercomparison. Our activities in this basin serve as a framework for our future work and are focused on:

- 1) ground and satellite data acquisition;
- 2) generation of environmental forcing fields from these data; and
- 3) water-and-energy balance studies using the two-layer Variable Infiltration Capacity model (VIC-2L), a hydrologically based land-surface scheme.

The strategy is to first drive our models using in situ observations. To that end, we are developing a method for real-time gridding of surface precipitation and temperature fields based on station data. Subsequently, as many of the model input fields as possible will be derived using remote-sensing methods, and model results will then be compared to simulations using only surface data. Based on our experience in the Red River-Arkansas basin, we have begun similar work for the entire Mississippi basin, an area of intense modeling and field activity within the context of the GEWEX Continental Scale International Project (GCIP).

Coincident with these specific modeling efforts, we are engaged in general research centered around the use of remotely sensed data in hydrological modeling. Our first activity is the development and validation of remote-sensing methods to derive input fields for hydrological modeling by integrating satellite data from multiple platforms at varying spatial and temporal resolutions. Secondly, we are working towards evolving our hydrologic model structure so that it can better exploit current and EOS-era remote-sensing products. For instance, with an appropriately designed model, remote-sensing data may be used not only as driving inputs, but also to update model state variables such as surface temperature, so that over time model outputs do not diverge from observed environmental conditions.

Use of Satellite Data

A central goal of this research is to combine remote sensing with hydrological modeling; therefore, our work relies heavily on satellite data. We have used a variety of existing remote-sensing data in our investigation thus far, including AVHRR, GOES, TOVS, Landsat, and a variety of passive and active microwave sensors, all guided primarily by required model input fields for VIC-2L. These fields include incoming solar radiation, surface albedo, incoming longwave radiation, air temperature, vapor pressure deficit, precipitation, wind, and surface characteristics such as vegetation, soils, and topography. In addition, model-state-variable updating may require data on surface temperature, soil moisture, and snow cover.

We use GOES data to derive incoming solar radiation at fine temporal resolution (30 minutes) with coarse spatial resolution (nominal 1 km). Data from the GOES water-vapor channel are also used to find total column precipitable water vapor. AVHRR data are used to derive near-surface air temperature, precipitable water vapor, near-surface humidity, and surface temperature. AVHRR imagery are also used to obtain vegetation data (NDVI), and from this, seasonal changes in fractional PAR, fractional forest cover and leaf-area index (LAI). The TOVS instrument on board NOAA polar orbiters provides coarse-resolution estimates of air and surface temperature. Lastly, we are exploring the use of radar and microwave data for temperature, soil moisture, and snow cover from instruments such as SIR-C and SMMR-SSM/I.

Participation in Field Programs

We intend to participate in field activities planned for the GCIP North Central (Upper Mississippi River basin) and East (Ohio and Tennessee-Cumberland River basin Large Scale Study Areas (LSAs)). GCIP plans to move its focus from LSA-SW (Arkansas-Red River basin) to North Central, and subsequently East, over the next two years. A current focus of our modeling is the development of an improved algorithm to simulate frozen soils and associated effects on infiltration and soil thermal characteristics. One aspect of this work may be in situ observations to verify the ability of SAR to delineate the extent of frozen soils. We are also participating in CASES, the Cooperative Atmosphere-Surface Exchange Study, a surface-boundary layer experiment initiated in the Walnut River basin in Kansas, in the spring of 1997. With others, our field work there is aimed at characterizing the spatial variability of soil moisture.

Overview and Objectives

The estimation of the spatial and temporal variability of the hydrologic and energy budgets of the land surface is a central objective of studies such as GCIP, and is crucial for improved climate simulation, numerical weather prediction, and water resources management. Macroscale hydrological modeling is a powerful tool with which to develop predictive understanding of the large-scale dynamics of these budgets. However, hydrological modeling at continental scales and beyond is greatly hindered by the scarcity of land-surface observations needed to drive the models.

Remote sensing promises to revolutionize large-scale hydrological modeling by providing an alternative to the use of ground observations that historically have been the sole model forcings. The challenge is to design hydrologic model structures and remote-sensing methodologies that make best use of the largely untapped potential of satellite observations for water-resources management during the EOS era.

Principal Investigator

Ralph Dubayah

Ralph Dubayah received his B.A. (1982) in geography from the University of California, Berkeley, and his M.A. (1986) and Ph.D. (1990) degrees in geography from the University of California, Santa Barbara. His research interests include land-surface energy balance, hydrology, topographic and spatial analysis, and remote sensing. He is principal investigator for the Vegetation Canopy Lidar (VCL), a NASA Earth System Science Pathfinder (ESSP) mission to map the structure of the Earth's forests and topography. He is currently Associate Professor at the University of Maryland, College Park, and holds a joint appointment in Geography and the University of Maryland Institute for Advanced Computer Studies (UMIACS).

Co-Investigator

Dennis P. Lettenmaier - *University of Washington*

References

Dubayah, R., E.F. Wood, and D. Lettenmaier, 1995: Combining hydrological modeling and remote sensing for large scale water and energy balance studies. Proc. International Geosciences and Remote Sensing Symposium (IGARSS '95), Florence, Italy.

Dubayah, R., E.F. Wood, T.E. Engman, K. Czajkowski, and M. Zion, 1997: A remote sensing approach to macroscale hydrological modeling. Remote Sensing in Hydrology and Water Management, G. Schultz, and E. Engman, Eds., Springer-Verlag, Berlin.

Investigation URL

<http://www.inform.umd.edu/geog/eos>

Liang, X., D.P. Lettenmaier, E.F. Wood, 1996: One-dimensional statistical dynamic representation of subgrid spatial variability of precipitation in the two-layer variable infiltration capacity model. *J. Geophys. Res.*, **101**, 21,403-21,422.

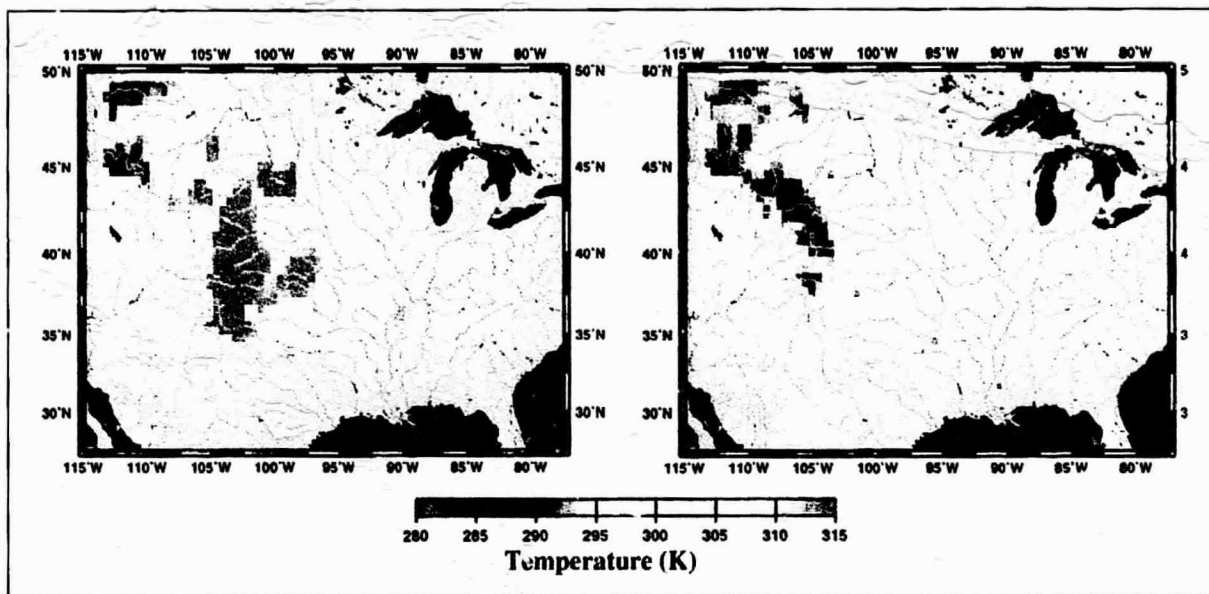

The advantage of satellite-based temperature estimation is the ability to continuously map over large regions. The images above show surface temperature (left) and air temperature (right) retrievals for the entire Mississippi basin at the AVHRR overpass time for 19 June, 1987. Note the relative difference between the two fields and the area of considerably warmer surface temperatures to the west, and the cooler air temperatures in the mountains forming the western border of the basin. (After Dubayah and Lettenmaier, 1997.)

Direct Use of Satellite Remote Sensing in the Estimation of Hydrologic Transports

Principal Investigator – **Dara Entekhabi**

Science Goal

The key objective of this proposal is to develop the capability to directly use data from remote-sensing instruments such as those on Terra (MODIS and CERES visible and infrared) in hydrologic processes studies. The project will use existing archives of satellite observations (ERBE and SSM/I at Langley DAAC) in these spectral regions together with robust dry static energy information from reanalyses (GEOS-1 NASA DAO) in a new approach to the estimation of hydrologic transports using these data. The project is directed towards the development of data products on land runoff and other components of the surface water and energy budget over the GEWEX continental scale basin experiments (GCIP, GAME, LBA, and MAGS basins). The development of the new methodology is in response to the severe limitations on the applicability of the current archive of satellite data and future suite of planned satellite missions in the quantitative characterization of the hydrologic cycle. It is also in response to the need to estimate land runoff and other components of the hydrologic cycle when instruments (river gages and radiosondes vapor data) have large measurement errors.

The hydrologic flux data (vapor convergence and runoff) produced by this project are essentially based on applying coupled atmospheric energy and water budget equations. Components of these equations are estimated using assimilated data on thermal and wind structure, and constraining these equations by high-quality visible and thermal-infrared satellite observations. These estimates form a third and independent estimate of the land and areal runoff (in addition to river gage and atmospheric vapor convergence estimates that may be compared to GEWEX continental scale basin experiment estimates based on in situ observations by river gages and vapor transport radiosondes/reanalyses).

Principal Investigators

Dara Entekhabi

Dara Entekhabi is currently an associate professor in the Department of Civil and Environmental Engineering and Department of Earth, Atmospheric, and Planetary Science at the Massachusetts Institute of Technology (MIT). His area of research interest includes land remote sensing, hydrologic data assimilation, land-atmosphere interaction,

and groundwater-surface water interaction. He received his bachelor's and two Master's degrees at Clark University (1983, 1985, 1987) and his doctoral degree at MIT. Dara Entekhabi was awarded the American Geophysical Union's Macelwane young scientist award as well as the National Science Foundation's Presidential Young Investigator's award. He is currently the chair of the National Research Council Committee on Hydrologic Science.

Co-Investigators

Rafael L. Bras - *Massachusetts Institute of Technology*

Guido D. Salvucci - *Boston University*

References

- Entekhabi, D., I. Rodriguez-Iturbe, and R.L. Bras, 1992: Variability in large-scale water balance with landsurface-atmosphere interaction. *J. Climate*, **5**, 798-813.
- Brubaker, K.L., D. Entekhabi, and P.S. Eagleson, 1993: Estimation of continental precipitation recycling. *J. Climate*, **6**, 1077-1089.
- Salvucci, G.D., and D. Entekhabi, 1995: Hillslope and climatic controls on hydrologic fluxes. *Water Resources Res.*, **31**, 1725-1740.
- Njoku, F.G., and D. Entekhabi, 1995: Passive microwave remote sensing of soil moisture. *J. Hydrol*, **184**, 101-130.
- Brubaker, K.L., and D. Entekhabi, 1996: Analysis of feedback mechanisms in land-atmosphere interaction. *Water Resources Res.*, **32**, 1343-1357.
- Kim, C-P., and D. Entekhabi, 1998: Analysis of feedback mechanisms in the uncoupled and coupled land surface and mixed layer energy budgets. *Boundary Layer Meteorology*, **88**, 1-21.
- Cohen, J., and D. Entekhabi, 1999: Eurasian snow cover variability and Northern Hemisphere climate predictability. *Geophys. Res. Lett.*, **26**, 345-348.

Representing Key Phytoplankton Groups in Ocean Carbon Cycle Models

Principal Investigator – **Paul G. Falkowski**

Project Summary

A quantitative understanding of the global carbon cycle is essential for the assessment of anthropogenic effects on the Earth's environment. Such an understanding requires the integration of ecological processes in mathematical models. We propose to develop and integrate observational data with mathematical models leading to the development of a comprehensive biogeochemical representation of key functional groups in the ocean carbon cycle. Specifically, we propose to:

- 1) develop satellite-based observational approaches for distinguishing major functional biological groups, including nitrogen fixers, diatoms, and coccolithophores, that influence the temporal and spatial distribution of sources and sinks for carbon dioxide in the world ocean;
- 2) develop modeling approaches for incorporating these functional groups in ecosystem models; and
- 3) simulate the response of functional groups to future climate scenarios using coupled atmosphere-ocean models.

The primary goal of this proposal is to improve ocean carbon models by describing how physical and chemical forcing affects the statistical distribution of key functional phytoplankton groups. That information is critical to predicting how changes in ocean physics and chemistry will influence total and new production in future ocean-model scenarios. The proposed research effort will be coordinated with the Ocean Carbon-cycle Modeling Intercomparison Project (OCMIP), an international project initiated in 1995 by the Global Analysis, Interpretation and Modeling (GAIM) Task Force of the International Geosphere-Biosphere Program (IGBP). The results of the proposed research specifically would lead to the development of algorithms that predict how ocean physics and chemistry affect the spatial distribution of:

- 1) *Trichodesmium sp.*, the major nitrogen-fixing organisms;
- 2) diatoms, the major group responsible for export production;
- 3) coccolithophores, which, as a consequence of calcification, raise $p\text{CO}_2$; and
- 4) the polytaxonomic group of picoplankton, which, while they are the major carbon fixers, contribute little to carbon export.

The statistical distribution of these four functional groups will be analyzed using remotely sensed information in conjunction with sea-truth data, and, based on the statistics of their distributions, "functional group profiles" will be generated. The "functional group profiles" give a probability of encountering each of the four groups in each grid cell of an ocean general circulation model (OGCM). Based on these profiles, we can specify physical and chemical criteria that maximize and minimize the distributions of each group, and hence prospectively infer their distributions in climate-change scenarios. From knowledge of the distributions of each group, the forcing and feedback between ocean circulation, chemistry, and biological processes can be represented much more realistically in OGCMs.

The proposed research will examine the relationship between remotely sensed data products, such as ocean color, SST, and wind stress, with the spatial and temporal distribution of the key functional groups. We propose to develop algorithms that represent biogeochemical processes such as nitrogen fixation, calcification, and export production. The algorithms are intended to be included in OGCMs in which the effects of climate change on the spatial and temporal distributions can be explored.

This research effort combines capabilities in remote sensing with expertise in physiological ecology and ocean biogeochemical process models. This interaction will be facilitated by collaborations with key researchers that specialize in one or more of the individual functional groups

p

Principal Investigator
Paul G. Falkowski

Paul G. Falkowski is a Professor at the Institute of Marine and Coastal Sciences, Rutgers University. His research interests include phytoplankton ecology, biophysics, biogeochemical cycles, and symbiosis.

Since 1976, Falkowski has been a principal investigator under contract to the U.S. Department of Energy, to study primary production and the fate of phytoplankton carbon off the east coast of the U.S. He has worked extensively in the Atlantic and Pacific Oceans and in the Red Sea. His latest research efforts are directed towards understanding the factors limiting biological carbon fixation on geological and ecological time scales. He was involved in the SeaWiFS primary production algorithm development program and remote sensing of global biogeochemical cycles.

Born in 1951 and raised in New York City, Falkowski earned his B.S. and M.Sc. degrees from the City College of the City University of New York and his Ph.D. from the University of British Columbia. After a post-doctoral fellowship at the University of Rhode Island, he went to Brookhaven National Laboratory in 1976 to join the staff of the newly formed Oceanographic Sciences Division. He received tenure in 1984 and served as head of the division from 1986 to 1991. In 1998 he moved to Rutgers University. In 1992 he received a John Simon Guggenheim Fellowship. In 1996 he was appointed as the Cecil and Ida Green Distinguished Professor at the University of British Columbia. He has authored or coauthored over 150 papers in peer-reviewed journals and books, and has co-invented and patented a fluorosensing system which is capable of measuring phytoplankton photosynthetic rates nondestructively and in real time.

Co-Investigators

Richard Barber - *Duke University*

Integrating Biogeochemical, Ecological, and Hydrological Processes in a Dynamic Biosphere

Principal Investigator – **Jonathan Foley**

Science Background

The biosphere is undergoing fundamental, global-scale changes in response to land use, increases in atmospheric CO₂ concentration, and variations in climate. It is therefore of paramount importance to improve our understanding of the terrestrial ecosystem processes on a global scale. In particular, we must examine the dynamics of the terrestrial biosphere on a wide variety of timescales, from seasons to centuries.

To better understand global biospheric processes, and to evaluate their potential response to human activity, we are developing a new integrated dynamical model of the Earth's biosphere. Previous computer models of the globe's ecosystems have typically focused on the static, or equilibrium, state of the biosphere rather than the full range of ecological, biophysical, and biogeochemical processes occurring across different timescales. In addition, earlier models have traditionally focused on one particular aspect of the biosphere—either the vegetation cover itself, its water balance, or its carbon balance.

Our new, more integrated model, called the Integrated Biosphere Simulator (or IBIS), reconciles the disparity of previous ecosystem models by including the following processes:

- Land-surface processes (including the energy, water and momentum balance of the soil-vegetation-atmosphere system);
- ecosystem physiology and carbon-balance processes;
- vegetation dynamics;
- nutrient cycling and biogeochemistry; and
- continental-scale hydrology

In addition, IBIS is one of the first models that can simulate the long-term dynamics of vegetation and ecosystems at the global scale. Such models, often referred to as Dynamic Global Vegetation Models (DGVMS), can be used to investigate how the world's ecosystems may change over time in response to land use, long-term climatic variations, or climate change.

Science Goal

Our NASA Interdisciplinary Science Team (IDS) project (as part of NASA's Earth Science Enterprise) aims to further develop and validate this new integrated model of the Earth's biosphere. The ultimate goal of our project is to improve our understanding of the Earth's terrestrial biogeochemical and hydrologic cycles and their dynamic response to anthropogenic and natural changes in the environment.

Current Activities

Some of our current research activities include the following:

- *Development and Testing of IBIS*

In early 1999, we released IBIS-2, a dramatically improved version of the IBIS modeling system. IBIS-2 includes a much more comprehensive representation of terrestrial ecosystem processes than its predecessors, including detailed land-surface processes, ecosystem physiological processes, vegetation growth and competition, and soil carbon and nutrient cycling. The model has been extensively tested against site-specific biophysical measurements (mainly from flux towers), as well as spatially extensive ecological and hydrological data. Currently, we operate the model at both global and regional scales; two regions of particular interest to our group are the Amazon Basin and the Mississippi Basin.

Future developments of IBIS will focus on two major areas. First, we will be adding managed ecosystems to the model, including permanent croplands and pastures. Second, we will be adding explicit disturbance and age-dependence, to account for the effects of natural or human disturbance on ecosystems and their response over time.

We are continuing to evaluate the performance of the IBIS model against a hierarchy of data sets, including site-level flux measurements, regional syntheses of ecological or hydrological measurements, and global-scale remote-sensing products.

p

- *Development of a New Terrestrial Hydrological Systems Model: Rivers, Lakes, and Wetlands*

Another part of our IDS project is focused on the linkages between surface waters (including lakes, wetlands, and rivers) and the terrestrial biosphere.

In 1998, we completed the development of the HYDrological Routing Algorithm (HYDRA), which is linked to IBIS through a shared water-balance calculation. HYDRA operates at fairly high spatial resolution (~10 km, globally) to simulate the flow of water from land surfaces (through rivers, lakes, and wetlands) to the ocean. HYDRA is the first global model to explicitly link rivers, lakes, and wetlands as fully dynamical parts of the hydrologic cycle. We have also included man-made structures (i.e., dams and reservoirs) within HYDRA, to account for the management of terrestrial hydrological systems.

We are actively working to evaluate HYDRA simulations against observed patterns of lakes, wetlands, and river systems.

We have been using the IBIS and HYDRA models in the following suite of research applications:

- *DGVM Intercomparison Exercise*

One recent application of IBIS has been to simulate the possible transient changes in global vegetation cover that may result from future climatic change. We are currently participating in an IGBP-sponsored international project (coordinated by the Potsdam Institute for Climate Impacts Research in Germany) to evaluate the transient changes in global vegetation cover resulting from CO₂; and aerosol-induced climatic change, as simulated with the U.K. Hadley Centre Coupled Atmosphere/Ocean model. There are several ecosystem modeling groups participating in this project, including our EOS-IDS project, Sheffield University (UK), the Hadley Centre (UK), the Potsdam Institute for Climate Impacts Research (Germany), the Institute for Terrestrial Ecology (UK), and the Max Planck Institute for Biogeochemical Cycles (Germany).

In this comparison, we are emphasizing the possible transient changes in global vegetation cover and terrestrial carbon storage resulting from climate change and CO₂ fertilization. At the present time, the preliminary results of the comparison show that the models have a fair degree of agreement, but many unexplained differences remain.

- *Effects of Land Use on the Terrestrial Biosphere*

We are beginning to examine how changes in land cover can affect the behavior of different ecosystems across the world. Specifically, we are interested in how land

use may change terrestrial hydrological processes and the ability of terrestrial ecosystems to store carbon. We have already compared IBIS simulations against detailed measurements made at the University of Wisconsin Agricultural Experimental Station for different land-use practices (e.g., restored prairie versus several corn growing practices). Currently, we are conducting sensitivity studies with IBIS at regional and global scales, to investigate the potential changes in biogeochemical and hydrological processes that may accompany land-use and land-cover change.

We are also developing a new historical database of global land-use and land-cover change. To reconstruct spatially-explicit land-use and land-cover change over the last 100-200 years, we are developing a statistical land-cover data-assimilation technique that combines contemporary satellite data with historical land-use inventory data and other environmental data. Our first data set, representing the global distribution of permanent croplands from 1992 to 1700 at ~10-km resolution, was completed in early 1999.

In the immediate future, we will be working to incorporate the dynamics of human land use activities within IBIS. Because IBIS is a mechanistic, integrated, and fully dynamic ecosystem model (including dynamic representations of vegetation regrowth)—it is ideally suited for this purpose. We will use this modeling framework along with geographically-explicit data on changes in land use and land cover (along with historical climate and CO₂-concentration records) to examine changes in terrestrial carbon exchange over the last century.

- *Spatial & Temporal Variability in the Hydrological Systems of the Midwest*

Using our new modeling tools, we have been investigating the effects of atmospheric and terrestrial processes on the water balance and hydrology of the Upper Midwest. In this study, we are applying IBIS and HYDRA across the Upper Midwest, to examine the influence of climate variability on land-surface processes, the surface water balance, and changes in river discharge.

We are currently testing the performance of the IBIS and HYDRA models across the Mississippi Basin, using a combination of detailed in situ measurements (from long-term soil-moisture recording stations and flux towers) and spatially extensive hydrographic data (gauging station data collected by the USGS).

- *Exploring Climate and Vegetation Interactions*

In a related NSF-funded project, we have incorporated IBIS directly within the GENESIS atmospheric GCM in collaboration with David Pollard at Penn State Uni-

versity and Starley Thompson at NCAR. With this fully coupled climate-vegetation model, we are evaluating the potential for vegetation feedbacks on the Earth's climate. In particular, we have found that scenarios of future climate change may need to be re-evaluated to consider the potential for vegetation feedbacks. Some specific questions we are considering include the following:

1. What might be the combined impacts of tropical deforestation and doubled CO₂ concentrations (including both radiative and physiological effects) on climate?
2. Are vegetation feedbacks likely to contribute to changes in future climate associated with a doubling of CO₂ concentrations?
3. Did vegetation feedbacks alter the climate of the Last Glacial Maximum? If so, what were the possible physiological effects of lower CO₂ concentrations on the climate and ecosystems?

Currently, we are actively engaged in an effort with NCAR scientists to couple IBIS into the NCAR Climate Systems Model (CSM). The CSM is a state-of-the-art climate model that combines an atmospheric general circulation model, a land-surface package, an ocean general circulation model, and a dynamical sea-ice model. By including IBIS within the NCAR CSM framework, we will provide the scientific community with an excellent framework to explore both the equilibrium and transient behavior of the coupled atmosphere-biosphere-ocean system, and its sensitivity to human activities.

Use of Satellite Data

We plan to use a variety of EOS-related satellite data in pursuit of our science goals. In particular, we will be using data from MODIS to evaluate our model results for a variety of biophysical and ecological parameters. In addition, we hope to incorporate data from other platforms into our project, including vegetation structure data from the VCL and improved rainfall data sets from TRMM.

Participation in Field Activities

Our group will be providing modeling and data analysis support to the Large-Scale Biosphere-Atmosphere Experiment in Amazonia (LBA) through NASA's LBA-Ecology program. Our LBA project focuses on long-term changes in the ecology, biogeochemistry, and water resources of the Amazon Basin, and how they may be affected by climatic variations and land-use practices.

Initial versions of IBIS have already been used to investigate ecological and hydrological processes within the Amazon, and their sensitivity to land use, climate change, and CO₂ fertilization. Working with other LBA-Ecology investigators, we plan to develop improved versions of our integrated terrestrial biosphere models, and use them to better understand the changing environmental conditions of Amazonia.

Principal Investigator **Jonathan Foley**

Jonathan Foley's research focuses on the interdisciplinary interface between climate, global ecology, and human activities. In particular, his work is focused on the use of computer models to analyze and simulate changes in climate, global ecosystems, and natural resources.

Foley is currently the Director of the Climate, People and Environment Program (CPEP) at the University of Wisconsin. In addition, he holds the Reid A. Bryson Professorship at Wisconsin.

Foley earned his doctoral degree in Atmospheric Sciences at the University of Wisconsin in 1993. His graduate work was supported by a National Science Foundation Fellowship, and was recognized with a Sigma Xi Doctoral Research Award. In addition, Foley was awarded a Presidential Early Career Award for Scientists and Engineers in 1997 (nominated by NASA), and a National Science Foundation Faculty Career Development award in 1995.

Co-Investigators

John Norman - *University of Wisconsin*

I. Colin Prentice - *Lund University, Sweden*

References

Coe, M.T., 1998: A linked global model of terrestrial hydrologic processes: Simulation of modern rivers, lakes, and wetlands. *J. Geophys. Res.*, **103**, 8885-8899.

Coe, M.T., 1999: Modeling terrestrial hydrologic systems at the continental scale: Testing the accuracy of an atmospheric GCM. *J. Climate*, in press.

Costa, M.H., and J.A. Foley: Combined effects of deforestation and doubled atmospheric CO₂ concentrations on the climate of Amazonia. *J. Climate*, accepted.

Costa, M.H., and J.A. Foley, 1997: The water balance of the Amazon basin: Dependence on vegetation cover and canopy conductance. *J. Geophys. Res.*, **102**, 23,973-23,990.

Delire, C., and J.A. Foley: Evaluating the performance of a land surface/ecosystem model with biophysical measurements from contrasting environments. *J. Geophys. Res.*, accepted.

Foley, J.A., I.C. Prentice, N. Ramankutty, S. Levis, D. Pollard, S. Sitch, and A. Haxeltine, 1996: An integrated biosphere model of land surface processes, terrestrial carbon balance, and vegetation dynamics. *Global Biogeochem. Cycles*, **10**, 603-628.

Foley, J.A., S. Levis, I.C. Prentice, D. Pollard, and S.L. Thompson, 1998: Coupling dynamic models of climate and vegetation. *Global Change Biology*, **4**, 561-579.

Foley, J.A., S. Levis, M.H. Costa, R. Doherty, J.E. Kutzbach, and D. Pollard: Vegetation and an interactive part of global climate models. *Ecological Applications*, submitted.

Kucharik, C.J., J.A. Foley, C. Delire, V.A. Fisher, M.T. Coe, S.T. Gower, J. Lenters, C. Molling, J.M. Norman, and N. Ramankutty: The IBIS-2 dynamic global biosphere model: Model formulation and validation. *Global Biogeochem. Cycles*, submitted.

Kucharik, C.J., K.R. Brye, J.M. Norman, J.A. Foley, S.T. Gower, and L.G. Bundy: Measurements and modeling of carbon and nitrogen dynamics in managed and natural ecosystems. *Global Biogeochem. Cycles*, submitted.

Levis, S., J.A. Foley, and D. Pollard: Regional scale vegetation feedbacks on a doubled CO₂ climate. *J. Climate*, submitted.

Levis, S., J.A. Foley, and D. Pollard: Potential high-latitude vegetation feedbacks on CO₂-induced climate change. *Geophys. Res. Lett.*, in press.

Levis, S., J.A. Foley, V. Brovkin, and D. Pollard: On the stability of the high-latitude climate-vegetation system in a coupled atmosphere-biosphere model. *Global Ecology and Biogeography Letters*, submitted.

Ramankutty, N., and J.A. Foley, 1998: Characterizing patterns of global land use: An analysis of global croplands data. *Global Biogeochem. Cycles*, **12**, 667-686.

Ramankutty, N., and J.A. Foley: Estimating historical changes in global land cover: Croplands from 1700 to 1992. *Global Biogeochem. Cycles*, submitted.

Ramankutty, N., and J.A. Foley: Estimating historical changes in land cover: North American croplands from 1850 to 1992. *Global Ecology and Biogeography Letters*, submitted.

Woodward, F.I., W. Cramer, A. Bondeau, I.C. Prentice, R.A. Betts, V. Brovkin, P.M. Cox, V. Fisher, J. Foley, A.D. Friend, C. Kucharik, M.R. Loas, C. Molling, N. Ramankutty, S. Sitch, and A. White: Dynamic responses of global terrestrial vegetation to changes in CO₂ and climate. *Nature*, submitted.

Investigation URL

<http://cpep.meteor.wisc.edu>

Biosphere-Atmosphere Interactions

Principal Investigator – Inez Fung

Science Background

This investigation is directed at improving our understanding of the role of the terrestrial biosphere in global change using models, in situ observations, and satellite data. Specifically, the science investigations in the project cover both short-term (biophysics) interactions between the land biosphere and the atmosphere and long-term (ecology, anthropogenic impacts) interactions. One short-term focus of the work is to develop and use a coupled land-biosphere-atmosphere model to simulate the response of the physical climate system to both radiative and physiological changes induced by increasing CO₂. This model will have its surface boundary conditions largely specified from satellite data. Complementary work is focused on the development of a range of carbon-cycle models operating over a wide range of time scales, which will be used to understand the follow-up response of the terrestrial biosphere to climate change.

Science Goal

The goal of the investigation is to first understand and then to predict the response of the coupled terrestrial biosphere-global atmosphere system to global change, specifically to the increase in atmospheric CO₂. In addition to improving our understanding of the critical components of the Earth system, this project should yield improved products of derived surface and atmospheric parameters, and will be directly useful in developing methodologies to extract the maximum benefit from EOS observations.

Current Activities

The group has constructed a biophysics model (SiB2) and a biogeochemical model (CASA), and has continued development of global climate and tracer transport models. Versions of SiB2 and CASA models have been coupled to different versions of the the Colorado State University (CSU) GCM and the GISS atmospheric tracer transport model. The flexible suite of models has been combined with the NDVI time series to investigate biophysical and biogeochemical interactions among energy, water and carbon on interannual and longer time scales. The group is also developing fundamental understanding in the use of isotope information to elucidate water- and carbon-

exchange processes and to constrain interpretation of global water and carbon cycles. Time series of global gridded satellite observations of the biosphere are produced and analyzed. Related work is being done on improving remote-sensing calibration and other tools to derive vegetation cover components and phenology.

Use of Satellite Data

The project will make strong use of the Terra and EOS PM platform data. MODIS, MISR, and ASTER data will be used to define surface properties for the SiB2 and CASA models to replace those data sets that are currently derived from AVHRR observations. AIRS data will be used to check all aspects of the model's performance including, among others, atmospheric states and radiation fields. We have also been working with the POLDER sensor on ADEOS and the Lewis sensor. We plan to use the data from the NPOESS sensors when the system becomes available.

Participation in Field Programs

Many of the team members participate in field programs which aim to further our understanding of important processes as well as teach us how to better use satellite data in the models. These experiments have included:

FIFE: A study of land-atmosphere exchanges and remote sensing, carried out in Kansas in the late 1980s.

BOREAS: Several investigators took part and will take part in this large-scale, interdisciplinary study of the functioning of the boreal forest of Canada.

LBL: This experiment focuses on biosphere-atmosphere interactions in tropical Amazonia. The ongoing analysis of the data embraces aspects of land-surface climatology, ecology, biogeochemistry, terrestrial ecology, and remote sensing.

FIRE: This is a study of atmospheric radiative transfer and the validation of remote-sensing algorithms.

Principal Investigator

Inez Fung

Inez Fung is currently Director of the Center for Atmospheric Sciences and a Professor in the Department of Geology and Geophysics and the Department of Environmental Science, Policy and Management at the University of California, Berkeley. She received her Sc.D. in Meteorology from the Massachusetts Institute of Technology in 1977, and was a postdoctoral fellow at Goddard Space Flight Center from 1977-1979. She was associated with the Goddard Institute for Space Studies in various capacities from 1979-1998. From 1993-1998, she was Professor at the University of Victoria in Canada. She was honored with NASA's Medal for Exceptional Scientific Achievement (1989), election as a Goddard Senior Fellow (1992-1997), as a Fellow of the American Meteorological Society (1994) and the American Geophysical Union (1996).

Co-Investigators

Joe Berry - *Carnegie Institution*

James Collatz - *NASA/Goddard Space Flight Center*

A. Scott Denning - *University of California at Santa Barbara*

Christopher Field - *Carnegie Institution*

Christopher O. Justice - *University of Virginia / NASA-GSFC*

Pamela A. Matson - *Stanford University*

Harold Mooney - *Stanford University*

David Randall - *Colorado State University*

Piers J. Sellers - *Johnson Space Flight Center*

Compton J. Tucker - *NASA/Goddard Space Flight Center*

Susan Ustin - *University of California at Davis*

Peter Vitousek - *Stanford University*

References

Denning, A.S., G.J. Collatz, C.G. Zhang, D.A. Randall, J.A. Berry, P.J. Sellers, G.D. Colello, and D.A. Dazlich, 1996: Simulations of terrestrial carbon metabolism and atmospheric CO₂ in a general circulation model. 1. Surface carbon fluxes. *Tellus*, **48B**, 521-542.

Denning, A.S., D.A. Randall, G.J. Collatz, and P.J. Sellers, 1996: Simulations of terrestrial carbon metabolism and atmospheric CO₂ in a general circulation model. 2. Simulated CO₂ concentrations. *Tellus*, **48B**, 543-567.

Field, C.B., M.J. Behrenfeld, J.T. Randerson, and P. Falkowski, 1998: Primary production of the biosphere: Integrating terrestrial and oceanic components. *Science* **281**, 237-240.

Fung, I., C.B. Field, J.A. Berry, M.V. Thompson, J.T. Randerson, C.M. Malmstrom, P.M. Vitousek, G.J. Collatz, P.J. Sellers, D.A. Randall, A.S. Denning, F. Badeck, and J. John, 1997: Carbon-13 exchanges between the atmosphere and biosphere. *Global Biogeochem. Cycles*, **11**, 507-533.

Myneni, R., C.D. Keeling, C.J. Tucker, G. Asrar, and R. Nemani, 1997: Increased plant growth in northern high latitudes from 1981 to 1991. *Nature*, **386**, 698-702.

Randerson, J. T., M.V. Thompson, I.Y. Fung, T. Conway, and C.B. Field, 1997: The contribution of terrestrial sources and sinks to trends in the seasonal cycle of atmospheric carbon dioxide. *Global Biogeochem. Cycles*, **11**, 535-560.

Sellers, P.J., R.E. Dickinson, D.A. Randall, A.K. Betts, F.G. Hall, J.A. Berry, C.J. Collatz, A.S. Denning, H.A. Mooney, C.A. Nobre, and N. Sato, 1997: Modeling the exchanges of energy, water, and carbon between the continents and the atmosphere. *Science*, **275**, 502-509.

Sellers, P.J., L. Bounoua, G.J. Collatz, D.A. Randall, D. Dazlich, S. Los, J. Berry, I. Fung, J. Tucker, C. Field, and T.G. Jensen, 1996: A comparison of the radiative and physiological effects of 2xCO₂ on the global climate. *Science*, **271**, 1402-1405.

Ustin, S.L., D.A. Roberts, J.E. Pinzon, S. Jacquemoud, G. Scheer, C.M. Castaneda, and A. Palacios, 1998: Estimating canopy water content of chaparral shrubs using optical methods. *Remote Sens. Environ.*, **65**, 280-291.

Investigation URL

<http://sequoia.atmos.berkeley.edu/ids/ids.html>

Aerosols, Clouds, Chemistry, and Radiative Forcing

Principal Investigator – **Steven J. Ghan**

Science Background

By burning fossil fuels and biomass, the human race is altering both the composition of the atmosphere and the radiation balance of the planet, perhaps enough to noticeably change the climate within the next few decades. Combustion of fossil fuels and biomass yields emissions of both CO₂ and aerosols and their precursors. CO₂ traps infrared radiation and hence warms the planet, while aerosols primarily scatter sunlight and hence cool the planet. Whether the radiative forcing due to anthropogenic aerosols dominates or is dominated by the radiative forcing due to anthropogenic CO₂ depends upon the relative emissions of these combustion products, their atmospheric lifetimes, and their radiative properties. Although anthropogenic emissions of CO₂ dominate those of aerosols and their precursors, and the atmospheric lifetimes of aerosols and their precursors are much shorter than that of CO₂, the global radiative forcing by aerosols resulting from fossil fuel combustion is estimated to be roughly comparable to that by CO₂, per unit of fuel combusted.

However, the uncertainty in the estimates of the radiative forcing due to anthropogenic aerosols is much greater than the uncertainty in the radiative forcing due to increasing CO₂ concentrations. This uncertainty is partly due to the short lifetime and hence heterogeneous distribution of anthropogenic aerosols, and partly due to the complex manner in which aerosols affect the planetary radiation balance. Aerosols can alter the planetary radiation balance directly by scattering, absorbing, and emitting solar and infrared radiation, and indirectly by serving as cloud condensation nuclei (CCN), thereby increasing cloud droplet number and cloud albedo. Direct radiative forcing is complicated by water uptake by aerosol particles, which depends not only on ambient relative humidity but also on the history of relative humidity encountered by the aerosol particle. Indirect radiative forcing through the role of anthropogenic aerosols as CCN depends not only on the concentration of the aerosols, but also on the concentration of other aerosols that compete for water when cloud droplets are formed. Reducing the uncertainties in estimates of the radiative forcing due to anthropogenic aerosols will therefore require methods that can account for considerable complexity.

Science Goal

To reduce the uncertainty in estimates of the radiative forcing due to anthropogenic aerosols, this investigation focuses on the development, evaluation, and application of an integrated global modeling system designed to provide refined physically based estimates of both direct and indirect radiative forcing by anthropogenic aerosols. This global modeling system, once properly evaluated through comparison with surface, in situ, and remote measurements, can serve as an intelligent interpolator of observations, providing the ability to distinguish between natural and anthropogenic aerosols.

Current Activities

We have coupled the Pacific Northwest National Laboratory (PNNL) global chemistry/aerosol model in-core memory with the PNNL version of the National Center for Atmospheric Research (NCAR) Community Climate Model (CCM2). The PNNL global chemistry/aerosol model simulates the sulfate, methane sulfonic acid (MSA), carbonaceous, dust and sea salt aerosol mass for specified size distributions in both the aqueous and interstitial phase. The PNNL version of the NCAR CCM2 simulates mass and number concentrations of cloud droplets and ice crystals. The two models interact through the influence of aerosols on radiative heating and cloud droplet number and through the influence of clouds on aqueous chemistry and wet removal of aerosol. Nudging of the simulated winds toward observations is applied so that the simulated aerosol can be evaluated on timescales of days as well as months.

Estimates of direct radiative forcing by aerosols have generally either relied upon field measurements or classical Kohler theory to treat the dependence of water uptake on relative humidity. However, field measurements cannot distinguish the influence of different aerosol compositions, and Kohler theory cannot account for hysteresis. To improve upon these treatments, we are developing a dynamic aerosol growth model suitable for global simulations. Depending on the composition, ambient RH, and particle history, the aerosol may be completely solid, completely liquid, or mixed-phase.

The treatment of a variety of aerosols is motivated by the hypothesis that aerosols compete for water when cloud droplets form, so that any estimate of the indirect radiative forcing by a particular aerosol species will depend upon the concentration of all other aerosol species. To test this hypothesis, we are conducting global experiments with several different values of a prescribed background aerosol. We are also using a detailed aerosol activation model to test the hypothesis for a variety of aerosol types, and are developing a refined parameterization of aerosol activation for multiple aerosol types.

Measurements of the composition of CCN in remote locations have indicated the presence of considerable organic material. We are therefore developing a model of tropospheric chemistry that treats organic chemistry and sulfur chemistry in much more detail. Parallel simulations with the present simple chemistry mechanism and with the more-detailed mechanism will be compared to determine the impact of the more-detailed chemistry on the estimated radiative forcing.

Aerosol size distribution is presently prescribed in terms of log-normal distributions for Aitken, accumulation, and coarse modes. Such a treatment lacks the flexibility needed to properly treat aerosol activation, in which a larger mass fraction than number fraction is typically activated for each aerosol mode. To distinguish between the activation of aerosol number and mass, we are exploring the prediction of number as well as mass for each aerosol mode.

Recent work with regional models has shown that heterogeneous reactions on aerosol surfaces can have a significant impact on tropospheric ozone. We are using our model to investigate this problem in a global atmosphere.

Use of Satellite Data

We use satellite data primarily to evaluate model performance. We are presently relying on AVHRR data to evaluate the simulated aerosol optical depth. Using daily analyses of AVHRR data by NOAA and by Brookhaven National Laboratory, we form composites of simulated optical depth for the same times as the AVHRR observations. Differences between the simulated and analyzed optical depths can reflect errors in the simulated optical depth, but can also arise from errors in the aerosol composition and size distribution assumed in the AVHRR analysis. To reduce ambiguity in the interpretation, we therefore are focusing on the "aerosol radiance" (the difference between the radiance observed by the satellite and what the radiance would be in the absence of aerosols) as the figure of merit.

To assess the simulation of indirect radiative forcing, we are currently relying on Qingyuan Han's estimate of droplet effective radius from AVHRR data, Tom Greenwald's estimate of cloud liquid water path from SSM/I microwave measurements, and on the ERBE mea-

surements of cloud radiative forcing. After the launch of the TRMM and Terra satellites, we will rely on analyses of CERES measurements for cloud radiative forcing and MODIS measurements for cloud optical depth and cloud-top particle size.

Global mid-tropospheric distributions of CO obtained from the Measurement of Air Pollution by Satellites (MAPS) experiments that took place in April and October of 1994 are being used to test the model's performance in simulating free tropospheric chemistry. After the launch of the Terra satellite we will use MOPITT estimates of tropospheric CO.

Participation in Field Programs

We have compiled a multi-year data set of aerosol optical depths measured daily by solar radiometers and rotating shadowband radiometers at a variety of sites across the continental United States, Barrow, Alaska, Mauna Loa, Barbados, Bermuda, Tenerife, the Canary Islands, Mace Head Ireland, Tasmania, and the South Pole.

Principal Investigator

Steven J. Ghan

Steven J. Ghan received his B.S. in Atmospheric Science from the University of Washington in 1979 and his Ph.D. in Meteorology from the Massachusetts Institute of Technology in 1988. From 1984 to 1990 he worked at the Lawrence Livermore National Laboratory, coupling a global aerosol model with a global circulation model to investigate the nuclear winter hypothesis. In 1990 he became a Senior Research Scientist at Battelle Pacific Northwest Laboratory, where he has focused on improving the treatment of clouds and cloud-aerosol interactions in global models and on representing the subgrid influence of mountains on clouds and precipitation in regional models. He has been a member of the Department of Energy Atmospheric Radiation Measurement Science Team since 1991, and an affiliate associate professor at the University of Washington since 1992.

Co-Investigators

Richard C. Easter - *Battelle Pacific Northwest Laboratory*

Rick D. Saylor - *Georgia Institute of Technology*

References

Ghan, S.J., C.C. Chuang, and J.E. Penner, 1993: A parameterization of cloud droplet nucleation. Part I: Single aerosol type. *Atmos. Res.*, **30**, 197-222.

Ghan, S.J., C.C. Chuang, R.C. Easter, and J.E. Penner, 1995: A parameterization of cloud droplet nucleation. Part II: Multiple aerosol types. *Atmos. Res.*, **36**, 39-54.

Ghan, S.J., R.C. Easter, Y. Zhang, L.R. Leung, R.D. Saylor, L.K. Peters, R. Zaveri, and P. Lee, 1997: Radiative forcing of climate by aerosols: A physically based modeling approach. Proceedings of the Third AMS Conference on Atmospheric Chemistry, Long Beach CA, February 1997.

Ghan, S.J., L.R. Leung, and Q. Hu, 1997: Application of cloud microphysics to NCAR CCM2. *J. Geophys. Res.*, **102**, 21,777-21,794.

Ghan, S.J., L.R. Leung, R.C. Easter, and H. Abdul-Razzak, 1997: Prediction of droplet number in a general circulation model. *J. Geophys. Res.*, **102**, 777-794.

Zaveri, R., 1997: Development and evaluation of a comprehensive tropospheric chemistry model for regional and global applications. Ph.D. dissertation. Virginia Polytechnic Institute and State University, Blacksburg, Virginia, USA.

Investigation URL

http://www.pnl.gov/atmos_sciences/as_clim.html

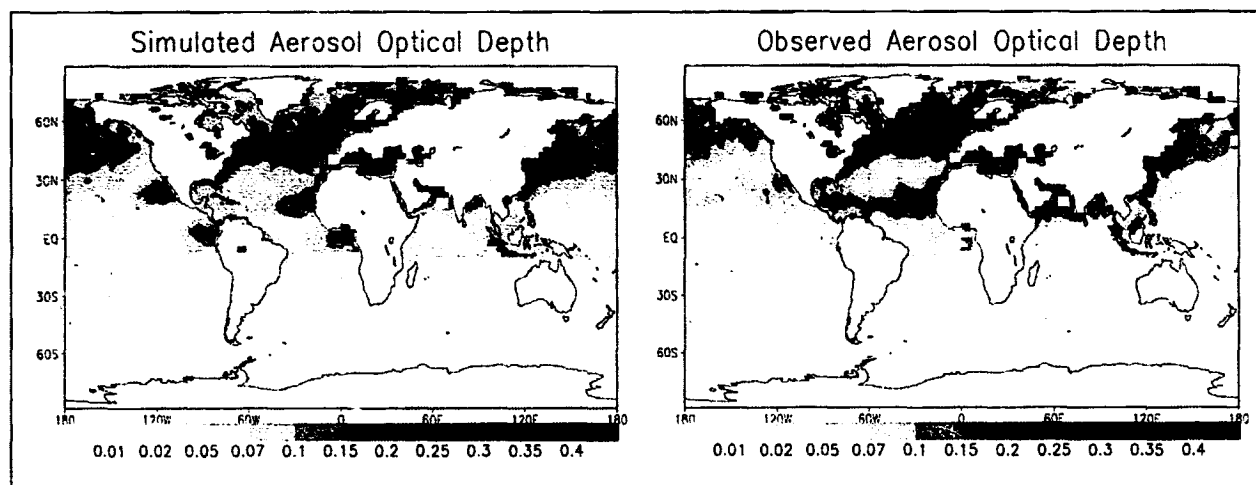

Clear-sky mean aerosol optical depth for August 1994 as derived from AVHRR radiance measurements and as simulated by the PNNL global aerosol model. Data is unavailable for the Southern Hemisphere because the satellite flew in the darkness there.

Use of the Cryospheric System (CRYSYS) to Monitor Global Change in Canada

Principal Investigator – **Barry E. Goodison**
International Sponsor – **Canada**

Science Background

The cryosphere is an important component of the global climate system, involving complex feedback mechanisms of differing magnitude and sign. At the global scale, there is a large body of evidence documenting an inverse relationship between the amount of snow and ice on the Earth's surface and global mean temperature. There are, however, important regional exceptions to this generalization, and greater understanding of cryospheric processes and their spatial and temporal variability is required to reduce the uncertainties in modeling regional and global climates and the hydrological cycle. Improved understanding of cryospheric variability is particularly relevant in Canada where a wide range of economic activities are sensitive to variations in cryospheric elements.

Science Goals

The basic scientific goals of CRYSYS are to:

- 1) develop capabilities for monitoring and understanding variations in cryospheric variables across a range of scales;
- 2) develop and validate local, regional, and global models of climate/cryospheric processes and dynamics to improve understanding of the role of the cryosphere in the climate system; and
- 3) assemble, maintain, and analyze key historical, operational, and research cryospheric data sets to support climate monitoring and model development.

Current Activities

The broad goals of CRYSYS are being addressed through five scientific themes corresponding to the main elements of the cryosphere in Canada: glaciers and ice caps, sea ice, lake ice, snow, and frozen ground/permafrost. There is a CRYSYS data management activity to address data issues and a cross-cutting cryospheric modeling component. Brief overviews of the activities of each theme follow. The theme leader is identified for each component.

Glaciers and ice caps (M. Brugman): This component focuses on the development of new techniques for monitoring glaciers and ice caps with remotely sensed data, complementary in situ validation, and continuing enhancement and access to conventional glacier information such as the Canadian Glacier Inventory.

Sea ice (E. LeDrew): CRYSYS sea-ice research focuses on field investigations for development and validation of microwave algorithms for first-year and multi-year sea ice, depth of snow on sea ice, and modeling of interannual variability and sea-ice-climate feedback processes.

Lake ice (A. Walker): Lake-ice studies focus on the use of passive and active microwave satellite data to extract geophysical information related to lake-ice processes and the identification of freeze-up/break-up events for climate variability and change analysis.

Snow (A. Walker): Main thrusts in CRYSYS snow-related research are the development and validation of passive and active microwave algorithms for snow-cover properties (extent, water equivalent, wet/dry state) in varying landscapes; the synergism between active and passive microwave data for enhancing snow-cover information retrieval; generation of information products in near-real time; and reconstruction of historical snow cover from conventional and remotely-sensed data to document and better understand long-term variability in snow cover.

Frozen ground/permafrost (C. Duguay): The frozen-ground research focuses on the development of new means for mapping/monitoring seasonally and perennially frozen ground (permafrost), and associated features (e.g., thaw slumps, active-layer detachment slides, thaw lakes) using optical and microwave remote-sensing data.

Cryospheric Modeling (G. Flato): CRYSYS research activities are contributing to the validation and improvement of the representation of the cryosphere in global climate models. To date, most of the CRYSYS modeling activities have focused on sea ice, such as studies to simulate landfast-ice variability in the Canadian high Arctic over a range of time scales from diurnal to interannual.

Use of Satellite Data

CRYSYS requires the effective combination of data from many conventional or ground data sets, from airborne campaigns, and from remotely sensed information from EOS and non-EOS platforms.

Current passive microwave data from SSM/I on the DMSP platforms are the basis for the development of snow, lake-ice, and sea-ice algorithms for AMSR and future SSM/I sensors. SAR data from ERS-1 and 2 and Radarsat are critical for all components of the cryosphere being studied under CRYSYS. AVHRR is the current sensor for large-area studies before MODIS becomes available in the EOS era. ASTER will support targeted glacier/ice cap and frozen-ground investigations. CRYSYS team members interact directly with the NSIDC and ASF DAAC facilities and Canadian agencies in most of their studies.

Examples of the use of current satellite data for CRYSYS research include: acquisition of DMSP SSM/I data in near real-time for the development of algorithms to derive snow-water equivalent (SWE), extent, and snow-pack state for different landscape regions of Canada and generate snow-cover information products for climate analyses (including modeling) and water resource monitoring and forecasting (such as depicted in the figure on the following page); development and implementation of an SWE algorithm using Radarsat data for hydroelectric forecasting in Northern Quebec; SSM/I 85-GHz brightness-temperature data for large lakes in northern Canada to discriminate between ice cover and open water, for monitoring freeze-up/break-up patterns for the entire lake; application of SAR and Landsat TM data for improving glacier-runoff modeling and glacier mass balance; the practical application of SAR interferometry for topographic measurements on glaciers; and the synergism between optical (Landsat, SPOT) and active microwave (ERS-1/2, JERS-1, Radarsat) data for mapping frozen-ground and permafrost phenomena.

Participation in Field Programs

All CRYSYS components involve extensive field investigations for algorithm development and validation, often in conjunction with other international initiatives such as BOREAS and GEWEX/MAGS (Mackenzie GEWEX Study). Detailed measurements of geophysical properties of first-year and multi-year ice have been taken at the SIMMS/C-ICE (Seasonal Sea Ice Monitoring and Modeling Site/Collaborative-Interdisciplinary Cryospheric Experiment) field site near Resolute, North West Territories (NWT), since 1990.

Extensive airborne and ground networks have been established in major landscape target sites throughout Canada (including prairie, boreal forest, tundra) for re-

peated ground-measurement and passive-microwave surveys for data acquisition in support of satellite microwave (e.g., SSM/I, Radarsat) snow-algorithm developing, testing, and validation. Five permafrost study sites have been established (Mayo and Old Crow, YT; Churchill, Man.; Fosheim Peninsula, NWT; and Umiujaq, Que.) and intensive field campaigns have been mounted in the Churchill area over the past two summers to map surface cover, active-layer depth, and permafrost-related terrain features. Glacier and ice-cap mass-balance measurements continue to be made at long-term monitoring sites in western Canada and the Canadian Arctic.

Principal Investigator

Barry Goodison

Barry Goodison received his Ph.D. from the University of Toronto and has over 30 years of experience in cryosphere, precipitation measurement, and climate/cryosphere studies as a scientist with the Atmospheric Environment Service, Environment Canada. He has led several national and international field studies on components of the cryosphere, especially snowfall and snow cover. He recently led the World Meteorological Organization Intercomparison on the Measurement of Solid Precipitation, and was an investigator and organizer of the Boreal Ecosystem Atmosphere Study (BOREAS). He currently is a member of the WCP Task Group on Cryosphere and Climate. He has served on, or chaired, many scientific committees and working groups, including several for NASA.

Co-Investigators

David Barber - *University of Manitoba*

Monique Bernier - *INRS-EAU, Université du Québec*

Ross Brown - *Atmospheric Environment Service*

Melinda Brugman - *Columbia Mountains Institute for Applied Ecology*

Claude Duguay - *Centre d'études nordiques, Université Laval*

Greg Flato - *Atmospheric Environment Service*

Hardy Granberg - *University of Sherbrooke*

Roy Koerner - *Geological Survey of Canada*

Ellsworth LeDrew - *University of Waterloo*

Lawrence Mysak - *McGill University*

Terry Pultz - *Canada Centre for Remote Sensing*

Anne Walker - *Atmospheric Environment Service*

Ming-ko Woo - *McMaster University*

References

Bernier, M., and J.P. Fortin, 1998: The potential of time series of C-band SAR data to monitor dry and shallow snow cover. *IEEE Trans. Geosci. Remote Sens.*, **36**, 1-18.

Brown, R.D., and B.E. Goodison, 1996: Interannual variability in reconstructed Canadian snow cover, 1915-1992. *J. Climate*, **9**, 1299-1318.

Chang, A.T.C., J.L. Foster, D.K. Hall, B.E. Goodison, A.E. Walker, J.R. Metcalfe, and A. Harby, 1997: Snow parameters derived from microwave measurement during the BOREAS winter field campaign. *J. Geophys. Res.*, **102**, 29,663-29,671.

Demuth, M.N., and A. Pietroniro, 1999: Inferring glacier mass balance using RADARSAT—results from Peyto Glacier, Canada. *Geografiska Annaler*, 81A, in press).

Derksen, C., E. LeDrew, and B. Goodison, 1998: SSM/I derived snow water equivalent data: The potential for investigating linkages between snow cover and atmospheric circulation. *Atmos.-Ocean*, **36**, 95-117.

De Seve, D., M. Bernier, J.-P. Fortin, and A. Walker, 1997: Preliminary analysis of snow microwave radiometry using the SSM/I passive-microwave data: The case of La Grande River watershed (Quebec). *Annals of Glaciology*, **25**, 353-361.

Duguay, C.R., W.R. Rouse, P.M. Lafleur, D.L. Boudreau, Y. Crevier, and T.J. Pultz, 1999. Analysis of multi-temporal ERS-1 SAR data of subarctic tundra and forest in the northern Hudson Bay Lowland and implications for climate studies. *Can. J. Remote Sensing*, **25**, 21-33.

Flato, G.M., and R.D. Brown, 1996: Variability and climate sensitivity of landfast Arctic sea ice. *J. Geophys. Res.*, **101**, 25,767-25,777.

Goodison, B.E., R.D. Brown, G. Flato, M. Brugman, C.R. Duguay, E.F. LeDrew, and A.E. Walker, 1999: CRYSYS—Use of the cryospheric system to monitor global change in Canada: Overview and progress. *Can. J. Remote Sensing*, **25**, 3-11.

Hanesiak, J.M., D.G. Barber, and G.M. Flato, 1998: The role of diurnal processes in the seasonal evolution of sea ice and its snow cover. *J. Geophys. Res.*, in press.

Leverington, D.W., and C.R. Duguay, 1997: A neural network method to determine the presence or absence of permafrost near Mayo, Yukon Territory, Canada. *Permafrost and Periglacial Processes*, **8**, 205-215.

Lewkowicz, A.G., and C.R. Duguay, 1999: Detection of permafrost features using SPOT panchromatic imagery, Fosheim Peninsula, Ellesmere Island, N.W.T. *Can. J. Remote Sensing*, **25**, 34-44.

Piwowar, J.M., D.R. Peddle, and E.F. LeDrew, 1997: Temporal mixture analysis of Arctic sea ice imagery: a new approach for monitoring environmental change. *Remote Sens. Environ.*, **63**, 195-207.

Vachon, P.W., D. Geudtner, K. Mattar, A.L. Gray, M. Brugman, and I. Cumming, 1996. Differential interferometry measurements of Athabasca and Saskatchewan glacier flow rate. *Can. J. Remote Sensing*, **22**, 287-296.

Investigation URL

<http://www1.tor.ec.gc.ca/crysys/>

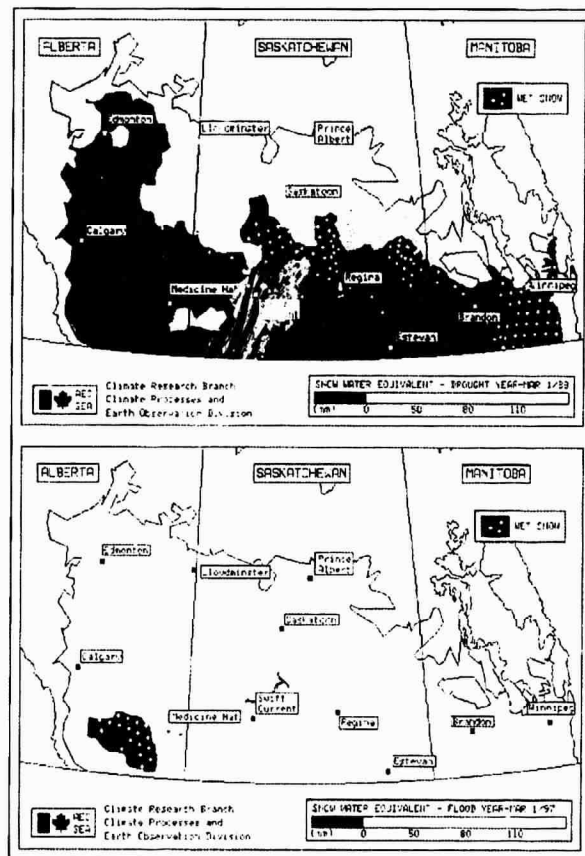

Passive microwave (SSM/I)-derived snow water equivalent for March 1, 1988 (drought year) and March 1, 1997 (flood year) on the Canadian prairies (shaded area).

Freshwater Cycle in the Global Ocean

Principal Investigator – **Sirpa Hakkinen**

Science Background

The heat transport in the oceans and the global-conveyor-belt concept to explain the renewal of the deep ocean has received more attention in the scientific literature than the oceanic freshwater conveyor. The thermal-conveyor circulation implies that the northern Atlantic source is the dominant deep-water source for the global ocean. The conversion of surface water to bottom water in the northern hemisphere occurs mainly through heat loss while the freshwater flux tries to oppose the process. There is a small contribution to the northern dense waters from the Arctic water masses which form as a result of brine rejection, as it is the only means of densification in ice-covered areas. In the Southern Ocean, brine rejection is the main process of densification, but there are occasional polynyas in deep water in the Ross and Weddell Seas where deep convection may occur.

Ice-core and sediment data show that there have been large fluctuations in the past in the thermohaline circulation which have been associated with the changes in the freshwater storage in ice sheets. Superimposed on this long-time-scale variability, the ice-core data show intense shorter timescale variability which can be interpreted to result from thermohaline circulation changes. The very-long-period variability in the hydrological cycle associated with the ice sheets is not of immediate interest in our study. The distribution of freshwater from sea ice and precipitation minus evaporation (P-E) sources is of importance to thermohaline circulation on interannual-to-decadal time scales by modifying the surface-water masses and mixing processes at subpolar-to-polar latitudes. This variability affects deep waters as well as mode waters (intermediate water masses), which can have a climatic impact on decadal scale because they will come into contact with the atmosphere much faster than the deep waters. More importantly, the basic knowledge of the freshwater cycle in the present climate is not well known, mainly due to the lack of good quality observational P-E data. Assimilated P-E products from atmospheric models can be flawed because the models can have serious biases in their moisture-transport and boundary-layer treatment. A manifestation of such model bias together with ocean-model bias is the need for flux correction when the models are coupled. For instance the GFDL coupled model (Manabe and Stouffer, 1988) shows that the largest model drift occurs in the areas of deep-water formation, such as

in the Greenland Sea and mainly affects the surface salinity fluxes.

The sea-ice regions are sources of variability in the freshwater cycle in the ocean through ice advection (Hakkinen, 1993, 1995), but, more importantly, these regions also provide the connections to the other ocean basins. Thus, the freshwater cycle is truly interhemispheric in nature with interbasin connections through the Arctic and the Southern Ocean. The only interbasin connection outside polar/subpolar regions is through the Indonesian archipelago.

Poleward of 45 N/S the land and oceans receive net precipitation which has to be returned back to the equatorial regions. The subpolar/polar regions are also source regions for the below-thermocline and deep/bottom waters; thus a part of the freshwater route back to global system coincides with the thermohaline circulation. The redistribution of freshwater between the two basins is significant for the conveyor circulation as shown by several modeling studies, e.g., Marotzke and Willebrand (1991). However, the freshwater route from the northern Pacific through the Arctic Ocean to the Atlantic has been neglected, and Wijffels et al. (1992) suggest that most of the net freshwater gain (from the atmosphere) by the North Pacific is routed through the Arctic. Considering this northern freshwater route, a study by Shaffer and Bendtsen (1994) is of importance: A three-box model describes the multiple equilibria as a result of water-mass exchange between the Pacific and the Atlantic. The general tendency of the solutions is that with larger flow/deeper Bering Strait the conveyor solution is suppressed while closing of the Strait favors the conveyor solution. Besides the depth of the Strait, two other free parameters of the model are the freshwater transport to the northern regions and how it is divided between the North Pacific and North Atlantic. With increasing total freshwater transport the North Atlantic sinking would be less likely, unless the fractional portion of the transport to the Pacific is increased. Thus the northern freshwater route complicates the scenarios for the variability of the thermohaline conveyor. This is especially relevant for the global-warming scenarios which imply enhanced moisture transport to the high latitudes.

Science Goal

The objective of this proposal is to study the freshwater transports in the global ocean using coupled ocean and

ice models. The hydrological cycle in the oceans requires inclusion of the polar regions for closure because the mid-to-high-latitude net precipitation, and runoff from continents, has to be returned to the rest of the world ocean. The freshwater conveyor opposes the thermal conveyor at the high latitudes where deep-water-formation regions are located. The variability of freshwater flux is of critical importance in these areas as the freshwater fluxes influence the global thermohaline circulation and thus provide a source for long-term climate variability. The proposed effort complements the present Earth Science Enterprise (ESE) study of the global hydrological cycle and supports the ESE goal towards understanding of mechanisms and factors which determine long-term climate variations and trends.

Our goal is to model the freshwater conveyor as it exists in the present climate using precipitation data from SMMR, SMM/I, and TRMM, as well as corresponding runoff data (from our land surface/ river model). We plan to estimate magnitudes of disturbances and their effects on the thermohaline cell. One such disturbance of interest is the distribution of the atmospheric freshwater transport between the N. Pacific and N. Atlantic.

Current Activities

The development of a generalized vertical-coordinate ocean model is the first task, which will include the same physics, such as the turbulence-closure model (which predicts the vertical diffusion of momentum, temperature, and salinity), as in the POM (Princeton Ocean Model; Blumberg and Mellor 1987). The latter model uses sigma-coordinates in the vertical where the model layers follow the terrain and requires considerable smoothing of the topography with decreasing resolution. Thus, modifications are necessary to accommodate some detail in topography in a coarse-resolution grid (2x2 degrees) but retaining some bottom boundary-layer physics, which is important for deep flows, i.e., thermohaline circulation. Inclusion of flexible vertical-layer structure could also allow the use of density surfaces to define layers, because the layers have to be updated every time step. The generation of a global grid that avoids the north-pole convergence and avoids any other boundary conditions than cyclic conditions requires some consideration and effort.

The freshwater cycling in the ocean is studied first in a diagnostic framework and later on in quasi-equilibrium runs for a specified freshwater forcing. Given the equilibration time scale of thousands of years for oceanic thermohaline circulation, even a 2x2-degree model can be too long to run for several experiments. However, tendencies in the model behavior can be equally illuminating of the physics and adequate for the study of the sensitivity of the interbasin freshwater export from the Pacific to the Atlantic via the Arctic Ocean.

Use of Satellite Data

Model input requires precipitation minus evaporation data to study the freshwater conveyor using data from SMMR, SMM/I, and TRMM, as well as corresponding runoff data (from our land surface/ river model).

Principal Investigator

Sirpa Hakkinen

Sirpa Hakkinen received her Bachelor of Science (1974) and Master of Science (1976) degrees in Physics from the University of Helsinki, Finland. Her Ph.D. is in Geophysical Fluid Dynamics from Florida State University (1984). Since 1990 she has been a member of the Oceans and Ice Branch at NASA Goddard Space Flight Center. She has worked on coupled sea-ice and ocean models to study mesoscale processes and during recent years has investigated interannual-to-decadal variability in the Arctic and North Atlantic Oceans.

Co-Investigator

George L. Mellor - *Princeton University*

References

- Blumberg, A.L., and G.L. Mellor, 1987: A description of a three-dimensional coastal ocean circulation model, 'Three dimensional coastal ocean models' (ed. N. S. Heaps), 1-16, *Am. Geophys. Union*, Wash. DC.
- Hakkinen, S., 1993: An Arctic source for the Great Salinity Anomaly : A simulation of the Arctic Ice Ocean System for 1955-1975. *J. Geophys. Res.*, **98**, 16,397-16,410.
- Hakkinen, S., 1995: Simulated interannual variability of the Greenland Sea deep water formation and its connection to surface forcing. *J. Geophys. Res.*, **100**, 4761-4770.
- Manabe, S., and R.J. Stouffer, 1988: Two stable equilibria of a coupled ocean-atmosphere model. *J. Climate*, **1**, 841-866.
- Marotzke, J., and J. Willebrand, 1991: Multiple equilibria of the global thermohaline circulation. *J. Phys. Oceanogr.*, **21**, 1372-1385.
- Shaffer, G., and J. Bendtsen, 1994: Role of the Bering Strait in controlling North Atlantic ocean circulation and climate. *Nature*, **367**, 354-357.
- Wijffels, S.E., R.W. Schmitt, H.L. Bryden, and A. Stigebrandt, 1992: Transport of freshwater by the oceans. *J. Phys. Oceanogr.*, **22**, 155-162.

Interannual Variability of the Global Carbon, Energy, and Hydrologic Cycles

Principal Investigator – **James E. Hansen**

Science Background

Global climate change has attained paramount interest in Earth sciences because of its potential to affect human activities and the environment. A crucial science issue is to understand the possible anthropogenic role in observed climate change. Mankind's alteration of the carbon cycle, through burning of fossil fuels and deforestation, is expected to significantly alter the planet's temperature and thermal-energy cycle, and perhaps the most important impact of this will be on water distribution and the hydrologic cycle. Measurable changes in the carbon, energy, and water cycles are occurring on a year-to-year basis. Analysis of these changes and their relationships has great potential to improve predictability of future climate change.

Science Goals

The ultimate objective of our study of the combined carbon, energy, and water cycles concerns global climate change, specifically an understanding of current and recent interannual climate variability and trends, as well as an ability to reliably predict the future climatic impact of anthropogenic activities. Achievement of the climate research goals is dependent upon appropriate global observations of climate forcings, feedbacks, and diagnostics, and thus our role in EOS and the overall NASA Earth Science Enterprise is to help define needed observations and to use these observations in our research as they become available during the EOS flight era.

Current Activities

Our present focus is on analysis of the change of the global energy, water, and carbon cycles during the period after the 1991 eruption of the Mount Pinatubo volcano. The stratospheric aerosols produced by this volcano altered the thermal-energy balance by an amount comparable in magnitude to the perturbation that will be caused by doubling of atmospheric carbon dioxide. Pinatubo thus provides an excellent opportunity to test our understanding of the sensitivity of these global cycles to a global, albeit short-term, forcing. Observational evidence exists for changes of global and continental temperatures, in at-

mospheric carbon dioxide and methane abundances, and patterns of precipitation. We are involved in both development of data sets to document these changes and modeling studies to interpret the changes.

Use of Satellite Data

Understanding of climate change can be achieved only if the major global climate forcings and radiative feedbacks are monitored with adequate precision, which accounts for special dependence of our studies on data from several EOS instruments. ACRIM III and SOLSTICE will provide data essential to determination of the role of solar variability in global climate change. SAGE III will provide data on climate forcings due to changes of stratospheric aerosols, water vapor, and ozone. EOSP will measure tropospheric aerosols, the most uncertain of all anthropogenic climate forcings.

Measurements of long-term changes of cloud properties induced by aerosols and other anthropogenic effects represent a great challenge because of the needed precision and diurnal sampling. The Earth Science Enterprise is expected to provide the possibility for these measurements through small Earth Probe satellites.

The most fundamental diagnostics for our climate analyses are precise changes of temperature in the atmosphere, on the surface, and in the ocean, along with the planetary radiation balance. Thus we rely on AMSU and MHS data from operational satellites and EOS, as well as radiosonde and meteorological station measurements. Ocean temperatures are provided by ships and buoys; acoustic tomography may provide information on future trends of internal ocean temperatures over large regions. CERES on EOS provides monitoring of the planetary radiation balance, and, in combination with MODIS and other EOS instruments, will allow comprehensive analyses of cloud processes.

Participation in Field Programs

The greatest uncertainty in global climate forcings is the poor knowledge of changes in anthropogenic aerosols in the troposphere. Because of the great difficulty in measuring aerosol properties with sufficient accuracy from space, we have helped organize a proposed international

network of sun photometers, with the principal objective being measurement of aerosol changes. This proposed effort would involve students centrally in the data collection and analysis, thus contributing to science education as well as environmental studies.

Principal Investigator

James E. Hansen

James Hansen heads the Goddard Institute for Space Studies (GISS). A student of Astronomy and Physics (Ph.D. from the University of Iowa, 1967), he has focused his research primarily on radiative transfer in planetary atmospheres and related interpretation of remote soundings, development of simplified climate models and three-dimensional global models, and the study of climate mechanisms. In addition to his research and administrative duties at GISS, he serves as Adjunct Professor at Columbia University.

Co-Investigators

James K.B. Bishop - *Lawrence Berkeley National Laboratory*

Inez Y. Fung - *University of California-Berkeley*

Michael J. Prather - *University of California-Irvine*

Peter H. Stone - *Massachusetts Institute of Technology*

The following are from the NASA/Goddard Institute for Space Studies:

Barbara E. Carlson
Anthony Del Genio
Andrew A. Lacis
Elaine Matthews
Ronald Miller
Michael Mishchenko
David H. Rind
Drew Shindell
Ina Tegen
William B. Rossow

References

Del Genio, A.D., 1996: Observational requirements for modeling of global and regional climate change. *NATO ASI Series*, **45**, 31-57.

Fung, I., 1996: The global carbon cycle and the atmospheric record: "the problem definition." *NATO ASI Series*, **40**, 25-34.

Hansen, J., and 30 co-authors, 1996: A Pinatubo climate modeling investigation. *NATO ASI Series*, **42**, 233-272.

Hansen, J., M. Sato, A. Lacis, and R. Ruedy, 1997: The missing climate forcing. *Phil. Trans. Roy. Soc. Lond. B*, **352**, 231-240.

Hansen, J., M. Sato, A. Lacis, R. Ruedy, I. Tegen, and E. Matthews, 1998: Climate forcings in the industrial era. *Proc. Nat. Acad. Sci.*, **95**, 12,753-12,758.

Hansen, J., and 42 co-authors, 1997: Forcings and chaos in interannual to decadal climate change. *J. Geophys. Res.*, in press, Nov. 27 issue.

Lin, B., and W.B. Rossow, 1997: Precipitation water path and rainfall rate estimates over oceans using special sensor microwave imager and International Satellite Cloud Climatology Project data. *J. Geophys. Res.*, **102**, 9359-9374.

Matthews, E., 1997: Global litter production, pools, and turnover times. *J. Geophys. Res.*, **102**, 18,771-18,800.

Mishchenko, M.I., and L.D. Travis, 1997: Satellite retrieval of aerosol properties over the ocean using intensity and/or polarization of reflected sunlight: effect of measurement errors and aerosol absorption. *J. Geophys. Res.*, **102**, 13,543-13,553.

Prigent, C., W.B. Rossow, and E. Matthews, 1998: Global maps of microwave land surface emissivities: potential for land surface characterization. *Radio Sci.*, **33**, 745-751.

Rosenzweig, C., J.R. Phillips, R. Goldberg, J. Carroll, and T. Hodges, 1996: Potential impacts of climate change on citrus and potato production in the U.S. *Agricultural Systems*, **52**, 455-479.

Shindell, D.T., D. Rind, and P. Lonergan, 1998: Increased polar stratospheric ozone losses and delayed eventual recovery owing to increasing greenhouse gas concentrations. *Nature*, **392**, 589-592.

Shindell, D.T., S. Wong, and D. Rind, 1997: Interannual variability of the Antarctic ozone hole in a GCM. *J. Atmos. Sci.*, **54**, 2308-2319.

Investigation URL

<http://www.giss.nasa.gov>

Climate Processes Over the Oceans

Principal Investigator – **Dennis Hartmann**

Science Background

The surface climate of Earth is strongly influenced by the amount and distribution of water vapor, liquid water, and ice suspended in the atmosphere. The response of water vapor and clouds to a climate change is the single most important feedback process determining the magnitude of the climate change expected from forcings such as increasing carbon dioxide in the atmosphere. The processes that control water in the atmosphere are very complex and extend across a wide range of spatial scales from the few-centimeter scale of turbulence in the boundary layer to the tens of thousands of kilometers that characterize the scale of global atmospheric circulation systems. Seventy percents of the surface of Earth is covered with ocean, so that the humidity and cloud structure of the global atmosphere are largely determined by processes occurring in oceanic areas. The climate over land areas is in substantial measure determined by processes that occur over the oceans.

Science Goals

The overall goal of this investigation is to achieve improved modeling of the atmosphere and its interactions with the ocean through use of new data from satellites as well as through use of existing data. The intent is to address the roles of circulation, clouds, radiation, water vapor, and precipitation in climate change, and the role of ocean-atmosphere interactions in the energy and water cycles. This investigation is contributing to a comprehensive understanding of climate and its natural variability, and thereby to reduced uncertainty in predictions of future climate changes.

Current Activities

Available satellite observations, in situ data, and global assimilated-data sets, and a variety of models are being used to construct an integrated view of atmospheric climate over the oceans and to improve understanding and modeling of climate feedback processes. The physical processes considered involve boundary-layer dynamics and resulting fluxes, cloud-scale and mesoscale dynamics, cloud physics, and global-scale circulations. Interactions among clouds, water vapor, and radiation fluxes, and among various scales of motion from small scale to plan-

etary scale are incorporated. Important phenomena being studied are described below:

- *Boundary-layer fluxes of heat, momentum, and moisture:* The vertical exchanges of heat, moisture, and energy across the planetary boundary layer are critical to both the oceanic state and the atmospheric state. These fluxes are being studied with observations and models.
- *Marine boundary-layer clouds:* Low clouds over the ocean are extremely important for the energy balance of Earth because they are abundant and reflect large amounts of solar energy, but have only a small effect on escaping longwave radiation. Albedos of low-level clouds may be sensitive to sulfur aerosols produced by humans. Long-term trends in low clouds and their relation to SST and other variables are being derived from long records of surface observations. Efforts are underway to improve the ability of global climate models to simulate marine-boundary-layer clouds.
- *Tropical convective clouds:* Deep convective clouds in the tropics are the primary mechanism whereby solar heating of the ocean is moved upward into the free troposphere where it can be transported poleward and eventually emitted to space. The spatial organization and temporal development of convective systems and their relation to large-scale conditions are being studied with data from geosynchronous satellites and global meteorological analyses. Water-vapor data from TOVS, GOES, and GMS are being used to study the effect of deep convection and associated large-scale circulations on the moisture budget of the upper troposphere of the tropics. Explicit simulations with regional-scale models are being compared with observations to understand the relationships between convective cloud properties and large-scale climate.
- *Midlatitude synoptic systems:* These systems produce most of the precipitation in midlatitudes, and the clouds associated with them comprise a rich mixture of convective, layered, and stratiform cloud structures, which have important effects on the energy and water balances in midlatitudes. Synoptic storms in midlatitudes are responsible for extreme modifications of the planetary boundary layer and intense interactions with the ocean, which are being studied with scatterometer data.

Use of Satellite Data

Models of the boundary layer are being combined with information from satellites such as ERS-1&2, SSM/I microwave measurements, global weather analyses, and in situ measurements to estimate surface fluxes and to understand their relationship to atmospheric and oceanic phenomena. Information about surface wind speed from SeaWinds, combined with temperature and humidity data from AIRS/AMSU/HSB and AMSR-E will enable much-improved understanding and better estimates of surface fluxes to be gained from EOS satellites. High temporal and spatial resolution information on convective cloud systems and upper-tropospheric water vapor from GOES, GMS, and Meteosat are being used extensively. More-detailed global data on cloud abundance, structure, and optical properties can be derived from instruments such as MODIS, CERES, and MISR within EOS. Improved data on the abundance of tropospheric aerosols that may affect the radiation balance and influence cloud properties will be provided by EOSP and MISR, also on EOS. MLS and GLAS will provide unique information on upper-tropospheric water vapor and thin cirrus cloud decks, respectively.

Participation in Field Programs

The investigators are involved in a number of field programs that are closely related to the goals of this investigation, such as TOGA/COARE, Atlantic Stratocumulus Transition Experiment (ASTEX), TRMM surface validation, NSCAT ADEOS, QuikSCAT and SeaWinds validation and Pan American Climate Studies (PACS).

Principal Investigator

Dennis L. Hartmann

Professor Hartmann received his Ph.D. in Geophysical Fluid Dynamics from Princeton University in 1975. He joined the faculty of the Department of Atmospheric Sciences at the University of Washington in 1977, and has been an adjunct faculty member of the Quaternary Research Center since 1978. His main research interests are in stratospheric ozone, global climate, large-scale dynamics, and the radiative energy balance of Earth. He has published over 80 research papers on these topics and has authored a textbook about global climate. Hartmann served as a Principal Investigator in the Earth Radiation Budget Experiment (ERBE) and the Airborne Antarctic Ozone Experiment (AAOE), for which he received NASA Group Achievement Awards. He is a Fellow of the American Meteorological Society and the American Association for the Advancement of Science and serves on numerous national and international service and advisory bodies.

Co-Investigators

Christopher S. Bretherton - *University of Washington*

Robert A. Brown - *University of Washington*

Robert A. Houze, Jr. - *University of Washington*

Kristina Katsaros - *NOAA*

Conway B. Leovy - *University of Washington*

References

Chen, S.S., and R.A. Houze, Jr., 1997: Diurnal variation and lifecycle of deep convective systems over the tropical Pacific warm pool. *Quart. J. Roy. Meteor. Soc.*, **123**, 357-388.

Dickinson, S., and R.A. Brown, 1996: A study of near-surface winds in marine cyclones using multiple satellite sensors. *J. Appl. Meteor.*, **35**, 769-781.

Klein, S.A., D.L. Hartmann, and J.R. Norris, 1995: On the relationships among low cloud structure, sea surface temperature and atmospheric circulation in the northeast Pacific. *J. Climate*, **8**, 1140-1155.

Miletta, J., and K.B. Katsaros, 1995: Using coincident multispectral satellite data to assess the accuracy of SSM/I liquid water path measurements. *J. Geophys. Res.*, **100**, 16,333-16,339

Norris, J., and C. Leovy, 1994: Interannual variability in stratiform cloudiness and sea surface temperature. *J. Climate*, **7**, 1917-1925.

Salathé, E.P., and D.L. Hartmann, 1997: A trajectory analysis of tropical upper-tropospheric moisture and convection. *J. Climate*, **10**, 2533-2547.

Su, H., S.S. Chen, and C.S. Bretherton, 1999: Three-dimensional week-long simulations of TOGA COARE convective systems using the MM5 mesoscale model. *J. Atmos. Sci.*, in press.

Investigation URL

<http://cos.atmos.washington.edu>

Evaluation of Marine Productivity in the Tropical Pacific and Atlantic Oceans Using Satellite Ocean Color and Numerical Models

Principal Investigator – **Eileen Hofmann**

Science Background

The tropical ocean plays a major role in global-scale physical (oceanographic and meteorological) and biological processes. Variability in the equatorial ocean is dominated on interannual time scales in the Pacific and on seasonal time scales in the Atlantic. However, because of the difficulty in making routine measurements in the great expanses of the tropical ocean, spatial and temporal variability in these regions is difficult to monitor and monitoring is possible only by using extensive mooring arrays and satellites. Several programs have occurred and are ongoing to obtain physical data measurements in the tropical oceans. However, similar programs designed to collect biological data are not scheduled in the near future and thus the primary source of new biological information for these regions will be ocean color sensors, such as SeaWiFS and MODIS. Analyses and understanding of these data require inclusion of information from the physical and biological environments. Data-assimilative numerical models that include circulation, ecosystem, and optical components offer one approach for doing this.

Science Goals

Our research program focuses on four general topics of investigation in the tropical Pacific and Atlantic Oceans:

- 1) Interactions between physical and biological processes;
- 2) Evaluations of primary, new, and export production;
- 3) Diagnostic and predictive coupled physical-biological models; and
- 4) Data-assimilation techniques for model prediction skill and ecosystem parameter estimation.

The first two objectives will be addressed through analysis of ocean-color data. The latter two will be addressed through numerical modeling.

Specific research objectives are related to quantifying the contribution of high-frequency physical events to

nutrient, iron, and carbon fluxes in the equatorial Pacific, understanding variability in the western, central, and eastern Pacific Ocean and ecosystem that occurs in response to El Niño conditions, and determining the correspondence between satellite- and model-derived estimates of primary production in the tropical oceans.

Current Activities

A part of our current effort is directed at developing the data-analysis tools that will provide the ocean-color and other fields needed for the models. Concurrently, we are developing circulation and ecosystem models that can be used to understand processes affecting ocean-color distributions in the Tropical Pacific Ocean. Much progress has been made on the development of a coupled mixed-layer and bio-optical model, and a model of the lower trophic levels (nutrients, phytoplankton, and zooplankton). The ecosystem model includes dependencies of phytoplankton growth on light, temperature, and iron availability. A separate modeling effort is focused on understanding the role of *Trichodesmium* spp. in nutrient fluxes in tropical Pacific waters. These models will eventually be embedded in a three-dimensional circulation model for the Tropical Pacific Ocean.

Participation in Field Activities

This study will make considerable use of ocean-color measurements from the SeaWiFS sensor. These data will be processed using SeaDAS (Fu et al., 1996) to reveal trends in the distributions and to determine correlations with other geophysical data such as sea-surface temperature. The goal of this portion of our research is to provide ocean-color distributions that can be used for initialization, calibration, and verification of data-assimilative ecosystem models.

Other satellite-derived data sets, such as sea-surface temperature (from AVHRR) and surface wind and height fields (from TOPEX and SeaWinds) will be used with the circulation models in a data-assimilative mode. These data will be combined with a variety of in situ oceanographic and meteorological measurements.

Use of Satellite Data

Our project is focused on data analysis and modeling activities, and, consequently, there is no explicit field program associated with our study. However, we make extensive use of field measurements, especially those obtained from the TOGA/TAO mooring array and those from the U.S. JGOFS Equatorial Pacific (EqPac) study.

Principal Investigator

Eileen Hofman

Eileen Hofmann received her Ph.D. in Marine Sciences and Engineering from North Carolina State University, after which she spent time at Florida State University and Texas A&M University and then moved to Old Dominion University in 1989, where she is presently a Professor of Oceanography. Her research interests are in the areas of descriptive physical oceanography and mathematical modeling of physical-biological interactions in marine food webs. She is presently a member of the U.S. and International Science Steering Committees for the Global Ocean Ecosystem Dynamics (GLOBEC) Program, and is Chair of the GLOBEC Southern Ocean Planning Group.

Co-Investigators

Ichio Asanuma -

Robert A. Brown - *University of Washington*

Antonio Busalacchi - *NASA/Goddard Space Flight Center*

Chester Koblinsky - *NASA/Goddard Space Flight Center*

Marlon Lewis - *Dalhousie University*

Charles R. McClain - *NASA/Goddard Space Flight Center*

Michael McPhaden -

Ragu Murtugudde - *University of Maryland*

References

Fu G., B.D. Scheiber, K.J. Settle, M. Darzi, C.R. McClain, and K.R. Arrigo, 1996: SeaDAS: A processing package for ocean color satellite imagery. Proc. Twelfth Int. Conf. on Interactive Inform. and Processing Systems for Meteorol. Oceanogr. and Hydrol., *Am. Meteorolog. Soc.*, 451-456.

Characterizing Aerosol Forcing Over the Atlantic Basin

Principal Investigator – **Brent Holben**

Science Background

A major scientific activity of the aerosol community is to develop an improved understanding of the local and regional climatic impact of aerosol. Aerosol particles are believed to be the major cause for observations of a smaller than expected warming of the Earth-atmosphere-system due to greenhouse-gas increases. The impact of aerosol on the energy balance (and radiative transfer processes) in the Earth's atmosphere is expressed by a forcing, which captures the difference between aerosol-included and aerosol-free scenarios. The uncertainty of this forcing for (not just anthropogenic) aerosol is considerable. Many individual efforts to investigate aerosol properties and/or their impact on radiative-transfer processes have been pursued, yet a coordinated effort to link individual contributions into a common picture has been missing for historic as well as follow-on measurement systems. Such coordination for improved predictions of aerosol radiative forcing is our major objective.

Science Goals

The main objective of the proposed research is to characterize the local and regional radiative forcing from industrial/urban aerosol (mainly sulfates), Saharan dust, and aerosol from biomass burning transported over extensive regions of the Atlantic basin from the nearby continents. This objective will be achieved by a synergism between several tools: a comprehensive database of aerosol spectral optical thickness and size distribution derived from ongoing ground-based in situ and remote-sensing aerosol measurements currently operational in the Atlantic and adjacent continents; satellite data; transport models; and GCM models. By using these tools to characterize the aerosol physical and chemical characteristics, we plan to develop a climatology of the aerosol dynamic properties for these aerosol types, to test approaches for characterization of aerosols and their radiative forcing from satellites on present platforms and on future EOS platforms, and to develop and verify models for the aerosol evolution and transport and the effect of aerosols on climate.

Current Activities

To characterize the global aerosol variability in terms of concentration and properties and estimate its impact on climate, an integrated approach is applied, which includes accurate spectral satellite data, detailed ground-based remote-sensing and in situ measurements, and an application of the current knowledge in global circulation and regional transport models including aerosol chemistry. Our initial work focuses on the Atlantic rim regions, where repeated short-term field experiments geared towards particular aerosol types and long-term monitoring of aerosol chemistry and aerosol-related sunlight attenuation from individual ground locations provide a database of aerosol ground observations. After careful intercomparisons of redundant measurements these data are used to update aerosol databases, to validate satellite-based aerosol products (which are used for global monitoring), to validate (chemical) transport model results (initialized by aerosol sources), and to simulate the associated aerosol forcing (including impacts from uncertainties due to models, aerosol properties, surface reflectance, and the presence of clouds).

Use of Satellite Data

This investigation will incorporate a number of data products from EOS instruments and other satellites to more-precisely characterize aerosol source strengths for modeling radiative forcing, the temporal and spatial extent of aerosol optical properties, and evaluating the model output. This effort will build on the long-term record from existing systems such as TOMS, AVHRR, GOES, and METEOSAT, and provide an interface with new more-accurate aerosol data products from SeaWiFS, MODIS, MISR, and CERES.

Participation in Field Programs

The IDS team has heavily participated in ACE-2, TARFOX, SCAR-B, and BOREAS, as well as smaller campaigns relating to aerosol and cloud optical properties. Because of the great diversity of aerosol types, distributions, and short lifetimes, team members anticipate extensive field programs in regions of biomass burning (SAFARI-2000, LBA-CLAIRE), Desert Dust (ACE-3),

and urban marine mixtures (INDOEX) to name a few. This research by a highly interdisciplinary team with expertise in ground and satellite observations, and modeling provides a unique opportunity to combine data measurements from diverse sources with global-modeling resources.

Principal Investigator

Brent N. Holben

Brent Holben (M.S. Watershed Sciences, Colorado State University 1975) has worked at NASA's GSFC for 20 years performing research in both ground-based and satellite remote sensing of vegetation and aerosols. He is the project leader for the AERONET sun-sky radiometer network that is providing aerosol optical properties for a variety of globally distributed aerosol regimes.

Co-Investigators

Olivier Boucher - *Laboratoire de Meteorologie Dynamique*

G. J. Collatz - *NASA/Goddard Space Flight Center*

Jay Herman - *NASA/Goddard Space Flight Center*

Thomas Eck - *Raytheon ITSS Corporation*

Rich Ferrare - *NASA/Langley Research Center*

Elaine Prins - *CIMSS, Univ. of Wisconsin-Madison*

Joseph M. Prospero - *CIMAS, University of Miami, RSMAS*

Hank Margolis - *CRBF Abitibi-Price*

Stephen E. Schwartz - *ECD, Brookhaven National Laboratory*

Geary K. Schwemmer - *NASA/Goddard Space Flight Center*

Darold Ward - *U.S. Department of Agriculture*

References

Boucher, O., S.E. Schwartz, T.P. Ackerman, T.L. Anderson, B. Bergstrom, B. Bonnel, P. Chylek, A. Dahlback, Y. Fouquart, Q. Fu, T. Iversen, M.J. Hayward, S. Kato, S. Kinne, A. Kirkevag, K.R. Knapp, A. Lacis, I. Laszlo, S. Nemesure, V. Ramaswamy, D.L. Roberts, P. Russell, M.E. Sclesinger, G.L. Stephens, R. Wagener, M. Wang, J. Fong, and F. Yang, 1998: Intercomparisons of models representing shortwave radiative forcing by sulfate aerosols. *J. Geophys. Res.*, in print.

S. Kinne, R. Bergstrom, O.B. Toon, E. Dutton, and M. Shiobara, 1998: Clear sky atmospheric solar transmission: an analysis based on FIRE 1991 field experiment data. *J. Geophys. Res.*, in print.

Investigation URL

<http://spamer.gsfc.nasa.gov>

Regarding the plot I am suggesting to contribute with a plot which compares the monthly averaged direct (local) forcing for biomass burning aerosol—based on multiyear AERONET statistics—for South American, African and Canadian sites.

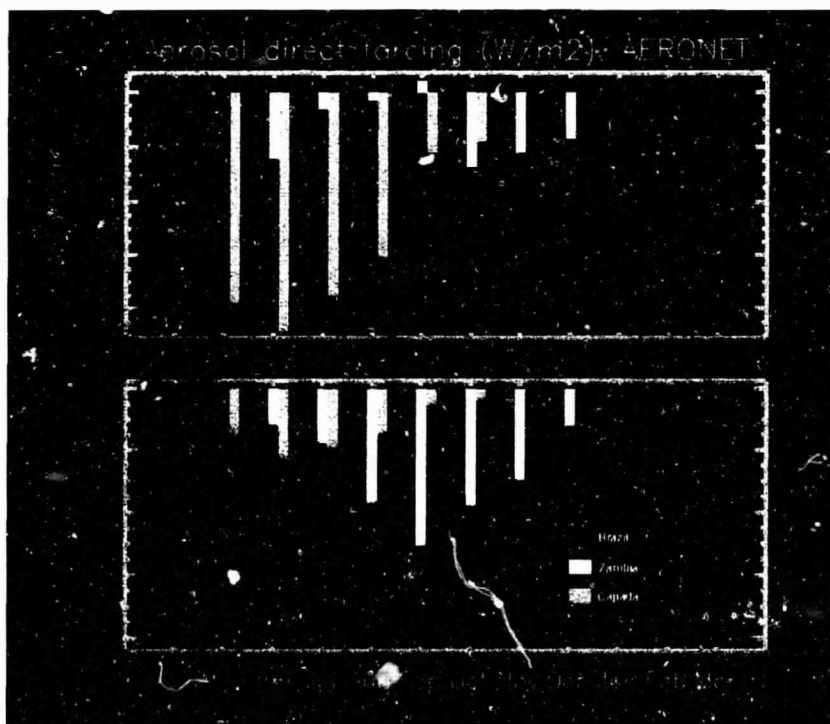

Assessing the Impact of Expanding Urban Land Use on Agricultural Productivity Using Remote Sensing Data and Physically Based Soil Productivity Models

Principal Investigator – **Marc Lee Imhoff**

Science Background

This project is intended to develop the tools and models for mapping the extent of urbanization and to assess the impact of this process on the Earth's biosphere and for making recommendations concerning the future food security of the human race. As more land is converted to urban uses, the question arises as to whether or not this represents a systematic reduction in our ability to produce food by placing our infrastructure on the most productive soil resources. Given present demographic trends, it is important that these land-use issues be resolved, as a rapidly growing number of regional populations are at risk with respect to socio-political and economic instabilities and their consequent effects on the food supply. Currently, both the magnitude and the potential effects of urban land transformation are hotly debated due to difficulties in making accurate measurements of the area of urban land use and assessing the impact of these changes on agricultural land area or production. The project will use satellite data from various sources to map the extent and location of human habitation. Natural resource, census, and agronomic data will be acquired, digitized, and co-registered to the satellite data in a geographic information system (GIS) for analysis and model development.

Science Goal

The goal of this investigation is to first understand and then predict the effect of urban land transformation on the Earth's primary productivity and translate that understanding into meaningful applications in global climate-change and food-security studies. We will seek to improve our understanding of the Earth's soils as a supporting matrix for photosynthesis and agricultural production at regional and global scales. We will develop techniques for determining the full extent of urbanization and relate the urban land transformation process to demographic data. Finally, we will improve our knowledge of how urbanization affects soil resources by calculating the impacts directly as a function of the transformed area of fertility-rated soils.

Current Activities

Within the context of global food security, this group has determined three key regions of focus: The United States and Mexico, Egypt and the Middle-East, and China. These focus areas were selected for their significance in terms of agricultural production, population, and strategic importance. Satellite data, soils maps, and demographic data for these regions are being collected and local investigators for the international components are being contacted. In order to develop the methodologies for mapping human habitation and making the impact assessment, this group has conducted a test in the United States using nighttime satellite-image data from the Department of Defense, digital soils maps from the United Nations Food and Agriculture Organization, and U.S. Census data. A preliminary assessment was made evaluating the urban mapping methods and the amount and quality of soils being urbanized in the US.

Use of Satellite Data

The project will make use of a wide variety of EOS and non-EOS satellite data. The primary satellite data set will be the Defense Meteorological Satellite Program's Operational Linescan System (DMSP/OLS), which acquires visible and NIR images of the Earth at night. DMSP/OLS detects urban areas and other sites of significant human activity by their lights. The accuracy of these data for urban mapping will be enhanced and evaluated using Landsat ETM+ and MODIS data. Land-cover, climate, and other satellite-derived data sets from other EOS investigators will also be used to help develop the soil-fertility rating system.

Participation in Field Programs

This team will participate in field data programs, but in a way not usually seen in past EOS investigations. Our primary focus will be on urban and peri-urban areas and the assessment and evaluation of the nature of the transformation of the soil. We will concentrate on soil physical

properties of both transformed and non-urbanized soils and their surface area in order to gauge the impact of the transformation.

Principal Investigator

Marc L. Imhoff

Marc Imhoff is a graduate of the Pennsylvania State University, received a Ph.D. from Stanford University, and is currently based at NASA's Goddard Space Flight Center, Biospheric Sciences Branch. He has been extensively involved in international remote sensing and science projects serving as a principal investigator on studies designed to map monsoon flooding and forest biomass in Bangladesh and wildlife habitats in Australia using a variety of remotely sensed imagery.

Co-Investigators

Christopher Elvidge - *NOAA/NGDC*

William T. Lawrence - *Bowie State University*

Gary W. Petersen - *The Pennsylvania State University*

Sharon Waltman - *National Soil Survey Center, USDA/NRCS*

References

M.L. Imhoff, W.T. Lawrence, C.D. Elvidge, T. Paul, E. Levine, M.V. Privalsky, and V. Brown, 1997: Using nighttime DMSP/OLS images of city lights to estimate the impact of urban land use on soil resources in the U.S. *Remote Sens. Environ.*, **59**, 105-117.

M.L. Imhoff, W.T. Lawrence, D.C. Stutzer, and C.D. Elvidge, 1997: A technique for using composite DMSP/OLS "City Lights" satellite data to accurately map urban areas. *Remote Sens. Environ.*, **61**, 361-370.

Investigation URL

<http://jhampa.gsfc.nasa.gov/index.html>

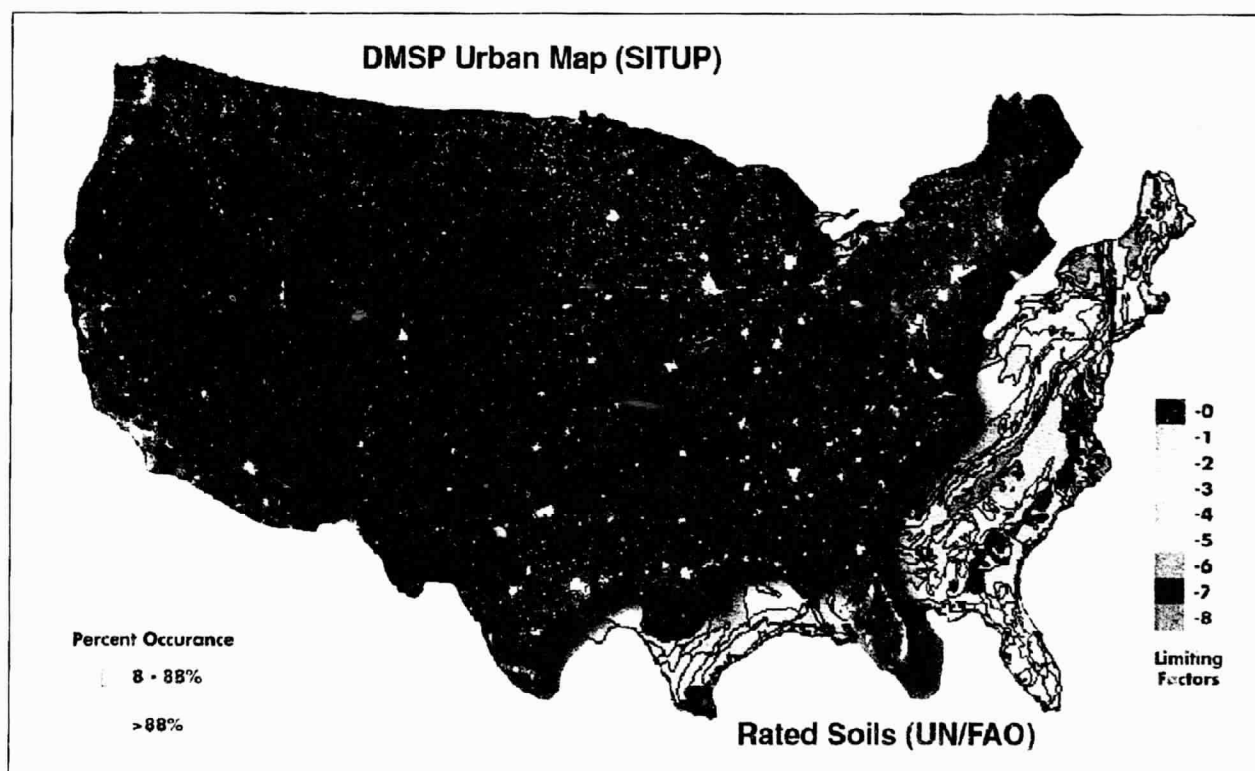

Shown above is a satellite-derived "city lights" map of urbanized area for the United States being overlain on the United Nations Food and Agriculture Organization's Digital Soils Map. The urban map was generated directly from DMSP/OLS imagery using a technique, developed by this project, called Spatial Integrity Thresholding of Urban Polygons (SITUPS). The thresholding technique created an urban map which compared very well with U.S. Census estimates of urbanized area in the U.S. The soils data are rated according to the number of physical factors present in the soil that limit agricultural production. Results of this work showed, undeniably, that many of our best agricultural soils are being lost to urbanization.

Soil Moisture Mapping at Satellite Temporal and Spatial Scales

Principal Investigator – **Thomas J. Jackson**

Science Background

There has been a significant growth in the recognition of the importance of soil-moisture information in large scale hydrology and climate modeling. Recent publications have made the analogy that soil moisture may have the same role in land hydrology that sea-surface temperature (i.e., El Niño) plays in climate, providing a seasonal memory for the system. There is a need to reevaluate the role that the Earth Science Enterprise (ESE) can play in providing measurements of soil moisture. There are potential satellite observing systems that could be implemented. However, there are still some important questions that need to be answered. Unfortunately, there are only sparse soil-moisture data sets that could in any way represent the types of observations that a satellite observing system might provide. The limited data available, such as Washita '92 (<http://hydrolab.arsusda.gov/washita92/wash92.htm>), have produced remarkable results and insights.

Science Goals

This investigation addresses remote sensing and the scales of temporal and spatial observation of surface soil moisture. Specific objectives are: 1) establish that higher resolution soil-moisture brightness-temperature algorithms developed using truck and aircraft sensors can be extended to the coarser resolutions expected from satellite platforms, 2) examine the spatial and temporal dynamics of surface soil moisture at an order of magnitude greater than previous investigations, and 3) develop a database for soil-moisture hydrology and land-atmosphere-interaction investigations. The results of this research are expected to establish the validity of current soil-moisture estimation algorithms at spatial scales typical of projected satellite systems, provide insights for the design of an observing system with regard to temporal features, explore the integration of ground-based and remote observing systems, and provide a unique data set to the large-scale hydrology and climate-modeling research community.

Current Activities

The core of this investigation is a large-scale aircraft soil-moisture mapping experiment, the Southern Great Plains

1997 (SGP97) Hydrology Experiment, conducted over a one-month period in the summer of 1997. Surface soil moisture was mapped over an area of ~10,000 km² (an order of magnitude larger than previously observed) of Oklahoma at a spatial resolution compatible with known data-interpretation algorithms (~1 km). The resulting database will allow the scaling up to projected satellite-sized footprints (~10 km) and cover an area large enough to provide nearly 100 of these satellite-sized pixels. These data will allow the examination of the information content of coarse-resolution data as well as the analysis of the spatial distribution over climate/atmospheric model scales. Convective fronts and local feedbacks may be observable at these scales.

Data were collected using an L band passive microwave mapping instrument called ESTAR, which was flown on a NASA P-3 aircraft. In addition to the L band system, other ground, aircraft, and satellite measurements were obtained concurrently. This comprehensive database is currently being assembled and will be a valuable contribution to a broad range of science investigations, including other ESE studies. The L band ESTAR data processing is complete and soil-moisture maps have been developed. Distinct spatial structure is quite apparent in the results. Some of this is a function of rainfall events, and some is related to soil and vegetation features.

Use of Satellite Data

Soil-moisture sensing requires long-wavelength microwave sensors. Within the current EOS program the longest wavelength sensor is the C band instrument that will be part of the Advanced Microwave Scanning Radiometer (AMSR-E). A similar instrument will be part of the Japanese ADEOS-II. Current research utilizes a wide variety of satellite data. Microwave sensors on the Russian MIR platform were used in the 1997 experiments. All existing radar satellites (Radarsat, JERS, and ERS) acquired data as part of SGP97 and data are being analyzed. SSM/I, Landsat, and NOAA AVHRR data are also important components of the research. In the next phase of research, data from the TRMM Microwave Imager will be utilized.

Participation in Field Programs

As noted, a major focus of this project revolves around field projects. The Southern Great Plains 1997 (SGP97) Hydrology Experiment provided a focal point for a number of collaborative EOS ESE investigations. Motivated by wide-spread interest among hydrologists, meteorologists, soil scientists, and ecologists, in the problems of estimating soil moisture at the continental scale and coupling between land surface and atmosphere the original soil-moisture experiment was broadened significantly. SGP97 was successfully completed and data analyses are currently underway. This work will provide a foundation for future satellite sensors and calibration/validation programs for soil moisture algorithms. A field program has been initiated to develop and calibrate soil-moisture algorithms for the AMSR instruments that will be part of the EOS-PM and ADEOS-II satellites. This effort will start in the summer of 1999 and continue through the launch of the instruments.

Principal Investigator

Thomas J. Jackson

Thomas J. Jackson obtained a Ph.D. in Civil Engineering from the University of Maryland in 1976. He has been a hydrologist with the USDA Agricultural Research Service Hydrology Lab since 1977. His research involves the application and development of remote-sensing technology in hydrology and agriculture. He has conducted research on the use of visible/near-infrared satellite data for deriving land-cover parameters used in hydrologic models and the use of an airborne laser profiler for measuring and monitoring soil erosion. The results of the laser-profiling research led to a paper titled "Airborne Laser Measurements of the Surface Topography of Simulated Concentrated Flow Gullies," (1990) that received the "paper of the year" award by the American Society of Agricultural Engineers. His current research focuses on the use of passive-microwave techniques in hydrology. A recent paper titled "Diurnal observations of surface soil moisture using passive microwave radiometers" was selected as the prize paper at the International Geoscience and Remote Sensing Symposium for 1994. He is also a member of the Japanese AMSR Science Team. He is a member of AGU and IEEE and currently serves on the Administrative Committee of The Geosciences and Remote Sensing Society.

Co-Investigators

Calvin T. Swift - *University of Massachusetts*

David M. Levine - *NASA/Goddard Space Flight Center*

Patrick J. Starks - *USDA Agricultural Research Service*

Peggy E. O'Neill - *NASA/Goddard Space Flight Center*

References

Jackson, T.J., 1993: Measuring surface soil moisture using passive microwave remote sensing. *Hydrological Processes*, **7**, 139-152.

Jackson, T.J., D.M. Le Vine, C.T. Swift, T.J. Schmugge, and F.R. Schiebe, 1995: Large area mapping of soil moisture using the ESTAR passive microwave radiometer in Washita '92. *Remote Sens. of Environ.*, **53**, 27-37.

Jackson, T.J., 1997: Soil moisture estimation using SSM/I satellite data over grassland region. *Water Resources Res.*, **33**, 1475-1484.

Jackson, T.J., P.E. O'Neill, and C.T. Swift, 1997: Passive microwave observation of diurnal surface soil moisture. *IEEE Trans. Geosci. Remote Sens.*, **35**, 1210-1222.

Investigation URLs

(Project) <http://hydrolab.arsusda.gov/sgp97/>

(Data) http://daac.gsfc.nasa.gov/CAMPAIGN_DOCS/SGP97/sgp97.html

Related URLs

(Washita '92 Hydrology Experiment)
<http://hydrolab.arsusda.gov/washita92/wash92.htm>

(ADEOS-II AMSR)
<http://www.eorc.nasda.go.jp/ADEOS-II/AMSR/amr.html>

(Microwave Remote Sensing-U of Mass.)
<http://www.ecs.umass.edu/ece/labs/mirsl.html>

Investigation of the Coupling Between Tropospheric Ozone, Sulfate Aerosols, and Climate Using a General Circulation Model

Principal Investigator – **Daniel J. Jacob**

Science Background

The radiative forcings associated with anthropogenic perturbations to tropospheric ozone and sulfate aerosols could have important climatic effects. Ozone and sulfate are produced in the troposphere by chemical reactions involving precursors emitted by both anthropogenic and natural sources. They have relatively short atmospheric lifetimes and hence inhomogeneous atmospheric distributions. Estimates of the global mean radiative forcing at the tropopause due to changes in tropospheric ozone from pre-industrial times to today range from 0.2 to 0.6 W m^{-2} , as compared to 1.6 W m^{-2} for CO_2 . For sulfate aerosols, the forcing is estimated to range from -0.3 to -3.0 W m^{-2} . The actual forcings from tropospheric ozone and aerosols are regionally variable, and can be greatly affected by correlations with meteorological variables (e.g., humidity, cloud cover, temperature), adding considerable complexity to an assessment of climatic impact. The concentrations and distributions of ozone and sulfate are also sensitive to changes in climate, resulting in intricate feedbacks. Relating the emissions of ozone and sulfate precursors to their ultimate climatic effects requires a global climate model that includes coupled, consistent, and realistic representations of ozone and sulfate aerosols.

Science Goal

Our work is motivated by five central questions:

- 1) What are the climatic effects of changes in the emissions of tropospheric ozone precursors?
- 2) How does tropospheric ozone respond to climate change and what are the feedbacks on climate?
- 3) What are the climatic effects of changes in the emissions of sulfate precursors?
- 4) How do sulfate aerosols respond to climate change, and what are the feedbacks on climate?
- 5) What are the couplings between the climatic effects of tropospheric ozone and sulfate aerosols?

Our approach to these questions is to incorporate process-based simulations of tropospheric ozone and sulfate aerosols into a new generation NASA/GISS general circulation model (GCM 2') and into a chemical tracer model (CTM) driven by assimilated meteorological data from the Goddard Earth Observing System Data Assimilation System (GEOS-DAS). The same modules for emissions, chemistry, deposition, and aerosol processes are implemented in the GISS GCM and in the GEOS CTM. We use the GCM to study the radiative and climatic effects of changes in tropospheric ozone and sulfate aerosols from pre-industrial times to today and into the future. At the same time, we use the GCM and the GEOS CTM to improve our understanding of the processes controlling tropospheric ozone and sulfate through detailed comparisons of model results with observations. Simulations with the GEOS CTM focus on specific field programs, affording better constraints for model evaluation.

Current Activities

We have incorporated on-line simulations of tropospheric ozone chemistry and sulfate aerosols into the GISS GCM 2, and conducted extensive evaluations of model results with climatological observations. We have used these simulations to calculate radiative forcings from ozone and sulfate aerosols over the past century, focusing on the factors that drive the heterogeneity in the forcings. We have compared on-line and off-line calculations of the radiative forcings and interpreted the differences between the two in terms of synoptic-scale correlations of ozone and aerosols with clouds. We have implemented on-line simulations of ammonia and sulfate-nitrate-ammonium-water thermodynamics in the GCM and evaluated results with observations; this simulation has allowed us to obtain a better understanding of the composition and water content of aerosols in different regions of the troposphere, and of the radiative implications. Publications on all these studies are available through our web site.

Our current work involves further development and application of our capability for coupled chemistry-aerosol-climate GCM simulations. Specific tasks for the year ahead include: 1) addition of aerosol types other than sulfate, and resolution of the aerosol size distribution; 2) in-

vestigation of the indirect radiative effect driven by aerosol influence on cloud microphysics; 3) merging of the ozone and sulfate-nitrate-ammonium simulations for study of chemistry-aerosol coupling; 4) investigation of climate forcing due to changes in tropospheric ozone from preindustrial to present; 5) investigation of ozone chemistry in preindustrial and future atmospheres; and 6) development of an on-line tropospheric chemistry simulation capability in the high-resolution (23-layer) version of the GISS GCM 2'.

In parallel to our GCM work, we have also developed capabilities for simulation of tropospheric ozone and sulfate aerosol in the GEOS CTM driven by assimilated meteorological observations. The sulfate model has been applied to simulations of the ACE-1, PEM-West A and B, and PEM-Tropics A aircraft campaigns. Results from these simulations have led to improved modeling of the corresponding processes in the GISS GCM, notably the oceanic emission of sulfur. The ozone model is presently being applied to a simulation of the PEM-West B campaign.

Our investigation interacts closely with space-based observations, both in terms of using the observations to test our models and in terms of using our model analyses to guide the design of the next generation of satellite measurements. We plan to make particular use of SAGE III for upper tropospheric and lower stratospheric ozone, MOPITT for CO, and the CHEM instrument ensemble for ozone and related species. In addition we plan to examine ERBE, CERES, and AIRS observations of radiation at the top of the atmosphere for ozone and aerosol effects.

Use of Satellite Data

Detailed evaluation with observations will be essential for assessing the capabilities of our chemistry-aerosol-climate models. Space-based data to be used for this purpose include SAGE III for upper tropospheric ozone; TOMS and SAGE III for tropospheric ozone residuals; and MAPS and MOPITT for CO. In addition, ERBE and CERES satellite observations of radiation at the top of the atmosphere will be examined for ozone and aerosol effects.

Participation in Field Activities

We have applied our ozone and sulfate models based on the GEOS CTM to simulation of the ACE-1, PEM-West A and B, and PEM-Tropics A aircraft campaigns. We plan over the next few years to apply these models to simulation of the SONEX aircraft campaign over the North Atlantic and the PEM-Tropics B aircraft campaign over the South Pacific. These campaigns include concurrent measurements of a large suite of chemical species over a large spatial domain and are thus particularly well-suited for

testing a global model driven by assimilated meteorological observations. Results from these simulations will be used on an ongoing basis to improve the descriptions of ozone and sulfur chemistry in the GISS GCM.

Principal Investigator

Daniel J. Jacob

Daniel J. Jacob is the Gordon McKay Professor of Atmospheric Chemistry and Environmental Engineering at Harvard University. He holds degrees in Chemical and Environmental Engineering (Ph.D., California Institute of Technology, 1985). His research focuses on improving knowledge of the chemistry of the troposphere and addresses problems ranging from urban air pollution to global environmental change. He contributes to several EOS committees and has chaired two recent NASA workshops on atmospheric chemistry measurements from space. He is Mission Scientist of the Pacific Exploratory Mission-Tropics aircraft campaigns and is a recipient of the AGU Macelwane Medal (1994).

Co-Investigators

Mian Chin - *NASA/Goddard Space Flight Center*

Dorothy M. Koch - *NASA/Goddard Institute of Space Studies*

Jennifer A. Logan - *Harvard University*

Michael J. Prather - *University of California at Irvine*

David Rind - *NASA/Goddard Institute of Space Studies*

John H. Seinfeld - *California Institute of Technology*

Anne M. Thompson - *NASA/Goddard Space Flight Center*

References

Adams, P.J., J.H. Seinfeld, and D.M. Koch: Global composition of tropospheric sulfate aerosol simulated in a general circulation model. *J. Geophys. Res.*, submitted.

Chin, M., R.B. Rood, D.J. Allen, M.O. Andreae, A. M. Thompson, S.A. Yvon-Lewis, R.R. Atlas, and J.V. Ardizzone, 1998: Processes controlling dimethyl sulfide over the ocean: Case studies using a 3-D model driven by assimilated meteorological fields. *J. Geophys. Res.*, **103**, 8341-8353.

Koch, D.M., D. Jacob, I. Tegen, D. Rind, and M. Chin: Tropospheric sulfur simulation and sulfate direct radiative forcing in the GISS GCM. *J. Geophys. Res.*, submitted.

Rind, D., J. Lerner, K. Shah, and R. Suozzo, 1999: Use of on-line tracers as a diagnostic tool in general circulation model development, 2. Transport between the troposphere and stratosphere. *J. Geophys. Res.*, in press.

Tegen, I., P. Hollrigl, M. Chin, I. Fung, D. Jacob, and J. Penner, 1997: Contribution of different aerosol species to the global aerosol extinction optical thickness: estimates from model results. *J. Geophys. Res.*, **102**, 23,895-23,915.

Wang, Y., and D.J. Jacob, 1998: Anthropogenic forcing on tropospheric ozone and OH since preindustrial times. *J. Geophys. Res.*, **103**, 31,123-31,135.

Wang, Y., D.J. Jacob, and J.A. Logan, 1998: Global simulation of tropospheric ozone-NO_x-hydrocarbon chemistry, 3. Origin of tropospheric ozone and effects of non-methane hydrocarbons. *J. Geophys. Res.*, **103**, 10,757-10,768.

Investigation URL

<http://www-as.harvard.edu/chemistry/trop/ids.html>

A Study of Carbon Monoxide Using Trace Constituent Data Assimilation: A New Approach in Global Tropospheric Chemistry Analysis

Principal Investigator – Prasad Kasibhatla

Science Background

The global biogeochemical cycles of a number of trace gases depend critically on their chemical processing in the troposphere. In this context, the hydroxyl radical (OH) is the key species in determining the chemical processing potential of the troposphere. The tropospheric OH concentration depends non-linearly on the local concentrations of CO, nonmethane hydrocarbons, and nitrogen oxides. The tropospheric distribution of these compounds in turn is quite variable owing to the heterogeneous spatial and temporal distribution of their sources, as well as due to their relatively short lifetime (days to months) in the troposphere.

In this investigation we focus on CO, which is the largest sink of OH in the troposphere. In recent years, infrared absorption measurements from space have offered the promise of providing a global picture of the CO distribution (Reichle et al. 1986; Reichle et al. 1990) and of shedding light on the various processes that shape this distribution (Newell et al. 1988; Connors et al. 1989; Watson et al. 1990). More recently, a sophisticated three-dimensional chemical transport model driven using assimilated meteorological fields for specific time periods has been used to analyze certain aspects of the global CO distribution (Allen et al. 1996). However, there has been no attempt to combine model results with CO measurements in a systematic manner.

This investigation is directed towards developing and applying trace-constituent data-assimilation techniques to systematically analyze space-based, airborne, and ground-based tropospheric CO measurements. Specifically, we will develop and apply an improved version of the NASA GSFC/DAO CO chemical transport model (CTM, Allen et al. 1996) in this investigation. In addition to being directly applicable to analyzing CO measurements from the MOPITT instrument, it is anticipated that the techniques developed as part of this project will be also be useful for interpreting future measurements of other tropospheric species from the TES instrument.

Science Goals

The scientific goals of this investigation are to: 1) develop methodologies to synthesize results from numerical chemical transport models with in situ and remote trace-gas measurements; 2) develop a comprehensive picture of the spatial CO distribution and temporal variability in the troposphere; and 3) elucidate the factors that are responsible for shaping the tropospheric CO distribution.

Current Activities

Major modifications have been made to the NASA GSFC/DAO CO chemical transport model to incorporate interactive CO-OH chemistry. This represents a significant advance over the original formulation, in which prescribed OH fields were used and no feedback was allowed between modeled CO and OH fields. The modifications involved incorporating a parameterized tropospheric OH calculation scheme into the CTM. In addition, other data sets required for the parameterized chemical calculations were acquired and processed for use in the CTM. These include global distributions of nitrogen oxides, ozone, water vapor, and total-column ozone, global climatologies of low-, middle-, and high-level cloud frequencies, and global albedo and land/ocean data.

The fossil-fuel combustion emission inventory for CO was updated based on an up-to-date emission inventory. In this inventory, CO emission rates are calculated using an energy database from the United Nations that gives consumption statistics for the end use of each fuel in 32 categories, along with emission factors for particular processes derived from EPA reports and the European CONAIR inventory. CO production from the oxidation of anthropogenic hydrocarbons, which was neglected in the original formulation of the model, is included by scaling the fossil-fuel CO source by a factor of 1.2. In addition, CO emissions from the burning of wood fuel and an up-to-date inventory of biomass-burning CO emissions will soon be incorporated into the CTM.

In parallel with the model development activities, the compilation of a comprehensive global observational dataset for CO has also been initiated. Preliminary data

files for sites in the Climate Monitoring and Diagnostics Laboratory (CMDL) cooperative air-sampling network and the in situ measurements from Pt. Barrow, AK, and Mauna Loa, HI, have been prepared. In particular, monthly-mean mixing ratios for 1994 at these surface sites have been compiled. In addition, preliminary data files of surface and airborne correlative CO measurements made during the April and October 1994 MAPS missions have been prepared. An important feature of these observation data sets is that all measurements are referenced to the NOAA/CMDL CO reference scale. We have also acquired the April and October 1994 MAPS CO measurement data files.

The CO distribution during the 1993-1994 time period has been simulated using the updated model. Results of these calculations have been compared to monthly mean CO measurements at the NOAA/CMDL surface sites. With a few exceptions, the updated model appears to capture the spatial and seasonal distribution of CO during 1994.

Further analysis is underway to identify the causes of specific shortcomings in the model, and to evaluate the model results against the airborne and MAPS CO measurement data sets as well. It is anticipated that a simulation with an updated biomass-burning source function will be completed shortly. In addition, enhancements to the model are being developed to characterize the budget of CO in various regions of the globe.

Use of Satellite Data

Prior to the deployment of the EOS sensors, this project involves the use of space-based CO measurements made during the 1994 SRL-1 and SRL-2 space-shuttle flights. Subsequent to the launch of the EOS Terra platform, model results will be evaluated against tropospheric CO measurements from MOPITT.

Principal Investigator

Prasad Kasibhatla

Prasad Kasibhatla received his undergraduate degree from Bombay University and his M. S. and Ph.D degrees from the University of Kentucky. He has 15 years of experience in regional and global tropospheric chemistry research. He is particularly interested in the effects of anthropogenic emissions on atmospheric chemical composition. From 1988 to 1995, he was a research scientist at the Georgia Institute of Technology. During this period he was also a visiting scientist at NOAA/GFDL from 1988 to 1993, and at NASA/GSFC from 1994 to 1995. From 1995 to 1996 he was a research scientist at MCNC/Environmental Programs. He is currently an assistant research professor at Duke University, where he also teaches a graduate-level course in atmospheric chemistry. In addition to his research and teaching responsibilities, he is

currently serving as co-convener of the IGAC/Global Integration and Modeling (GIM) Activity and is a member of the organizing committee of the Fourth World Climate Research Programme Workshop on Chemical Transport Modeling. He has received a NASA Group Achievement Award for his role as a member of the MAPS Science Team.

Co-Investigators

Vickie S. Connors - *NASA/Langley Research Center*

Jennifer A. Logan - *Harvard University*

Richard Menard - *University of Maryland Baltimore County/JCEST*

Paul C. Novelli - *NOAA/Climate Monitoring and Diagnostics Laboratory*

Henry G. Reichle - *North Carolina State University*

References

Allen, D.J., P. Kasibhatla, A.M. Thompson, R.B. Rood, B.G. Doddridge, K.E. Pickering, R.D. Hudson, and S.-J. Lin, 1996: Transport-induced interannual variability of carbon monoxide using a chemistry and transport model. *J. Geophys. Res.*, **101**, 28,655-28,669.

Connors, V.S., T. Miles, and H.G. Reichle, Jr., 1989: Large-scale transport of a CO-enhanced air mass from Europe to the Middle East. *J. Atmos. Chem.*, **9**, 479-496.

Newell, R.E., S.T. Shipley, V.S. Connors, and H.G. Reichle, Jr., 1988: Regional studies of potential carbon monoxide sources based on space shuttle and aircraft measurements. *J. Atmos. Chem.*, **6**, 61-81.

Reichle, H.G., Jr., V.S. Connors, J.A. Holland, W.D. Hypes, H.A. Wallio, J.C. Casas, B.B. Gormsen, M.S. Saylor, and W.D. Hesketh, 1986: Middle and upper tropospheric carbon monoxide mixing ratios as measured by a satellite-borne remote sensor during November 1981. *J. Geophys. Res.*, **91**, 10,865-10,887.

Reichle, H.G., Jr., V.S. Connors, J.A. Holland, R.T. Sherrill, H.A. Wallio, J.C. Casas, E.P. Condon, B.B. Gormsen, and W. Seiler, 1990: The distribution of middle tropospheric carbon monoxide during early October 1984. *J. Geophys. Res.*, **95**, 9845-9856.

Watson, C.E., J. Fishman, and H.G. Reichle, Jr., 1990: The significance of biomass burning as a source of carbon monoxide and ozone in the southern hemisphere tropics: A satellite analysis. *J. Geophys. Res.*, **95**, 16,443-16,450.

Southern Ocean Seasonal Net Production From Atmosphere and Ocean Data Sets

Principal Investigator – **R. F. Keeling**

Scientific Background

As it is not possible to directly observe many of the key quantities needed for adequately understanding the biogeochemical cycling of materials on the Earth, it therefore is crucial to develop methods for estimating these quantities from those we can observe. Specifically needed are methods that improve our capability to extrapolate local observations to the larger spatial scales. One of the significant components that is under detailed study by the Joint Global Ocean Flux Study (JGOFS) is the net photosynthesis of the oceanic photic zone and its relationship to surface CO₂ partial pressure and air-sea CO₂ flux. While models and extrapolations of ocean total and net primary production are available, there has been limited use of global chemical data sets to constrain the estimates.

Over the past few years several large data sets have been gathered by JGOFS and other programs for the purpose of determining processes that control the partitioning of carbon in the ocean and exchanges between the ocean and the atmosphere and for developing the capability to predict how changes in the environment will influence this partitioning (Sarmiento and Armstrong 1997). Several of these data sets, including the JGOFS/WOCE survey of ocean carbon concentrations (Takahashi et al. 1997), the climatology of seasonal O₂ variability in surface waters (Najjar and Keeling 1997), observations of variations in the atmospheric O₂ concentration (Keeling et al. 1996; Bender et al. 1996; Keeling et al. 1997), and satellite observations of ocean color (Feldman et al. 1989), provide unprecedented opportunities for characterizing and interpreting chemical fluxes on large spatial scales.

Science Goals

An analysis of the relationships between the large-scale chemical data sets, their relationship to ocean productivity, and linkages to the ultimate physical, biological, and chemical controls on productivity is our primary objective. Our study will focus on using chemical budgets to constrain productivity and carbon fluxes at middle and high latitudes in the Southern Hemisphere. We choose to focus on these regions because of their importance in controlling exchanges with the deep ocean (Sarmiento and Toggweiler 1984; Siegenthaler and Wenk 1984; Broecker

1991), because the high degree of zonal symmetry in both the ocean and the atmosphere presents a natural testbed for models, and because the new data sets provide unprecedented opportunities for improving flux estimates in these regions.

The biological production and deep mixing of the Southern Ocean lead to significant exchange of O₂ with the atmosphere on seasonal time scales. These exchanges are most graphically illustrated in the seasonal variations in O₂ concentration that have been observed at surface stations at middle and high latitudes of the southern hemisphere (Keeling and Shertz 1992; Bender et al. 1996; Keeling et al., 1998). The oceans tend to be a source in the spring and summer months when light levels are higher and the water column is well stratified, while they are a net sink in the winter time. The changes in atmospheric O₂ concentration are dispersed throughout the southern hemisphere on time scales of week to months, although the southern hemisphere as a whole remains largely isolated from the northern hemisphere on these time scales due to slow mixing across the intertropical convergence zone (Keeling and Shertz 1992). Superimposed on these biologically-mediated fluxes are additional O₂ fluxes driven by temperature-induced changes in solubility in the water. This thermal component is relatively small and can be reasonably well estimated from the air-sea heat flux allowing the larger biologically mediated component to be computed from the total flux minus the thermal flux. It is also possible that the biological component of the flux may be closely associated with the net air-heat flux, a possibility that was first suggested in Keeling et al. (1993), and which will be exploited further in our studies.

The seasonal variations in atmospheric O₂ concentration place constraints on the magnitude of net ingassing and outgassing of O₂ with the ocean on a seasonal time scale. While the atmospheric data alone constrain the magnitude of the air-sea fluxes only over large scales due to atmospheric mixing, additional information on the patterns of air-sea O₂ exchange are provided by the climatology of dissolved O₂ saturation in surface waters and climatological estimates of the air-sea gas exchange velocity (Keeling et al. 1997; Najjar and Keeling 1997). In the Southern Ocean, where the O₂ climatology suffers from sparseness of observations, the resolution is effec-

tively limited to seasonal time scales and zonal averages over broad ($\sim 10^\circ$) latitude bands. Importantly, however, the possibility exists of improving the O_2 flux climatology based on more-recent surface-dissolved O_2 measurements and by using the air-sea heat flux to extrapolate into data-poor regions. Using heat fluxes for extrapolation may be advantageous because the heat fluxes are available in various forms with much higher spatial and temporal resolution than the near-surface dissolved O_2 data.

The biological component of the O_2 flux is closely linked to the net community production of organic carbon in the upper ocean (Keeling and Shertz 1992; Keeling et al. 1993; Bender et al. 1996). We plan to use the air-sea O_2 flux maps to derive estimates of community production in the mixed layer by combining the O_2 flux data with additional data on the seasonal variations of O_2 in and below the mixed layer and with rates of vertical transport. We expect to carry out this analysis with monthly time resolution and with spatial resolution corresponding to zonally averaged bands with 5° -to- 10° resolution. Following this analysis, and taking advantage of ongoing programs to document changes in atmospheric O_2 concentration, radiative forcing, SST, and air-sea heat flux, we will expand this analysis to examine patterns of interannual variability of productivity, carbon, and oxygen fluxes. The annual and interannual production and flux fields which we derive will also facilitate collaborative studies of the relationship between these quantities and satellite observations of ocean color.

An additional application of our approach is testing for consistency between surface O_2 maps and surface maps of CO_2 partial pressure (Takahashi et al. 1997). It was shown in Keeling et al. (1993) that if there exists locally a tight relationship between seasonal variations in oxygen flux and heat flux, then there must also exist a tight relationship between SST and surface-dissolved inorganic carbon (which is closely related to CO_2 pressure). We plan to explore whether these relationships actually hold in the real world using our O_2 flux maps and the surface inorganic carbon data sets (e.g., Takahashi et al. 1997) as the basis for comparison. If the approach works well enough, we can use the O_2 flux maps to provide improved estimates of seasonal carbon variations in the ocean and also to provide improved estimates of the net seasonal air-sea CO_2 flux.

Use of Satellite Data

We require surface wind and net air-sea heat-flux fields, derived in part from satellite observations, to estimate surface oxygen flux. More generally, our goal is to develop data products that will facilitate collaborative studies of ocean productivity based on ocean color.

Current Activities

As a preliminary study of O_2 /carbon linkages, we are re-examining the framework Keeling et al. (1993) for estimating seasonal O_2 fluxes using estimates of variations of dissolved inorganic carbon in the water and heat flux. We are exploring whether using the enlarged carbon data sets from Takahashi et al. (1997), lead to more-successful predictions of the variations in atmospheric O_2 using this framework. This will provide a very broad-scale check of the level of consistency between ocean carbon and atmospheric oxygen data sets. We are also gathering together relevant global and southern hemisphere data sets to begin exploratory studies of possible relationships between seasonal O_2 flux and seasonal net air-sea heat flux. These will then be used to derive improved estimates of surface water O_2 variations and air-sea O_2 flux in data-sparse regions. These in turn will be used to provide estimates for net community production. This project is still in its beginning phases.

References

- Bender M., J.T. Ellis, P.P. Tans, R.J. Francey, and D. Lowe, 1996: Variability in the O_2/N_2 ratio of southern hemisphere air, 1991-1994: implications for the carbon cycle. *Global Biogeochem. Cycles*, **10**, 9-21.
- Broecker, W.S., 1991: The great ocean conveyor. *Oceanography*, **4**, 79-89.
- Feldman, G., N. Kuring, et al., 1989: Ocean Color: Availability of the global data set. *EOS*, **70**, 634-645.
- Keeling, R.F., and S.R. Shertz, 1992: Seasonal and interannual variations in atmospheric oxygen and implications for the global carbon cycle. *Nature*, **358**, 723-727.
- Keeling, R.F., R.G. Najjar, M.L. Bender, and P.P. Tans, 1993: What atmospheric oxygen measurements can tell us about the global carbon cycle. *Global Biogeochem. Cycles*, **7**, 37-67.
- Keeling, R.F., S.C. Piper, and M. Heimann, 1996: Global and hemispheric CO_2 sinks deduced from changes in atmospheric O_2 concentration. *Nature*, **381**, 218-221.
- Keeling, R.F., B.B. Stephens, R.G. Najjar, S.C. Doncy, D. Archer, and M. Heimann, 1998: Seasonal variations in the atmospheric O_2/N_2 ratio in relation to the kinetics of air-sea exchange of O_2 . *Global Biogeochem. Cycles*, **12**, 141-163.
- Najjar, R.G., and R.F. Keeling, 1997: Analysis of the mean annual cycle of the dissolved oxygen anomaly in the world ocean. *J. Mar. Res.*, **55**, 117-151.

Sarmiento, J.L., and R.A. Armstrong, 1997: U.S. JGOFS Implementation Plan for Synthesis and Modeling, The Role of Oceanic Processes in the Global Carbon Cycle, U.S. JGOFS Planning Office, Woods Hole.

Sarmiento, J.L., and J.B. Toggweiler, 1984: A new model for the role of the oceans in determining atmospheric PCO_2 . *Nature*, **308**, 621-624.

Siegenthaler, U., and T. Wenk, 1984: Rapid atmospheric CO_2 variations and ocean circulation. *Nature*, **308**, 624-626.

Takahashi, T., R.A. Feely, R. Weiss, et al. 1997: Global air-sea flux of CO_2 : an estimate based on measurements of sea-air pCO_2 difference. *Proc. Nat. Acad. Sci.*

The Hydrologic Cycle and Climatic Processes in Arid and Semi-Arid Lands

Principal Investigator – **Yann Kerr**
 Lead U.S. Investigator – **Soroosh Sorooshian**
 International Co-Sponsor – **France**

Science Background

Remotely sensed and other kinds of EOS data will allow scientists to monitor the changes in hydrologic fluxes brought about by a variety of forcings. The integration of such data with robust hydrologic models will make possible a better understanding of the processes that control changes in hydrologic storages and fluxes. This knowledge will allow scientists to better assess the role of the hydrologic cycle in a global context and to predict the effects of natural or human-induced climate change. Such information is particularly critical in the southwestern U.S. and Mexico, and in Sahelian Africa, where the quality of life and agricultural productivity are especially sensitive to changes in the hydrologic cycle and where space-based remote sensing is particularly effective.

Science Goals

The major objective of this research is to monitor and study the hydrological cycle and climatic processes in arid and semi-arid areas with the use of EOS data applied to temporally and spatially distributed models. This objective is addressed in terms of the following four major goals:

- 1) Identify the dominant hydrologic processes and understand how they change as a function of time/space scale in arid/semi-arid regions;
- 2) Develop a modeling framework that is capable of assimilating remote-sensing data to capture the interactions, at multiple spatial and temporal scales, between land-surface characteristics, meteorologic conditions, regional climate, and land-surface water and energy fluxes and state variables in arid/semi-arid regions;
- 3) Assess, through process studies and modeling exercises, the magnitudes of spatially and temporally distributed water and energy fluxes and state variables and their interactions with surface characteristics and regional climate in arid/semi-arid regions, particularly in the Lower Colorado River basin; and
- 4) Demonstrate the utility of remote-sensing-enabled models in regional/subregional water resources assessment, particularly within the Lower Colorado basin.

Our strategy is to approach similar problems from different time and space scales and at different levels of model complexity in order to find the most robust and accurate description of the hydrologic cycle across the world's vast arid/semi-arid regions.

Current Activities

Our research aims to significantly improve the human ability to both monitor (measure) and simulate (model) land-surface hydrologic processes across a range of spatial and temporal scales. These parallel themes are both critical to our success. One thrust is, therefore, to develop algorithms that efficiently and accurately convert electromagnetic signals obtained from EOS (and other) sensors into hydrologic parameters and variables. The parallel thrust is to understand and model the way in which fundamental hydrologic processes operate and how they interact with each other.

Our activities include: calibration and validation of optical, thermal, and microwave satellite data derived from simultaneous ground/satellite measurements across highly instrumented watersheds in the U.S., France, and the Sahel region of Africa; aggregation and dis-aggregation of modeled and observed variables at General Circulation Model (GCM) scales; development of a distributed land-surface model (LSM) of the hydrology and hydro-meteorology in semi-arid regions for coupling with mesoscale and GCM atmospheric circulation models; and multi-criteria methods for calibration of land-surface models. These activities are coordinated between two teams, one in France and the other in the U.S.

The French Team seeks to quantify and monitor natural and anthropogenically induced changes in hydrologically relevant surface parameters at mesoscales. Work performed to date has dealt mainly with investigating the extraction of geophysical parameters from remotely sensed data. First, sophisticated radiometric models are developed that include various perturbing factors (atmosphere, directional effects, canopy structure). After validation, these models are re-parameterized to derive more tractable and robust inversion algorithms, which are subsequently validated using ground experiments. Similarly, flux-assessment algorithms are being developed and tested together with models of the scaling factors. In order to

assess CO₂ fluxes, net primary production models are being developed. They rely on vegetation-growth models and thus couple water and energy budgets with generic vegetation models under an assimilation scheme.

The U.S. team is focused on the understanding and modeling of hydrologic processes at the sub-watershed, watershed, basin, and regional scales. Satellite data are used to derive distributed basin characteristics and the inputs to water/energy simulation models. Progress to date has included: multiple-scale studies of hydrologic variability, satellite validation, and the behavior of sparse desert canopies; development of a semi-arid distributed hydro-meteorology model which couples the SiB land-surface scheme with the Regional Atmospheric Modeling System (RAMS) in a manner which facilitates the assimilation of various types of remote-sensing data and products; development of multi-criteria sensitivity-analysis/parameter-estimation/model-evaluation methods that show potential for significantly improving the performance of LSMs; development of improved rainfall-estimation algorithms that incorporate TRMM satellite data; and development and initial testing of an improved snow model for coupling with regional climate/weather models, LSMs, and GCMs. In addition, members of our team have conducted and participated in several experiments aimed at refining soil-moisture-estimation algorithms, understanding scaling and aggregation issues, watershed characterization, vegetation response to large-scale circulation, and evaluation of soil/water-retention models.

Use of Satellite Data

The hydrological sciences and the entire investigation team look forward to well-calibrated, atmospherically-corrected and geo-referenced EOS-era satellite products to better characterize sparse canopies and soils (ASTER), seasonal vegetation and bidirectional reflectance (MODIS, MISR), radiation (CERES), and precipitation and soil moisture (AMSR-E). Equally important are non-EOS sensors operated by NOAA and ESA, particularly with regard to diurnal radiation, clouds, and active microwave measurements. We are involved at different levels in several EOS instrument teams (MODIS, AMSR-E, ASTER) as well as other instrument teams for satellite instruments (POLDER, Vegetation Monitoring Instrument (VMI) [on SPOT 4], TRMM) and for airborne instruments [Microwave Imaging Radiometer with Antenna Synthesis (MIRAS), PORTOS, ESTAR]. (PORTOS is an airborne/ground passive microwave radiometer [6 frequencies from 1.4-to-90 GHz, dual polarized]).

Participation in Field Programs

From the onset, members of our teams have played leading roles in the organization and support for a number of field experiments. The HAPEX-Sahel experiment took

place in 1991-1993, with an intensive observation period in 1992 over a GCM-size grid square. (HAPEX-Sahel is the Hydrologic Atmosphere Pilot Experiment in the Sahel.) The USDA-ARS Walnut Gulch watershed in Southeast Arizona has also been the focus of several field campaigns such as the MONSOON 90, where observations were made at a range of scales (1-10000 km²). Team members participated in several intensive-observation-period field-scale experiments over the Maricopa Agricultural Center (Arizona, USA) in 1995-96, an aircraft campaign over Landes Forest near Bordeaux (France) in 1996, and an intensive field campaign near Toulouse (France) in 1996. The field work is now primarily focused on the Upper San Pedro (Arizona, USA) in conjunction with the Semi-Arid Land Surface Atmosphere program (SALSA). Several of us have also been involved with other international initiatives related to global change such as IGBP and GEWEX.

Principal Investigator

Yann Kerr

Yann Kerr received his Ph.D. from the Université Paul Sabatier, Toulouse, France, and his M.S. from Glasgow University, U.K. From 1980 to 1985, he was with the Centre National d'Études Spatiales (CNES) in Toulouse. He joined the Laboratoire d'Études et de Recherches en Télédétection Spatiale (LERTS) when it was established in 1985. From 1987 to 1988, he took a leave of absence to work at the Jet Propulsion Laboratory in Pasadena, CA. Kerr has worked mainly with the METEOSAT, Nimbus 7 Scanning Multispectral Radiometer (SMMR), ERS-1 Wind-scatterometer, and the Advanced Very High Resolution Radiometer (AVHRR) systems in order to improve the use of thermal infrared, microwave, and visible/near-infrared data for assessing surface fluxes related to the hydrological cycle. He has been involved in several field experiments in Sahelian Africa, in the U.S., and in Europe. Kerr has served as a principal investigator on various projects and has helped organize the HAPEX-Sahel experiment.

Lead U.S. Investigator

Soroosh Sorooshian

Prof. Sorooshian's primary research is in surface hydrology, with particular emphasis on precipitation-runoff-modeling utilization of remote-sensing information in the hydrology of arid/semi-arid regions, as well as water-resources management issues. His research activities are funded primarily by NASA, NSF, and NOAA. Sorooshian is a member of several National Research Council (NRC) committees and is currently the Chair of the National Academy's Global Energy and Water cycle Experiment (GEWEX) panel. He is also serving on various advisory panels in agencies at both the national and international

levels; in particular he is a member of the science advisory board of NOAA and incoming chair of GEWEX-SSG. He has been an active member of several professional societies and has served in various capacities (former Head of the Department of Hydrology and Water Resources, University of Arizona; former Editor of Water Resources Research, published by the American Geophysical Union; former member of the Council of the American Meteorological Society; etc.) He is currently the special editor for hydrology of the Bulletin of the American Meteorological Society (BAMS), and is the President of the Hydrology Section of AGU. Sorooshian is a Fellow of AAAS, AGU, AMS, and formerly of the Udall Center for Public Policy during 1993-94.

Co-Investigators

Agnes Bégué - *Centre de Coopération Internationale en Recherche Agronomique pour le développement*

Abdelghani Chehbouni - *Institut Français de Recherche Scientifique pour le Développement en Coopération*

Gérard Dedieu - *Centre National d'Etudes Spatiales (CESBIO)*

Xiaogang Gao - *University of Arizona/Hydrology and Water Resources*

David Goodrich - *USDA/Agricultural Research Service*

Hoshin Gupta - *University of Arizona/Hydrology and Water Resources*

Bisher Imam - *University of Arizona/Hydrology and Water Resources*

Jacques Imbernon - *Centre de Coopération Internationale en Recherche Agronomique pour le développement*

Jean-Pierre Lagouarde - *Institut National de Recherche Agronomique*

M. Susan Moran - *USDA/Agricultural Research Service*

Bernard Seguin - *Institut National de Recherche Agronomique*

James Shuttleworth - *University of Arizona/Hydrology and Water Resources*

James Smith - *Princeton University*

Alain Vidal - *International Programme on Technology and Research in Irrigation and Drainage (IPTRID) FAO/AGLW*

Jean-Pierre Wigneron - *Institut National de Recherche Agronomique*

References

Chehbouni, A., E. Njoku, J.-P. Lhomme, and Y. Kerr, 1995: Approaches for averaging surface parameters and fluxes over heterogeneous terrain. *J. Climate*, **8**, 1386-1393.

Gao, X., and S. Sorooshian, 1994: A stochastic precipitation disaggregation scheme for GCM applications. *J. Climate*, **7**, 238-247.

Gupta, H.V., L.A. Bastidas, S. Sorooshian, W.J. Shuttleworth, and Z.L. Yang. 1999: Parameter estimation of a land surface scheme using multi-criteria methods. *J. Geophys. Res.*, in press.

Kustas, W.P., and D.C. Goodrich, 1994: Preface: special section on Monsoon '90 Multidisciplinary Experiment. *Water Resources Res.*, **30**, 1211-1225.

Sano, E.E., M.S. Moran, A.R. Huete, and T.R. Miura, 1998: C- and Multi-angle Ku band synthetic aperture radar data for bare soil moisture estimation in agricultural areas. *Rem. Sens. Environ.*, **64**, 77-90.

Xu, L., X. Gao, S. Sorooshian, P.A. Arkin, and B. Imam, 1999: A microwave infrared threshold technology technique to improve the GOES precipitation index. *J. Appl. Meteor.*, in press.

Investigation URLs

http://www.hwr.arizona.edu/uaid_home.html

http://www.hwr.arizona.edu/cgi-bin/uadata_browse

<http://www.orstom.fr/hapex/>

http://www.tucson.ars.ag.gov/salsa/salsa_home.html

<http://www-sv.cict.fr/cesbio>

Climate and Chemical Cycles: The Role of Sulfate and Ozone in Climate Change

Principal Investigator — Jeffrey T. Kiehl

Science Background

Human activities have led to dramatic changes in the chemical composition of Earth's atmosphere over the past century. Projections for changes into the 21st century indicate the potential for continued changes. Previous studies of the potential climate impacts of these changes in the chemical composition of the atmosphere have used climate models with specified changes in composition. Also, much of climate-change research has solely focused on increases in carbon dioxide, methane, nitrous oxide, and chlorofluorocarbons. Important changes have also occurred in sulfate aerosols and atmospheric ozone over the past. Changes in climate and changes in chemical composition are not uncoupled from one another. Chemical processes depend on climate processes such as convective transport, the hydrologic cycle, and radiation. Thus, to comprehensively study climate and chemistry problems requires the use of both climate and chemical transport models. The most complete treatment requires the full coupling of chemistry and climate models. It is now recognized that changes in sulfate aerosols and ozone can potentially contribute to significant climate change. Sulfate aerosols can reflect solar radiation back to space both directly and through the modification of cloud albedo, the so-called indirect effect. This implies a negative forcing to the climate system. Increases in tropospheric ozone leads to increased radiative forcing of the climate system, while decreases in stratospheric ozone lead to a reduction in radiative forcing. Changes in sulfate aerosols and ozone lead to significant changes in the regional patterns of net forcing. These spatial patterns in net forcing are important to regional climate change.

Science Goal

The key goal is to quantify the roles of sulfate aerosols and ozone in the climate system. The focus is to carry out simulations with the NCAR CCM3 climate model that incorporates a sulfur chemistry model that simulates both the direct and indirect effects of sulfate aerosols on the climate system. This model will be used to simulate both the present-day effects of sulfate aerosols and the predicted change in climate over the past 120 years due to changes in the amount of aerosols due to anthropogenic

activity. Climate-change simulations will also be carried out for future scenarios. Two chemical transport models IMAGES and the Model for Ozone And Related chemical Tracers (MOZART) will be used in conjunction with the NCAR CCM3 climate model to study the climate effects of changes in ozone, both tropospheric and stratospheric over the past 120 years and potential future changes. The accuracy of present-day simulations of aerosols and ozone will be evaluated through the use of satellite data. These studies will lead to the coupling of the climate and chemistry model to study the non-linear interactions between chemistry and climate.

Current Activities

Studies have been carried out on the radiative forcing due to tropospheric sulfate aerosols, tropospheric ozone, and stratospheric ozone. The tropospheric sulfate distributions were obtained from the latest version of the NCAR CCM3 that includes a prognostic cloud-water scheme and a sulfur-chemistry model. The model prognoses SO_2 , DMS, and SO_4 , where the mass of sulfate is predicted. The oxidant distributions, NO_3 , O_3 , OH, and a diagnosed H_2O_2 are obtained from the chemical transport model, IMAGES. Simulations have been carried out with pre-industrial emissions and present-day emissions of sulfur; the global annual mean direct forcing is -0.56 Wm^{-2} . Simulations have been carried out on the indirect effect of aerosols on clouds. The range in the global annual mean indirect effect is -0.7 to -1.8 Wm^{-2} , where the uncertainty is due to uncertainties in linking aerosol mass to cloud-drop number concentration. AVHRR and SSM/I satellite data are being used to understand the causes for these uncertainties in model-predicted cloud-drop size.

Parallel to the sulfate studies, a wide range of simulations with IMAGES and MOZART has been carried out on tropospheric ozone for present, past, and future time periods. For present-day conditions the model-predicted ozone has been compared with satellite observations. Radiative-forcing calculations have been carried out for these cases. For the pre-industrial-to-present changes in tropospheric ozone, a radiative forcing of 0.48 Wm^{-2} is obtained. This forcing will be less when reductions in stratospheric ozone are included.

Use of Satellite Data

For the pre-launch time period, a variety of satellite data is being used to evaluate the model-simulated distributions of sulfate aerosols and ozone. For cloud and aerosols, SSM/I, AVHRR, SAGE, and ERBE data are employed. Currently, the visible aerosol optical depth from the model is compared to the AVHRR product. Model-predicted cloud-drop sizes are compared against the AVHRR-retrieved data from the Han et al. study. For ozone, SAGE and TOMS products are used to evaluate the model-simulated total-ozone abundance for both the total column, and the troposphere and the stratosphere, separately.

For the post-launch time period, MODIS and MISR products will be used to evaluate aerosol optical depth. MODIS will also be used to evaluate model-predicted cloud-drop size, which should reveal aerosol indirect effects. CERES data will be used to compare the top-of-atmosphere Earth radiation budget to model simulations. For the chemical transport model, MOPITT data will be used to evaluate the simulated CO and CH₄ fields.

Participation in Field Programs

The investigators are involved in a number of field programs that are linked to the goals of this project. The PI is a member of the steering committee of the Indian Ocean Experiment (INDOEX), which is focused on satellite and in situ measurements of the direct and indirect effects of sulfate aerosols, and also the measurements of ozone.

Principal Investigator

Jeffrey T. Kiehl

Jeffrey Kiehl received his Ph.D. in Atmospheric Science from the State University of New York at Albany in 1981. He is currently the head of the Climate Modeling Section at the National Center for Atmospheric Research. His main research interests are in climate modeling, cloud-radiation interactions, and climate effects of aerosols. His current research is on the climate effects of aerosols and the interaction between chemistry and climate. As co-chair of the Climate System Model working group on Chemistry and Climate Change, he has worked toward providing new estimates of climate-forcing factors for the past 120 years. These factors are being used in the National Assessment of Climate. He has also worked on radiative-dynamical interactions in the stratosphere. His research employs models, satellite, and in situ observations. He is the co-director of the Center for Clouds, Chemistry and Climate, and a past member of the Climate Research Committee.

Co-Investigators

Guy Brasseur - *National Center for Atmospheric Research*

D. Hauglustaine - *National Center for Atmospheric Research*

C. Granier - *NOAA Aeronomy Laboratory*

B.A. Ridley - *National Center for Atmospheric Research*

References

Brasseur, G.P., D. A. Hauglustaine, S. Walters, P. J. Rasch, J.F. Muller, C. Granier, and X.X. Tie: MOZART: a global chemical transport model for ozone and related chemical tracers, part 1, model description. *J. Geophys. Res.*, submitted.

Brasseur, G.P., J.T. Kiehl, J.F. Muller, T. Schneider, C. Granier, X.X. Tie, and D.A. Hauglustaine, 1998: Past and future changes in global tropospheric ozone: impact on the radiative forcing. *Geophys. Res. Lett.*, **25**, 3807-3810.

Han, Q., W.B. Rossow, and A.A. Lacis, 1994: Near-global survey of effective droplet radii in liquid water clouds using ISCCP data. *J. Climate*, **7**, 465-497.

Hauglustaine, D. A., G.P. Brasseur, S. Walters, P. J. Rasch, J.F. Muller, L.K. Emmons, and M.A. Carroll: MOZART: a global chemical transport model for ozone and related chemical tracers, part 2, model results and evaluation. *J. Geophys. Res.*, submitted.

Kiehl, J.T., T.L. Schneider, P.J. Rasch, M.A. Barth, and J. Wong: Radiative forcing due to sulfate aerosols from simulations with the NCAR community climate model (CCM3). *J. Geophys. Res.*, submitted.

Kiehl, J.T., T.L. Schneider, R. Portmann, and S. Solomon: Climate forcing due to tropospheric and stratospheric ozone. *J. Geophys. Res.*, submitted.

Investigation URL

<http://www.cgd.ucar.edu/cms/eos/>

Urban Metabolism and Trace Gas Respiration

Principal Investigator – **Charles E. Kolb**

Science Background

Cities and their associated industrial areas are dynamic entities which consume and metabolize fuels, foodstuffs, and industrial and commercial chemicals in the course of daily urban activities. This consumption of organic and inorganic materials leads directly to respiration of a wide range of trace gases from urban areas. Many of these respiration products play a major role in urban and regional air pollution, while the longer lived gases can be a significant input to global atmospheric chemical budgets.

Analyses of the trace-gas levels found in urban atmospheres demonstrate that cities are major sources of greenhouse gases such as carbon dioxide (CO_2), nitrous oxide (N_2O), methane (CH_4), and halocarbons (e.g., CFCI_3 , CF_2CI_2 , CH_3CCl_3). The latter also lead to stratospheric ozone destruction. Our previous work has quantified significant CH_4 emission fluxes from urban features such as natural-gas distribution systems, municipal-wastewater treatment plants, and waste-disposal landfills. Of course, fossil-fuel-combustion-exhaust sources associated with industrial boilers, commercial and industrial space heating, and transportation systems have long been identified as major sources of carbon dioxide emissions. In addition, combustion sources, most particularly fluidized-bed coal combustors and automobiles equipped with modern catalytic converters, are sources of nitrous oxide (N_2O). Since each of these directly forcing greenhouse trace gases has a disproportionate impact upon the Earth's radiation budget, urban respiration products are an important aspect of potential global warming.

In addition to the emission of long-lived greenhouse and ozone-depletion source gases, urban/industrialized areas are also major sources of precursor species for tropospheric aerosols, including: condensation nuclei (CN), sulfur dioxide (SO_2) and volatile organic compounds (VOCs); and the key precursor gases for tropospheric ozone and associated oxidants, including: nitrogen oxides (NO , NO_2), carbon monoxide (CO), and VOCs.

New and efficient methods are needed to characterize trace-gas emission fluxes from urban and industrialized areas, to connect these fluxes to quantitative measures of the urban and industrial activities which create them, and to develop urban/industrial activity parameters accessible to characterization and quantification by re-

mote sensing which can predict trace-species emissions and represent the factors which control them.

Science Goals

This project addresses the development and utilization of better in situ experimental measurement techniques based on sensitive, accurate, real-time, trace-gas and particulate sensors deployed on mobile platforms, coupled with innovative models of urban/regional atmospheric chemistry and transport. Together, these experimental and modeling methods will be used to design better measurement strategies and to analyze trace-gas concentration and flux data. This project also involves the use of urban/industrial geographic information systems and databases to correlate observed trace-gas-emission fluxes (urban respiration) with urban and industrial activity and consumption factors (urban metabolism). Finally, where possible, statistically meaningful correlations between measured trace-gas emissions and urban/industrial activity/consumption factors will be used to identify parameters accessible to air- and satellite-borne remote-sensing systems in order to enable automated estimates of urban and industrial trace-gas emissions relevant to global change and regional pollution issues.

Current Activities

Initial project activities are focused on developing and deploying the tools required to perform the required field measurements and concomitant data analysis and interpretation activities. These include: a series of sensitive, specific, real-time (~1-second response) sensors for greenhouse, aerosol precursor, and ozone-precursor trace gases and fine particulates; a global positioning system (GPS)-equipped step-van mobile laboratory for trace gas/fine-particulate-concentration mapping and flux measurements; a tethered balloon-borne sampling system for performing vertical trace-gas profile measurements; a calibrated SF_6 tracer gas release and monitoring system for urban plume flux measurements; a set of urban air quality and transport models designed to aid in field-measurement design and inversion of concentration maps and plume flux data to quantify urban-area trace-gas and par-

ticulate-emission flux distributions; and a geographical information system (GIS) urban-activity-factor database for our test urban areas (Manchester, NH and Boston, MA).

The proposed measurement methods are based upon techniques we previously developed to measure methane emissions from natural-gas distribution systems in urban areas. These techniques are being extended to map the concentration of a set of gases plus fine particulates and to measure emission rates of these gases from urban areas. The main experimental advance involves the use of tunable infrared laser differential-absorption spectrometer (TILDAS) trace-gas monitors installed in a mobile laboratory to survey urban emissions. Because the instruments can be tuned for specific gases, a range of different species can be measured simultaneously in real-time. Use of GPS receivers, GIS databases, and computer algorithms allows the automated conversion of real-time TILDAS measurements into concentration maps for selected pollutants. Continuous high-accuracy trace-gas measurements can be coupled with area atmospheric tracer releases to provide a basis for estimating area emission rates. The area-flux determination is accomplished through the use of a real-time tracer analyzer also installed in the TILDAS survey vehicle. Further information needed to characterize the mix of urban emissions can be obtained from canister samples collected along survey traverses and from tethered-balloon vertical profiles. These latter samples can be analyzed with the TILDAS instruments as well as with gas-chromatography methods which can identify hundreds of true VOC species.

Participation in Field Programs

Initial field measurements were planned for late 1997/early 1998. They will extend through calendar 1998 and 1999 to allow determination of seasonal variations in urban trace-gas and fine-particulate emission patterns. Current plans are to use Manchester, NH (population 100,000) as an initial testbed to hone measurement and analysis tools and then to study the metropolitan Boston area (population 2,870,000) as an ongoing field laboratory to assess seasonal emissions variations. We may extend measurements to other U.S. cities chosen as major field sites by the North American Regional Strategy for Tropospheric Ozone (NARSTO) program, if schedule and funding considerations allow.

Use of Satellite Data

Satellite data from Landsat and other surface-imaging satellite systems will be used, as appropriate, to help prepare GIS urban activity maps of the test urban areas. These maps will be compared with measured trace-gas/fine-particulate emissions maps obtained from the project's field

data to investigate correlations between pollutant-emission patterns and urban activity maps. The goal of this part of the investigation is to identify surrogate urban-area remote-sensing observables which track and predict urban-pollution emission levels.

Principal Investigator **Charles E. Kolb**

Charles Kolb has been involved in atmospheric chemistry and physics studies for over 25 years. He received his undergraduate degree in chemical physics from the Massachusetts Institute of Technology (1967) and masters (1968) and doctoral (1971) degrees in physical chemistry from Princeton University. He joined Aerodyne Research, Inc. in 1971 and founded its Center for Chemical and Environmental Physics in 1977. He has served as the company's president and chief executive officer since 1985. His research interests include the homogeneous and heterogeneous chemical kinetics of atmospheric and industrial processes and the development and utilization of advanced trace-gas and aerosol measurement techniques. He has served on a wide range of NASA and National Research Council panels, boards, and committees dealing with environmental issues; he received the 1997 Award for Creative Advances in Environmental Science and Technology from the American Chemical Society. He is currently Atmospheric Sciences Editor for *Geophysics Research Letters*.

Co-Investigators

Joseph Ferreira, Jr. - *Massachusetts Institute of Technology*

Brian K. Lamb - *Washington State University*

Gregory J. McRae - *Massachusetts Institute of Technology*

Robert W. Talbot - *University of New Hampshire*

References

Blake, D.R., V.H. Woo, S.C. Tyler, and F.S. Rowland, 1984: Methane concentrations and source strengths in urban locations. *Geophys. Res. Lett.*, **11**, 1211-1214.

Blaha, D., B. Mosher, R.C. Harriss, C.E. Kolb, J.B. McManus, J.H. Shorter, and B. Lamb, 1994: Mapping urban sources of methane. *Geo. Info. Systems*, (October), 34-38.

Czepiel, P.M., P.M. Crill, and R.C. Harriss, 1993: Methane emissions from municipal wastewater treatment processes. *Environ. Sci. Technol.*, **27**, 2472-2477.

Czepiel, P.M., B. Mosher, J.H. Shorter, J.B. McManus, C.E. Kolb, E. Allwine, B.K. Lamb, and R.C. Harriss, 1995: Landfill methane emissions by static enclosures and atmospheric tracer methods. *J. Geophys. Res.*, **101**, 16,711-16,719.

Kolb, C.E., J.C. Wormhoudt, and M.S. Zahniser, 1995: Recent Advances in Spectroscopic Instrumentation for Measuring Stable Gases in the Natural Environment. *Methods in Ecology: Trace Gases*, P.A. Matson and R.C. Harriss, Eds. 259-290.

Lamb, B.K., J.B. McManus, J.H. Shorter, C.E. Kolb, B. Mosher, R.C. Harriss, E. Allwine, D. Blaha, T. Howard, A. Guenther, R.A. Lott, R. Siverson, H. Westberg, and P. Zimmerman, 1995: Development of atmospheric tracer methods to measure methane emissions from natural gas facilities and urban areas. *Environ. Sci. Technol.*, **29**, 1468-1479.

Milford, J.B., A.G. Russell, and G.J. McRae, 1989: A new approach to photochemical pollution control: Implications

of spatial patterns in pollutant responses to reductions in nitrogen oxides and reactive organic gas emissions. *Environ. Sci. Technol.*, **23**, 1290-1301.

Mulholland, M., and J.H. Seinfeld, 1995: Inverse air pollution modelling of urban-scale carbon monoxide emissions. *Atmos. Environ.*, **26A**, 113-123.

NRC, 1991: Rethinking the Ozone Problem in Urban and Regional Air Pollution. National Research Council, National Academy Press, Washington, DC.

Rowland, F.S., N.R.P. Harris, and D.R. Blake, 1990: Methane in cities. *Nature*, **347**, 432-433.

Zahniser, M.S., D.D. Nelson, J.B. McManus, and P.L. Keabian, 1995: Measurement of trace gas fluxes using tunable diode laser spectroscopy. *Phil. Trans. Royal Soc.*, **A351**, 371-382.

Investigation URLs

<http://www.aerodyne.com>

<http://ortho.mit.edu/nasa>

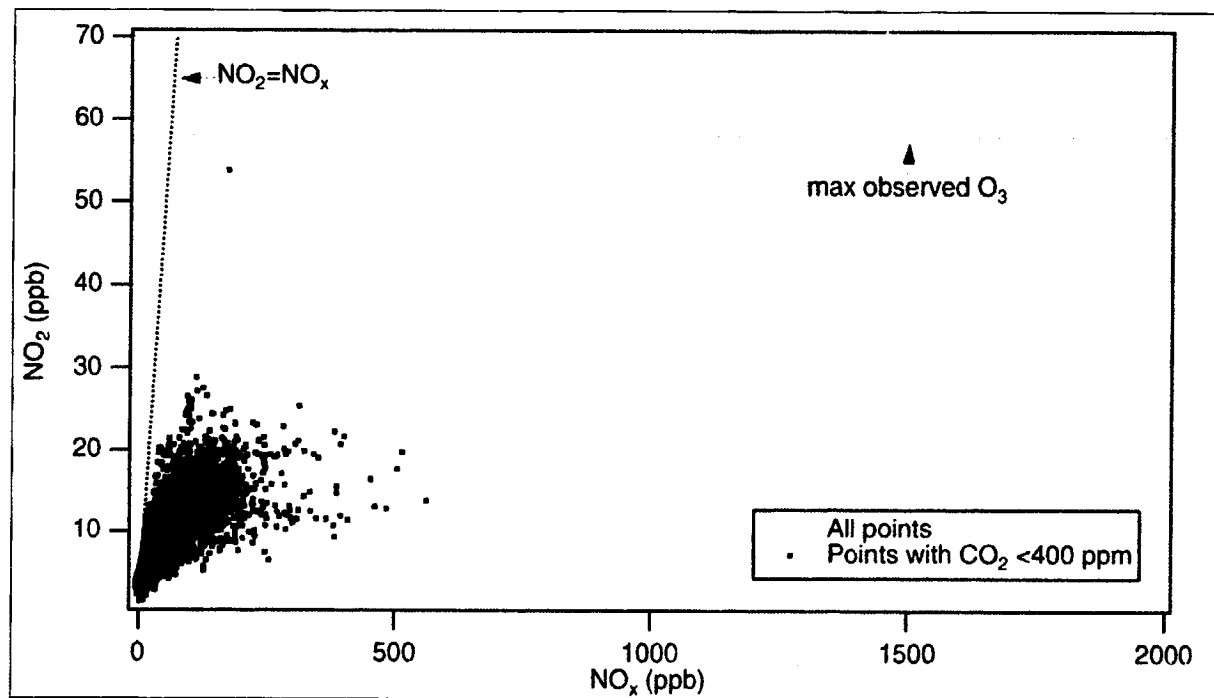

Relationship of NO_2 to NO_x in an urban area. Data collected with a mobile TDL spectrometer on city and highway roads of Manchester, NH, 2:30-9 pm EDT on 26 August 1998. The darker points are those with corresponding $\text{CO}_2 < 400$ ppm and thus are not a result of directly sampling a combustion source such as vehicle exhaust.

The Land Surface Component of the Climate System: (i) Improved Representation of Subgrid Processes and (ii) Analysis of Land Surface Effects on Climate Variability

Principal Investigator – **Randal D. Koster**

Science Background

Droughts, floods, and other manifestations of a region's hydroclimatology can have tremendous social and economic impacts. Coupled models of the land-atmosphere system allow an understanding of hydroclimatological variability that transcends what can be learned from a strictly observational analysis. Assuming that the coupled system includes realistic feedbacks between the land surface and the overlying atmosphere (an assumption that must be constantly critiqued and tested against observations whenever possible), the system can be artificially manipulated to isolate and characterize the fundamental physical controls on the variability.

The land-surface models (LSMs) used in such coupled systems are typically one-dimensional representations of land-surface processes that include such features as a vegetation canopy for explicitly controlling transpiration and multiple soil layers for moisture storage. The formulations are quite complex in some LSMs, and several perform well against point measurements. What most LSMs lack, however, is a proper treatment of the extensive subgrid variability known to exist over the large length scales resolved by typical coupled systems. Many LSMs, for example, include thin soil-moisture layers that are assumed homogeneously wet across hundreds of kilometers. Given the nonlinear response of evaporation to soil moisture, vegetation type, surface aspect, and other spatially varying properties, an improper treatment of subgrid variability may overwhelm any improvements that can be made in the one-dimensional physics. This suggests a sensible path for LSM development.

Science Goal

The goal of this project is to improve our understanding of land-atmosphere feedbacks and their influence on hydroclimatic variability through model development and application. The specific objectives are twofold: 1) to produce a land-surface model that explicitly models subgrid soil-moisture variability and its effects on evaporation and runoff, and 2) to perform simulation experiments with an

LSM coupled to a general circulation model that characterize land-atmosphere interaction and isolate the mechanisms underlying regional precipitation statistics.

Current Activities

Model development: In a break from traditional modeling strategies, the continental surface is separated into a mosaic of hydrological catchments with boundaries that are not constrained by the grid of the overlying atmospheric model. A land-atmosphere-communication algorithm handles the existence of numerous catchments within a single GCM grid cell and the straddling of some catchments across grid cells.

Within each catchment, the land-surface model being developed for this project solves the relevant energy and water-balance equations at every simulation time step. This model is partly based on existing catchment hydrological models that use topographical indices to treat subgrid soil-moisture variation explicitly. The treatment also includes, however, a root-zone-moisture variable to allow for soil-wetting fronts following storms and to avoid some of the limitations of the topographic-index approach in regions of little-to-moderate orography. We avoid a distributed modeling approach within each catchment by deriving preprocessed relationships that relate average catchment soil-moisture content to the aspects of spatial variability relevant to the surface energy and water budget. Global topographic data are being analyzed to derive the parameters needed for the preprocessed functions.

Model application: Coupled-model simulations are being designed that address various issues related to land-atmosphere feedback; some are logical and important extensions of previous work. One set of multi-decade simulations illustrates the role of SST variability in controlling the timing of continental precipitation anomalies and the concurrent role of land-surface processes in amplifying the anomalies. Another focuses on the predictability of precipitation when all surface boundary conditions—over both land and ocean—are known. The large-scale structures of evaporation and soil-moisture fields are be-

ing examined, as is the effect of improving the land-surface fluxes in a data-assimilation system.

Use of Satellite Data

The Mosaic LSM is currently being incorporated into the data assimilation system of NASA/GSFC's Data Assimilation Office. By increasing the realism of the LSM through sensible model development, we should eventually be able to increase the realism of the atmospheric model output and thereby increase the value of the assimilated satellite inputs. The sensitivity of the assimilation model fields to land-surface fluxes will, in any case, be quantified as part of this project.

The Mosaic LSM (and, eventually, the catchment model) is also a part of NASA's Seasonal-to-Interannual Prediction Project (NSIPP), a modeling and data assimilation project aimed at translating satellite ocean data (e.g., altimetry) and land data (e.g., soil moisture) into long-term predictions. An improved LSM and an improved understanding of land-atmosphere interactions should, in principle, lead to improved predictions and thus should add value to the original satellite data.

Participation in Field Programs

Field measurements of surface-energy and water-balance fluxes lie at the heart of the LSM validation exercises performed as part of the international Project for the Intercomparison of Land-surface Parameterization Schemes (PILPS) and Global Soil Wetness Project (GSWP) model-intercomparison projects. Through extensive participation in these projects, the investigators are learning much about LSM behavior and overall modeling strategy.

Principal Investigator

Randal Koster

Randal Koster joined the Hydrological Sciences Branch at the NASA/Goddard Space Flight Center upon receiving an Sc.D. from the Massachusetts Institute of Technology in 1988. His research has focused on the development of land-surface schemes for climate models, the behavior of the coupled land-atmosphere system, and the global geochemistry of stable water isotopes.

Co-Investigators

Praveen Kumar - *Department of Civil Engineering, University of Illinois (Urbana-Champaign)*

Max Suarez - *Climate and Radiation Branch, NASA/Goddard Space Flight Center*

References

Ducharne, A., R.D. Koster, M.J. Suarez, P. Kumar, and M. Stieglitz, 1999: A catchment-based land surface model for GCMs and the framework for its evaluation. *Physics and Chemistry of the Earth*, in press.

Koster, R.D., and M.J. Suarez, 1999: A simple framework for examining the interannual variability of land surface moisture fluxes. *J. Climate*, in press.

Koster, R.D., M.J. Suarez, and M. Heiser: Variance and predictability of precipitation at seasonal-to-interannual timescales. *J. Hydrometeorology*, submitted.

Koster, R.D., T. Oki, and M.J. Suarez, 1999: Assessing success in the offline validation of land surface models. *J. Meteor. Soc. Japan*, in press.

Koster, R.D., and P.C.D. Milly, 1997: The interplay between transpiration and runoff formulations in land surface schemes used with atmospheric models. *J. Climate*, **10**, 1578-1591.

Koster, R.D., and M.J. Suarez, 1996: The influence of land surface moisture retention on precipitation statistics. *J. Climate*, **9**, 2551-2567.

Koster, R.D., and M. Suarez, 1996: Energy and Water Balance Calculations in the Mosaic LSM. NASA Tech. Memo. 104606, Vol. 9.

Koster, R.D., and M.J. Suarez, 1995: The relative contributions of land and ocean processes to precipitation variability. *J. Geophys. Res.*, **100**, 13,775-13,790.

Regional Land-Atmosphere Climate Simulation System (RELACS) for the Asian Monsoon Region

Principal Investigator – **William K. M Lau**

Science Background

The Asian monsoon region is the home for over 60% of the world population. More than half of the population of the Asian monsoon countries reside within the Southeast Asian monsoon region. Agricultural productivity and socio-economic development in Southeast Asia are highly dependent on the vagaries of the monsoon climate, often associated with disastrous floods and droughts occurring from year to year. Recently urban growth and deforestation have further compounded the problems already caused by natural variability of the monsoon climate.

Because of its unique geographical location, the regional hydrologic cycle of Southeast Asia is very complex, being affected by basin-scale moisture transports associated with the El Niño, as well as moisture recycling processes within the land-ocean-atmosphere of the Asian monsoon region. During an average year, from April through the beginning of May, deep convection migrates northward along the "land bridge" of the maritime continent from Indonesia, the Malay Peninsula to southern Thailand. During the early part of the monsoon season (around middle of May), heavy monsoon rain abruptly shifts from the land region of Indochina to the South China Sea, signaling the first stage of the onset of the Asian summer monsoon. Subsequently, the monsoon convection vacillates between the land region of East Asia and the South China Sea and tropical western Pacific region. In a given year, the above scenario may fail to develop or develop with different timing, resulting in delayed or early onset of the monsoon, at times accompanied by severe floods or droughts conditions. The physical underpinnings of the abrupt transitions and interannual variability of the Southeast Asian monsoon precipitation regimes are unknown and are of great importance in better understanding the mechanism of the regional hydrologic cycle in the Southeast Asian monsoon region.

On the regional scale, the natural climate variability associated with atmosphere-land-surface interactions is much larger than that compared to global or continental scales. As a result the signal-to-noise ratio is very low, making regional climate signals very difficult to detect.

To assess the influence of global climate signals on regional scales, it is necessary to downscale the global

signals and translate them into regional and local forcing functions for regional climate variability. This is one of the most challenging problems of climate-change research. This project will be initially focused on developing downscaling techniques in the southeast Asian monsoon region. The methodology developed, with proper modification, will be applicable to different climate regimes.

Science Goals

Our goals are:

- 1) to provide a better understanding of the physical processes involved in regional atmospheric-land-surface interactions and their linkages to other components of the climate system;
- 2) to enable experimental predictions and studies of regional climate variability due to natural variability, land use, and global change with application to the southeast Asia region; and
- 3) to provide special land-surface data sets and assimilation products for validation of land-atmosphere models and satellite algorithms.

Key scientific tasks are:

- 1) To acquire the temporal and spatial distribution of precipitation, evaporation, moisture storage, and runoff in southeast Asia before and during the monsoon rainy seasons;
- 2) to understand the roles of land-surface-atmosphere feedbacks vs. large-scale remote forcing, in particular, sea-surface temperature, in giving rise to the observed characteristics of land-locked vs. oceanic precipitation in the southeast Asian monsoon region; and
- 3) to assess the response of regional precipitation and streamflows in major river basins in Southeast Asia to natural climate fluctuations and to land-use changes and different global-change scenarios.

Current Activities

The current research is focused on the downscaling of climate forcings to regional and local scales via a multiple nesting modeling and satellite-retrieval approach. The research tasks are divided into three main components: development of RELACS; validation data-set development and analysis for the GEWEX Asian Monsoon Experiment-Tropics (GAME-T); and climate-downscaling experiments using RELACS. RELACS has five inter-linked modular components: a) a nested mesoscale model (MM5), b) a coupled land-surface model (LSM), c) a regional 4DDA component d) a GCM/4DDA component, and e) a macro-hydrologic model component for river-basin-scale water-resource applications (see figure on following page). Basic components of the nested regional model and the GCM component exist at GSFC. The macro-hydrologic model for GAME-T is provided by Drs. S. Herath and T. Oki from the University of Tokyo, Japan. This investigation will focus on developmental work needed to provide a robust interface linking all the existing submodels and infrastructures to develop an integrated end-to-end climate-prediction system for regional (sub-continental scale) climate applications for GEWEX.

Use of Satellite Data

One of the key attributes of this project is the building of an end-to-end regional climate-simulation capability at GSFC that can easily adopt future model improvements and incorporate new satellite data. The strongest link to the ESE satellite program is TRMM, which will provide rainfall and latent heating information for validation, assimilation, and diagnosis for all the research tasks. GMS radiation data will be used to derive surface radiation budgets over GAME-T. Other satellite data used include SSM/I, TOVS pathfinder, and AVHRR, for estimation of atmospheric moisture, precipitation, vegetation indices, and other relevant hydrologic parameters. With the launch of Terra, data from MODIS and CERES will provide additional information on clouds and land-surface characteristics for re-processing of the data sets to be developed in this investigation.

Participation in Field Programs

Investigators on this project are actively involved in the planning, execution, and data analyses of international field experiments over the southeast Asian region. GAME-T is the one of four components of GEWEX, conducting quantitative monitoring of vapor flux, precipitation, evapotranspiration, radiative flux, and their seasonal, intra-seasonal and interannual variations over the southeast Asia with intensive observations over Thailand. GAME-T's role is to observe and investigate the energy and water cycle in the warm humid areas of the Asia Monsoon

region, from tropics to sub-tropics. Another important experiment is the South China Sea Monsoon Experiment (SCSMEX), which provides enhanced radar rainfall observations over the South China Sea including a vast array of oceanic observations. SCSMEX is jointly sponsored by the WMO/M1 Committee of Atmospheric Sciences, WCRP CLIVAR Monsoon Program, and the Pacific Science Association. It involves the participation of all major countries and regions of East and Southeast Asia, as well as Australia and the U.S. Both experiments will be carried out in conjunction with TRMM.

Principal Investigator

William K.-M. Lau

William Lau received a Ph.D. in Atmospheric Sciences from the University of Washington in 1977. He was Assistant Professor at the Naval Postgraduate School until 1981. Since then he has been a Senior Research Meteorologist in the Goddard Laboratory for Atmospheres (GLA) at Goddard Space Flight Center. Currently, he is Head of the Climate and Radiation Branch of GLA. His research expertise includes empirical data analysis and modeling in climate dynamics, tropical and monsoon meteorology, and ocean-atmosphere interaction. He has published over 120 research papers in the refereed literature. He is currently the co-chair of the CLIVAR Asian-Australia Monsoon Panel, Chief Scientist for the South China Sea Monsoon Experiment (SCSMEX), and guest editor of the Special Issues of the Journal of Climate on TRMM. He served as Chairman of the American Meteorological Society (AMS) Committee on Climate Variations, member of the U.S. Science Working Group for TOGA/COARE, chief scientist of the U.S.-People's Republic of China bilateral research on monsoons, and as a science team member of TRMM. He was awarded the AMS Meisinger Award, the NASA John Lindsay Memorial Award for excellence in research, and the Mausum prize for best research paper (Mausum is a Hindi word meaning season [or monsoon]). Dr. Lau is a Senior Goddard Fellow and a fellow of the AMS.

Co-Investigators

S. Herath - *University of Tokyo, Japan*

T. Oki - *University of Tokyo, Japan*

The following are from NASA/Goddard Space Flight Center:

M.-D. Chou

W.-K. Tao

Y. Sud

P. Wetzel

References

Chou, M.-D., 1991: The derivation of cloud parameters from satellite-measured radiances for use in surface radiation calculations. *J. Atmos. Sci.*, **48**, 1549-1559.

Hewitson, B.C., and R.G. Crane, 1996: Climate downscaling: techniques and application. *Climate Research*, **7**, 85-95.

Bony, S., K.-M. Lau, and Y. Sud, 1997: Sea surface temperature and large scale circulation influences on tropical greenhouse effect and cloud radiative forcing. *J. Climate*, **10**, 2055-2077.

Lau, K.-M., J.H. Kim, and Y. Sud, 1996: Intercomparison of hydrologic processes in AMIP GCMs. *Bull. Amer. Meteor. Soc.*, **77**, 2209-2227.

Lau, K.-M., and S. Yang, 1996: The Asian monsoon and the predictability of the tropical ocean-atmosphere system. *Quart. J. Royal. Met. Soc.*, **122**, 945-957.

Lau, K.-M., and S. Yang, 1997: Climatology and interannual variability of the southeast Asian monsoon. *Adv. Atmos. Sci.*, **14**, 141-162.

Lau, K.-M., and W. Bua, 1997: Monsoon-Southern Oscillation Coupling. *Climate Dynamics*, submitted.

Investigation URL

<http://climate.gsfc.nasa.gov/~kim/relacs/>

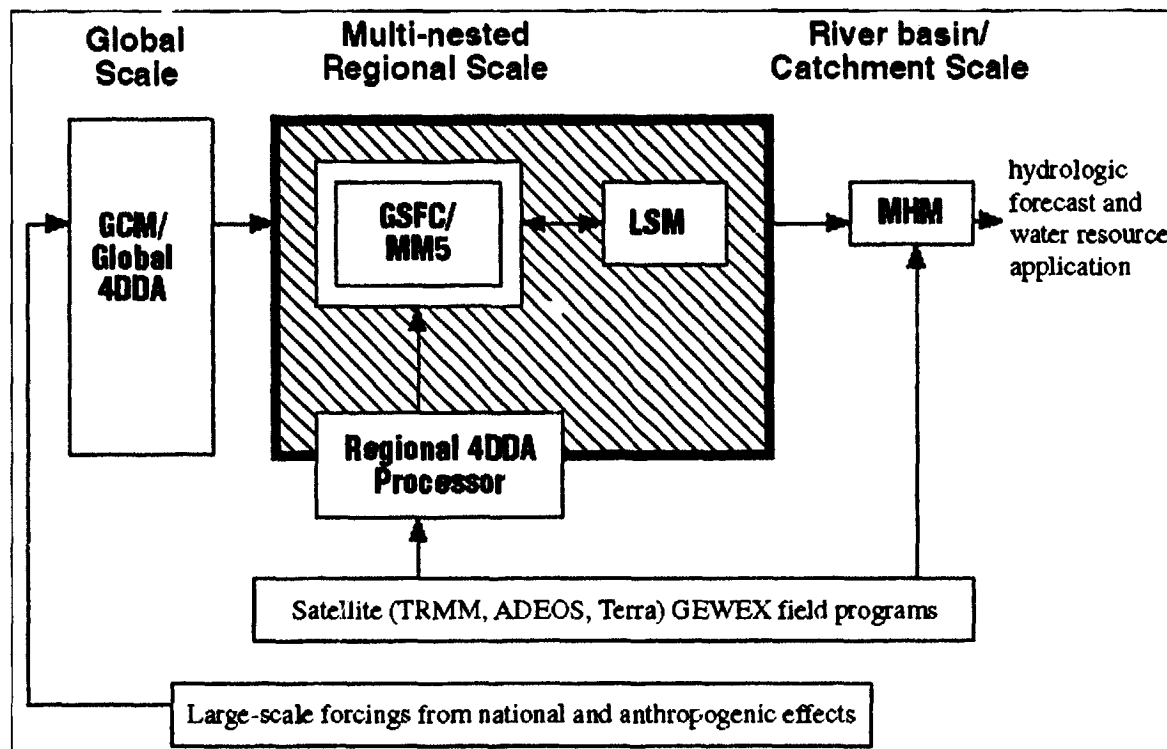

The conceptual framework of RELACS. The core component of the system is represented inside the hatched box.

The Role of Air-Sea Exchanges and Ocean Circulation in Climate Variability

Principal Investigator — **W. Timothy Liu**

Science Background

The ocean is forced at the surface largely through the exchanges of water, momentum, and heat. Without surface forcing, the ocean would just be a static pool of water. The exchanges drive the transport and change the storage of heat, water, and greenhouse gases and thus moderate the world's climate. The ocean feedback to climate changes must be manifested through these exchanges, without which the Earth would be a hostile or less-suitable habitat. We need to study ocean circulation and air-sea exchanges to understand natural global changes and to discern the anthropogenic effects.

The ocean is an under-sampled turbulent fluid with non-linear interactions; processes at one scale affect processes at other scales. Adequate observations at significant temporal and spatial scales can only be achieved from the vantage point of space. The life span of a spaceborne sensor is conducive to the study of seasonal-to-interannual variation. While our focus has been on the variability and predictability in this range of time scale, we have started to examine how such variability is affected by shorter (intra-seasonal) and longer (decadal) time-scale changes.

All spaceborne sensors measure various parts of the same electromagnetic spectrum and are intrinsically complementary. A suite of complementary spaceborne sensors is needed to unravel the complex processes of ocean-atmosphere interaction. Our study will demonstrate that the value of flying the suite of sensors together continuously far outweighs the sum of the benefits of flying individual sensors one at a time, the essence of EOS.

Spaceborne sensors, however, cannot probe the deep ocean and, therefore, in situ measurements are also needed. Ocean general circulation models (OGCM) have the potential of providing the dynamic interpolation and integration of these data. Our study will take advantage of the historic opportunity created by the advance of computer technology and the maturity of ocean general circulation models to assimilate the variety of data available during the EOS era.

Science Goals

The goal is to improve diagnosis and prognosis of global changes through the understanding of the coupled ocean-atmosphere system. The objectives are:

- 1) To improve existing, and to develop new, methodologies for estimating global ocean-atmosphere fluxes in momentum, energy, water, and carbon dioxide;
- 2) To study the changes in the transport and storage of heat, water, and greenhouse gases by the ocean in response to surface forcing; and
- 3) To understand the energy and hydrologic balances of the atmosphere and their relation to ocean surface fluxes.

Current Activities

The strategy of our investigation evolves over time, but it is based largely on the synergistic and interdisciplinary approaches of applying satellite data, ground-based measurements, and numerical models to our research. Our current activities support our three objectives. We are improving the bulk-parameterization method for estimating turbulent fluxes and deriving relevant parameters from satellite observations. We are developing new methodologies for estimating hydrologic forcing using satellite data. We are studying ocean-surface momentum balance and wind-driven ocean circulation using Lagrangian drifters and wind-speed data obtained by scatterometer. We are relating sea-level changes to both ocean dynamics and storage of heat and water. We are studying how the cloud forcing, convection, and surface heat flux are related to sea-surface temperature changes, at intraseasonal, seasonal, and interannual time scales. We are examining the relation between atmospheric water vapor and greenhouse warming. We are studying the variability of tropical cyclones, monsoons, and El Niño that have strong economic and environmental impacts.

Our modeling effort has focused in the improvement of surface forcing and mixing parameterization in an OGCM. Realistic surface forcing derived from satellite data is being used to force the OGCM, and the model responses are being compared with observations both from spaceborne and ground-based sensors. We will learn to interpret the differences in terms of specific physical processes and model weaknesses. Surface flux derived inversely by constraining the model with data will also be examined. An eddy-resolving model in the North Atlantic with $1/6^\circ$ spatial resolution has been successfully run.

We plan to extend our study to coupled ocean-atmosphere models, and the incorporation of biology in the physical model is being explored. Our efforts in satellite data application and ground-based measurements are described below.

Use of Satellite Data

Our team has strong experience in estimating ocean surface forcing using satellite data. We are actively using NSCAT and TOPEX/Poseidon data to study wind forcing and ocean dynamic response. We are currently using SSM/I and AVHRR to estimate evaporation and latent heat; ISCCP to compute solar irradiance; GPCP (Global Precipitation Climatology Project) to provide rain. We are using MLS and SSM/I to estimate upper tropospheric and integrated water vapor and ERBE data to estimate greenhouse warming. In the near future, we will continue to use operational data from AVHRR, TOVS, SSM/I, SSMT2 (humidity sounding), ISCCP, and GPCP; from scatterometers and altimeters on ERS2; from SeaWiFs (ocean productivity); from TRMM; from GLI and AMSR on ADEOS-2. We are actively preparing for the increase in accuracy and resolution of expected EOS sensors, such as, SeaWinds, QuikSCAT, Jason-1, AMSR-E, AIRS (HSB), MODIS, and CERES at the turn of the century.

Participation in Field Campaigns

Our team members have participated in the design of in situ monitoring programs and the execution of field campaigns for the Tropical Ocean Global Atmosphere (TOGA) Program and the World Ocean Circulation Experiment (WOCE). We shall continue in the analysis of data from experiments, such as TOGA-COARE (Coupled Ocean Atmosphere Response Experiment) and are actively planning and will participate in new programs, such as, the Global Drifter Program and the Atlantic Climate Change Experiment.

Principal Investigator

W. Timothy Liu

W. Timothy Liu holds M.S. and Ph.D. degrees in Atmospheric Sciences from the University of Washington. He has been a Principal Investigator on studies concerning air-sea interaction and satellite oceanography since he joined JPL in 1979. He is currently a Senior Research Scientist, the leader of the Air-sea Interaction and Climate Team, and the NSCAT/QuikSCAT Project Scientist. He received the NASA Medal for Exceptional Scientific Achievement for his pioneering work in ocean surface heat flux, a NASA Group Achievement Award for TOPEX, and a number of NASA Certificates of Recognition. Liu was selected as a member of the science investigator teams of NSCAT, TOPEX/Poseidon, TRMM, and ERS Projects. He has served on the Earth Science

and Applications Division Advisory Subcommittee and various science working groups of NASA. He has also served on numerous science working groups and advisory panels of the World Climate Research Program and editorial boards of scientific journals.

Co-Investigators

Catherine Gautier - *University of California at Santa Barbara*

William Holland - *National Center for Atmospheric Research*

Paola Malanotte-Rizzoli - *Massachusetts Institute of Technology*

Pearl P. Niiler - *Scripps Institute of Oceanography*

The following are from the Jet Propulsion Laboratory:

Lee-Leung Fu
Ichiro Fukumori
William Patzert
Wenqing Tang
Victor Zlotnicki

References

Baturin, N.G., and P.P. Niiler, 1997: Effects of instability waves in the mixed layer of the equatorial Pacific. *J. Geophys. Res.*, **102**, 27,771-27,794.

Gautier, C., P. Peterson, and C. Jones, 1996: Global estimation of freshwater fluxes and oceanic transport from satellite data. *World Resources Review*, **8**, 505-514.

Liu, W.T., A. Zheng, and J. Bishop, 1994: Evaporation and solar irradiance as regulators of the seasonal and interannual variabilities of sea surface temperature. *J. Geophys. Res.*, **99**, 12,623-12,637.

Liu, W.T., W. Tang, and R. Atlas, 1996: Responses of the tropical Pacific to wind forcing as observed by spaceborne sensors and simulated by model. *J. Geophys. Res.*, **101**, 16,345-16,359.

Liu, W.T. and W. Tang, 1997: The spaceborne scatterometer in studies of atmospheric and oceanic phenomena from synoptic to interannual time scales. *Space Remote Sensing of Subtropical Oceans*, 113-126, C.T. Liu (ed.), Pergamon, New York.

Moison, J.R., and P.P. Niiler, 1998: The seasonal heat budget of the North Pacific: Net heat flux and heat storage rates (1950-1990). *J. Phys. Oceanogr.*, **28**, 401-421.

Investigation URL

<http://airsea-www.jpl.nasa.gov/>

Spatial and Temporal Variability of Soil Moisture and Its Relation to Water and Energy Balances in a Monsoon Region

Principal Investigator – **Yongqiang Liu**

Science Background

Soil moisture is an extremely important factor for the continental-scale water and energy balances through its roles in providing available water for evapotranspiration and in determining the partition of radiative energy absorbed on the land surface into sensible and latent-heat fluxes. Our understanding of these balances is mostly based on numerical simulations, but is limited due to lack of soil-moisture measurements. Although models are powerful tools to investigate the various processes involved in the water and energy balances, observations are necessary for evaluating the performance of land-surface parameterizations and land-atmosphere coupled climate models, and for providing initial conditions to such models. Therefore, using a combination of soil-moisture observations and numerical modeling seems the most appropriate method to study the variability of soil moisture, and water and energy balances. In fact, a great effort is being made as part of the Global Energy and Water cycle Experiment (GEWEX) Continental-Scale International Project (GCIP) to collect in situ and remotely sensed observations of soil moisture, as well as develop and apply mesoscale models in the Mississippi River Basin.

To provide a more-global view of the water and energy budgets, this investigation expands GCIP to a monsoon region (East China) by using soil-moisture observations in that region as well as a regional climate model. This study is expected to provide useful insights on the spatial and temporal variability of soil moisture and its role in the water and energy balances of this monsoon region. Using studies performed in the GCIP region, we will be able to provide a comparison between these two regions.

Science Goals

The objectives of this investigation are: 1) to identify the major scales and patterns in spatial and temporal variability presented in soil-moisture observations by using various analysis techniques, as well as possible relations between these scales and patterns, and between soil moisture and other land-atmosphere variables; 2) to simulate

soil moisture and other land-atmosphere hydrological and energy components with the NCAR Regional Climate Model version 2 (RegCM2), and to analyze water and energy budgets; and 3) to conduct a number of experiments with RegCM2 to investigate the impacts of soil-moisture variability on the water and energy balances, and to provide simulation evidence and physical interpretation of possible relations between the scales and patterns of soil moisture and other land-atmosphere variables obtained from the observation study. The observation and simulation analyses will focus on differences of soil-moisture variability, and the water and energy budgets during various stages of development of monsoons, and differences during normal, anomalously strong, and anomalously weak monsoon events.

Current Activities

A complete data set of soil moisture is needed to achieve the objectives of this investigation. We are currently in the process of building up such a data set, which consists of soil-moisture observations and corresponding atmospheric observations at over 500 sites in China during the past decade. This is done in cooperation with Chinese colleagues. Part of this data set is being used to analyze the persistence of soil moisture and its role in land-atmosphere variability. It is also used to evaluate the performance of the Biosphere-Atmosphere Transfer Scheme (BATS), which will be adopted for our simulations.

We are planning to perform our numerical simulations with RegCM2. However, the climate version of the Regional Atmosphere Modeling System (ClimRAMS) developed at the Colorado State University is also available to us for this study. Because this model presents some unique features, we are also conducting test simulations with it to evaluate which one is most appropriate for our needs.

Use of Satellite Data

The appropriate specification of land types should considerably improve our simulations of land-surface processes. In RegCM2, the only land types available for the region of interest are natural vegetation (mainly conifer-

ous and deciduous forest). However, forest covers less than 20% of that region, and agriculture is a significant part of the landscape. Furthermore, both forest and agriculture crops have significant annual cycles. We will use the EOS satellite observations to better specify land cover and its annual cycle.

Principal Investigator
Yongqiang Liu

Yongqiang Liu received a Ph.D. in Atmospheric Dynamics from the Institute of Atmospheric Physics, Chinese Academy of Sciences, in 1990. He was a visiting scientist at NCAR during 1992-1993, and a faculty member at Rutgers University during 1995-1998. He is currently a Senior Research Scientist at Georgia Institute of Technology. His research areas include land-atmosphere interactions, regional climate modeling, and parameterization of precipitation induced by land-surface heterogeneity. He received the Youth Research Award of the National Committee of the Natural Science Foundation of China (1991-1993) and the Science and Technology Achievement Award of the National Meteorological Administration of China (1994). He served as an editor for "Climate Research Newsletter of China" during 1993-1994.

Co-Investigator

Roni Avissar - Rutgers University

References

Liu, Y.-Q., and R. Avissar, 1999: A study of persistence in the land-atmosphere system with a general circulation model and observations. *J. Climate*, in press.

Liu, Y.-Q., and R. Avissar, 1999: A study of persistence in the land-atmosphere system with a fourth-order analytical model. *J. Climate*, in press.

Investigation URL

<http://www.envsci.rutgers.edu>

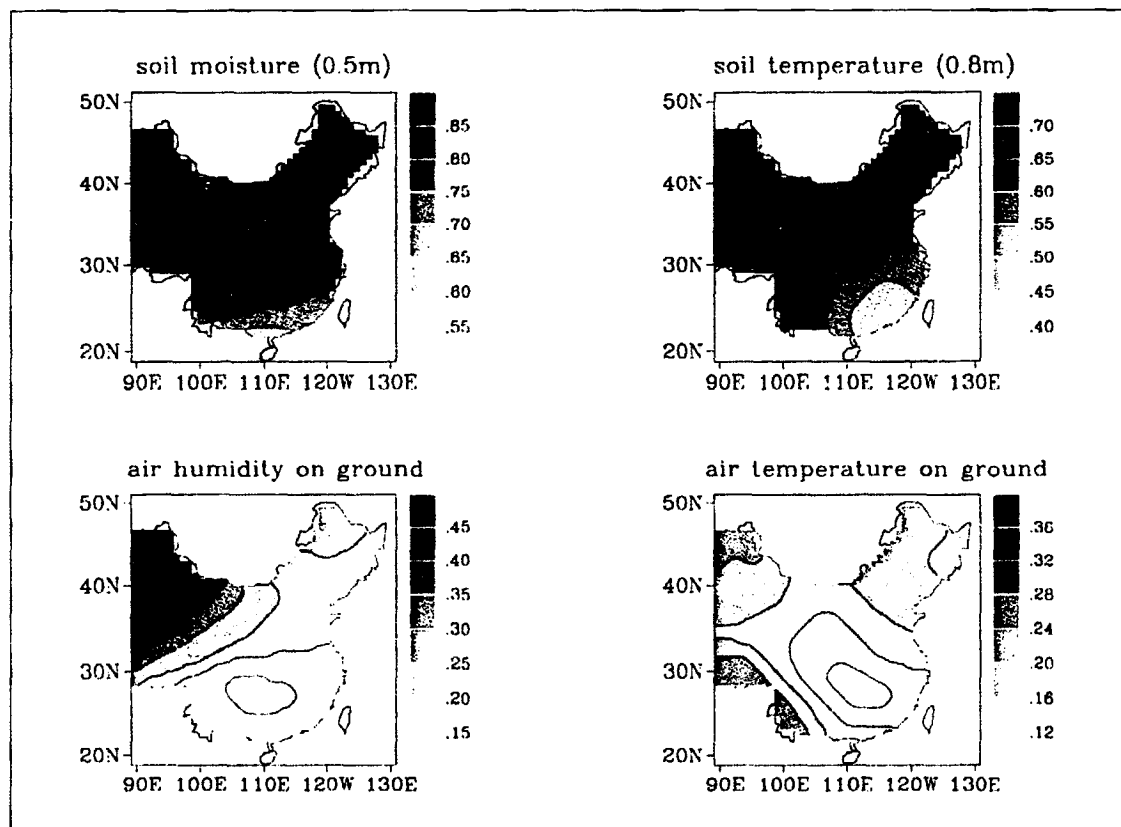

One month-lag autocorrelation coefficients in China, indicating the strongest persistence in soil moisture, and in increasing tendency in persistence from moist to dry climate regimes.

Interannual Variability of Ocean Color: A Synthesis of Satellite Data and Models and Participation in the Ocean Carbon Cycle Model Intercomparison

Principal Investigator – **John C. Marshall**

Scientific Background

1) Interannual variability of ocean color in the North Atlantic – In situ-time series observations of biogeochemical properties of the surface ocean, such as chlorophyll and zooplankton concentrations, have been shown to vary significantly on interannual and decadal timescales. Correlations with indicators of regional climate change, such as the NAO index, have also been found suggesting large scale structure to the variability. The ongoing remote ocean observation program (SeaWiFS, MODIS, TOPEX/Poseidon) will provide a database with which to examine the relationships which link physical and biological variability in the ocean. Understanding these relationships will provide insight into the nature of biogeochemical responses and feedbacks to climate change.

We are studying these relationships using ocean circulation models which are driven by observed winds and heat fluxes, and constrained to be consistent with remotely sensed altimetry, coupled with ecological models. Initial modeling studies have demonstrated that winter-time nutrient supply to the surface ocean is modulated largely by changes in convective mixing, and hence linked to surface meteorological forcing. A coupled ecological model, however, shows that interannual changes in chlorophyll concentration does not directly reflect nutrient supply, but has a more complex, regionally varying response to anomalous mixing. This regional dependence is captured in a simple analytical model which is shown to be consistent with CZCS and in situ observations of chlorophyll time-series.

2) Participation in the Ocean Carbon Cycle Model Intercomparison – Marshall and Follows are also participants, using the MIT ocean model, in the Ocean Carbon Model Intercomparison Project (OCMIP), details of which can be found in the OCMIP group entry (see under Najjar).

Principal Investigator **John C. Marshall**

John Marshall is a Professor in the Department of Earth, Atmospheric and Planetary Sciences at MIT. His research

is directed at the understanding of key components of the general circulation of the atmosphere and oceans, and the role of ocean circulation on global biogeochemical cycles. A key component of this work is the development of high performance oceanic and atmospheric models. These models are used to study fluid mechanical problems, ranging from rotating convection to the global circulation; and biogeochemical cycles, ranging from interannual variability of the North Atlantic to the oxygenation of the Panthalassic ocean in the late Permian.

Co-Investigators

Mick Follows - *Massachusetts Institute of Technology*

Watson Gregg - *NASA/Goddard Space Flight Center*

References

Follows, M.J., R.G. Williams, and J.C. Marshall, 1996: The solubility pump of carbon in the subtropical gyre of the North Atlantic. *J. Marine Res.*, **54**, 605-630.

Marshall, J.C., A.J.G. Nurser, and R.G. Williams, 1993: Inferring the subduction rate and period over the North Atlantic. *J. Phys. Oceanog.*, **23**, 1315-1329.

Marshall, J.C., C. Hill, L. Perelman, and A. Adcroft, 1997a: Hydrostatic, quasi-hydrostatic, and nonhydrostatic ocean modeling. *J. Geophys. Res.*, **102(C3)**, 5733-5752

Marshall, J., A. Adcroft, C. Hill, L. Perelman, and C. Heisey, 1997b: A finite-volume, incompressible Navier Stokes model for studies of the ocean on parallel computers. *J. Geophysical Res.*, **102(C3)**, 5753-5766.

Williams R.G., and M.J. Follows, 1998: Estimating new production over the North Atlantic due to the climatological Ekman supply of nutrients. *Deep-Sea Res.*, **45**, 461-489.

Williams R.G., and M.J. Follows, 1998: Eddies make ocean deserts bloom. *Nature*, **394**, 228-229.

Physical-Biological Interactions in the Tropical Pacific & Atlantic Equatorial Surface Layers

Principal Investigator – **Charles R. McClain**

Science Background

The tropical ocean plays a major role in both global-scale physical (oceanographic and meteorological) and biological processes. Much of the global meridional heat transport to northern latitudes is oceanic transport from the tropics. Programs such as TOGA (Tropical Ocean/Global Atmosphere) have been conducted to understand better the influence of the tropical Pacific on weather and climate, although many processes and interactions remain unresolved. Progress in understanding ENSO (El Niño-Southern Oscillation) has helped define the future directions of the World Climate Research Programme, the U.S. Global Change Research Program and the NASA Earth Science program with seasonal-to-interannual climate variability being a top priority. Biologically, the equatorial ocean is: a) the site of much of the world ocean primary productivity, i.e. the creation of organic matter through plant photosynthesis, b) a primary source of CO₂ flux to the atmosphere and c) a major commercial fishing ground. Consequently, the eastern tropical Pacific was the site for the Joint Global Ocean Flux Study (JGOFS) EqPac program in 1992 to investigate carbon cycling and transport. Physical and biological processes are linked. The vertical flux of subsurface nutrients into the surface euphotic zone controls ocean primary production. On the other hand, light attenuation by marine phytoplankton modulates the flux of visible light absorbed in the surface mixed layer and, therefore, may have significant feedbacks on sea surface temperature and air-sea heat flux.

Science Goals

The research program focuses on three general topics of investigation:

- 1) *Interactions between physical & biological processes in tropical Pacific and Atlantic Oceans.* The primary emphasis will be to perform empirical and diagnostic studies using various basin-scale meteorological, altimetric, SST, and in situ data for time-space correlation analyses with the surface photosynthetic pigment fields.
- 2) *Coupled physical-ecological models for predictive and diagnostic studies.* The models will be used to provide a more-complete interpretation of the ob-

served fields and correlations identified in Objective 1). The models will also be used to conduct sensitivity studies on the effects of spatial (horizontal and vertical) and temporal variability in light absorption on heat fluxes, mixed-layer depth, and circulation. Also, the ecosystem models currently under development include iron-uptake kinetics and competition between phytoplankton and zooplankton groups so as to address the effects of temporal variability in nutrient (micro- and macronutrients) supply on ecosystem structure and productivity.

- 3) *Data-assimilation techniques for model prediction skill and ecosystem parameter estimation.* Given that the various ecosystem processes, e.g., phytoplankton growth rate, are time dependent and vary as a function of light and nutrient history, data-assimilation methods may provide improved estimation of these quantities better than current parameterization schemes (including simple constant value assumptions).

Current Activities

Work has proceeded along five lines of investigation, as itemized below. Most of the work to date has been in development of 3-D tropical ocean circulation models, 1-D coupled physical-biological ecosystem models, 1-D biological data assimilation schemes, and the analysis of historical tropical-ocean data sets.

Historical Studies – These studies have primarily evolved around the Coastal Zone Color Scanner (CZCS) data from the tropical Pacific and Atlantic. The Pacific study focused on interannual variability and the impact of the 1982-1983 El Niño on pigment (biomass) concentrations and showed the strong correlation between sea level and surface pigment concentrations. The Atlantic study looked at the pronounced seasonal variation in pigment concentrations in the Gulf of Guinea and suggested that secondary circulation cells associated with the complex equatorial flow patterns prolong the bloom for several months after the cessation of summertime equatorial upwelling.

Data Analysis – With the recent launch of SeaWiFS in September 1997, global chlorophyll fields are routinely available for the first time. These data along with basin-

scale sea-surface temperature, TOPEX sea level, and TAO (TOGA Atmosphere-Ocean) subsurface hydrographic data are being analyzed as the tropical Pacific phases from the 1997-1998 El Niño to La Niña.

1-D Modeling – The development of ecosystem models is critical to understanding the observed fluctuations in phytoplankton concentrations, which occur in response to changes in the physical environment. Ecosystem models, forced by physical models, have been developed and tested at Ocean Weather Station P and both the eastern equatorial Pacific “Cold Tongue” and the western Pacific “Warm Pool.”

3-D Modeling – A 3-D circulation model for the tropics has been developed which incorporates an ocean surface mixed layer model and an atmospheric marine-boundary-layer model. The model also accommodates precipitation and evaporation effects on salinity and density, which are critical processes in regions like the Warm Pool. An ecosystem model is presently being integrated into this circulation model.

Data Assimilation – In parallel with the general circulation and ecosystem-model development activities, methodologies for assimilating satellite estimates of phytoplankton, i.e., chlorophyll-a, concentrations into 1-D models are being examined. Once the coupled 3-D model is completed, the assimilation studies will utilize it.

Use of Satellite Data

Satellite data will be used extensively as many of the primary physical and biological quantities of interest can be derived from remote-sensing data. Only satellite sources can provide data on the space and time scales required for this investigation. In particular, ocean chlorophyll-a estimates from SeaWiFS, the ADEOS-I/OCTS, and MODIS will be used in conjunction with SST products derived from the NOAA AVHRR and sea-level variability fields from TOPEX. Cloud-cover data, such as products from ISCCP, are used for computing surface irradiance which is required for estimation of phytoplankton growth rates and radiative heat fluxes.

Participation in Field Studies

For the past several years, as part of the international JGOFS program, Marlon Lewis and Ichio Asanuma have been conducting annual hydrographic surveys of the central and western equatorial Pacific. The data collection includes surface-layer temperature, salinity, nutrients, primary production, chlorophyll-a, and spectral irradiance. Mike McPhaden manages the TAO buoy array in the equatorial Pacific.

Principal Investigator Charles R. McClain

Chuck McClain received a B.A. degree in 1970 from William Jewell College in Liberty, MO., with a major in physics and a minor in mathematics and a Ph.D. in marine sciences from North Carolina State University in 1976. He worked for two years as a National Research Council postdoctoral associate at the Naval Research Laboratory (NRL) in Washington, D.C. where he used airborne laser profilometry to validate GEOS-III altimeter estimates of surface wave heights. He has worked at NASA/Goddard Space Flight Center since 1978. Since joining the research staff at NASA/GSFC, his research has focused on the utilization of satellite ocean-color observations and numerical models to study the interactions between physical and biological processes in the oceans. He is presently serving as the SeaWiFS (Sea-viewing Wide Field of View Sensor) Calibration and Validation Manager, Project Scientist, and Project Manager. He also serves as the Project Manager of the SIMBIOS (Sensor Intercomparison and Merger for Biological and Interdisciplinary Oceanic Studies) Project, which is co-located with the SeaWiFS Project.

Co-Investigators

Eileen Hofmann - *Old Dominion University*

Marlon Lewis - *Dalhousie University*

Ragu Murtugudde - *University of Maryland*

Antonio Busalacchi - *NASA/Goddard Space Flight Center*

Chester Koblinsky - *NASA/Goddard Space Flight Center*

Michael McPhaden - *NOAA/Pacific Marine Environmental Laboratory*

Ichio Asanuma - *Japan Marine Science and Technology Center*

References

Kessler, W.S., and M. J. McPhaden, 1995: The 1991-1993 El Niño in the central Pacific. *Deep Sea Res.*, **42**, 295-333, .

Lawson, L. M., E. E. Hofmann, and Y. H. Spitz, 1996: A Data assimilation technique applied to a marine ecosystem model. *Deep Sea Res.*, **43**, 625-651.

Leonard, C. L., and C. R. McClain, 1996: Assessment of interannual variation (1979-1986) in pigment concentrations in the tropical Pacific. *Int. J. Remote Sens.*, **17**(4), 721-732.

Lewis, M.R., M.-E. Carr, G.C. Feldman, W.E. Esaias, and C.R. McClain, 1990: Satellite estimates of the influence of penetrating solar radiation on the heat budget of the equatorial Pacific Ocean. *Nature*, **347**, 543-545.

Monger, B., C.R. McClain, and R. Murtugudde, 1997: Seasonal phytoplankton dynamics in the eastern tropical Atlantic. *J. Geophys. Res.*, **102**, 12,389-12,411.

McClain, C.R., A.R. Arrigo, K.S. Tai, and D. Turk, 1996: Observations and simulations of physical and biological processes at OWS P, 1951-1980. *J. Geophys. Res.*, **101**, 3697-3713.

Murtugudde, R.G., R. Seager, and A. Busalacchi, 1996: Simulations of tropical oceans with an ocean GCM coupled to an atmospheric mixed layer model. *J. Climate*, **9**, 1795-1815.

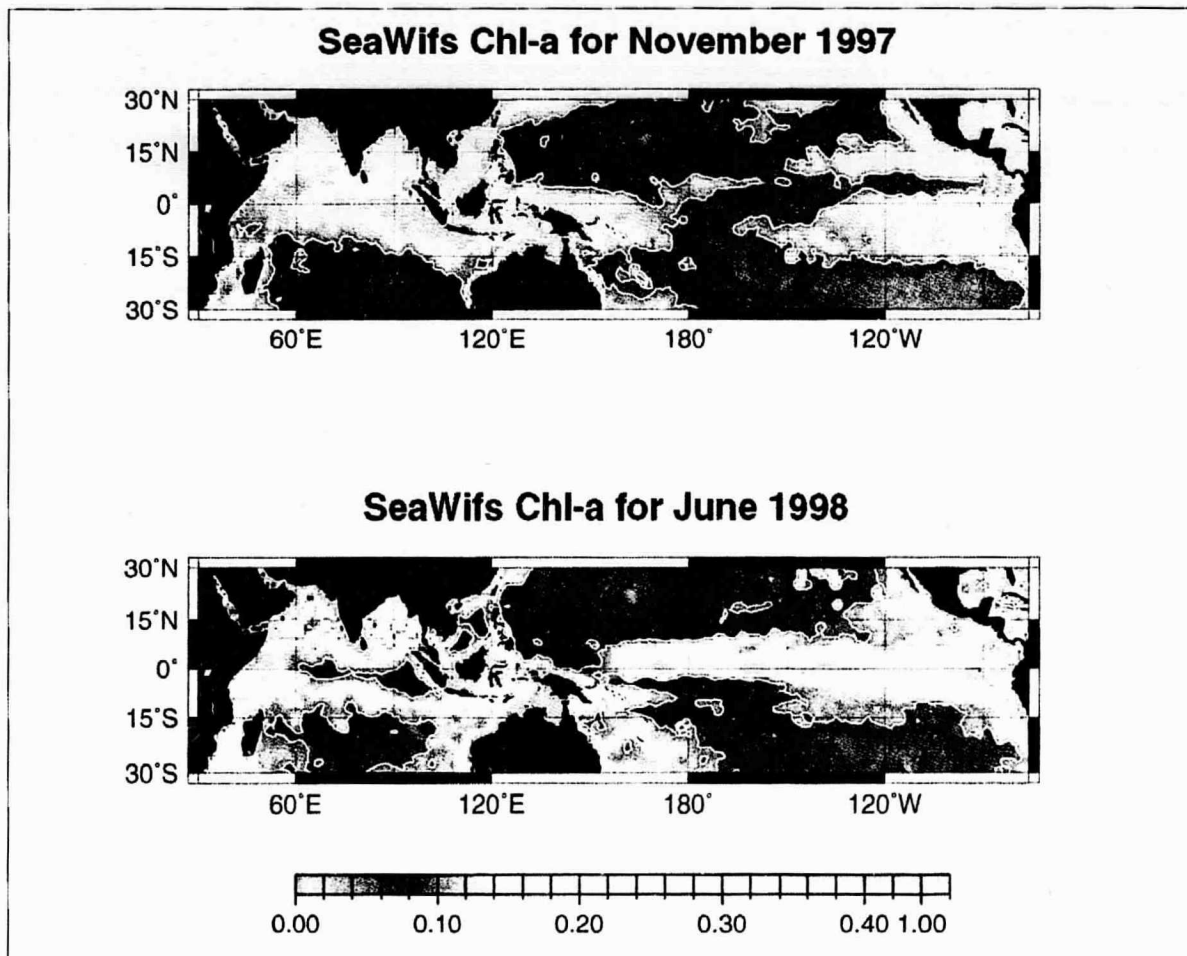

SeaWiFS surface chlorophyll concentration (mg/m^3) for the Indo-Pacific region. Note the low values of Chl-a in the equatorial Pacific during El Niño (November '97), and the extensive Chl-a bloom during La Niña (June '98). The large bloom in the eastern equatorial Indian Ocean during November 1997 was caused by extremely anomalous winds. The $0.1 \text{ mg}/\text{m}^3$ contour is superimposed for clarity.

Modeling Mesoscale Biogeochemical Processes in a TOPEX/Poseidon Diamond Surrounding the U.S. JGOFS Bermuda Atlantic Time-series Study

Principal Investigator – **Dennis McGillicuddy**

Science Goal

The overall goal of the proposed research is to investigate the role of mesoscale dynamics and upper-ocean processes on biogeochemical fluxes in the Sargasso Sea. The general approach is to use a three-dimensional coupled physical and biological model together with in situ observations and a full complement of remotely sensed information (altimetry, ocean color, scatterometry, and AVHRR) to study the biological and chemical ramifications of spatially and temporally intermittent physical processes. The coupled model system will be configured in a "TOPEX/Poseidon (T/P) Diamond" surrounding the U.S. JGOFS Bermuda Atlantic Time Series Study (BATS) site. This implementation will make it possible to prescribe the necessary physical model boundary conditions directly from T/P altimetry. Assimilation of additional data available in the interior (from moorings, BATS hydrography, and ERS altimetry) will facilitate the construction of optimal estimates of the three-dimensional structure of the water column as it evolves. These space-time continuous representations of oceanic fields will constitute a novel basis for interpretation of SeaWiFS and OCTS imagery by providing the ability to analyze ocean-color variations in the context of the underlying circulation patterns.

A nitrogen-based planktonic ecosystem model, which has been incorporated into the circulation model, will serve as a vehicle for the analysis of the biogeochemical response to physical forcing. The specific process of interest here is the role of mesoscale eddies in nutrient supply to the upper ocean. Recent modeling studies (McGillicuddy et al. 1995; McGillicuddy and Robinson 1997) indicate substantial nutrient flux associated with the formation of cyclonic eddies and subsequent intensification caused by interaction with adjacent features. Long-term simulations in the Sargasso Sea based on statistically realistic mesoscale flow fields suggest that this eddy-upwelling mechanism is the dominant mode of nutrient transport in the annual budget for the region. Data-driven coupled physical-biological simulations of the type proposed here will be used to test this hypothesis and thus

should help to reconcile the longstanding controversy concerning nutrient supply in the oligotrophic waters of the open ocean.

In addition, these hindcast simulations will be used to conduct a retrospective analysis of the BATS data to help differentiate between spatial and temporal variability in the time-series record. The possibility of using this interdisciplinary-model system in a nowcast/forecast mode to contribute to optimal resource deployment in future observational activities will be evaluated.

Principal Investigator

Dennis J. McGillicuddy Jr.

Dennis McGillicuddy Jr. earned both his M.S. degree in Applied Physics in 1989 and his Ph.D. in Earth and Planetary Sciences in 1993 from Harvard University. His research interests include physical-biological interactions; influences of circulation dynamics on planktonic ecosystems; mesoscale ocean dynamics; interaction of the near surface and deep ocean; numerical modeling; and data assimilation.

References

- McGillicuddy, D.J., A.R. Robinson, and J.J. McCarthy, 1995: Coupled physical and biological modeling of the spring bloom in the North Atlantic: II. Three dimensional bloom and post-bloom processes. *Deep Sea Res.*, **42**, 1359-1398.
- McGillicuddy, D.J., and A.R. Robinson, 1997: Eddy-induced nutrient supply and new production in the Sargasso Sea. *Deep Sea Res.*, **44**, 1427-1450.
- McGillicuddy, D.J., A.R. Robinson, D.A. Siegel, H.W. Jannasch, R. Johnson, T.D. Dickey, J. McNeil, A.F. Michaels, and A.H. Knapp, 1998: Influence of mesoscale eddies on new production in the Sargasso Sea. *Nature*, accepted.

Analysis of the Effect of Changing Climate Variability on Crop Production in the Southeastern United States: An Integration of Stochastic Modeling, Regional Climate Modeling, Crop Modeling, and Remote Sensing Techniques

Principal Investigator – **Linda O. Mearns**

Science Background

New concerns have emerged regarding possible impacts of climate perturbations on agricultural resources. One such concern is the role of changing climatic variability effects on crops, in addition to changes in mean climate states. Failure to account for variability change (on daily-to-interannual time scales) effects on resource systems was recognized as a serious limitation for studies conducted for the EPA Report on Potential Effects of Climate Change on the United States. More recently, the research needed to determine possible effects of changes in variability, was highlighted in the IPCC 1995 Working Group II Report.

In the past few years there has also been an intense flurry of activity regarding seasonal forecasts of El Niño/Southern Oscillation (ENSO) and the value of such forecasts to various economic sectors, especially agriculture. This heightened interest resulted both from clearer evidence of robust relationships between ENSO events and agricultural production (e.g., Cane et al. 1994) and improvements in climate/forecast models leading to better forecasts of ENSO events (e.g., Chen et al. 1995). The most-recent El Niño episode, the duration of which caused some alarm in climate and impacts communities, lasted more than four years, and some scientists suggested that its duration could well be related to global warming (Trenberth and Hoar 1996). This last suggestion indicates that changes in the frequency and intensity of ENSO-type events that strongly influence interannual variability of climate are likely in a future greenhouse-gas-warmed climate. While the immediate attraction of seasonal forecasting of climate is obvious from, for example, a famine early-warning point of view, it should also be recognized that the constellation of new research in climate modeling and in impacts assessment provides a fertile area for new research in longer term climate change, i.e., the consideration of changes in the statistical characteristics of events that strongly influence interannual climate vari-

ability, and how these changes could affect agricultural production.

Our project is an interdisciplinary investigation that concerns development of plausible scenarios for regional climate for application to improved assessments of the potential impacts of climate variability on U.S. agricultural production and world production.

We propose to conduct a multifaceted study in the Southeastern U.S. that will combine stochastic modeling of interannual climate variability, high-resolution regional climate modeling, application of crop models, and application of remote-sensing techniques, to examine the potential effects of changes in interannual climatic variability on crop production. This work will build on a regional modeling study that is currently underway at NCAR whereby high-resolution (50 km) control and doubled runs will be produced (Giorgi et al. 1993a,b; Giorgi et al. 1994). In this proposal we plan to use these runs as a baseline climate scenario and apply them to crop models (i.e., the CERES and CROPGRO family of models).

Two types of scenarios will be developed from these model runs: one including daily mean changes in the relevant climate variables and another including both mean and daily variability changes (Mearns et al. 1996, 1997). Since the regional-climate-model scenario will be developed by nesting it in a general circulation model (GCM) with only a mixed-layer ocean, the changes in variability predicted by the climate model will be "incomplete" in that major changes in interannual variability resulting from alterations in three-dimensional ocean dynamics and heat exchange will not be modeled. We will, however, construct guided sensitivity studies of changes in the frequency of ENSO and North Atlantic Oscillation (NAO) events relevant to the region, through examination of both indications of past changes in ENSO events and the most recent results of coupled climate-model transient experiments. These changes will be stochastically simulated and applied to the crop models.

Science Goals

- 1) Further knowledge regarding possible effects of changing climatic variability on regional crop production.
- 2) Clarify the relative importance of ENSO and NAO events on crop yields in the southeast by stratifying various measures of observed yields according to ENSO- or NAO- related categories (e.g., El Niño, La Niña, normal).
- 3) Further the use of remote sensing (particularly AVHRR) for determination of crop characteristics and conditions.
- 4) Improve crop-climate models by incorporating crop response to excess moisture (flooding, water logging) so the models can be more successfully used for studies of changes in interannual climatic variability.
- 5) In a pilot-study mode, investigate methods of deriving land-surface parameters for the Regional Climate Model (RegCM2) from remotely sensed data using NDVI values. The spatial and temporal dynamics of land-surface parameters (e.g., surface roughness, albedo, and canopy conductance) would be obtained directly from remotely sensed data rather than inferred indirectly from survey-based classification.
- 6) Apply crop models to a relatively high-resolution-grid system of climate changes (in contrast to studies using a few isolated points to represent a region).
- 7) Compare the effects of different spatial resolutions of climate change (nested regional climate compared to driving GCM resolution) on determination of changes in crop yield.

Current Activities

The regional climate-modeling runs have been completed, and a climate-change scenario, for use in the crop models, has been formed. The scenario exhibits fairly large decreases in precipitation in the late spring and summer, which likely leads to negative effects on crops. We have produced some preliminary runs with the CERES-wheat model over the entire southeastern domain, using the climate-change scenario. Our first results indicate substantial (about 30%) decreases in simulated crop yields throughout the region with the climate change from the Regional Model. Next steps include producing simulated yields from the scenario for all crops, and then repeating the runs with adaptation and direct CO₂ fertilization effects.

Six SPOT images for the 1998 soybean-cropping season at Florence, South Carolina have been acquired, and NDVI calculated from the images. We performed field sampling of LAI for the soybean crop coincident with the SPOT images. Relationships between NDVI and LAI are being developed and will be used to validate crop-model runs at this and other sites.

Biweekly maximum-value NDVI composite data (from AVHRR) from 1989 through 1998 have been assembled and analyzed for the Southeast. These data were analyzed according to vegetation-cover type within climate divisions. Six cover types were defined in the Southeast U.S. Average NDVI and associated statistics were determined for the entire Southeast region, for the region by cover type, for selected climate divisions and for each division by cover type. Twenty-four climate divisions within an expected climate signal (ENSO) as well as sites outside the signal area were selected for detailed analysis. Analyses of the interannual variability of the NDVI values for the selected climate divisions are being performed, and relations between NDVI and fluctuations in both observed and simulated crop yields are being developed.

Some of these NDVI data will be used to validate crop models (assuming relationships between NDVI and LAI are successfully developed) and may be used to update the crop models during simulation runs.

Participation in Field Experiments

No participation in field experiments is currently planned.

Use of Satellite Data

We are incorporating the use of remote sensing in this study in four ways: 1) verification of cropping regions via SPOT and AVHRR data; 2) validation of the climate model via SSM/I data, and 3) validation of certain elements of the crop models (such as LAI) to determine their ability to correctly reproduce interannual variability; and 4) use of AVHRR data to further confirm the effect of El Niño events on crops in the region, by comparing year-to-year values of NDVI that have been processed to represent specific crop characteristics such as LAI or, perhaps, economic yield.

Particularly extreme El Niño events (e.g., 1982-83) will be examined in greater detail with AVHRR data to determine if extreme crop responses can be determined via remotely sensed data.

Principal Investigator
Linda O. Mearns

Linda O. Mearns is a Scientist III in the Environmental and Societal Impacts Group (ESIG) at the National Center for Atmospheric Research, Boulder, Colorado, and leads an interdisciplinary research group within ESIG focusing on applications of regional climate modeling results to impact assessments. She holds a Ph.D. in Geography/Climatology from UCLA. She has performed research and published in the areas of crop-climate interactions, climate-change-scenario formation, climate-change impacts on the agro-ecosystems, and analysis of climate variability and extreme climate events in both observations and climate models. She has most recently published a series of articles on the effects of changes in climate variability (in contrast to changes in mean climate) on simulated crop yields.

She has contributed to the IPCC Climate Change 1992 and 1995 Reports on the subject of climate variability in general circulation models, the climatology of mountainous regions, and impacts of climate change on agriculture. She is a member of the IPCC Task Group on Scenarios for Climate Impact Assessment. She currently leads a project funded by the EPA, NASA, and USDA, on the effects of changes in climate variability on crop production in the Southeastern U. S.

Co-Investigators

Richard W. Katz - *National Center for Atmospheric Research*

William Easterling - *Pennsylvania State University*

Gregory Carbone - *University of South Carolina*

D. Rundquist - *University of Nebraska*

E. Walter-Shea - *University of Nebraska*

References

Cane, M.A., G. Eshel, and R.W. Buckland, 1994: Forecasting Zimbabwean maize yield using eastern equatorial Pacific sea surface temperature. *Nature*, **370**, 204-205.

Chen, D., S.E. Zebiak, A.J. Busalacchi, and M.A. Cane, 1995: An improved procedure for El Niño forecasting: Implications for predictability. *Science*, **269**, 1699-1702.

Giorgi, F., M.R. Marinucci, and G.T. Bates, 1993a: Development of a second generation regional climate model (REGCM2). Part I: Boundary layer and radiative transfer processes. *Mon. Wea. Rev.*, **121**, 2794-2813.

Giorgi, F., M.R. Marinucci, G. DeCanio, and G.T. Bates, 1993b: Development of a second generation regional climate model (REGCM2). Part II: Cumulus cloud and assimilation of lateral boundary conditions. *Mon. Wea. Rev.*, **121**, 2814-2832.

Giorgi, F., C.S. Brodeur, and G.T. Bates, 1994: Regional climate change scenarios over the United States produced with a nested regional climate model. *J. Climate*, **7**, 375-399.

Mearns, L.O., C. Rosenzweig, and R. Goldberg, 1996: The effect of changes in daily and intrannual climatic variability on CERES-Wheat: A sensitivity study. *Climatic Change*, **32**, 257-292.

Mearns, L.O., C. Rosenzweig, and R. Goldberg, 1997: Mean and Variance Change in Climate Scenarios: Methods, Agricultural Applications, and Measures of Uncertainty. *Climatic Change*, **35**, 367-396.

Trenberth, K., and T.J. Hoar, 1996: The 1990-1995 El Niño-Southern Oscillation Event: Longest on record. *Geophys. Res. Letters*, **23**, 57-60.

Observation and Modeling of Heat and Water Fluxes Over Heterogeneous Land Surfaces at Mesoscale

Principal Investigator – **Massimo Menenti**

Science Background

The performance of a Numerical Weather Prediction (NWP) model is critically dependent on the initialization and updating of the model state, of which both the model forecast in the preceding period and the observations of the atmosphere and of the land surfaces are most important. Hence the quality of the initial data and the data-assimilation procedure determine the prediction skill of an NWP model. Because the data assimilation is nearly continuous in time in an NWP model, the availability of reliable global data becomes critical to update weather forecasts.

Science Goals

Since it has been shown that initial soil-water content has an important impact on the NWP model forecast, two strategies for assimilation of soil-moisture fields in an NWP model can be considered: 1) to derive from the energy balance at the land-atmosphere interface a measure of water availability in the plant root zone; and 2) to estimate soil-water content in the surface layer using microwave observations. Earth Science Enterprise (ESE) data provide excellent opportunities to carry out the above two strategies. The aims of this investigation are to:

- evaluate the use of advanced imaging radiometers, to obtain more-accurate estimates of surface albedo, spectral indices, and surface temperature;
- improve the accuracy of the energy partition at the land surface;
- develop a procedure to obtain large-area soil-water content using microwave observations; and
- develop a procedure to assimilate time series of energy balance and surface soil moisture into NWP models.

Current Activities

Within the Dutch national remote-sensing program, the group has developed a new remote-sensing algorithm

Surface Energy Balance (SEBAL) to map heat fluxes for heterogeneous land surfaces. It has also been shown that the evaporative fraction (the ratio of latent heat to the difference between net radiation and soil heat flux) is a reliable indicator of soil-water availability. A set of tools has been created for processing currently available remote-sensing data (Landsat, NOAA/AVHRR, Meteosat) to derive the necessary inputs for SEBAL. Various approaches have been developed for the estimation of surface moisture using microwave observations. A research version NWP model Regional Atmospheric Climate Model (RACMO) has been applied to North Africa and Europe. RACMO includes a fully interactive land-surface-process sub-model that describes heat and water transfer in the root-zone soil using multi-layers and allows the assimilation of root-zone soil-water indicators and surface moisture.

Use of Satellite Data

EOS data products will be used to retrieve surface parameters to characterize various land-surface processes. These parameters include surface albedo, vegetation spectral indices, surface emissivity, surface temperature, roughness, and moisture. MODIS, ASTER, Landsat 7, AMSU, MISR, and AMSR-E will be used to complement currently available satellite sensors. These data will be used to make atmospheric corrections in the optical, infrared, and thermal infrared in combination with synoptic weather information. Derivation of directional reflectance and temperature will also be investigated using these data.

Participation in Field Programs

Members of this group have been involved in several past and ongoing large field programs. These include: MONSOON, HAPEX-MOBILHY held in France in 1986, First ECHIVAL Field Experiment in Desertification Threatened Areas (EFEDA) held in central Spain in 1991 and 1994, HAPEX-SAHEL held in Niger in 1992, Heihe basin Field Experiment (HEIFE) during 1990 and 1995 in Northwest China, Jornada Experiment (JORNEX) during 1995 and 1996 in Washita, New Mexico, 1992 and 1994, and

GEWEX ESE Southern Great Plains Hydrology Experiment (SGP'97). During the period 1997-1999 we plan to participate in the TIPEX, IMGRASS and JORNEX activities.

Principal Investigator
Massimo Menenti

Massimo Menenti of the Winand Staring Centre in Wageningen, The Netherlands, has been a member of the 1st Steering Committee of ISLSCP and spends regular extended visits at the NASA/GSFC Hydrological Sciences Branch and USDA/ARS Hydrology Laboratory. His research interest focuses on land-surface processes and regional hydrological processes. These range from studies of heat balance in relation to groundwater evaporation to integration of satellite observations with hydrological models. High-spatial-and-vertical-resolution laser measurements were used to estimate aerodynamic roughness and leaf-area index. The relation of climate variability to large-area vegetation phenology was studied by using long time series of satellite observations.

Co-Investigators

A. C. M. Belijaars - *Weather Forecast, ECMWF*

Henk A. R. De Bruin - *Wageningen Agricultural University*

Dirk H. Hoekman - *Wageningen Agricultural University*

A. Holtslag - *Royal Netherlands Meteorological Inst.*

References

Menenti, M., J.C. Ritchie, and K.S. Humes, 1996: Estimation of aerodynamic roughness at various spatial scales. *Scaling Up in Hydrology Using Remote Sensing*. J.B. Stewart, et al., Eds., Wiley, Chichester, UK, 39-58.

Wang, J., Y. Ma, M. Menenti, and W.G.M. Bastiaanssen, 1995: The scaling-up of processes in the heterogeneous landscape of HEIFE with the aid of satellite remote sensing. *J. Meteor. Soc. Japan*, **73**, 1235-1244.

Bastiaanssen, W.G.M., M. Menenti, R.A. Feddes, and A.A.M. Holtslag, 1997: A remote sensing surface energy balance algorithm for land (SEBAL). Part 1: Formulation. *J. Hydrology* (special issue), in press.

Ritchie, J.C., M. Menenti, and M.A. Weltz, 1996: Measurements of land surface features using an airborne laser altimeter: the HAPEX-Sahel experiment. *Int. J. Remote Sens.*, **17**, 3705-3724.

Hurk, B.V.D., W.G.M. Bastiaanssen, H. Pelgrum, and E.V. Meijgaard, 1997: A new methodology for assimilation of initial soil moisture fields in weather prediction models using Meteosat and NOAA data. *J. Appl. Meteor.*, in press.

Z. Su, P.A. Troch, and F.P. De Troch, 1997: Remote sensing of bare soil moisture using EMAC/ESAR data. *Int. J. Remote Sens.*, **18**, 2105-2124.

Investigation URL

<http://www.sc.dlo.nl/>

Global Climate Impact on Regional Hydro-Climate and its Effect on Southeastern Asian Agro-Ecosystems

Principal Investigator – **Norman L. Miller**

Science Background

The Regional Climate System Model (RCSM) has been under development for several years. This system downscales global climate data to the watershed catchment scale, and consists of data pre- and post-processors, and four model components. The four model components are: 1) a mesoscale atmospheric model, 2) a soil-plant-snow model, 3) a watershed-hydrology-riverflow model, and 4) a crop-response model. The first three model components have been coupled, and the system includes two-way feedbacks between the plant-soil-snow model and the mesoscale atmospheric model. This three-component version of the RCSM has been tested, validated, and successfully used for operational quantitative precipitation forecasts and seasonal water-resource studies over the southwestern U.S.. Integration of the fourth component (crop-response model) into the RCSM is part of our current research plan in collaboration with NASA and NCAR.

Science Goal

The goal of this research is to improve our current understanding of the relationships between global climate forcing, regional climate variation, and agro-ecosystem response. This investigation is based on numerical simulations using the RCSM with large-scale forcing from global analyses and the utilization of a variety of observational data including specific EOS data sets. This research is concentrating on southeastern Asia (China, Japan, and Korea), a rainfall- and temperature-sensitive region representing over 20% of the world's grain production and population and also the site of the GEWEX Asian Monsoon Experiments (GAME). The primary contribution is to provide validated fine-resolution soil moisture and input for crop-yield simulations for this region. Past investigations of climate-change impacts on the world's major agro-ecosystems have relied on simulated GCM precipitation. However, it has been shown that large-scale precipitation fields do not reproduce precipitation and soil moisture sufficiently. This leads to the extension of the RCSM over specific regions with sub-daily to annual time scales. Validation using reanalysis will provide for a downscaling system to study regional impacts based on large-scale climate projections.

Current Activities

We are systematically investigating the impacts of large-scale variability on regional water resources and agriculture over the GAME region using the RCSM forced by global reanalyses. Validation studies for southeastern Asia (Kim et al. 1997) are being performed with good results. A 17-year hindcast at 60-km resolution and monsoon simulations at 20-km resolution are to be carried out during 1998. This mesoscale-modeling research is part of a collaboration with the Korean Meteorological Research Institute (METRI). The hydrological data collection and modeling research is part of a collaboration with the Chinese Ministry of Water Resources and the Changwon National University of Korea. Agriculture data and modeling is in collaboration with NASA and NCAR scientists. These efforts will contribute to both the GAME/HUBEX (Huaihe Basin Experiment) and KORMEX (Korean Monsoon Experiment) field campaigns.

Use of Satellite Data

We are using a variety of satellite-produced data sets including the $1^\circ \times 1^\circ$ TOVS Pathfinder A data set to perform model validation and climatology studies. The main data fields are precipitation, surface air temperature, skin temperature, precipitable water, outgoing longwave radiation, and downwelling surface longwave radiation. Additionally, we are using the AVHRR-produced leaf-area index and green-leaf fraction, as well as the NOAA 9, 11 GPCP data.

Participation in Field Activities

Participation in the HUBEX Intensive Observation Period (IOP): Travel to Korea during 1998 and work with scientists from the Korean Meteorological Research Institute.

Participation in the KORMEX Intensive Observation Period (IOP): Travel to the Huaihe Basin during Spring 1998 and work with scientists from the Chinese Ministry of Water Resources.

Principal Investigator**Norman L. Miller**

Norman L. Miller received his Ph. D. in Meteorology from the University of Wisconsin in 1987. He is currently a Hydrometeorologist at the University of California-I.BNL and is principally involved in Regional Climate System Model management and development. This entails numerical-code development and sensitivity analyses for hydrological and biophysiological phenomena at a range of temporal and spatial scales. Special focus is on atmospheric-hydrologic coupling and feedbacks, hydrologic model calibration and verification, and land-surface characterization.

Co-InvestigatorJinwon Kim - *University of California***References**

Kim, J., N.L. Miller, J-H. Oh, J. Chung, and D-K. Rha, 1998: Eastern Asian hydrometeorology simulation using the Regional Climate System Model. *Global and Planetary Change*, **19**, 225-240.

Kim, J., 1997: Precipitation and snow budget over the southwestern United States during the 1994-1995 winter season. *Water Resour. Res.*, in press.

Kim, J., Miller, N., K.P. Georgakakos, and A.K. Guetter, 1998: River flow response to precipitation and snow budget in California during the 1994-1995 winter. *J. Climate*, **11**, 2378-2386.

Kim, J., N.L. Miller, J-H. Oh, and J. Chung, 1997: A simulation of precipitation and land-surface water budgets over East Asia using the UC Regional Climate System Model. The Third International Study Conference on GEWEX in Asia and GAME, 26-28 March 1997, Cheju, Korea.

Kim J., and N.L. Miller, 1996: Application of a coupled atmosphere river flow model to a regional water resources study. Second International Science Conference on global energy and water cycle, 17-21 June 1996, Washington, DC.

Kim, J., and S-T Soong, 1996: A simulation of a precipitation event in the western U.S. Regional Impacts of Climate Change, S. Ghan, W. Pennel, K. Peterson, E. Rykiel, M. Scott, and L. Vail, Eds., Battelle Press.

Kim, J., and M. Ek, 1995: A simulation of the surface energy budget and soil water content over the Hydrologic Atmospheric Pilot Experiments-MOBILHY forest site. *J. Geophys. Res.*, **100**, 20,845-20,854.

Miller, N.L., 1997: Coupling global climate models to regional hydrometeorologic models. In Minutes of the Twelfth Mission to Planet Earth/Earth Observing System (MTPE/EOS) Investigators Working Group Meeting. *The Earth Observer*. March/April, 9. No. 2, 15.

Miller, N.L., and J. Kim, 1997: The UC-LLNL Regional Climate System Model (RCSM). Mission Earth: Modeling and Simulation for a sustainable Global System. Ed. M.G. Clymer and C.R. Mechoso, Eds.

Miller, N. L., J. Kim, and J. Duan, 1997: The UC-LLNL Regional Climate System Model: Southwestern United States and Eastern Asia Studies. Research Activities in Atmospheric and Oceanic Modelling. CAS/JSC Working Group on Numerical Experimentation. WMO/ICSU/IOC World Climate Research Programme Report 25. A. Staniforth, Ed.

Miller, N.L., J. Kim, J-S Chung, I-H. Oh, and B-H Bae, 1997: East Asian hydroclimate and agro-ecosystem research using the Regional Climate System Model. The Third International Study Conference on GEWEX in Asia and GAME, 26-28 March 1997, Cheju, Korea.

Miller, N.L., and J. Kim, 1996: Numerical prediction of precipitation and riverflow over the Russian River watershed during the January 1995 California storms. *Bull. Amer. Meteor. Soc.*, **77**, 101-105.

Investigation URL

<http://ccs.lbl.gov/RCSM>

Changes in Global Biogeochemical Cycles

Principal Investigator – **Berrien Moore**

Science Background

This Interdisciplinary Science investigation addresses the primary biogeochemical cycles of planet Earth.

Initial efforts focus on the cycles of water, carbon, nitrogen, and selected trace gases. Process-based models are developed as modules, in concert with database management techniques which synthesize the in-situ and remote sensing data needed to characterize regional and global scales. Ecosystem, hydrologic, and biogeochemical modules will ultimately be coupled interactively to atmospheric chemistry and transport modules. The results of this investigation have supported the priority research needs of the Intergovernmental Panel on Climate Change (IPCC) and other regional and global integrated assessment activities, including the U.S. National Assessment.

Models of the Earth's biogeochemical cycles are a central theme. They provide a rigorous means for developing quantitative projections of the interactions of atmospheric composition, climate, terrestrial and aquatic ecosystems, ocean circulation, and the effects of human activities. The family of models being developed in this investigation will provide the predictive link between the physical and biological Earth system and the human dimensions of global change.

Goal and Objectives

The long-term goal of our IDS research is to understand the primary biogeochemical cycles of the planet, the nature of the coupling between the Biogeochemical Subsystem and the Physical-Climate Subsystem, and the characteristics of the human forcing of the Biogeochemical Subsystem, including the hydrological cycle. Our strategy is to study how element cycles function in natural systems where perturbations in biogeochemical states are driven primarily by climate variability and in systems where disturbance gradients induced by human activity have modified significantly exchanges of water, carbon, nitrogen, or sulfur.

To execute this strategy, we have been developing regional and global, geographically-specific, mathematical models and databases. These describe ecosystem distribution and condition, the biological processes that determine the exchange of CO₂ and trace gases with the

atmosphere, and the fluxes of carbon and nutrients to aquatic ecosystems. This suite of models rests within interactive information systems that integrate geographic information systems, remote-sensing systems, database management systems, graphics packages, and model interface shells. A macro Information Management System is being developed to "wrap" the specific subsystem information management systems.

Five science Objectives form the basis for our IDS research.

- To describe the global pattern and distribution of terrestrial ecosystems and to describe the geographical and temporal forcing agents of anthropogenic disturbance, particularly deforestation.
- To describe globally, for terrestrial ecosystems, key biological processes such as net primary production, heterotrophic respiration, transpiration, nutrient uptake, carbon allocation, and leaching, which bear upon global biogeochemical cycles.
- To determine the baseline and changing fluxes of water, carbon, nitrogen, and phosphorus from terrestrial biomes to the world's oceans.
- To determine the spatial and temporal patterns of the fluxes in CO₂, CH₄, CO, N₂O, NH₃, reduced sulfur gases, and the nonmethane hydrocarbons between terrestrial biomes and the atmosphere, and between aquatic systems and the atmosphere.
- To develop the background trace-gas-release data associated directly with human industrial and urban activities.

Principal Investigator **Berrien Moore**

Berrien Moore earned a Ph.D. in Mathematics from the University of Virginia in 1969. He is best known internationally for his computer modeling of the global carbon cycle. Professor Moore's specific research interests include the application of geographic information systems

and remote sensing in modeling ecosystem dynamics globally, and the use of inverse calculations to develop ocean models for use in carbon-cycle investigations. He is well-published in ecosystems literature and in studies of the role of the ocean in the carbon cycle. He is involved in numerous related studies for NASA, the National Science Foundation, and the Environmental Protection Agency. Professor Moore is Director of the Institute for the Study of Earth, Oceans, and Space at the University of New Hampshire.

Co-Investigators

William Emanuel - *University of Virginia*

Robert Harris - *NASA/Langley Research Center*

Jerry M. Melillo - *Marine Biological Laboratory*

Bruce Peterson - *Marine Biological Laboratory*

The following are from the University of New Hampshire:

John Aber

Steve Froking

Barrett N. Rock

Chang Sheng Li

David Skole

Charles Vorosmarty

References

Aber, J.D., B.L. Bolster, S. Newman, M. Soulia, and M.E. Martin, 1994: Testing the utility of end-member analysis in the measurement of carbon fraction and nitrogen content of forest foliage. *J. Near Infrared Spectroscopy*, **2**, 15-24.

Melillo, J.M., A.D. McGuire, D.W. Kicklighter, B. Moore, C.J. Vorosmarty, and A.L. Schloss, 1993: Global climate change and terrestrial primary production. *Nature*, **363**, 234-240.

Moore, B., and B.H. Braswell, 1994: The lifetime of excess atmospheric carbon dioxide. *Global Biogeochem. Cycles*, **8**, 23-28.

Skole, D.L., and C.J. Tucker, 1993: Tropical deforestation, fragmented habitat, and adversely affected habitat in the Brazilian Amazon: 1978-1988. *Science*, **260**, 1905-1910.

Vorosmarty, C.J., B. Moore, A.L. Grace, M.P. Gildea, J.M. Melillo, B.J. Peterson, E.B. Rastetter, and P.A. Steudler, 1989: Continental-scale models of water balance and fluvial transport: An application to South America. *Global Biogeochem. Cycles*, **3**, 241-265.

Investigation URLs

<http://eos-www.sr.unh.edu/eos/>

<http://pathfinder-www.sr.unh.edu/pathfinder/>

A Global Assessment of Active Volcanism, Volcanic Hazards, and Volcanic Inputs to the Atmosphere from EOS

Principal Investigator – **Peter J. Mouginis-Mark**

Science Background

The impact of volcanoes on the Earth system was dramatically demonstrated by the eruption in 1991 of Mt. Pinatubo (Philippines), and in 1994 by activity at Rabaul volcano (Papua New Guinea). Mt. Pinatubo had a near-global effect via the introduction of 20-to-30 megatons of sulfur dioxide and aerosols into the atmosphere, and represented the second largest eruption this century—second only to Mt. Katmai (Alaska) in 1912. The materials injected into the stratosphere by Mt. Pinatubo circled the Earth in only 3 weeks, and covered ~42 percent of the Earth's surface after 2 months. Atmospheric models suggest that a global cooling of 0.5 degrees Celsius took place the year after the eruption. In Papua New Guinea, the hazards associated with volcanoes were clearly demonstrated by the unexpected eruption of Rabaul volcano, which caused 30,000 people to be hastily evacuated hours before over a meter of ash was deposited in parts of the nearby town!

The degassing history of a lava flow or an eruption plume may have a major effect on the local or hemispheric climate, depending on the rate of eruption, the magma chemistry, and pre-eruption storage characteristics of the magma. Through the analysis of ongoing eruptions, data from EOS surface imagers and atmospheric instruments are expected to significantly improve the understanding of volcanic hazards, how volcanoes work, and the short-term effects that eruptions have on weather and climate.

Science Goals

This investigation's objectives are threefold: 1) to understand the physical processes associated with volcanic eruptions; 2) to investigate the manner by which sulfur dioxide, water vapor, carbon dioxide, and other volcanic gases are injected into the troposphere and stratosphere; and 3) to place the diverse volcanic eruptions into the context of the regional tectonic setting of the volcano.

Current Activities

The major activity is the development of robust algorithms that enable the team to routinely study volcanic phenomena and their impact on the atmosphere. This includes a wide range of investigations, including the development

of SO₂ retrievals using UV and thermal-infrared data, the mapping of topography and topographic change using radar interferometry, the analysis of the particle-size distribution and gas content of volcanic eruption clouds using visible and infrared data, and the analysis of the distribution of temperatures within active lava flows and domes from infrared observations. Automated techniques are also being developed that will enable MODIS to detect a new eruption in near real-time, and distinguish an eruption from a forest fire or other hotspot, thereby enabling event detection to be routinely conducted worldwide. Field programs that test the ability of remote-sensing instruments to make quantitative measurements of volcanic phenomena, and the validation of satellite observations made at visible, infrared, and microwave wavelengths also make up much of our on-going research.

Use of Satellite Data

This investigation draws heavily on many of the EOS sensors and complementary ESE instruments, combining high-spatial-resolution images of near-vent activity and daily regional low-resolution views of volcanic thermal anomalies and eruption plume dispersal. ASTER, Landsat 7, and MODIS will be used for temperature measurements of active lava flows and eruption plumes. EOSP, MISR, MLS, SAGE III, and TES will be used to study the dispersal of different volcanic gases and aerosols. ASTER and orbital radars (Radarsat, ENVISAT's ASAR) will be used for high-resolution topographic mapping of volcanoes and the analysis of ground deformation due to intrusions and eruptions. Jason-1, MISR, MODIS, and VCL will be used to determine the heights of eruption plumes and their three-dimensional shapes, and these measurements will be compared to AIRS atmospheric temperature data in order to investigate eruption-plume dynamics.

Before the EOS satellites are launched, the team is using analog data sets from existing instruments, including ATSR, AVHRR, ERS-1/2 radar, HIRS, Landsat 5, MLS/UARS, Radarsat, SIR-C/X-SAR, TIMS, TOMS, and TOPSAR. The radar data sets from ERS-1/2, SIR-C/X-SAR, and TOPSAR provide baseline topography for individual volcanoes which can be compared to future EOS digital elevation models derived from ASTER and MISR, as well as the Shuttle Radar Topography Mission (SRTM).

Different orbital radar instruments are being used to gain experience in studying temporal changes of volcanoes. ERS-1/2 and SIR-C/X-SAR data are being used to develop experience in handling large volumes of data and in working with on-going missions. HIRS is used as an analog for MODIS, and TIMS (an aircraft instrument similar to the thermal-infrared portion of ASTER) is being used for temperature studies as well as the development of algorithms for mapping tropospheric SO₂. Four versions of the TOMS instrument have been flown on satellites since 1978 and these have been routinely used to estimate amounts of SO₂ released by volcanic eruptions. The EP-TOMS has proven to be particularly useful (by virtue of its relatively low-altitude orbit) for studying tropospheric SO₂ from volcanoes. The MLS on UARS provided experience in the interpretation of daily global maps of SO₂ that started 3 months after the eruption of Pinatubo.

In order to observe eruptions while they are still in progress, this EOS investigation has already contributed significantly to the development of a near-real-time response capability. Automatically generated alarms for hot lava flows will be produced continuously from the MODIS data stream and will be placed on our Web site. Such a capability is expected to be of benefit to numerous other studies of transient phenomena, particularly forest fires, since they too will be mapped each day. Higher order data sets that document the characteristics of specific eruptions, the height and dispersal of eruption plumes, and the geology of individual volcanoes will be the primary archival products. These thermal alarms and other data products will be maintained locally on our Web site for access by the volcanology community at large.

Participation in Field Programs

Our team is heavily involved in several field programs related to the analysis of the 15 International Decade Volcanoes, as well as on-going studies of other active volcanoes around the world. We helped organize Decade Volcano Workshops at Santa Maria (Guatemala) in 1993 and a workshop at Taal (Philippines) in 1995. Planning is currently underway to collaborate with the Filipinos in the study of Mt. Pinatubo and Canlaon volcanoes as part of NASA's PacRim studies. We have also experimented with the use of Fourier Transform and other thermal IR sensors to monitor SO₂ and HCl at Mt. Etna (Sicily). In 1996, we participated in the NASA aircraft deployment to New Zealand to map some of the volcanoes and perform volcanic gas studies. These programs are multi-disciplinary, involving the measurement of volcanic gases, surface temperatures, ground deformation, and topography. Mapping, using satellite and aircraft data, is also conducted in the Andes of Chile, the Philippines, and the Galapagos Islands, while synoptic radar data are employed to study volcanoes in Central Africa.

Principal Investigator

Peter J. Mouginis-Mark

Peter Mouginis-Mark received his training in environmental sciences (Ph.D. from Lancaster University, England, 1977). He has concentrated his research experience on volcanic phenomena, planetary geology, and remote sensing. He has been associated with the University of Hawaii since 1982, and now is a member of the Hawaii Institute of Geophysics and Planetology. Mouginis-Mark has been actively involved in many NASA and foreign Earth orbital missions, particularly in the field of radar remote sensing. He is currently the Chair of the Commission on Remote Sensing of Volcanoes for the International Association of Volcanology and Chemistry of the Earth's Interior (IAVCEI), and is a former member of NASA's Earth System Science and Applications Advisory Committee (ESSAAC). He also has a strong commitment to space science education and is Program Director for Remote Sensing for the NASA Hawaii Space Grant Consortium.

Co-Investigators

John Adams - *University of Washington*

Joy A. Crisp - *Jet Propulsion Laboratory (Deputy Team Leader)*

Luke P. Flynn - *University of Hawaii*

Peter W. Francis - *Open University, England*

Lori S. Glaze - *Proxemy Research, Inc.*

Jonathan Gradie - *TerraSystems, Inc.*

Kenneth Jones - *Jet Propulsion Laboratory*

Anne B. Kahle - *Jet Propulsion Laboratory*

Arlin Krueger - *NASA/Goddard Space Flight Center*

Fred Prata - *CSIRO-DAR, Australia*

David C. Pieri - *Jet Propulsion Laboratory*

Virce Realmuto - *Jet Propulsion Laboratory*

William I. Rose - *Michigan Technological University*

Stephen Self - *University of Hawaii*

Louis S. Walter - *George Washington University*

Lionel Wilson - *Lancaster University, England*

Charles A. Wood - *University of North Dakota*

Howard A. Zebker - *Stanford University*

References

- Flynn, L.P., and P.J. Mouginiis-Mark, 1995: Thermal characteristics of active lava flows and forest fires. *Geophys. Res. Lett.*, **22**, 2577-2580.
- Glaze, L.S., L. Wilson, and P.J. Mouginiis-Mark, 1999: Volcanic eruption plume top topography and heights as determined from photoclinometric analysis of satellite data. *J. Geophys. Res.*, **104**, 2989-3001.
- Holasek, R.E., S. Self, and A.W. Woods, 1996: Satellite observations and interpretation of the 1991 Mount Pinatubo eruption plumes. *J. Geophys. Res.*, **101**, 27,635-27,655.
- Kahle, A., M.J. Abrams, E.A. Abbott, P.J. Mouginiis-Mark, and V.J. Realmuto, 1995: Remote sensing of Mauna Loa. Mauna Loa Revealed: Structure, Composition, History, and Hazards. *American Geophysical Union Monograph No. 92*, 145-170.
- Krueger, A.J., L.S. Walter, and C.C. Schnetzler, 1996: The December 1981 eruption of Nyamuragira Volcano (Zaire) and the origin of the "mystery cloud" of early 1982. *J. Geophys. Res.*, **101**, 15,191-15,196.
- Prata A.J., and P.J. Turner, 1997: Cloud-top height determination using ATSR data. *Remote Sens. Environ.*, **59**, 1-13.
- Realmuto, V.J., A.J. Sutton, and T. Elias, 1997: Multi-spectral thermal infrared mapping of sulfur dioxide plumes—a case study from the East Rift Zone of Kilauea Volcano, Hawaii. *J. Geophys. Res.*, **102**, 15,057-15,072.
- Rose, W.I., D.J. Delene, D.J. Schneider, G.J.S. Bluth, A.J. Krueger, I. Sprod, C. McKee, H.L. Davies, and G.G.J. Ernst, 1995: Ice in Rabaul eruption cloud of 19-21 September 1994. *Nature*, **375**, 477-479.
- Self, S., and P.J. Mouginiis-Mark, 1995: Volcanic eruptions, prediction, hazard assessment, and remote sensing. U.S. National Report to the IUGG, 1991-1994, *Revs. Geophys. Suppl.*, July 1995, 257-262.
- Zebker, H.A., P.A. Rosen, S. Hensley, and P.J. Mouginiis-Mark, 1996: Analysis of active lava flows on Kilauea Volcano, Hawaii, using SIR-C radar correlation measurements. *Geology*, **24**, 495-498.
- Zebker H.A., P.A. Rosen, and S. Hensley, 1997: Atmospheric effects in interferometric synthetic aperture radar surface deformation and topographic maps. *J. Geophys. Res.*, **102**, 7547-7563.

Investigation URL

<http://www.geo.mtu.edu/eos/>

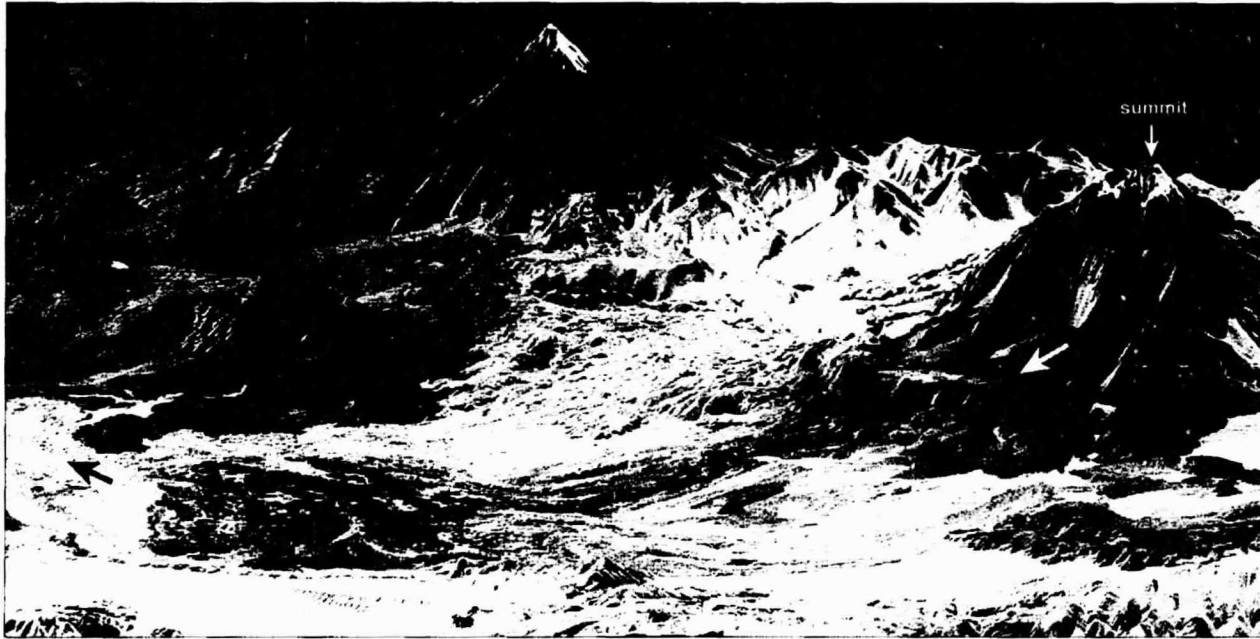

Studying the eruptive characteristics and topography of volcanoes will be greatly aided by EOS-Era instruments. ASTER, MODIS, Landsat 7, SRTM and VCL will be used routinely by the Volcanology IDS Team to study on-going activity, as well as the geology and geomorphology of volcanoes around the world. This image is of Socompa volcano, NE Chile, which is over 6,050 m high. Landsat Thematic Mapper data were combined with a digital elevation model derived from ERS-2 radar interferometry to study the flow dynamics of a giant landslide deposit. Arrows show the direction of flow of the landslide. This landslide, which resulted from an eruption similar to the 1980 activity at Mt. St. Helens, formed when part of the summit collapsed sometime between 500 to 10,000 years ago. The resultant deposits cover about 490 km², and have a minimum volume of 15 km³. Image courtesy of Mary MacKay and Harold Garbeil, University of Hawaii.

Synoptic Analysis of Factors Influencing Carbon Fluxes at a Continental Margin Time Series: CARIACO

Principal Investigator – **Frank E. Muller-Karger**

Science Background

Over geological time scales, geochemical imbalances at the Earth's surface are closely tied to carbon sequestration by marine organisms. However, whether the ocean helps mitigate the increase of anthropogenic greenhouse gases over shorter time scales (years to decades), represents one of the most pressing questions in ocean biogeochemistry. The question is relevant because even though the global carbon budget could be balanced if the terrestrial biosphere were a net sink, at present there is a net flux of $\sim 3.25 \times 10^{15} \text{ gC y}^{-1}$ from the land biosphere to the atmosphere. Current biosphere models are inadequate because they use coarse grids to increase efficiency and because they are constrained by averages of scarce ocean data, which are primarily derived from the ocean's interior. Also, we still don't understand uncertainties associated with processes that control the fluxes of key elements.

While much of the attention in oceanography over the past 100 years has focused on the deep ocean, now there is increasing evidence that ocean margins play a key role in the global carbon budget. Annual new production integrated over the world's continental shelves and slopes (a total of $5.8 \times 10^7 \text{ km}^2$) is estimated to be about $3.7 \times 10^{15} \text{ g Carbon}$. This is over 56% of the total global new oceanic production. The importance of this flux lies in its efficient sequestration of elements, i.e., particles that take up carbon from the surface of the ocean take it with them as they sink. This carbon can be stored for long periods in deep waters or in the sediment. This "biological pump" is more significant along continental margins than in the ocean's interior, since the mean particle flux at 2,300 m is $\sim 7.0 \text{ gC m}^{-2} \text{ y}^{-1}$, compared to $\sim 0.8 \text{ gC m}^{-2} \text{ y}^{-1}$ at 2,300 m in the deep sea. These issues lie at the core of the role of oceanic moderation of atmospheric CO_2 and other greenhouse gases.

Recent evidence suggests that the tropical Atlantic, and particularly the Caribbean Sea, may function as barometers of global change. The Caribbean experiences the most marked of the El Niño teleconnections in the Atlantic Ocean. During El Niño, the Trade Winds tend to blow more to the NNW rather than to the ESE, and warmer sea-surface temperatures (SSTs) are observed in the Caribbean. Changes in solar irradiance also lead to SST variations which are in phase in tropical regions, but out of phase in extratropical regions. Global ocean changes are

therefore dominated by changes in the tropics, and changes in irradiance accentuate the response of tropical regions. Along margins, natural and anthropogenic perturbations may have an amplified effect because of vigorous exchange processes between land, atmosphere, and the ocean.

The Cariaco Basin is a depression on the continental shelf of the southern Caribbean Sea ($10^\circ 20' \text{N}$, $64^\circ 10' \text{W}$, $11^\circ 00' \text{N}$, $66^\circ 10' \text{W}$). It consists of two main sub-basins, each about 1400 m deep, separated by a saddle at about 900 m depth off the coast of Venezuela. The basin is bound to the north by a sill that allows free exchange of water with the open ocean above about 100 m, but which isolates waters below this depth. Therefore, the Cariaco Basin forms a natural sediment trap embedded within a continental shelf. This is the only permanently anoxic basin in the world's oceans, and serves as an oceanic analog of the Black Sea. In Cariaco, the effects of external oceanic variability (i.e., in the Atlantic Ocean and Caribbean Sea) are preserved for decades in the water column and more permanently within the sediments. We chose the Cariaco Basin for this study because of these characteristics.

Science Goal

This study seeks to quantify the influence of large-scale phenomena on the partitioning of carbon into various pools at a continental-margin time-series site. Of specific interest is the particulate carbon flux that sinks to deeper waters and that is deposited as sediment, since it may represent long-term removal of carbon from the atmosphere. The primary goal is to assess whether phenomena in the Western Atlantic have a significant effect on processes such as the vertical flux of nutrients, river discharge, or sea-surface temperature, and their interaction on the partitioning of carbon into various pools, including carbon uptake and deposition, in the Cariaco Basin. We seek to understand which oceanographic processes are most relevant to components of the carbon budget at this site.

Current Activities

To address the connection between surface oceanographic processes and sediment flux to deep waters, the National Science Foundation, in collaboration with the Consejo Nacional de Investigaciones Científicas y Tecnológicas

(CONICIT, Venezuela), implemented a program of observations in the Cariaco Basin in November 1995. This cooperative, multidisciplinary program is referred to as CARIACO (CARbon Retention In A Colored Ocean). CARIACO is part of the NASA SIMBIOS program (Sensor Intercomparison and Merger for Biological and Interdisciplinary Oceanic Studies) for satellite ocean-color product validation. Similar programs only exist at two deep-water oceanic stations, Bermuda and Hawaii, but CARIACO addresses continental margins issues.

CARIACO is now incorporated into the "Synthesis and Modeling Project" (SMP) of the U.S. Global Ocean Flux Study (U.S. JGOFS) through the NASA EOS Interdisciplinary Science Investigation program. This EOS activity will integrate synoptic observations from satellite platforms into the ongoing field data collection, synthesis, and modeling efforts conducted at the CARIACO continental-margin time-series station. It will also incorporate a strong education component with national and international graduate students, research associates, and middle-and high-school teachers.

Our measurements to date have captured three cycles of seasonal upwelling in the Cariaco Basin. We estimate that Net Primary Production (NPP) would normally be of the order of 450 g C/m²/yr, which compares with a vertical flux of 22.6 g C/m²/yr at 260 m depth and 8.25 g C/m²/yr at 1250 m. Our observations suggest, however, that very brief (~2 weeks) punctuated production events raise productivity as high as 615 g C/m²/yr. These events would normally be missed in one-time survey programs, but are captured in the satellite and field-observation time-series programs.

Use of Satellite Data

We use regional and basin-scale ocean color, infrared, scatterometer, and selected altimeter observations to study spatial and temporal variability of parameters that influence the distribution of phytoplankton, primary productivity, dispersal of dissolved organic matter, and the vertical flux of organic material. The satellite data are a rich source of information that can be used to pinpoint the upwelling foci, circulation patterns, and the relationship between local phenomena and processes acting upstream in the Atlantic Ocean and Caribbean Sea. Ocean-color data from the CZCS and SeaWiFS sensors, and future data from MODIS, help us study phytoplankton biomass fields and the dispersal pattern of river plumes. AVHRR and future MODIS data provide us with local and global estimates of the sea-surface temperature, a parameter that is critical in defining circulation and areas of nutrient supply. Scatterometer data (NSCAT, QuikSCAT, SeaWinds, ERS-1, ERS-2) provide at least once per day and frequently twice per day coverage of global/regional winds. These allow us to better understand the dispersal of cold waters and pigment. With TOPEX/Poseidon data, we have

started an analysis of variability in the sea-surface elevation of the Caribbean Sea and the adjacent Western Atlantic Ocean. These data will be compared with local tide-gauge observations to define whether variation seen in sea level along the coast is due to transient eddies, wind set-up during the upwelling process, or steric (density-related) height changes.

Participation in Field Activities

Our approach to understanding variability in the sediment record in the Cariaco Basin is to study the relationship between the sinking flux of particles (measured with moored sediment traps) and variability in present-day oceanographic conditions (measured with electronic probes or discrete samples from a ship). Our results show that to interpret sediment-trap samples, each of which represents a 2-week integration of the sinking flux, hydrographic and primary productivity observations are required at least monthly. The field component focuses on primary production, phytoplankton biomass, hydrography, nutrient, and dissolved inorganic carbon observations on a monthly basis, on cruises lasting 1.5 days. These monthly measurements are needed to support the basic objectives of the sediment-trapping component, and are required to interpret changes in bacterial community productivity and respiration. Two of the 1.5-day cruises are extended to 4 days during upwelling maxima and minima periods, respectively, each year. The objective is to study spatial variability around our single monthly station located at 10.5° N, 64.66° W and map the three-dimensional structure of the upwelling plume. Our profiling conductivity-temperature-depth (CTD) probe is equipped with both a fluorometer configured to detect chlorophyll and with a c-beam transmissometer (660 nm). This combination of instruments helps us detect and map the three-dimensional structure of the phytoplankton bloom and differentiate it from any possible submerged sediment plume extending from the continental margin.

Principal Investigator

Frank E. Muller-Karger

Frank E. Muller-Karger received his Ph.D. in Marine and Estuarine Sciences in 1988 from the University of Maryland. He has an M.S. in Biological Oceanography from the University of Alaska (1984), and a B.S. in Biological Oceanography from the Florida Institute of Technology (1979). Muller-Karger was a NASA Graduate Student Trainee at the Goddard Space Flight Center between 1985 and 1988 and a post-doctoral fellow at the University of South Florida in 1988. He joined the faculty at the University of South Florida in 1989 where he serves as Associate Professor tenured in the Department of Marine Science. Muller-Karger acted as Program Scientist for Ocean Biogeochemistry at NASA Headquarters, in this rotating

position, between 1992 and 1994. His research focuses on remote sensing of continental margins, including application of visible- and infrared-satellite data to understanding fluxes of elements between land, the ocean surface, and the ocean bottom. Among awards he has received are NASA's Jet Propulsion Laboratory Award for Outstanding Contributions in 1996, the NASA Administrator's Award for Exceptional Contribution and Service in 1995, the American Geophysical Union (AGU) Sea Scholar award (1987-1988), and the American Geological Institute's Minority Participation Program Scholarship (1987-1988).

Co-Investigators

Ramon Varela - *Fundacion La Salle de Ciencias Naturales Estacion de Investigaciones Marinas Isla Margarita, Venezuela*

John J. Walsh - *University of South Florida*

Robert Thunell - *University of South Carolina*

Mary Scranton - *State University of New York*

Gustavo Ruiz - *Fundacion Instituto Ingenieria Universidad Simon Bolivar, Venezuela*

Linwood Jones - *University of Central Florida*

References

- Ballester, A., and R. Margalef, 1965: Produccion primaria. Memoria. *Sociedad de Ciencias Naturales La Salle*, XXV:(70, 71, 72), 209-221.
- Berner, R. A., 1992: Comments on the role of marine sediment burial as a repository for anthropogenic CO₂. *Global Biogeochem. Cycles*, 6, 1-2.
- Brewer, P. G., 1986: What controls the variability of carbon dioxide in the surface ocean? A plea for complete information. Dynamic Processes in the Chemistry of the Upper Ocean. J. D. Burton, P.G. Brewer, and R. Chesselet, Eds., Plenum, NY. pp. 215-231.
- Deuser, W.G., F.E. Muller-Karger, R.H. Evans, O.B. Brown, W.E. Esaias, and G.C. Feldman, 1990: Surface-ocean color and deep-ocean carbon flux: how close a connection? *Deep-Sea Res.*, 37, 1331-1343.
- Enfield, D.B., and D.A. Mayer, 1997: Tropical Atlantic sea surface variability and its relation to El Niño-Southern Oscillation. *J. Geophys. Res.*, 102, 929-945.
- GOFS. 1987. U.S. Global Ocean Flux Study: Ocean Margins in GOFS. Report of the workshop on The Impact of Ocean Boundaries on the Interior Ocean, March 10-12, 1987. Chairman: George A. Knauer. U.S. GOFS Planning Report Number 6. Woods Hole Oceanographic Institution. 245 pp.
- Hochman, H.T., F.E. Muller-Karger, and J.J. Walsh, 1993: Interpretation of the Coastal Zone Color Scanner (CZCS) signature of the Orinoco River. *J. Geophys. Res.*, 99, 7443-7455.
- Jahnke, R.A., 1996: The global ocean flux of particulate organic carbon: Areal distribution and magnitude. *Global Biogeochem. Cycles*, 10, 71-88.
- Longhurst, A R., 1991: Role of the marine biosphere in the global carbon cycle. *Limn. and Ocea.*, 36, 1507-1526.
- Melillo, J.M., T.V. Callaghan, F.I. Woodward, E. Salati, and K. Sinha, 1990: Effects on ecosystems, p. 283-310, in: J. T. Houghton et al. [eds.], *Climate Change - the IPCC scientific assessment*. Cambridge.
- Muller-Karger, F.E., and R. Aparicio, 1994: Mesoscale Processes Affecting Phytoplankton Abundance in the Southern Caribbean Sea. *Continental Shelf Res.*, 14, 199-221.
- Muller-Karger, F.E., C.R. McClain, T.R. Fisher, W.E. Esaias, and R. Varela, 1989: Pigment distribution in the Caribbean Sea: observations from space. *Progress in Oceanography*, 23, 23-69.
- Muller-Karger, F.E., C.R. McClain, and P.L. Richardson, 1988: The dispersal of the Amazon's water. *Nature*, 333, 56-59.
- Peterson, L.C., J.T. Overpeck, N.G. Kipp, and J. Imbrie, 1991: A high-resolution late quaternary upwelling record from the anoxic Cariaco Basin, Venezuela. *Paleoceanography*, 6, 99-119.
- Richards, F.A., and R.F. Vaccaro, 1956: The Cariaco Trench, an anaerobic basin in the Caribbean Sea. *Deep-Sea Res.*, 3, 214-228.
- Walsh, J.J., 1988: On the nature of continental shelves. Academic Press, San Diego. pp. 1-520.
- Zhang, J.Z., and F.J. Millero, 1993: The chemistry of the anoxic waters in the Cariaco Trench. *Deep Sea Res.*, 40, 1023-1041.

Investigation URL

<http://paria.marine.usf.edu>

Investigation of the Atmosphere-Ocean-Land System Related to Climate Processes

Principal Investigator – **Masato Murakami**
International Sponsor – **Japan**

Science Background

It has been widely recognized that the observed long-term, climatic variations should be understood in the framework of an integrated atmosphere-ocean-land system. The atmosphere, ocean, and land interact with each other through the exchanges of heat energy, momentum, and water substance, while each subsystem undergoes changes following its own internally determined physical processes. One example can be seen in the relationship between the tropics and the global climate. The tropics act as heat source regions which drive the global atmospheric circulation. Recent observational and theoretical studies have revealed that the long-term variations of tropical heat sources play an important role in the climatic variability of the global atmospheric circulation, e.g., such phenomena as El Niño and the Southern Oscillation (ENSO).

The atmospheric circulation changes affect the oceanic circulation through the changes in wind stress at the sea surface. On the other hand, it is also known that the variations of the tropical heat sources are closely associated with the variations of sea surface temperature (SST) through the process of heat exchange. In addition, the circulation changes also cause changes of the soil moisture and snow cover over land. Recently, investigations have shown increasing evidence that changes in land-surface conditions affect the variation of the large-scale atmospheric circulation features such as monsoons.

The preceding discussion serves to illustrate the importance of our understanding of the integrated behavior of the Earth system. There are other important components to be taken into account when we try to understand and predict climatic changes. For instance, the effects of atmospheric minor constituents on the global climate should be investigated by both observational and modeling studies.

Science Goal

The goal of this investigation is to perform a comprehensive investigation of the atmosphere-ocean-land system by pursuing seven different subjects (described in the next section) including both observational and modeling studies.

Current Activities

This investigation provides a mixture of observational studies and climate modeling related to the atmosphere-ocean-land interactions that occur through heat and momentum exchanges. The investigation has three components. First, researchers will develop algorithms for the objective identification of cloud types and the quantitative measurement of precipitation. Data validation of newly developed remote-sensing techniques will also be carried out. Based on these products, observational studies will be conducted to examine the atmospheric systems associated with various rainfall activities. The role of atmospheric minor constituents in climate changes will also be examined. Secondly, researchers will monitor climatic changes of the sea-surface temperature, sea level, and sea-surface wind through the use of satellite observations, eventually generating data sets that can be incorporated in the ocean modeling study of seasonal/interannual variations of the Pacific and the mid-latitude eddies of the ocean. Finally, researchers will examine land-surface conditions, such as ground wetness and snow mass.

An atmospheric general circulation model (GCM) will be incorporated to evaluate the impact of anomalous surface conditions on climate change. Project elements will exchange results and data with other elements under the direction of the Principal Investigator to ensure overall understanding of the Earth system.

The seven supporting studies being conducted by the Meteorological Research Institute (MRI) of the Japan Meteorological Agency (JMA) are as follows: 1) measurement of precipitation and analysis of rain-producing systems; 2) study of the climatic and environmental changes affected by the increase of greenhouse gases; 3) ozone chemistry; 4) validation of EOS data by use of MRI lidar and JMA data; 5) monitoring of the ocean from satellites; 6) ocean modeling study; and 7) analysis of the changes of surface conditions in the vicinity of Japan, and studies of their impact on atmospheric circulations with the use of the MRI GCM.

Use of Satellite Data

In the atmospheric part of this study we plan to delineate the convective activity (heat sources) and moisture fields

at relatively fine spatial resolution with the combination of data from AIRS, MODIS, and HSB. We have been using AVHRR to estimate rainfall from cumulus-type clouds. The technique uses classification by the split-window technique in conjunction with radar and rain gauge observations. The technique will be tuned to retrieve total precipitable water from the split window and passive microwave data, comparing results with radiosonde observation data. We will also intercompare the passive microwave retrieval and split-window retrieval methods for rainfall estimation and also for water-vapor estimation over cloud-free regions. During the early stage of EOS, intercomparisons with AIRS, ASTER, MODIS, HSB, and AMSR-E will be carried out. In the oceanic part of this study, efforts will be concentrated in developing algorithms for retrieving and validating the following geophysical parameters: SST, sea level, and latent heat flux. Algorithms for retrieving SST with AMSR-E will be developed.

Principal Investigator

Masato Murakami

Masato Murakami was academically trained in Geophysics and Meteorology at the University of Tokyo, and earned his S. Sc. from that institution in 1974. Except for a 2-year position at Florida State University, Murakami has been affiliated with the Meteorological Research Institute for his entire professional career. Currently, he is Chief of Laboratory in the Typhoon Research Division. His research interests include tropical, monsoon, and satellite meteorology. He is acting as a WMO rapporteur on the Asian/African monsoon program and is engaged in the project management of JEXAM (Japanese Experiment of Asian Monsoon).

Co-Investigators

The following co-investigators are from the Meteorological Research Institute

Tadao Aoki
Masahiro Endoh
Toshifumi Fujimoto
Masashi Fukabori
Toshiro Inoue
Masafumi Kamachi
Y. Kitamura
Akio Kitoh
Yukio Makino
Tetsuo Nakazawa
Toru Sasaki
Akira Shibata
Kenzo Shuto
Masato Sugi
Tatsahi Tokioka

Osamu Uchino
Isamu Yagai
Koji Yamazaki

References

Chen, T.C., and M. Murakami, 1988: The 30-50 day variation of convective activity over the western Pacific Ocean with emphasis on the northwestern Pacific Ocean. *Mon. Wea. Rev.*, **116**, 892-906.

Murakami, M., 1992: The equatorial convective activity and its variation. Technical Note, *J. Meteor. Soc.*, **176**, 63-72 (in Japanese).

Murakami, M., and K. Takahashi, 1993: The large scale convective activity over the equatorial Pacific and the SPCZ. *Kaiyo Monthly*, **No.5**, 33-39 (in Japanese)

Takayabu, T.N., and M. Murakami, 1991: The structure of super cloud clusters observed in 1-20 June 1986 and their relationship to easterly waves. *J. Meteor. Soc. Japan*, **69**, 105-125.

Yamazaki, N., and M. Murakami, 1989: An intraseasonal amplitude modulation of the short-term tropical disturbances over the western Pacific. *J. Meteor. Soc. Japan*, **67**, 791-807.

Investigation URL

<http://www.mri-jma.go.jp>

Evaluation and Comparison of Global Three-dimensional Marine Carbon Cycle Models

Principal Investigator – **Raymond G. Najjar**

Science Background

Understanding the processes that control the amount of carbon dioxide in the atmosphere is critical to our success in making predictions about future climate. The oceans play a major role in determining atmospheric CO₂ because the oceans exchange rapidly with the atmosphere and because the oceans contain about 65 times more carbon than the atmosphere. Currently, the oceans are believed to be absorbing about 1-2 billion tons of carbon per year from the atmosphere, a substantial fraction of the CO₂ added to the atmosphere by fossil fuel burning.

Numerical models of the marine carbon cycle are essential for making predictions of atmospheric CO₂. Such models have not been exhaustively evaluated with observations, which are needed in order to determine their credibility. What does seem clear is that existing models do differ greatly from each other. These differences, in combination with evaluation of the models, could be exploited in order to improve the models and make them more suitable for the prediction of atmospheric CO₂ in the future.

In 1995, the Ocean Carbon-cycle Model Intercomparison Project (OCMIP) was initiated. Its goals were to improve the ability of marine carbon cycle models to simulate the uptake and storage of carbon dioxide. Through carefully designed simulations, the causes of model differences were determined. There is still a need, however, to evaluate these models thoroughly with observations in order to determine model weaknesses and accelerate model development. Furthermore, a limited set of simulations was made which did not include the natural marine carbon cycle.

Science Goal

We have proposed to carry OCMIP to its next phase, which will include a more-extensive suite of simulations (including the natural marine carbon cycle), a greater diversity of modeling groups, and exhaustive evaluation of models with observations. The overall goal is the same as the original aims of OCMIP—to improve marine carbon cycle models.

Use of Satellite Data

Satellite ocean color data measured from SeaWiFS will be critical for evaluating models of the natural marine carbon cycle. SeaWiFS will provide information on chlorophyll concentrations and primary productivity, two important measures of biological cycling in the upper ocean that affects the carbon budget.

Participation in Field Activities

Data have already been collected for evaluating the models from programs such as JGOFS and WOCE. There is also a rich historical data set that will be exploited. Therefore, no field measurements are proposed for this project.

Principal Investigator

Raymond G. Najjar

Raymond Najjar is an assistant professor in the Departments of Meteorology and Geosciences at the Pennsylvania State University. His research interests are mainly associated with the role of the oceans in the Earth system, particularly in the area of global biogeochemical cycles.

Co-Investigators

Ken Caldeira - *Lawrence Livermore National Laboratory*

Scott Doney - *National Center for Atmospheric Research*

Mick Fellows - *Massachusetts Institute of Technology*

Robert Key - *Princeton University*

John Marshall - *Massachusetts Institute of Technology*

Christopher Sabine - *Princeton University*

Jorge Sarmiento - *Princeton University*

Investigator URL

<http://www.meto.umd.edu/MISSIONS/tropoconv.htm>

Tropospheric Convection and Stratosphere-Troposphere Exchange: Effects on Photochemistry, Aerosols, and Climate

Principal Investigator · Kenneth E. Pickering

Science Background

Deep convection and stratosphere-troposphere exchange (STE) processes cause substantial changes in the vertical profiles of trace gases and aerosols which, in turn, have effects on the actinic flux and on the radiative forcing of climate. For example, convective transport of ozone precursors leads to enhanced photochemical ozone production in the upper troposphere. These transport processes develop on small spatial scales, but are globally important and strongly influence the budgets of many species. However, these smaller-scale hydrodynamical effects and nonhydrostatic motions are typically not well represented in state-of-the-art global climate models (GCMs). For example, considerable uncertainty is associated with parameterization of deep convection in GCMs. A variety of other models, submodels, and algorithms are available to evaluate convection and STE in a GCM and to further enhance the GCM. Our investigation covers modeling and data analysis efforts to improve understanding of coupling processes between atmospheric chemistry and climate. We address two major elements of the EOS Science Strategy: 1) clouds, radiation, water vapor, and precipitation; and 2) greenhouse gases and tropospheric chemistry.

Science Goals

The major goals of our work are to: 1) examine the effects of vertical mixing processes such as deep convection and STE on photochemically active trace gases and aerosols and the resulting effects on radiative forcing of climate; and 2) determine the ability of global chemical transport models to accurately represent these vertical mixing processes at various model resolutions. To address these objectives we are enhancing the Goddard Chemical Transport Model (GCTM) to operate with a variable resolution grid and with a tropospheric chemical scheme, with the ultimate goal of coupling the transport model with the stretched-grid version of the Goddard Earth Observing System (GEOS) GCM and performing experiments with the coupled system. In addition, we are adding a chemical scheme to the Goddard Cumulus Ensemble (GCE) Model. This cloud-resolving coupled system will be used to evaluate the parameterized convection in the global model in simulations of observed case-study ver-

tical-mixing events. The combination of models will allow estimation of the effects of mixing events on global chemical budgets and radiative heating. The sensitivity of global chemical budgets and related climate characteristics to uncertainties in model description of convection and STE will be estimated.

Current Activities

Our work to date has centered on five areas: 1) modification of the advection scheme in the GCTM to allow calculation of transport on a stretched grid; 2) incorporation of the Sparse-Matrix Vectorized Gear code (SMVGEAR II) chemical solver and chemical mechanism into the GCTM; 3) development and use of a single-column CTM for testing chemical mechanisms and for case-study analysis; 4) development of methods for calculating aerosol and cloud effects on photolysis rates; and 5) preparation for case-study simulations.

In our transport experiments the continuity equation for trace gases will be solved on a nonuniform grid generated automatically within the chemical transport model. The grid is chosen so that its resolution is uniform and maximum in the region of interest (e.g., the region of a field experiment); the grid spacing increases gradually outside of the region with the coarsest resolution occurring on the opposite side of the globe. The advantages of this approach include improved accuracy in transport and photochemical calculations in the region of interest and avoidance of boundary problems that develop in nested-grid models. The stretched-grid CTM is designed to be compatible with the Stretched-grid GEOS GCM, which is under development with separate funding. The modified advection scheme is currently being tested through a series of Rn-222 tracer experiments. Model runs are being conducted using a uniform grid (2×2.5 -degree resolution) and with the modified scheme, with a stretched grid focused over North America and the North Atlantic. Results are being compared with observed Rn-222 at Bermuda.

We are coupling the Stretched-grid GCTM with the high-speed SMVGEAR II chemical solver. Initially, we are using the Jacobson chemical scheme which includes three different reaction sets (urban, free troposphere, and stratosphere). Other reaction schemes will also be tested.

We have developed a single-column CTM, which describes the vertical mixing processes exactly as in the GCTM. It can be driven by the GEOS-1 assimilated data for a particular region and can be used for case-study analysis and interpretation of field observations. We are using the column CTM for comparing model results with observations as a test of the chemistry schemes for polluted air and for clean marine-boundary-layer conditions.

We are using the discrete-ordinate radiative transfer model (DISORT) for calculations of actinic flux, and in combination with molecular properties, we are computing a full set of photolysis rates for use in the CTM. Use of DISORT will allow consideration of the effects of aerosol and cloud properties on photolysis rates. We have focused on the July 15, 1995 high-ozone episode along the east coast of the U.S. In this preliminary study of the effects of observed aerosol on tropospheric ozone production, we have computed enhanced ozone production rates associated with scattering sulfate aerosol and decreased production with absorbing aerosols such as soot or dust.

We are preparing for upcoming simulations with the Stretched-grid GCTM for cases of observed convective mixing and/or STE. The first convective simulation that will be conducted with the model will be for a period of the Kansas-Oklahoma PRE-STORM experiment of 1985. A wealth of meteorological and chemical data is available from this experiment, and we have already performed simulations of individual convective events from this experiment with the GCE model. Stretched-grid GCTM calculations will be performed for the April 1996 AEROCE field-campaign period. In this work we will examine the relative role of photochemical production, deep convection over land, and transport from the stratosphere in determining ozone mixing ratios over the North Atlantic Ocean. Major convective episodes have been detected in the 1994 MAPS CO data. We will also simulate these periods with the Stretched-grid GCTM.

The Stretched-grid GEOS GCM, while still under development, has been successfully run with the dynamics computed on the stretched grid and the physical packages computed with a uniform grid of intermediate resolution. Use of winds, temperatures, convective mass fluxes, and diffusion coefficients from this version of the GCM with high regional spatial resolution of the dynamics will allow us to account for the effects of small-scale vertical mixing on chemical processes. When this GCM is completed, we will couple the GCM with the Stretched-grid CTM and conduct experiments with the coupled system for vertical mixing events.

Use of Satellite Data

Because CO is an excellent tracer of convective transport, the MAPS CO data will be very useful for the proposed simulations. Similarly, after Terra launch, MOPITT

CO will also be extremely valuable. TOMS total ozone data will be used in the calculation of photolysis rates, and TOMS-derived tropospheric ozone will be used in tropical case studies. CERES, MODIS, and ASTER cloud products will be used in model verification.

Participation in Field Programs

Pickering and Stenchikov participated in the STERAO-A deep convection experiment in Colorado in 1996. Pickering also took part in the NASA/GTE/TRACE-A mission in 1992 and in the 1997 NASA/AEAP/SONEX mission. Deep convection was an important process affecting the measurements in both of these experiments. Dickerson is a key participant in the AEROCE and INDOEX field missions.

Principal Investigator

Kenneth E. Pickering

Kenneth Pickering is an atmospheric scientist who is a research faculty member in the Department of Meteorology at the University of Maryland. He received his B.S. degree from Rutgers University and an M.S. from the State University of New York at Albany. Pickering worked in private consulting in the air pollution meteorology field, and subsequently earned his doctoral degree in Meteorology from the University of Maryland in 1987. Following completion of his doctoral work, he was a Visiting Scientist at the NASA/Goddard Space Flight Center where he studied the effects of deep convection on free tropospheric ozone production through the use of convective transport and photochemical models. He joined the Joint Center for Earth System Science (a joint University of Maryland and NASA/GSFC research institute) in 1994.

Co-Investigators

Georgiy L. Stenchikov - *Rutgers/State University of New Jersey*

Dale J. Allen - *University of Maryland*

Russell R. Dickerson - *University of Maryland*

Michael S. Fox-Rabinovitz - *University of Maryland*

Robert D. Hudson - *University of Maryland*

Wei-Kuo Tao - *NASA/Goddard Space Flight Center*

References

Dickerson, R.R., S. Kondragunta, G. Stenchikov, B. Doddridge, W.F. Ryan, and B. Holben, 1997: The impact of aerosols on photochemical smog production. *Science*, **278**, 827-830.

Fox-Rabinovitz, M.S., G.L. Stenchikov, M.J. Suarez, and L.L. Takacs, 1997: A finite-difference GCM dynamical core with a variable-resolution stretched grid. *Mon. Weather Rev.*, **125**, 2943-2968.

Investigation URL

<http://www.meto.umd.edu/MISSIONS/tropoconv.htm>

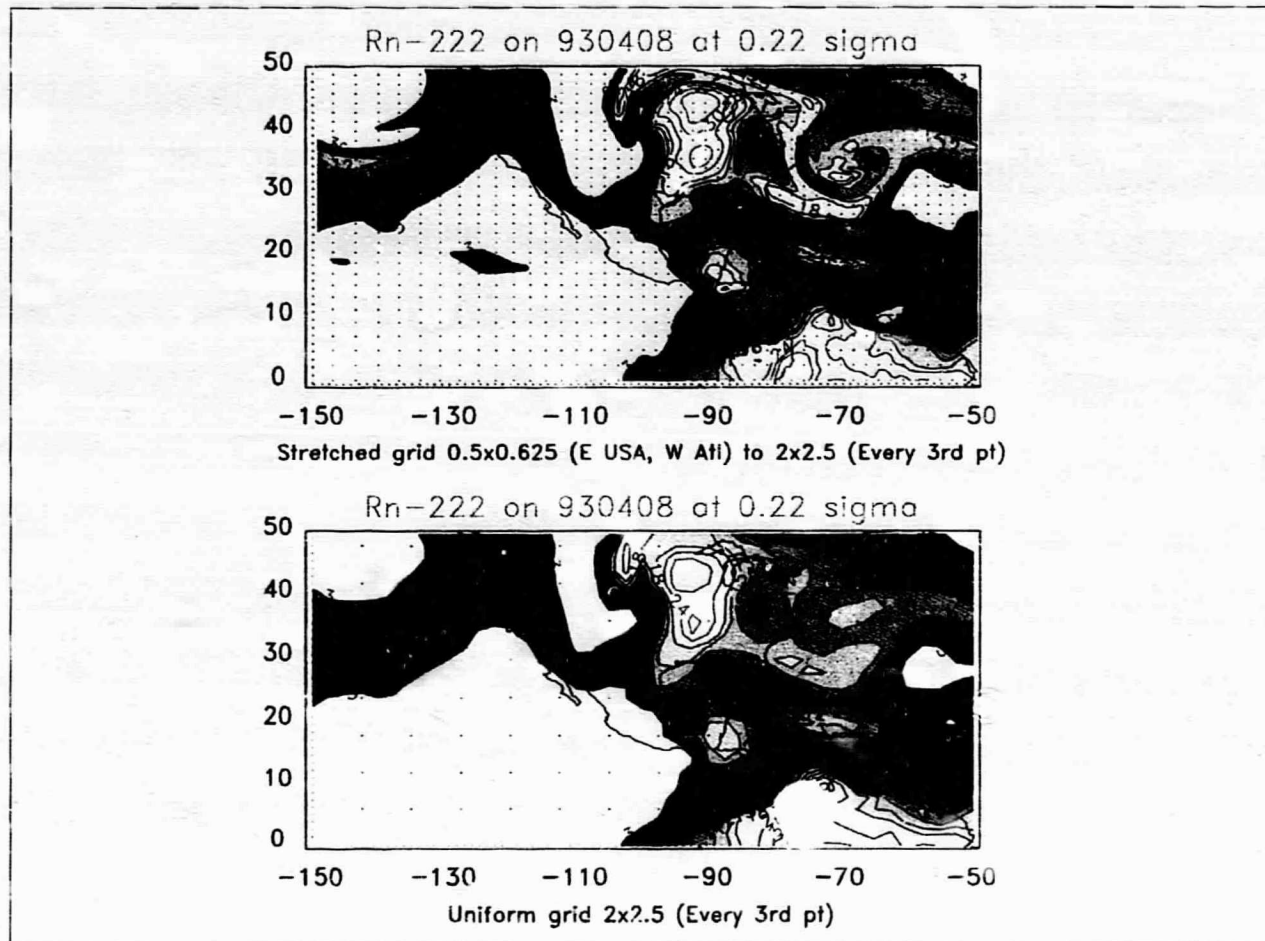

Upper tropospheric Rn-222 concentrations at 00 UT April 8, 1993 from the UMD/Goddard Stretched-grid CTM. Stretched-grid (uniform-grid) results are shown in the top (bottom) plot. The location of every 3rd grid point is shown with dots. The resolution of the stretched grid varies from 0.5×0.625 to 2×2.5 degrees. The resolution of the uniform grid is 2×2.5 degrees. The contour interval is 3 (6) pCi/SCM for concentrations less (greater) than 18 pCi/SCM. Rn-222 is a tracer used to evaluate venting of the boundary layer by convection in global chemical transport models.

Coupling Atmospheric, Ecologic, and Hydrologic Processes in a Regional Climate Model

Principal Investigator – **Roger Pielke, Sr.**

Science Background

For several years, we have explored the influence of landscape on weather and climate. In our work, we have demonstrated that alterations in transpiration patterns, due to vegetation changes over time, have significantly modified thunderstorm development and intensity, and large-scale precipitation and temperature patterns (e.g., Pielke et al. 1998; Pielke and Zeng 1989). We have shown that these effects extend across the United States (Copeland et al. 1996) and globally (Chase et al. 1996). Such landscape-change effects may have already altered climate as much as is proposed for a doubling of greenhouse gases (Pielke and Zeng 1994). An extensive review of modeling and observational studies of the importance of landscape processes on weather and climate is presented in Pielke et al. (1998).

Evaluating the two-way interactions between atmospheric and land-surface processes is crucial to understanding regional and global climate, vegetation dynamics, and watershed hydrology. Terrestrial biospheric processes respond strongly to atmospheric temperature, humidity, precipitation, and radiative exchanges, as well as to surface hydrologic processes including runoff, percolation, and snowpack accumulation and melt. Atmospheric processes, including large- and small-scale circulations and the formation of clouds and precipitating systems, are highly dependent on surface heat and moisture fluxes, which, in turn, are largely dependent upon vegetation function and soil-moisture storage. In addition, vegetation plays a major role in determining the relative contributions of precipitation, interception, runoff, and transpiration. The underlying hypothesis motivating this proposal is that atmospheric, terrestrial biospheric (biophysical/biogeochemical), and surface hydrologic processes are strongly interactive, such that accurate modeling of these processes requires their coupling in numerical models. Examples of interactions we hope to study as part of this proposal include: 1) identifying whether a dry spring, and its associated reduced biomass, leads to a relatively dry summer because of reduced transpiration and moisture recycling, 2) determining whether a wet spring, and its relative increase in biomass, reduces the chance of having a relatively dry summer, through the enhanced transpiration and associated precipitation, and 3) quantifying

the influence of land-use practices, like irrigation and grazing programs, on the character of weather and climate.

Science Goal

Our research involves coupling two state-of-the-art models developed at Colorado State University: RAMS and CENTURY. The Regional Atmospheric Modeling System (RAMS) is a general-purpose atmospheric-simulation modeling system consisting of equations of motion, heat, moisture, and continuity in a terrain-following coordinate system (Pielke et al. 1992). The Land Ecosystem Atmospheric Feedback model, version two (LEAF-2), is a subset of RAMS that represents the storage and exchange of heat and moisture associated with the atmosphere-terrestrial interface (Walko et al. 1998). The CENTURY ecosystem model simulates the biospheric response (changes in above- and below-ground biomass) to atmospheric and hydrologic forcings (Parton et al. 1996).

In its current form, RAMS/LEAF-2 assumes that vegetation phenology is predefined according to existing climatologies and time of year. This limitation prevents vegetation-related functions from responding to deviations from climatology, such as wetter or drier than average seasons, or to changes in climate. Similarly, CENTURY assumes that atmospheric forcing is known, and that vegetation dynamics have no influence on meteorology or climate. In contrast to this idealized configuration, numerous studies have shown that there are significant feedbacks between vegetation and the atmosphere (recent studies on this topic include Pielke and Vidale 1995; Chase et al. 1996; Copeland et al. 1996; Pielke et al. 1997, 1998; Avissar 1995; Dickinson 1995; Entekhabi 1995). The current proposal is designed to remedy this uncoupled misrepresentation of the climate system by merging RAMS/LEAF-2 and CENTURY. As further justification for the need to perform such a coupling, we have found the two models to be sensitive to each other's output.

Because vegetation responds strongly to atmospheric temperature, precipitation, and soil moisture, both atmospheric and soil hydrologic processes, including precipitation and runoff, must be adequately accounted for in order to accurately simulate this type of vegetation change. In turn, the type and quantity of vegetation strongly influence runoff, evaporation, transpiration, surface heat

flux, and, consequently, the air temperature and development of precipitating systems.

The atmospheric and ecosystem models are coupled through an exchange of information operating on a seven-day time step. CENTURY receives, as input, the atmospheric-forcing variables including air temperature, precipitation, and radiation simulated by RAMS. From CENTURY-produced outputs, parameters including leaf-area index, vegetation fractional coverage, displacement and roughness height, rooting profile, and vegetation albedo are computed and returned to RAMS/LEAF-2. In this way, vegetation responses to short-term (weekly) and long-term (seasonal-to-interannual) atmospheric changes are simulated and fed back to the atmospheric/land-surface hydrology model. The coupled model forms a sophisticated representation of the atmosphere-land system including relevant aspects of the hydrological cycle.

The goals of this modeling effort closely follow many of the priority research areas outlined within the context of the NASA/NOAA Global Energy and Water Cycle Experiment (GEWEX). In particular, the scientific goals of this work include:

- 1) To develop and validate a comprehensive hydrologic-biospheric-atmospheric model that integrates known important land and atmospheric processes into a unified interactive system.
- 2) To explore mechanisms by which land-use change affects the hydrological cycle on short-term, seasonal, and interannual time scales.
- 3) To apply a coupled atmosphere-hydrological-ecosystem model as a tool in assessing the potential atmospheric, biospheric, and hydrologic impacts of climate-change scenarios.

Current Activities

To achieve these goals, we are using a climate version of RAMS that is capable of efficiently performing full annual integrations (Coneland et al. 1996; Liston and Pielke 1998), and focusing on the Rocky Mountains and Central Grasslands regions.

Comparisons and evaluations of feedbacks between the models, and their performance as a coupled system, are being carried out in seasonal-to-multi-year simulations. The integrations initially focus on the 6-year period from 1988 through 1993, which was chosen to highlight a combination of generally typical as well as anomalously wet (e.g., 1993) and dry (e.g., 1988) years. By the end of our research effort, we expect to achieve the milestone of developing, testing, and verifying the coupled modeling system to the extent that we are confident in its usefulness as a primary research tool and simulation model for studying the complex interactions between the atmo-

sphere, biosphere, and hydrosphere. Specifically, we are focusing on coupling and evaluating hydrological/ecosystem and atmospheric models over regional-to-continental spatial scales, and over seasonal-to-interannual temporal scales.

As part of our previous research efforts, we have demonstrated that the two models are indeed sensitive to the outputs of each other. For example, changes in leaf-area index (LAI), defined within RAMS/LEAF-2, lead to climatologically-significant changes in atmospheric properties like temperature and precipitation. In addition, CENTURY has been found to produce ecologically-significant variations in properties like root-zone biomass and LAI, in response to climatologically plausible variations in atmospheric forcings of temperature and precipitation. Consequently, we anticipate the coupled models will highlight some interesting and significant interactions and feedbacks.

The major biological variables that influence the atmosphere include live-leaf biomass, plant residue, and live-root biomass. Increasing live-leaf biomass contributes to greater transpiration water loss from the soil, increased interception water loss, reduced surface runoff, and a generally lower albedo resulting in increased surface absorption of solar radiation. Increasing plant residue (dead standing and surface plant material) contributes to higher plant-interception water loss, lower surface runoff, lower bare-soil evaporation rates, and generally higher albedo than live plants. Higher root biomass causes increased evaporation and transpiration water loss from the soil.

In the coupled models, CENTURY receives, as input, the daily air temperature, precipitation, radiation, wind speed, and humidity simulated by RAMS/LEAF-2. CENTURY evaluates heterotrophic respiration and nutrient dynamics. From CENTURY-produced outputs, parameters including leaf-area index (LAI), vegetation fractional coverage, displacement and roughness height, rooting profile, and vegetation albedo are computed and input to RAMS/LEAF-2 every seven days. In this way, vegetation responses to both short-term and long-term atmospheric changes are simulated and fed back to the atmospheric and hydrology models.

The major proposal objectives in Year 1 involve making the model modifications required to ensure compatibility of the information passed between RAMS/LEAF-2 and CENTURY. In addition, the data sets required to drive and validate the uncoupled and coupled models will be accumulated. Specific tasks that are being performed include:

- 1) Modify RAMS/LEAF-2 to receive inputs from CENTURY. This includes a) casting RAMS/LEAF-2 in a form that receives spatially distributed vegetation parameter data sets which are only indirectly linked to vegetation type, instead of the direct vegetation-

type linkage that currently exists, and b) implement the routines required to convert from CENTURY-produced variables to those used by RAMS/LEAF-2.

- 2) Couple RAMS/LEAF-2 and CENTURY dynamically through subroutine calls operating at a weekly timestep. Cast the models on common spatial grids, and implement the use of common vegetation and soils parameter data sets within the two models.
- 3) Obtain the data sets required for driving and validating RAMS/LEAF-2 and CENTURY in both uncoupled and coupled modes. These data sets include those available from the FIFE and CASES program in Kansas; the Pawnee Grasslands LTER site in Colorado; United States coverage of bi-weekly NDVI data from the EROS data center; meteorological-station observations, such as the first-order summary-of-the-day data sets; and hourly, six-hourly, and daily atmospheric surface and upper-air observational and analyses data sets such as those provided by the ETA model as part of GCIP. In addition, we will acquire the NCEP global-model 6-hourly reanalysis data sets to provide the RAMS lateral boundary conditions. All of these data are readily available to us through our accounts at NCAR and other data archival sites such as the NASA GSFC Distributed Active Archive Center (DAAC). The data obtained will focus initially on the 6-year period 1988 through 1993, chosen to highlight a combination of generally typical as well as anonymously wet (e.g., 1993) and dry (e.g., 1988) years. This effort will also complement the regional atmospheric model intercomparison (PIRCS) for the Great Plains area being directed by Iowa State University (Takle 1995).

Use of Satellite Data

Satellite remotely sensed data are being used to validate the coupled RAMS-CENTURY model simulations. Satellite data have also been crucial in identifying current land use in our modeled domain.

Participation in Field Programs

We are using data collected as part of the FIFE and CASES in Kansas, and the Pawnee LTER site in Colorado for model validation. We also plan to utilize ARM/CART data and information from the University of Oklahoma mesonet to test the models.

Principal Investigator Roger A. Pielke, Sr.

Roger A. Pielke, Sr. received both his M.S. and Ph.D. degrees in Meteorology from Pennsylvania State University. For the last 25 years, he has concentrated on the study of terrain-induced mesoscale systems, including the development of a three-dimensional mesoscale model of the sea breeze, for which he received the NOAA Distinguished Authorship Award for 1974. Pielke has worked for NOAA's Experimental Meteorology Lab (1971-1974), The University of Virginia (1974-1981), and Colorado State University (1981-present). He is currently a Professor of Atmospheric Science at CSU. He has served as Chairman and Member of the AMS Committee on Weather Forecasting and Analysis, and was Chief Editor for the Monthly Weather Review for 5 years from 1981 to 1985.

In 1977, he received the AMS Leroy Meisinger Award for "fundamental contributions to mesoscale meteorology through numerical modeling of the sea breeze and interaction among the mountains, oceans, boundary layer, and the free atmosphere." Pielke received the 1984 Abell New Faculty Research and Graduate Program Award, and also received the 1987/1988 Abell Research Faculty Award. He was declared "Researcher of 1993" by the Colorado State University Research Foundation. He was elected a Fellow of the AMS in 1982. From 1993-1996, he served as Editor-in-Chief of the U.S. National Science Report (1991-1995) for the American Geophysical Union. Starting in January 1996, he was appointed to a three-year term as Co-Chief Editor of the Journal of Atmospheric Science.

He has published over 200 papers in peer-reviewed journals, 25 chapters in books, and co-edited 4 books. He is currently a professor in the Department of Atmospheric Science at Colorado State University.

Co-Investigator

Glen E. Liston - *Department of Atmospheric Science,
Colorado State University*

References

- Avisar, R., 1995: Recent advances in the representation of land-atmosphere interactions in general circulation models. *Rev. Geophys.*, Supplement to Vol. 33, 1005-1010.
- Chase, T.N., R.A. Pielke, T.G.F. Kittel, R. Nemani, and S.W. Running, 1996: The sensitivity of a general circulation model to global changes in leaf area index. *J. Geophys. Res.*, **101**, 7393-7408.

- Copeland, J.H., R.A. Pielke, and T.G.F. Kittel, 1996: Potential climatic impacts of vegetation change: A regional modeling study. *J. Geophys. Res.*, **101**, 7409-7418.
- Dickinson, R.E., 1995: Land-atmosphere interaction. *Rev. Geophys.*, Supplement to Vol. 33, 917-922.
- Entekhabi, D., 1995: Recent advances in land-atmosphere interaction research. *Rev. Geophys.*, Supplement to Vol. 33, 995-1003.
- Liston, G.E., and R.A. Pielke, 1998: A climate version of the Regional Atmospheric Modeling System. In preparation.
- Parton, W.J., D.S. Ojima, and D.S. Schimel, 1996: Models to evaluate soil organic matter storage and dynamics. In M.R. Carter, Ed., *Structure and Organic Matter Storage in Agricultural Soils*, CRC Press, Inc., 421-448.
- Pielke, R.A., and P.L. Vidale, 1995: The boreal forest and the polar front. *J. Geophys. Res.*, **100**, 25,755-25,758.
- Pielke, R.A., and X. Zeng, 1989: Influence on severe storm development of irrigated land. *Nat. Wea. Dig.*, **14**, 16-17.
- Pielke, R.A., and X. Zeng, 1994: Compounding of uncertainty in climate change scenarios. Proceedings, Global Climate Change: Science, Policy, and Mitigation Strategies, Air and Waste Management Association, Phoenix, Arizona, 5-8 April 1994, 393-401.
- Pielke, R.A., W.R. Cotton, R.L. Walko, C.J. Tremback, M.E. Nicholls, M.D. Moran, D.A. Wesley, T.J. Lee, and J.H. Copeland, 1992: A comprehensive meteorological modeling system - RAMS. *Meteor. Atmos. Phys.*, **49**, 69-91.
- Pielke, R.A., T.J. Lee, J.H. Copeland, J.L. Eastman, C.L. Ziegler, and C.A. Finley, 1997: Use of USGS-provided data to improve weather and climate simulations. *Ecological Applications*, **7**, 3-21.
- Pielke, R.A., R. Avissar, M. Raupach, H. Dolman, X. Zeng, and S. Denning, 1998: Interactions between the atmosphere and terrestrial ecosystems: influence on weather and climate. *Global Change Biology*, **4**, 101-115.
- Takle, E.S., 1995: Project to intercompare regional climate simulations (PIRCS), Preliminary Workshop, 17-18 November 1994. *Bull. Amer. Meteor. Soc.*, **75**, 1625-1626.
- Walko, R.L., L.E. Band, J. Baron, T.G.F. Kittel, R. Lammers, T.J. Lee, R.A. Pielke Sr., C. Taylor, C. Tague, C.J. Tremback, and P.L. Vidale, 1998: Coupled atmosphere-terrestrial ecosystem-hydrology models for environmental modeling. Department of Atmospheric Science Class Report 9, Colorado State University, Fort Collins, Colorado, 46 pp + figures.

Investigation URL

<http://hercules.atmos.colostate.edu/~project/>

Chemical, Dynamical, and Radiative Interactions Through the Middle Atmosphere and Thermosphere

Principal Investigator – **John A. Pyle**
International Sponsor – **United Kingdom**

Science Background

The middle atmosphere is a highly coupled system in which dynamical, radiative, and chemical processes are intimately connected. CO₂ and O₃ play important radiative roles. Ozone absorbs ultraviolet radiation. This leads to a heating of the middle atmosphere and also protects the biosphere from a strong and potentially dangerous UV dosage. The distribution of ozone depends on the chemical interactions of a large number of other gases. Atmospheric temperature and the general circulation of the middle atmosphere are also crucial to determining the structure of ozone. Exchanges with both the troposphere and higher atmospheric levels are important in determining the longer term changes to the system. It is vital that all these processes be understood.

Science Goals

This investigation aims to improve our understanding of atmospheric dynamical, chemical, and radiative interactions—and hence the ability to predict and detect long-term atmospheric trends in the Earth's climatic and chemical environment. Modeling and data analysis efforts will focus on the following middle atmosphere and thermosphere components: 1) circulation and internally generated variability of the atmosphere; 2) interactions between chemical, dynamical, and radiative processes; and 3) horizontal and vertical coupling mechanisms.

The study will involve a two-pronged theoretical assault using EOS data and sophisticated numerical, dynamical, radiative, and photochemical models of the troposphere, stratosphere, and mesosphere now being developed in the United Kingdom.

Current Activities

As part of our study we have developed a hierarchy of numerical models of the middle atmosphere. These include several 3-D models. One is a free-standing general circulation model (GCM), based on a model from the European Centre for Medium Range Weather Forecasts, to which we have added a full description of chemical

processes. Future studies with this model will aim at chemistry/climate interactions. We have also developed a number of chemical transport models, using different vertical coordinate systems, in which the transport is specified, either from meteorological analyses or from previous GCM integrations. These models are complemented by a range of trajectory models of varying sophistication.

Our scientific studies have involved detailed investigations combining our models with atmospheric data. Thus, a variety of UARS data sets have been studied using the full range of models. Particular investigations have looked at, for example, the descent within the polar vortex, the exchange between the polar vortex and middle latitudes, as well as studies of chlorine activation and deactivation.

Use of Satellite Data

Our EOS studies will involve the combination of our numerical models with various EOS data sets. Of particular interest will be instruments designed to measure chemical constituent concentrations or to provide dynamical or radiative information, especially for the middle atmosphere. These instruments include HIRDLS, MLS, TES, SOLSTICE, ACRIM III, SAGE III, MOPITT, and CERES. The data will be used in a number of ways. Firstly, case studies of interesting periods will be carried out using our hierarchy of models. Secondly, seasonal, and longer, integrations will be performed, initializing the models with appropriate EOS data, and comparing the subsequent model and data evolution. Thirdly, in research mode, 4-dimensional variational assimilation studies will be carried out, building on studies currently underway.

Participation in Field Programs

We have participated in recent field campaigns such as: 1) EASOE - European Arctic Stratospheric Ozone Experiment; 2) SESAME - Second European Stratospheric Arctic and Mid-latitude Experiment; 3) ASHOE - Airborne Southern Hemisphere Ozone Experiment; and 4) THE3EO, the Third European Stratospheric Experiment on Ozone.

Our aim has been to study polar ozone loss (with an emphasis on the Arctic) and the way polar processes influence the middle latitudes. Of special interest have been very-high-resolution modeling studies to investigate the filaments of air, torn from the edge of the polar vortex, which have been observed and now successfully modeled.

These investigations are advancing our ability to combine data and models and so are paving the way to studies in the EOS era.

Principal Investigator

John Pyle

John Pyle holds a D.Phil. in Atmospheric Physics from the University of Oxford. He is University Reader in Atmospheric Chemistry at the University of Cambridge and head of the European Ozone Research Coordinating Unit since 1991. Currently, he serves as Principal Investigator in the U.K. Universities Global Atmospheric Modeling Programme supported by the Natural Environment Research Council. He has chaired the Core Groups organizing both EASOE and SESAME campaigns to study Arctic stratospheric ozone. He is Chairman of the U.K. Stratospheric Ozone Review Group and has served as a consultant to the European Space Agency on the future of middle atmospheric studies from space. In 1985, he was the recipient of the Eurotrac Award of the Remote Sensing Society.

Co-Investigators

Timothy J. Fuller-Rowell - *CIRES-Boulder, Colorado*

Lesley J. Gray - *Daresbury Rutherford Appleton Laboratory*

Joanna D. Haigh - *Imperial College of Science and Technology*

Robert S. Harwood - *University of Edinburgh*

Brian Hoskins - *University of Reading*

Roderic L. Jones - *University of Cambridge*

Michael E. McIntyre - *University of Cambridge*

Roy J. Moffett - *University of Sheffield*

Shaun Quagan - *University of Sheffield*

David Rees - *University College, London*

Alan Rodger - *British Antarctic Survey*

Keith Shine - *University of Reading*

Ralf Toumi - *Imperial College of Science and Technology*

References

Bekki, S., M.P. Chipperfield, J.A. Pyle, J.J. Remedios, S.E. Smith, R.G. Grainger, A. Lambert, J.B. Kumer, and J.L. Mergenthaler, 1997: Coupled aerosol-chemical modeling of UARS HNO₃ and N₂O₅ measurements in the Arctic upper stratosphere. *J. Geophys. Res.*, **102**, 8977-8990.

Chipperfield, M.P., A.M. Lee, and J.A. Pyle, 1996: Model calculations of ozone depletion in the Arctic polar vortex for 1991/92 to 1994/95. *Geophys. Res. Lett.*, **23**, 559-562.

Hadjinicolaou, P., J.A. Pyle, M.P. Chipperfield, and J.A. Kettleborough, 1997: Effect of interannual meteorological variability on middle latitude ozone. *Geophys. Res. Lett.*, **24**, 2993-2996.

Lee, A.S.M., G.D. Carver, M.P. Chipperfield, and J.A. Pyle, 1997: Three-dimensional chemical forecasting: A methodology. *J. Geophys. Res.*, **102**, 3905-3917.

McIntyre, M.E., and J.A. Pyle, 1993: Model studies of dynamics, chemistry, and transport in the Antarctic and Arctic stratospheres. University Research in Antarctica, R.B. Heywood, Ed., *British Antarctic Survey*, 17-33.

Pyle, J.A., G. Carver, J.L. Grenfell, J.A. Kettleborough, and D.J. Lary, 1992: Ozone loss in Antarctica: The implications for global change. *Proc. Roy. Soc. London B*, **338**, 219-226.

Pyle, J.A., P. Brown, S. Bekki, G.D. Carver, K.S. Law, and D.Z. Stockwell, 1995: Modeling the sources and sinks of radiatively active gases. *Proc. Roy. Soc. London A*, in press.

Investigation URL

<http://www.atm.ch.cam.ac.uk/>

Project ATLANTA (ATLanta Land use ANalysis: Temperature and Air quality)

Principal Investigator – **Dale A. Quattrochi**

Science Background

Project ATLANTA seeks to observe, measure, model, and analyze how the rapid growth of the Atlanta, Georgia metropolitan area since the early 1970's has impacted the region's climate and air quality. The primary objectives for this research effort are: 1) To investigate and model the relationship between Atlanta urban growth, land-cover change, and the development of the urban heat island phenomenon through time at nested spatial scales from local to regional; 2) to investigate and model the relationship between Atlanta urban growth and land-cover change on air quality through time at nested spatial scales from local to regional; and 3) to model the overall effects of urban development on surface-energy budget characteristics across the Atlanta urban landscape through time at nested spatial scales from local to regional.

Science Goal

Our key goal is to derive a better scientific understanding of how land-cover changes associated with urbanization in the Atlanta area, principally in transforming forest lands to urban land covers through time, has, and will, affect local and regional climate, surface-energy flux, and air-quality characteristics. Allied with this goal is the prospect that the results from this research can be applied by urban planners, environmental managers, and other decision makers, for determining how urbanization has impacted the climate and overall environment of the Atlanta area. It is our intent to make the results from this investigation available to the user community to help facilitate measures that can be applied to mitigate climatological or air-quality degradation, or to design alternative measures to sustain or improve the overall urban environment in the future.

Current Activities

The scientific approach we are using in relating land-cover changes to modifications in the local and regional climate and in air quality, is predicated on the analysis of remote-sensing data in conjunction with in situ data (e.g., meteorological measurements) that are employed to initialize local- and regional-level numerical models of land-atmo-

sphere interactions. Remote-sensing data form the basis for quantifying how land covers have changed within the Atlanta metropolitan area through time from the early-1970's, when Atlanta's dramatic growth began in earnest, to the present. These remotely sensed data will be used to provide input to numerical models that relate land-cover change through time with surface-energy flux and meteorological parameters to derive temporal models of how land-cover changes have impacted both the climatology and the air quality over the Atlanta region. Current remote-sensing data (i.e., data obtained during 1997) will be used to calibrate the models and to serve as baseline data for extending the models to predict how prospective future land-cover changes will affect the local and regional climate and air quality over the Atlanta-north-Georgia region. Additionally, remote-sensing data will be used to characterize and measure urbanization and deforestation parameters that can be used to assess, as well as predict, the effects of land-use changes on the local microclimate.

The science tasks associated with Project ATLANTA are being executed via a number of separate, but highly interlinked, tasks. These are listed in the following paragraphs.

Land-Use/Land-Cover-Change Detection from Landsat MSS and Thematic Mapper Images

Science Objectives – 1) To detect land-use/land-cover changes that are meteorologically or climatologically significant across the Atlanta metropolitan area using retrospective Landsat MSS and TM data, and high-spatial-resolution aircraft-scanner data; 2) to map changes in land-surface temperature using retrospective Landsat MSS and TM data, and high-spatial-resolution aircraft-scanner data; and 3) to derive NDVI estimates of changes in greenness for the Atlanta area through time using Landsat MSS and TM and AVHRR data, and high-spatial-resolution aircraft-scanner data. Land-use/land-cover change has been mapped from MSS data over the Atlanta region for 1973, 1979, 1983, 1988, and 1992. Current research efforts are focused on extracting NDVI values from the historical MSS data, on mapping land use/land cover from Landsat TM data obtained in 1997 over Atlanta, and on mapping land use/land cover from high-spatial-resolution multi-spectral aircraft-scanner data acquired over Atlanta in 1997.

Analysis of Urban Surface Energy Fluxes from High-Spatial-Resolution Multispectral Thermal IR Data

Science Objectives – 1) To characterize and quantify surface-energy fluxes using high-spatial-resolution airborne remote-sensing data across the Atlanta urban landscape; 2) to examine and quantify effects of spatial scale on these energy fluxes; and 3) to develop a functional classification of the change in thermal surface-energy flux over time of the Atlanta urban landscape. High-spatial-resolution (10-m pixel resolution) multispectral aircraft-scanner data were acquired over Atlanta using the NASA Advanced Thermal and Land Applications Sensor (ATLAS) in May 1997. These data are being used to derive thermal IR measurements of land-surface-energy fluxes for day and night for the Atlanta metropolitan area for input to the land-use change, and meteorological and air-quality modeling tasks in Project ATLANTA. MAS and AVIRIS data were also collected over Atlanta in August 1997 and will be used to derive additional land-cover information for use in the land-use change and meteorological modeling tasks of this project.

Linking Satellite Remote-Sensing Data with Temporal Changes in Urban Land Cover and Observed Climatic Data

Science Objectives – To derive an historical description of urbanization (i.e., associated land-use change) for Atlanta using the available archived satellite data (e.g., AVHRR) from 1985 to date (1996) on an annual basis, and to estimate the amount of soil moisture, and vegetative cover that has been modified as a result of the urbanization process. NDVI values have been derived from AVHRR data acquired for the region. These data will be analyzed for comparison of how NDVI changes through time over the study area. AVHRR data will be used to assess the influence of urbanization and related changes in land cover on the observed in situ maximum and minimum air temperatures. Additionally, AVHRR-derived surface-temperature and vegetation-index values, and modeled fractional-vegetative-cover and heat-flux values will be analyzed in relation to land-use/land-cover changes as defined from Landsat MSS and TM data sets.

Meteorological Modeling

Science Objectives – To simulate the regional meteorology and air quality of the Atlanta region over a time span of several years (e.g., mid-1970's to the present) as a means for understanding the linkages between changes in local land use/land cover and regional meteorology and air quality. Another objective is to model prospective (i.e., future) changes that may occur, based on simulated changes in land use/land cover, on meteorological and

air-quality conditions over the Atlanta metropolitan area. These simulations of future impacts are useful as input to decision makers for potentially developing air-quality control measures and for mitigating the development of the urban heat island over the Atlanta-north Georgia region. Two summer episodes have been used to model daytime and nighttime heating over the Atlanta region. Work is currently in-progress in implementing the MM5 model for comparative testing of simulated meteorological scenarios over Atlanta in the future. Current research is directed towards improving meteorological model input using land-cover information derived from the high-spatial-resolution aircraft data collected in 1997 along with recent TM data, and in using the historical land-cover information derived from MSS and AVHRR data.

Air Quality Modeling

Science Objectives – The impacts of urban growth on air quality in Atlanta both for short- and long-term changes are being modeled using photochemical simulations. Air-quality impacts of changes in albedo and vegetation cover/tree species over time and as proposed in future urban development plans for Atlanta are also being modeled. The most significant meteorological impact of these surface modifications is an elevation in air temperature which will increase chemical reaction rates. A base-case photochemical model has been run for the Atlanta region using the Urban Airshed Model (UAM) for two air-quality episodes. Improved base-case and modified base-case UAM scenarios are currently being performed using state-wide in situ observational meteorological data. Land-use information derived from ATLAS, Landsat MSS and TM, and AVHRR data are being used to refine the airshed base-case model via input to the background meteorological model. Remote-sensing data are also used to define albedo input as a refinement to the UAM model.

Analysis of Cloud Effects on Urban Climate

Science Objectives – Clouds are significant intermediaries in the urban land-cover-climate connection. Changes in urban land cover will change the cloud cover—particularly of the small clouds—which will change the solar insolation and the outgoing infrared radiation, and thus the climate and the air quality. GOES 8 data are being used to construct a cloud climatology over the study area for input to the meteorological modeling tasks of Project ATLANTA. GOES 8 data are also being analyzed to understand the diurnal variability of albedo, soil-moisture availability, thermal inertia, and surface roughness needed to initialize the mesoscale meteorological models. Additionally, GOES 8 data are being used to determine what effects changes in land use/land cover have on the modeled cloud field over the Atlanta area.

Applications Strategy Assessment

Objectives – During FY97 an effort was initiated to relate the science tasks associated with Project ATLANTA to the needs of the user community in the Atlanta metropolitan area. The application of the results achieved in Project ATLANTA by decision makers, planners, and other individuals and agencies to make the Atlanta area a more-sustainable and habitable urban environment, is viewed as the ultimate demonstration that the science tasks described above, produce results that can be effectively used to make the Atlanta metropolitan area a better place in which to work and live. Three areas comprise the principal foci for current and future work: 1) Maintain effective contact with the recently organized Project ATLANTA Applications Working Group to ensure that data products are developed that are responsive to the group's needs and interests. This will be accomplished by keeping the working-group members informed regarding the types of remote-sensing data collected, plans to utilize this data, and how we hope to use the data to advance knowledge of the urban heat island and its impact on air quality and the energy budget; 2) evaluate the tools and resources available for integration with the remote-sensing data and model output products from Project ATLANTA. This includes a survey of GIS-based tools and software packages that are of interest to the user community in the Atlanta area; and 3) transfer the remote-sensing and data and model output results from Project ATLANTA to the user community.

Use of Satellite Data

Pre-EOS satellite data are used extensively throughout Project ATLANTA for analysis of landscape, biophysical, land-atmosphere surface-energy flux, and cloud characteristics over the Atlanta metropolitan area. Landsat MSS and TM data are used to detect, observe, and measure land-cover/land-use change across the study area. AVHRR data are being employed to measure a host of attributes including NDVI, land-cover/land-use change, soil-moisture availability, and thermal-energy fluxes. GOES 8 data are utilized to analyze cloud cover, as well as diurnal variability of albedo, soil-moisture availability, thermal inertia, and surface roughness. These satellite data are key inputs to initializing and calibrating the meteorological and air-quality models used in Project ATLANTA, and also for providing temporal data on the dynamics of a range of biophysical and land-process phenomena, to assess how these parameters have impacted the meteorology and air quality of the Atlanta area.

Data from the Terra platform, particularly from MODIS and ASTER, and the Landsat 7 ETM+, will be integral to the continued analysis and modeling of how landscape dynamics across the Atlanta metropolitan area

affects meteorology and climate. As a precursor to the launch of MODIS, MAS data acquired to support this project will be used in conjunction with the high-spatial-resolution ATLAS data, to define thermal surface-energy flux characteristics for selected surfaces typical of the Atlanta urban landscape. MODIS data will be employed to provide current data on land-cover/land-use change, NDVI, and thermal land-surface characteristics over the Atlanta metropolitan region for input to meteorological and air-quality modeling. ASTER thermal data in conjunction with Landsat 7 ETM+ TIR data, will be analyzed to derive current measurements of daytime and nighttime thermal-energy flux characteristics that will be particularly valuable in assessing and modeling the magnitude, extent, and dynamics of the Atlanta urban heat island on a seasonal and yearly basis. These collective data from MODIS, ASTER, and Landsat ETM+ will provide a vehicle for developing a near-real-time analysis of land-cover/land-use change, NDVI, and urban-heat-island dynamics, at different spatial and spectral resolutions. These data will also be critical to understanding how urban landscape attributes, biophysical characteristics, and surface thermal-energy fluxes are manifested at different spatial, temporal, and radiometric scales. Additionally, data from the MODIS, ASTER, and Landsat ETM+ sensors, in conjunction with current and future generation GOES data, will be invaluable for building a comprehensive model on how soil moisture, albedo, and related biophysical properties affect cloud-cover development, which, ultimately, will affect the climate and air quality of the Atlanta metropolitan area.

We believe these data will also be of great value to the user community by providing a variety of satellite data products obtained at different spatio-temporal resolutions, that can be used for the continuous characterization of land-cover dynamics across the Atlanta region. We envision a host of potential applications for MODIS, ASTER, and Landsat 7 ETM+ data, especially for decision-making on urban land use or environmental policies at the regional level across the Atlanta metropolitan area.

Participation in Field Activities

Field activities associated with Project ATLANTA are related primarily to ground-truth assessments of landscape characteristics for verification of land-cover characterization information derived from aircraft and satellite data. Field campaigns to support data collection with the ATLAS and MAS sensors in 1997 focused on obtaining spot surface-temperature measurements using thermal IR thermometers, and in launching radiosonde balloons and setting up solar measurement instrumentation to acquire atmospheric profile and solar insolation data for remote-sensing data calibration.

Principal Investigator
Dale Quattrochi

Dale Quattrochi is a Senior Research Scientist with the NASA Global Hydrology and Climate Center located at the George C. Marshall Space Flight Center in Huntsville, Alabama. He received his Ph.D. in geography from the University of Utah and has over nineteen years of experience in the field of Earth science remote-sensing research and applications. His research interests focus on the analysis of land-atmosphere energy exchanges in urban areas using thermal remote sensing, on the characterization of urban landscape patterns and processes using remote sensing, on the integration of remote-sensing data with geographic information systems, and on the spatial analysis of remote-sensing data using fractals and other geostatistical techniques. He has co-edited a book with Michael Goodchild from the University of California, Santa Barbara, entitled *Scale in Remote Sensing in GIS*, published in January 1997 by CRC/Lewis Publishers, Boca Raton, Florida.

Quattrochi is an adjunct faculty member in the geography departments at the University of New Orleans and the Louisiana State University. He is also an adjunct professor in the Department of Plant and Soil Science and the Center for Hydrology, Soil Climatology and Remote Sensing at Alabama A&M University, and is an adjunct associate professor in the Department of Atmospheric Science at the University of Alabama in Huntsville.

Co-Investigators

Jeffrey C. Luvall - NASA, Global Hydrology and Climate Center

Stanley Q. Kidder - Colorado State University

C.P. Lo - University of Georgia

Haider Taha - Lawrence Berkeley National Laboratory

Robert D. Bornstein - San Jose State University

Robert R. Gillies - Utah State University

Kevin P. Gallo - NOAA/NESDIS National Climatic Data Center

References

Bornstein, R., 1987: Urban effects on mesoscale and synoptic systems. Preprints, 3rd AMS Conf. on Mesoscale Processes, 21-26 August, Vancouver, B. C.

Bornstein, R., et al., 1994: Observation and simulations of urban effects on boundary layer structure. *Air Pollution Modeling and its Applications*, X, Plenum Press, New York, 101-108.

Gallo, K.P., J.D. Tarpley, A.L. McNab, and T.R. Karl, 1995: Assessment of urban heat islands: a satellite perspective. *Atmos. Res.*, **37**, 37-43.

Gallo, K.P., and J.D. Tarpley, 1996: The comparison of vegetation index and surface temperature composites for urban heat-island analysis. *Intl. J. Remote Sens.*, **17**, 3071-3076.

Gallo, K.P., D.R. Easterling, and T.C. Peterson, 1996: The influence of land use/land cover on climatological values of the diurnal temperature range. *J. Climate*, **9**, 2941-2944.

Gillies, R.R., T.N. Carlson, J. Cui, W.P. Kustas, and K.S. Humes, 1997: A verification of the 'triangle' method for obtaining surface soil water content and energy fluxes from remote measurements of the Normalized Difference Vegetation Index (NDVI) and surface radiant temperature. *Intl. J. Remote Sens.*, **18**, 3145-3166.

Kidder, S.Q., and O.M. Essenwanger, 1995: The effect of clouds and wind on the difference in nocturnal cooling rates between urban and rural areas. *J. Appl. Meteor.*, **34**, 2440-2448.

Kidder, S.Q., and J. Hafner, 1995: A satellite study of urban warming for global climate change research. Presented at Reducing Scientific Uncertainty II: The Second Annual NIGEC Research Symposium, 26-27 April 1995, Tuscaloosa, Alabama.

Lo, C.P., D.A. Quattrochi, and J.C. Luvall, 1997: Application of high-resolution thermal infrared remote sensing and GIS to assess the urban heat island effect. *Intl. J. Remote Sens.*, **18**, 287-304.

Lo, C.P., 1997: Land use/cover changes of the Atlanta Metropolitan Region as revealed by Landsat MSS Images, 1973-1992. Abstracts, Southeastern Division of the Association of American Geographers annual meeting, 22-25 November 1997, Birmingham, AL, p. 15.

Lo, C.P., and X. Yang, 1998: An operational approach to land use/cover change mapping using multi-date Landsat MSS imagery. Paper presented at the 94th annual meeting of the Association of American Geographers, 25-29 March 1998, Boston, MA.

Lo, C.P., and X. Yang, 1998: Some practical considerations of relative radiometric normalization of multitemporal Landsat MSS data for land use change detection. Paper presented at the American Society for Photogrammetry and Remote Sensing-Resource Technology Institute annual meeting, 30 March-3 April, 1998, Tampa, FL.

Owen, T.W., T.N. Carlson, and R.R. Gillies, 1997: An assessment of satellite remotely sensed land cover parameters in quantitatively describing the climate effect of urbanization. *Intl. J. Remote Sens.*, in press.

Quattrochi, D.A., and M.K. Ridd, 1994: Measurement and analysis of thermal energy responses from discrete urban surfaces using remote sensing data. *Intl. J. Remote Sens.*, **15**, 1991-2022.

Quattrochi, D.A., and N.S. Goel, 1995: Spatial and temporal scaling of thermal infrared remote sensing data. *Remote Sensing Reviews*, **12**, 255-286.

Quattrochi, D.A., and J.C. Luvall, 1997: High spatial resolution airborne multispectral thermal infrared data to support analysis and modeling tasks in EOS IDS Project ATLANTA. *The Earth Observer*, **9**, 22-27.

Quattrochi, D., and M.K. Ridd, 1998: Analysis of vegetation within a semi-arid urban environment using high spatial resolution airborne thermal infrared remote sensing data. *Atmos. Environ.*, **32**, 19-33.

Taha, H., 1997: Modeling the impacts of increased urban vegetation on the ozone air quality in the south coast air basin. *Atmos. Environ.*, **30**, 3423-3430.

Taha, H., 1997: Modeling the impacts of large-scale albedo changes on ozone air quality in the south coast air basin. *Atmos. Environ.*, **31**, 1667-1676.

Taha, H., and A. Meier, 1997: Mitigation of urban heat islands: Meteorology, energy, and air quality impacts. Proceedings, International Symposium on Monitoring and Management of Urban Heat Island, CREST/JST, 19-20 November 1997, Keio University, Fujisawa, Japan, 124-163.

Investigation URL

<http://www.ghcc.msfc.nasa.gov/atlanta/>



High-resolution (10 m) daytime thermal ATLAS image of the Atlanta, Georgia central business district (CBD). Grayscale relative temperature ranges are from "hot" (in white) to "cool" (in dark gray to black). Note the shadows cast by tall buildings in the Atlanta CBD.

Variability and Predictability of Land-Atmosphere Interactions: Observational and Modeling Studies

Principal Investigator – **John O. Roads**

Science Background

This investigation is aimed at evaluating and predicting seasonal-to-interannual variability for selected regions emphasizing the role of land-atmosphere interactions. Of particular interest are the relationships between large-scale and regional and local scales and how they interact to account for seasonal and interannual variability, including extreme events such as droughts and floods. North and South America, including the GEWEX GCIP, MacKenzie, and LBA basins, will be emphasized during the first two years. We will also generalize and synthesize to other land regions across the globe, especially those pertinent to other GEWEX projects.

Science Goal

The overall goal of this project is to increase our understanding of seasonal-to-interannual variability and predictability of atmosphere-land interactions. The specific objectives of are to:

- 1) Document the low-frequency variability in land-surface features and associated water and energy cycles from general circulation models (GCMs), observations, and reanalysis products.
- 2) Determine what relatively wet and dry years have in common on a region-by-region basis and then examine the physical mechanisms that may account for a significant portion of the variability.
- 3) Develop GCM experiments to examine the hypothesis that better knowledge of the land surface enhances long-range predictability.

Current Activities

Roads et al. (1998a) compared characteristics of the National Centers for Environmental Prediction and National Center for Atmospheric Research (NCEP/NCAR) reanalysis surface-water budget to the surface-water budget characteristics in a long-term simulation with the NCEP global spectral model (GSM) used in the reanalysis. There are many geographic similarities. There are a few differences, though, mainly because the reanalysis has a source

(artificial) of water from a seasonally varying damping (forcing) term, which affects the surface-water budget. A number of climatological simulations and sensitivity experiments with the latest NCAR community climate model coupled to a sea-ice mixed-layer ocean model (Roads et al. 1998b,c,d) were compared to the NCEP reanalysis and each other. In addition to a control run forced by observed sea-surface temperatures for the period 1950-1994, there have been a number of 20-year CO₂ simulations developed, ranging from concentrations of 100 ppm to 3000 ppm. We are also beginning to compare precipitation measurements from GPCP and ultimately from TRMM with these simulations and the reanalysis.

We are also investigating the relative impacts of local influences (e.g., soil moisture, land cover) versus far-field effects (e.g., SST anomalies) on warm-season precipitation over the central U.S. GCIP region using NCAR's Climate System Model (CSM), NCEP and DAO reanalyses, and available observations (Oglesby et al. 1998, Robertson et al. 1998). Initial findings suggest that remote atmospheric forcings produce a clear response in soil-moisture anomalies over the GCIP region (through changes in the structure of the large-scale quasi-stationary wave structure) and that local effects (particularly precipitation) have a clear diagnostic relationship with soil-moisture anomalies.

Use of Satellite Data

This project will make use of current and emerging observational data sets from NASA's EOS and pre-EOS missions. Global observations of precipitation from GPCP, MSU, and SSM/I are to be used in documenting interannual variability of regional precipitation and, along with radiation, to serve as a means for inferring anomalous thermal forcing to radiation, heat, and moisture budgets. ERBS TOA fluxes and SRB radiative flux components are being used to document the gross radiative behavior over continents and subregions such as the Mississippi basin. Over land the ERBS fluxes are used as a means to check the net horizontal flux divergence of moist static energy in reanalyses. Although soil moisture is not directly observed from space, we are using proxies such as skin-temperature anomalies from the TOVS Path-A products and the SRB radiative components to assess diagnosed soil moisture. The Schnorr/Lettenmaier data set and

several GEWEX Soil Wetness Products which used observed precipitation and meteorology to drive hydrologic models are to be scrutinized in this way.

A preliminary evaluation of these combined data sources has shown the ability of the remotely sensed data to capture anomalous hydrologic events over the Mississippi basin during the period 1983 to 1991. Lagged surface response to atmospheric vertical motion and resulting precipitation suggests that quantitative use can be made of these data sets. Water vapor from the NVAP project and from individual TOVS and SSM/I algorithms will be used to critique moisture-budget diagnostics and to infer vertical motions. Global observations of precipitation provided through GPCP and water vapor provided through NVAP have already been used to validate water-vapor cycling rates, defined as column-integrated water vapor/precipitation rate. As shown by Roads et al. (1998b), the smallest cycling rate occurs for the satellite-based observations. The cycling rate is a bit higher for the NCEP reanalysis and quite a bit higher for each of the CCM3 simulations. However, there are strong seasonal similarities among the observations, reanalysis, and CCM3 simulations; the cycling rate is largest during the boreal winter and smallest during the boreal summer. This seasonal variation is similar to what occurs in changed-CO₂ experiments in that the cycling rate decreases with increasing CO₂. This decrease is due to the large increase in atmospheric moisture relative to smaller increases in precipitation.

Participation in Field Programs

This project is not directly involved in any field campaigns. However, analysis of in situ and remotely sensed data sets for the purpose of checking GCM model performance and cross-checking of regional and global data sets will be done.

Principal Investigator

John O. Roads

John Roads received a Ph.D. from M.I.T. in 1977 and is currently based at the Scripps Institution of Oceanography at the University of California, San Diego, where he is director of the Experimental Climate Prediction Center. He is a member of the NAS/NRC GEWEX panel and has been involved with GCIP since its inception.

Co-Investigators

Robert J. Oglesby - *Purdue University*

Susan Marshall - *University of North Carolina, Charlotte*

Franklin R. Robertson - *NASA/Marshall Space Flight Center*

References

Oglesby, R.J., S. Marshall, J.O. Roads, and F.R. Robertson, 1998: Diagnosing energy and water budgets for GCIP from models and observations. GCIP Mississippi River Climate Conference. St. Louis, MO, June 8-12.

Roads, J.O., S.-C. Chen, M. Kanamitsu, and H. Juang, 1998a: Surface water characteristics in the NCEP Global Spectral Model and Reanalysis. *J. Geophys. Res.*, in press.

Roads, J., S. Chen, S. Marshall, and R. Oglesby, 1998b: Atmospheric moisture cycling rates. *GEWEX News*, in press.

Roads, J.O., S.-C. Chen, S. Marshall, R.J. Oglesby, and F.R. Robertson, 1998c: Sensitivity of the water budget over the Americas to increased CO₂. *Climate of the Americas*, Merida, Venezuela, March 16-22.

Roads, J.O., S.-C. Chen, S. Marshall, R.J. Oglesby, and F.R. Robertson, 1998d: Sensitivity of the water budget over the Mississippi to increased CO₂. GCIP Mississippi River Climate Conference. St. Louis, MO, June 8-12.

Robertson, F.R., J.O. Roads, R.J. Oglesby, and S. Marshall, 1998: Anomalies in coupled energy and water budgets over the Americas during the Northern Hemisphere warm season. GCIP Mississippi River Climate Conference. St. Louis, MO, June 8-12.

The Development and Use of a Four-Dimensional Atmospheric-Ocean-Land Data Assimilation System for EOS

Principal Investigator – **Richard B. Rood**

Science Background

This investigation will develop a research-quality, 4-dimensional atmosphere-ocean-land data-assimilation system for EOS. The data assimilation melds observations with a model prediction to provide a dynamically consistent depiction of the Earth-atmosphere system. It has the unique ability to produce estimates of unobserved quantities.

Data-assimilation approaches are used throughout science and engineering. Information from the observations is combined with information from the model using objective analysis techniques. A classic example of the assimilation process is the parallel development of the theory of planetary motions and the discovery of the new planets. For example, the outer planets were hypothesized because a high degree of confidence was placed in the equations of motion (i.e., the model), and new objects were needed to explain the observed perturbations in the orbits of the known planets). In traditional NASA culture, data-assimilation techniques are crucial to orbit determination and were essential to navigation in the Apollo flights.

Because of the large number of observations and the complexity of Earth-system models, Earth-science data assimilation provides many difficult challenges. The ability of a data-assimilation technique to integrate the diverse measurements of the observing program motivates addressing these scientific and computational challenges. The data-assimilation system: 1) organizes the observations from many diverse instrument sources and measurement times into a single useful data product; 2) complements the observations by propagation of information from observed into unobserved regions and times; 3) provides estimates of expected values of the observations with which to assess data and instrument quality; 4) provides special products for environmental-assessment studies; and 5) supplements the observations by providing estimates of quantities that are difficult or impossible to observe.

Science Goals

The goals of this investigation are to produce an assimilation analysis to ensure that the maximum information

is gained from the EOS and other observations, and to set the foundation for future Earth system models. The development will be a sequence of incremental builds of the Goddard Earth Observing System (GEOS) Data Assimilation System. Continual research into numerical and theoretical techniques and associated Earth Science process studies will ensure that the developed system meets the needs of EOS. Analyzing historical and new data sets available in the pre-launch phase of EOS will serve to define the basis for NASA's assimilation system. Application from these pre-launch products will define the evolution of the data-assimilation system. The assimilated data produced in the pre-launch period will be made available to the broad science community to assure infusion of relevant diverse applications into the development process. A commitment is made to continued reanalyses of these data sets to quantify the impact of the heterogeneity of the input data stream on interannual signals.

Current Activities

The investigation performs research into all aspects of 4-dimensional data assimilation, including satellite retrievals, data quality control, error propagation, objective analysis, and all component models of the Earth system. Data from satellites such as UARS, TRMM, and ADEOS are being used to assess the utility of new data types, such as marine-surface wind and precipitation data. Initial studies concentrate on meteorology, with an emphasis on the hydrological cycle and seasonal and interannual variability. A strong emphasis is also placed on global transport processes and atmospheric chemistry. Near-term development will emphasize land-surface and ocean-surface processes.

Significant Events

- Production of 1980-1994 global gridded data set of tropospheric meteorological and hydrological quantities with version one of the GEOS Data Assimilation System. This product is distributed by the Goddard DAAC.

- Production of 1987-1995 gridded data set of marine surface winds using SSM/I wind-speed observations. This product is distributed by the JPL DAAC.
- Production of a near-real-time current global gridded data set of tropospheric and stratospheric meteorological and hydrological quantities. These data sets have been extensively used in international ozone assessment studies.
- Production of near-real-time forecasts to help target NASA ER-2 and DC-8 aircraft in SPADE, ASHOE/MAESA, STRAT, POLARIS, and SONEX missions. Also produced data sets to support the ATLAS mission on the space shuttle.
- Data-impact studies on ADEOS that show potential of NSCAT to improve weather forecasting and marine storm forecasting.
- Data-impact studies of SSM/I and TMI show the ability of precipitation observations to reduce biases in key radiative climate quantities.
- Provision of numerical algorithms to Code R Global Modeling Initiative for NASA and IPCC assessments of the potential impact of aircraft emissions on atmospheric pollution.
- Provisions of the Physical-space Statistical Analysis System to the U.S. Navy, CPTEC (Brazil) with plans for more national and international collaborations.

Development and Products

Incremental versions of the GEOS Data Assimilation System will be built to support NASA missions. The current version supports the CERES instrument on TRMM. For Terra the GEOS system will be developed specifically to improve tropospheric water and near-surface meteorological conditions. The Terra system will be used to perform a consistent updated reanalysis from 1979 to current time. Two research efforts, focused on use of MO-PITT observations, are being pursued in collaboration with Duke University and NCAR. For PM-1 much of the focus will be to perform quick evaluation of the impact of AIRS observations on the assimilated data products. The data-assimilation system is undergoing continuous improvement to provide increasingly more-accurate representations of transport processes for both tropospheric and stratospheric applications. Finally, products are being provided to improve the quality of retrievals from a broad range of remote-sensing instruments.

Assimilation products to be made available include the following 4-dimensional gridded fields:

- Atmosphere: wind, temperature, moisture, geo-potential, turbulence, radiative heating/flux, clouds (amount, type, mass flux, and detrainment), precipitation, sensible and latent heat flux, and planetary boundary layer depth.
- Surface (land and ocean): albedo, temperature, pressure, evaporation, roughness (drag and wind stress), snow depth, soil moisture, and vegetative moisture.
- Surface (ocean only): salinity, currents, sea state, and sea-level height.

Principal Investigator

Richard B. Rood

Richard Rood obtained a Ph.D. in Meteorology from Florida State University in 1982. Since then, he has been at NASA's Goddard Space Flight Center (GSFC). He has been involved in the development of atmospheric general circulation models, and three-dimensional chemistry and transport models. He has pioneered the use of winds and temperatures derived by data assimilation to study atmospheric transport processes. In 1992, he was appointed Head of the Data Assimilation Office at GSFC—the only center of data-assimilation research that is not maintained within an operational weather-forecasting center. The Data Assimilation Office produces research-quality data sets to study Earth system processes and global change.

Co-Investigators

Donald R. Johnson - *University of Wisconsin*

The following are from NASA/Goddard Space Flight Center:

Robert M. Atlas
 J. Ray Bates
 Stephen Cohn
 Michael Fox-Rabinovitz
 H. Mark Helfand
 Arthur Hou
 David J. Lamich
 Siegfried Schubert
 Joel Susskind
 Lawrence Takacs

The following are from NOAA/National Meteorological Center:

Wayman E. Baker
John Derber
Eugenia Kalnay
Masao Kanamitsu
Ants Leetmaa
James Miller
James Pfaendtner
Chester F. Ropelewski

References

Daley, R., 1991: Atmospheric Data Analysis. Cambridge University Press, 457 pp.

DAO, 1996: Algorithm Theoretical Basis Document, Data Assimilation Office, Goddard Space Flight Center.

Schubert, S., R. Rood, and J. Pfaendtner. 1993: An assimilated data set for earth science applications. *Bull. Amer. Meteor. Soc.*, **74**, 2331-2342.

Cohn, S.E., 1997: An introduction to estimation theory. *J. Meteor. Soc. Japan*, **75**, 257-288.

National Research Council, 1991: Four-Dimensional model assimilation of data. *National Academy Press*.

Investigation URL

<http://dao.gsfc.nasa.gov>

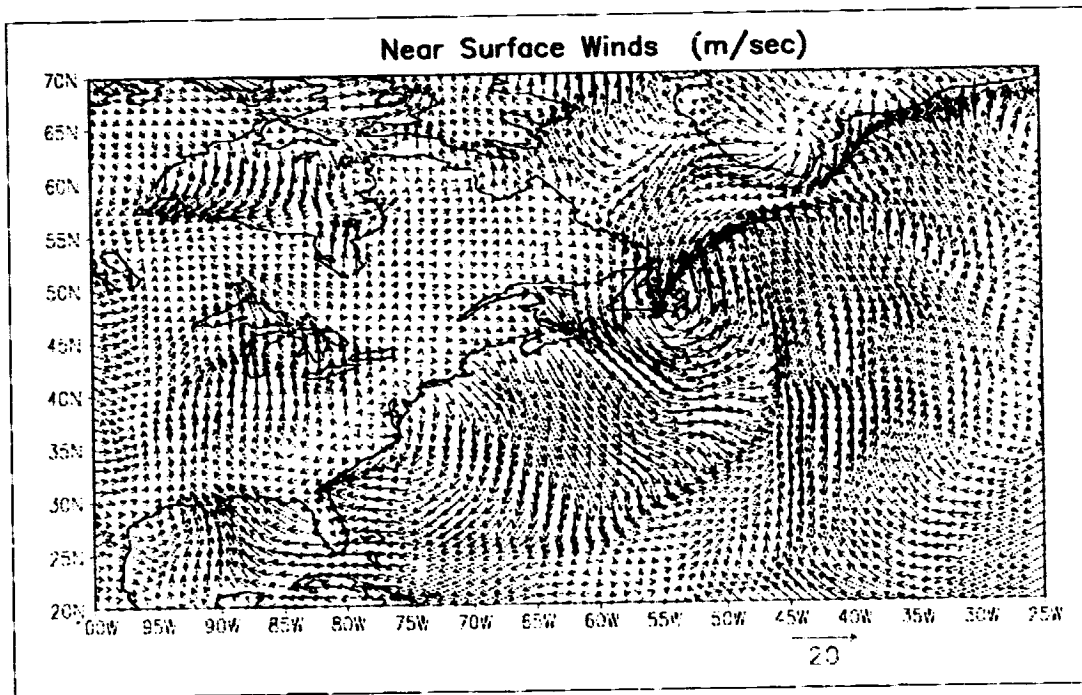

Assimilated atmospheric winds at 10 meters from the Goddard Earth Observing System Data Assimilation System with 1-degree horizontal resolution showing an intense low-pressure system off Nova Scotia and Newfoundland at 18 Z November 18, 1991.

Impacts of Interannual Climate Variability on Agricultural and Marine Ecosystems and Fisheries

Principal Investigator – **Cynthia Rosenzweig**

Science Background

In 1997, Pacific sea-surface temperatures were the highest on record, indicating an El Niño event of very large proportions. What are the agricultural consequences of El Niño events and how can scientists help in coping with them? Our EOS Interdisciplinary Science Team brings together six groups in order to create an 'end-to-end' analysis of El Niño predictions and their use in food production: Oceanographers who develop El Niño forecast models; atmospheric scientists who use global climate models (GCMs); remote-sensing specialists; agronomists whose tools include dynamic crop-growth models; marine ecologists; and economists.

The basis of the study is a set of linked regional analyses in places where El Niño events have strong or potentially important impacts on crops and fisheries. The study regions are the U.S. Corn Belt, Zimbabwe, the Brazilian Nordeste and Cerrados, and Southeastern South America (including parts of Brazil, Argentina, and Uruguay). The fishery study regions are the tropical Atlantic and the tropical Pacific regions. In each study region, we seek to understand the nature and geography of the agricultural systems and then to quantify the relationships among sea-surface temperatures, the phases of the El Niño cycle, climate variables (especially precipitation and temperature), and crop or fishery yields, production, and economic value.

Science Goals

The objectives of the project are to develop a coordinated methodological framework for assessment and prediction of the impacts of large-scale seasonal-to-interannual climate fluctuations, especially El Niño Southern Oscillation (ENSO) events, on important food-producing systems around the world. An additional objective is to improve the timing, geographic specificity, and accuracy of forecasts of regional climate anomalies and their impacts on agricultural and marine ecosystems. Furthermore, this project strives to investigate the potential for mitigation of negative climate-variability impacts on food production.

Current Activities

The challenge for this project is to make the connections among the research components to create an integrated whole, contributing to the practical application of research relating to the provision of world food supply. To that end, we are focusing on establishing methodological linkages among the modeling tools of each group. For example, we are testing the use of global GCM output in the dynamic process crop-growth models, and evaluating the agronomic feasibility of adaptations suggested by the economic analysis. A set of ensemble GCM runs was carried out using global observed sea-surface temperatures for the 1979-present time period and other climate forcings. SSTs for 1979-1988 were taken from the AMIP data sets, and those for subsequent years from the blended analysis approach of Reynolds (1988), already in-house at GISS. Results show that, in general, the GISS GCM simulates regional ENSO climate teleconnections adequately. Furthermore, the GCM is particularly helpful in understanding the climate dynamics contributing to regional variability. This is a key element in improving the use of regional climate predictions.

Use of Satellite Data

Each research area has a satellite data component.

ENSO Prediction: This work examines the ability of TOPEX data, with its complete spatial but coarse time resolution, to capture propagating features, especially the equatorial Kelvin waves critical to the ENSO mechanism. The results show the TOPEX view to be comparable in quality to an in situ array of echo sounders, and adequate for prediction studies.

GCM: A microwave postprocessor to the 9-vertical-layer Goddard Institute for Space Studies (GISS) GCM has analyzed simulated climates from the ensemble SST runs. This microwave radiative transfer model calculates the brightness temperature that would be observed by the MSU radiometer if it were orbiting the simulated GCM atmosphere. The MSU mean climatology of 1982-1991 has been used to examine the GCM's mean annual cycle;

the MSU regional, interannual variability; the GCM's internal variability; and the MSU time series of the GCM's thermodynamic response to observed SST.

Remote Sensing: The GIMMS component of the IDS team has produced a new global NDVI data set for the period of mid-1981 through 1997 from NOAA-7, NOAA-9, NOAA-11, and NOAA-14 data. Analysis of NDVI IDS data set is continuing to quantify ENSO influences on agricultural responses.

Agriculture: The El Niño signal is less pronounced in the U.S. Cornbelt than in regions such as Australia or Indonesia. Nonetheless, the ENSO signal is present, and distinguishable using coarse-scale Advanced Very High Resolution Radiometer (AVHRR) imagery.

Maximum monthly (AVHRR) Normalized Difference Vegetation Index (NDVI) values in the agricultural areas of the U.S. Cornbelt were summed over the growing season (June, July and August). The growing-season NDVI values were averaged at the Agricultural Statistics Districts (ASD) level and grouped by ENSO event. The seasonal profile of agriculture in the U.S. Cornbelt is preserved at the 8-km scale. On average, La Niña-year NDVI values are lower throughout the growing season than during either an El Niño or a neutral year.

To determine the spatial extent of ENSO impacts on agricultural areas in the U.S. Cornbelt, two methods of analysis were employed. In the first case, each year's NDVI values were related to the maximum NDVI value in the time series. In the second case, NDVI values during ENSO events values were compared with the 17-year mean. In both cases, the spatial extent of ASD regions sensitive to ENSO events is evident.

In general, corn yields during El Niño years are higher than average while yields during La Niña years are lower than average. Negative impacts during La Niña years on corn yields in the U.S. Cornbelt are more severe than the positive impacts of El Niño years (Phillips et al., 1996). Growing-season NDVI anomalies and yield anomalies for the time period in question are significantly correlated.

Marine Ecosystems: Ocean-color data from CZCS is being used to infer the effects of the Indonesian throughflow and ENSO on ecosystems in the Indo-Pacific basin.

Field Programs

We are working with a small group of experts and stakeholders from each study area to collaborate with us and advise on the project. These include climatologists, agronomists, economists, regional agricultural planners, and commodity group representatives.

Principal Investigator Cynthia Rosenzweig

Cynthia Rosenzweig is a Research Scientist at NASA/Goddard Institute for Space Studies and Adjunct Senior Research Scientist at Columbia University's Earth Institute. She earned advanced degrees from Rutgers University and the University of Massachusetts. Her research focuses on the potential impacts of environmental change, including global warming and El Niño events, on agricultural production at regional, national, and global scales. She is the co-author with Daniel Hillel of the new book, *Climate Change and the Globe Harvest*, published in 1998 by Oxford University Press.

Co-Investigators

Tony Busalacchi - NASA/Goddard Space Flight Center

Mark Cane - Lamont Doherty Earth Observatory

David Rind - NASA/Goddard Institute for Space Studies

Jim Tucker - NASA/Goddard Space Flight Center

References

Druryan, L.M., K.P. Shah, M.A. Chandler, and D. Rind, 1998: GCM hindcasts of SST forced climate variability over agriculturally intensive regions. *Climatic Change*, in press.

Myneni, R.B., C.D. Keeling, C.J. Tucker, G. Asrar, and R. Nemani, 1997: Evidence from satellite data for northern high-latitude increased photosynthetic capacity from 1982-1990. *Nature*, **386**, 698-705.

Myneni, R.B., S.O. Los, and C.J. Tucker, 1996: Satellite-based identification of linked vegetation index and sea-surface temperature anomaly areas from 1982-1990 for Africa, Australia, and South America. *Geophys. Res. Lett.*, **23**, 729-732.

Phillips, J.G., M.A. Cane, and C. Rosenzweig, 1997: ENSO, seasonal rainfall patterns and maize yield variability in Zimbabwe. *Agric. and Forest Meteorol.*, **90**, 39-50.

Phillips, J.G., B. Rajagopalan, M.A. Cane, and C. Rosenzweig, 1999: The role of ENSO in determining climate and maize yield variability in the U.S. Cornbelt. *Int. J. Climatology*, in press.

Shah, K.P., and D. Rind, 1999: Comparison of upper tropospheric and lower stratospheric temperatures: MSU, radiosonde, CIRA, and NCEP/NCAR reanalysis climatologies. *Mon. Wca. Rev.*, in press.

Investigator URL

<http://www.giss.nasa.gov>

POLAR Exchange at the Sea Surface (POLES)

Principal Investigator – **D. Andrew Rothrock**

Science Background

POLES is a broad investigation into the role of polar regions in the global energy and water cycles, and the atmospheric, oceanic, and sea-ice processes that determine that role. The primary importance of our investigation is to show how these polar processes relate to global climate.

Science Objectives

The objectives of our current research are:

- Determine the heat and moisture balance of the polar atmosphere, including the surface heat balance, radiation to space, and the transport of heat and moisture into the polar atmosphere from mid-latitudes.
- Determine more accurately the amounts of polar clouds and their effect on the surface and top-of-atmosphere radiative balance.
- Determine the turbulent surface fluxes of heat, momentum, and moisture and how they and radiative fluxes interact together with the atmospheric boundary layer and determine boundary-layer stability.
- Determine a “plumbing diagram” for heat and freshwater in the Arctic Ocean, their seasonal/interannual variabilities, and their impact on water-mass formation and the global thermohaline circulation.
- Determine the processes controlling sea-ice mass and momentum balance and extent, and their role in polar air-sea exchange.

Current Activities

The Atmosphere and Surface Fluxes—The atmospheric advection of energy into the Arctic from lower latitudes, and the deposition of that energy within the Arctic provides a primary link between the Arctic and the global climate system. We are analyzing an 18-year record of TOVS Polar Pathfinder temperature and moisture profiles, adding NCEP winds, and producing a climatology

of heat and moisture advection into the Arctic. We are exploring the variability of these transports and their connection with hemispheric atmospheric oscillations.

Radiative fluxes dominate the surface-energy budget over snow and ice throughout much of the year and in most high-latitude regions. We are producing critical data sets on cloud properties and their effect on radiative forcing of the sea-ice cover and are intercomparing these radiative-flux data sets with those commonly used in ice models and those computed in the NCEP and ECMWF reanalyses. We have created and analyzed a 2-m air-temperature data set from buoy and station data and have reported a warming trend for May and June: an earlier onset of the summer season.

The Ocean and Sea Ice – Significant changes in Arctic climate have been observed in the late 1980s and 1990s. Our models show that Atlantic Water inflow to the Arctic Ocean has increased in the early 1990s during the positive phase of the North Atlantic Oscillation, and that this increase enters mainly via the Barents Sea. We have discovered a remarkable and related reduction in the extent of the Cold Halocline Layer of the Arctic Ocean, as observed by both icebreaker and submarine cruise data.

Ice-Ocean Model Development and Testing – Ice-ocean models are an important component of global climate models. We are improving ice-ocean models, testing them, and making them more computationally efficient. We have undertaken a comparison of thickness as modeled and as observed by submarines. Such tests provide a new and crucial measure of performance for sea-ice models. We have constructed a global ice-ocean model that couples the latest GFDL Modular Ocean Model (MOM2) with our sea-ice model and our latest numerical scheme for ice dynamics, which is an order of magnitude faster than previous schemes. Together with our existing regional ice-ocean model for the north polar ocean, the global ice-ocean model allows us to examine the effects of global-scale ocean circulation and poleward oceanic heat transport on the behavior of the ice-ocean systems in both polar regions.

Algorithm Development, Data Set Production, and Validation – We have put considerable energy into improving algorithms for polar cloud and surface variables, and producing data sets based on these algorithms in collaboration with the AVHRR and TOVS Polar Pathfinders. Our strategy is to intercompare cloud and radiation products from AVHRR, and from TOVS, with each other and with available in situ and buoy data sets. By the end of this year we will have a full 18 years of TOVS Polar Pathfinder data and 14 years of AVHRR Polar Pathfinder data. As early products have been produced, we have worked to improve the performance of our algorithms and the efficiency of radiation codes by replacing the radiative transfer code Streamer with a neural network FluxNet.

Principal Investigator
D. Andrew Rothrock

Drew Rothrock earned his Ph.D. from the University of Cambridge in 1968, studying fluid mechanics. Since 1970, he has been affiliated with the University of Washington, where he is a Principal Research Scientist in the Applied Physics Laboratory and an Associate Research Professor in the School of Oceanography. His research interests include sea-ice dynamics and kinematics, and the remote sensing of polar geophysical processes with active and passive microwave, and thermal and visible satellite sensors.

Co-Investigators

Roger Barry - *University of Colorado*
Robert Brown - *University of Washington*
Frank Carsey - *Jet Propulsion Laboratory*
Jeffrey Key - *Boston University*
Seelye Martin - *University of Washington*
Michael Steele - *University of Washington*
Dale Winebrenner - *University of Washington*

References

- Francis, J.A., 1997: A method to derive downwelling long-wave fluxes at the Arctic surface from TIROS operational vertical sounder data. *J. Geophys. Res.*, **102**, 1795-1806.
- Key, J.R., J. Collins, C. Fowler, and R. Stone, 1996: High-latitude surface temperature estimates from thermal satellite data. *Rem. Sens. Environ.*, **61**, 302-309.
- Martin, S., E. Munoz, and R. Drucker, 1997: Recent observations of a spring-summer surface warming over the Arctic Ocean. *Geophys. Res. Lett.*, **24**, 1259-1261.
- Rothrock, D.A., and J. Zhang: Surface downwelling radiative fluxes: Ice model sensitivities and data accuracies. *Bull. Amer. Meteor. Soc.*, in press.
- Schweiger, A.J., and J. Key, 1997: Estimating surface radiation fluxes in the Arctic from TOVS HIRS and MSU brightness temperatures. *Intl. J. Rem. Sens.*, **18**, 955-970.
- Steele, M., and T. Boyd: Retreat of the cold halocline layer in the Arctic Ocean. *J. Geophys. Res.*, in press.
- Steele, M., J. Zhang, D. Rothrock, and H. Stern, 1997: The force balance of sea ice in a numerical model of the Arctic Ocean. *J. Geophys. Res.*, **102**, 21,061-21,079.
- Thomas, D., The quality of sea ice velocity estimates. *J. Geophys. Res.*, in press.
- Zhang, J., D.A. Rothrock, and M. Steele: Warming of the Arctic Ocean by a strengthened Atlantic inflow: model results. *Geophys. Res. Lett.*, submitted.

Investigation URL

<http://psc.apl.washington.edu/poles/>

Using Multi-Sensor Data to Model Factors Limiting Carbon Balance in Global Arid and Semiarid Land

Principal Investigator – **David S. Schimel**

Science Background

This Interdisciplinary Science investigation (IDS) is investigating the ecology of global ecosystems, focusing on arid land systems where climate and land use can produce very rapid changes in both ecosystem structure (the abundance and spatial distribution of woody, grass, and desert vegetation) and function (plant and animal productivity, trace gas and carbon exchange with the atmosphere, hydrology). We are also investigating the response of ecosystems regionally and globally to interannual climate variability using field studies, modeling and remote sensing to determine, observationally, ecosystem responses to climate as a basis for projecting effects of longer term climate changes. The IDS is based on the use of multisensor remote-sensing techniques, and has developed algorithms that use MODIS, MISR, Landsat, and ASTER data synergistically.

Science Goal

Quantification of the impacts of land use and climate on ecosystems of the Earth's arid and semiarid zones

Current Activities

Key principal activities are: 1) the analysis of Pathfinder AVHRR data sets for interannual variability in ecosystems and linking that variability to changes in atmospheric CO₂, and 2) development of techniques utilizing radiative-transfer modeling to retrieve land-surface characteristics.

Use of Satellite Data

The investigation is using satellite data in three main ways. First, in Northern China and Mongolia, we are mapping land cover and land-cover change to identify trends in management as part of a study of grassland ecosystem function. This subproject emphasizes Landsat. Second, we are using Landsat and AVHRR data in a pilot study prototyping our radiative-transfer inversion algorithms for retrieving light interception by foliage and litter, phenol-

ogy, and albedo. This work focuses on regional studies in West Africa, the southwestern U.S., and Brazil. Third, we are using Pathfinder AVHRR to analyze interannual variability in NDVI in relation to temperature. This work suggests that northern ecosystems have high NDVI in warm years, while arid ecosystems have low NDVIs in warm years; cold years produce the opposite responses. There are also lagged correlations of NDVI with temperature that are suggestive of nutrient-cycling feedbacks.

Participation in Field Activities

The investigation is carrying out field studies in the southwestern U.S. and northeastern Brazil aimed at collecting the ground optical measurements needed to operate and validate radiative-transfer models for interpreting satellite data.

Principal Investigator

David S. Schimel

David Schimel is a senior scientist at the National Center for Atmospheric Research and a member of the College of Natural Resources, Colorado State University. Schimel's research focuses on the ecological control of terrestrial biogeochemistry. He has reported extensively on the role of nutrient cycling in regulating terrestrial ecosystem processes, on the global carbon cycle, and on the development of ecosystem models. He served as Convening Lead Author for the IPCC assessment of the carbon cycle. Schimel is also active in the development of techniques for studying large-scale processes in ecosystems, including the use of remote sensing.

Co-Investigators

Steve Archer - *Texas A&M University*

Brian Curtiss - *University of Colorado*

Alex Goetz - *University of Colorado*

Timothy Kittel - NCAR

William Parton - Colorado State University

Carol Wessman - University of Colorado

Investigation URL

<http://kiwi.atmos.colostate.edu/ids/>

References

Braswell, B.H., D.S. Schimel, E. Linder, and B. Moore III, 1997: The response of global terrestrial ecosystems to interannual temperature variability. *Science*, **278**, 870-872.

Braswell, B.H., D.S. Schimel, J.L. Privette, B. Moore III, W.J. Emery, E.W. Sulzman, and A.T. Hudak, 1996: Extracting ecological and biophysical information from AVHRR optical data: an integrated algorithm based on inverse modeling. *J. Geophys. Res.*, **101**, 23,335-23,348.

Schimel, D.S., B.H. Braswell, and VEMAP Participants, 1997: Continental scale variability in ecosystem processes: models, data and the role of disturbance. *Ecological Monographs*, **67**, 251-271.

Investigation of the Chemical and Dynamical Changes in The Stratosphere

Principal Investigator – **Mark R. Schoeberl**

Science Background

This interdisciplinary science investigation focuses on analyzing stratospheric and tropospheric chemical and dynamical changes using EOS instruments and current satellite and aircraft data sets.

Complex and subtle chemical changes are occurring within the Earth's atmosphere, mostly as a result of changes in the surface emission of important trace gases. This investigation is primarily interested in the response of ozone to these trace-gas changes, changes in stratospheric ozone as a result of increasing human-made chlorine, potential changes due to aircraft emissions, and tropospheric ozone changes due to biogenic activity such as land-use changes, industrial pollutants, and biomass burning. To separate natural changes in trace gases from those generated by human activity, high-quality data sets are needed for analysis. Interpretation of the changes requires complex chemical models. In addition to analysis of the data, this investigation is responsible for the production and quality of chemical data products produced by the EOS Data Assimilation effort.

Science Goal

The scientific goal of the investigation is to isolate natural from anthropogenic chemical changes in the Earth's atmosphere to determine their effects on ozone and to assess radiative and dynamical feedbacks.

Current Activities

The data-analysis effort supports the development and validation of models being created as part of this investigation, while the modeling effort supports interpretation of the data. There are three major activities within this group: model development, satellite and aircraft data analysis, and chemical assimilation/data-set generation.

Model development – This investigation has developed two models. The first is a fully interactive 2-dimensional chemical/dynamical model. This model is being used to examine the dynamical feedbacks associated with ozone loss and the impact of natural and man-made pollution. Because of the computational cost of fully 3D interactive chemical models, the 2D interactive model is the only way we can currently examine the interaction

between radiative feedbacks and chemical depletions. The 2D model is being used to investigate the impact of CO₂ increase on stratospheric ozone, the effect of volcanic eruptions, and the radiative feedbacks of sub-visible cirrus at the tropopause.

We have also developed a Lagrangian Chemical Model which, along with the off-line 3D Chemical Model (partially supported under this investigation), is being used to investigate the evolution of the annual polar-ozone depletions and to analyze aircraft observations. Using the Lagrangian model we have been able to simulate the development of the Antarctic ozone hole, and have predicted its evolution under different anthropogenic chlorine-loading scenarios.

Analysis of satellite and aircraft data – Our second major activity involves the analysis of satellite and aircraft data with regard to model validation and increasing our understanding of the chemical processes within the stratosphere. We are currently focusing most of our efforts on analysis of Upper Atmosphere Research Satellite (UARS) data and data from the latest series of aircraft expeditions. Using the trajectory-mapping technique, and reverse domain filling (RDF) developed under this Interdisciplinary Science investigation (IDS), we have been able to utilize meteorological constraints on trace-gas measurements in an optimal way. This IDS also maintains a 'user run' trajectory-model service for the community. In 1997, there were over 100 users with over 7000 accesses for this service.

Analysis of the UARS data is especially important for this investigation since the UARS instruments, CLAES, ISAMS, and MLS are progenitors of the EOS CHEM instruments (HIRDLS, MLS). We also continue with our analysis of the TOMS data with respect to the size and variability of the polar-ozone depletions. We are also analyzing the European GOME data set. CHEM will fly the Dutch-provided OMI, which is similar to TOMS and GOME in measurement capability. We have also done extensive analysis of the CRISTA data set. CRISTA, which was flown on the Shuttle, is a high-horizontal-resolution limb sounder. CRISTA data provide a good test of our analysis methods for HIRDLS data.

Members of our team have been the project scientists for four aircraft expeditions: STRAT, TOTE/VOTE, POLARIS, SONEX. We will also be involved in the 1999/00 Sage III validation mission (SOLVE).

Chemical assimilation/data-set generation – The third major activity of this investigation is the development of meteorological and chemical data sets for EOS-DIS. Sixteen years of NMC global stratospheric data have been analyzed, and balanced winds and potential vorticity have been produced and transferred to the Goddard DAAC. Under development is a chemical assimilation model which will directly assimilate satellite chemical measurements. Here we work in close collaboration with the EOS Data Assimilation Office. We are responsible for stratospheric meteorological data quality and the quality control of the chemical assimilation system. We are currently using UARS data as a test of that system and have generated prototype data sets using UARS CLAES nitrous oxide measurements and HALOE methane data.

Principal Investigator

Mark Schoeberl

Mark Schoeberl received his Ph.D. from the University of Illinois in 1976. He has 23 years of research experience in atmospheric dynamics, stratospheric physics, and numerical modeling. He is the author or co-author of more than 130 scientific papers and has been affiliated with NASA/Goddard Space Flight Center since 1983. He is the Upper Atmosphere Research Satellite Project Scientist, and he was co-project scientist for the TOTE/VOTE aircraft mission. Within his field of research, he has chaired multiple conferences and committees, and has served in an editorial capacity for several journals. He is a recipient of the NASA Exceptional Scientific Achievement and Outstanding Leadership Medals. He is a fellow of the American Geophysical Union, fellow of the American Meteorological Society, and fellow of the American Association for the Advancement of Science. He was elected president of the American Geophysical Union's Atmospheric Sciences Section for the term 1998-00.

Co-Investigators

Steve E. Cohn - NASA/Goddard Space Flight Center

Anne R. Douglass - NASA/Goddard Space Flight Center

Marvin A. Geller - State University of New York-Stony Brook

James Gleason - NASA/Goddard Space Flight Center

Robert D. Hudson - University of Maryland-College Park

Charles H. Jackman - NASA/Goddard Space Flight Center

Leslie R. Lait - Raytheon ITSS Corporation

Paul A. Newman - NASA/Goddard Space Flight Center

Richard B. Rood - NASA/Goddard Space Flight Center

Joan E. Rosenfield - General Sciences Corporation

Richard S. Stolarski - NASA/Goddard Space Flight Center

Anne M. Thompson - NASA/Goddard Space Flight Center

References

Douglass, A.R., M.R. Schoeberl, R.S. Stolarski, J.W. Waters, J.M. Russell III, and A.E. Roche, 1995: Interhemispheric differences in springtime deactivation of vortex CIO. *J. Geophys. Res.*

Morris, G.M., M.R. Schoeberl, L. Sparling, P.A. Newman, L.R. Lait, L. Elson, J. Waters, R. Sutjic, A. Roche, J. Kumer, and J.M. Russell III, 1995: Trajectory mapping and applications to data from the Upper Atmosphere Research Satellite. *J. Geophys. Res.*, **100**, 16,491-16,505.

Newman, P., and M.R. Schoeberl, 1995: A reinterpretation of the data from the NASA stratosphere-troposphere exchange project. *Geophys. Res. Lett.*, 2501-2504.

Rosenfield, J.E., D. Considine, M.R. Schoeberl, and E. Browell, 1998: The impact of subvisible cirrus clouds near the tropical tropopause on stratospheric water vapor. *Geophys. Res. Lett.*, **25**, 1883-1886.

Schoeberl, M.R., et al., 1996: The development of the Antarctic ozone hole. *J. Geophys. Res.*, **101**, 20,909-20,924.

Schoeberl, M.R., C.H. Jackman, and J.E. Rosenfield, 1998: A Lagrangian estimate of aircraft effluent lifetime. *J. Geophys. Res.*, **103**, 10,817-10,825.

Schoeberl, M.R., and P.A. Newman, 1998: A multiple level trajectory analysis of vortex filaments. *J. Geophys. Res.*, **100**, 25,801-25,815.

Sparling, L.C., A.R. Douglass, and M.R. Schoeberl, 1998: An estimate of the effect of unresolved structure on modeled ozone loss from aircraft observations of CIO. *Geophys. Res. Lett.*, 305-308.

Thompson, A.M., et al., 1996: Where did tropospheric ozone over southern Africa in the tropical Atlantic come from in October 1992: Insights from TOMS, GTE TRACE A, and SAFARI 1992. *J. Geophys. Res.*, **101**, 24,251-24,278.

Investigation URL

<http://hyperion.gsfc.nasa.gov/EOS/EOS.html>

Interdisciplinary Determination of Snow Accumulation Patterns on the Greenland Ice Sheet: Combined Atmospheric Modeling and Field and Remote Sensing Studies

Principal Investigator – **Christopher A. Shuman**

Science Background

Ice sheets play a critical role in the global climate system. Not only do they currently store enough water to raise global sea level 10s of meters, but they affect the climate system directly and even act as a recorder of climate system temperature and atmospheric composition. This Interdisciplinary Science investigation focuses on improving the determination of the incoming mass flux to the Greenland Ice Sheet as a means of more-accurately assessing polar mass balance as suggested by the U.S. Global Change Research Program (USGCRP).

Both direct glaciological and indirect meteorological assessments provide the necessary means of assessing polar mass balance, albeit with their relative costs and limitations. This proposal will contemporaneously integrate improved meteorological and glaciological observations to produce an enhanced characterization of accumulation patterns over the Greenland ice sheet at multiple sites. Because this approach makes extensive use of remote-sensing data, it is well-suited to the development of EOS instruments and should facilitate long-term monitoring of polar ice. If this integrated approach is successful, it will, by extension, increase confidence in the indirect atmospheric-modeling approach that can be used to predict precipitation/accumulation across the climatically and politically sensitive Arctic region.

Science Goal

In this research, we propose to: 1) use a high-resolution diagnostic-dynamic atmospheric model to obtain sub-seasonal and annual estimates of precipitation for specific locations distributed over the Greenland ice sheet (NASA project with PI David H. Bromwich); and 2) use a combination of high-resolution stable-isotope ($d^{18}O$ and dD) profiling in numerous snow pits with comparisons to satellite brightness-temperature trends to document the amount, rate, and timing of accumulation at the same locations. The resulting comparisons will assess the reliability of the atmospheric modeling approach to accumulation monitoring for ice-sheet mass-balance studies. This

will provide a critical data set for comparison to, and validation of, the hydrologic elements of global climate model results. Additionally, through the collection and compilation of numerous high-resolution (> 20 samples per year) stable-isotope profiles distributed across Greenland, a database will be compiled which can be used to assess issues critical to some paleoclimate variables.

Current Activities and Field Programs

Current activities are focused on the extensive database of isotope profiles being provided by collaborators at the Alfred Wegner Institut Für Polar Und Meeresforschung from their North Greenland Traverse over the past several years as well as additional data from field expeditions to Greenland in the spring of 1997, 1998 and again in 1999 (see figure on the following page). Once these isotope and associated density profiles are obtained, they will be compared to Special Sensor Microwave/Imager (SSM/I) trends from equivalent time periods and accumulation amount, rate, and timing information will be derived. These field- and remote-sensing-based accumulation assessments will be compared to the meteorological analysis results, currently being developed by David H. Bromwich (BPRC-OSU), and an assessment of the accuracy of their accumulation amount and timing information will be made.

Use of Satellite Data

The relationship of satellite passive-microwave brightness temperature (TB) to physical temperature is described by the Rayleigh-Jeans approximation. In this approximation, satellite brightness temperature is the product of the physical temperature of the near-surface snow multiplied by its emissivity. In central Greenland, the daily average 37 GHz V brightness temperature trend is similar to the isotope record from the approximate corresponding depth interval of a sample snow pit. The similar trends of these temperature indicators supports the assertion that stable oxygen and hydrogen isotope ratios record temperature variations in accumulating snow in central Greenland

Summit with relatively high frequency. Brightness-temperature data from an SSM/I 37-GHz V (0.81-cm wavelength) channel are available starting in July 1987. The passive-microwave data used in this study will be obtained from the National Snow and Ice Data Center. Temperature calibration of the 37-GHz V data will be based on available AWS records. The EOS-era instrument, AMSR-E, will improve the precision of this technique through its improved spatial and spectral resolution.

Principal Investigator

Christopher A. Shuman

Christopher A. Shuman received M.S. and Ph.D. degrees in Geology and Geosciences from the Pennsylvania State University and was a postdoctoral researcher there and with the National Research Council at NASA's Goddard Space Flight Center (GSFC). Shuman is currently a Universities Space Research Association Visiting Research Fellow at GSFC. His research interests include monitoring the state of the current climate system over the great polar ice sheets with field and remote-sensing data and how paleoclimate variations are preserved in polar snow and ice. He is a member of the science team currently working at the Siple Dome deep-ice-core site in West Antarctica.

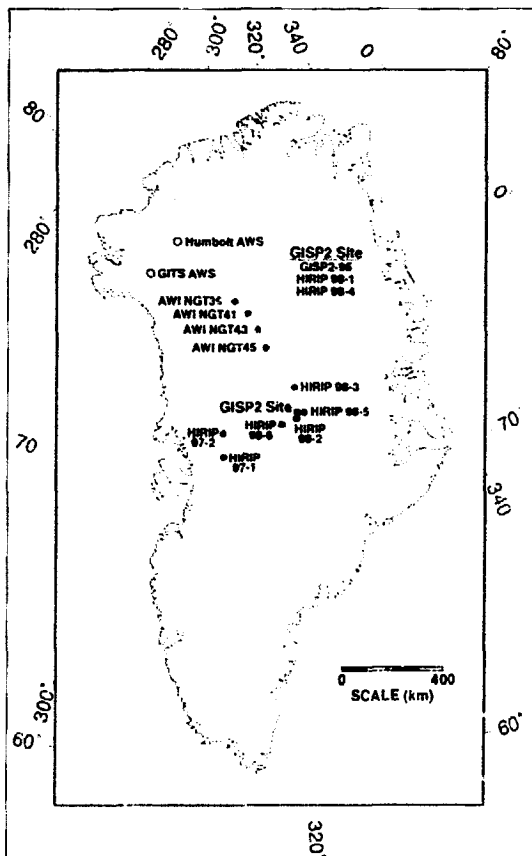

Location of high-resolution isotope profiles used in this study.

Co-Investigators

Robert A. Bindshadler - NASA/Goddard Space Flight Center

David H. Bromwich - Byrd Polar Research Center, Ohio State University

References

Shuman, C.A., R.B. Alley, M.A. Fahnestock, R.A. Bindshadler, J.W.C. White, and J. Winterle, 1998: Temperature history and accumulation timing for the snow pack at GISP2, central Greenland. *J. Glaciol.*, **44**, 21-30.

Shuman, C.A., R.B. Alley, M.A. Fahnestock, P.J. Fawcett, R.A. Bindshadler, S. Anandkrishnan, and C.R. Stearns, 1997: Detection and monitoring of annual indicators and temperature trends at GISP2 using passive microwave remote sensing data, GISP2-GRIP Compendium Volume. *J. Geophys. Res.*, **102**, 26,877-26,886.

Shuman, C.A., M.A. Fahnestock, R.A. Bindshadler, R.B. Alley, and C.R. Stearns, 1996: Composite temperature record from the Greenland summit, 1987-1994: Synthesis of multiple automatic weather station records and SSM/I brightness temperatures. *J. Climate*, **9**, 1421-1428.

Shuman, C.A., R.B. Alley, S. Anandkrishnan, J.W.C. White, P.M. Grootes, and C.R. Stearns, 1995: Temperature and accumulation at the Greenland Summit: Comparison of high-resolution isotope profiles and passive microwave brightness temperature trends. *J. Geophys. Res.*, **100**, 9165-9177.

Shuman, C.A., R.B. Alley, S. Anandkrishnan, and C.R. Stearns, 1995: An empirical technique for estimating near-surface air temperatures in central Greenland from SSM/I brightness temperatures. *Rem. Sens. Environ.*, **51**, 245-252.

Shuman, C.A., and R.B. Alley, 1993: Spatial and temporal characterization of hoar formation in central Greenland using SSM/I brightness temperatures. *Geophys. Res. Lett.*, **20**, 2643-2646.

Shuman, C.A., R.B. Alley, and S. Anandkrishnan, 1993: Characterization of a hoar-development episode using SSM/I brightness temperatures in the vicinity of the GISP2 site, Greenland. *Annals of Glaciology*, **17**, 183-188.

Investigation URL

<http://igloo.gsfc.nasa.gov/~shuman/home.html>

Influence of Subgrid-Scale Heterogeneity on Remotely-Sensed Surface Temperature

Principal Investigator – **W. James Shuttleworth**

Science Background

Over the last decade there has been substantial progress in understanding how best to represent subgrid-scale heterogeneous land cover in meteorological models. Meanwhile there has been rapid (but still ongoing) progress in providing the remotely sensed land-cover data to apply that understanding. Research has established the value, usefulness, and feasibility of applying remotely sensed land-cover classes when describing heterogeneous land cover in meteorological models used for free-running seasonal, interannual, and longer-term climate prediction. However, no attempt has yet been made to apply present-day theory and methods for representing heterogeneous cover in the Numerical Weather Prediction (NWP) models such as those used with four-dimensional data assimilation (4DDA) to provide gridded data in the Global Energy Water-cycle Experiment (GEWEX) continental-scale projects. Nor has their use been investigated in the context of the EOS data-assimilation models.

Science Goal

The overall goal of this investigation is to elucidate issues and explore assimilation methods relevant to using remotely sensed data on land cover, surface temperature, and surface radiation to aid the diagnosis of the surface-energy budget in the mesoscale models used for 4DDA in the GEWEX large scale field experiments.

We intend to:

- 1) develop methods which will allow use of remotely sensed land-cover data to improve representation of heterogeneous land cover in regional-scale meteorological models used for 4DDA, specifically the Eta model at the National Centers for Environmental Prediction (NCEP) and the Eta model at the Brazilian Center for Weather and Climate Prediction (CPTEC);
- 2) carry out model experiments to investigate whether subgrid-scale variations in land cover, topography, and surface-induced atmospheric circulation can de-

tract from the value of area-average, remotely sensed surface temperature as a diagnostic of surface-energy partition;

- 3) develop and apply current aggregation theory to provide an aggregation algorithm which calculates grid-average surface-energy fluxes from data on land-cover class, surface temperature, and surface radiation available at subgrid scale; and
- 4) test whether the grid-average surface-energy fluxes given by the aggregation algorithm, when assimilated into a model with grid-scale representation of surface-atmosphere interactions, provide a diagnosis of area-average surface-energy partition which follows that given by the subgrid-scale data fields.

Current Activities

Much of the research will be carried out using the Regional Atmospheric Modeling System (RAMS) running nested within the atmospheric fields calculated by (the relevant versions of) the Eta model used for 4DDA at NCEP and CPTEC. We will carry out model experiments at appropriately heterogeneous sites, two in the U.S. and two in Brazil. The nested-modeling experiments are ongoing for the San Pedro valley in Southern Arizona (a semi-arid site).

A second U.S. site in the Tennessee valley (a moist site) has been selected so that we can compare and contrast with the Arizona site the possible importance of topography-generated wind-speed differences on grid-average surface-energy balance. The two Brazilian sites, around Ji-Parana in Rondonia (where there is managed forest clearance) and around Santerem in Para (where there is haphazard clearance and a large river) have been chosen to allow us to investigate the possible importance of land-cover-induced mesoscale atmospheric circulation. This investigation will continue and expand a long-standing working relationships between the PI and scientists at NCEP and CPTEC that has proven effective in past joint research studies.

Use of Satellite Data

We have implemented the Pinker and Laszlo (1992) algorithm for modeling surface solar irradiance using geostationary satellite data, and we are assimilating the solar data into the nested RAMS runs. Currently, remotely sensed land-cover data are available in the form of pathfinder data sets with global coverage for model-relevant cover classes at a 1×1 -km pixel size. It is to be anticipated that provision of such land-cover data will soon become routine using data provided by the Earth Observing System. We will develop and test novel theoretical ideas for assimilating remotely sensed thermal data from a variety of platforms and over a wide range of spatial resolutions. The ultimate goal of assimilating a variety of satellite data is to allow coupled hydrologic-atmospheric models to routinely document surface energy and water exchanges.

Participation in Field Activities

Our research will contribute scientific input to and draw data, from the GEWEX Continental-scale International Project (GCIP), the Large-scale Biosphere-Atmosphere (LBA) Experiment, and the Semi-Arid Land-Surface-Atmosphere (SALSA) Program. We are proposing to actively participate in the LBA experiment as part of the LBA Science Team.

Principal Investigator

W. James Shuttleworth

Prior to joining the Department of Hydrology and Water Resources at the University of Arizona in January 1993, Dr. Shuttleworth was Head of the Hydrology Processes Division of the prestigious Institute of Hydrology, United Kingdom. His major research interests are in physical processes in hydrology, with emphasis on evaporation and hydrometeorology, as applied to environment change at local, regional, and global scales. Present research includes: the representation of heterogeneous land surfaces in Global Climate Models, the application of remote-sensing methods within hydrology, and the micrometeorology of natural semi-arid vegetation and riparian systems in the desert Southwest. He serves on committees for the International Council of Scientific Unions, the International Hydrology Programme, the International Geosphere-Biosphere Project and the World Climate Research Programme, and on the NRC Committee for Global Change Research and on the Panel on the Global Ocean Atmosphere Land System

Co-Investigators

James J. Toth - *University of Arizona*

References

Arain, A. M., W. J. Shuttleworth, Z.-L. Yang, J. D. Michaud, and A. J. Dolman, 1997: Mapping surface cover parameters using aggregation rules and remotely sensed cover classes. *Quart. J. Roy. Meteor. Soc.*, **123**(B), 2325-2348.

McNider, R. T., A. J. Song, D. M. Casey, P. J. Wetzel, W. L. Crosson, and R. M. Rabin, 1994: Toward a dynamic-thermodynamic assimilation of satellite surface temperature in numerical atmospheric models. *Mon. Wea. Rev.*, **122**, 2784-2803.

Pinker, R. T., and I. Laszlo, 1992: Modeling surface solar irradiance for satellite applications on a global scale. *J. Appl. Meteor.*, **31**, 194-211.

Sellers, P. J., D. A. Randall, G. J. Collatz, J. A. Berry, C. B. Field, D. A. Dazlich, C. Zhang, and L. Bounoua, 1996: A revised land surface parameterization (SiB2) for atmospheric GCMs. Part I: Model formulation. *J. Climate*, **9**, 676-705.

Shuttleworth, W. J., 1998: Combining remotely sensed data using aggregation algorithms. *Hydrology and Earth System Sciences*, **2**, 149-158.

Shuttleworth, W. J., Z.-L. Yang, and A. M. Arain, 1997: Aggregation rules for surface parameters in global models. *Hydrology and Earth System Sciences*, **2**, 217-226.

Investigation URL

<http://www.hwr.arizona.edu/heterogeneity>

Development and Application of the Next Generation of Ocean Color Models for the Understanding of Marine Processes on Regional and Global Scales

Principal Investigator – **David A. Siegel**

Science Background

Satellite ocean color imagery provides more information than just the chlorophyll a concentration, a measure of phytoplankton pigmented biomass. Frankly, the next set of scientific questions for the ocean biosphere will require considerably more extensive and diverse set of ocean color data products than we have today. Questions related to partitioning of the upper ocean carbon budget, estimation of air-sea CO₂ exchange, tropospheric aerosol production due to dimethyl sulfide emissions, photochemical production of greenhouse related important trace gases (such as CO, COS, etc.) and probably the remote estimation of water column integrated primary production rates require more information about the marine biosphere than is supplied by just the chlorophyll pigment concentration.

Ocean optics research has shown that an ocean color spectrum contains some of the missing information and several recent ocean color models have been developed to determine the concentration of phytoplankton pigments, the recycled, colored organic materials and the intensity of particulate backscatter. It is our opinion, substantial progress in the application of satellite technology to ocean biology and biogeochemical processes requires the development and application of a new generation of ocean color tools. In this way, we will begin to achieve the maximum scientific return from NASA's (and other international space agency) infrastructure investments.

Science Goal

One of the major objectives of our work is to assess inherent optical properties of the upper ocean on global and regional scales using data from the on-going SeaWiFS ocean color mission. Our algorithms have provided the means for determining simultaneously the concentration of phytoplankton pigments, the abundance of colored organic materials and the intensity of particulate backscatter. Our first goal is to simply address the time-space distributions of these optically important, in-water constituents and to assess their relationship with physical forcing mechanisms.

However, these "global solutions" must work on regional scales as well as global scales. Hence, we validate our state-of-the-art ocean color models using data collected by our group from the NASA SIMBIOS supported Bermuda BioOptics Project (BBOP) time series in the Sargasso Sea and the NOAA-COP/ONR supported Plumes and Blooms field study of the Case II waters of the Santa Barbara Channel. This allows us to develop new ocean color "tools" and to assess their utility in addressing biogeochemical and biological processes. By comparing the results derived from global and regional data sets, we can assess the global validity of common ocean color modeling assumptions and may be able to make improvements in retrieval results by parameterizing regional differences in the retrieved model parameters. In this way, we will develop "optimal" ocean color products from SeaWiFS, MODIS, etc.

Use of Satellite Data

Satellite ocean color data measured from SeaWiFS are critical for this work. We will also use data from MODIS, MISR and a host of international ocean color imagers (GLI, POLDER-2, MERIS, etc.) as they become available. In addition, we have and will continue to use other satellite data sets, including altimetry (TOPEX/Poseidon, ERS, Jason, etc.), ISCCP cloud fields, sea surface temperature (AVHRR pathfinder, MODIS), and TOMS ozone.

Participation in Field Activities

Our group has extensive, on-going field work programs in both the open sea of the Sargasso Sea (BBOP) and the coastal waters of the Santa Barbara Channel (Plumes and Blooms). These programs provide field data that are used to develop and validate our next generation of ocean color algorithms. We also participate extensively with the SIMBIOS program.

Principal Investigator**David A. Siegel**

David Siegel is a professor of oceanography at the Institute for Computational Earth System Science. He has academic appointments in the Department of Geography and the Donald Bren School of Environmental Science and Management and is an adjunct faculty member of the Bermuda Biological Station for Research. His research interests are mainly associated with the role of the oceans in the earth system, particularly in the area of ocean color remote sensing and its application to understanding global biogeochemical cycles.

Co-Investigators

Stephane Maritorena - *Institute for Computational Earth System Science*

Norman B. Nelson - *Bermuda Biological Station for Research*

Anthony F. Michaels - *USC Wrigley Institute for Environmental Studies*

Climate Change and Human Response in the Semi-arid Near East

Principal Investigator – **Ronald B. Smith**

Science Background

The Southwest Asian region lies at the junction of three continents: Europe, Asia, and Africa. It includes Turkey, Syria, Lebanon, Israel, Iraq, Iran, Jordan, Armenia, Azerbaijan, Kuwait, Turkmenistan, and Saudi Arabia. Most of this region is characterized by a semi-arid Mediterranean climate with a strong N-S gradient and interannual variations in precipitation, a rapidly rising population (3-5% per year), inaccessible environmental data sets, and a long 6000-year history of human influence on the landscape. Over the last quarter century, due to climate, population, economic pressure, and governmental policy, the landscape has been changing rapidly.

Science Goal

The goal of the Southwest Asia Project (SWAP) is to summarize and understand the last 25 years of landscape changes in the region, including the influence of climate and human factors. In addition, this research will identify those special physical attributes and resource issues in the region which affect the choice and use of remote-sensing technologies for environmental monitoring.

Current Activities

In collaboration with the International Center for Agricultural Research in Dry Areas (ICARDA), we are pursuing five parallel research subprojects:

- large-scale agro-ecological characterization
- impact of interannual climate fluctuation
- crop growth and yield
- rangeland degradation and restoration
- evaluation of new remote-sensing technology

Each of these projects requires remote sensing, the analysis of archival data, field work, and the development of international partnerships.

Use of Satellite Data

Three types of satellite data are used most heavily in the Southwest Asia Project: Composite AVHRR, Landsat, and SIR-C radar. Other data types, including Seasat, ERS-1-2, Radarsat, MODIS, and ASTER are under evaluation.

The subproject on agro-ecological characterization uses multi-temporal NDVI to estimate the spatial distribution of natural vegetation and agriculture. A systematic process of verification and iterative correction of these estimates is underway using field visits and Landsat images. Composite AVHRR time series are also used in conjunction with conventional climate data and gridded hydrologic models to study interannual variation of vegetation over a 15-year period.

The subproject on crop growth and yield is refining the use of conventional broadband and hyperspectral image data to estimate biophysical descriptors of dry-land and irrigated agriculture in the Near East including wet biomass, leaf-area index and yield, along with crop type and stage. This study requires extensive ground-level-reflectivity measurements as well as real-time Landsat acquisitions.

The subproject on rangelands requires the application and refinement of new remote-sensing techniques to measure sparse vegetation in disturbed steppe regions. The statistical analysis of SIR-C and Landsat data is underway along with ground verification. Plans are being developed for the application of ERS-1-2, Seasat, ASTER, and MODIS to the rangeland/steppe problem.

Participation in Field Programs

The various field components of SWAP are carried out in collaboration with ICARDA, FAO, and other established regional partners. These field activities consist of ground surveys and sample analyses, point measurements of climate and soil moisture variables, and hyperspectral measurements of soil-vegetation reflectivity and atmospheric absorption and scattering.

Co-Investigators

Frank Hole - Yale University

Xuhui Lee - Yale University

Mark Wilson - Yale University

References

Smith, R.B., et al., 1997: A climate and vegetation atlas of the fertile crescent. CEO, Yale University, Department of Geology and Geophysics, New Haven, Connecticut, Internal Publication, 1-34.

Thenkabail, P., R.B. Smith, and E. DePauw, 1999: Hyperspectral Vegetation Indices for Determining Agricultural Crop Characteristics. *Remote Sens. Environ.*, in press.

Kouchoukos, N., et al., 1998: Monitoring the Distribution, Use and Regeneration of Natural Resources in Semi-arid Southwest Asia. *Yale F&ES Bulletin*, 103, 1-24

Smith, R.B. et al, 1999: Spatial analysis of climate, landscape, and hydrology in the Middle East: Modeling and Remote Sensing. In prep.

Investigation URL

<http://spectra.ceo.yale.edu/swap.html>

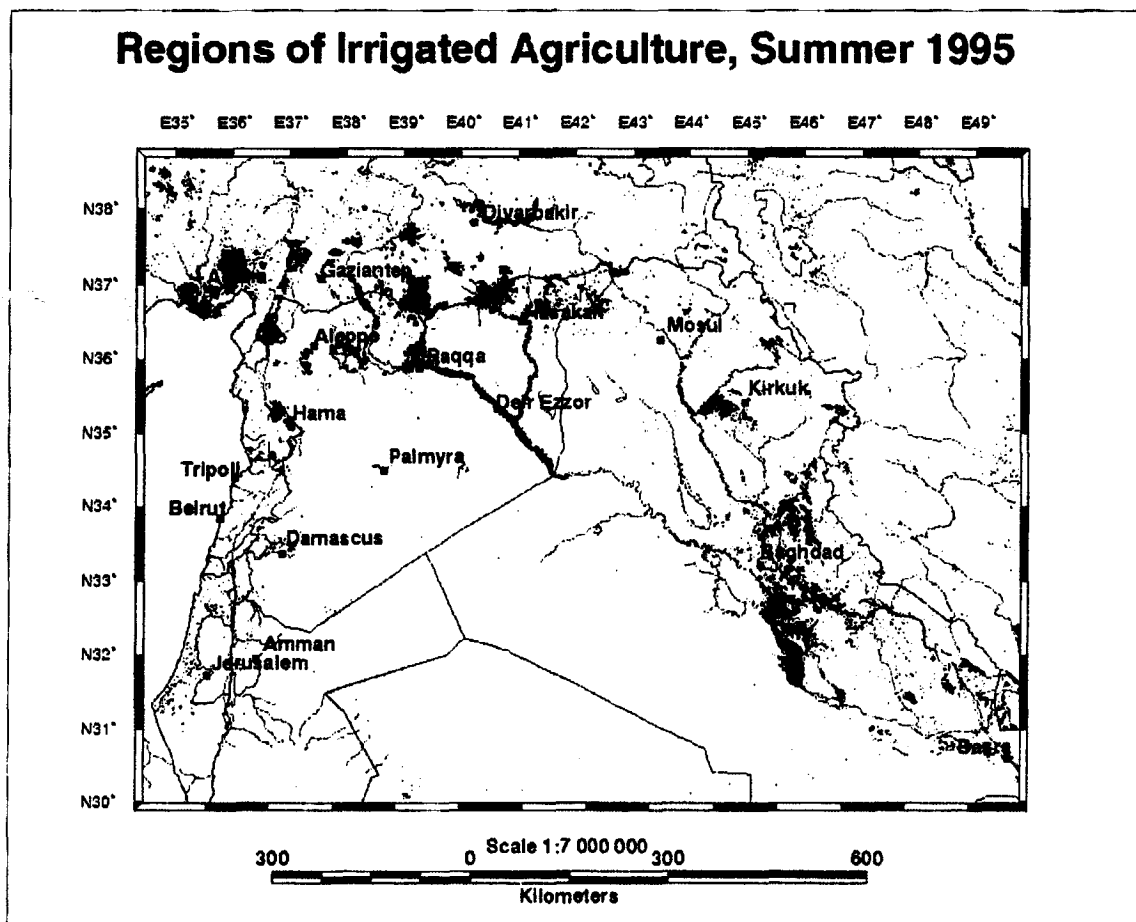

Using composite AVHRR imagery and simple models, several aspects of Middle East hydrology can be monitored including upland snow cover, river discharge, irrigated agriculture, and rain-fed farming. This image shows, with a spatial resolution of one kilometer, the active irrigated agriculture during the summer of 1995. The largest of these regions are on the lower Ceyhan near Adana in Turkey, the GAP project in Turkey near the Syrian border, new projects near Raqqa and Aleppo in Syria, historic farms along the Syrian Euphrates and in Mesopotamia near Baghdad, Iraq. These patterns of irrigation have changed dramatically over the last 15 years.

Long-Term Monitoring of the Amazon Ecosystems Through EOS: From Patterns to Processes

Principal Investigator – **Joao V. Soares**
Lead U.S. Investigator – **Thomas Dunne**
International Co-Sponsor – **Brazil**

Science Background

Amazonia is unique among terrestrial ecosystems because of its extent, the intimate interaction with the largest river on the planet, and the rate of change caused by human activity. Environmental conditions in the Basin range from high mountains to equatorial lowlands, and are subject to natural and anthropogenic changes. Both natural and anthropogenic changes in the Amazon are expected to disrupt regional vegetation distributions, alter the physical and chemical characteristics of the continental-scale river system, and modify regional hydroclimatology with significant potential to influence global climate patterns. Understanding the process dynamics of the Amazon Basin under natural and disturbed conditions is of high scientific priority and is an essential prerequisite for modeling global change and for understanding the resulting public policy issues.

Science Goal

The goals of this investigation are:

- To understand the impacts of land-use cover change to carbon fluxes and ecosystem's sustainability; and
- To understand the routing of the mobile terrestrial materials (water, sediment and nutrients) from precipitation, through the landscape and drainage system, to the atmosphere and ocean under changing climate and land use.

Current Activities

The EOS Amazon group uses remote sensing, field sampling, and hydromet databases to study carbon dynamics; ecosystem sustainability; sources, transport and processing of water, sediments and solutes within the basin as they are governed by the large-scale features of the terrain; atmospheric processes and vegetation characteristics.

Use of Satellite Data

In addition to using currently available data, the group is preparing, through development of remote-sensing tools, computer models, and data management systems, to maximize the utility of data from EOS sensors. They are exploring the usefulness of MODIS-type sensors for monitoring the status of forest canopies and using the information in their computations of hydrologic response, primary production, and nutrient cycling. The group has made comparisons of AVHRR records and TM images of the forested parts of the Basin in order to learn what aspects of the land cover can be reliably measured from coarse-resolution images. They have been developing algorithms, for application to new imaging systems, which take into account the full range of background variation in spectral variability due to atmosphere, instrument, and other non-vegetative scene components, as opposed to optimizations based solely on the spectral contrast of the target material. MODIS has the capability to provide variable-resolution band passes. The Amazon group's focus is to optimize these band passes, based on the contrast between foreground and background, given the natural variability that exists within these defined groups.

The fore-and-aft viewing of ASTER allows separation of many atmospheric influences from that of the surface in addition to the goal of making stereo pairs. The inclusion of the thermal channels in ASTER also allows for better detection of even simple scene components such as vegetation.

The group has also been incorporating satellite measurements of solar radiation fluxes and the results of numerical weather simulations into their hydrologic models and comparing the data with sparse ground-level measurements in order to learn about the accuracy and utility of future large sets of environmental data for monitoring and interpreting the condition of the Basin surface.

Participation in Field Programs

Field studies by the group concern rivers and flood plains at all scales throughout the Basin, as well as well-drained forested parts of the landscape. Measurements of vegeta-

tion characteristics in forested, cleared, and re-growth areas allow the interpretation of sequential Landsat TM, SAR, and AVHRR images of land cover. An important emphasis is the characterization of the vegetation and geomorphic characteristics of vast wetlands and mapping of the timing and extent of their inundation, using passive microwave data from SMMR and SSM/I, and from AMSR-E. This information is interpreted and linked to basin hydrology through analysis of empirical hydrologic data and mathematical modeling. The hydrology of these wetlands, which cover more than 20 percent of the Basin, is crucial to understanding the biogeochemistry of the river as well as the exchange of methane with the atmosphere.

Principal Investigator
João Soares

João Soares holds a B.A. and an M.Sc. in Agricultural Engineering from the Federal University of Viçosa, Brazil, and a Ph.D. in Physics of Remote Sensing conferred by the University of Paris in 1986. He has focused his research in the areas of modeling the biosphere/atmosphere interactions for water/carbon/energy fluxes and on remote sensing. He has worked on the problem of extracting soil moisture and vegetation structure from radar data in the context of the Space Radar Laboratory (SIRC/X-SAR) experiment. He has been affiliated with the Instituto Nacional de Pesquisas Espaciais since 1997.

Lead U.S. Investigator
Thomas Dunne

Thomas Dunne is Professor in the School of Environmental Science and Management at the University of California Santa Barbara. He holds B.A. and Ph.D. degrees in Geography from the University of Cambridge and The Johns Hopkins University, respectively, and is a Member of the National Academy of Sciences and the American Academy of Arts and Sciences. His research concerns field and theoretical studies of drainage-basin and hill-slope evolution, incorporating the relations among climate, vegetation, hydrology, sediment transport, and soil properties. In addition to work in several mountain and subarctic environments of North America, he has experience measuring hydrologic and sedimentation processes in tropical environments in Africa and Brazil, which he uses as the basis for computer-modeling studies to generalize his findings.

Co-Investigators

John B. Adams - *University of Washington*

John M. Melack - *University of California-Santa Barbara*

Leal A.K. Mertes - *University of California-Santa Barbara*

Jeffrey E. Richey - *University of Washington*

Dar Roberts - *University of California-Santa Barbara*

Compton J. Tucker - *NASA/Goddard Space Flight Center*

Reynaldo Victoria - *Universidade de Sao Paulo, Brazil*

John M. Wallace - *University of Washington*

The following are from the Instituto Nacional de Pesquisas Espaciais, Brazil:

Diogenes S. Alves
Marcio N. Barbosa
Bruce R. Forsberg
Hermann Kux
Carlos Nobre
Evelyn M.L.M. Novo
Yosio E. Shimabukuro
Dalton Valeriano

References

Batista G.T., and C.J. Tucker, 1994: Assessment of AVHRR data for deforestation estimation in Mato Grosso (Amazon Basin). *Remote Sens. Rev.*, **10**, 35-49.

Dunne, T., L.A.K. Mertes, R.H. Meade, J.E. Richey, and B.R. Forsberg, 1997: Exchanges of sediment between the floodplain and channel of the Amazon River in Brazil. *Geological Society of America Bull.*, in press.

Keil, R.G., L.M. Mayer, P.D. Quay, J.E. Richey, and J.I. Hedges, 1997: Loss of organic matter from riverine particles in deltas. *Geochimica et Cosmochimica Acta*, **61**, 1507-1511.

McClain, M.E., and J.E. Richey, 1996: Regional-scale linkages of terrestrial and lotic ecosystems in the Amazon basin: A conceptual model for organic matter. *Archiv für Hydrobiologie (Suppl. 113)*, 111-125.

McClain, M.E., J.E. Richey, J.A. Brandes, and T.P. Pimentel, 1997: Dissolved organic matter and terrestrial-lotic linkages in the central Amazon Basin, Brazil. *Global Biogeochem. Cycles*, **11**, 295-311.

McClain, M.E., J.E. Richey, and R.L. Victoria, 1996: Andean contributions to the biogeochemistry of the Amazon River system. *Bulletin de l'Institut Francais d'Etudes Andines*, **24**, 425-437.

p

Mertes, L.A.K., 1997: Documentation and significance of the perirheic zone on inundated floodplains. *Water Resour. Res.*, **33**, 1749-1762.

Mertes L.A.K., M. Smith, and J.B. Adams, 1993: Quantifying sediment concentration in surface waters of the Amazon River wetlands from Landsat images. *Remote Sens. Environ.*, **43**, 281-301.

Mertes, L.A.K., T. Dunne, and L.A. Martinelli, 1996: Channel-floodplain geomorphology of the Solimoes-Amazon River, Brazil. *Geological Society of America Bull.*, **108**, 1089-1107.

Novo, E.M., and Y.E. Shimabukuro, 1994: Spectral mixture analysis of inland tropical waters. *Int. J. Remote Sens.*, **15**, 1351-1356.

Richey, J.E., and R.L. Victoria, 1996: Continental-scale biogeochemical cycles of the Amazon River system. *Verh. Int. Verein. Limnol.*, **26**, 219-226.

Richey, J.E., and R. Victoria, 1993: C, N, and P dynamics in the Amazon River. Interactions of C, N, P, and S Biogeochemical Cycles and Global Change, R. Wollast, F.T. Mackenzie, and L. Chou, Eds., Springer-Verlag, Berlin. 123-140.

p

Richey, J.E., S.R. Wilhelm, M.E. McClain, R.L. Victoria, J.M. Melack, and C.A.R.M. Araujo-Lima, 1997: Organic matter and nutrient dynamics in river corridors of the Amazon Basin and their response to anthropogenic change. *Ciencia e Cultura*, **49**, 98-110.

Ustin S.L., M.O. Smith, and J.B. Adams, 1993: Remote sensing of ecological processes: A strategy for developing and testing ecological models using spectral mixture analysis. *Scaling Physiological Processes: Leaf to Globe*, J.R. Ehleringer and C.B. Field, Eds., Academic Press, 339-357.

Victoria, R.L., L.A. Martinelli, J.M. Moraes, M.V. Ballester, G. Pellegrino, R.M.B. Almeida, and J.E. Richey, 1997: Surface air temperature variations in the Amazon region and its borders during this century. *J. Climate*, in press.

Investigation URL

<http://boto.ocean.washington.edu/eos/>

Middle And High Latitude Oceanic Variability Study (MAHLOVS)

Principal Investigator – **Meric Srokosz**

Science Background

The aim of MAHLOVS is to investigate the variability of the atmospheric forcing of the oceans, the consequent effect on the oceanic response, and the resulting effect on the biological productivity of the oceans. Much effort is presently being expended on determining the long-term and large-scale means and trends in the structure of the oceans (for example, the WOCE and JGOFS programs). By the time of the launch of Terra a good grasp of that problem should have been obtained. This study builds on that understanding by examining the spatial and temporal variability of the ocean (on space scales ranging from one-to-one-thousand kilometers and time scales of days to years), about these large-scale and long-term means and trends. This is likely to contribute to the UK component of CLIVAR (the successor to WOCE and TOGA). To understand changes in the atmosphere-ocean-biology system it is clear that knowledge about the variability of the system is necessary, as well as information about means and trends. MAHLOVS concentrates on mid-to-high-latitude regions of the oceans, in particular the eastern North Atlantic and the Southern Ocean. These regions have been chosen because they are areas of significant atmosphere-ocean-biology interaction and variability and because there is a continuing UK oceanographic interest in them (they feature in the UK components of the WOCE and JGOFS programs). The latter consideration is important in that in situ data are therefore to be available for incorporation into this study. It is proposed to make use of the microwave, visible, and infrared sensors of the EOS system to calculate the sea-surface forcing and fluxes, the dynamical variability of the ocean, and the biological activity. The data will be combined in a synergistic manner, and assimilation of the data into ocean models (biological and physical) will be used to enhance the analysis, interpretation, and understanding of the phenomena observed.

Science Goals

The science goal of this investigation is to examine the relationship between the temporal and spatial variability of the atmospheric forcing of the ocean and the conse-

quent variability of the oceanic response and its effect on the biological productivity at mid-to-high latitudes (particularly in the eastern North Atlantic and the Southern Ocean). Specific scientific questions to be addressed are:

- What changes occur over a ten-year period in the surface fluxes of momentum, heat, water, and radiation in the regions of interest, on space scales of the order of hundreds of kilometers and time scales of longer than one week?
- What is the variability of the ocean circulation and biological activity in these areas and how do they relate to the variability of the surface forcing?
- To what extent does the coupling of the eastern North Atlantic with the Norwegian Sea, the North Sea, and the Western Mediterranean affect its dynamical and biological variability?
- In the Southern Ocean, what is the effect of the variability of the Antarctic Circumpolar Current on the biological activity?
- What are the differences and similarities between the eastern North Atlantic and the Southern Ocean?

Current Activities

Recent progress in MAHLOVS studies includes:

- multi-sensor studies of Rossby wave propagation in the North Atlantic, using TOPEX altimeter height and ERS ATSR SST data. These show a strengthening of the Rossby wave signal in the Azores current region.
- a new global climatology of improved air-sea fluxes, based on in situ data, covering the period 1980-93, has been generated. This contributes to the understanding of the coupled atmosphere-ocean system. (see <http://www.soc.soton.ac.uk/JRD/MET/fluxclimatology.html>)

- development of a novel method for assimilating data into a biological model to obtain better estimates for the model parameters, thus improving the model's ability to represent the ocean biology.
- studies of plankton patchiness in the eastern North Atlantic, including data acquired on a recent cruise (April-May 1997) and ocean-color data from OCTS on ADEOS. The data suggest that both biological and biophysical interactions are of importance in the development of patchiness.
- studies of the relationship between wind speed and stress, using ship measurements (corrected for air-flow distortion round the ship), have shown that there is no dependence of wind stress on the wave conditions in the open ocean.
- development of a new method for estimating rain rate over the ocean that makes use of the dual-frequency capability of the TOPEX altimeter.

Use of Satellite Data

Prior to the launch of the EOS sensors, data from other satellite missions and sensors (Geosat, AVHRR, ERS-1 & 2, TOPEX/Poseidon, SeaWiFS, ADEOS) are being, or will be, used to carry out initial studies. Once Terra is launched, data from the radar altimeter, scatterometer (on ADEOS-II), MODIS, AMSR-E, AIRS and CERES will be used in combination to investigate atmosphere-ocean-biology interaction and variability. In addition, data from sensors on the NOAA polar orbiter series, the ESA Envisat and Metop missions, and the NASDA ADEOS-II mission will be used to complement those obtained from NASA's EOS sensors. Important to the investigation is the requirement for simultaneity of observations from a number of sensors (the degree of simultaneity required depends on the particular process being studied), which will be available from EOS.

Participation in Field Programs

A major cruise, aboard the UK research vessel RRS Discovery, was undertaken in April-May of 1997 to study plankton patchiness during the development of the spring bloom. The ship and satellite (ERS-2, ADEOS—particularly OCTS, AVHRR, TOPEX/Poseidon) measurements acquired during the cruise period contributed to determining the relative importance of the biological and biophysical interactions in creating patchiness. In addition, bio-optical data from the cruise contributed to the validation of ocean-color algorithms.

To complement the study of the relationship between wind speed and stress from ship-based measurements (where air flow distortion round the ship needs to be ac-

counted for), a meteorological buoy has been developed that can make measurements without the problem of flow distortion. The buoy carries sonic anemometers that allow the direct measurement of stress via the dissipation technique. The buoy has been deployed at sea, and the results obtained will improve understanding of the wind-speed-to-stress relationship.

Finally, an acoustic rain-measuring buoy has been developed, and is to be deployed, to validate the new algorithms for rain over the ocean that use the dual-frequency capability of the TOPEX altimeter. In addition, data from a ground-based meteorological rain radar will be used in the validation.

Principal Investigator

Meric A. Srokosz

Meric Srokosz has 18 years of experience in the fields of applied mathematics and remote sensing of the oceans. He holds both undergraduate and doctoral degrees in Mathematics from Bristol University. Currently, he is a member of the James Rennell Division of the Southampton Oceanography Centre (SOC). Dr. Srokosz is a Principal Investigator for the ERS-1 and ERS-2 missions, and a co-investigator for the TOPEX/Poseidon, ADEOS, and TRMM missions.

Co-Investigators

Keith Haines - *University of Edinburgh*

The following are from the Southampton Oceanography Centre:

Peter G. Challenor (James Rennell Division)
 Mike Fasham (George Deacon Division)
 Trevor Guyer (James Rennell Division)
 Ian Robinson (University of Southampton)
 Peter K. Taylor (James Rennell Division)

References

Challenor, P.G., J.F. Read, and R.T. Tokmakian, 1996: Measuring surface currents in Drake Passage from altimetry and hydrography. *J. Phys. Oceanogr.*, **26**, 2748-2759.

Cipollini, P.D. Cromwell, M.S. Jones, G.D. Quartly, and P.G. Challenor, 1997: Concurrent altimeter and infrared observations of Rossby wave propagation near 34N in the Northeast Atlantic. *Geophys. Res. Lett.*, **24**, 889-892.

Cooper, M., and K. Haines, 1996: Altimetry assimilation with water property conservation. *J. Geophys. Res.*, **101**, 1059-1077.

Fasham, M.J.R., 1995: Variations in the seasonal cycle of biological production in subarctic oceans: a model sensitivity analysis. *Deep Sea Res.*, **42**, 1111-1149.

Harmon, R., and P.G. Challenor, 1997: A Markov chain Monte Carlo method for estimation and assimilation into models. *Ecol. Modelling*, **101**, 41-59.

Josey, S.A., E.C. Kent, D. Oakley, and P.K. Taylor, 1996: A new global air-sea heat and momentum flux climatology. *International WOCE Newsletter*, **24**, 3-5.

Quarty, G.D., T.H. Guymer, and M.A. Srokosz, 1996: The effects of rain on TOPEX radar altimeter data. *J. Atmos. Oceanic Tech.*, **13**, 1209-1229.

Srokosz, M.A., 1997: Plankton patchiness studies by ship and satellite, RRS Discovery Cruise 227, 15 April - 16 May 1997. *Southampton Oceanography Centre Cruise Report No. 12*, 76 pp.

Robinson, I.S., A.R. Weeks, and B.A. Booty, 1995: A towed near-surface optical reflectance meter for measuring ocean color in support of remote sensing. *Deep Sea Res.*, **42**, 2093-2111.

Yelland, M., and P.K. Taylor, 1996: Wind stress measurements from the open ocean. *J. Phys. Oceanogr.*, **26**, 541-558.

Investigator URL

<http://www.soc.soton.ac.uk/>

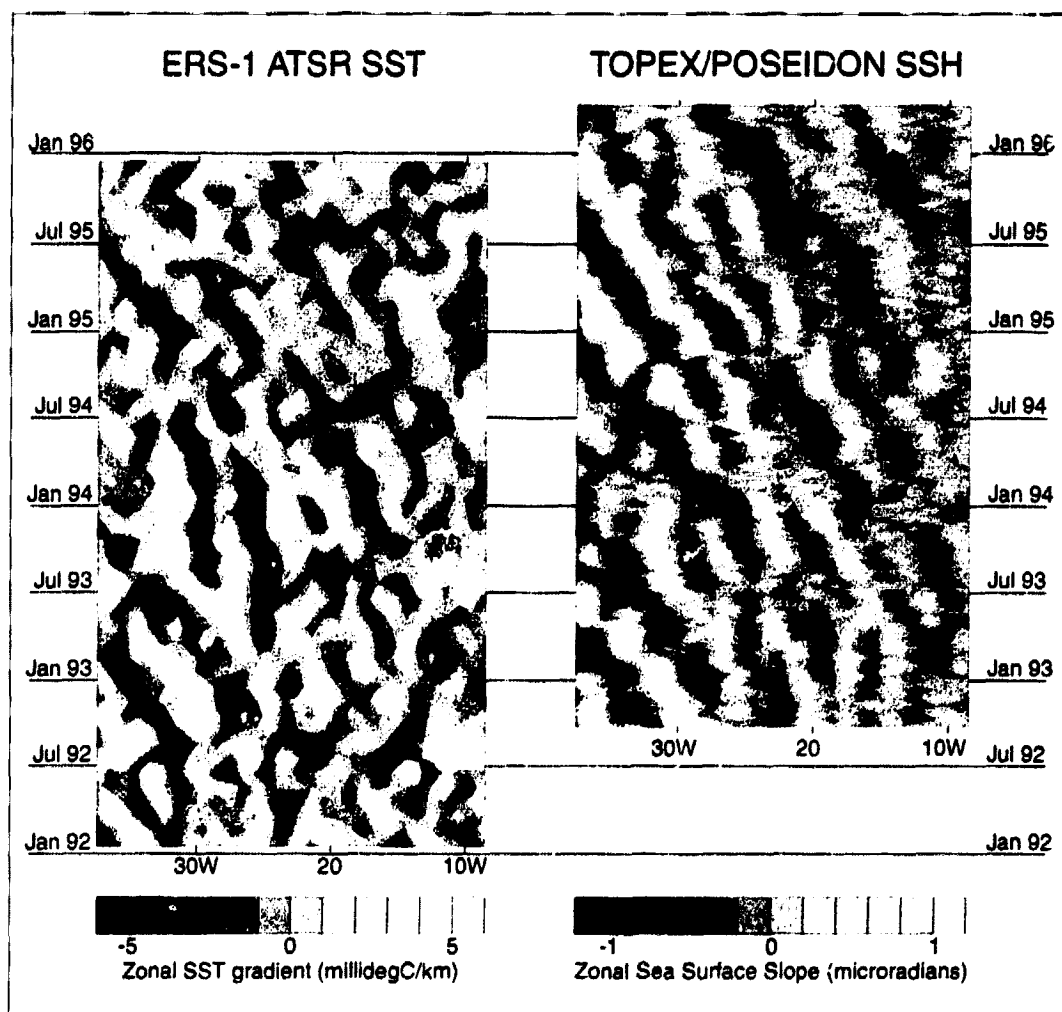

These Hovmöller diagrams show the westward propagation of baroclinic Rossby waves at 34N and in the N.E. Atlantic, as observed in the zonal gradients of ERS-1 ATSR SST and TOPEX/Poseidon SSH data.

Water Vapor in the Climate System

Principal Investigator – **Graeme Stephens**

Science Background

A characteristic of the Earth's climate system is its great complexity. Couplings between vast arrays of processes are thought to produce a series of complex feedbacks in response to any given climate forcing. The energy budget of the planet is one important component of the system as are the dynamical processes which move the atmosphere and oceans and the hydrological processes that shape the energy exchanges. One of the major issues confronting global-change research is understanding how the energy is distributed in the system, the extent that the hydrological cycle determines this distribution, and how the dynamical processes, driven by heating gradients, in turn shape the hydrological cycle.

The hydrological cycle is germane to all of the principal components of the climate system (e.g., Chahine, 1992). As such, research aimed at improving our understanding of how this cycle works receives high priority in both national and international climate research programs (such as the Global Energy and Water cycle Experiment (GEWEX) of the World Climate Research Program (WCRP) and within the U.S. Global Change Research Program (USGCRP). The objectives of the research on the Water Vapor in the Climate System are to study how:

- Water vapor plays a decisive role in the transfer of radiation through the atmosphere and therefore largely determines the atmospheric response to an increase of infrared-active gases such as carbon dioxide and freons through the water-vapor feedback mechanism.
- Water vapor is important to the transport and release of latent heat. The distribution of latent-heat release is a topic that has received considerable attention over the past decade, especially with the burgeoning interest in the variability of the atmosphere on both inter- and intra-seasonal time scales.
- The amount of water vapor present in the atmosphere influences the rate of evaporation from the surface, a process of crucial importance to our understanding of the surface energy budget
- The transport and divergence of water vapor are essential ingredients in determining the distribution of solid

and liquid water in the atmosphere and therefore crucial to the significant and perplexing problem of cloud feedback in climate change.

- The atmospheric distribution of water vapor is critical in determining the energy balance at the ocean surface and indirectly, in the water flux into the ocean. In that context, the atmospheric water vapor is of a vital importance in determining the interaction of the ocean and the atmosphere over a wide spectrum of space and time scales.

Research Goals

The research described below seeks to elucidate the role of water vapor in climate and climate change especially with regard to (i) water-vapor feedback, (ii) the impact of vertical redistribution on this feedback and (iii) the broad aspects of the transport of this vapor. To achieve these three goals, research is discussed in terms of two broad and connected areas.

The first is concerned with research in ways of obtaining global water-vapor data using existing and new satellite observations. The second phase of this research (and one definitely connected to the first) is concerned with application of the data to evaluate the hydrological cycle as it is predicted in climate models and observed in the real world. This research involves analyses of two types of climate model simulations, one of the AMIP (Gates, 1992) type where the SSTs are specified and another involving simulations of coupled ocean atmospheric GCMs. It is important to emphasize that this research is not merely about collecting water-vapor data and comparison of these data to their model counterparts. Rather the research focuses on examining the sensitivity of important processes (such as radiative transfer, cloud processes among others) to water vapor and to examine how well these are treated in climate models.

Current Activities

Further results describing these activities are located on the web site listed at the end of this investigation summary.

The main elements of this research include:

- 1) *Satellite retrievals:* Analyses and assessment of present satellite capabilities (Engelen and Stephens, 1998).
- 2) *Validation of satellite data:* Use of field-study data, such as collected during the ARM IOP (<http://www.arm.gov/>) and other current activities.
- 3) *Analyses of existing data:* Analyze existing data to study the climate system (e.g., Lietzke and Vonder Haar, 1998). Under this activity we analyze NVAP and reanalysis data related to other components of the climate system. We are currently analyzing NVAP, ECMWF, DAO, and NCEP reanalysis data sets.
- 4) *Reanalyses Comparison:* In related activities, the work of CLERA (Clear Sky Longwave Radiation from ECMWF Reanalysis) is an extension of earlier work by Slingo and Webb (1992). The idea is to incorporate analyses data into a model of clear-sky OLR, and through comparison with measured OLR, identify problems in the reanalysis measurements.
- 5) *Water vapor transport and mixing:* A new effort under development is to use the satellite data, together with daily wind data to study the properties of water-vapor mixing. This work is being carried out in the University of Chicago under the direction of Professor R. Pierrehumbert using Lagrangian methods; and at Colorado State University where Davey et al. (1999) are studying moisture plumes from the tropics to mid-latitudes.
- 6) *Comparisons and analyses of other satellite data:* We have developed a collaboration with J. Waters of JPL and are beginning to analyze MLS upper troposphere water vapor in association with TOVS and SSMT2. These data will not only be compared to other satellite data but will also be used to study the relationship between upper tropospheric water-vapor variability and the variability of the atmospheric circulation.
- 7) *Comparison with models - AMIP-2 comparisons:* We have implemented a special AMIP-2 project under this research that allows the modeling groups to simulate TOVS radiance directly. Refer to the following web address: http://langley.atmos.colostate.edu/richard/amip_home.html
- 8) *Analysis of Coupled Model Results:* Experiments from four coupled climate models in which CO₂ concentrations increases at rates of 0.5-1.1% per year for periods of 75-200 years are used to study the radiative fluxes at the surface and the water-vapor bud-

get of the atmosphere. Results from a fifth simulation are currently being included in this analysis (Garratt et al., 1998).

- 9) *Signatures of water vapor feedback:* We use existing data sources, primarily derived from current satellite radiances to study the feedback between radiation, clouds, water vapor, and sea surface temperature (SST) in the tropical atmosphere. The variety of data sources provides new insight about tropical convection and the association of this convection to SST.

Principal Investigator **Graeme L. Stephens**

Prior to becoming an Associate Professor in 1984 and a Professor in 1991 at Colorado State University, Graeme L. Stephens was a Senior Research Scientist at the Commonwealth Scientific and Industrial Research Organization, Division of Atmospheric Research. He received his M.S. and Ph.D. degrees at the University of Melbourne, Australia. In 1990 he received the Henry G. Houghton Award of the American Meteorological Society.

Co-Investigators

Edward Browell - NASA/Langley Research Center

Michael Exner - University Corp. for Atmospheric Research

J. Garratt - CSIRO, Australia

Jorge Ramirez - Colorado State University-CE

David Randel - Colorado State University-CIRA

Roger Saunders - ECMWF UK

Anthony Slingo - UK Meteorological Office

Thomas H. Vonder Haar - Colorado State University

References

- Davey, C., T. Vonder Harr, and J. Forsythe, 1999: Probing the Depths of Atmospheric Moisture Plumes. Poster presentation at the EOS-IWG meeting, Vale, Colorado, June 15-17.
- Engelen, R., and G.L. Stephens, 1998: Characterization of Water Vapor Retrievals from TOVS/HIRS and SSMT/2 Measurements. *Quart. J. Roy. Meteor. Soc.*, in press.
- Garratt, J.R., D.M. O'Brien, G.L. Stephens, M.R. Dix, M. Wild, and J.M. Murphy, 1998: Response of Radiative Fluxes in the Atmosphere to CO₂ Forcing. *J. Climate*, submitted.

Gates, W.L., 1992: AMIP: The Atmospheric Model Intercomparison Project. *Bull. Amer. Meteor. Soc.*, **73**, 1961-1970.

Lietzke, C.E., and T.H. Vonder Haar, 1998: Regional Water Vapor in the Presence of Tropical Storms. Ph.D. Dissertation. Colorado State University, Department of Atmospheric Science, Ft. Collins, Colorado 80523-1371.

Randel, D.L., T.H. Vonder Haar, M.A. Ringerud, G.L. Stephens, T.J. Greenwald and C.L. Combs, 1996: *Bull. Amer. Met. Soc.*, **77**, 1233-1246.

Slingo, A., and M.J. Webb, 1992: Simulation of clear-sky outgoing longwave radiation over the oceans using operational analyses. *Quart. J. Roy. Meteor. Soc.*, **118**, 1117-1144.

Investigation URL

<http://langley.atmos.colostate.edu/nasawv.html>

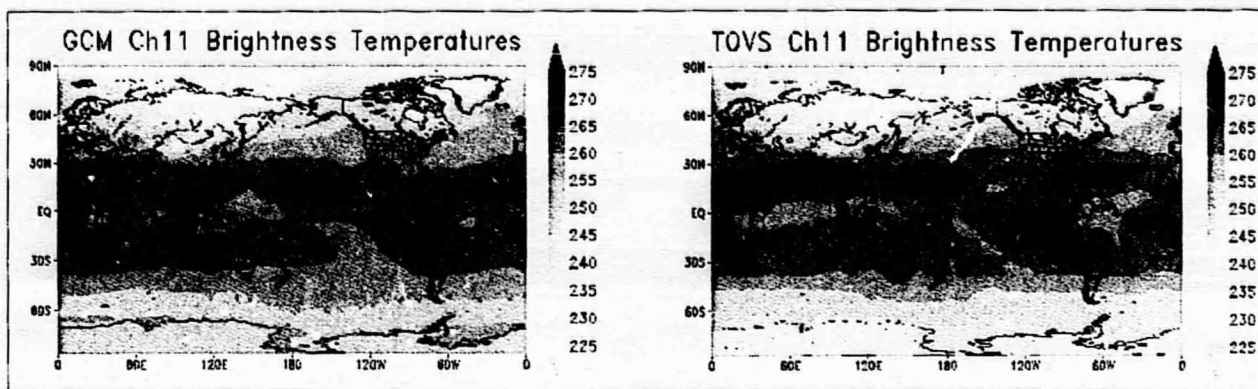

Comparisons of observed January TOVS/HIRS channel 11 brightness temperatures with brightness temperatures calculated using data derived from the CSU GCM.

Earth System Dynamics: The Determination and Interpretation of the Global Angular Momentum Budget Using EOS

Principal Investigator – **Byron D. Tapley**

Science Background

Momentum, mass, and energy transport between the atmosphere, oceans, and solid Earth produce changes in the Earth's rotation and gravity field which are being measured by modern space-geodetic techniques. Changes in rotation are attributable both to motions of winds in the atmosphere and currents in the oceans as well as to mass redistribution within the Earth system. Alternatively, changes in the gravity field, which can be inferred from satellite-orbit perturbations, arise only from mass redistribution. Thus space-geodetic measurements of Earth rotation, gravity variations, and satellite motions provide global measures of momentum and mass redistribution and can be used to study the mechanisms involved in these changes.

The details of the mass and momentum exchange between the components of the Earth's dynamic system are not fully understood, and a primary focus of the research will be to clarify the mechanisms that dynamically couple the atmosphere, oceans, and solid Earth. The agents that transfer angular momentum between the atmosphere and the other components include torques from tangential surface frictional effects and from normal pressure gradients across mountainous topography. Similarly, oceanic pressure differences across continental faces can also be important in transferring momentum from oceans to the solid Earth.

Earth rotation and gravity variations occur over many time scales and provide measures of such climate-related signals as seasonal fluctuations in atmospheric pressure and winds, the El Niño/Southern Oscillation phenomenon, and longer-term redistribution of water mass among ocean/continent/polar-ice-cap reservoirs. Appropriate global integrals of the mass and motion of air and water give predictions of gravity and rotation changes that can be compared with observations. These comparisons can be used to verify and improve models of the interaction of the oceans, atmosphere, and land-surface hydrology. Energy redistribution across the ocean boundary is another process for which a quantitative assessment of atmosphere-ocean coupling interaction has not been fully achieved, but the measurement of gravity and its temporal variations along with current ocean-surface-topogra-

phy measurements from satellite-altimeter missions provides unique information for using ocean models to study this coupling.

Science Goal

The objective of this investigation is to develop appropriate Earth-system models for analyzing multi-sensor information from EOS satellites, along with in situ data and data from other satellites, to investigate the interactions of the atmosphere, oceans, and solid Earth, as represented by the exchange of angular momentum, mass, and energy among these components. The study will focus on understanding the relationship of changes in these quantities to global climate-change processes. An important issue to be addressed is the impact of global warming on sea-level change. The EOS measurements will allow us to directly measure the different contributions to sea-level change including thermal expansion and the melting/accumulation of ice in the polar regions and continental glaciers.

Current Activities

The investigation is utilizing atmospheric angular momentum and related data sets derived from the wind and mass fields from the NASA Goddard Earth Observing System Data Assimilation System, as well as from operational analyses of the world's major weather centers such as the National Centers for Environmental Prediction (NCEP). Variations in oceanic angular momentum due to mass redistribution and changes in currents are being studied as are interactions between the ocean and the Earth's solid crust. Output from ocean general circulation models using both barotropic and eddy-resolving realizations is being used to calculate and assess oceanic angular momentum and torque mechanisms. Monthly surface winds derived from scatterometry will be used to improve assessments of the global momentum budget beyond the result based on operational models. Torques from the ERS-1 scatterometer may be in better balance with the inferred changes in momentum over the seasonal cycle. In addition, research into ocean data assimilation using satellite-altimeter, scatterometer, and radiometer data is being con-

ducted to develop methodologies for ingesting these data into appropriate models for more-accurate computation of ocean circulations. In alternate studies, the TOPEX/Poseidon altimeter data are being used to measure the seasonal, interannual, and secular sea-level change. Analysis of six years of TOPEX/Poseidon sea-level data indicates that these measurements have the potential to determine the global variations of the mean sea level with an accuracy of better than 1 mm/yr if a longer time series can be accumulated. The investigation has also been focusing on the analysis of atmospheric pressure fields from meteorological models (NCEP, ECMWF) to determine the effect of atmospheric mass redistribution on the temporal variations of the Earth's gravity field. These variations are being compared to gravity-field variations observed using satellite laser ranging, and they are also being used in pre-mission studies for the ESSP mission, Gravity Recovery and Climate Experiment (GRACE).

Use of Satellite Data

The ocean and polar-ice topography changes observed by the EOS radar and laser altimeter satellites, along with the Earth rotation and mass change observed by satellite laser ranging, very long baseline interferometry, and GPS space-geodesy techniques will be primary measurements for this investigation. The mass and momentum balances will require measurements from a number of EOS instruments. AIRS/AMSU/HSB will provide input for the temperature and moisture in the atmospheric momentum, mass, and water budgets. AMSR-E will be used to observe water vapor and the information about surface winds over the ocean. QuikSCAT will be used to provide measurements for sea-surface wind vectors. Jason-1 will provide sea-surface topography, wind speed, and wave-height measurements and measurements of global sea-level change. ICESat/GLAS will be used to provide changes in ice-sheet elevations to provide a constraint on the global water budget. These two measurements will be crucial to measuring the impact of global warming on sea-level change.

A critical data set to this investigation will become available in 2001 with the launch of GRACE. GRACE will provide the highest resolution measurements of the mean and time-varying components of the Earth's gravity field ever made. These measurements will allow us to monitor mass movement in the solid Earth, the oceans, the atmosphere, the polar ice caps, and continental ground-water and glaciers.

In addition, other data sources, including many of the Pathfinder data sets, satellite radar-altimetry data, and long-term space-geodetic measurements, such as the 20-year series of satellite laser ranging to geodetic satellites, will be utilized. The terrestrial reference frame determined by satellite laser ranging is an essential requirement for

describing changes in the Earth system over multi-decadal time intervals.

Participation in Field Activities

Instrument-calibration activities were conducted supporting the ESA ERS-1 Venice Tower calibration and the NASA/CNES TOPEX/Poseidon Harvest Platform and Lampedusa calibrations. As part of the activities which support GLAS and accurate measurement of sea level, additional calibration of ERS-1 and TOPEX/Poseidon instruments is being conducted in the Galveston Bay region along the Texas coast. These activities will continue for future altimeter missions such as Jason-1. Team members provide atmospheric angular-momentum data, as well as Earth-rotation solutions determined from geodetic satellites, to the International Earth Rotation Service.

Principal Investigator

Byron D. Tapley

Byron Tapley earned a Ph.D. in Engineering Mechanics at The University of Texas at Austin, and has over 30 years of experience in the use of satellites for Earth observations. He has served on the National Research Council (NRC) Space Studies Board (SSB), the SSB Committee on Earth Studies, and the NRC Earth Studies Board Geodesy Committees. He began teaching at his alma mater in 1958. Since 1984, he has held the Ciare Cockrell Williams Centennial Chair in the Department of Aerospace Engineering and Engineering Mechanics, and he serves as Director of the Center for Space Research. He is also the Director of the Texas Space Grant Consortium. His research interests focus on the application of nonlinear parameter-estimation methods to determine crustal motion, Earth rotation, the Earth's geopotential, and ocean circulation. He has served as Chairman of the Geodesy Section for the American Geophysical Union (AGU). He is the recipient of the NASA Exceptional Scientific Achievement Medal in 1983, the American Institute of Aeronautics and Astronautics (AIAA) Mechanics and Control of Flight Award in 1989, the NASA Public Service Medal in 1995 and the AAS Dirk Brouwer Award in 1996. He is a member of the National Academy of Engineering and a Fellow of AGU, AIAA, and AAAS.

Co-Investigators

Richard J. Eanes - *University of Texas at Austin*

John Lundberg - *University of Texas at Austin*

Rui. M. Ponte - *Atmospheric and Environmental Research, Inc.*

Richard D. Rosen - *Atmospheric and Environmental Research, Inc.*

David A. Salstein - *Atmospheric and Environmental Research, Inc.*

Bob E. Schutz - *University of Texas at Austin*

C. K. Shum - *Ohio State University*

Clark R. Wilson - *University of Texas at Austin*

References

Chen, J.L., C.R. Wilson, D.P. Chambers, R.S. Nerem, and B.D. Tapley, 1998: Global water mass balance and mean sea level variations. *Geophys. Res. Lett.*, **25**, 3555-3558.

Kuehne, J., S. Johnson, and C. Wilson, 1993: Atmospheric excitation of non-seasonal polar motion. *J. Geophys. Res.*, **98**(B11), 19,973-19,979.

Nerem, R.S., B.J. Haines, J. Hendricks, J.F. Minster, G. T. Mitchum, and W. B. White, 1997: Improved determination of global mean sea level variations using TOPEX/Poseidon altimeter data. *Geophys. Res. Lett.*, **24**(11) 1331-1334.

Ponte, R., and R. Rosen, 1994: Oceanic angular momentum and torques in a general circulation model. *J. Phys. Ocean.*, **24**, 1966-1977.

Ponte, R.M., D. Stammer, and J. Marshall, 1998: Oceanic signals in observed motions of the Earth's pole of rotation. *Nature*, **391**, 476-479.

Salstein, D.A., 1993: Monitoring atmospheric winds and pressures for Earth orientation studies. *Adv. Space Res.*, **13**(11), 175-184.

Tapley, B.D., B.E. Schutz, R.J. Eanes, J.C. Ries, and M.M. Watkins, 1993: Lageos laser ranging contributions to geodynamics, geodesy, and orbital dynamics, in *Contributions of Space Geodesy to Geodynamics: Earth Dynamics, Geodyn. Ser.*, Vol. 24, edited by D. E. Smith and D. L. Turcotte, 147-174, AGU, Washington, D.C.

Watkins, M.M., and R.J. Eanes, 1997: Observations of tidally coherent diurnal and semidiurnal variations in the geocenter. *Geophys. Res. Lett.*, **24** (17), 2231-2234.

Watkins, M.M., and R.J. Eanes, 1993: Long-term changes in the Earth's shape, rotation, and geocenter. *Adv. in Space Res.*, **13**(11), 251-255.

Investigation URL

<http://www.csr.utexas.edu>

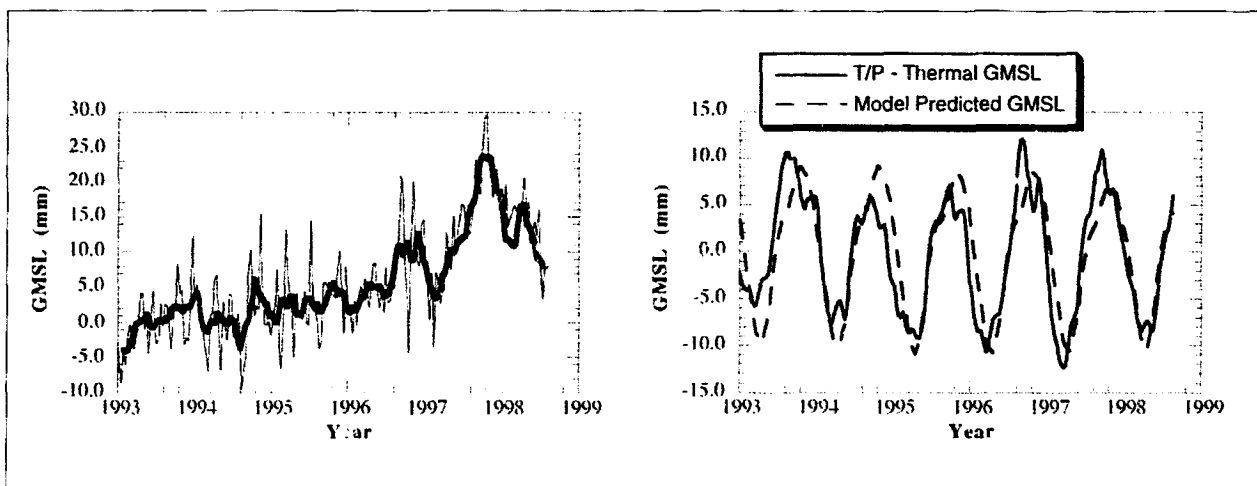

The figure on the left shows global mean sea level (GMSL) variations measured by the TOPEX/Poseidon (T/P) altimeter satellite from 1993 to 1998, including the rise associated with the 1997 El Niño. This signal is influenced by warming of the upper layer of the ocean and by changes in the ocean mass. The figure on the right shows variations in GMSL as measured by T/P after removing thermal sea level variations and a linear trend. Superimposed on this figure is the annual variability predicted from the global water mass balance using contemporary atmospheric and hydrological models. The results indicate the annual variations of the atmosphere, oceans, and land as they exchange water mass over the year.

Modeling of Distribution and Interannual to Interdecadal Variations of Aerosols

Principal Investigator – Ina Tegen

Science Background

In recent years it has become clear that not only sulfate aerosols, but also other aerosol types like soil dust and smoke from biomass burning are likely to be important climate-forcing factors. The magnitude and even the sign of the climate forcing caused by these tropospheric aerosols is still unclear. Absorbing aerosols like dust and black carbon do not necessarily cause significant changes in top-of-atmosphere radiative fluxes but can change heating rates in aerosol-containing layers which could lead to regional changes in atmospheric circulation. For an assessment of this effect, distributions of optical properties of all important aerosol species including absorbing aerosols are needed.

“Radiative forcing” by aerosols is defined as the change in radiative fluxes caused by an increase in aerosol levels. For climate-change studies, we therefore need to separately consider aerosol emissions from natural (background) sources and sources that change with time due to human impact or climate variations. Aerosol loads can change considerably on interannual-to-interdecadal timescales, where changes are not globally uniform. Although distinguishing between “natural” and “anthropogenic” aerosols, currently existing aerosol transport models do not take into account changes at interannual and interdecadal timescales.

Current satellite instrumentation is not sufficient to allow for global retrieval of tropospheric aerosol properties with an accuracy needed for climate-change studies. For now, global transport models must be used to calculate aerosol distributions with the best available knowledge on sources and aerosol processes, validating and constraining model results with ground-based measurements of aerosol concentrations, deposition rates, and extinction optical thicknesses.

Science Goal

The goal is to model sources, transport, and removal of key aerosol types (mineral dust, carbonaceous aerosol, sea salt) in the atmosphere using the GISS global 3-D tracer transport model. As part of a separate project the sulfate cycle is being included into the Goddard Institute for Space Studies (GISS) GCM (Daniel Jacob, Harvard U., Principal Investigator; at GISS this project is carried

out by D. Koch). Results from that model will be available for sensitivity studies.

Estimates of aerosol emissions for the period 1980-1990, and, in some cases, 1950-1990 together with observed precipitation fields for those years will be included in the model to provide interannual variations of anthropogenic aerosols. Variations of dust emissions for the different years will also be included. The result of the proposed effort is a global 4-D distribution of aerosol optical properties useful for climate models and satellite retrievals.

With information on distribution, aerosol optical thickness, effective particle size and effective variance, and chemical composition (i.e., refractive indices) direct aerosol forcing can be calculated. Since aerosol optical properties are already parameterized in the GISS GCM, this parameterization will be applied to the calculated aerosol distributions. An ultimate goal will be to evaluate the GCM response to changing aerosol levels for the different aerosol types.

Current Activities

A comparison of distributions of different aerosol types resulting from different models which have been converted into optical thicknesses revealed that sulfate, carbonaceous aerosols, and soil dust contribute approximately equally to the global average tropospheric aerosol optical thickness. Soil dust and sea-salt aerosols have been included as tracers (including size distribution) in the GISS chemical transport model. Carbonaceous aerosol emission fields (soot and carbonaceous aerosols) have been compiled at GISS by P. Hollrigl and are available to be included into the tracer transport code. A 20-year emission trend for anthropogenic sulfate and black carbon has been compiled for different regions of the world.

A new version of the 3-D GISS offline tracer model being developed by I. Fung (U. Victoria) is available for the aerosol transport calculations. It uses wind fields derived from the new version of the GISS GCM and calculates convective mixing on-line using temperature, wind, and humidity fields. It does not include explicit horizontal diffusion. This model shows much improved results, e.g., for calculations of the distribution of the tracer SF₆ compared to the old version of the tracer model that was

previously used. Similarly improved results compared to the previous version are expected for the aerosol calculations with this model.

A case study of a Saharan dust storm that affected dust loads measured over the Atlantic and Mediterranean Sea was done to explore the possibility of combining modeling, ground-based measurements and satellite retrievals to obtain a complete picture of an aerosol event as well as to explore possibilities of dust retrievals over land using brightness temperatures.

Use of Satellite Data

Aerosol retrievals from AVHRR and TOMS will be used to validate interannual variations of aerosol distributions. Even if the retrieved aerosol optical thicknesses are uncertain due to unknown aerosol optical properties, the year-to-year variations in these data should reveal trends in aerosol loads. In a case study, brightness temperatures from the Meteosat IR channel archived in the ISCCP pixel-level data set were used to obtain dust-aerosol information over land.

Planned satellite instruments (MODIS, MISR, EOSP) will provide improved capabilities to retrieve aerosol properties. Retrieval algorithms for these instruments are under development. The aerosol product from this investigation will provide ranges of refractive indices and particle sizes as well as information on particle nonsphericity (by assuming dust particles to be nonspherical and hygroscopic particles to be spherical) at model resolution as 'first guess' for aerosol retrieval calculations, while in turn the new satellite aerosol products will provide improved possibilities of validating aerosol transport models.

Principal Investigator **Ina Tegen**

Ina Tegen is an Associate Research Scientist in the Department of Applied Physics at Columbia University and the NASA Goddard Institute for Space Studies in New York. She received her Ph.D. in Physics at the University of Heidelberg in July 1992. Her research interests are interactions of tropospheric aerosols and climate. In the field of soil-dust aerosol her recent research included an estimate of radiative forcing due to dust from anthropogenically disturbed soils.

References

Hollrigl, P., 1997: Modeling the distribution of aerosols and their effect on the atmospheric radiation, Ph.D. thesis, ETH Zurich, Switzerland.

Kubilay, N., E. Oszoy, S. Nickovic, and I. Tegen: A hemispheric dust storm affecting the Atlantic and Mediterranean (April 1994): Analyses, modeling, ground-based measurements and satellite observations. *J. Geophys. Res.*, submitted.

Tegen, I., A. Lacis, and I. Fung, 1996: The influence of mineral aerosol from disturbed soils on the global radiation budget. *Nature*, **380**, 419-422.

Tegen, I., P. Hollrigl, M. Chin, I. Fung, D. Jacob, and J. Penner, 1997: Contribution of different aerosol species to the global aerosol extinction optical thickness: Estimates from model results. *J. Geophys. Res.*, **102**, 23,895-23,915.

Tegen, I., and R. Miller: A GCM study on the interannual variability of soil dust aerosols. *J. Geophys. Res.*, **102**, in press.

The Role of Natural and Anthropogenic Aerosols in Earth's Radiation Budget and Climate: Microphysical Simulations with the NCAR Community Climate Model

Principal Investigator – **Owen B. Toon**

Science Background

Clouds and aerosols play a significant role in the Earth's atmosphere. They significantly affect the radiation budget, they impact atmospheric chemistry, and they interfere with satellite remote-sensing measurements. During the past two decades we have constructed numerical models of the microphysical, chemical, optical, and radiative properties of clouds and aerosols in both the stratosphere and troposphere and applied these models to problems of importance in the Earth's radiation budget, climate, and atmospheric chemistry. We have conducted global-scale three-dimensional simulations of the stratospheric dispersion of debris from the Mt. Pinatubo and El Chichón eruptions as well as one-dimensional simulations of the microphysical evolution of the Mt. Pinatubo volcanic cloud. We successfully compared these simulations with data from several satellites and from aircraft and balloon campaigns, demonstrating the sensitivity of volcanic cloud transport to meteorology at the time of the eruptions. We have simulated the evolution of Saharan dust storms, and the continental-scale expansion of smoke from forest fires in three dimensions. We compared these calculations with data from satellites, and showed among other things that the cooling observed beneath smoke clouds could be numerically simulated. We have investigated the interactions between aerosols and cirrus clouds as well as the interactions between aerosols and stratus clouds. We employed satellite and in situ observations of ship tracks as a test of our modeling skills for stratus clouds, and showed that the cloud albedo, and even the depth of the marine boundary layer, could be affected by aerosols. We helped design, and participated in, an airborne campaign to investigate similar issues for cirrus clouds.

Science Goal

We plan to use EOS data to improve the accuracy of numerical simulations of clouds and aerosols, and to extend them to the global scale by collaboration with the NCAR Community Climate Modeling (CCM) group. We will compare the results of these simulations with observations from currently available sensors and EOS instru-

ments, as their data become available. Initially we will conduct our global-scale modeling using a model that employs the physics package from the CCM driven by observed winds. We will first consider primary aerosols which are directly emitted into the atmosphere such as mineral aerosols, carbonaceous aerosols, and sea salt. These aerosols are relatively simple to model because they are not chemically active. Then, we will proceed by including secondary aerosols (sulfates and nitrates), which are more complex because they are produced by gas-to-particle conversion through a complicated chain of chemical and physical processes. Our goal will be to evaluate the direct and indirect climate effects caused by multi-component aerosols with time-dependent properties. Previous GCM studies were focused on a given aerosol component or a mixture of components with prescribed fixed properties. We will recommend simple prescriptions for including indirect effects of aerosols on clouds in the CCM and evolve to more-detailed algorithms. We will also continue process-scale modeling so that we can learn from detailed comparisons with field data how best to model aerosols and their interactions with clouds.

Current Activities

We are currently pursuing two issues. Scientists at GISS have used satellite observations of clouds to develop parameterizations for use in their climate model. We are using a three-dimensional cloud model to investigate these parameterizations to determine the physical process that may be responsible. Our objective is to determine if the observations used to make the parameterizations can be used to extrapolate to conditions other than the ones that occurred when the observations were made. In short we are trying to establish the physics behind these empirical cloud parameterizations. Our other current project is three-dimensional simulations of aerosols that have been observed by multiple satellite sensors. In particular we are modeling dust storms observed by LITE, AVHRR, and METEOR-TOMS. One goal is to test our ability to reproduce the observations from these space-based sensors, each of which is sensitive to different aspects of the aerosols. Another goal is to better determine how well the

aerosol-retrieval algorithms used by these instruments are able to uniquely determine the properties of the aerosols. Finally, we are trying to determine what information not currently available, such as aerosol optical constants, is needed to improve the ability of EOS instruments to retrieve aerosol characteristics properly.

Use of Satellite Data

At the present time we are interacting with data from the TOMS instrument, LITE, and AVHRR.

Participation in Field Activities

We have participated in a number of field activities in the past few years, and anticipate several others in the next few years. We participated in the Monterey Area Ship Track (MAST) field program, a joint Navy/NASA program designed to understand the ways in which aerosols affect clouds. In this case a number of ships emitted aerosols into marine-stratus clouds. The changes in cloud albedo and other properties were observed from aircraft and satellites. We have analyzed some of these data to test parameterizations of the indirect effects of clouds on aerosols. We also played a major role in NASA's Subsonic aircraft: Contrail and Cloud Effects Special Study (SUCCESS) field project. This project was aimed at better understanding the impact of aviation on clouds and at better understanding the ability to remotely sense the properties of clouds. This multi-aircraft campaign obtained a wealth of data that indicate the difficulty of detecting contrails from space, and illustrate the difficulty of correctly obtaining cloud-particle size and other data from remote-sensing measurements.

Principal Investigator

Owen Brian Toon

Brian Toon completed an A. B. in physics at U. C. Berkeley in 1969 and a Ph.D. in physics at Cornell University in 1975 with Professor Carl Sagan. He joined NASA Ames' civil service staff in 1978 and retired from the federal government in 1997. He became a Professor in the Atmospheric and Oceanic Department and a member of the Laboratory for Atmospheric and Space Physics at the University of Colorado in 1997.

His research is focused on radiative transfer, aerosol and cloud physics, as well as atmospheric chemistry. He has published about 200 papers. He was the Deputy Project Scientist for the 1987 Airborne Antarctic Ozone Expedition, and the DC-8 Flight Scientist in the 1989 and 1992 Airborne Arctic Stratospheric Expeditions, which sought to understand the reasons for polar-ozone loss. He was the co-Project Scientist for the Tropical Ozone Transport Experiment, a 1995-96 aircraft mission to investigate stratospheric transport processes in the Arctic and in the

tropics. He was also the Project Scientist for the Subsonic Aircraft: Contrail and Cloud Effect Special Study, a 1996 multi-aircraft campaign whose goal was to learn about the formation and radiative properties of cirrus clouds and the effects that aircraft may have on them. In addition to being an EOS IDS he is a team member of HIRDLS.

Toon received NASA's medal for Exceptional Scientific Achievement in 1983 for studies of the climates of Earth and the planets, and again in 1989 for work on the ozone hole. He was a co-winner of the American Physical Society's 1985 Leo Szilard Award for Physics in the Public Interest for his work on nuclear winter. He received the Washington D.C. Jaycees' 37th Annual Arthur Flemming Award for outstanding individual performance in the Federal Government. He was elected a Fellow of the American Meteorological Society in 1990, and a Fellow of the American Geophysical Union in 1992.

Co-Investigators

Irina Sokolik - *University of Colorado, Boulder*

Andy Ackerman - *University of Colorado, Boulder*

Eric Jensen - *NASA/Ames Research Center*

References

Ackerman, A.S., O.B. Toon, and P.V. Hobbs, 1995: Numerical modeling of ship tracks produced by injections of cloud condensation nuclei into marine stratiform clouds. *J. Geophys. Res.*, **100**, 7121-7134.

Toon, O.B., 1995: Modeling the relationships between aerosol properties and the direct and indirect effects of aerosols on climate. Aerosol Forcing of Climate, Dahlem Workshop Report ES 17, R.J. Charlson and J. Heintzenberg, Eds., J. Wiley & Sons, 197-213.

Zhao, J., R.P. Turco, and O.B. Toon, 1995: A model simulation of Pinatubo volcanic aerosols in the stratosphere. *J. Geophys. Res.*, **100**, 7315-7328.

Sokolik, I., and O.B. Toon, 1996: Direct radiative forcing by anthropogenic airborne mineral aerosols. *Nature*, **381**, 681-683.

Jensen, E.J., O.B. Toon, H.B. Selkirk, and J. Spinhirne, 1996: On the formation and persistence of subvisible cirrus clouds near the tropical tropopause. *J. Geophys. Res.*, **101**, 21,361-21,376.

Investigation URL

<http://lerxst.colorado.edu/groupweb/>

A Numerical Analysis of New Nitrogen Sources of NO_3 and N_2 Affecting Carbon Cycling in the Southern Caribbean Sea: A Key to CDOC Contamination of Satellite Color Signals

Principal Investigator – **John J. Walsh**

Science Background

A simple numerical model (Walsh and Dieterle 1994; Walsh et al. 1997) of carbon/nitrogen cycling within the Bering/Chukchi Seas and early field observations of total DOC and chlorophyll biomass in the North Sea first suggested that ~50% of the CZCS color signal, sensed above the 70-m isobath of these sub-polar shelves, might be composed of colored dissolved organic carbon (CDOC). A more-complex, spectral bio-optical model (Hochman et al. 1995) of the western English Channel indeed indicated that 39% of the color signal after the spring bloom and 46-76% during the fall overturn was CDOC contamination of Case-II shelf waters. A similar third spectral model (Bissett et al. 1998a), embedded within our more-complex food-web model (Bissett et al. 1998b) of multiple phytoplankton groups, replicated some recent bio-optical observations at the JGOFS time series site in the Sargasso Sea. Our most recent analysis of the BATS data suggests that absorption of light by CDOC at both 412 nm and 442 nm is equivalent to that by pigments for two 30-day periods, after the spring bloom and during the fall overturn, even within Case-I waters around Bermuda! Finally, in the southern Caribbean Sea, away from the influence of the Orinoco River, preliminary model simulations (Walsh et al. 1998) and a 1995-1998 in situ time series in the Cariaco Basin concur in suggesting that past CZCS imagery may have overestimated seasonal changes of phytoplankton biomass here as well.

Science Goal

In the otherwise oligotrophic Caribbean Sea, distinct seasonal periods of wind-forced upwelling, deposition of Fe-rich Saharan aerosols, and river discharge provide a unique opportunity to examine the persistence of CDOC, provided by: 1) physical injection from the aphotic zone, 2) biological release from surface blooms of the cyanophyte, *Trichodesmium*, which provide DOM at a rate of as much as 50% of N_2 -fixation, and 3) lateral supply from land. We wish to test the hypothesis that after injection of "new"

nitrogen, by coastal upwelling during the winter/spring, by nitrogen-fixation in the summer, and by river runoff in the fall, CDOC of distinct physical and biological origins will continue to contaminate the color signals of the southern Caribbean Sea, seen now by the SeaWiFS sensor. Similarly, in the eastern Gulf of Mexico, arrival of Saharan aerosols during June-July may stimulate cyanophyte blooms on the oligotrophic West Florida shelf, serving as an ultimate nutrient source for subsequent noxious red-tides (Walsh 1996), sensed later in the fall by past CZCS imagery (Gilbes et al. 1996).

Current Activities

We are now using our coupled biological/physical models of carbon/nitrogen cycling by phytoplankton, zooplankton, and bacteria to assess the impacts of nitrogen fixation and upwelling during new production within the shelf environs of the Cariaco Basin. During spring upwelling in response to a mean wind forcing of 8 m sec^{-1} , the physical model matches AVHRR and hydrographic estimates of surface temperature. Within the 3-D flow field, the steady solutions of the biological model of a simple food web of diatoms, adult copepods, and ammonifying/nitrifying bacteria underestimate by ~9%, however, the mean spring observations of settling fluxes caught by a sediment trap at ~240 m, moored at our time-series site in the Basin.

The models also overestimate by ~12% the average ^{14}C net primary production and by ~29% the chlorophyll biomass at the site, but they do mimic the observed spatial fields of nitrate and light penetration during the same time period of February-April. To evaluate the importance of CDOC impact on both the amount of refractory metabolites and light-regulated primary production, one must have some understanding of its time-dependent sources and sinks (Walsh et al. 1992). To explore the above lack of covariance between CDOC and other optical properties, we considered both a strongly colored and weaker source of CDOC. We conclude that smaller amounts of CDOC are a correct description of the site's light field

during spring, but not in the summer/fall cases of the model (Walsh et al. 1998).

Addition of a slow-growing cyanophyte, with another source of new nitrogen and large releases of DOM, would remedy the deficiencies of the models, attributed to use of a single phytoplankton group, i.e., diatoms. Indeed, our $\delta^{15}\text{N}$ isotope budgets of dissolved and particulate forms of nitrogen suggest that neglected diazotrophs may contribute 19-34% of new production during spring, none in summer, and 57-78% in fall. We were able, based on the structure of the simulation models, to match $\delta^{15}\text{N}$ of particulate matter suspended in the water column and caught by sediment traps in the Cariaco Basin (Walsh et al. 1998).

Use of Satellite Data

Using concurrent AVHRR imagery of SST and aerosol optical thickness to distinguish different periods of upwelling and of iron deposition, the time-dependent introduction of CDOC to surface waters, by both physical supply and phytoplankton loss, will be analyzed in relation to the photolysis there of CDOC and to the changing seasonal contamination of SeaWiFS images above both the Venezuelan shelf of the southern Caribbean Sea and the West Florida shelf of the Gulf of Mexico.

Participation in Field Activities

Further assessment of the spring nitrogen/carbon economies of the Venezuelan shelf requires: 1) representation of *Trichodesmium* as an explicit state variable of a more-complex model, 2) an analysis of their role in other seasons of the year, 3) consideration of the time-dependent delivery of atmospheric nutrients, e.g., iron, and 4) addition of picoplankton and protozoan components of the microbial food web as co-occurring state variables with diatoms and cyanophytes. Time series of CDOM, DOM, and the optical signatures of the excretory products of diatoms, cyanophytes, flagellates, and their predators are similarly required.

Validation data of the bio-optical part of these analyses will thus consist of in-water optical measurements made along the Venezuelan coast, from the mouth of the Orinoco River to the stenohaline Cariaco Basin, as part of separately funded NASA SIMBIOS and EOS Interdisciplinary projects at USF, conducted by my colleague Frank E. Muller-Karger. Additional field data on dissolved Fe, $\delta^{15}\text{N}$ of particulate matter, and *Trichodesmium* abundance, will be collected during dust events on the west Florida shelf as part of a NOAA/EPA/ONR ECOHAB project. Finally, a NASA pre-doctoral fellowship is supporting the thesis work of Mr. Chris Catral, under the supervision of Ken Carder at USF, to estimate the aerosol content seen by SeaWiFS during Saharan outbursts.

Principal Investigator

John J. Walsh

John J. Walsh received M.S and Ph.D. degrees at the University of Miami and was a pre- and postdoctoral fellow at Oak Ridge National Laboratory and the University of Washington. He is currently a Distinguished Research Professor at the University of South Florida and is the author of two books and over 90 papers on biological oceanography. His awards include a Pre-doctoral Fellowship, Ford Foundation (1967); Gold Medal of Science, University of Liege (1980); Fellow of the Amer. Assoc. Adv. Sci. (1990); and Professorial Excellence Program, USF (1996). His research covers systems analysis of continental shelves, biological components of global carbon and nitrogen budgets, and numerical models of marine food webs, constrained by satellite data sets.

References

- Bissett, W.P., K.L. Carder, J.J. Walsh, and D.A. Dieterle: Carbon cycling in the upper waters of the Sargasso Sea, II, Numerical simulation of apparent and inherent optical properties. *Deep-Sea Res.*, in press.
- Bissett, W.P., J.J. Walsh, D.A. Dieterle, and K.L. Carder: Carbon cycling in the upper waters of the Sargasso Sea, I, Numerical simulation of differential carbon and nitrogen fluxes. *Deep-Sea Res.*, in press.
- Gilbes, F., C. Tomas, J.J. Walsh, and F.E. Muller-Karger, 1996: An episodic chlorophyll plume on the west Florida shelf. *Cont. Shelf Res.*, **16**, 1201-1224.
- Hochman, H.T., J.J. Walsh, K.L. Carder, A. Sournia, and F.E. Muller-Karger. 1995: Analysis of ocean color components within stratified and well-mixed waters of the western English Channel. *J. Geophys. Res.*, **100**, 10,777-10,787.
- Walsh, J.J. 1996: Nitrogen-fixation within a tropical upwelling ecosystem: Evidence for a Redfield budget of carbon/nitrogen cycling by the total phytoplankton community. *J. Geophys. Res.*, **101**, 20,607-20,616.
- Walsh, J.J., K.L. Carder, and F.E. Muller-Karger, 1992: Meridional fluxes of dissolved organic matter in the North Atlantic. *J. Geophys. Res.*, **97**, 15,625-15,637.
- Walsh, J.J., and D.A. Dieterle, 1994: CO_2 cycling in the coastal ocean. I. A numerical analysis of the southeastern Bering Sea, with applications to the Chukchi Sea and the northern Gulf of Mexico. *Progr. Oceanogr.*, **34**, 335-392.

Walsh, J.J., D.A. Dieterle, F.E. Muller-Karger, K. Aagaard, A.T. Roach, T.E. Whittedge, and D. Stockwell, 1997: CO₂ cycling in the coastal ocean. II. Seasonal organic loading to the Canadian Basin from source waters south of Bering Strait. *Cont. Shelf Res.*, 17, 1-36.

Walsh, J.J., D.A. Dieterle, F.E. Muller-Karger, R. Bohrer, W.P. Bissett, R. Aparicio, R. J. Varela, H.T. Hochman, C. Schiller, R. Diaz, R. Thunell, G.T. Taylor, M.I. Scranton, K.A. Fanning, and E.T. Peltzer: Isotope constraints on numerical simulation of carbon/nitrogen cycling during spring upwelling in the Cariaco Basin. *J. Geophys. Res.*, submitted.

An Interdisciplinary Investigation of Clouds and the Earth's Radiant Energy System: Analysis (CERES-A)

Principal Investigator – **Bruce A. Wielicki**

Science Background

The CERES-A interdisciplinary science (IDS) investigation examines the role of clouds and radiative energy balance in the climate system. Studies include cloud feedback mechanisms, which can greatly modify the response of the climate system to increased greenhouse gases. Initial CERES-A general circulation modeling (GCM) studies have shown that cloud-radiative heating might enhance the strength of the Hadley cell by as much as a factor of two.

A typical research strategy for studies of global systems must encompass scientific problems at a wide range of time and space scales. We develop and apply a series of radiative and dynamical cloud models that range from highly detailed Large Eddy Simulation models which resolve scales between 50 meters and 5 km, to greatly simplified GCM cloud models which resolve scales between 200 km and global. Definitive progress is achieved through a combination of careful observations and modeling studies made across all of the scales important for the understanding of cloud and radiation processes.

This IDS investigation is closely tied to the CERES instrument investigation. Our studies will be used to validate CERES instrument measurements and will use the CERES instrument data to study the role of clouds in the climate system. The CERES instrument investigation focuses on production of the cloud and radiation budget data needed for our investigation and other EOS-sponsored studies. These data products utilize not only CERES broadband radiance data, but also depend critically on cloud data derived using the VIRS (Visible and Infrared Scanner) on TRMM and using MODIS on Terra and EOS PM. The cloud properties are matched to each CERES broadband field of view, allowing derivation of a consistent set of cloud properties and radiative fluxes. The CERES instrument provides radiative flux estimates at the top of the atmosphere, at the surface, and at several levels within the atmosphere. These data are critical to the CERES-A climate-system studies.

Science Goals

Goals of the investigation include: 1) extend the studies of cloud-radiative effects beyond the top of the atmosphere

to the radiative balance at the surface of the Earth and to radiative heating/cooling within the atmosphere; 2) extend the studies of cloud-radiative effects using the more-accurate CERES top-of-atmosphere radiative fluxes; 3) examine the use of satellite-derived radiative fluxes to develop improvements in medium-range forecasting; and 4) validate the cloud properties and radiative fluxes produced by the CERES instrument investigation.

Current Activities

Studies are under way to examine the role of clouds in the tropical ocean heat balance, to examine the amount of atmospheric heating produced by the absorption of solar energy in clouds, and to examine potential cloud feedback systems. Studies have also included determination of the impact of the Pinatubo eruption on the Earth's radiative-energy balance.

Prospective validation of CERES instrument observations relies on direct observations of surface radiative fluxes (shortwave and longwave) as well as cloud properties using surface remote sensing (radiometers, lidar, and radar). Key surface data are being obtained, working jointly with the DoE ARM (Atmospheric Radiation Measurement) program, the BSRN (Baseline Surface Radiation Network) of the World Climate Research Program, the Surface Radiation Budget and the NASA FIRE (First ISCCP [International Satellite Cloud Climatology Project] Regional Experiment).

Use of Satellite Data

This interdisciplinary investigation will use the CERES instrument investigation data products as its prime source of global data on cloud properties and radiative fluxes. Other important input data for this investigation will include temperature and humidity profiles (NCEP, ECMWF, and EOS DAO 4-D assimilation), sea-surface and land temperatures (MODIS, AIRS), cloud liquid water (TMI, AMSR-E), and ocean-surface winds (scatterometers). Other satellite data will also be examined to provide coverage of the global oceans and polar regions. For cloud properties, satellite-based lidar (GLAS) as well as a potential future cloud radar system (CloudSat) placed into synergistic orbit with EOS PM will be key to determin-

ing the effects of optically thin cirrus and overlapping cloud layers and for validating EOS cloud-property retrieval methods. For validating the effects of non-parallel clouds, the EOS MISR multi-angle radiance data will provide key tests of the accuracy of cloud-radiative models and remote sensing.

Participation in Field Programs

The CERES-A investigation is working closely with the FIRE cloud field experiment, which will be examining polar clouds and tropical cirrus in the next 5 years. CERES-A is also coordinating closely for a long time series of surface and in-atmosphere radiative flux measurements being taken as part of the DOE ARM program, the GEWEX (Global Energy and Water cycle Experiment), and the WCRP BSRN surface-measurement program.

Principal Investigator

Bruce A. Wielicki

Bruce Wielicki was awarded a Ph.D. in Physical Oceanography from the Scripps Institution of Oceanography in 1980. He has focused primarily on atmospheric research concerning cloud properties, cloud remote sensing, and the Earth's radiation budget. Following a 3-year assignment at NCAR, Wielicki joined the NASA/Langley Research Center as a Research Scientist in 1980. At NASA he served as a Principal Investigator on the Landsat Thematic Mapper and Earth Radiation Budget Experiment (ERBE) science teams. He currently is a Principal Investigator for the First ISCCP Regional Experiment (FIRE). Wielicki received the NASA medal for Exceptional Scientific Achievement in 1992 and the American Meteorological Society Houghton Award in 1995.

Co-Investigators

Robert D. Cess - *State University of New York at Stony Brook*

James A. Coakley, Jr. - *Oregon State University*

Dominique Crommelynck - *Royal Meteorological Institute, Belgium*

Leo J. Donner - *NOAA/Geophysical Fluid Dynamics Laboratory*

Robert S. Kandel - *CNRS Ecole Polytechnique, France*

Michael D. King - *NASA/Goddard Space Flight Center*

Alvin J. Miller - *NOAA/National Centers for Environmental Prediction*

v. Ramanathan - *Scripps Institution of Oceanography*

David A. Randall - *Colorado State University*

G. Louis Smith - *Virginia Polytechnic Institute and State University*

Larry L. Stowe - *NOAA/NESDIS*

Ronald M. Welch - *University of Alabama/Huntsville*

The following are from NASA/Langley Research Center:

Bruce R. Barkstrom

Ryan A. Baum

Thomas P. Charlock

Richard N. Green

David P. Kratz

Robert B. Lee III

Patrick Minnis

David F. Young

References

Cess, R.D., M.H. Zhang, P. Minnis, L. Corsetti, E.G. Dutton, B.W. Forgan, D.P. Garber, W.L. Gates, J.J. Hack, E.F. Harrison, X. Jing, J.T. Kiehl, C.N. Long, J.-J. Morcrette, G.L. Potter, V. Ramanathan, B. Subasilar, C.H. Whitlock, D.F. Young, and Y. Zhou, 1995: Absorption of solar radiation by clouds: Observations versus models. *Science*, **267**, 496-499.

Fowler, L.D., and D.A. Randall, 1994: A global radiative convective feedback. *Geophys. Res. Lett.*, **21**, 2035-2038.

Minnis, P., E.F. Harrison, L.L. Stowe, G.G. Gibson, F.M. Denn, D.R. Doelling, and W.L. Smith, Jr., 1993: Radiative forcing by the Mount Pinatubo eruption. *Science*, **259**, 1411-1415.

Ramanathan, V., B. Subasilar, G.J. Zhang, W. Conant, R.D. Cess, J.T. Kiehl, H. Grassl, and L. Shi, 1995: Warm pool heat budget and shortwave cloud forcing: A missing physics? *Science*, **267**, 499-503.

Wielicki, B. A., R. D. Cess, M. D. King, D. A. Randall, and E. F. Harrison, 1995: Mission to Planet Earth: Role of Clouds and Radiation in Climate. *Bull. Amer. Meteor. Soc.*, **76**, 2125-2153.

Wielicki, B. A., B. R. Barkstrom, E. F. Harrison, R. B. Lee III, G. L. Smith, and J. E. Cooper, 1996: Clouds and the Earth's Radiant Energy System (CERES): An Earth Observing System Experiment. *Bull. Amer. Meteor. Soc.*, **77**, 853-868.

Investigation URL

<http://asd-www.larc.nasa.gov/ASDhomepage.html>

Terrestrial Hydrology and Climate Studies Using EOS-Era Data

Principal Investigator – **Eric F. Wood**

Science Background

Understanding the role of the terrestrial hydrosphere-biosphere in Earth's climate system, especially in the coupling of land-surface hydrologic processes to atmospheric processes over a range of spatial and temporal scales, the role of the land surface in climate variability and climatic extremes, and its role in climate change and terrestrial productivity are integral components of EOS science objectives for terrestrial hydrology and ecology (Running et al. 1997). They also are central science objectives of the World Climate Research Program (WCRP) activities under GEWEX, and, in particular, the GEWEX continental-scale experiments (GCIP, BALTEX, MAGS, LBA, and GAME).

There is an extensive body of research over the last 30 years to support the contention that land-surface processes control local climate through the partitioning of precipitation and incoming radiation into their budget components. What is not well understood are the mean values and variability of the water- and energy-budget terms over a range of temporal and continental-to-global spatial scales. The inherent research strategy for EOS and WCRP/GEWEX for investigating these issues is through process-based, terrestrial water- and energy-balance models. This strategy was developed because the historical record related to the terms in the water- and energy-balance equations is too short, and the required spatial and temporal observations are too extensive, costly, and logistically impractical to support the analysis.

Large-scale applications of energy- and water-balance models are greatly complicated by the scarcity of land-surface observations and difficulties in representing hydrological processes at large scales. This recognition in the early 1980's resulted the establishment of climate experimental programs like HAPEX (Hydrology Atmospheric Parameterization Experiment) and ISLSCP (International Satellite Land Surface Climatology Programme) as initiatives of the WMO/ICSU Joint Scientific Committee for WCRP. In the late 1980s, ICSU established a core project on the Biospheric Aspects of the Hydrological Cycle (BAHC) with a research focus on the spatial and temporal integration of biospheric-hydro-spheric interactions. In addition, the above strategy supported remote-sensing initiatives which resulted in the

recent availability of consistent, long-term remote sensing records, such as AVHRR (Agbu, 1993), GOES (Young, 1995) and SSM/I (Hollinger et al., 1992) Pathfinder data sets; the compilation of remote-sensing data as part of ISLSCP initiatives (Scellers et al., 1994, Meeson et al., 1995), recent advances in remote-sensing algorithms for deriving forcing variables such as radiation, humidity, and surface air temperature; and the development of new remote-sensing instruments such as TRMM (for precipitation) and the future suite of EOS sensors that may be used directly or indirectly to estimate the required variables.

Scientific Motivation and Goals

Achievement of the WCRP GEWEX science objectives to understand the seasonal, annual, and interannual variability of water and energy cycles, and the EOS science objectives for terrestrial hydrology and ecology requires continental-to-global-scale fields of water and energy fluxes and storages at high spatial and temporal resolution that need to be well validated.

Implicit within GEWEX and EOS science plans is the belief that remote sensing will provide products that are appropriate for hydrological modeling, and that the current generation of models can ingest these products and provide the continental-to-global fields to address the scientific objectives. It is the central premise of this research proposal that this research strategy is feasible, but it still needs to be demonstrated at continental and global scales. Furthermore, it needs to be demonstrated that model-derived water and energy fluxes can provide the necessary data for in-depth analyses of the seasonal, annual, and interannual variability of the terrestrial water and energy balances at regional-to-global scales.

Thus, the goals of the proposed research are to demonstrate that continental-to-global-scale water and energy balance fields can be estimated through a combination of process-based terrestrial hydrological models and remote-sensing inputs, and that diagnostic studies with these model-derived fields can be carried out to further our understanding of the role of land-surface processes in the global hydrological cycle.

Science Issues and Questions

Science issues central to the proposed research include:

- What are the characteristics of the terrestrial surface water and energy balances, including their seasonal, annual, and interannual variability over a range of temporal and spatial scales, and how do these characteristics vary in different climates and locations on Earth?
- What role does the terrestrial hydrosphere-biosphere play in Earth's climate system, including the factors that control partitioning of precipitation and incoming radiation and their budget components, and how do these factors vary with climatic conditions (including changes in land-surface conditions) and seasonality?

To answer these issues, requires a consideration of the following research questions:

- What are the spatial and temporal resolution and accuracy requirements of continental-scale water- and energy-balance fields needed to answer the GEWEX and EOS science objectives related to water and energy balances?
- Can these requirements be achieved through a combination of hydrological modeling and remote sensing, including a determination of which remote-sensing-derived products are most appropriate for hydrological modeling at continental-to-regional scales?
- Can model-derived, continental-scale water- and energy-balance fields be validated and if so, how?

Research Strategy

A multi-scale research strategy has been developed that provides an end-to-end proof-of-concept for the research strategy for selected periods. This research strategy can be summarized as follows:

- 1) The development, calibration, and validation of process-based hydrologic models using data from small-scale land-surface experiments (Liang et al. 1994; Liang et al. 1996; Peters-Lidard et al. 1997);
- 2) The use of the developed models to scale up to larger spatial scales on the order of 10⁵ sq km, with foci on

model parameterizations at regional scales and on testing remote-sensing products in the hydrological models (Abdulla et al. 1996; Nijssen et al. 1997; Wood et al. 1997); and

- 3) The simulation of continental-to-global fields of water and energy fluxes through modeling and remote sensing, and their validation using large-scale hydrologic data (Dubayah et al. 1997).

Table 1 illustrates the implementation of this strategy. Current activities are directed towards extending these results at larger regional-to-global-scale basins, validation of the water- and energy-balance models at these scales, testing of remote-sensing products, and initial diagnostic analyses using model-based fields of water and energy flux and storage variables. Initial global water balance simulations have been carried out using observed daily precipitation and temperature data. A global validation strategy is being developed around a set of continental-scale river basins distributed globally, including the major GEWEX basins.

Current Use Of Satellite Data

Solar Radiation: Incoming and net solar radiation are derived using the GOES-VISSR sensor (e.g., Pinker et al. 1992; Whitlock et al. 1995; Dubayah and Loechel 1997).

Air Temperature: Spatially-varying air temperature may be estimated using AVHRR data as shown in Goward et al. (1994), Prince and Goward (1995), Prihodko and Goward (1997), Prince et al. (1997), and Dubayah et al. (1997). Dubayah et al. (1997) also have shown how TOVS-derived air temperature may be used for hydrological modeling.

<i>Modeling/ Observations</i>	<i>Scale (sq. km)</i>	<i>Research focus</i>	<i>Research Objective</i>	<i>Data set/ experiment</i>
Small Scale	10 ² -10 ³	Process modeling	Land-atmospheric interactions	FIFE, BOREAS, SIR-C, PILPS
Medium Scale	10 ⁴ -10 ⁵	Coupled models	Scaling	GCIP-SW
		Remote sensing	Test algorithms	Red-Arkansas basins
Large Scale	10 ⁵ -10 ⁶	Budget analysis	continental-scale variability	PILPS-2c, ISLSCP, Schnur and Lettenmaier (1997)

Table 1: Implementation of observation-modeling strategy

Surface Humidity: Total-column precipitable water may be derived in a variety of ways, including the split-window differential-absorption techniques used in AVHRR and GOES methods, as well as the sounding and data-assimilation strategy using TOVS data (Dubayah et al. 1997).

Precipitation: Estimation of precipitation by satellite remote sensing remains problematic at time scales required by hydrologic models (see Adler et al. 1994). While missions such as TRMM have great promise for improving climatological estimates of precipitation, and perhaps for estimating areal precipitation at monthly-to-seasonal time steps, the current (and planned) platforms suffer from an inability to observe the diurnal cycle directly.

Pre-EOS remote-sensing data products expected to be available include precipitation (GPCP Version 1a Combined Precipitation Data Set [Huffman 1996]), vegetation/land-use products developed by the MODIS instrument team (Running et al. 1997), snow extent and snow-water-equivalent data sets archived at the National Snow and Ice Data Center, and global atmospheric water-vapor products from TOVS.

Participation in Field Activities

The science strategy uses data sets from small-scale land-surface experiments for the development, calibration, and validation of process-based hydrologic models, and data from continental-scale GEWEX projects to develop model parameterizations at regional scales, to test remote-sensing products in the hydrological models, and to validate the models at regional-to-continental scales.

As part of this strategy, we will utilize and participate in a wide variety of field experiments. To date we have used data from the following experiments: the First ISLSCP Fields Experiment, the Boreal Ecosystem-Atmospheric Study (BOREAS) (see <http://www.princeton.edu/~cewr/hydrology>); the GEWEX Continental Scale Project (GCIP) in the Mississippi River basin; Mackenzie GEWEX Study (MAGS); Southern Great Plains (SGP) Experiment.

Principal Investigator

Eric F. Wood

Eric F. Wood is a terrestrial hydrologist at Princeton University (in the Program for Environmental Engineering and Water Resources, Department of Civil and Environmental Engineering). He received his doctorate from the Massachusetts Institute of Technology in 1974 working with Ignacio Rodriguez-Iturbe in statistical hydrology. After a 30-month research appointment at the International Institute for Applied Systems Analysis in Laxenburg, Austria, he was appointed as an Assistant Pro-

fessor at Princeton University, being promoted to Associate Professor in 1981 and Full Professor in 1986. He served as the Director of the Water Resources Program from 1982-1993. He is a Fellow of the American Geophysical Union and the American Meteorology Society, and has served or serves on numerous journal editorial boards, society committees, and NRC's Water Science and Technology Board and Board on Atmospheric Science and Climate. His research focuses on hydroclimatology and remote sensing, with an emphasis on land-surface hydrologic parameterization and their scaling behavior over a range of spatial and temporal scales with interests ranging from tower scales to continental domains. He has been an investigator in a number of ISLSCP field experiments including FIFE and BOREAS, and in SIR-C; using this field and remote sensing data as an integral part of his model development and validation research.

Co-Investigators

Dennis Lettenmaier, - *University of Washington*

Ralph Dubayah - *University of Maryland*

References

- Abdulla, F.A., D.P. Lettenmaier, E.F. Wood, and J.A. Smith, 1996: Application of a Macroscale Hydrological Model to Estimate the Water Balance of the Arkansas-Red River Basin. *J. Geophys. Res.*
- Adler, R.F., G.J. Huffman, and P.R. Keehn, 1994: Global rain estimates from microwave-adjusted geosynchronous IR data. *Remote Sens. Rev.*, **11**, 125-152.
- Agbu, P., B. Vollmer, and M. James, 1993: Pathfinder AVHRR land data set, NASA Goddard Space Flight Center, Greenbelt, MD.
- Dubayah, R., E.F. Wood, M. Zion, and K. Czajkowski, 1997: A remote sensing approach to macroscale hydrological modeling, in Schultz, G. and E. Engman (Eds.) Remote sensing in hydrology and water management, Springer-Verlag.
- Dubayah, R., and S. Loebel, 1997: Modeling topographic solar radiation using GOES data. *J. Appl. Meteor.*, **36**, 141-154.
- Goward, S.N., R.H. Varling, D.G. Dye, and J. Yang 1994: Ecological remote sensing at OTTER: satellite macroscale observations. *Ecological Appl.*, **4**, 332-343.
- Hollinger J., J. Pierce, and G. Poe., 1990: SSM/I instrument evaluation. *IEEE Trans. Geosci. and Remote Sens.*, **28**, 781-790.

Huffman, G.J., 1996: GPCP Version 1a combined precipitation data set documentation, Laboratory for Atmospheres, NASA Goddard Space Flight Center, September 9, 1996.

Liang, X., E.F. Wood, and D.P. Lettenmaier, 1996: Surface Soil Moisture Parameterization of the VIC-2L Model: Evaluation and Modifications. *Global and Planetary Change*, **13**, 195-206.

Liang, X., D.P. Lettenmaier, E.F. Wood, and S.J. Burges, 1994: A Simple Hydrologically Based Model of Land Surface Water and Energy Fluxes for General Circulation Models. *J. Geophys. Res.*, **99**, 14,415-14,428.

Meeson, B.W., F.E. Corprew, J.M.P. McManus, D.M. Myers, J.W. Closs, K.J. Sun, J. Sunday, and P.J. Sellers, ISLSCP Initiative I-Global Data Sets for Land Atmosphere Models, 1987-1988, Vols. 1-5, NASA, CD-ROM, 1995.

Nijssen, B., D.P. Lettenmaier, X. Liang, S.W. Wetzel, and E.F. Wood, 1997: Simulation of Runoff from Continental-Scale River Basin using a Grid-Based Land Surface Scheme. *Water Resour. Res.*, **33**, 711-724.

Peters-Lidard, C., M. Zion, and E.F. Wood, 1997a: A soil-vegetation-atmosphere transfer scheme for modeling spatially variable water and energy balance processes. *J. Geophys. Res.*, **102**, 4303-4324.

Pinker, R.T., and I. Laszlo, 1992: Modeling surface solar irradiance for satellite applications on a global scale. *J. Appl. Meteor.*, **31**, 194-211.

Prihodko, L., and S.N. Goward, Estimation of air temperature from remotely sensed observations. *Remote Sens. Environ.*, in review.

Prince, S.L., Goetz, S.J., Dubayah, R., Czajkowski, K., and M. Thaler, 1997: Inference of surface and air temperature, atmospheric precipitable water and vapor pressure deficit using AVHRR satellite observations: validation of algorithms. *J. Hydrol.*, in press.

Running S., J. Collatz, J. Washburn, and S. Sorooshian, (editors.) 1997: EOS Science Plan, Chapter 5, Land Ecosystems and Hydrology, NASA HQ, Washington, DC.

Schnur, R., and D.P. Lettenmaier, 1997: Global gridded data set of daily soil moisture for use in General Circulation Models, presented at the 13th Conference in Hydrology, AMS Meeting, Long Beach, CA.

Sellers, P.J., C.J. Tucker, G.J. Collatz, S.O. Los, C.O. Justice, D.A. Dazlich, and D.A. Randall, 1994: A global 1-degree by 1-degree NDVI data set for climate studies. Part2: The generation of global fields of terrestrial biophysical parameters from the NDVI. *Int. J. Remote Sensing*, **15**, 3519-3545.

Whitlock, C.H., T.P. Charlock, W.F. Staylor, R.T. Pinker, I. Laszlo, A. Ohmura, H. Gilgen, R.C. DiPasquale, S.R. LeCroy, and N.A. Ritchey, 1995: First Global WCRP Surface Radiation Budget Data Set. *Bull. Amer. Met. Soc.*, **76**, 905-922.

Wood, E.F., D.P. Lettenmaier, X. Liang, B. Nijssen, and S. W. Wetzel, 1997: Hydrological Modeling of Continental-Scale Basins. *Annual Reviews of Earth and Planetary Sciences*, **25**, 279-300.

Wu, M.C., and C. Cleng, 1989: Surface downward flux computed by using geophysical parameters derived from HIRS 2/MSU soundings. *Theor. Appl. Climatol.*, **40**, 37-51.

Young, J., J. Hagens, and D. Wade., 1995: GOES pathfinder product generation system, 9th Conference on Applied Climatology, Dallas, TX, American Meteorological Society, Boston, MA.

Points of Contact

EOS Project Science Office

Michael D. King

Senior Project Scientist

Code 900

NASA/Goddard Space Flight Center

Greenbelt, Maryland 20771

Phone: 301/614-5636

Fax: 301/614-5620

Internet: king@climate.gsfc.nasa.gov

EOS Missions and Platforms

Terra

Yoram J. Kaufman

Project Scientist

Code 913

NASA/Goddard Space Flight Center

Greenbelt, Maryland 20771

Phone: 301/614-6189

Fax: 301/614-6307

Internet: kaufman@climate.gsfc.nasa.gov

Landsat 7

Darrel L. Williams

Project Scientist

Code 923

NASA/Goddard Space Flight Center

Greenbelt, Maryland 20771

Phone: 301/614-6692

Fax: 301/614-6695

Internet: darrel@ltpmail.gsfc.nasa.gov

EOS PM

Claire L. Parkinson

Project Scientist

Code 971

NASA/Goddard Space Flight Center

Greenbelt, Maryland 20771

Phone: 301/614-5715

Fax: 301/614-5644

Internet: clairep@neptunc.gsfc.nasa.gov

Jason-1

Lee-Lueng Fu

Project Scientist

Mail Stop 300-323

Jet Propulsion Laboratory

4800 Oak Grove Drive

Pasadena, California 91109

Phone: 818/354-8167

Fax: 818/393-6720

Internet: llf@pacific.jpl.nasa.gov

ICESat**H. Jay Zwally***Project Scientist*

Code 971

NASA/Goddard Space Flight Center
Greenbelt, Maryland 20771*Phone:* 301/614-5643*Fax:* 301/614-5644*Internet:* jay@intrepid.gsfc.nasa.gov**EOSDIS****Skip Reber***Project Scientist*

Code 900

NASA/Goddard Space Flight Center
Greenbelt, Maryland 20771*Phone:* 301/614-5201*Fax:* 301/614-5267*Internet:* reber@skip.gsfc.nasa.gov**EOS CHEM****Mark R. Schoeberl***Project Scientist*

Code 910

NASA/Goddard Space Flight Center
Greenbelt, Maryland 20771*Phone:* 301/614-6002*Fax:* 301/614-5903*Internet:* schom@zephyr.gsfc.nasa.gov**SeaWinds****W. Timothy Liu***Project Scientist*

Code 300-323

Jet Propulsion Laboratory

4800 Oak Grove Drive

Pasadena, California 91109

Phone: 818/354-2394*Fax:* 818/393-6720*Internet:* liu@pacific.jpl.nasa.gov**ESSP****James J. Garvin***Project Scientist*

Code 921

NASA/Goddard Space Flight Center
Greenbelt, Maryland 20771*Phone:* 301/614-6504*Fax:* 301/614-6522*Internet:* garvin@denali.gsfc.nasa.gov**Validation****David Starr***Validation Scientist*

Code 913

NASA/Goddard Space Flight Center
Greenbelt, Maryland 20771*Phone:* 301/614-6191*Fax:* 301/614-6307*Internet:* starr@climate.gsfc.nasa.gov**SAGE III****William P. Chu***Project Scientist*

Mail Stop 475

NASA/Langley Research Center
Hampton, Virginia 23681*Phone:* 757/864-2675*Fax:* 757/864-2671*Internet:* William.P.Chu@larc.nasa.gov**Calibration****James Butler***Calibration Scientist*

Code 925

NASA/Goddard Space Flight Center
Greenbelt, Maryland 20771*Phone:* 301/614-5942*Fax:* 301/614-5790*Internet:* butler@highwire.gsfc.nasa.gov**SORCE****Robert F. Cahalan***Project Scientist*

Code 913

NASA/Goddard Space Flight Center
Greenbelt, Maryland 20771*Phone:* 301/614-5390*Fax:* 301/614-5493*Internet:* Robert.Cahalan@gsfc.nasa.gov

Instruments

ACRIM III

Richard C. Willson

Principal Investigator

Columbia University

1001 B Avenue, Suite 200

Coronado, California 92118

Phone: 619/522-2945 or 619/628-8507

Fax: 619/575-8173 or 619/522-2967

Internet: acrim@znet.com

AIRS/AMSU-A/HSB

Moustafa T. Chahine

Team Leader

Jet Propulsion Laboratory

4800 Oak Grove Drive

Mail Stop 180-904

Pasadena, California 91109-8099

Phone: 818/354-6057

Fax: 818/393-4218

Internet: moustafa.t.chahine@jpl.nasa.gov

AMSR-E

Roy W. Spencer

Team Leader - U.S.

NASA/Marshall Space Flight Center

Code ES43

977 Explorer Blvd.

Huntsville, Alabama 35806

Phone: 256/922-5960

Fax: 256/922-5788

Internet: roy.spencer@msfc.nasa.gov

Akira Shibata

Team Leader - Japan

National Space Development Agency of Japan/

Earth Observing Research Center

1-9-9, Roppongi

Minato-ku, Tokyo, 106

JAPAN

Phone: 81-33-224-7040

Fax: 81-33-224-7051

Internet: Ashibata@corc.nasda.go.jp

ASTER

Hiroji Tsu

Science Team Leader - Japan

Earth Remote Sensing Data Analysis Center

(ERSDAC)

Forefront Tower

3-12-1 Kachidoki Chuo-ku

Tokyo, 104

JAPAN

Phone: 81-33-533-9380

Fax: 81-33-533-9383

Internet: tsu@gsj.go.jp

Anne Kahle

Team Leader - U.S.

Jet Propulsion Laboratory

4800 Oak Grove Drive

Mail Stop 183-501

Pasadena, California 91109

Phone: 818/354-7265

Fax: 818/354-0966

Internet: anne@aster.jpl.nasa.gov

CERES

Bruce R. Barkstrom

Principal Investigator

NASA/Langley Research Center

Mail Stop 420

Hampton, Virginia 23681-2199

Phone: 757/864-5676

Fax: 757/864-7996

Internet: brb@ceres.larc.nasa.gov

EOSP

Larry D. Travis

Principal Investigator

NASA/Goddard Institute for Space Studies

2880 Broadway

New York, New York 10025

Phone: 212/678-5599

Fax: 212/678-5622

Internet: ltravis@giss.nasa.gov

ETM+**Samuel Goward***Team Leader*

University of Maryland
1113 LeFrak Hall
College Park, Maryland 20742

Phone: 301/405-4055

Fax: 301/314-9299

Internet: sg21@umail.umd.edu

GLAS**Bob E. Schutz***Team Leader*

University of Texas at Austin
Center for Space Research, C0605
Austin, Texas 78712-1085

Phone: 512/471-4267

Fax: 512/471-3570

Internet: schutz@csr.utexas.edu

HIRDLS**John Barnett***Co-Principal Investigator*

Atmospheric, Oceanic, and Planetary Sciences

Oxford University

Clarendon Laboratory

Oxford, OX1 3PU

UNITED KINGDOM

Phone: 44-186-527-2909

Fax: 44-186-527-2923

Internet: barnett@isams.atm.ox.ac.uk

John C. Gille*Co-Principal Investigator*

National Center for Atmospheric Research

Atmospheric Chemistry Division

P. O. Box 3000

Boulder, Colorado 80307

Phone: 303/497-1402

Fax: 303/497-1492

Internet: gille@ncar.ucar.edu

Jason-1**Lee-Lueng Fu***Principal Investigator - U.S.*

Jet Propulsion Laboratory

4800 Oak Grove Drive

Mail Stop 300-323

Pasadena, California 91109

Phone: 818/354-8167

Fax: 818/393-6720

Internet: llf@pacific.jpl.nasa.gov

Yves Menard*Principal Investigator - France*

Centre National d'Etudes Spatiales

DSO/ED/AL

bpi 2002

18 Ave. Edouard Belin

31401 Toulouse, Cedex

FRANCE

Phone: 33-56-127-4872

Fax: 33-56-128-2595

Internet: Yves.Menard@cnes.fr

LIS**Hugh J. Christian***Principal Investigator*

NASA/Marshall Space Flight Center

Code ES41

977 Explorer Blvd.

Huntsville, Alabama 35806

Phone: 205/922-5828

Fax: 205/922-5723

Internet: hugh.christian@msfc.nasa.gov

MISR**David J. Diner***Principal Investigator*

Jet Propulsion Laboratory

4800 Oak Grove Drive

Mail Stop 169-237

Pasadena, California 91109-8099

Phone: 818/354-6319

Fax: 818/393-4619

Internet: djd@jrd.jpl.nasa.gov

MLS**Joe W. Waters***Principal Investigator*

Jet Propulsion Laboratory

4800 Oak Grove Drive

Mail Stop 183-701

Pasadena, California 91109-8099

Phone: 818/354-3025*Fax:* 818/393-5065*Internet:* joe@mls.jpl.nasa.gov**MODIS****Vincent V. Salomonson***Team Leader*

NASA/Goddard Space Flight Center

Code 900

Greenbelt, Maryland 20771

Phone: 301/614-5634*Fax:* 301/614-5620*Internet:* vsalomon@pop900.gsfc.nasa.gov**MOPITT****James R. Drummond***Principal Investigator*

University of Toronto

Department of Physics

60 St. George Street

Toronto, Ontario M5S 1A7

CANADA

Phone: 416/978-4723*Fax:* 416/978-8905*Internet:* jim@atmosp.physics.utoronto.ca**OMI****Pieter Levelt***Principal Investigator*

Royal Netherlands Meteorological Institute (KNMI)

Climate Research and Seismology Department

Atmospheric Sciences Division

P.O. Box 210

3730 AE De Bilt

The Netherlands

Phone: 31-30-220-6667 or 220-6416*Fax:* 31-30-221-0407*Internet:* levelt@knmi.nl**SAGE III****M. Patrick McCormick***Principal Investigator*

Hampton University

Center for Atmospheric Sciences

23 Tyler Street

Hampton, Virginia 23668

Phone: 757/728-6867*Fax:* 757/727-5090*Internet:* mcc@hamptonu.edu**SeaWinds****Michael H. Freilich***Principal Investigator*

Oregon State University

College of Oceanic and Atmospheric Sciences

Oceanography Administration Bldg. 104

Corvallis, Oregon 97331-5503

Phone: 503/737-2748*Fax:* 503/737-2064*Internet:* mhf@oce.orst.edu**SORCE****Gary J. Rottman***Principal Investigator*

Laboratory for Atmospheric and Space Physics

University of Colorado

Campus Box 590

Boulder, Colorado 80309-0590

Phone: 303/492-8324*Fax:* 303/492-6444*Internet:* Gary.Rottman@lasp.colorado.edu**TES****Reinhard Beer***Principal Investigator*

Jet Propulsion Laboratory

4800 Oak Grove Drive

Mail Stop 183-301

Pasadena, California

Phone: 818/354-4748*Fax:* 818/393-4445*Internet:* Reinhard.Beer@jpl.nasa.gov

Interdisciplinary Investigations

Mark R. Abbott

Principal Investigator

Oregon State University
College of Oceanic and Atmospheric Sciences
Oceanography Administration Bldg. 104
Corvallis, Oregon 97331-5503

Phone: 541/737-4045

Fax: 541/737-2064

Internet: mark@oce.orst.edu

Kevin Arrigo

Principal Investigator

Code 971
NASA/Goddard Space Flight Center
Greenbelt, Maryland 20771

Phone: 301/286-9634

Fax: 301/286-0240

Internet: Kevin.R.Arrigo.1@gsfc.nasa.gov

Marcia Baker

Principal Investigator

University of Washington
Geophysics Program
Box 351650

Seattle, Washington 98195-1650

Phone: 206/685-3799

Fax: 206/543-0489

Internet: marcia@geophys.washington.edu

Eric J. Barron

Principal Investigator

Pennsylvania State University
Earth System Science Center
248 Deike Building
University Park, Pennsylvania 16802

Phone: 814/865-1619

Fax: 814/865-3191

Internet: eric@essc.psu.edu

Ian J. Barton

Principal Investigator

CSIRO Marine Research
GPO Box 1538
Hobart, Tasmania 7001
AUSTRALIA

Phone: 61-02325222

Fax: 61-02325000

Internet: Ian.Barton@marine.csiro.au

G. Robert Brakenridge

Principal Investigator

Department of Geography
Dartmouth College
Hanover, New Hampshire 03755

Phone: 603/646-2870

Fax: 603/646-1601

Internet: G.Robert.Brakenridge@dartmouth.edu

Ken Caldeira

Principal Investigator

Climate System Modeling Group
Lawrence Livermore National Laboratory
7000 East Avenue

Livermore, California 94550

Phone: 925/423-4191

Fax: 925/423-6388

Internet: kenc@llnl.gov

Douglas G. Capone

Principal Investigator

Chesapeake Biological Laboratory
University of Maryland Center for Environmental
Science

Solomons, Maryland 20688-0038

Phone: 410/326-7250

Fax: 410/326-7341

Internet: capone@cbl.umces.edu

Mary-Elena Carr

Principal Investigator

Jet Propulsion Laboratory
4800 Oak Grove Drive
Pasadena, California 91109

Phone: 818/354-5097

Fax: 818/393-6720

Internet: mec@pacific.jpl.nasa.gov

William Chameides

Principal Investigator

School of Earth and Atmospheric Sciences
Georgia Institute of Technology
221 Bobby Dodd Way
Atlanta, Georgia 30332-0340

Phone: 404/894-1749

Fax: 404/894-1106

Internet: william.chameides@eas.gatech.edu

Josef Cihlar**Principal Investigator**

Canada Centre for Remote Sensing
588 Booth Street
4th Floor
Ottawa, Ontario K1A 0Y7
CANADA
Phone: 613/947-1265
Fax: 613/947-1406
Internet: cihlar@ccrs.emr.ca

Jean O. Dickey**Principal Investigator**

Jet Propulsion Laboratory/Caltech
M/S 238-332
4800 Oak Grove Drive
Pasadena, California 91109
Phone: 818/354-3235
Fax: 818/393-6890
Internet: jean.o.dickey@jpl.nasa.gov

Robert E. Dickinson**Principal Investigator**

University of Arizona
1118 E 4th St
P.O. Box 210081
Tucson, Arizona 85721-0081
Phone: 520/621-2810
Fax: 520/621-6833
Internet: robted@hail.atmo.arizona.edu

Paul A. Dirmeyer**Principal Investigator**

Center for Ocean-Land-Atmosphere Studies
Institute of Global Environment & Society Inc
4041 Powder Mill Road
Suite 302
Calverton, Maryland 20705-3106
Phone: 301/902-1254
Fax: 301/595-9793
Internet: dirmeyer@cola.iges.org

Jeff Dozier**Principal Investigator**

School of Environmental Science and Management
University of California
Santa Barbara, California 93106
Phone: 805/893-7363
Fax: 805/893-7612
Internet: dozier@icess.ucsb.edu

Ralph Dubayah**Principal Investigator**

Department of Geography
1113 Lefrak Hall
University of Maryland
College Park, MD 20742
Phone: 301/405-4069
Fax: 301/314-9299
Internet: rdubayah@geog.umd.edu

Thomas Dunne**Lead U.S. Co-Investigator**

School of Environmental Science & Management
University of California Santa Barbara
4670 Physical Sciences North
Santa Barbara, California 93106 USA
Phone: 805/893-7557
Fax: 805/893-7612
Internet: tdunne@esm.ucsb.edu

Dara Entekhabi**Principal Investigator**

Department of Civil Environmental Engineering
Massachusetts Institute of Technology
48-331
Cambridge, Massachusetts 01239
Phone: 617/253-9698
Fax: 617/258-8850
Internet: darac@mit.edu

Jonathan A. Foley**Principal Investigator**

Climate, People, and Environment Program (CPEP)
Institute for Environmental Studies
University of Wisconsin
1225 West Dayton Street
Madison, Wisconsin 53706
Phone: 608/265-5144
Fax: 608/263-4190
Internet: jfoley@facstaff.wisc.edu

Paul Falkowski**Principal Investigator**

Environmental Biophysics & Molecular Ecology
Program
Institute of Marine & Coastal Sciences
Rutgers University
71 Dudley Road
New Brunswick, New Jersey 08903
Phone: 732/932-6555
Fax: 732/932-8578
Internet: falko@imcs.rutgers.edu

Inez Fung**Principal Investigator**

Center for Atmospheric Sciences
301 McCone Hall #4767
University of California, Berkeley
Berkeley, California 94720
Phone: 510/643-9367
Fax: 510/643-9377
Internet: ifung@uclink4.berkeley.edu

Steven J. Ghan**Principal Investigator**

Climate Dynamics Group
Mail Stop K9-30
Battelle Pacific Northwest Laboratory
3200 Q Avenue
Richland, Washington 99352
Phone: 509/372-6169
Fax: 509/372-6168
Internet: steve.ghan@pnl.gov

Barry E. Goodison**Principal Investigator**

Climate Research Branch
Atmospheric Environment Service
4905 Dufferin Street
Downsview, Ontario M3H 5T4
CANADA
Phone: 416/739-4345
Fax: 416/739-5700
Internet: Barry.Goodison@ec.gc.ca

Sirpa Hakkinen**Principal Investigator**

NASA Goddard Space Flight Center
Oceans and Ice Branch
Code 971
Greenbelt, Maryland 20771
Phone: 301/614-5712
Fax: 301/614-5644
Internet: hakkinen@gsfc.nasa.gov

James E. Hansen**Principal Investigator**

NASA/Goddard Institute for Space Studies
2880 Broadway
New York, New York 10025
Phone: 212/678-5500
Fax: 212/678-5622
Internet: jhansen@giss.nasa.gov

Dennis L. Hartmann**Principal Investigator**

University of Washington
Department of Atmospheric Science
Box 351640
Seattle, Washington 98195-1640
Phone: 206/543-7460
Fax: 206/685-9302
Internet: dennis@atmos.washington.edu

Eileen Hofmann**Principal Investigator**

Center for Coastal Physical Oceanography
Crittenton Hall
Old Dominion University
Norfolk, Virginia 23529
Phone: 757/683-5334
Fax: 757/683-5550
Internet: hofmann@ccpo.odu.edu

Brent Holben**Principal Investigator**

Code 923
NASA/Goddard Space Flight Center
Greenbelt, Maryland 20771
Phone: 301/614-6658
Fax: 301/614-6695
Internet: brent.holben@gsfc.nasa.gov

Marc L. Imhoff**Principal Investigator**

Code 923
NASA/Goddard Space Flight Center
Greenbelt, Maryland 20771
Phone: 301/614-6628
Fax: 301/614-6695
Internet: marc.imhoff@gsfc.nasa.gov

Thomas J. Jackson**Principal Investigator**

Hydrology Laboratory
U.S. Department of Agriculture
Building 007, BARC West, Room 104
Beltsville, Maryland 20705
Phone: 301/504-8511
Fax: 301/504-8931
Internet: tjackson@hydr.arsusda.gov

Daniel J. Jacob
Principal Investigator
 Harvard University
 Pierce Hall
 29 Oxford Street
 Cambridge, Massachusetts 02138
 Phone: 617/495-1794
 Fax: 617/495-4551
 Internet: djj@io.harvard.edu

Prasad Kasibhatla
Principal Investigator
 Nicholas School of the Environment
 Duke University
 P.O. Box 90328
 Durham, North Carolina 27708
 Phone: 919/613-8075
 Fax: 919/684-8741
 Internet: psk9@duke.edu

Ralph F. Keeling
Principal Investigator
 Scripps Institution of Oceanography
 University of California, San Diego
 9500 Gilman Drive
 La Jolla, California 92093
 Phone: 619/534-7582
 Fax: 619/534-2997
 Internet: rkeeling@ucsd.edu

Yann H. Kerr
Principal Investigator
 Centre National d'Etudes Spatiales
 CESBIO
 18 Avenue Edouard Belin
 31401 Toulouse, Cedex 4
 FRANCE
 Phone: 33-56-155-8522
 Fax: 33-56-155-8500
 Internet: yann.kerr@cesbio.cnes.fr

Jeffrey T. Kiehl
Principal Investigator
 National Center for Atmospheric Research
 P.O. Box 3000
 Boulder, Colorado 80307
 Phone: 303/497-1350
 Fax: 303/497-1324
 Internet: jtkon@ncar.ucar.edu

Charles E. Kolb
Principal Investigator
 Center for Atmospheric and Environmental Chemistry
 Aerodyne Research, Inc.
 45 Manning Road
 Billerica, Massachusetts 01821
 Phone: 978/663-9500
 Fax: 978/663-4918
 Internet: kolb@aerodyne.com

Randal D. Koster
Principal Investigator
 Hydrological Sciences Branch
 Laboratory for Hydrospheric Processes
 NASA/Goddard Space Flight Center
 Greenbelt, Maryland 20771
 Phone: 301/614-5781
 Fax: 301/614-5808
 Internet: randal.koster@gsfc.nasa.gov

William K. M. Lau
Principal Investigator
 NASA/Goddard Space Flight Center
 Code 913
 Greenbelt, Maryland 20771
 Phone: 301/614-6772
 Fax: 301/614-6307
 Internet: lau@climate.gsfc.nasa.gov

W. Timothy Liu
Principal Investigator
 Jet Propulsion Laboratory
 4800 Oak Grove Drive
 Mail Stop 300-323
 Pasadena, California 91109
 Phone: 818/354-2394
 Fax: 818/393-6720
 Internet: liu@pacific.jpl.nasa.gov

Yongqiang Liu
Principal Investigator
 School of Earth and Atmospheric Sciences
 Georgia Institute of Technology
 Atlanta, Georgia 30332
 Phone: 404/385-0584
 Fax: 404/894-1106
 Internet: liuy@cas.gatech.edu

John Marshall**Principal Investigator**

Massachusetts Institute of Technology
77 Massachusetts Avenue
Bldg. 54-1256
Cambridge, Massachusetts 02139
Phone: 617/253-9615
Fax: 617/253-4464
Internet: marshall@gulf.mit.edu

Charles R. McClain**Principal Investigator**

Code 970.2
NASA/Goddard Space Flight Center
Greenbelt, Maryland 20771
Phone: 301/286-5377
Fax: 301/286-1775
Internet: mcclain@calval.gsfc.nasa.gov

Dennis McGillicuddy**Principal Investigator**

Woods Hole Oceanographic Institution
Woods Hole, Massachusetts 02543
Phone: 508/289-2683
Fax: 508/457-2194
Internet: dmcgillicuddy@whoi.edu

Linda O Mearns**Principal Investigator**

Environmental and Societal Impacts Group
National Center for Atmospheric Research
P.O. Box 3000
Boulder, Colorado 80307
Phone: 303/497-8124
Fax: 303/497-8125
Internet: lindam@ucar.edu

Massimo Menenti**Principal Investigator**

Winand Staring Center
P.O. Box 125
Wageningen, 6700AC
The Netherlands
Phone: 31 317 474324
Fax: 31 317 424812
Internet: m.menenti@sc.dlo.nl

Norman L. Miller**Principal Investigator**

Earth Sciences Division
Berkeley National Laboratory
University of California
One Cyclotron Road, M/S 90-1116
Berkeley, California 94720
Phone: 510/495-2374
Fax: 510/486-7070
Internet: nlmiller@lbl.gov

Berrien Moore III**Principal Investigator**

University of New Hampshire
Morse Hall Room 305
Durham, New Hampshire 03824
Phone: 603/862-1766
Fax: 603/862-1915
Internet: bmoore@unh.edu

Peter J. Mouginiis-Mark**Principal Investigator**

Hawaii Institute of Geophysics & Planctology
University of Hawaii
2525 Correa Road
Honolulu, Hawaii 96822
Phone: 808/956-3147
Fax: 808/956-6322
Internet: pmm@pgd.hawaii.edu

Frank Muller-Kruger**Principal Investigator**

Department of Marine Science
University of South Florida
140 7th Avenue South
St. Petersburg, Florida 33701
Phone: 727/553-3335
Fax: 727/553-1103
Internet: carib@carbon.marine.usf.edu

Masato Murakami**Principal Investigator**

Typhoon Research Department
Meteorological Research Institute
1-1 Nagamine, Tsukuba-shi
Ibaraki 305
JAPAN
Phone: 81-29-855-2683
Fax: 81-29-853-8668
Internet: mmurakam@mri-jma.go.jp

Raymond C. Najjar
Principal Investigator
 Department of Meteorology
 503 Walker Building
 Pennsylvania State University
 University Park, Pennsylvania 16802
Phone: 814/863-1586
Fax: 814/865-3663
Internet: najjar@essc.psu.edu

Kenneth E. Pickering
Principal Investigator
 Department of Meteorology
 University of Maryland
 College Park, Maryland 20742
Phone: 301/405-7639
Fax: 301/314-9482
Internet: pickerin@metosrv2.umd.edu

Roger A. Pielke, Sr.
Principal Investigator
 Department of Atmospheric Science
 Colorado State University
 Fort Collins, Colorado 80523
Phone: 970/491-8293
Fax: 970/491-8293
Internet: pielke@hercules.atmos.colostate.edu

John Adrian Pyle
Principal Investigator
 Cambridge University
 Department of Chemistry
 Lensfield Road, Cambridge CB2 1EW
 UNITED KINGDOM
Phone: 44-12-236-1188
Fax: 44-12-234-6739
Internet: pyle@atm.ch.cam.ac.uk

Dale A. Quattrochi
Principal Investigator
 Global Hydrology and Climate Center
 NASA/Marshall Space Flight Center
 977 Explorer Boulevard
 Huntsville, Alabama 35806
Phone: 256/922-5887
Fax: 256/922-5723
Internet: dale.quattrochi@msfc.nasa.gov

John O. Roads
Principal Investigator
 Climate Research Division
 Scripps Institution of Oceanography
 University of California-San Diego
 9500 Gilman Drive
 La Jolla, California 92093
Phone: 619/534-2099
Fax: 619/534-8561
Internet: jroads@ucsd.edu

Richard B. Rood
Principal Investigator
 NASA/Goddard Space Flight Center
 Code 910.3
 Greenbelt, Maryland 20771
Phone: 301/614-6155
Fax: 301/614-6297
Internet: rood@dao.gsfc.nasa.gov

Cynthia Rosenzweig
Principal Investigator
 NASA/Goddard Institute for Space Studies
 2880 Broadway
 New York, New York 10025
Phone: 212/678-5562
Fax: 212/678-5648
Internet: crosenzweig@giss.nasa.gov

D. Andrew Rothrock
Principal Investigator
 University of Washington
 Applied Physics Laboratory
 Mail Stop HN-10
 Seattle, Washington 98195
Phone: 206/685-2262
Fax: 206/543-3521
Internet: rothrock@apl.washington.edu

David S. Schimel
Principal Investigator
 National Center for Atmospheric Research
 PO Box 3000
 Boulder, Colorado 80307-3000
Phone: 303/497-1610
Fax: 303/497-1695
Internet: schimel@ncar.ucar.edu

Mark R. Schoeberl
Principal Investigator
 NASA/Goddard Space Flight Center
 Code 910
 Greenbelt, Maryland 20771
Phone: 301/614-6002
Fax: 301/614-5903
Internet: Mark.Schoeberl@gsfc.nasa.gov

Christopher A. Shuman
Principal Investigator
 NASA/Goddard Space Flight Center
 Code 971
 Greenbelt, MD 20771
Phone: 301/614-5881
Fax: 301/614-5644
Internet: shuman@hardy.gsfc.nasa.gov

David Siegel
Principal Investigator
 Institute for Computational Earth System Science
 University of California at Santa Barbara
 Santa Barbara, California 93106-3060
Phone: 805/893-4547
Fax: 805/893-2578
Internet: davey@icess.uscb.edu

W. James Shuttleworth
Principal Investigator
 Department of Hydrology & Water Resources
 Bldg. 11
 University of Arizona
 Tucson, Arizona 85721
Phone: 520/621-8787
Fax: 520/621-1422
Internet: shuttle@hwr.arizona.edu

Ronald B. Smith
Principal Investigator
 Department of Geology and Geophysics
 Yale University
 P.O. Box 208109
 New Haven, Connecticut 06520
Phone: 203/432-3129
Fax: 203/432-3134
Internet: ronald.smith@yale.edu

Joao V. Soares
Principal Investigator
 Instituto Nacional de Pesquisas Espaciais
 Divisao de Sensoriamento Remoto
 Avenida dos Astronautas, 1758 - C.P. 515
 12227-010 Sao José dos Campos, SP
 BRAZIL
Phone: 55-12-345-6439
Fax: 55-12-345-6488
Internet: vianei@tid.inpe.br

Soroosh Sorooshian
Lead U.S. Investigator
 University of Arizona
 Department of Hydrology and Water Resources
 Harshbarger Building, Room 122
 Tucson, Arizona 85721
Phone: 520/621-1661
Fax: 520/626-2488
Internet: soroosh@hwr.arizona.edu

Meric A. Srokosz
Principal Investigator
 Southampton Oceanography Centre (SOC)
 Empress Dock, Southampton SO14 3ZH
 UNITED KINGDOM
Phone: 44-170-359-6414
Fax: 44-170-359-6400
Internet: M.Srokosz@soc.soton.ac.uk

Graeme Stephens
Principal Investigator
 Atmospheric Science Department
 Colorado State University
 Ft. Collins, Colorado 85721
Phone: 970/491-8541
Fax: 970/491-8449
Internet: stephens@atmos.colostate.edu

Byron D. Tapley
Principal Investigator
 The University of Texas - Austin
 Center for Space Research R1000
 3925 West Breaker Lane, Suite 200
 Austin, Texas 78712
Phone: 512/471-5573
Fax: 512/232-2443
Internet: tapley@csr.utexas.edu

Ina Tegen

Principal Investigator

Department of Applied Physics

Columbia University

2880 Broadway

New York, New York 10027

Phone: 212/678-5573

Fax: 212/678-5552

Internet: itegen@giss.nasa.gov

Owen B. Toon

Principal Investigator

Laboratory for Atmospheric & Space Physics

University of Colorado

Campus Box 392

Boulder, Colorado 80309

Phone: 303/492-1534

Fax: 303/492-6946

Internet: toon@lasp.colorado.edu

John J. Walsh

Principal Investigator

Dept. of Marine Science

University of South Florida

140 7th Avenue South

St. Petersburg, Florida 33701

Phone: 727/553-1164

Fax: 727/553-1189

Internet: jwalsh@seas.marine.usf.edu

Bruce A. Wielicki

Principal Investigator

NASA/Langley Research Center

Mail Stop 420

Hampton, Virginia 23681-2199

Phone: 757/864-5683

Fax: 757/864-7996

Internet: b.a.wielicki@larc.nasa.gov

Eric F. Wood

Principal Investigator

Department of Civil and Environmental Engineering

Princeton University

Princeton, New Jersey 08544

Phone: 609/258-4675

Fax: 609/258-2799

Internet: efwood@pucc.princeton.edu

Page intentionally left blank

Acronyms and Abbreviations

2D Two Dimensional
3D Three Dimensional
4DDA 4-Dimensional Data Assimilation

A

A/SA arid/semi-arid
AABW Antarctic Bottom Water
AAOE Airborne Antarctic Ozone Experiment
AASE II Airborne Arctic Stratospheric Expedition II
AATSR Advanced Along Track Scanning Radiometer
ABS oxygen A-Band Spectrometer
ACRIM Active Cavity Radiometer Irradiance Monitor
AC Atmospheric Corrector
ACSYS Arctic Climate System Study
ADEOS Advanced Earth Observation Satellite
AEAP Atmospheric Effects of Aviation Program
AERONET Aerosol Robotic Network
AESOPS Antarctic Environment Southern Ocean Process Study
AESP Aerospace Education Services Program
AGCM Atmospheric General Circulation Models
AGU American Geophysical Union
AHM (model)
AIAA American Institute of Aeronautics and Astronautics
AIRSAR Airborne Synthetic Aperture Radar
ALI Advanced Land Imager
ALOS Advanced Land Observation Satellite
ALT Altimeter
AMI Active Microwave Instrument
AMIP Atmospheric Model Intercomparison Project
AMLS Array MLS
AMS American Meteorological Society
AMSR Advanced Microwave Scanning Radiometer

AMSR-E Advanced Microwave Scanning Radiometer (EOS Version)
AMSU Advanced Microwave Sounding Unit
AO Announcement of Opportunity
APAR Absorbed Photosynthetically-Active Radiation
APFZ Antarctic Polar Frontal Zone
API Application Programming Interface
APT Automatic Picture Transmission
ARM Atmospheric Radiation Measurement
ASAR Advanced Synthetic Aperture Radar
ASF Alaska SAR Facility
ASHOE Airborne Southern Hemisphere Ozone Experiment
ASTER Advanced Spaceborne Thermal Emission and Reflection Radiometer
ASTEX Atlantic Stratocumulus Transition Experiment
ATBD Algorithm Theoretical Basis Document
ATLAS Atmospheric Laboratory for Applications and Science
ATMOS Atmospheric Trace Molecule Spectroscopy
ATSR Along Track Scanning Radiometer
AVHRR Advanced Very High-Resolution Radiometer
AVIRIS Airborne Visible-Infrared Imaging Spectrometer
AWS Automatic Weather Station

B

BAHC Biospheric Aspects of the Hydrological Cycle
BASIC Bay Area Shared Information Consortium
BATS Biosphere-Atmosphere Transfer Model
BIOME Biogeochemical Information Ordering Management Environment
BOREAS Boreal Ecosystems Atmosphere Study
BRDF Bidirectional Reflectance Distribution Function
BSRN Baseline Surface Radiation Network
BUV Backscatter Ultraviolet

C

CALM	Circumpolar Active Layer Monitoring
CAPE	Convection and Precipitation Electrification field project
CARIACO	Carbon Retention In A Colored Ocean
CART	Cloud and Radiation Testbed
CASES	Cooperative Atmosphere-Surface Exchange Study
CCD	Charge-Coupled Device
CCN	Cloud Condensation Nuclei
CDIAC	Carbon Dioxide Information and Analysis Center
CDOC	colored dissolved organic carbon
CDOM	Colored Dissolved Organic Matter
CEES	Committee on Earth and Environmental Sciences
CEM	Cumulus Ensemble Model
CENR	Committee on the Environment and Natural Resources
CEOS	Committee on Earth Observation Satellites
CERES	Clouds and the Earth's Radiant Energy System
CESAR	Cloud Electrification Studies using Aircraft and Radar
CESBIO	Centre d'Études Spatiales de la Biosphère
CFC	Chlorofluorocarbon
CH₂Cl₂	Dichloromethane
CH₃Cl	Methyl chloride
CHCl₃	Chloroform
CHAMP	Challenging Mini-satellite Payload
CHEM-1	Chemistry Mission-1
CLAES	Cryogenic Limb Array Etalon
CLASS	Canadian Land Surface Scheme
CLIVAR	CLimate VARIability and prediction
ClO_x	oxides of chlorine family
CMDL	Climate Monitoring and Diagnostics Laboratory
CMIS	Conical Microwave Imager Sounder
CNES	Centre National d'Études Spatiales (France)
CPEP	Climate, People and Environment Program
CPR	Cloud Profiling Radar
CPTEC	Center for Weather and and Climate Prediction (Brazil)
CSMS	Communications and System Management Segment
COARE	Coupled Ocean-Atmosphere Response
CODMAC	Committee on Data Management, Archiving, and Computing
COS	Carbonyl Sulfide
COSEPUP	Committee on Science, Engineering, and Public Policy
COV	Coefficient of Variation

CPR	Cloud Profiling Radar
CR	Correlation Radiometry
CRIS	Cross-track Infrared Sounder
CRYSYS	Use of the Cryospheric System to Monitor Global Change in Canada (EOS IDS)
CSA	Canadian Space Agency
CSIRO	Commonwealth Scientific and Industrial Research Organization
CTM	Chemistry and Transport Model
CZCS	Coastal Zone Color Scanner

D

DAAC	Distributed Active Archive Center
DAO	Data Assimilation Office
DAS	Data Assimilation System
DDL	Direct Downlink
DECAFE	Dynamique et Chimie de l'Atmosphère en Forêt Equatoriale
DEM	Digital Elevation Model
DFA	Dual-Frequency radar Altimeter
DGVM	Dynamic Global Vegetation Models
DISORT	Discrete Ordinate Radiative Transfer Model
DMS	Dimethyl Sulfide
DMSP	Defense Meteorological Satellite Program
DMWG	Data Management Working Group
DoC	Department of Commerce
DoD	Department of Defense
DoE	Department of Energy
DOM	Dissolved Organic Matter
DORIS	Doppler Orbitography and Radiopositioning Integrated by Satellite
DSB	Direct Sounding Broadcast
DT	Delta T (Temperature)
DU	Dobson Unit
DWL	Doppler Wind Lidar

E

EASOE	European Arctic Stratospheric Ozone Experiment
EBC	Eastern Boundary Currents
EBNet	EOS Backbone Network
ECHIVAL	European International Project on Climate and Hydrological Interactions between Vegetation, Atmosphere, and Land Surfaces
ECLIPS	Experimental Cloud Lidar Pilot Study
ECMWF	European Centre for Medium-Range Weather Forecasts

ECS EOSDIS Core System
EDC EROS Data Center
EDOS EOS Data and Operations System
EFEDA ECHIVAL Field Experiment in Desertification-Threatened Areas
EGIG Expédition Glaciologique Internationale au Groenland
ELV Expendable Launch Vehicle
ENSO El Niño-Southern Oscillation
ENVISAT Environmental Satellite, ESA
EO-1 Earth Orbiter-1
EOS Earth Observing System
EOS PM EOS afternoon-crossing satellite
EOSDIS EOS Data and Information System
EOSP Earth Observing Scanning Polarimeter
EOSPSO EOS Project Science Office
EP Earth Probe
EPA Environmental Protection Agency
EPGS EOS Polar Ground Station
EPOP European Polar-Orbiting Platform
ER-2 NASA Research Aircraft
ERB Earth Radiation Budget
ERBE Earth Radiation Budget Experiment
ERBS Earth Radiation Budget Satellite
ERCN Educator Resource Center Network
ERG EOSDIS Review Group
EROS Earth Resources Observation System
ERS European Remote-Sensing Satellite
ERS-1 European Remote-Sensing Satellite-1
ERTS Earth Resources Technology Satellite
ESA European Space Agency
ESSAAC Earth System Science and Applications Advisory Committee
ESCC Electrically Self-Calibrating Cavity
ESDIS Earth Science Data and Information System
ESE Earth Science Enterprise
ESIP Earth Science Information Partner
ESMR Electrically Scanning Microwave Radiometer
ESR Electrical Substitution Radiometer
ESSC Earth System Sciences Committee
ESSP Earth System Sciences Pathfinder
ET Evapotranspiration
ETM Enhanced Thematic Mapper
ETM+ Enhanced Thematic Mapper Plus
EURECA European Retrievable Carrier

F

FAA Federal Aviation Administration
FAO Food and Agriculture Organization
FAPAR Fraction Absorbed Photosynthetically Active Radiation
FIFE First ISLSCP Field Experiment
FIRE First ISCCP Regional Experiment
FLUXNET Flux Network
FOO Flight Of Opportunity
FOS Flight Operations Segment
FPAR Fraction of Photosynthetically-Active Radiation
FSSP Forward Scattering Spectrometer Probe
FTS Fourier Transform Spectrometer
FY Fiscal Year

G

GAC Global Area Coverage
GAIM Global Analysis, Interpretation, and Modeling
GAME GEWEX Asian Monsoon Experiment
GAME-T GEWEX Asian Monsoon Experiment-Tropics
GAP Gap Analysis Project
GCIP GEWEX Continental-Scale International Project
GCM General Circulation Model (also Global Climate Model)
GCOS Global Climate Observing System
GCTE Global Change in Terrestrial Ecosystems
GDP Gross Domestic Product
GEBA Global Energy Balance Archive
GENESIS Global Environmental and Ecological Simulation of Interactive Systems
GEOCOMP GEOcoding and COMpositing system
GEOS Goddard Earth Observing System
GERB Geostationary Earth Radiation Budget
GEWEX Global Energy and Water cycle Experiment
GFDL Geophysical Fluid Dynamics Laboratory
GFO Geosat Follow-On
GGD Global Geocryology Database
GHCN Global Historical Climatology Network
GIS Geographic Information System
GISP Greenland Ice Sheet Program
GISS Goddard Institute for Space Studies
GLAS Geoscience Laser Altimeter System
GLCTS Global Landcover Test Site Initiative
GLI Global Imager

GLIMS Global Land Ice Monitoring from Space
GLIS Global Land Information System
GLOBE Global Learning and Observations to Benefit the Earth
GLOBEC Global Ocean Ecosystem Dynamics
GMS Geostationary Meteorological Satellite
GNP Gross National Product
GOALS Global Ocean-Atmosphere-Land System
GOES Geostationary Operational Environmental Satellite
GOMOS Global Ozone Monitoring By Occultation of Stars
GPCP Global Precipitation Climatology Project
GPP Gross Primary Productivity
GPS Global Positioning System
GPSOS Global Positioning Sensor Occultation System
GRACE Gravity Recovery And Climate Experiment
GRDC Global Runoff Data Center
GSFC Goddard Space Flight Center
GSRP Graduate Student Researchers Program
Gt Gigaton
GTOS Global Terrestrial Observing System
GVaP GEWEX Water Vapor Project

H

HAIRS High Accuracy Inter-satellite Ranging System
HALOE Halogen Occultation Experiment
HAPEX Hydrological-Atmospheric Pilot Experiment
HCFC Hydrochlorofluorocarbon
HH Horizontal, Horizontal Polarization
HEIFE Heihe basin Field Experiment
HIRDLS High-Resolution Dynamics Limb Sounder
HIRS High-Resolution Infrared Radiation Sounder
HNLC High Nutrient, Low Chlorophyll
HO_x odd hydrogen family
HRDI High-Resolution Doppler Imager
HRPT high-resolution picture transmission
HSB Humidity Sounder - Brazil
HSCT High-Speed Civil Transport
HUBEX Huaihe Basin Experiment

I

IABP International Arctic Buoy Program
IAVCEI International Association of Volcanology and Chemistry of the Earth's Interior
IBS Integrated Biosphere Simulator

ICESat Ice, Clouds, and Land Elevation Satellite
ICRCCM Intercomparison of Radiative Codes for Climate Models
ICSU International Council of Scientific Unions
IDS Interdisciplinary Science Investigation (EOS)
IELV Intermediate Expendable Launch Vehicle
IEOS International Earth Observing System
IFC Intensive Field Campaign
IFO Intensive Field Observation
IFOV Instantaneous Field of View
IGAC International Global Atmospheric Chemistry
IGBP International Geosphere-Biosphere Programme
IGPPDI Global Primary Production Data Initiative
IHP International Hydrological Program
IIP Instrument Incubator Program
ILAS Improved Limb Atmospheric Spectrometer
IMARPE Instituto del Mar de Peru
IMAS Integrated Multispectral Atmospheric Sounder
IMS Information Management System
INDOEX Indian Ocean Experiment
IOC Intergovernmental Oceanographic Commission
IOP Intensive Observing Period
IPCC Intergovernmental Panel on Climate Change
IPO Integrated Program Office
IR infrared
IRR Imaging Infrared Radiometer
ISAMS Improved Stratospheric and Mesospheric Sounder
ISCCP International Satellite Cloud Climatology Project
ISLSCP International Satellite Land Surface Climatology Project
IT Instrument Team
ITCZ Inter-Tropical Convergence Zone
IWG Investigators Working Group
IWP ice water path

J

JERS Japanese Earth Remote-Sensing Satellite
JERS-OPS Japanese Earth Remote-sensing Satellite-OPS
JEXAM Japanese Experiment of Asian Monsoon
JGOFS Joint Global Ocean Flux Study
JMR Jason Microwave Imager
JORNEX Jornada Experiment
JPL Jet Propulsion Laboratory

JPLAIRSAR JPL Airborne Synthetic Aperture Radar
JPO Joint Planning Office
JPOP Japanese Polar-Orbiting Platform

K

KINEROS Kinematic wave overland flow, channel routing and Erosion model
KORMEX Korean Monsoon Experiment

L

LAC Local Area Coverage
LAGEOS Laser Geodynamics Satellite
LAI Leaf-Area Index
Landsat Land Remote-Sensing Satellite
LaTIS Langley TRMM Information System
LBA Large Scale Biosphere-Atmosphere Experiment in Amazonia
LERTS Laboratoire d'Etudes et de Recherches en Teledetection Spatiale
LHH L-band HH
LIS Lightning Imaging Sensor
LITE Lidar In-space Technology Experiment
LLNL Lawrence Livermore National Laboratory
LOICZ Land Ocean Interactions in the Coastal Zone
LRC Langley Research Center
LRPT Low-Resolution Picture Transmissions
LS Lower Stratosphere
LSM Land-Surface Model
LSP Land-Surface Parameterization
ILTER Long-Term Ecological Research
LW longwave
LWP Liquid Water Path

M

MAAT Mean Annual Air Temperature
MAC Multi-sensor Air Campaign
MAPS Measurement of Air Pollution from Satellites
MBLA Multi-Beam Laser Altimeter
MCS Mesoscale Convective System
MERIS Medium-Resolution Imaging Spectrometer
METEOR-3 Russian Operational Weather Satellite
METOP Meteorological Operational Satellite
METRI Meteorological Research Institute (Korea)

MHS Microwave Humidity Sounder
MIMR Multifrequency Imaging Microwave Radiometer
MISR Multi-angle Imaging Spectroradiometer
MIT Massachusetts Institute of Technology
MITI Ministry of International Trade and Industry (Japan)
MLS Microwave Limb Sounder
MM mesoscale model
MMIC Microwave Monolithic Integrated Circuit
MMS Modular Modeling System
MODIS Moderate-Resolution Imaging Spectroradiometer
MODLAND MODIS Land
MOPITT Measurements of Pollution in the Troposphere
MOU Memorandum of Understanding
MOZART Model for Ozone And Related chemical Tracers
MSFC Marshall Space Flight Center
MSG Meteosat Second Generation
MSS Multispectral Scanner
MSU Microwave Sounding Unit
MT Megaton
MVI MODIS Vegetation Index

N

NAD Nitric Acid Dihydrate
NADW North Atlantic Deep Water
NAO North Atlantic Oscillation
NARSTO North American Research Strategy for Tropospheric Ozone
NASA National Aeronautics and Space Administration
NASDA National Space Development Agency (Japan)
NAT Nitric Acid Trihydrate
NBIOME Northern Biosphere Observation and Modeling Experiment
NCAR National Center for Atmospheric Research
NCDC National Climatic Data Center
NCEP National Centers for Environmental Prediction
NDVI Normalized Difference Vegetation Index
NESDIS National Environmental Satellite, Data, and Information Service
NEXRAD Next Generation Weather Radar
NH Northern Hemisphere
NIMA National Imagery and Mapping Agency
NIR Near Infrared
NISN NASA Integrated Services Network

NIST National Institute of Standards and Technology
NMC National Meteorological Center
NMHC Non-Methane Hydrocarbons
NMP New Millennium Program
NOAA National Oceanic and Atmospheric Administration
NOPEX Northern Hemisphere Climate-Processes Land-Surface Experiment
NO_x odd nitrogen family
NPOESS National Polar-orbiting Operational Environmental Satellite System
NPP Net Primary Production
NRA NASA Research Announcement
NRC National Research Council
NREN NASA Research and Education Network
NSCAT NASA Scatterometer
NSF National Science Foundation
NSIDC National Snow and Ice Data Center
NSTC National Science and Technology Council
NWP Numerical Weather Prediction

O

OCS Carbonyl Sulfide
OCMIP Ocean Carbon-cycle Model Intercomparison Project
OCTS Ocean Color and Temperature Scanner
ODT Ocean Color and
OES Office of Earth Science
OH Hydroxyl radical
OLR Outgoing Longwave Radiation
OMI Ozone Monitoring Instrument
OMPS Ozone Mapper and Profiler Suite
ONR Office of Naval Research
ORNL Oak Ridge National Laboratory
OSU Oregon State University
OTD Optical Transient Detector
OTTER Oregon Transect Terrestrial Ecosystem Research

P

PABSI Profiling A-Band Spectrometer/Visible Imager
PACS Pan American Climate Studies
PAR Photosynthetically-Active Radiation
PARC Public Access Resource Center
PARCA Program for Arctic Regional Climate Assessment

PDF portable document format
PEM Production Efficiency Model
PI Principal Investigator
PICASSO Pathfinder Instruments for Cloud and Aerosol Spaceborne Observations
PIK Potsdam Institute for Climate Impact Research
PILPS Project for Intercomparison of Land-Surface Parameterization (LSP) Schemes
PNNL Pacific Northwest National Laboratory
PNZ Phytoplankton-nutrient-zooplankton
POLDER Polarization and Directionality of the Earth's Reflectance
POLES Polar Exchange at the Sea Surface (IDS)
ppm parts per million
PR Precipitation Radar
PSC Polar Stratospheric Cloud
PSU Pennsylvania State University
PW precipitable water
PWV precipitable water vapor

Q

QBO Quasi-Biennial Oscillation

R

RACMO Regional Atmospheric Climate Model
Radarsat Radar Satellite, Canada
RAMS Regional Atmospheric Modeling System
RC radiative-convective
RCSM Regional Climate System Model
REP Relativistic Electron Precipitation
RGPS Radarsat Geophysical Processor System

S

S.D. Standard Deviation
SAA Satellite Active Archive
SADCO South African Data Center for Oceanography
SAFARI South African Fire-Atmospheric Research Initiative
SAGE Stratospheric Aerosol and Gas Experiment
SALSA Semi-Arid Land-Surface-Atmosphere
SAM Stratospheric Aerosol Measurement
SAR Synthetic Aperture Radar
SAS-C Scientific Applications Satellite-C

SAVI Soil-Adjusted Vegetation Index
SBIR Small Business and Innovative Research
SBUV Solar Backscatter Ultraviolet
SCA Snow-Covered Area
SCANSAR Scanning Synthetic Aperture Radar
SCAR-B Smoke, Cloud, and Radiation-Brazil
SCARAB Scanner for Radiation Budget
SCF Scientific Computing Facility
SCICEX Submarine Arctic Science Cruise (Program)
SCISSAP Southern Center for the Integrated Study of Secondary Air Pollutants
SCIGN Southern California Integrated GPS Network
SCOPE Scientific Committee on Problems of the Environment
SDPS Science Data Processing Segment
SeaWIFS Sea-viewing Wide Field-of-view Sensor
SEBAL Surface Energy Balance
SEDAC Socioeconomic Data and Applications Center
SESAME Second European Stratospheric Arctic and Mid-Latitude Experiment
SGP Southern Great Plains
SHEBA Surface Heat Budget of the Arctic Ocean
SI Systeme Internationale
SIB Simple Biosphere Model
SIM Spectral Irradiance Monitor
SIMBIOS Sensor Intercomparison and Merger for Biological and Interdisciplinary Oceanic Studies
SIMIP Sea Ice Model Intercomparison Project
SIPS Science Investigator-led Processing System
SIR-C Shuttle Imaging Radar-C
SITUPS Spatial Integrity Thresholding of Urban Polygons
SLA Shuttle Laser Altimeter
SLR Satellite Laser Ranging
SMM Solar Maximum Mission
SMMR Scanning Multispectral Microwave Radiometer
SMVGEAR Sparse-Matrix Vectorized Gear Code
SOCC Satellite Operations Control Center
SOHO Solar Heliospheric Observatory
SOLAS Surface Ocean Lower Atmosphere Study
SOLSTICE Solar Stellar Irradiance Comparison Experiment
SOS Southern Oxidants Study
SPCZ South Pacific Convergence Zone
SPE Solar Particle Event
SPOT Systeme pour l'Observation de la Terre
SRB Surface Radiation Budget
SRBEX Susquehanna River Basin Experiment
SRTM Shuttle Radar Topography Mission

SSALT Solid State radar Altimeter
SSBUV Shuttle Solar Backscatter Ultraviolet
SSM/I Special Sensor Microwave/Imager
SST Sea-Surface Temperature
SSU Stratospheric Sounding Unit
STP Standard Temperature and Pressure
STS Space Transport System
SVAT Soil-Vegetation-Atmosphere Transfer Model
SVI Spectral Vegetation Indices
SW shortwave
SWAP SouthWest Asia Project
SWE Snow Water Equivalent
SWG Science Working Group
SWIR Shortwave Infrared

T

T-S temperature-salinity
TAO TOGA Atmosphere-Ocean
TARFOX Tropospheric Aerosol Radiative Forcing Observational Experiment
TEM Terrestrial Ecosystem Model
TES Tropospheric Emission Spectrometer
THESEO Third European Stratospheric Experiment on Ozone
THM Terrestrial Hydrology Model
TILDAS tunable infrared laser differential absorption spectrometer
TIM Total Irradiance Monitor
TIR Thermal Infrared
TIROS Television and Infrared Observation Satellite
TM Thematic Mapper
TMI TRMM Microwave Imager
TMR TOPEX Microwave Radiometer
TOA Top Of the Atmosphere
TOGA Tropical Ocean Global Atmosphere
TOMS Total Ozone Mapping Spectrometer
TOP Terrestrial Observation Panel
TOPEX/Poseidon Ocean Topography Experiment
TOPORAD (model)
TOPSAR Topographic Synthetic Aperture Radar
TOVS TIROS Operational Vertical Sounder
TRACE-A Transport and Chemistry near the Equator over the Atlantic
TRAGNET United States Trace Gas Network
TRCN Teacher Resource Center Network
TRMM Tropical Rainfall Measuring Mission
TSI Total Solar Irradiance

TSS TRMM Support System
TT&C Tracking, Telemetry & Commanding
TZD total zenith delay

U

UAM Urban Airshed Model
UARP Upper Atmosphere Research Program
UARS Upper Atmosphere Research Satellite
UKMO United Kingdom Meteorological Office
UMAC Upper Midwest Aerospace Consortium
UMCP University of Maryland, College Park
UNEP United Nations Environment Program
UNESCO United Nations Educational, Scientific, and Cultural Organization
USAF United States Air Force
USDA United States Department of Agriculture
USGCRP U.S. Global Change Research Program
USGS United States Geological Survey
USRA University Space Research Association
UT Upper Troposphere
UV Ultraviolet
UV-B Ultraviolet-B

V

VCL Vegetation Canopy Lidar
VEMAP Vegetation/Ecosystem Modeling and Analysis Project
VHRR Very High Resolution Radiometer
VI Vegetation Index
VIC Variable Infiltration Capacity
VIIRS Visible and Infrared Imaging Radiometer Suite
VIRGO Variability of solar Irradiance and Gravity Oscillations
VIRS Visible Infrared Scanner
VIS Visible
VNIR Visible and Near Infrared
VOC Volatile Organic Carbon

W

WCRP World Climate Research Program
WDC-A World Data Center-A
WFC visible Wide-Field Camera

WFPS Water-Filled Pore Space
WMO World Meteorological Organization
WOCE World Ocean Circulation Experiment
WSMC Western Space and Missile Center
WSR Weather Surveillance Radar
WVR Water Vapor Radiometer

X

X-SAR X-Band Synthetic Aperture Radar
XBT Expendable BathyThermograph
XPS XUV Photometer System

Z

ZWD Zenith Wet Delay

Appendix

ATMOSPHERE	Cloud Properties <i>(amount, optical properties, height)</i>	MODIS, GLAS, AMSR-E, MISR, AIRS, ASTER, EOSP, SAGE III
	Radiative Energy Fluxes <i>(top of atmosphere, surface)</i>	CERES, ACRIM III, TIM, MODIS, AMSR-E, GLAS, MISR, AIRS, ASTER, SAGE III
	Precipitation	AMSR-E
	Tropospheric Chemistry <i>(ozone, precursor gases)</i>	TES, MOPITT, SAGE III, MLS, HIRDLS, LIS
	Stratospheric Chemistry <i>(ozone, ClO, BrO, OH, trace gases)</i>	MLS, HIRDLS, SAGE III, OMI, TES
	Aerosol Properties <i>(stratospheric, tropospheric)</i>	SAGE III, HIRDLS, MODIS, MISR, EOSP, OMI, GLAS
	Atmospheric Temperature	AIRS/AMSU-A, MLS, HIRDLS, TES, MODIS
	Atmospheric Humidity	AIRS/AMSU-A/HSB, MLS, SAGE III, HIRDLS, Poseidon 2/JMR, MODIS, TES
Lightning <i>(events, area, flash structure)</i>	LIS	
SCALAR RADIATION	Total Solar Irradiance	ACRIM III, TIM
	Ultraviolet Spectral Irradiance	SOLSTICE
LAND	Land Cover & Land Use Change	ETM+, MODIS, ASTER, MISR
	Vegetation Dynamics	MODIS, MISR, ETM+, ASTER
	Surface Temperature	ASTER, MODIS, AIRS, ETM+
	Fire Occurrence <i>(extent, thermal anomalies)</i>	MODIS, ASTER, ETM+
	Volcanic Effects <i>(frequency of occurrence, thermal anomalies, impact)</i>	MODIS, ASTER, ETM+, MISR
	Surface Wetness	AMSR-E
OCEAN	Surface Temperature	MODIS, AIRS, AMSR-E
	Phytoplankton & Dissolved Organic Matter	MODIS
	Surface Wind Fields	SeaWinds, AMSR-E, Poseidon 2/JMR
	Ocean Surface Topography <i>(height, waves, sea level)</i>	Poseidon 2/JMR
CRYOSPHERE	Land Ice <i>(ice sheet topography, ice sheet volume change, glacier change)</i>	GLAS, ASTER, ETM+
	Sea Ice <i>(extent, concentration, motion, temperature)</i>	AMSR-E, Poseidon 2/JMR, MODIS, ETM+, ASTER
	Snow Cover <i>(extent, water equivalent)</i>	MODIS, AMSR-E, ASTER, ETM+

24 EOS Measurements in support of the U.S. Global Change Research Program (USGCRP). The chart above shows the key physical variables needed to advance understanding of the entire Earth system and the interactions among the components. The EOS instruments listed in bold font are primary sensors, bold italics represent secondary instruments, and roman fonts are contributing instruments for critical measurements.