

NASA/TM—1999-209282



# SAMS Acceleration Measurements on Mir from May 1997 to June 1998 (NASA Increments 5, 6, and 7)

Richard DeLombard  
Glenn Research Center, Cleveland, Ohio

## The NASA STI Program Office . . . in Profile

Since its founding, NASA has been dedicated to the advancement of aeronautics and space science. The NASA Scientific and Technical Information (STI) Program Office plays a key part in helping NASA maintain this important role.

The NASA STI Program Office is operated by Langley Research Center, the Lead Center for NASA's scientific and technical information. The NASA STI Program Office provides access to the NASA STI Database, the largest collection of aeronautical and space science STI in the world. The Program Office is also NASA's institutional mechanism for disseminating the results of its research and development activities. These results are published by NASA in the NASA STI Report Series, which includes the following report types:

- **TECHNICAL PUBLICATION.** Reports of completed research or a major significant phase of research that present the results of NASA programs and include extensive data or theoretical analysis. Includes compilations of significant scientific and technical data and information deemed to be of continuing reference value. NASA's counterpart of peer-reviewed formal professional papers but has less stringent limitations on manuscript length and extent of graphic presentations.
- **TECHNICAL MEMORANDUM.** Scientific and technical findings that are preliminary or of specialized interest, e.g., quick release reports, working papers, and bibliographies that contain minimal annotation. Does not contain extensive analysis.
- **CONTRACTOR REPORT.** Scientific and technical findings by NASA-sponsored contractors and grantees.

- **CONFERENCE PUBLICATION.** Collected papers from scientific and technical conferences, symposia, seminars, or other meetings sponsored or cosponsored by NASA.
- **SPECIAL PUBLICATION.** Scientific, technical, or historical information from NASA programs, projects, and missions, often concerned with subjects having substantial public interest.
- **TECHNICAL TRANSLATION.** English-language translations of foreign scientific and technical material pertinent to NASA's mission.

Specialized services that complement the STI Program Office's diverse offerings include creating custom thesauri, building customized data bases, organizing and publishing research results . . . even providing videos.

For more information about the NASA STI Program Office, see the following:

- Access the NASA STI Program Home Page at <http://www.sti.nasa.gov>
- E-mail your question via the Internet to [help@sti.nasa.gov](mailto:help@sti.nasa.gov)
- Fax your question to the NASA Access Help Desk at (301) 621-0134
- Telephone the NASA Access Help Desk at (301) 621-0390
- Write to:  
NASA Access Help Desk  
NASA Center for Aerospace Information  
7121 Standard Drive  
Hanover, MD 21076

NASA/TM—1999-209282



# SAMS Acceleration Measurements on Mir from May 1997 to June 1998 (NASA Increments 5, 6, and 7)

Richard DeLombard  
Glenn Research Center, Cleveland, Ohio

National Aeronautics and  
Space Administration

Glenn Research Center

---

August 1999

This report contains preliminary findings, subject to revision as analysis proceeds.

Available from

NASA Center for Aerospace Information  
7121 Standard Drive  
Hanover, MD 21076  
Price Code: A03

National Technical Information Service  
5285 Port Royal Road  
Springfield, VA 22100  
Price Code: A03

**SAMS Acceleration Measurements on Mir from May 1997 to  
June 1998 (NASA Increments 5, 6, and 7)**

June 18, 1999

Richard DeLombard  
NASA Glenn Research Center  
Cleveland, Ohio

## **Abstract**

During NASA Increments 5, 6, and 7 (May 1997 to June 1998), about eight gigabytes of acceleration data were collected by the Space Acceleration Measurement System (SAMS) onboard the Russian Space Station Mir. The data were recorded on twenty-seven optical disks which were returned to Earth on Orbiter missions STS-86, STS-89, and STS-91. During these increments, SAMS data were collected in the Priroda module to support various microgravity experiments. This report points out some of the salient features of the microgravity acceleration environment to which the experiments were exposed. This report presents an overview of the SAMS acceleration measurements recorded by 10 Hz and 100 Hz sensor heads. The analyses included herein complement those presented in previous Mir increment summary reports prepared by the Principal Investigator Microgravity Services project.

### Acronyms and Abbreviations

DMT	Decreed Moscow Time (year/day/hour:minute:second)
$f_c$	cutoff frequency (Hertz)
$f_s$	sampling rate (samples per second)
ftp	file transfer protocol
$g$	acceleration level referenced to $g_o$
$g_o$	acceleration due to Earth's gravity (9.81 m/s <sup>2</sup> )
GRC	NASA John H. Glenn Research Center
Hz	Hertz
$\mu g$	microgravity (1/1,000,000 of $g_o$ )
MIM	Microgravity Isolation Mount
MiPS	Mir Payload Support
MiSDE	Mir Structural Dynamics Experiment
PDF	portable document format
PIMS	Principal Investigator Microgravity Services
PSD	power spectral density
QUELD	Queen's University Experiments in Liquid Diffusion
RMS	root-mean-square
SAMS	Space Acceleration Measurement System
STS	Space Transportation System
TSH	triaxial sensor head
URL	uniform resource locator
WWW	World Wide Web
$X_h, Y_h, Z_h$	X-, Y-, Z-Axis coordinate system for unspecified SAMS sensor head
$X_{h,A}, Y_{h,A}, Z_{h,A}$	X-, Y-, Z-Axis coordinate system for SAMS TSH A
$X_{h,B}, Y_{h,B}, Z_{h,B}$	X-, Y-, Z-Axis coordinate system for SAMS TSH B
$X_B, Y_B, Z_B$	X-, Y-, Z-Axis coordinate system for Mir Base Block

**Table of Contents**

Abstract.....	i
Acronyms and Abbreviations .....	ii
Table of Contents .....	iii
Lists of Tables/Figures .....	iv
1. Introduction .....	1
2. Data Acquisition and Processing .....	1
3. Mir Space Station .....	2
3.1 Mir Configuration .....	2
3.2 Mir Coordinate Systems .....	2
4. SAMS Triaxial Sensor Head Location .....	3
5. Facilities Supported .....	3
5.1 Microgravity Glovebox .....	3
5.2 Microgravity Isolation Mount (MIM) .....	3
5.3 Biotechnology System Facility Operations .....	3
6. Experiments Supported.....	3
6.1 Advanced Protein Crystallization Facility .....	3
6.2 Diffusion Controlled Apparatus Module .....	3
6.3 Biotechnology of 3-D Tissue Engineering .....	3
6.4 Biotechnology System Coculture .....	4
6.5 Canadian Protein Crystallization Experiment .....	4
6.6 Cartilage in Space .....	4
6.7 Colloidal Gelation.....	4
6.8 Interferometric Study of Protein Crystal Growth .....	4
6.9 Liquid Metal Diffusion Experiment .....	4
6.10 Opposed Flame Flow Spread on Cylindrical Surfaces .....	4
6.11 Protein Crystal Growth in Dewar .....	4
6.12 Queen's University Experiments in Liquid Diffusion (QUELD) .....	4
6.13 Single Locker Thermal Enclosure System for Protein Crystal Growth .....	5
6.14 Mir Structural Dynamics Experiment (MiSDE).....	5
7. Data Analysis Techniques .....	5
8. Microgravity Environment .....	6
8.1 Orbiter Docking and Undocking with Mir .....	6
8.2 Soyuz and Progress Docking and Undocking with Mir .....	6
8.3 Characterization of MIM and QUELD .....	6
9. Summary .....	7
10. References .....	7
Appendix A: SAMS Cutoff-Frequency Color Spectrograms TSH A (100 Hz).....	A-1
Appendix B: SAMS Cutoff-Frequency Color Spectrograms TSH B (10 Hz).....	B-1
Appendix C: SAMS Nyquist-Frequency Color Spectrograms TSH A (250 Hz) .....	C-1
Appendix D: SAMS Nyquist-Frequency Color Spectrograms TSH B (25 Hz) .....	D-1
Appendix E: User Comment Sheet.....	E-1
Appendix F: Accessing Acceleration Data via the Internet .....	F-1



**List of Tables**

Table 1. Comparison of Orbiter docking and undocking time sources ..... 9  
 Table 2. Tabular representation of Mir module orientations ..... 9  
 Table 3. Active microgravity experiments during NASA Increments 5, 6, and 7 ..... 10  
 Table 4. MIM/QUELD Characterization Test Conducted on Mir ..... 11

**List of Figures**

Figure 1. Mir activities and SAMS recording times during 1997 ..... 12  
 Figure 2. Mir activities and SAMS recording times during 1998 ..... 13  
 Figure 3. Typical Mir crew daily activities ..... 13  
 Figure 4. Mir core module coordinate system and module orientation ..... 14  
 Figure 5. Mir coordinate systems ..... 15  
 Figure 6. MIM characterization test (first hour) ..... 16  
 Figure 7. MIM characterization test (second hour) ..... 17  
 Figure 8. MIM characterization test (third hour) ..... 18  
 Figure 9. MIM characterization test (fourth hour) ..... 19  
 Figure 10. Power spectral density plot before MIM operations ..... 20  
 Figure 11. Power spectral density plot during MIM operations ..... 21

## 1. Introduction

The NASA Headquarters Microgravity Research Division sponsors microgravity science experiments on several carriers, which include the NASA Shuttle Orbiters and the Mir Space Station. The Microgravity Research Division sponsors the Space Acceleration Measurement System (SAMS) at the NASA Glenn Research Center (GRC) to support microgravity experiments with acceleration measurements. The GRC Principal Investigator Microgravity Services (PIMS) project supplies principal investigators of microgravity science experiments and other experiment personnel with analysis of acceleration data to support the evaluation of the effects of microgravity on their experiments. PIMS also provides information about on-orbit events such as equipment operation to assist in the scheduling of microgravity science experiment operations.

In 1994, a SAMS unit [1] was installed on the Mir Space Station [2] to support U.S. and Russian microgravity experiments by measuring the microgravity environment during experiment operations. Previous reports [3-9] by PIMS have summarized and evaluated the SAMS data acquired during the period from September 1994 to May 1997. This report summarizes the SAMS data during NASA Increment 5 (May to October 1997), Increment 6 (October 1997 to January 1998), and Increment 7 (January to June 1998).

Data were recorded to support experiment and to characterize microgravity environment. The events described in this report include the characterization of disturbances due to the MIM facility and the QUELD furnace.

Appendices A and B contain cutoff-frequency spectrograms of the data from the two SAMS sensor heads; appendices C and D contain Nyquist-frequency spectrograms of the data from the two SAMS sensor heads. The data plots in appendices A through D are viewable from the attached CD-ROM. Appendix E contains a user comment sheet, which users are encouraged to complete and return to PIMS. Appendix F describes the procedures that users should follow to access SAMS data over the internet via anonymous file transfer protocol (ftp).

This entire report is also viewable from the attached CD-ROM and is available on the World Wide Web (WWW) in the portable document format (PDF). Adobe Acrobat Reader® version 3.0 or higher will be necessary to open and/or print these files. A current version of Adobe Acrobat Reader® is included on the CD-ROM.

## 2. Data Acquisition and Processing

As noted in previous reports [3-9], the SAMS unit on Mir is connected to two triaxial sensor heads (TSHs). TSH A had a cutoff frequency of 100 Hz and a sampling rate of 500 samples per second. TSH B had a cutoff frequency of 10 Hz and a sampling rate of 50 samples per second. During increments 5, 6, and 7, the SAMS unit was turned on periodically to record microgravity accelerations in support of the various experiments and other significant events. SAMS data coverage for this time period is summarized in Figures 1 and 2. Figure 3 shows the normal daily activities on the Mir. The time used on Mir is Decreed Moscow Time (DMT).

The time assigned to the post-mission SAMS data is derived from several possible sources. The primary source is the time encoded in the data files by the SAMS unit when it had been properly synchronized with the Mir Payload Support (MiPS) equipment on-board Mir. Lacking proper synchronization, the time in the post-mission SAMS data was assigned based on the crew member's notations. In some cases the time is assigned after correlation with mission events such as vehicle docking. Differences in time have been found in some of the SAMS data files, so caution should be used for specific correlation of SAMS data to experiment operations and results. Table 1 summarizes the six Orbiter and seven Progress docking and undocking events during this time period. There were two Orbiter events for which there are major differences between the time as reported by NASA Johnson Space Center and that shown in the SAMS data. The reasons for these differences are not known at the present time. Problems with the synchronization with MiPS are suspected.

Five optical data disks were returned to Earth on STS-86 with six of the sides having valid data. Four disks were returned on STS-89 with five of the sides having valid data. Eighteen disks were returned on STS-91 with twenty-nine of the sides having valid data. The SAMS unit was also returned to Earth on STS-91 and is slated for transfer to the Smithsonian's National Air and Space Museum. These data were processed by the SAMS project at GRC and placed on a NASA GRC file server ([beech.grc.nasa.gov](http://beech.grc.nasa.gov)) to make them available to users. Appendix F of this report provides instructions for accessing these data files.

### 3. Mir Space Station

#### 3.1 Mir Configuration

The Mir has been in orbit since February 1986 and, in the years since, modules have been added until the Mir reached its present configuration of six modules. The Mir currently consists of the Base Block, Kvant, Kvant-2, Kristall, Spektr, and Priroda modules. It measures more than 32 meters in length with the docked Progress-M and the Soyuz-TM spacecraft and is about 27 meters in width across the modules. Figure 4 shows a typical configuration of the Mir Space Station with a docked NASA Orbiter during the time covered by this report.

#### 3.2 Mir Coordinate Systems

The Mir Space Station's basic coordinate system is that of the Base Block module coordinate system which is shown in Figure 4. Each of the modules of the Mir station has its own coordinate system, which is based upon its orientation with respect to the Mir Base Block module. Figure 5 shows a graphical representation of these coordinate systems for the nominal Mir configuration (consistent with that shown in Figure 4). Table 2 is a tabular representation of Figure 4.

The determination of the coordinate system is made by a simple procedure. If you "stand" in any module, such that your feet are on the floor, and you are facing towards the transitional node of the Base Block module, then the coordinate system of that module is defined by the right hand rule, such that the direction you are facing is +X module, the direction from your feet to your head is +Y module, and the direction from your left to right is +Z module.

#### **4. SAMS Triaxial Sensor Head Locations**

The TSHs were located in the Priroda module during NASA Increments 5, 6, and 7.

#### **5. Facilities Supported**

Additional information on these facilities may be obtained from [10].

##### **5.1 Microgravity Glovebox**

The glovebox facility was used to conduct experiments associated with combustion experiments and hazardous operations which need to be isolated from the Mir living environment.

##### **5.2 Microgravity Isolation Mount (MIM)**

The MIM was used to isolate some experiments from the vibrations and accelerations of the Mir space station.

##### **5.3 Biotechnology System Facility Operations**

This facility was designed to house biotechnology experiments such as tissue culture and protein crystal growth.

#### **6. Experiments Supported**

The SAMS unit supported experiments listed in Table 3. Additional information on these experiments may be obtained from [10].

##### **6.1 Advanced Protein Crystallization Facility**

Investigators grew large well-ordered protein crystals for later characterization in ground laboratories.

##### **6.2 Diffusion Controlled Apparatus Module**

Scientists grew protein crystals in space and evaluated the dialysis and liquid/liquid diffusion methods of crystal growth.

### 6.3 Biochemistry of 3-D Tissue Engineering

Scientists characterized tissue biochemical properties as a result of three-dimensional tissue formation in microgravity.

### 6.4 Biotechnology System Coculture

This experiment studied the growth and maintenance of cell cultures and investigated the long-term effect of on-orbit cell growth for the purpose of tissue engineering.

### 6.5 Canadian Protein Crystallization Experiment

This experiment analyzed the crystalline structure of approximately thirty-two clinically important proteins in microgravity. Scientists will apply these analyses towards the enhancement of current methodologies used in the drug development and design process.

### 6.6 Cartilage in Space

Cartilage cells were grown in microgravity to facilitate the study of basic cell interactions devoid of sedimentation.

### 6.7 Colloidal Gelation

This experiment studied the limitations of the amount of polymer-induced aggregation in microgravity.

### 6.8 Interferometric Study of Protein Crystal Growth

Protein crystals were grown in microgravity to enable the study of solute concentration gradients in crystal solutions.

### 6.9 Liquid Metal Diffusion Experiment

This experiment studied diffusion coefficients in liquid metals. Scientists also attempted to prevent any void/bubble formation in liquid metal diffusion samples in microgravity. This experiment was conducted with the Liquid Metal Diffusion apparatus in the MIM facility.

### 6.10 Opposed Flame Flow Spread on Cylindrical Surfaces

This experiment studied how the microgravity environment affected the spread of flames in the presence of an opposing oxidizer.

### 6.11 Protein Crystal Growth in Dewar

Investigators studied protein crystal growth in microgravity and evaluated flash-frozen and liquid/ liquid diffusion methods.

### 6.12 Queen's University Experiments in Liquid Diffusion (QUELD)

This experiment collected data on diffusion coefficients in the melt of metal alloy systems devoid of gravitational effects. This experiment was conducted with the QUELD apparatus in the MIM facility.

### 6.13 Single Locker Thermal Enclosure System for Protein Crystal Growth

The experiment was to produce large, high-quality crystals of selected proteins under controlled temperature conditions in microgravity.

### 6.14 Mir Structural Dynamics Experiment (MiSDE)

Investigators used this experiment to obtain structural dynamic response data on the Mir and Mir/Orbiter in a mated configuration during normal operational events such as docking, Orbiter and Mir thruster jet firings, crew exercise, and other crew activities. A final report [11] has been written for MiSDE. Although this is not a microgravity science experiment, it utilized the SAMS acceleration data to supplement the MiSDE accelerometer data.

## 7. Data Analysis Techniques

SAMS data are generally presented and plotted in several forms for evaluation: acceleration versus time, interval average acceleration versus time, root-mean-square (RMS) average acceleration versus time, power spectral density (PSD) versus frequency, and spectrogram (PSD versus frequency versus time). The form used depends on what aspect of the data is of interest. These techniques are described in detail in [12].

Acceleration versus time plots are used to display the acceleration levels recorded by the SAMS sensor head. These plots can then be used by experiment personnel to correlate experiment results with the measured microgravity environment. This form of data display gives the most time-accurate representation of the microgravity environment.

A plot of the interval average acceleration in units of acceleration versus time gives an indication of net accelerations which last for a number of seconds equal to or greater than the interval parameter. Shorter duration, high amplitude accelerations can also be detected with this type of plot, however, the exact timing and magnitude of specific acceleration events cannot be extracted. A plot of the interval root-mean-square acceleration in units of acceleration versus time gives an indication of the time-averaged power in the signal due to oscillatory acceleration sources.

PSD calculations and plots are used to examine and display the frequency content of SAMS data during relatively short periods of time (on the order of seconds to minutes). Analysis times may be chosen based upon some specific event or experiment operation. For SAMS data, the PSD units are  $g^2/Hz$ . Spectrograms are 3-dimensional plots, but, as presented here, the third dimension is color, so all the data can be presented as a 2-dimensional image. Spectrograms can be used to evaluate how the microgravity environment varies in intensity with respect to both the time and frequency domains.

## 8. Microgravity Environment

Many features of the Mir microgravity environment have been described in previous reports [3-9] and will not be described again here.

### 8.1 Orbiter Docking and Undocking with Mir

Four Orbiter missions conducted docked operations with Mir during increments 5, 6, and 7. The dates and times [13] [14] of Orbiter docking and undocking activities are listed in Table 1.

### 8.2 Soyuz and Progress Docking and Undocking with Mir

There were several Soyuz and Progress vehicles docking to and undocking from Mir during this time interval. The dates and times [13, 14] of these vehicle docking activities which coincided with SAMS data acquisition periods are listed in Table 1.

### 8.3 Characterization of MIM and QUELD

Analysis of SAMS data from earlier increments led PIMS to the conclusion that the MIM and/or QUELD were causing a noticeable disturbance to the microgravity environment. A test of MIM and QUELD operations was developed by PIMS to investigate possible disturbances to the environment and was conducted on 13-14 May 1998. The sequence of steps taken on 13 May is summarized in Table 4. The tags listed in this table correspond to the tags in the data plots shown in Figures 6 - 9. The Canadian Space Agency [15] provided information which describes the significant actions during MIM and QUELD operations.

A correlation may be seen between the operation of certain equipment and the features in the SAMS data. In particular, the 84 Hz trace appears to be correlated with the MIM cooling fans; the 71 Hz trace appears to be correlated with the MIM hard disk rotation; and the multiple traces around 65 Hz appear to be correlated with fans on the QUELD apparatus. The characteristic pattern involving multiple frequencies from 60 to 100 Hz appears to be correlated with MIM data recording.

The effect of the general broad band noise from the MIM may be seen in the power spectral density plots of Figure 10 before MIM was active and Figure 11 during MIM operations. When the MIM is active, higher levels are seen above 55 Hz.

It should be noted that the timing of these activities was derived from Andy Thomas' logbook and were (for the most part) given in terms of minutes not seconds. This makes the accuracy of these times to be plus or minus a minute or two which results in the tags not being precisely aligned with the features in the data plots.

## 9. Summary

This report presents a summary of the SAMS data recorded on the Mir Space Station during NASA Increments 5, 6, and 7 from May 1997 to June 1998. During that time, the SAMS supported various microgravity science experiments. The general environment was similar to the environment of the previous increments. Data during the operation of the MIM and the QUELD were also analyzed to characterize the effects of that equipment on the microgravity environment.

## 10. References

References indicated with an asterisk may be found on the World Wide Web from the PIMS page at uniform resource location (URL):

<http://www.grc.nasa.gov/WWW/MMAP/PIMS/HTMLS/reportlist.html>

- [1] DeLombard, R. and Finley, B. D.: Space Acceleration Measurement System Description and Operation on the First Spacelab Life Sciences Mission. NASA TM-105301, 1991.
- [2] WWW page at URL:  
<http://www.hq.nasa.gov/osf/mir/mirguide.html>
- [3] \* DeLombard, R. and M. J. B. Rogers: Quick Look Report of Acceleration Measurements on Mir Space Station during Mir-16. NASA TM-106835, 1995.
- [4] DeLombard, R., S. B. Ryaboukha, M. Moskowitz, K. Hrovat: Further Analysis of the Microgravity Environment on Mir Space Station during Mir-16. NASA TM-107239, June 1996.
- [5] \* DeLombard, R., K. Hrovat, M. Moskowitz, and K. McPherson: SAMS Acceleration Measurements on Mir from June to November 1995. NASA TM-107312, September 1996.
- [6] DeLombard, R.: SAMS Acceleration Measurements on Mir from November 1995 to March 1996. NASA TM-107435, April 1997.
- [7] Truong, D., M. Moskowitz, K. Hrovat, and T. Reckart: SAMS Acceleration Measurements on Mir from March to September 1996. NASA TM-107524, August 1997.



**Table 1:** Comparison of Orbiter docking and undocking time sources.

	<b>JSC-WWW</b>	<b>POSA Reports</b>	<b>SAMS Data</b>	<b>DELTA</b>
<b>EVENT</b>	<b>DMT</b> (year/day/hour:mi n)	<b>DMT</b> (year/day/hour:mi n)	<b>DMT</b> (year/day/hour:min)	<b>WWW- SAMS</b> (hour:min)
STS-84 undocking	1997/142/04:04		1997/142/04:04	00:00
Progress M-34 Undocking		1997/175/13:20		
STS-86 docking	1997/270/22:58		1997/271/18:30	20:32
STS-86 undocking	1997/276/20:28		1997/276/20:28	00:00
Progress 235 Docking		1997/280/15:03		
Progress 237 Docking		1997/281/20:08		
STS-89 docking	1998/024/23:14		1998/024/23:14	00:00
STS-89 undocking	1998/029/19:57		1998/029/18:42	01:15
Progress 236 Undocking		1998/74/22:15		
Progress 240 Docking		1998/76/03:31		
Progress 240 Undocking		1998/135/21:44		
Progress 238 Docking		Not available	1998/137/02:55	
STS-91 docking	1998/155/19:58		1998/155/20:00	-00:02

**Table 2:** Tabular representation of Mir module orientations.

<b>Base</b>	<b>Kristall</b>	<b>Kvant</b>	<b>Kvant-2</b>	<b>Priroda</b>	<b>Spektr</b>
$+X_B$	$+Z_{\text{Kristall}}$	$-X_{\text{Kvant}}$	$+Y_{\text{Kvant-2}}$	$-Z_{\text{Priroda}}$	$-Y_{\text{Spektr}}$
$+Y_B$	$-Y$	$+Y$	$-X$	$-Y$	$+X$
$+Z_B$	$+X$	$-Z$	$+Z$	$-X$	$+Z$

**Table 3:** Active microgravity experiments during NASA Increments 5, 6, and 7.

<b>EXPERIMENT TITLE</b>	<b>INCREMENT</b>
Advanced Protein Crystallization Facility	7
Ambient Diffusion Controlled Protein Crystal Growth	5, 6
Biochemistry of 3-D Tissue Engineering	5
Biotechnology System Coculture	7
Biotechnology System Facility Operations	5
Canadian Protein Crystallization Experiment	6
Cartilage in Space	7
Colloidal Gelation	5
Interferometric Study of Protein Crystal Growth	6
Liquid Metal Diffusion Experiment	6
Microgravity Glovebox Facility Operations	5
Microgravity Isolation Mount Facility Operations Experiment	5, 6, 7
Mir Structural Dynamics Experiment	5, 6, 7
Opposed Flame Flow Spread on Cylindrical Surfaces	5
Protein Crystal Growth in Dewar	5, 6, 7
Queen's University Experiment in Liquid Diffusion	5, 6, 7
Single Locker Thermal Enclosure System for Protein Crystal Growth	6, 7

**Table 4:** MIM/QUELD Characterization Test Conducted on Mir.

<b>Figure Tag</b>	<b>Hour:Min(DMT)</b>	<b>Description</b>
First one hour spectrogram (Figure 6)		
A	15:23	MIM S3 & S4 ON
B	15:37	MIM S4 OFF
C	15:44	MIM S1 ON
D	15:49	MIM S2 ON
E	15:50	Data storing ON
F	15:53	MIM S3 ON, QUELD S1 ON
G	15:58	Data storing OFF
Second one hour spectrogram (Figure 7)		
H	16:26	Flotor unlatched
I	16:33	Data storing ON
J	16:36	QUELD RUN pressed
K	16:55	MIM S3 OFF
L	16:58	MIM S3 & S4 ON
Third one hour spectrogram (Figure 8)		
M	17:03	MIM S3 & S4 OFF
N	17:03	Data storing OFF
O	17:04	MIM S2 & S1 OFF
P	17:17	MIM S1 ON
Q	17:20	MIM S2 ON
R	17:28	Data storing ON
S	17:33	Data storing OFF
T	17:53	Data storing ON
Fourth one hour spectrogram (Figure 9)		
U	18:03	Data storing OFF
V	18:03	MIM S2 & S1 OFF
W	18:05	MIM S1 ON
X	18:08	MIM S2 ON
Y	18:09	Data storing ON
Z	18:11	Data storing ON
AA	18:16	Data storing OFF
AB	18:22	Data storing ON
AC	18:33	Data storing OFF

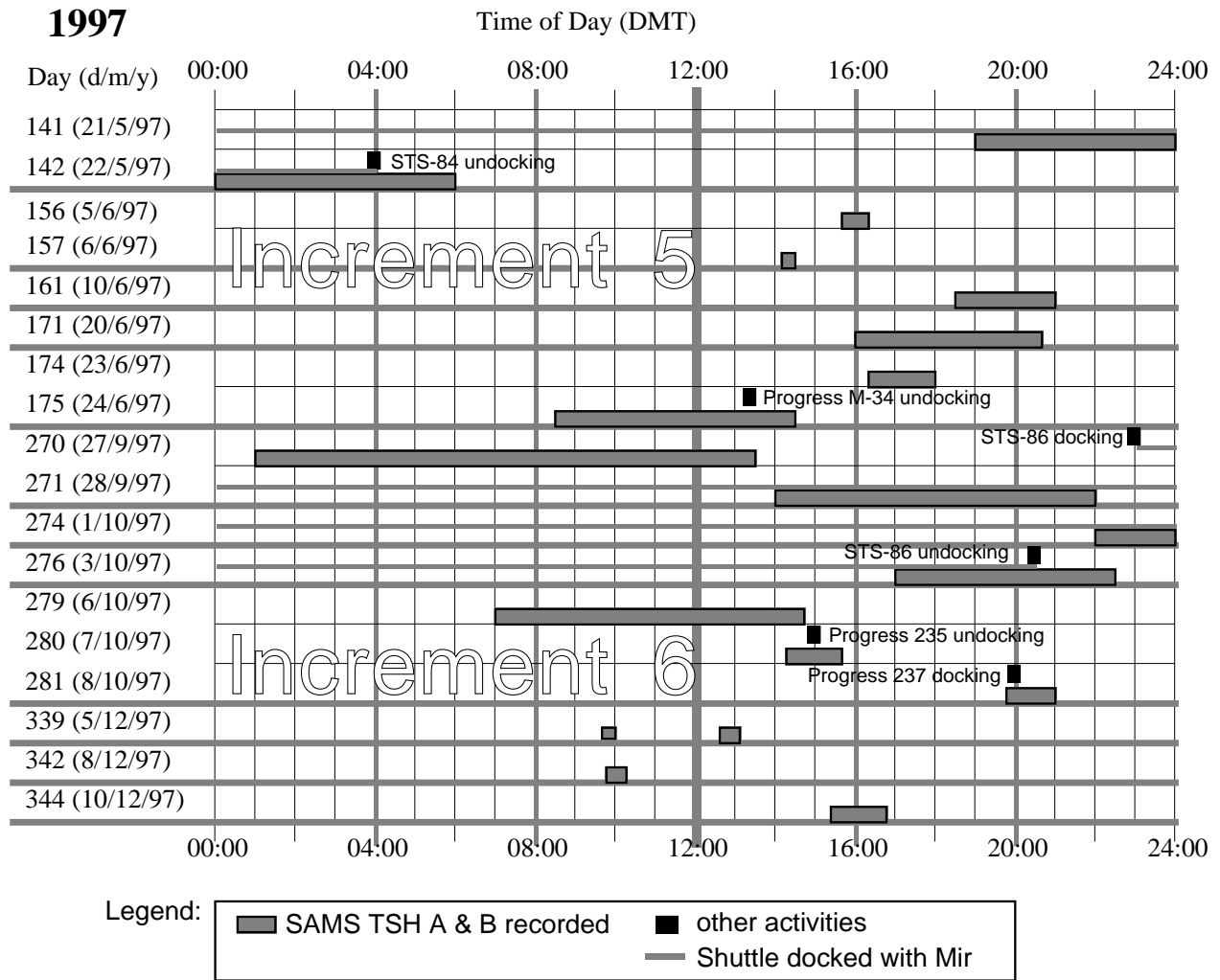

Figure 1. Mir activities and SAMS recording times during 1997.

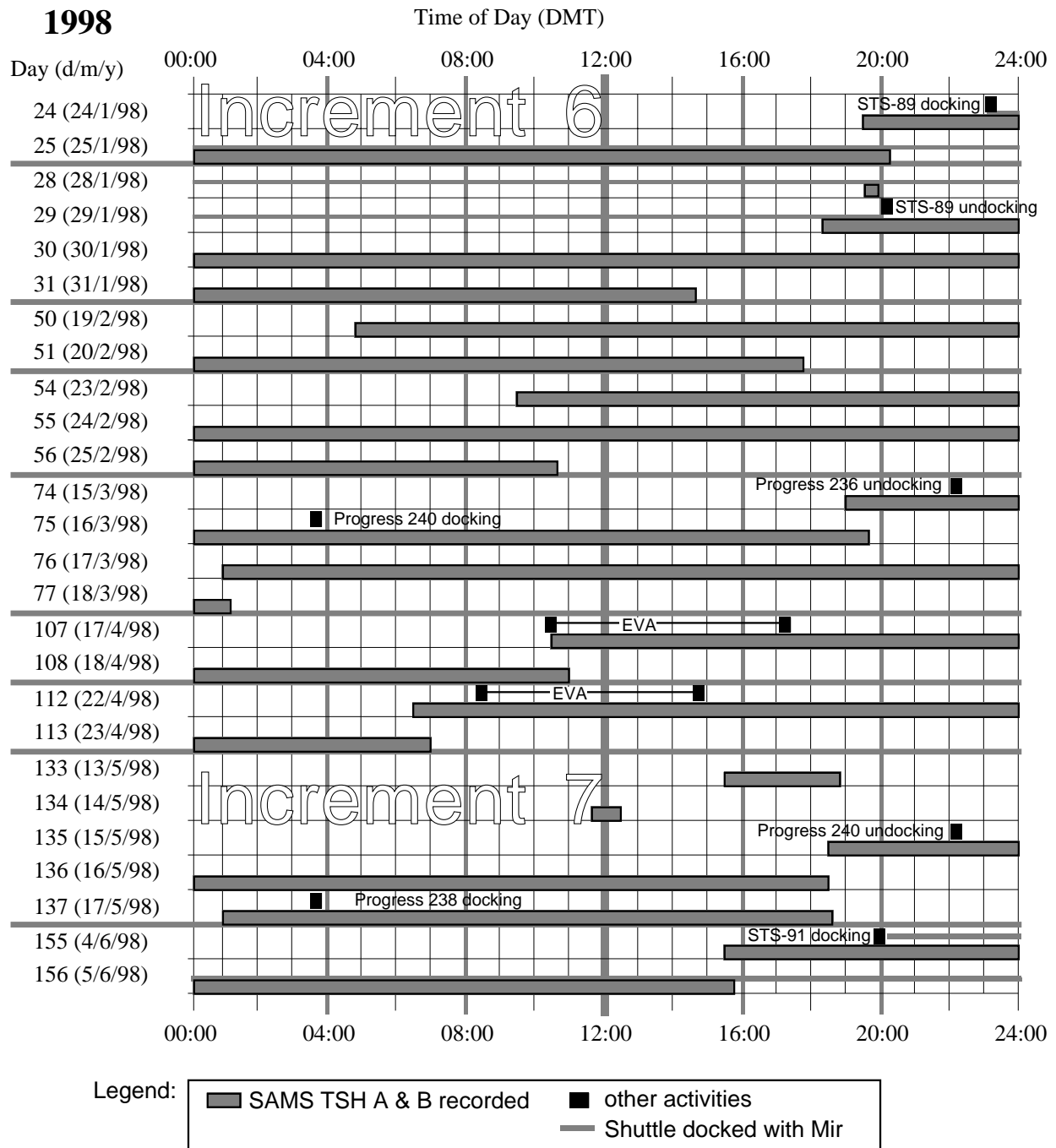

Figure 2. Mir activities and SAMS recording times during 1998.

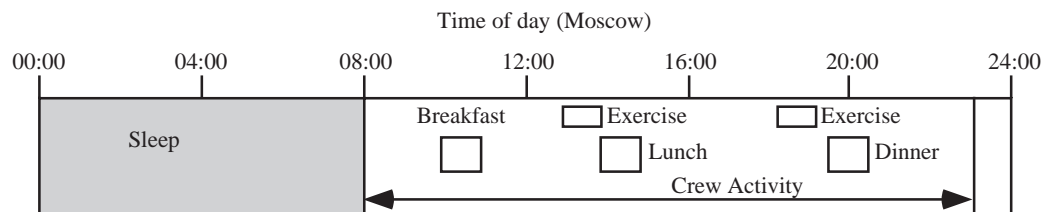
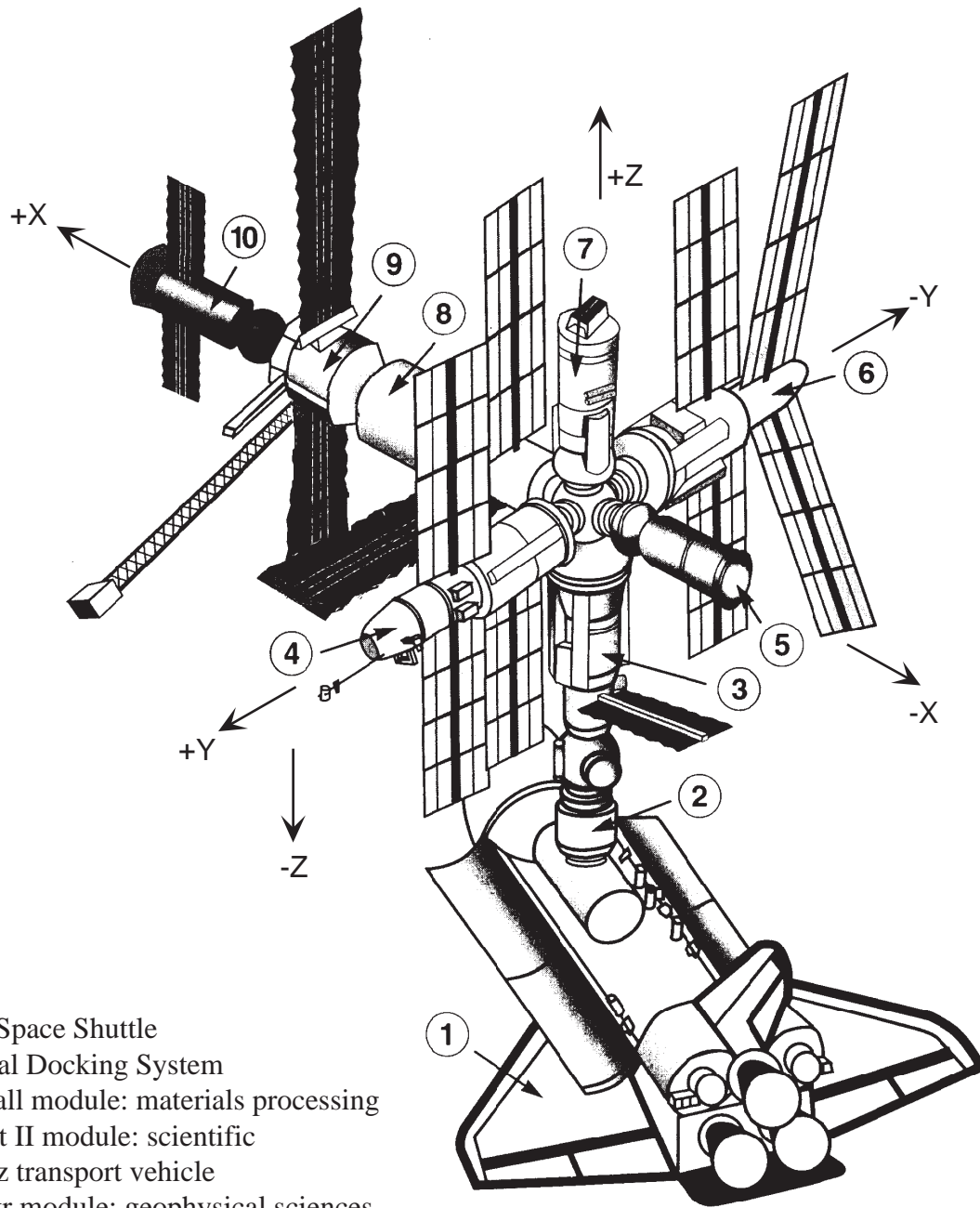

Figure 3. Typical Mir crew daily activities.



- 1) U.S. Space Shuttle
- 2) Orbital Docking System
- 3) Kristall module: materials processing
- 4) Kvant II module: scientific
- 5) Soyuz transport vehicle
- 6) Spektr module: geophysical sciences
- 7) Priroda Module: Earth remote sensing
- 8) Core module: habitation, power, life support
- 9) Kvant module: astrophysics
- 10) Progress vehicle

**Figure 4.** Mir core module coordinate system and module orientation.

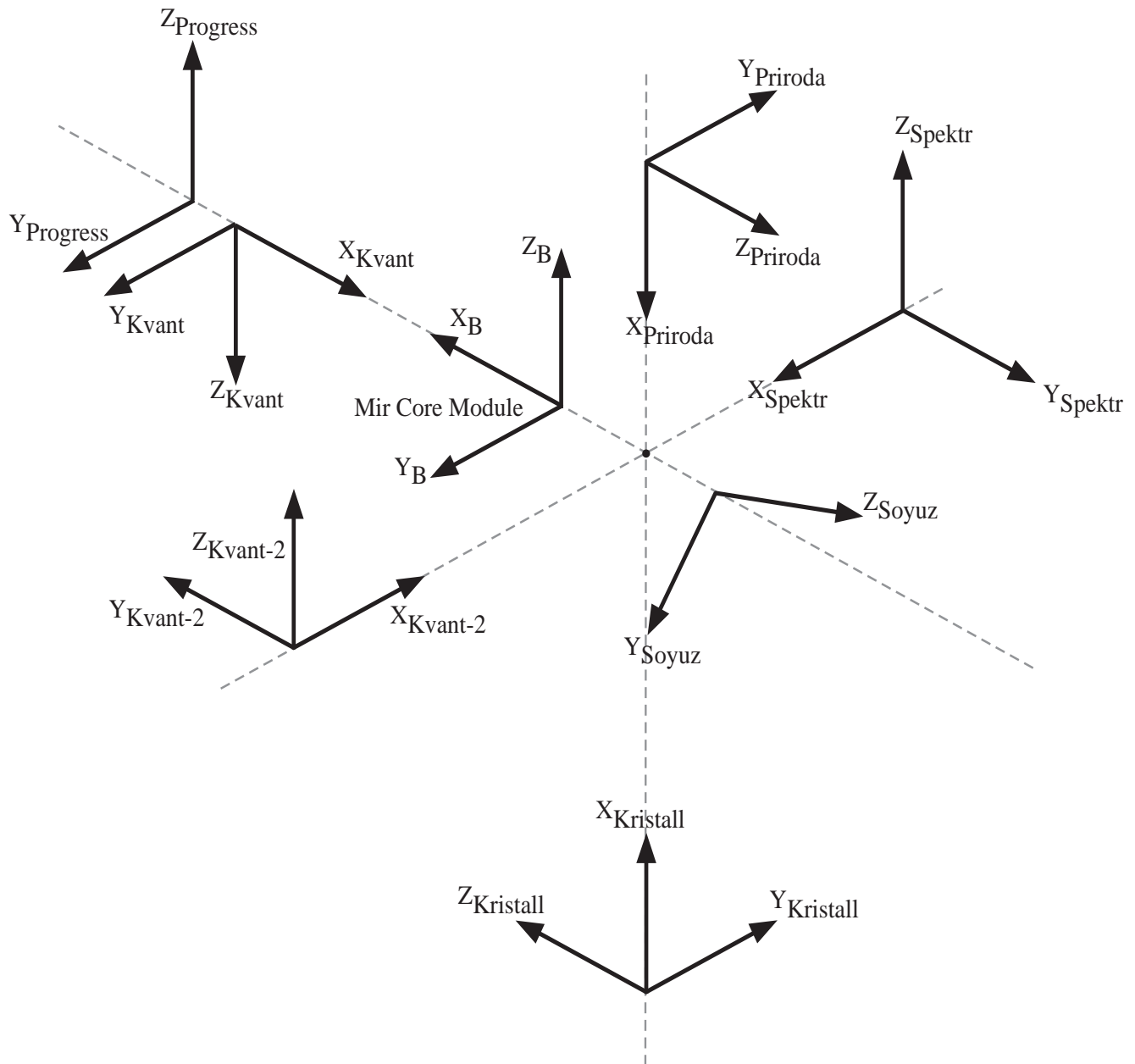

Figure 5. Mir coordinate systems.

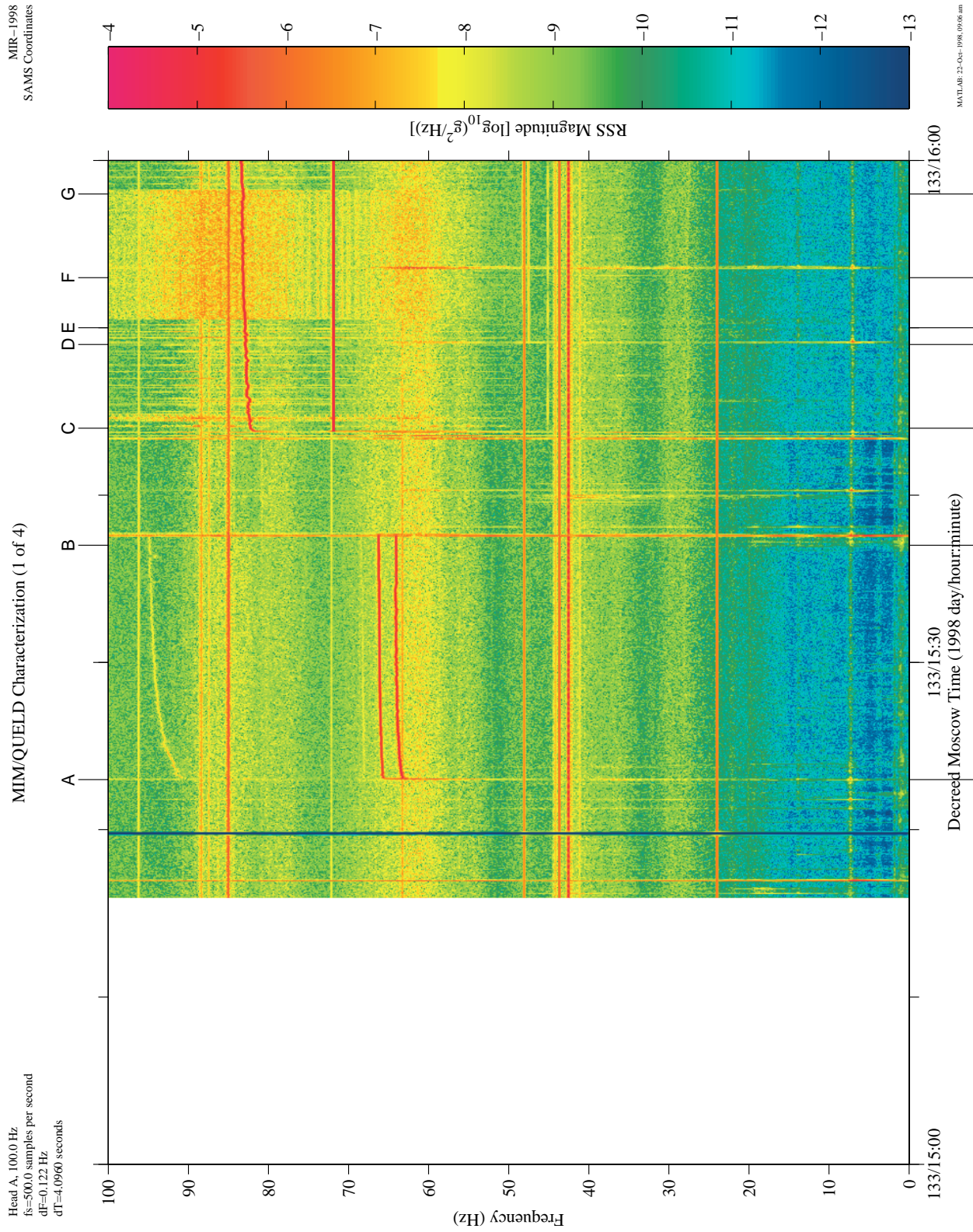

Figure 6. MIM characterization test (first hour).



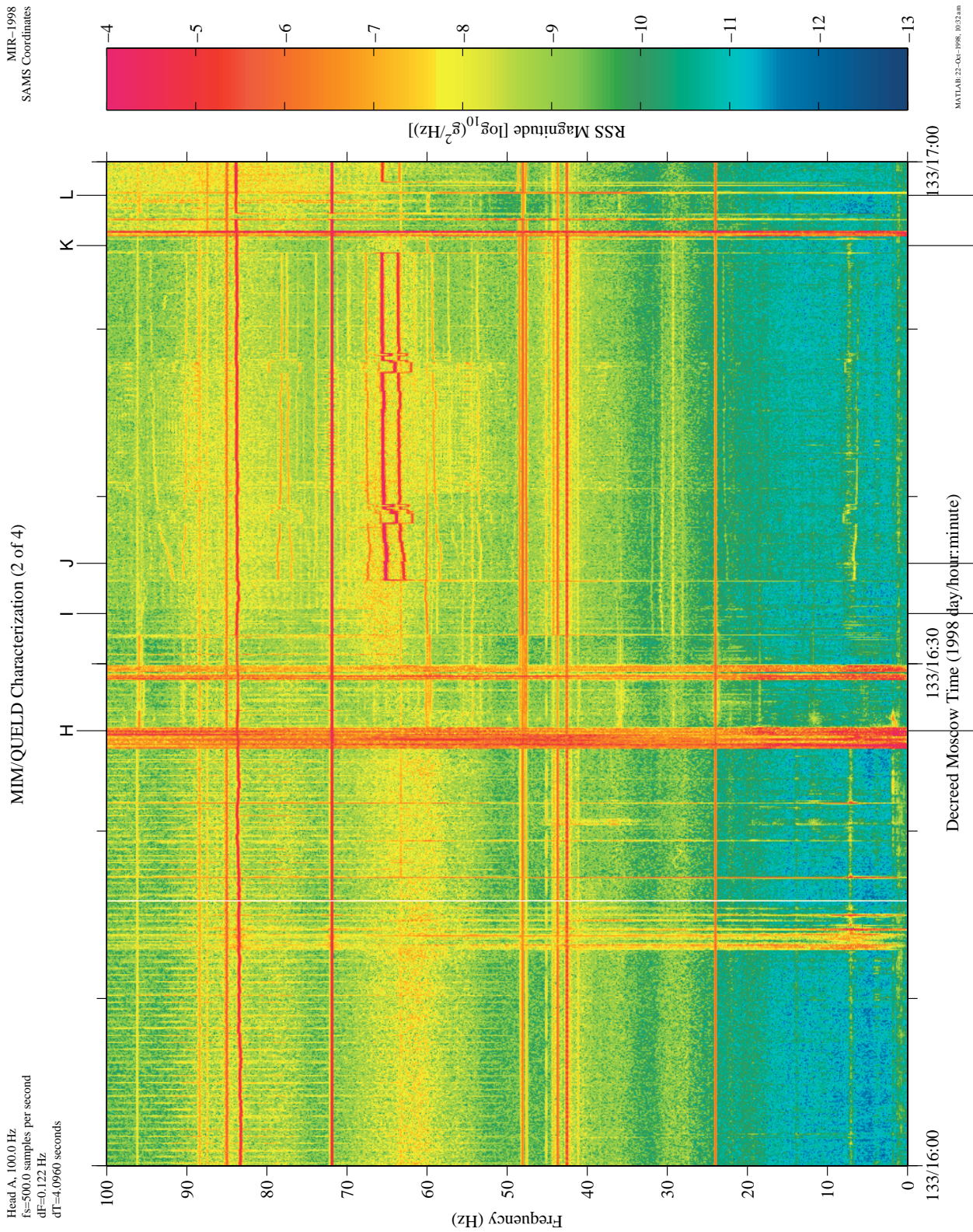

Figure 7. MIM characterization test (second hour).

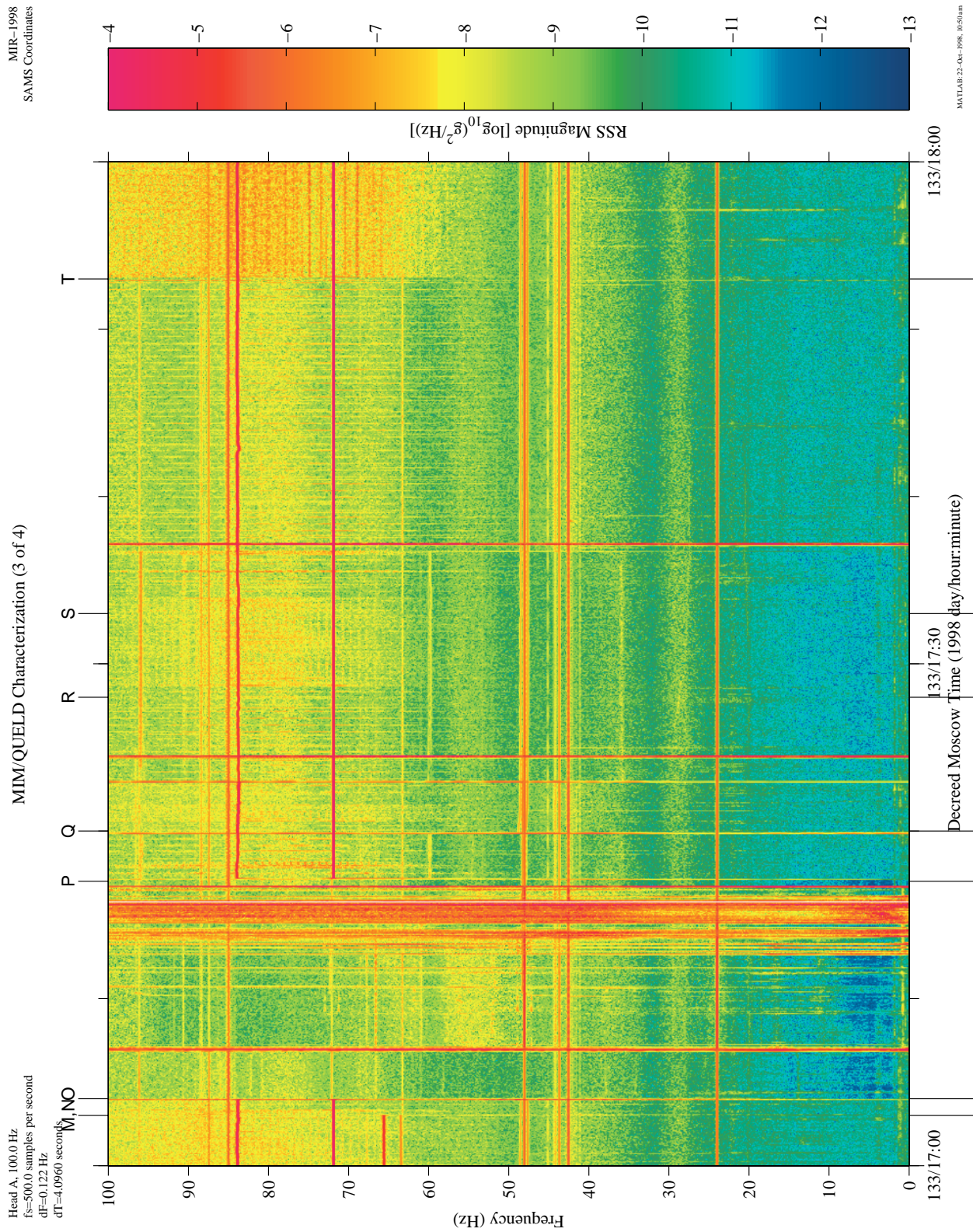

Figure 8. MIM characterization test (third hour).

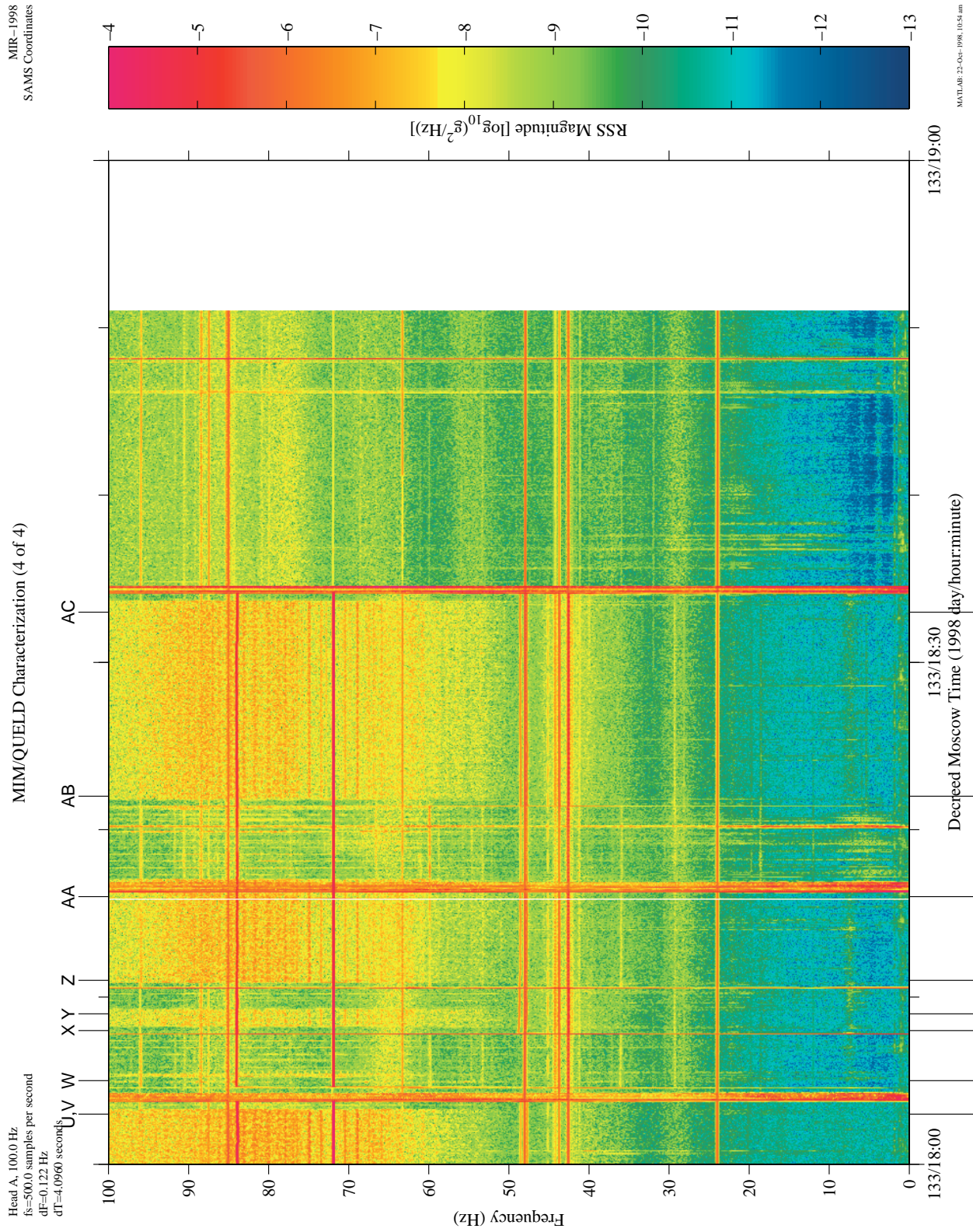

Figure 9. MIM characterization test (fourth hour).

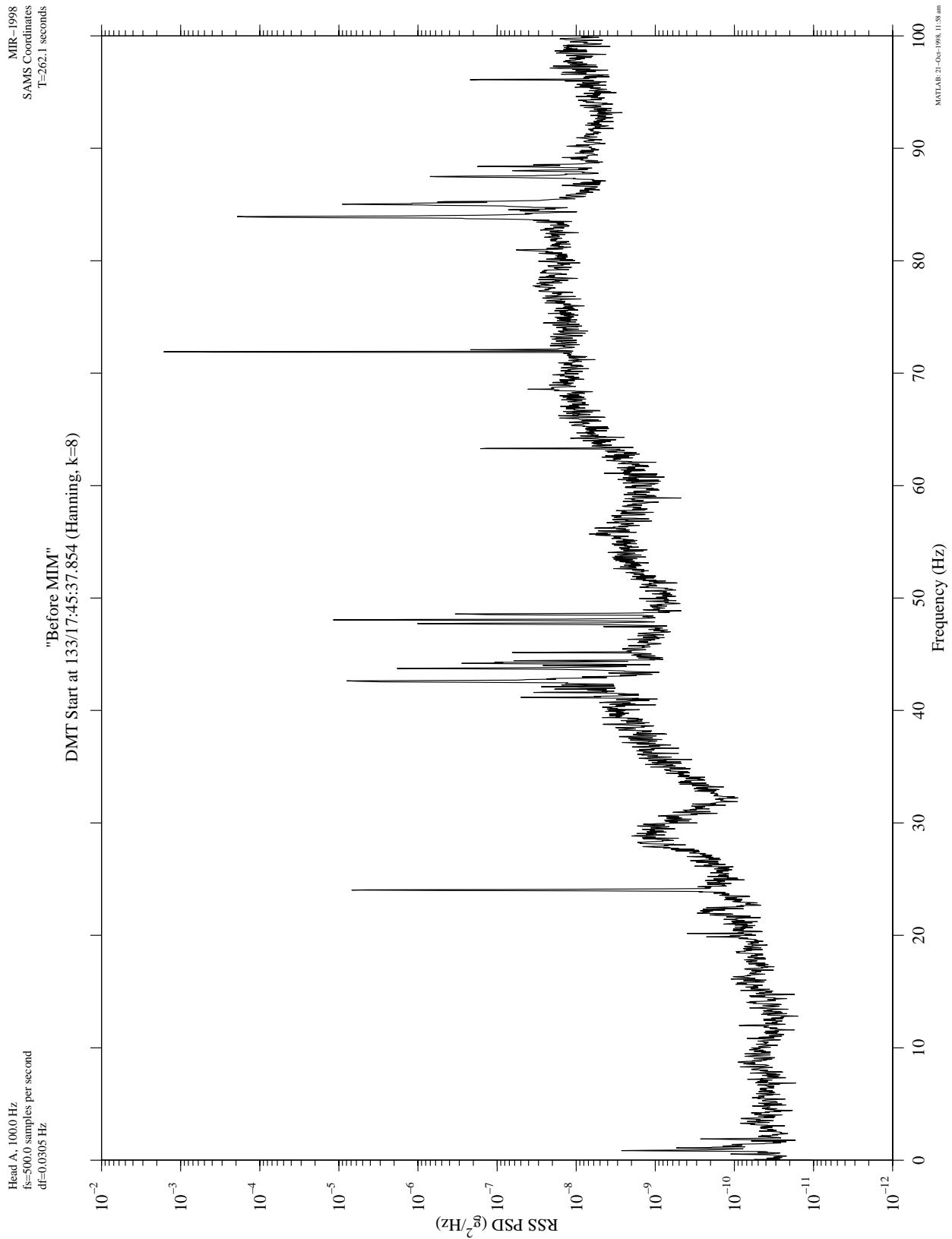

Figure 10. Power spectral density plot before MIM operations.

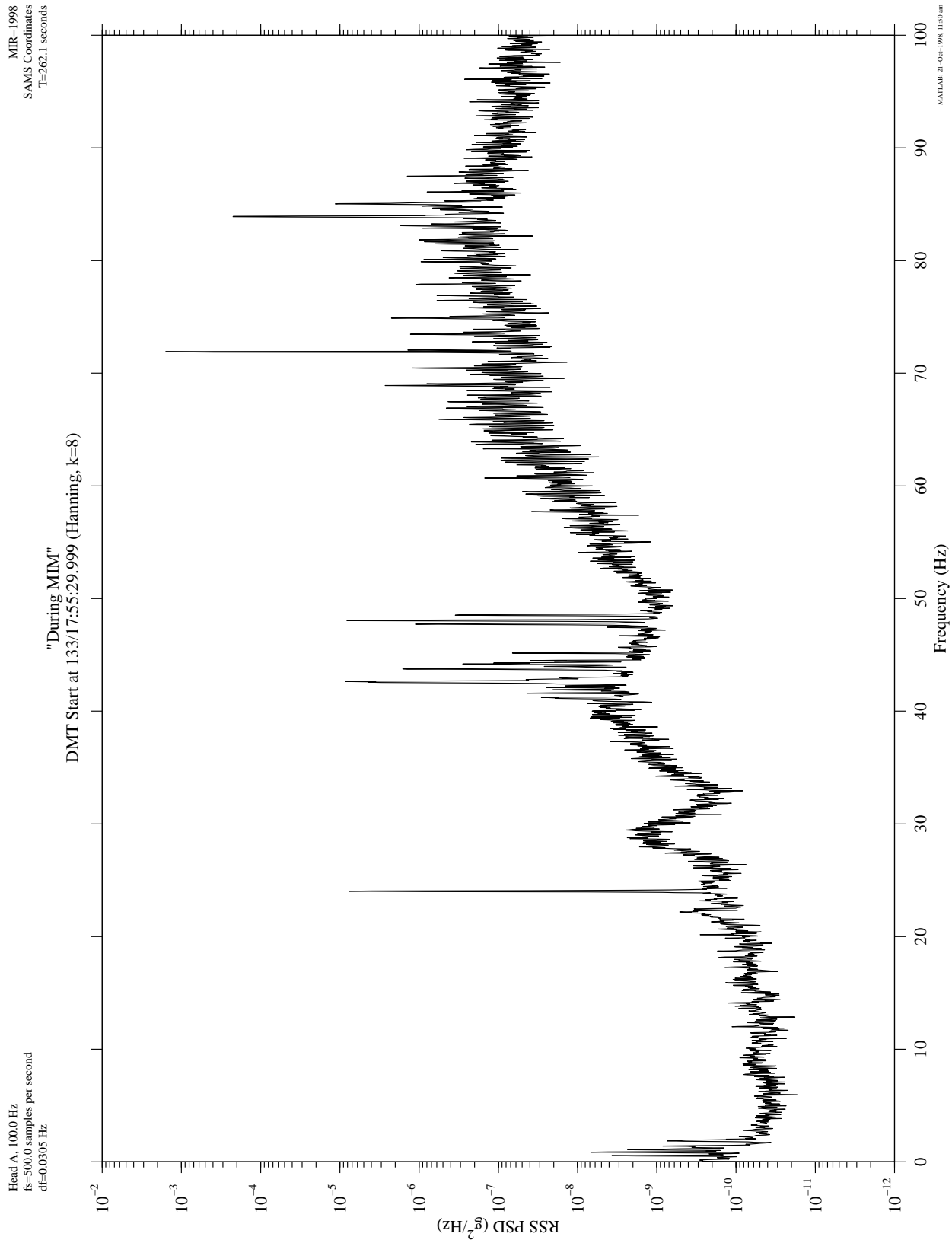

Figure 11. Power spectral density plot during MIM operations.

**Appendix A: SAMS Cutoff-Frequency Color Spectrograms TSH A (100 Hz)**

The Principal Investigator Microgravity Services (PIMS) group has further processed SAMS data to produce the plots shown here. This appendix presents power spectral density versus frequency versus time (spectrogram) plots of SAMS TSH A ( $f_c = 100$  Hz) data.

Color spectrograms are used to show how the microgravity environment varies in intensity with respect to time and frequency. These spectrograms are provided as an overview of the frequency characteristics of the SAMS data. Each spectrogram is a composite of 6 hour's worth of data. The time resolution used to compute the spectrograms seen here is 16.384 seconds. This corresponds to a frequency resolution of 0.0610 Hz.

These data were collected at 500 samples per second, and a 100 Hz low-pass filter was applied to the data by the SAMS unit prior to digitization. Prior to plot production, the raw SAMS data were compensated for gain changes, and then de-meant. De-meaning was accomplished by analyzing individual sections with a nominal length of 30 minutes. Since this de-meaning operation operates on time periods longer than the plot's time resolution, an artificial dc component may be seen in the extreme lower frequency regime of these spectrograms. Since these are data processing artifacts, the low frequency regime ( $f < 0.05$  Hz) should be ignored. Users who are interested in further details for either of these operations are encouraged to contact the PIMS group.

**Appendix B: SAMS Cutoff-Frequency Color Spectrograms TSH B (10 Hz)**

The Principal Investigator Microgravity Services (PIMS) group has further processed SAMS data to produce the plots shown here. This appendix presents power spectral density versus frequency versus time (spectrogram) plots of SAMS TSH B ( $f_c = 10$  Hz) data.

Color spectrograms are used to show how the microgravity environment varies in intensity with respect to time and frequency. These spectrograms are provided as an overview of the frequency characteristics of the SAMS data. Each spectrogram is a composite of 6 hour's worth of data. The time resolution used to compute the spectrograms seen here is 40.960 seconds. This corresponds to a frequency resolution of 0.0244 Hz.

These data were collected at 50 samples per second, and a 10 Hz low-pass filter was applied to the data by the SAMS unit prior to digitization. Prior to plot production, the raw SAMS data were compensated for gain changes, and then de-meant. De-meaning was accomplished by analyzing individual sections with a nominal length of 30 minutes. Since this de-meaning operation operates on time periods longer than the plot's time resolution, an artificial dc component may be seen in the extreme lower frequency regime of these spectrograms. Since these are data processing artifacts, the low frequency regime ( $f < 0.05$  Hz) should be ignored. Users who are interested in further details for either of these operations are encouraged to contact the PIMS group.

**Appendix C: SAMS Nyquist-Frequency Color Spectrograms TSH A (250 Hz)**

The Principal Investigator Microgravity Services (PIMS) group has further processed SAMS data to produce the plots shown here. This appendix presents power spectral density versus frequency versus time (spectrogram) plots of SAMS TSH A ( $f_N = 250$  Hz) data.

Color spectrograms are used to show how the microgravity environment varies in intensity with respect to time and frequency. These spectrograms are provided as an overview of the frequency characteristics of the SAMS data. Each spectrogram is a composite of 6 hour's worth of data. The time resolution used to compute the spectrograms seen here is 16.384 seconds. This corresponds to a frequency resolution of 0.0610 Hz.

These data were collected at 500 samples per second, and a 100 Hz low-pass filter was applied to the data by the SAMS unit prior to digitization. Prior to plot production, the raw SAMS data were compensated for gain changes, and then de-meant. De-meaning was accomplished by analyzing individual sections with a nominal length of 30 minutes. Since this de-meaning operation operates on time periods longer than the plot's time resolution, an artificial dc component may be seen in the extreme lower frequency regime of these spectrograms. Since these are data processing artifacts, the low frequency regime ( $f < 0.05$  Hz) should be ignored. Users who are interested in further details for either of these operations are encouraged to contact the PIMS group.



**Appendix D: SAMS Nyquist-Frequency Color Spectrograms TSH B (25 Hz)**

The Principal Investigator Microgravity Services (PIMS) group has further processed SAMS data to produce the plots shown here. This appendix presents power spectral density versus frequency versus time (spectrogram) plots of SAMS TSH B ( $f_N = 25$  Hz) data.

Color spectrograms are used to show how the microgravity environment varies in intensity with respect to time and frequency. These spectrograms are provided as an overview of the frequency characteristics of the SAMS data. Each spectrogram is a composite of 6 hour's worth of data. The time resolution used to compute the spectrograms seen here is 40.960 seconds. This corresponds to a frequency resolution of 0.0244 Hz.

These data were collected at 50 samples per second, and a 10 Hz low-pass filter was applied to the data by the SAMS unit prior to digitization. Prior to plot production, the raw SAMS data were compensated for gain changes, and then de-measured. De-meaning was accomplished by analyzing individual sections with a nominal length of 30 minutes. Since this de-meaning operation operates on time periods longer than the plot's time resolution, an artificial dc component may be seen in the extreme lower frequency regime of these spectrograms. Since these are data processing artifacts, the low frequency regime ( $f < 0.05$  Hz) should be ignored. Users who are interested in further details for either of these operations are encouraged to contact the PIMS group.

**Appendix E: User Comment Sheet**

We would like you to give us some feedback so that we may improve the Mission Summary Reports. Please answer the following questions and give us your comments.

1. Do the Mission Summary Reports fulfill your requirements for acceleration and mission information?  
 Yes     No

If not why not?

Comments: \_\_\_\_\_

2. Is there additional information which you feel should be included in the Mission Summary Reports?  
 Yes     No

If so what is it?

Comments: \_\_\_\_\_

3. Is there information in these reports which you feel is not necessary or useful?  
 Yes     No

If so, what is it?

Comments: \_\_\_\_\_

4. Do you have internet access via: (  )ftp (  )WWW (  )gopher (  )other? Have you already accessed SAMS data or information electronically?  
 Yes     No

Comments: \_\_\_\_\_

Completed by: Name: \_\_\_\_\_ Telephone: \_\_\_\_\_

Address: \_\_\_\_\_ Facsimile: \_\_\_\_\_

\_\_\_\_\_ E-mail: \_\_\_\_\_

**Return this sheet to:**  
**Kevin McPherson**  
**NASA Lewis Research Center**  
**21000 Brookpark Road MS 500-216**  
**Cleveland, OH 44135**

**or**  
**FAX to PIMS Project: 216-433-8660**  
**e-mail to: pims@grc.nasa.gov.**

## Appendix F - Accessing Acceleration Data Via the Internet

SAMS data collected on Mir from May 1997 to June 1998 are available over the Internet from a NASA Glenn Research Center file server with hostname `beech.grc.nasa.gov`. Acceleration data and related files are arranged in a tree structure. The figure shown below illustrates this structure. The acceleration data files (located at the end of the tree structure) are named for the contents of the file. For example, a file named “`axr17508.46r`” in the directory “`/pub/SAMS-MIR/MIR_1997/MIR_1997_22/heada/year1997/day175/accel`” would contain TSH A data for the X-axis for day 175, hour 8, file 4 of 6. The `readme.doc` file in the `MIR_1997_22` directory gives a complete explanation of the file naming convention. The beech file server can be accessed via anonymous file transfer protocol (ftp), as follows:

1. Open a connection to the file server (hostname: `beech.grc.nasa.gov`)
2. Login with username: `anonymous`, and enter your complete e-mail address as the password
3. Navigate to the directory containing the desired files (like the path shown here:  
`/pub/SAMS-MIR/MIR_1997/MIR_1997_22/heada/year1997/day175/accel`)
4. Enable binary file transfer
5. Transfer the desired files
6. Close the connection

If you encounter difficulty in accessing the data using the file server, send an electronic mail message to `pims@grc.nasa.gov`. Please describe the nature of the difficulty and give a description of the hardware and software you are using to access the file server, including the domain name and/or IP address from which you are connecting.

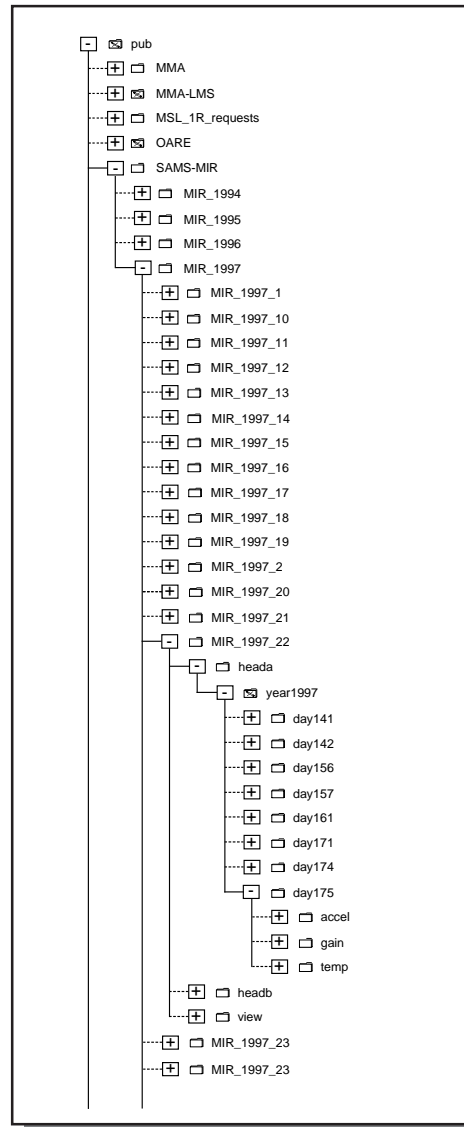

<b>REPORT DOCUMENTATION PAGE</b>			<i>Form Approved</i> <i>OMB No. 0704-0188</i>	
Public reporting burden for this collection of information is estimated to average 1 hour per response, including the time for reviewing instructions, searching existing data sources, gathering and maintaining the data needed, and completing and reviewing the collection of information. Send comments regarding this burden estimate or any other aspect of this collection of information, including suggestions for reducing this burden, to Washington Headquarters Services, Directorate for Information Operations and Reports, 1215 Jefferson Davis Highway, Suite 1204, Arlington, VA 22202-4302, and to the Office of Management and Budget, Paperwork Reduction Project (0704-0188), Washington, DC 20503.				
<b>1. AGENCY USE ONLY (Leave blank)</b>		<b>2. REPORT DATE</b> August 1999	<b>3. REPORT TYPE AND DATES COVERED</b> Technical Memorandum	
<b>4. TITLE AND SUBTITLE</b> SAMS Acceleration Measurements on Mir from May 1997 to June 1998 (NASA Increments 5, 6, and 7)			<b>5. FUNDING NUMBERS</b>  WU-101-46-0A-00	
<b>6. AUTHOR(S)</b>  Richard DeLombard				
<b>7. PERFORMING ORGANIZATION NAME(S) AND ADDRESS(ES)</b> National Aeronautics and Space Administration John H. Glenn Research Center at Lewis Field Cleveland, Ohio 44135-3191			<b>8. PERFORMING ORGANIZATION REPORT NUMBER</b>  E-11750	
<b>9. SPONSORING/MONITORING AGENCY NAME(S) AND ADDRESS(ES)</b> National Aeronautics and Space Administration Washington, DC 20546-0001			<b>10. SPONSORING/MONITORING AGENCY REPORT NUMBER</b>  NASA TM-1999-209282	
<b>11. SUPPLEMENTARY NOTES</b>  Responsible person, Richard DeLombard, organization code 6727, (216) 433-5285.				
<b>12a. DISTRIBUTION/AVAILABILITY STATEMENT</b>  Unclassified - Unlimited Subject Categories: 18, 20, and 35  This publication is available from the NASA Center for AeroSpace Information, (301) 621-0390.			<b>12b. DISTRIBUTION CODE</b>	
<b>13. ABSTRACT (Maximum 200 words)</b>  During NASA Increments 5, 6, and 7 (May 1997 to June 1998), about eight gigabytes of acceleration data were collected by the Space Acceleration Measurement System (SAMS) onboard the Russian Space Station Mir. The data were recorded on twenty-seven optical disks which were returned to Earth on Orbiter missions STS-86, STS-89, and STS-91. During these increments, SAMS data were collected in the Priroda module to support various microgravity experiments. This report points out some of the salient features of the microgravity acceleration environment to which the experiments were exposed. This report presents an overview of the SAMS acceleration measurements recorded by 10 Hz and 100 Hz sensor heads. The analyses included herein complement those presented in previous Mir increment summary reports prepared by the Principal Investigator Microgravity Services project.				
<b>14. SUBJECT TERMS</b> Acceleration measurement; Microgravity environment; SAMS, Shuttle, Orbiter, Mir, NASA increment			<b>15. NUMBER OF PAGES</b> 38	
			<b>16. PRICE CODE</b> A03	
<b>17. SECURITY CLASSIFICATION OF REPORT</b> Unclassified	<b>18. SECURITY CLASSIFICATION OF THIS PAGE</b> Unclassified	<b>19. SECURITY CLASSIFICATION OF ABSTRACT</b> Unclassified	<b>20. LIMITATION OF ABSTRACT</b>	