

NASA/TM—2000-209807



NASA Glenn Steady-State Heat Pipe Code Users Manual Version 2, DOS Input

Leonard K. Tower
Glenn Research Center, Cleveland, Ohio

April 2000

The NASA STI Program Office . . . in Profile

Since its founding, NASA has been dedicated to the advancement of aeronautics and space science. The NASA Scientific and Technical Information (STI) Program Office plays a key part in helping NASA maintain this important role.

The NASA STI Program Office is operated by Langley Research Center, the Lead Center for NASA's scientific and technical information. The NASA STI Program Office provides access to the NASA STI Database, the largest collection of aeronautical and space science STI in the world. The Program Office is also NASA's institutional mechanism for disseminating the results of its research and development activities. These results are published by NASA in the NASA STI Report Series, which includes the following report types:

- **TECHNICAL PUBLICATION.** Reports of completed research or a major significant phase of research that present the results of NASA programs and include extensive data or theoretical analysis. Includes compilations of significant scientific and technical data and information deemed to be of continuing reference value. NASA's counterpart of peer-reviewed formal professional papers but has less stringent limitations on manuscript length and extent of graphic presentations.
- **TECHNICAL MEMORANDUM.** Scientific and technical findings that are preliminary or of specialized interest, e.g., quick release reports, working papers, and bibliographies that contain minimal annotation. Does not contain extensive analysis.
- **CONTRACTOR REPORT.** Scientific and technical findings by NASA-sponsored contractors and grantees.

- **CONFERENCE PUBLICATION.** Collected papers from scientific and technical conferences, symposia, seminars, or other meetings sponsored or cosponsored by NASA.
- **SPECIAL PUBLICATION.** Scientific, technical, or historical information from NASA programs, projects, and missions, often concerned with subjects having substantial public interest.
- **TECHNICAL TRANSLATION.** English-language translations of foreign scientific and technical material pertinent to NASA's mission.

Specialized services that complement the STI Program Office's diverse offerings include creating custom thesauri, building customized data bases, organizing and publishing research results . . . even providing videos.

For more information about the NASA STI Program Office, see the following:

- Access the NASA STI Program Home Page at <http://www.sti.nasa.gov>
- E-mail your question via the Internet to help@sti.nasa.gov
- Fax your question to the NASA Access Help Desk at (301) 621-0134
- Telephone the NASA Access Help Desk at (301) 621-0390
- Write to:
NASA Access Help Desk
NASA Center for AeroSpace Information
7121 Standard Drive
Hanover, MD 21076

NASA/TM—2000-209807



NASA Glenn Steady-State Heat Pipe Code Users Manual Version 2, DOS Input

Leonard K. Tower
Glenn Research Center, Cleveland, Ohio

National Aeronautics and
Space Administration

Glenn Research Center

April 2000

Acknowledgments

The author wishes to express very sincere gratitude to the following people: Barbara McKissock has taken the rough draft of this report and rendered it into a form meeting current NASA standards, not an inconsiderable effort. She also provided much advice on organization and clarity of the text. Karl Baker participated in much invaluable discussion on heat pipe limits. In addition, he made some very thought-provoking suggestions concerning future ways of changing data input to take advantage of new computer capabilities in the future. Both McKissock and Baker helped prepare figures.

Note that at the time of research, the NASA Lewis Research Center was undergoing a name change to the NASA John H. Glenn Research Center at Lewis Field. Both names appear in these proceedings.

Available from

NASA Center for Aerospace Information
7121 Standard Drive
Hanover, MD 21076
Price Code: A03

National Technical Information Service
5285 Port Royal Road
Springfield, VA 22100
Price Code: A03

NASA GLENN STEADY-STATE HEAT PIPE CODE USERS MANUAL
VERSION 2, DOS INPUT

Leonard K. Tower*
National Aeronautics and Space Administration
Glenn Research Center
Cleveland, Ohio 44135

ABSTRACT

The heat pipe code LERHP has been revised, corrected, and extended. New features include provisions for pipes with curvature and bends in "G" fields. Heat pipe limits are examined in detail and limit envelopes are shown for some sodium and lithium-filled heat pipes. Refluxing heat pipes and gas-loaded or variable conductance heat pipes were not considered.

INTRODUCTION

The Lewis Research Center developed and reported on a heat pipe code designated as LERHP (ref. 1). This code has been used as an aid in the preliminary design of space power systems and space radiators.

Subsequent to the release of the documentation on this code, it has been considerably altered to introduce new features and to correct previous errors and shortcomings. The new material, although developed for use in preliminary design studies of heat pipes for high temperature Stirling power converters, should be of general interest. The present publication describes the new features available in the revised code and reviews the previously reported features.

DISCUSSION

Some Features of the Code

Although the code retains the features of the earlier version, a detailed discussion of them is included herein in the interest of completeness. Reference 1 can be readily consulted for further information. Among the new features is the ability to consider curved and moderately bent heat pipes in a "G" field. Also, heat input from heaters at specified temperatures radiating or convecting to evaporators is considered. At present the code is constructed for use on a PC-compatible machine with DOS capability and requires coupling to a dedicated printer for output of data. The language of the source code is Microsoft FORTRAN 4.1, a version of FORTRAN 77.

Physical Units—The units used for input and output are exclusively SI. So many possibilities exist that if other choices are made, any compromise in favor of other units would be certain to inconvenience some users. The code internally employs calories in some of the stored thermochemical data for alkali metals to avoid possible error in converting to SI units.

Vapor flow algorithm—The code employs a vapor flow algorithm based on the incompressible equations derived by Busse (ref. 2). Reference 3 describes how Busse's incompressible equations were rederived to account for compressibility. Density was treated as a variable in the equations for momentum and mass conservation. With the introduction of an energy integral relating the heat pipe thermal boundary conditions with the energy transported by the flowing vapor, three ordinary differential equations in pressure, mean vapor temperature, and the velocity profile factor introduced by Busse were obtained. These can be solved to relate heat flux to heat pipe temperatures for a variety of cases. The availability of these differential equations enables a smooth numerical integration through the heat pipe without the stepwise incompressible increments necessitated in some other codes (ref. 4). For the alkali

* Distinguished Research Associate at Glenn Research Center.

metal working fluids, with the exception of cesium, chemical equilibrium between monatomic and diatomic species is considered in the flow equations.

The use of the mean vapor temperature as a variable accounts for the subcooling which occurs in the core of the pipe as the vapor expands from its source at the wall vapor-liquid interface. This phenomenon has been considered for heat pipes in an analytical study (ref. 5) but is not generally incorporated in simple heat pipe codes. Rather, the usual practice has been to relate vapor temperature and pressure by assuming liquid-vapor equilibrium. Conceivably, the neglect of subcooling can affect the prediction of conditions wherein choke is encountered at the end of evaporator or adiabatic sections of the heat pipe. Decoupling of the mean vapor temperature from the local vapor pressure in the evaporator and adiabatic section may lead to a more justifiable, and possibly more realistic, representation of the vapor flow in these sections, especially at high subsonic Mach numbers. In this regard, a sonic limit is not computed during the execution of the present code, as is often done (ref. 4) by means of the Busse (ref. 6) or Levy (ref. 7) sonic limit equations. These equations, relating heat flux to evaporator upstream pressure and density, idealize the vapor flow, do not account for the effect of evaporator friction, and require simplified treatment of adiabatic section friction. Admittedly, the Busse sonic limit expression gives surprisingly good agreement with results of the LERCHP code described here despite these shortcomings.

Also not considered in some other codes are the complexities due to the possible existence of chemical equilibria in the vapor phase if alkali metals are employed. If these equilibria are attained, the equations in these codes may provide poorer approximations to a choking condition. With the Lewis code, the conditions of heat flux and temperature leading to the choking of a pipe of specified dimensions are identified more precisely within the assumption of local chemical equilibrium between monatomic and diatomic species with a little iterative effort.

Thermal Boundary Conditions—For the purpose of assigning thermal boundary conditions, the code has been designed to be flexible with respect to number and arrangement of the component parts (evaporator, condenser, adiabatic section). Two options for thermal boundary conditions are available: (1) heat input or removal at specified rates, and (2) specified environment temperature with heat transfer coefficients between pipe and environment provided by the user. Option 2 can handle heat transfer to or from a source or sink by radiation and/or convection. If more than one heat input section is present sequentially in a pipe, each can be assigned independently to option (1) or (2). An adiabatic section is represented by option 1 with no heat transfer. Up to 20 sections with different thermal conditions can be considered although most pipes contain only an evaporator, adiabatic section, and condenser. The required thermal data can be entered as a single value for an entire section. Alternatively, input data that vary with distance along a section are entered at numerous positions. At code execution, the data are interpolated smoothly within a section by cubic spline fits. Thermal discontinuities are accommodated by creating a new section as required. The algorithms to implement the spline interpolation algorithms were adapted from reference 8. Appendix A presents a figure illustrating the subdivision of the pipe into thermal sections.

Operation in "G" Field—The liquid in a pipe operating in a "G" field is subjected to body forces that may either aid or hinder the return of the liquid from the condenser to the evaporator. For operation in "G" fields, the possibility of bends and curvature out of the plane of the gravitational horizon, leading to variation in hydrostatic head along the pipe, has been considered. Alternatively, the pipe may be straight but inclined to horizontal. Varying curvature may be specified along the pipe for up to twenty sections of the pipe. Again, cubic spline fits are used to interpolate this curvature and orientation data. Appendix A also presents figures and description of the data required for orientation and curvature specification. Operation of the pipe in the reflux position (evaporator lower than condenser) has not been considered at this time.

Input and Output of the Code

Data entry and retrieval—Appendix B contains a list of symbols used in input and output. Appendix C contains examples of data entry for the present DOS version of the code, displaying features of the code. In Appendix D the data outputs for these examples are displayed.

In the present DOS version of the code, data entry is by means of an interactive subroutine in which the user is asked to indicate the options to be used and to type in the values desired, or to change default values provided. At the completion of data input, a summary is printed out.

Two modes of data output are available. The user may obtain a printout of the principal local variables such as liquid and vapor pressure, temperatures, and axial heat flux for a chosen number of locations uniformly spaced along the pipe. At the same time, these data are also printed for ends and beginnings of sections properly interspersed with the uniformly spaced data.

In addition, a data summary is printed showing mainly the heat transport, pipe surface temperature at the upstream end of the evaporator and the downstream end of the condenser, location of the wet point, and the meniscus pressure difference. While this information is always produced, the data printout at stations along the pipe may be omitted. Retrieval of data will be illustrated by some examples.

Solution of the Flow Equations

Vapor flow—In references 1 and 3 the three ordinary differential equations pertaining to pressure, mean temperature, and velocity profile factor are derived. In Appendix E, herein, the derivation is amended by incorporating a derivation of the flow equations for the condition of turbulence in the condenser. The fourth-order Runge-Kutta algorithm recommended by White (ref. 9) is employed in the solution of the differential equations. The user chooses the maximum step size by specifying the initial number of steps to be employed in the solution with a default value of 100. As the computation progresses through the pipe, the step size is halved if the pressure drop between successive steps exceeds about 3 percent. If subsequent pressure recovery exceeds 1 percent per step, the step size is doubled. Also, as the end of a section is approached, the step size is adjusted so that it coincides with the section end. The optimum step size was not systematically investigated. However, when as many as 200 steps were tried, the results were not necessarily improved.

In the evaporator and adiabatic section, the set of three equations in pressure, temperature, and velocity profile factor are solved in straightforward fashion. The condenser section requires additional consideration. There is no apparent way to perform a mathematical "unmixing" of the vapor stream as it is diminished by condensation. The mean vapor temperature computed by the algorithm used in the evaporator and adiabatic section becomes uncoupled from the boundary conditions, leading to an impossible increase in vapor temperature.

An additional complication in the condenser is the possible onset of turbulence caused by mass removal. Laminar flow is assured in the evaporator because of mass injection (ref. 10), and probably persists in the adiabatic section. The axial rate of development of turbulence in the condenser is unknown.

Another factor possibly affecting the vapor flow is the nucleation of liquid droplets due to the subcooling of the vapor core. While this phenomenon is a possibility in all sections, the greater time of flight available in the condenser makes it much more likely there. This effect apparently has not been considered in any heat pipe code, including the present one.

Because of these uncertain conditions in the condenser, the user of the present code may choose one of two approaches at the time of data entry. Careful consideration of experimental data may then indicate which approach is most representative of the actual situation. In the first of these, the default computation, use is made of the Kemme approximation for recovery of the inertial pressure, as employed in reference 4. The development of turbulence in the condenser is considered. For these reasons, flat front flow equations were employed in a part of the condenser. A more elegant treatment of the condenser flow awaits better experimental definition of processes in the condenser. These issues are discussed in Appendix E.

In the second approach, the laminar flow equations presented in reference 1 are used in their entirety for the condenser as well as the preceding sections, except as follows: At the point where the mean vapor temperature becomes equal to the temperature at the vapor-liquid interface (the saturation temperature), the latter is employed instead. The Busse velocity profile factor computed in this case indicates a strong recirculation near the condenser downstream end.

Liquid flow—The Darcy equation (ref. 11) is used to compute the liquid pressure drop between the condenser end and the evaporator upstream end. The liquid pressure profile is adjusted after convergence of the vapor flow integration through the pipe with satisfaction of thermal boundary conditions. The liquid pressure must approximate

the vapor pressure at one point (the wet point), or perhaps two in a refluxing pipe. Commonly, the wet point is located at the condenser downstream end.

Pipe Construction

Material properties—The code contains data for these fluids: the alkali metals (sodium, potassium, lithium, and cesium), water, ammonia, methanol, mercury, Dowtherm A, acetone, benzene, Freon-11, n-heptane, silver, toluene, and m-xylene. For the alkali metals except cesium, the presence of both monomer and dimer vapor species (monatomic and diatomic) is considered. Thermodynamic data from reference 12, stored in the program as arrays, enable the varying chemical equilibrium between the two species to be considered along the pipe, assuming ideal gas behavior of the individual species. From the tabulated information the composition, heat of vaporization, equilibrium speed of sound, and other required data are obtained.

The user may select the following substances as construction materials for the heat pipe wall: aluminum, beryllium, copper, Inconel, iron, molybdenum, nickel, niobium-1% zirconium, 304 stainless steel, tantalum, titanium, and tungsten. For materials not on this list, known thermal conductivities can be entered by the user. However, axial temperature variation will not then be accounted for.

Thermophysical and thermodynamic properties of the construction materials except for the alkali metals as noted above, were taken from references 11 and 12, and 13 through 16, and stored as polynomials in the program.

Wick Options—The wick options are: (1) user input, (2) screen wick, (3) screen wick with arteries, (4) sintered metal wick, and (5) sintered metal wick with arteries. Appendix F illustrates these options and lists the input data which are required.

How the Code Works

Appendix G contains a somewhat detailed description of how the code proceeds to achieve a solution after the input data on working fluid and pipe specifications are provided.

Limit Envelope—As examples, limit envelopes were generated for heat pipes. These envelopes illustrate the regions of heat input and evaporator upstream vapor temperature within which a series of heat pipes of the chosen classes can be expected to operate. A series of pipes with identical evaporator and adiabatic sections was considered, with finned condensers whose lengths were increased in generating the envelope. These examples have been chosen to illustrate the use of the code in constructing an envelope, and do not represent an attempt to design a heat pipe for an actual application.

In the first example, sodium was taken as the working fluid, with stainless steel being used for wicking and containment material. Figure 1a shows the envelope which was generated for a series of pipes identical except for condenser length. In Appendix H the details of the pipes assumed for development of the limit envelope is discussed. In all cases, both the evaporator and adiabatic sections were 0.2 m in length. For each pipe, heat input Q was increased in steps to generate a line of Q against $T_1(0)$, the vapor temperature at the upstream end of the evaporator. For example, consider the line for the pipe of total length 0.6 m. Below the lower heat pipe limit, the viscous limit is encountered and no solution exists. The upper limit for this pipe is the boiling limit (the radius for nucleation was adjusted arbitrarily to assure the presence of a boiling limit line on the figure.) By increasing the condenser length in increments of 0.05 m for succeeding pipes, a series of lines was generated for which lower and upper heat pipe limits were encountered. While figure 1a shows only a few of these lines, the developed limit envelope is drawn. The approximate regions in which each of the limits is encountered (viscous, capillary, and boiling) is also shown.

Figure 1b is a limit envelope for a series of lithium-filled tungsten pipes with tungsten wicking. All dimensions of construction were the same as those assumed for the sodium-filled pipe. While the scale of the envelope for lithium is much larger than for sodium, the plots are very similar.

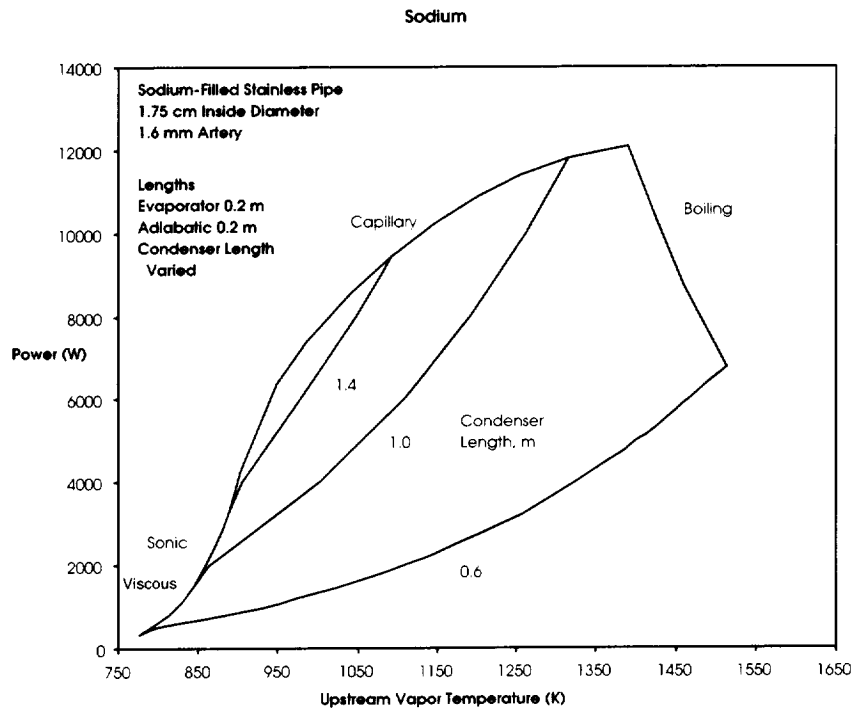

Figure 1a.—Heat pipe limit envelope and operating curves for various fixed condenser lengths using sodium working fluid.

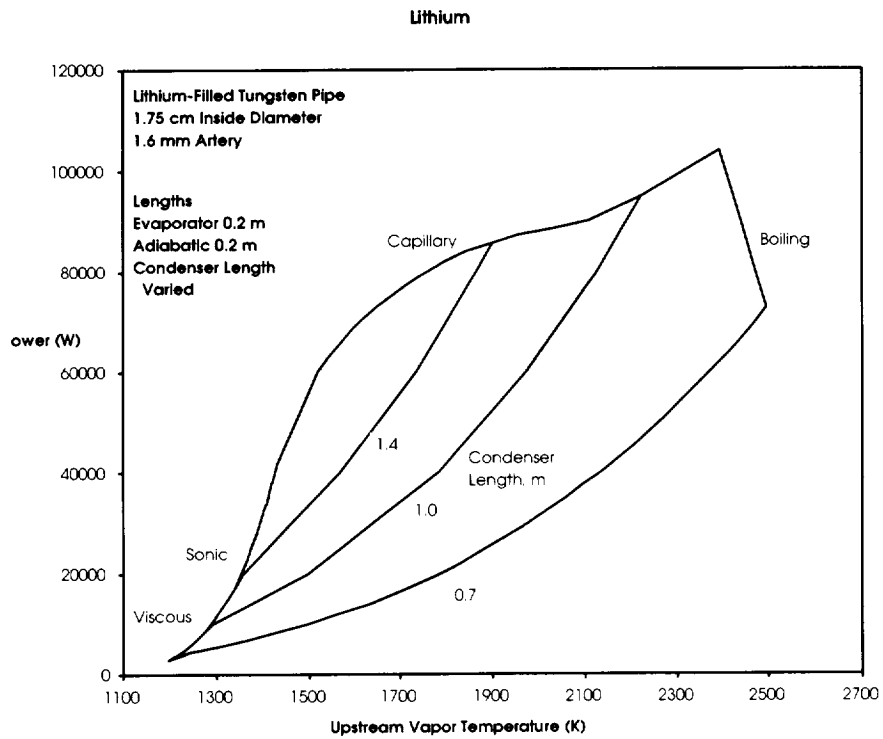

Figure 1b.—Heat pipe limit envelope and operating curves for various fixed condenser lengths using lithium working fluid.

For both the sodium and lithium examples, the tilt was -3° (evaporator above condenser), and the minimum nucleation radius was 6×10^{-6} m.

An example in Appendix H also compares the sonic and viscous limits found by the LERCHP code with the limits given by the simplified equations of Busse (ref. 6). The Busse relations are widely employed in predicting performance of heat pipe designs and are computed and displayed in the execution of some heat pipe codes (ref. 4).

CONCLUDING REMARKS

The code, as reported herein, is an ongoing effort. The number of possible combinations of boundary conditions and materials is very large. It has been possible to test thoroughly only a few of these combinations. No doubt the user may find many cases where the code will fail. A primary goal of this coding effort has been to avoid a return to the operating system with an error message. If examination of the data entered shows that no input error has been made, the problem may be a previously undetected programming error.

APPENDIX A
PIPE SUBDIVISIONS AND GEOMETRY

Thermal Sections

Figure 2 shows a conventional heat pipe subdivided into evaporator, adiabatic section, another evaporator, and condenser. This pipe has been divided into NS sections, NS = 4. These are numbered IS = 1 to 4. The thermal boundary condition for each section is specified by LD(IS) = 1 or LD(IS) = 2. LD(IS) = 1 indicates heat input will be specified. Environment temperatures are provided if LD(IS) = 2. Adiabatic sections are denoted by the condition LD(IS) = 1 with no heat input. The input may be given as uniform for the entire section. Alternatively, the heat input or removal can vary smoothly over the section and is specified as heat input or output per unit length for up to 21 stations per section, interpolated by spline fit. If varying boundary conditions instead of heat input are to be specified over a section, the varying heat transfer coefficients (radiant and/or convective) and specific areas (m^2/m), and possibly environment temperatures are required. These may also be specified for up to 21 stations per section. If a discontinuity in any of these variables within a section prevents a good spline fit, new sections can be created within which the variables and their first derivatives are indeed continuous.

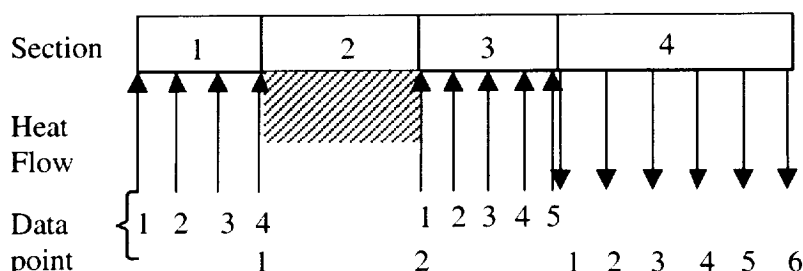
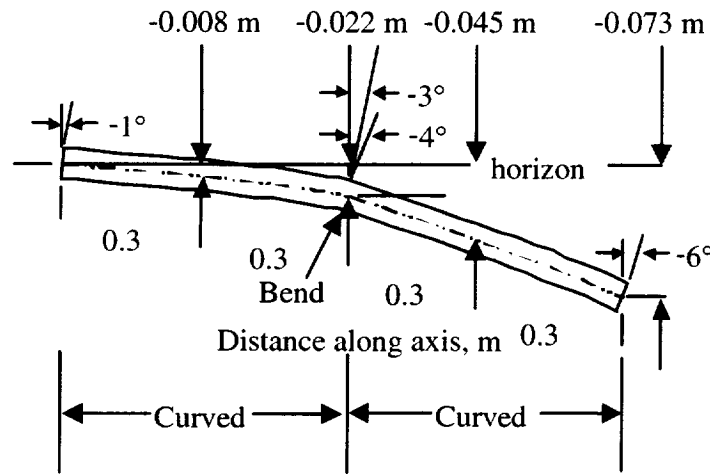

Figure 2.—Pipe thermal subdivisions.

"G" Field Orientation Sections

If the pipe is in a "G" field, the user of the code establishes a reference plane of gravitational equipotential (a "horizon") from which to work. This plane is passed through the midpoint of the inside of the evaporator end cap. If the pipe is straight, the user of the code specifies only the angle with respect to the horizon. If the pipe is curved, varying curvature is specified with respect to the horizontal plane for a sequence of locations along the axis. If a few moderate bends are also present, the locations of these bends and their angles can be specified along the pipe for one to twenty sections of the pipe. The total number of sections is designated with NSB and individual section number with ISB. These sections are similar to the familiar evaporator, adiabatic, condenser sections, but not necessarily coincident therewith. Bends between sections may be sharp but are required to be small since no account is made at present of liquid and vapor pressure losses due to disturbance of the flow at such points. In the HITE option, the user specifies the vertical distance from the horizon to the pipe centerline, HITE, for a number of locations along the centerline. In this option, the angles of the pipe axis at the beginning and end of each section are required as boundary conditions for the spline fit. However, if the vertical distance is specified for more than three locations in the first or last section of the pipe, no pipe axis angles are specified for the beginning or end of the pipe. In this case, natural boundary conditions (ref. 8) are assumed for the pipe beginning or end. Alternatively, in the BETA option the angle of the pipe with respect to the horizon, BETA, may be specified at a number of locations.

Figure 3a shows a pipe of two curved sections separated by a bend with vertical distances from the pipe axis to the horizon specified, together with the angles at the beginning and end of sections required as boundary conditions in the cubic spline fit. As the other option, figure 3b shows the same pipe with local angles specified at several locations. All distances and angles are to be measured from the pipe centerline. In both figures 3a and 3b the pipe centerline coordinate is also shown (the z coordinate of the code), and can be out of the plane of the paper. The z coordinate is understood to be the actual scalar distance along the pipe axis. When the code is run, the distance from the pipe centerline to the top and bottom of the vapor space is accounted for in computing the hydraulic head at each axial or z location. The sample case provided in this report illustrates the HITE option.



Not to scale

Figure 3a.—"G" field orientation using vertical distance from horizon.

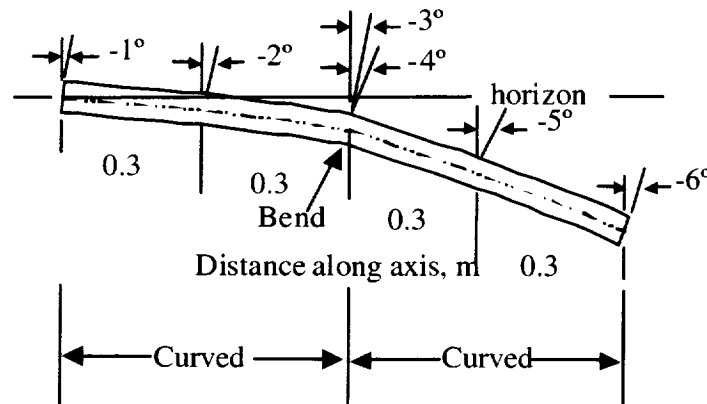

Not to scale

Figure 3b.—"G" field orientation using angle with respect to horizon.

The specification of the vertical distance below the horizon at a number of locations along the pipe rather than the local angles with respect to the horizon plane gives essentially the same result. This may be verified by first running a case in which the angles are provided (the BETA option), and obtaining HITE as an output for a number of locations. These values of HITE, used as input in the HITE option, will provide insignificantly different performance.

Also, when the HITE option is used, the values of HITE retrieved at the locations for which data was input may differ very slightly from the input values. When the spline fit subroutine is used to interpolate HITE, it computes also the first derivative thereof. This is conveniently used in the integration subroutine RUNGE to obtain the hydrostatic head and to reconstruct HITE.

If a straight pipe is inclined in a "G" field, only the angle of inclination is required by the code.

Data Print Locations

If the printout of data along the pipe is desired, up to 100 uniformly spaced locations may be specified. In addition, data will be printed at the beginning and end of each section whether or not it is at one of the uniformly spaced print locations. If a print location is between two steps of the Runge-Kutta solution, linear interpolation is employed for the printed-out variables.



APPENDIX B
SYMBOLS USED IN INPUT AND OUTPUT

A	Busse velocity profile parameter
AK	product of wick cross section area and permeability, m^4
AV	cross section area of vapor passage, m^2
BETA	angle between gravitational horizon and pipe centerline, degrees
DCRITE	entrainment critical dimension, m
DELTCR	temperature drop through evaporator wick to initiate boiling, K
DWBR	critical dimension in the Weber equation for entrainment, m
DI	inner diameter of pipe wall, m
DO	outer diameter of pipe wall, m
DQDZ	radial heat rate into or out of pipe per unit length, W/m
HC	heat transfer coefficient, W/m^2K
HITE	vertical distance from gravitational horizon to pipe centerline, m
KE	effective thermal conductivity of saturated wick, W/mK
MACHM	mean Mach number at axial position Z computed using mean velocity VM, with sound speed computed from mean temperature TM
NA	number of arteries
P	pressure in the vapor at axial position Z, N/m^2
PE	perimeter of vapor passage cross section, m
PLBOT	liquid pressure at bottom of wick at position Z, N/m^2
PLTOP	liquid pressure at top of wick at position Z, N/m^2
PORE	porosity of wick, volume of void in wick per wick volume
Q	axial vapor heat transport at axial position Z, W
QSEC	total radial heat input to an evaporator section of pipe, W
RADK	product of emissivity and configuration factor
RCM	effective minimum capillary radius in the wick, m
RN	minimum nucleation radius, m
RSS	radius of particles in sintered wick, m

SA	specific area, m^2/m
TBOIL	temperature drop through evaporator wick, which will result in boiling if DELTCR is exceeded, K
TENV	environment temperature or temperature of heater surface, K
TM	mean temperature at axial position Z, K
TWI	wick thickness, m
T1Z	vapor temperature at vapor-liquid interface at axial position Z, K
T2Z	liquid temperature at vapor-liquid interface at axial position Z, K
T3Z	inner surface temperature of pipe at axial position Z, K
T4Z	outer surface temperature of pipe surface at axial position Z, K
VM	mean vapor velocity at axial position Z, m/s
Z	axial distance from beginning of pipe or reference coordinate measured along the centerline, m

APPENDIX C
EXAMPLE OF DATA INPUT

As an example of data input in this DOS version of the code, the following case has been chosen. A curved and bent heat pipe similar to that shown in figures 3a and 3b is operated in a "G" field. The pipe is heated by radiation from a heater at a uniform temperature, has an adiabatic section, and rejects heat to an environment at uniform temperature. The data provided are those required by heat pipe wick option 1, user definable, as described in Appendix F. Dimensions of the pipe are as follows:

Outside diameter	0.0191 m
Inside diameter	0.0175 m
Length of evaporator	0.2 m
Length of adiabatic section	0.2 m
Length of condenser	1.0 m
Permeability-area product	$3.931 \times 10^{-14} \text{ m}^4$
Vapor perimeter	0.04346 m
Porosity	0.6107
Thermal conductivity of wick	44 W/m K
Vapor cross sectional area	$1.503 \times 10^{-4} \text{ m}^2$
Capillary radius	$3.683 \times 10^{-5} \text{ m}$
Entrainment dimension	$3.683 \times 10^{-5} \text{ m}$
Nucleation radius	$1 \times 10^{-6} \text{ m}$
Number of arteries	0

The gravity field has a strength of 1 "G". The pipe has a single bend at 0.6 m. Orientation in the field is by specification of the vertical distances from the gravity equipotential plane to the pipe centerline at selected distances along the centerline. Before the bend, these are as follows:

Distance z, m	Height HITE, m
0.0	0.0
.2	-.005235
.4	-.013959
.6	-.026581

No angle is specified for the pipe centerline with respect to the horizon at the pipe beginning because more than three data points are employed. However, at the end of the section, at the discontinuous bend, the angle is -4 degrees.

At the start of the section beyond the bend this angle is -3 degrees. The distance versus height data are as follows:

Distance z, m	Height HITE, m
0.6	-.026581
.8	-.035946
1.0	-.044122
1.2	-.050018
1.4	-.054160

No angle is specified for the pipe centerline at the pipe end because more than three data points are again used.

The following thermal input data were found by trial to cause this pipe to operate close to choke at the end of the adiabatic section:

Section	SA,m ² /m	RADK	HC,W/m ² K	QSEC,W	TENV, K
1	0.06	0.8	0	----	1680
2	----	---	-----	0	----
3	.15	.8	0	----	273

The data entry for this example, as it appears on the screen, follows.
The data printout is shown in Appendix D.

LERCHP

LEWIS HEAT PIPE CODE, NASA LEWIS RESEARCH CENTER
TO CONSIDER LAMINAR FLOW IN LAST CONDENSER, TYPE "Y"

TURBULENCE CONSIDERED IN LAST CONDENSER

IF THIS IS NOT THE FIRST RUN AND ALL PREVIOUSLY ENTERED DATA ARE USED EXCEPT
NEW THERMAL DATA, TYPE "Y"

BEGIN INPUT OF HEAT PIPE GEOMETRY
IS THE PIPE IN A "G" FIELD? TYPE "Y"
Y

FOLLOWING INPUT IS FOR PIPES IN "G" FIELDS

IF EVAPORATOR BELOW CONDENSER BEWARE! CODE NOT YET FOR THERMOSYPHONS.

"G" FIELD STRENGTH,MULTIPLE OF "G" .00000000
IF CHANGE, TYPE "Y", THEN PRESS ENTER
Y

ENTER NEW REAL VALUE

1

IS HEAT PIPE STRAIGHT? TYPE "Y"

CURVED OR BENT PIPE IN "G" FIELD.
IF HEIGHT WITH RESPECT TO HORIZON GIVEN INSTEAD OF ANGLE,TYPE "Y"
Y

GIVE VERTICAL DISTANCE FROM HORIZONTAL PLANE TO PIPE AXIS.
IF EVAPORATOR ABOVE CONDENSER,PIPE ANGLE IS NEGATIVE.

ENTER NUMBER OF DISCRETE CURVED OR BENT SECTIONS> 0
IF CHANGE, TYPE "Y", THEN PRESS ENTER
Y

ENTER NEW INTEGER VALUE

2

"G" FIELD SECTION NUMBER 1

NUMBER OF LOCATIONS WITH INPUT DATA PROVIDED IN THIS SECTION> 0
IF CHANGE, TYPE "Y", THEN PRESS ENTER
Y

ENTER NEW INTEGER VALUE
4
ANGLES OR VERTICAL DISTANCES BELOW THE HORIZONTAL ARE NEGATIVE.

POINT # 1
DISTANCE Z ALONG PIPE AXIS, m .00000000
IF CHANGE, TYPE "Y", THEN PRESS ENTER

POINT # 2
DISTANCE Z ALONG PIPE AXIS, m .00000000
IF CHANGE, TYPE "Y", THEN PRESS ENTER
Y
ENTER NEW REAL VALUE
.2
VERTICAL DISTANCE FROM HORIZON TO PIPE AXIS, m, .00000000
IF CHANGE, TYPE "Y", THEN PRESS ENTER
Y
ENTER NEW REAL VALUE
-.005235

POINT # 3
DISTANCE Z ALONG PIPE AXIS, m .00000000
IF CHANGE, TYPE "Y", THEN PRESS ENTER
Y
ENTER NEW REAL VALUE
.4
VERTICAL DISTANCE FROM HORIZON TO PIPE AXIS, m, -.52350000E-02
IF CHANGE, TYPE "Y", THEN PRESS ENTER
Y
ENTER NEW REAL VALUE
-.0139

POINT # 4
DISTANCE Z ALONG PIPE AXIS, m .00000000
IF CHANGE, TYPE "Y", THEN PRESS ENTER
Y
ENTER NEW REAL VALUE
.6
LOCAL ANGLE OF THE PIPE, DEG .00000000
IF CHANGE, TYPE "Y", THEN PRESS ENTER
Y
ENTER NEW REAL VALUE
-4
VERTICAL DISTANCE FROM HORIZON TO PIPE AXIS, m, -.13900000E-01
IF CHANGE, TYPE "Y", THEN PRESS ENTER
Y
ENTER NEW REAL VALUE
-.026581

"G" FIELD SECTION NUMBER 2

NUMBER OF LOCATIONS WITH INPUT DATA PROVIDED IN THIS SECTION> 0
IF CHANGE, TYPE "Y", THEN PRESS ENTER
Y

ENTER NEW INTEGER VALUE
5
ANGLES OR VERTICAL DISTANCES BELOW THE HORIZONTAL ARE NEGATIVE.

POINT # 1
DISTANCE Z ALONG PIPE AXIS, m .60000000

LOCAL ANGLE OF THE PIPE, DEG -4.0000000
IF CHANGE, TYPE "Y", THEN PRESS ENTER
Y
ENTER NEW REAL VALUE
-3

POINT # 2
DISTANCE Z ALONG PIPE AXIS, m .00000000
IF CHANGE, TYPE "Y", THEN PRESS ENTER
Y
ENTER NEW REAL VALUE
.8
VERTICAL DISTANCE FROM HORIZON TO PIPE AXIS, m, -.26581000E-01
IF CHANGE, TYPE "Y", THEN PRESS ENTER
Y
ENTER NEW REAL VALUE
-.035946

POINT # 3
DISTANCE Z ALONG PIPE AXIS, m .00000000
IF CHANGE, TYPE "Y", THEN PRESS ENTER
Y
ENTER NEW REAL VALUE
1
VERTICAL DISTANCE FROM HORIZON TO PIPE AXIS, m, -.35946000E-01
IF CHANGE, TYPE "Y", THEN PRESS ENTER
Y
ENTER NEW REAL VALUE
-.044122

POINT # 4
DISTANCE Z ALONG PIPE AXIS, m .00000000
IF CHANGE, TYPE "Y", THEN PRESS ENTER
Y
ENTER NEW REAL VALUE
1.2
VERTICAL DISTANCE FROM HORIZON TO PIPE AXIS, m, -.44122000E-01
IF CHANGE, TYPE "Y", THEN PRESS ENTER
Y
ENTER NEW REAL VALUE
-.050018

POINT # 5
DISTANCE Z ALONG PIPE AXIS, m .00000000
IF CHANGE, TYPE "Y", THEN PRESS ENTER
Y
ENTER NEW REAL VALUE
1.4

VERTICAL DISTANCE FROM HORIZON TO PIPE AXIS, m, -.50018000E-01
IF CHANGE, TYPE "Y", THEN PRESS ENTER
Y

ENTER NEW REAL VALUE
-.05416
END HEIGHT OR ANGLE INPUT FOR PIPE IN "G" FIELD
TO CORRECT PIPE ORIENTATION INPUT, TYPE"Y"

INITIAL NUMBER OF RUNGE-KUTTA STEPS CHOSEN 100
IF CHANGE, TYPE "Y", THEN PRESS ENTER

LIMIT ON DATA POINTS OUTPUT ALONG PIPE IS 100.
SHOULD NOT EXCEED NUMBER OF RUNGE-KUTTA STEPS.

NUMBER OF DATA POINTS OUTPUT ALONG THE PIPE 50
IF CHANGE, TYPE "Y", THEN PRESS ENTER
Y

ENTER NEW INTEGER VALUE
14

NUMBER OF PIPE THERMAL SECTIONS TO BE CONSIDERED 2
IF CHANGE, TYPE "Y", THEN PRESS ENTER
Y

ENTER NEW INTEGER VALUE
3

ARE PIPE DIMENSIONS AND WICKING SAME IN ALL SECTIONS? TYPE "Y"
Y

OUTSIDE PIPE WALL DIAMETER, DO, m .00000000
IF CHANGE, TYPE "Y", THEN PRESS ENTER
Y

ENTER NEW REAL VALUE
.0191

INSIDE PIPE WALL DIAMETER, DI, m .00000000
IF CHANGE, TYPE "Y", THEN PRESS ENTER
Y

ENTER NEW REAL VALUE
.0175

WICK TYPE CODE
1 = USER INPUT DATA
2 = SCREEN WICK
3 = SCREEN WITH ARTERIES
4 = SINTERED METAL
5 = SINTERED METAL WITH ARTERIES
6 = GROOVE

CHOICE OF WICK CODE 0
IF CHANGE, TYPE "Y", THEN PRESS ENTER
Y

ENTER NEW INTEGER VALUE
1

WICK PERMEABILITY*AREA, AK, m**4 .00000000
IF CHANGE, TYPE "Y", THEN PRESS ENTER
Y
ENTER NEW REAL VALUE
3.931E-14

VAPOR SPACE PERIMETER, PE, m .00000000
IF CHANGE, TYPE "Y", THEN PRESS ENTER
Y
ENTER NEW REAL VALUE
.04346

POROSITY OF WICK, PORE .00000000
IF CHANGE, TYPE "Y", THEN PRESS ENTER
Y
ENTER NEW REAL VALUE
.6107

EFF. WICK CONDUCTIVITY, KE, W/m K .00000000
IF CHANGE, TYPE "Y", THEN PRESS ENTER
Y
ENTER NEW REAL VALUE
44

EFFECTIVE VAPOR AREA, AV, m**2 .00000000
IF CHANGE, TYPE "Y", THEN PRESS ENTER
Y
ENTER NEW REAL VALUE
1.503E-4

EFF. MIN CAPILLARY RADIUS, RCM, m .00000000
IF CHANGE, TYPE "Y", THEN PRESS ENTER
Y
ENTER NEW REAL VALUE
3.683E-5

ENTRAINMENT DIMENSION, DWBR, m .00000000
IF CHANGE, TYPE "Y", THEN PRESS ENTER
Y
ENTER NEW REAL VALUE
3.683E-5

UNLESS WICK IS UNIFORM,
PROVIDE WICK THICKNESS FOR BOILING
LIMIT CALCULATION CALC, TWI, m .00000000
IF CHANGE, TYPE "Y", THEN PRESS ENTER

CRITICAL NUCLEATION RADIUS, RN, m .00000000
DEFAULT VALUE = 1.0E-6
IF CHANGE, TYPE "Y", THEN PRESS ENTER

TO REVIEW OR CORRECT THE DIAMETER AND WICK INPUT, TYPE "Y"

ALL WICKING, X-SECTION DIMENSIONS SAME AS THERMAL SECTION 1

MATERIAL CHOICE CODE

- 1 = STAINLESS STEEL 304
- 2 = TITANIUM
- 3 = IRON
- 4 = NICKEL
- 5 = ALUMINUM
- 6 = COPPER
- 7 = NIOBIUM-1&ZIRCONIUM
- 8 = TUNGSTEN
- 9 = INCONEL
- 10 = MOLYBDENUM
- 11 = TANTALUM
- 12 = BERYLLIUM

TYPE OF PIPE MATERIAL 0
IF CHANGE, TYPE "Y", THEN PRESS ENTER
Y

ENTER NEW INTEGER VALUE

1

TYPE OF WICK MATERIAL 0
IF CHANGE, TYPE "Y", THEN PRESS ENTER
Y

ENTER NEW INTEGER VALUE

1

FLUID TYPE CODE 0

- 1 = LITHIUM
- 2 = POTASSIUM
- 3 = SODIUM
- 4 = WATER
- 5 = AMMONIA
- 6 = METHANOL
- 7 = MERCURY
- 8 = DOWTHERM A
- 9 = ACETONE
- 10 = BENZENE
- 11 = CESIUM, NO DIMERS CONSIDERED
- 12 = FREON-11
- 13 = N-HEPTANE
- 14 = SILVER
- 15 = TOLUENE
- 16 = M-XYLENE

FLUID TYPE 0
IF CHANGE, TYPE "Y", THEN PRESS ENTER
Y

ENTER NEW INTEGER VALUE

3

WETTING ANGLE, DEG .00000000

IF CHANGE, TYPE "Y", THEN PRESS ENTER

WEBER CONSTANT, DEFAULT 2*PI, SEE INSTRUCTIONS 6.2831800

IF CHANGE, TYPE "Y", THEN PRESS ENTER

AVAILABLE CHOICES OF THERMAL CONDITIONS FOR SECTIONS

- 1 HEAT INPUT OR OUTPUT SPECIFIED IN SECTION
 - 2 ENVIRONMENT OR HEATER TEMPERATURE GIVEN IN SECTION
- CHOICE FOR SECTION # 1----->0

IF CHANGE, TYPE "Y", THEN PRESS ENTER
 Y
 ENTER NEW INTEGER VALUE
 2
 DIMENSIONS, PROPERTIES IN SECTION ARE CONSTANT
 IF CHANGE, TYPE "Y"

AXIAL LOCATION OF PIPE BEGINNING, m .00000000
 IF CHANGE, TYPE "Y", THEN PRESS ENTER

AXIAL LOCATION OF SECTION END, m .00000000
 IF CHANGE, TYPE "Y", THEN PRESS ENTER
 Y
 ENTER NEW REAL VALUE
 .2
 ENVIRONMENT OR HEATER TEMPERATURE, TENV, K .00000000
 IF CHANGE, TYPE "Y", THEN PRESS ENTER
 Y
 ENTER NEW REAL VALUE
 1680
 SPECIFIC AREA PER UNIT LENGTH, SA .00000000
 IF CHANGE, TYPE "Y", THEN PRESS ENTER
 Y
 ENTER NEW REAL VALUE
 .06
 RADIATION FACTOR RADK .00000000
 IF CHANGE, TYPE "Y", THEN PRESS ENTER
 Y
 ENTER NEW REAL VALUE
 .8
 CONVECTION COEFFICIENT HC, W/m**2 K .00000000
 IF CHANGE, TYPE "Y", THEN PRESS ENTER

AVAILABLE CHOICES OF THERMAL CONDITIONS FOR SECTIONS
 1 HEAT INPUT OR OUTPUT SPECIFIED IN SECTION
 2 ENVIRONMENT OR HEATER TEMPERATURE GIVEN IN SECTION
 CHOICE FOR SECTION # 2----->0
 IF CHANGE, TYPE "Y", THEN PRESS ENTER
 Y
 ENTER NEW INTEGER VALUE
 1
 HEAT IN OR OUT ALONG SECTION IS CONSTANT
 IF CHANGE, TYPE "Y"

AXIAL LOCATION OF SECTION END, m .00000000
 IF CHANGE, TYPE "Y", THEN PRESS ENTER
 Y
 ENTER NEW REAL VALUE
 .4
 HEAT INTO OR OUT OF SECTION, WATTS .00000000
 IF CHANGE, TYPE "Y", THEN PRESS ENTER

AVAILABLE CHOICES OF THERMAL CONDITIONS FOR SECTIONS
1 HEAT INPUT OR OUTPUT SPECIFIED IN SECTION
2 ENVIRONMENT OR HEATER TEMPERATURE GIVEN IN SECTION
CHOICE FOR SECTION # 3----->0

IF CHANGE, TYPE "Y", THEN PRESS ENTER

Y

ENTER NEW INTEGER VALUE

2

DIMENSIONS, PROPERTIES IN SECTION ARE CONSTANT

IF CHANGE, TYPE "Y"

AXIAL LOCATION OF SECTION END, m .00000000

IF CHANGE, TYPE "Y", THEN PRESS ENTER

Y

ENTER NEW REAL VALUE

1.4

ENVIRONMENT OR HEATER TEMPERATURE, TENV, K .00000000

IF CHANGE, TYPE "Y", THEN PRESS ENTER

Y

ENTER NEW REAL VALUE

273

SPECIFIC AREA PER UNIT LENGTH, SA .00000000

IF CHANGE, TYPE "Y", THEN PRESS ENTER

Y

ENTER NEW REAL VALUE

.15

RADIATION FACTOR RADK .00000000

IF CHANGE, TYPE "Y", THEN PRESS ENTER

Y

ENTER NEW REAL VALUE

.8

CONVECTION COEFFICIENT HC, W/m**2 K .00000000

IF CHANGE, TYPE "Y", THEN PRESS ENTER

TO REVIEW OR CORRECT MATERIALS, FLUIDS, THERMAL CONDITIONS, TYPE "Y"

APPENDIX D
EXAMPLE OF DATA OUTPUT

The printout of the solution computed for the data entered in the example of Appendix C is shown here. The option was chosen to print the variables at 14 stations along the pipe. Otherwise, only the summary appearing at the end of the listing and also on the screen, would have been obtained.

Some features of this solution should be noted. The capillary limit has been exceeded at the beginning of the evaporator, as noted by the printed advisory. However, the solution was not interrupted. The vertical distance from the gravitational horizon to the pipe centerline, HITE, shown in the output listing, differs slightly at some positions from the values entered. This is because the spline fit subroutine conveniently provided the first derivative of HITE to the Runge-Kutta subroutine. The result was integrated to reconstruct HITE for the printout.

The heater temperature of 1680 K, resulting in an evaporator upstream surface temperature of 958.58 K, was chosen to cause the pipe to operate very close to the so-called sonic limit. This is verified by the maximum mean Mach number of 0.88 occurring in the pipe at thermal equilibrium. While thermal convergence was found, the capillary limit was exceeded in this case.

During the execution of the code and before thermal equilibrium was attained, a condition was determined such that the pipe would have been choked at the end of the adiabatic section. In actuality, a different condenser length would have been required for this to represent a thermal equilibrium. However, the code saves the interim upstream temperatures and choking mean Mach number which resulted from this attempt. These data are printed out as "Sonic Limit During Iteration" for the benefit of the user. For the case in hand, the pipe upstream surface temperature T4E was listed as 958.3867 K. The mean Mach number, MACHM, at the end of the adiabatic section was computed as 1.032. Usually for this choking condition, the code will compute a value of MACHM between 0.98 and 1.0. Recall, however, that because of the velocity profile, a portion of the flow at this point will considerably exceed MACHM equal to 1.0. This may in part account for MACHM being slightly greater than 1.0 in some instances.

Negative absolute liquid pressures are computed for the evaporator end of the pipe. While this result seemingly violates common sense for many people, the phenomenon is accepted as a necessity in heat pipes. Indeed, unless it is permitted, the startup of a liquid metal pipe with frozen working fluid would not be possible. Anderson (ref. 17) discusses experimental evidence demonstrating the existence of negative liquid pressure. And indeed, Frenkel (ref. 18, p. 94, p. 345, p. 372) discussed this issue many years ago.

```
BEGIN PRINTOUT OF RESULTS
MENISCUS PRESS. DIFFERENCE
  P - PLTOP, N/m**2      =          9601.3490
CAPILLARY LIMIT PC, N/m**2 =      7353.5930
CAPILLARY LIMIT EXCEEDED

BEGIN SECTION # 1

Z=      .00000000
P=      7812.7800      PLBOT= -1680.6670      PLTOP= -1788.5680
T1Z=    929.48990      T4Z=   958.57760      TM=     929.48990
VM=     .00000000      MACHM= .00000000      A=     .59740120
DQDZ=  19587.300      Q=      .00000000      HITE=   .00000000

Z=      .10000000
P=      7313.7670      PLBOT= -1524.6280      PLTOP= -1632.6710
T1Z=    924.84720      T4Z=   954.01690      TM=     921.80040
VM=     134.22360      MACHM= .22000570      A=     .64038840
DQDZ=  19642.590      Q=      1960.3450      HITE=  -.26766010E-02
```

Z= .20000000
P= 4871.5950 PLBOT= -1038.6720 PLTOP= -1147.5780
T1Z= 897.29340 T4Z= 926.82070 TM= 873.43840
VM= 376.67570 MACHM= .64337280 A= .87930330
DQDZ= 19883.390 Q= 3932.8770 HITE= -.52349970E-02

BEGIN SECTION # 2

MENISCUS PRESS. DIFFERENCE

P - PLTOP, N/m**2 = 6019.1630
CAPILLARY LIMIT PC, N/m**2 = 7512.6960

Z= .20000000
P= 4871.5840 PLBOT= -1038.6720 PLTOP= -1147.5780
T1Z= 897.29340 T4Z= 897.29340 TM= 873.43840
VM= 376.67570 MACHM= .64337280 A= .87930330
DQDZ= .00000000 Q= 3932.8770 HITE= -.52349970E-02

Z= .30000000
P= 4371.7390 PLBOT= -352.70780 PLTOP= -461.79790
T1Z= 890.23000 T4Z= 890.23000 TM= 863.47980
VM= 414.27750 MACHM= .71311210 A= .87198000
DQDZ= .00000000 Q= 3932.8770 HITE= -.95980230E-02

Z= .40000000
P= 3490.8540 PLBOT= 350.80590 PLTOP= 241.31540
T1Z= 875.90630 T4Z= 875.90630 TM= 839.86690
VM= 500.58240 MACHM= .88015130 A= .94933270
DQDZ= .00000000 Q= 3932.8770 HITE= -.13899990E-01

BEGIN SECTION # 3

MENISCUS PRESS. DIFFERENCE

P - PLTOP, N/m**2 = 3249.5460
CAPILLARY LIMIT PC, N/m**2 = 7618.3830

Z= .40000000
P= 3490.8620 PLBOT= 350.80590 PLTOP= 241.31540
T1Z= 875.90630 T4Z= 869.76250 TM= 839.86690
VM= 500.58240 MACHM= .88015130 A= *****
DQDZ= -3896.7730 Q= 3932.8770 HITE= -.13899990E-01

Z= .50000000
P= 3640.5560 PLBOT= 1038.1430 PLTOP= 928.80030
T1Z= 878.54410 T4Z= 872.32920 TM= 853.62730
VM= 445.52690 MACHM= .76966710 A= *****
DQDZ= -3941.8850 Q= 3540.8200 HITE= -.20178860E-01

Z= .60000000
P= 3700.6900 PLBOT= 1659.0600 PLTOP= 1549.6820
T1Z= 879.57640 T4Z= 873.33070 TM= 865.70040
VM= 400.23580 MACHM= .68040580 A= *****
DQDZ= -3961.4090 Q= 3145.4320 HITE= -.26740980E-01

Z= .70000000
P= 3705.3040 PLBOT= 2194.3310 PLTOP= 2084.9200
T1Z= 879.65430 T4Z= 873.40590 TM= 878.08390
VM= 359.46460 MACHM= .60092310 A= *****
DQDZ= -3963.1390 Q= 2749.1390 HITE= -.31435100E-01

Z=	.80000010				
P=	3724.8700	PLBOT=	2659.1250	PLTOP=	2549.7080
T1Z=	879.98890	T4Z=	873.73190	TM=	879.98890
VM=	307.95690	MACHM=	.51358820	A=	*****
DQDZ=	-3968.6360	Q=	2352.6340	HITE=	-.36528270E-01
Z=	.90000010				
P=	3767.1060	PLBOT=	3055.9160	PLTOP=	2946.5070
T1Z=	880.70220	T4Z=	874.42540	TM=	880.70220
VM=	254.23020	MACHM=	.42385550	A=	*****
DQDZ=	-3981.1430	Q=	1955.1860	HITE=	-.40611610E-01
Z=	1.0000000				
P=	3827.2900	PLBOT=	3385.6500	PLTOP=	3276.2680
T1Z=	881.70670	T4Z=	875.40240	TM=	881.70670
VM=	200.54510	MACHM=	.33420570	A=	*****
DQDZ=	-3998.5990	Q=	1556.2760	HITE=	-.44489410E-01
Z=	1.1000000				
P=	3902.4400	PLBOT=	3647.5080	PLTOP=	3538.1370
T1Z=	882.94260	T4Z=	876.60270	TM=	882.94260
VM=	147.61030	MACHM=	.24585920	A=	*****
DQDZ=	-4021.1330	Q=	1155.2220	HITE=	-.48023650E-01
Z=	1.2000000				
P=	3954.7220	PLBOT=	3832.3960	PLTOP=	3723.0030
T1Z=	883.79040	T4Z=	877.42600	TM=	883.79040
VM=	96.850620	MACHM=	.16125510	A=	*****
DQDZ=	-4036.7070	Q=	752.27150	HITE=	-.50081220E-01
Z=	1.3000000				
P=	3985.8340	PLBOT=	3938.6730	PLTOP=	3829.2960
T1Z=	884.29040	T4Z=	877.91130	TM=	884.29040
VM=	47.421890	MACHM=	.78939840E-01	A=	*****
DQDZ=	-4046.0080	Q=	348.08240	HITE=	-.50654320E-01
Z=	1.4000000				
P=	3996.7320	PLBOT=	3996.7320	PLTOP=	3887.4810
T1Z=	884.47010	T4Z=	878.08050	TM=	884.45940
VM=	*****	MACHM=	*****	A=	*****
DQDZ=	-4049.2610	Q=	-.47906880E-01	HITE=	-.54160000E-01
TBOIL(1)	16.657040	DELTCR	2362.6180		

SUMMARY

THERMAL CONVERGENCE FOUND. RESULT MAY NOT BE VALID, CHECK LIMITS.

HEATER TEMPERATURE, K	1680.0000
EVAPORATOR UPSTREAM SURFACE TEMP, K	958.57760
EVAPORATOR UPSTREAM VAPOR TEMP, K	929.48990
CONDENSER DOWNSTREAM SURFACE TEMP, K	878.08050
CONDENSER DOWNSTREAM VAPOR TEMP, K	884.47010
TOTAL HEAT INPUT TO PIPE, WATTS	3932.8770
MAXIMUM MEAN MACH NUMBER IN PIPE	.88015130
WET POINT IS LOCATED AT Z =	1.4000000
MAXIMUM MENISCUS PRESS.DIFFERENCE	
P - PLTOP, n/m**2 =	9601.3490
CAPILLARY LIMIT PC,N/m**2	7353.5930

"SONIC LIMIT" DURING ITERATION WAS

ENCOUNTERED BEFORE THERMAL BALANCE WAS REACHED, WITH:

HEAT INPUT TO CHOKE PIPE, WATTS 3933.3570

AND THESE TEMPERATURES:

CHOKE POINT VAPOR TEMPERATURE, K 818.85210

EVAPORATOR UPSTREAM SURF. T4E, K 958.38670

MEAN MACH # AT CHOKING POINT 1.0323860

CAPILLARY LIMIT EXCEEDED. ARTERIES, OR FINER SCREEN AND PORES REQUIRED AT THIS
CONDITION

CASE FINISHED. BEGIN NEW ONE

APPENDIX E
VAPOR FLOW ALGORITHM

The vapor flow algorithm used in the code was first derived in reference 3 and repeated in reference 1. In the evaporator and adiabatic sections, the equations of reference 3 are employed in the present code. For the condenser, the code has been modified as described herein.

Condenser Section

If the profiles are plotted for the vapor-liquid interface temperatures TR and the mean vapor temperature TM, as computed by the laminar equations above, they would look somewhat like this in the condenser:

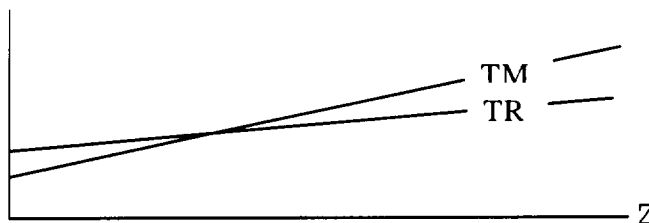

Because of heat rejection TM crosses TR at some point. If the solution using laminar equations (9), (14), and (15) of reference 1 is continued in the condenser beyond this point, TM continues to rise above TR. Beyond the crossover point, the result certainly is spurious because there is no way to unmix mathematically the vapor streams condensing on the wall in the same fashion that the vapors were mixed in the evaporator. For this reason the assumption is made, whether laminar or turbulent flow is assumed in the condenser, that beyond the crossover point TM and TR are equal. This couples TM to the local vapor pressure beyond the crossover.

Turbulent condenser option—No doubt turbulence will develop in the condenser. The user is given the option in the code of assuming condenser turbulence. Because of the possible droplet nucleation and other complications, the rate of turbulence onset is uncertain. For this reason the simplifying assumption is made in the code that the region between the condenser entrance and the crossover point where TM equals TR, is the zone of transition. The portion of the condenser beyond the crossover will be regarded herein as the turbulent zone.

Before proceeding, the phenomenon of inertial pressure recovery will be considered. As the vapor stream slows in the condenser, some of the kinetic energy is recovered as pressure. An unpublished correlation by Kemme, validated by experiment and used in reference 4, relates the pipe geometry to a factor by which the so-called inertial pressure at the condenser entrance must be multiplied to determine the pressure recovery. The recovery factor of Kemme is given in reference 4 as

$$REC = (-Re_{r,c} - 2.0) / [-1.23Re_{r,c} + (2L_e + 4L_a)/L_c] \quad 1$$

where the condenser radial Reynolds number is defined as

$$Re_{r,c} = \frac{dq_R}{dz} \frac{1}{2\pi\eta h_{vi}} \quad 2$$

and the L's refer to the lengths of the evaporator, adiabatic section, and condenser, respectively. Also, q_R is the heat flux into the vapor per unit area, η is dynamic viscosity, and h_{vi} is the heat of evaporation.

Turbulent zone—For the region in which fully developed turbulence is assumed, the momentum equation for flat front vapor flow with friction can be modified by Kemme's inertial pressure recovery factor REC to become

$$\frac{dp}{dz} = -(REC) \frac{d(\rho_m v_m^2)}{dz} - \frac{f \rho_m v_m^3}{R} \quad 3$$

where REC is Kemme's inertial pressure recovery factor and f is the friction factor. Also p is the mean pipe pressure, v_m is the mean vapor velocity and ρ_m is the mean vapor density, all at axial location z. The friction factors are defined as

$$f = 16/Rey \quad (Rey < 2000) \quad 4$$

$$f = 0.0791 Rey^{-2.5} \quad (2000 < Rey < 20000) \quad 5$$

$$f = 0.046 Rey^{-2.0} \quad (Rey > 20000) \quad 6$$

for the axial Reynolds number (Rey) ranges indicated (ref. 4.)

If the flat front momentum equation 3 above is solved for the pressure derivative using equation (7) and (8) of reference 1, and the Clausius-Clapeyron relation, the pressure derivative in the turbulent regime becomes:

$$\frac{d \ln p}{dz} = \frac{-REC \frac{\rho_m v_m^2}{p} \left(2 \frac{d \ln m}{dz} - 2 \frac{d \ln A_v}{dz} \right) - \frac{FT v_m}{p}}{1 - REC \frac{\rho_m v_m^2}{p} \left(GRP - \frac{GRT}{h_{vl}} \right)} \quad 7$$

where

$$FT = \frac{\rho_m v_m f}{R} \quad 8$$

Here, m is the axial mass flux and A_v is the vapor cross section area, both at axial position z. Variables GRP and GRT are defined in reference 1.

Transition zone—The artifice used in the present code to deal with the transition zone is as follows: The laminar flow equations developed above are used. The laminar friction factor in equation (9) of reference 1, (the term in η) is modified as follows: A simple fairing function is defined between the condenser beginning and the station where the laminar flow equations show that TM equals TR:

$$turbf = 1 - 3 TRM + 2 (TRM)^2 \quad 9$$

where

$$TRM = \frac{(TR - TM)}{(TR - TM)_0} \quad 10$$

The subscript 0 refers to the beginning of the condenser.

When the laminar equation (9) of reference 1 is solved, the viscous term in η is replaced by

$$FF = (1 - turbf) FF_1 + (turbf) FT \quad 11$$

where FF_1 is the term in η in equation (9) of reference 1 as shown above, with the turbulent f 's as shown in equations (4) to (6) above. The term in η in the centerline equation 16 of reference 1 is summarily set to zero. At the same time, all the terms in equations (9) and (15) of reference 1, representing the inertial terms of the momentum equation, are multiplied by the Kemme pressure recovery term REC.

When the laminar flow equations are used for the transition zone in the fashion outlined, existence and location of a crossover point for TM and TR are accounted for. Otherwise, the unrealistic assumption of full turbulence at the beginning of the condenser would have to be accepted.

Sequential condensers—If there are multiple condensers in series, only the last one is handled in the fashion outlined. For the previous ones, the laminar flow equations developed above are employed, and no turbulence is considered. In general, more than two condensers in series in a single pipe would seem unlikely.

Laminar condenser option—The user of the code is given the option of considering the entire condenser to be laminar. In this case, equations (9), (14), and (15) are employed up to the point of crossover of TM and TR. Beyond this point, only equations (9) and (15) are used with TM taken as the saturation pressure corresponding to the local pressure.



APPENDIX F HEAT PIPE WICK OPTIONS

References 11 and 13 discuss the parameters employed in specifying the wick options described herein.

Option 1 requests that the user provide the following information:

- (1) The product of wick permeability and wick cross-sectional area
- (2) The wick perimeter at the liquid-vapor interface
- (3) Porosity of the wick
- (4) Effective thermal conductivity of the liquid-filled wick
- (5) Axial vapor flow area
- (6) Effective capillary radius for pumping
- (7) Entrainment critical dimension
- (8) Minimum nucleation radius for boiling in the liquid

The data input example in Appendix C illustrates the information required for Option 1.

Option 2 for screen wick structures as shown in Figure 5 requires the following information:

- (1) Screen wire diameter
- (2) Space between screen wires
- (3) Crimping factor
- (4) Number of screen wraps

Option 3 for screen wicks with arteries requires the information from option 2 and the following:

- (1) Artery exterior diameter
- (2) Artery wall thickness
- (3) Number of arteries

Option 4 pertains to sintered metal wicks for which the following data must be specified:

- (1) Porosity of the wick
- (2) Effective radius of the wick particles
- (3) Experimentally determined thermal conductivity constant as discussed in reference 11. The values are 0.34 for metal felt or fiber and 0.53 for sintered powders.
- (4) Thickness of the wick

Option 5, used for sintered wicks with arteries, requires the following information in addition to that in Option 4:

- (1) Inside diameter of the artery
- (2) Number of arteries
- (3) Area of protrusion of each artery into the vapor space, reducing the vapor flow area as shown in figure 5.

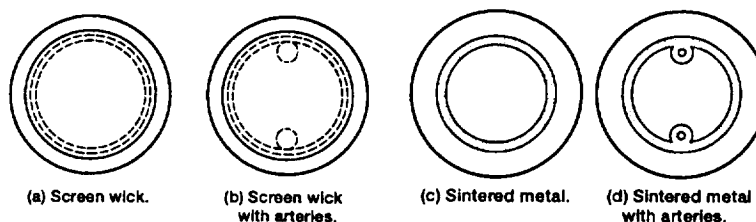

Figure 5.—Heat pipe wick structure options.



APPENDIX G HOW THE CODE WORKS

This section describes how the major subroutines interact to achieve a solution of a case which has been entered. The command LERCHP (or lerchp) calls Program LERCHP.EXE. This program summons subroutine INPUT. User interactive data input is controlled by this subroutine. An illustration of the data input is shown in example cases presented in Appendix C. An abbreviated flow diagram in figure 3 summarizes the discussion which follows.

When data input is completed, LERCHP then call subroutine RUNCAS which controls the running of the case which has been entered. RUNCAS calls subroutine GUESS. In GUESS, the heat pipe is envisioned as an isothermal bar with infinite axial conductivity. GUESS consults a tabulation containing a temperature at the approximate midpoint of the usable range of each working fluid to determine a starting temperature. GUESS calls subroutine SUMPIP to determine the heat input to the evaporator, either specified or computed, from the boundary conditions for radiation and/or conduction from heaters. The heat rejection is similarly computed from the specified boundary conditions between the condensers and the environment. GUESS iterates until the upstream evaporator surface temperature which matches heat input and output is found. If the evaporator upstream surface temperature T4E so determined is less than half that provided by GUESS at the outset, a warning that the working fluid or pipe dimensions appear inappropriate is given. If T4E is more than 80% of the critical temperature of the working fluid, as listed in subroutine CRITIC, the same warning is given. No radial wall temperature drops are considered yet.

RUNCAS then calls subroutine START, which initializes pipe wall, wick, and liquid temperatures at the upstream end of the evaporator to T4E for the first iteration throughout the pipe. The radial temperature drop between the pipe surface and the vapor-liquid interface is found by a call from START to subroutine THMRS2, which computes the thermal resistances through the pipe wall and wick to the interface.

The estimate of evaporator upstream surface temperature T4E, thus determined, is again checked by subroutine CRITIC to see that it does not exceed 80% of the working fluid critical temperature in which case some input condition must be changed. RUNCAS then successively calls subroutine SUMEP to iterate to a final computation of pressures and temperatures through the pipe. At the first iteration, the highest vapor Mach number at any point in the pipe is estimated. If this is less than 0.01, the incompressible vapor drop algorithm DLPINC is used. Otherwise, the compressible algorithm DLPTAD is employed. The point of transition from DLPTAD to DLPINC is smooth.

At each iteration, SUMEP calls a Runge-Kutta subroutine RUNGE (ref. 9) to integrate the vapor pressure and temperatures through the pipe using either DLPTAD or DLPINC. During this integration, subroutine CALSPL is called to provide local boundary conditions interpolated by spline fits, and subroutine THRMS2 is called to provide the local temperatures and heat transfer through the pipe wall and wick to sources and sinks. Thermodynamic and physical properties are recomputed within THMRS2. During the computations, possible entrainment, capillary failure, and boiling is flagged, but computation proceeds.

During the stepwise integration through the pipe, a condition of choke may be identified by SUMEP in the evaporator (or adiabatic section, if present). This condition is characterized during the computation by detection of one of two conditions: (1) the derivative of pressure with axial distance approaching negative infinity, $dP/dZ \rightarrow -\infty$, or (2) the vapor pressure gradient dP/dZ changing sign. When either of these situations is detected, control is returned to RUNCAS for another estimate of T4E. In the case of choke within the evaporator, the heat remaining to be transferred to the fluid beyond the choke point is computed. A derivative of the Busse or Levy sonic limit equations wherein $Q \sim (P\rho)^{1/2}$, with Q the transported heat and P and ρ the upstream vapor pressure and density, provides a first estimate of a new evaporator upstream surface temperature T4E. This moves the choke point on the next iteration toward the evaporator end. Successive increases in T4E are then made until the choke point is at the evaporator end where one dimensional flow theory permits it to occur. In the case of the adiabatic section, SUMEP is similarly called repeatedly to integrate through the pipe until the choke point is at the section downstream end. SUMEP then continues integrating to the end of the pipe or until all the available axial heat flux is exhausted, either case resulting in a normal return to RUNCAS.

After the normal return to RUNCAS, the deficit or excess of heat being transported axially at the condenser end of the pipe is noted. From this error a correction in the evaporator upstream surface temperature T4E is then computed by Newton-Raphson or by the secant method (ref. 19). SUMEP is called again and the procedure repeated until the axial heat flux at the downstream pipe end is less than 0.01% of the input heat.

In some cases, the vapor pressure computation in the last condenser section encounters a deficit of axial heat flux before the pipe end is reached. Accordingly, temperature T4E is dropped an appropriate amount. This lowers the condenser surface temperature, and consequently, the heat rejected. If this change in condition would result in choke being encountered before converging to thermal balance as described above, the viscous limit is deemed to have been encountered. The case is exited with a printed statement to this effect.

In another situation, choke may be indicated within the evaporator or adiabatic section, requiring an increase in temperature as described above. But this results in more heat being rejected from the pipe than has been specified as having been put in. This situation is also indicative of a viscous limit situation. An appropriate message is printed, and the case is exited.

One must note that heat pipes can operate within a viscous limit regime with the end cold. This situation is not representative of normal, desirable function for a heat pipe and can lead to freezing of working fluid in some situations. However, such a condition can exist as a transient during start up of a heat pipe.

On the other hand, if the input data of heat input, pipe dimensions, etc., are just right, the choke point may be found almost exactly at the end of an evaporator or adiabatic section while the thermal boundary conditions are met. In this case the pipe whose geometry is described by the input is truly at the "sonic limit", and a message to this effect will be printed. This is the only instance in the Lewis code in which the "sonic limit" will be so identified.

During the iterations to achieve thermal balance, SUMEP is also computing and storing the rise in liquid pressure along the pipe required to pump the liquid. Initially, the pressure at the evaporator upstream end is recorded as zero. In "G" field situations, the hydrostatic heads are also being incorporated. After convergence of the thermal iterations, the accumulated arrays of vapor and liquid pressures versus distance along the pipe are searched. The location of minimum difference between liquid and vapor is recorded as the wet point. Since in reality the liquid and vapor pressures must be nearly equal at this point, the entire record of liquid pressure versus distance is adjusted by this difference so that the pressure difference is zero at the wet point. Then the vapor-liquid pressure differences along the pipe, particularly at the upstream end, are compared to the capillary pumping capability of the wick. If the capillary limit is exceeded, a message is written to the effect "capillary limit exceeded" at the point it occurs when the output data are printed.

If the case being run results in a satisfactory solution being attained, the user is asked whether a printout of conditions along the length of the pipe is desired or not. If not, only a summary is printed.

In the execution of the code as described, axial heat conduction along the pipe wall is considered negligible as compared to the heat convected in the vapor stream. This could lead to error in some pipe configurations (very thick pipe wall, small vapor passage, small heat of evaporation of the working fluid, and these factors in combination). The neglect of axial heat conduction will result in step changes in surface wall temperature when passing from one section into another. To encumber the code with a cosmetic smoothed temperature change at such points would involve adding some sort of a finite difference computation of axial wall temperature. This has not yet been done.

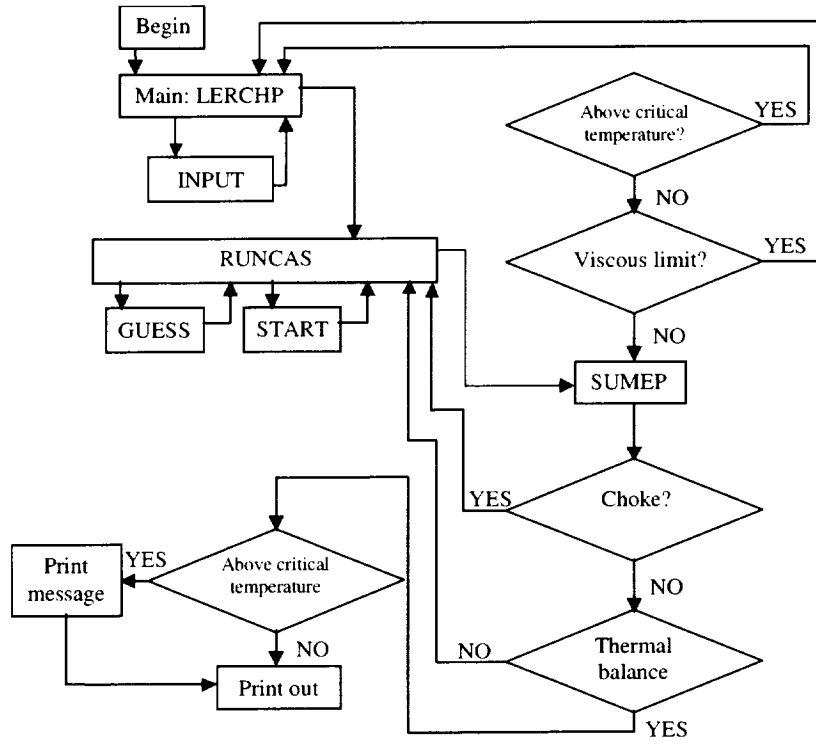
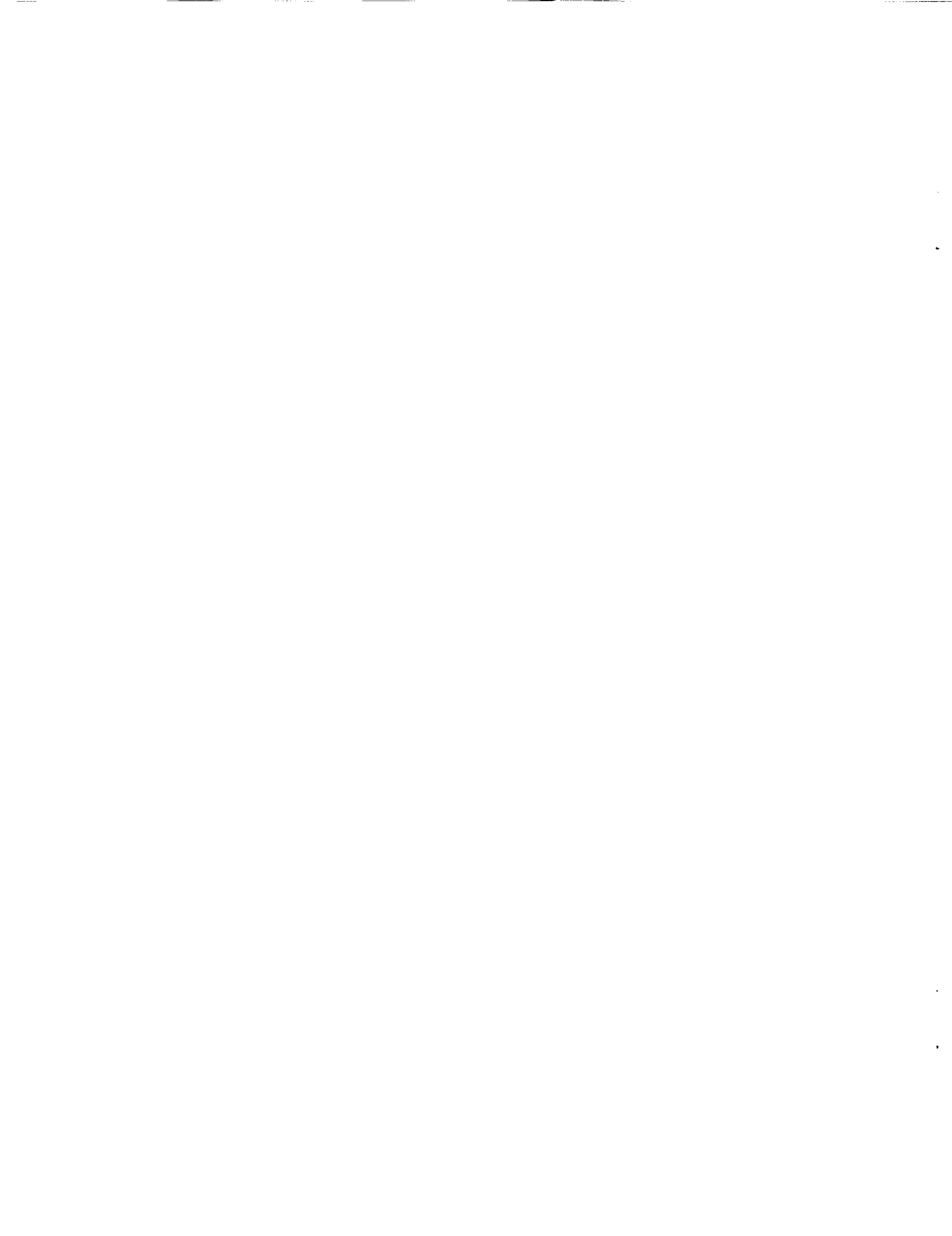

Figure 3.—Flow chart for NASA Lewis heat pipe code.



APPENDIX H HEAT PIPE LIMITS AND A LIMIT ENVELOPE

Development of a Limit Envelope—A limit envelope was generated for a series of heat pipes having dimensions and characteristics chosen specifically to facilitate the construction of the envelope. Some of these may not be encountered in normal practice depending on the fluid and geometry of the particular pipe being considered. The pipes had specifications as follows:

- Sodium working fluid
- Stainless steel tube
- Stainless steel screen
- Outer diameter DO, 0.0191 m
- Inside diameter DI, .0175 m
- Evaporator length 0.2 m
- Adiabatic length 0.2 m
- Screen wire wick 400 mesh in 2 layers on wall
 - wire diameter 2.54×10^{-5} m
 - wire spacing 3.81×10^{-5} m
- Single artery of rolled screen
 - outside artery diameter 1.6×10^{-3} m
 - artery wall thickness 1.27×10^{-4} m
- Dimension for nucleate boiling RN, 1.2×10^{-5} m

The radiating condenser was finned with condenser parameters as follows:

- Specific area SA, $0.15 \text{ m}^2/\text{m}$
- Radiation parameter RADK, 0.8

Straight pipe tilted 3° , evaporator above condenser

The envelopes (figures 1a and 1b), shown previously, were generated as follows. For sodium, condenser lengths from 0.6 to 1.65 meters were considered. The shortest, 0.6 m was a convenient starting point. A low evaporator heat input was tried, resulting in a message that since this was below the sonic limit, more heat was required. Accordingly, heat was increased in steps until the lowest heat input was found for which thermal balance was obtained between heat input and rejection enabling temperature data for the pipe to be output. In successive computations, power was incremented until an upper limit was reached, which for the 0.6 m condenser was the boiling limit. This procedure was repeated for successively longer condenser sections. In this case, the lowest limit was the viscous limit, in which vapor flow and heat transport ceased before the condenser end. Similarly, the upper bound became the capillary limit as condenser length increased. Figures 1a and 1b show the approximate ranges of the various limits. On the limit envelope plot are also shown the operating lines for some of the pipes when condenser length was fixed and the input heat was varied between the limit boundaries.

The limit envelope for lithium in a tungsten pipe of the same physical dimensions as for sodium as shown in figure 1b resembles that for sodium, figure 1a, but the temperature range is much greater. Also, the lowest attainable limit in this example was the viscous limit.

The sonic limits shown for sodium are close to those computed by the Busse equation (ref. 6) for the same operating conditions. The next subsection discusses this in more detail.

Busse Sonic and Viscous Limit Study—Equations derived by Busse (refs. 2 and 6) for the sonic and viscous limit are frequently displayed as part of the output data for heat pipe codes (ref. 4). Inasmuch as these equations may give different results from those available from LERCHP, an example has been specifically computed by LERCHP for comparison with Busse's equations. For the example a pipe having the dimensions listed above was studied. However, no adiabatic section was assumed as in the Busse derivation. With the following geometry

Evaporator length L_e 0.2 m
Condenser length L_c 1.23 m
Effective length L_{eff} 0.715 m
Vapor flow area A_v 2.33×10^{-4} m²
Wetted perimeter P_e 0.0594 m

these operating conditions were obtained:

Heat input Q 4480 W
Evaporator upstream vapor temperature 902.56 K

The physical parameters for the Busse equations are

Vapor density ρ_v 0.0176 kg/m³
Vapor pressure p 5275 N/m²
Evaporation heat h_{v1} 4.005×10^6 W/kg
Vapor viscosity μ_v 1.97×10^{-5} Ns/m²

The Busse equation for the sonic limit is

$$Q/A_v = 0.474h_{v1}(p\rho_v)^{1/2}$$

The Busse equation gives a sonic limit heat transport of 4293 W at the stated conditions as compared to the value of 4480 W from the code, a difference of only 4.3%.

REFERENCES

- 1 Tower, L.K.; Baker, K.W.; and Marks, T.S.: NASA Lewis Steady-State Heat Pipe Code Users Manual. NASA TM 105161, 1992.
2. Busse, C.A.: Pressure Drop in the Vapor Phase of Long Heat Pipes. IEEE Conference Record of the Thermionic Conversion Specialist Conference, IEEE, 1967, pp. 391–398.
3. Tower, L.K.; and Hainley, D.C.: An Improved Algorithm for the Modeling of Vapor Flow in Heat Pipes. NASA CR-185179, 1989.
4. Woloshun, K.; Merrigan, M.A.; and Best, E.D.: HTPPIPE: A Steady State Heat Pipe Analysis Program, A User's Manual. LA-11324-M, UC-405, 1988.
5. DeMichele, D.W.: The Numerical Solution to Axial Symmetric Compressible Flow With Mass Injection and Its Application to Heat Pipes. Ph.D. Thesis, University of Arizona, 1970.
6. Busse, C.A.: Theory of Ultimate Heat Transfer Limit of Cylindrical Heat Pipes. Inst. J. Heat and Mass Transfer. Vol.16, pp.169–186, 1973.
7. Levy, E.K.: Effects of Friction on the Sonic Velocity Limit in Sodium Heat Pipes. ASME Paper HPT-71-022.
8. Press, W.H., et al.: Numerical Recipes: The Art of Scientific Computing. Cambridge University Press, Cambridge, 1986.
9. White, F.M.: Viscous Fluid Flow. McGraw-Hill, 1974.
10. Bowman, W.J.: Simulated Heat Pipe Vapor Dynamics. Ph.D. Dissertation, Air Force Institute of Technology, Wright Patterson Air Force Base, OH, 1987. (Avail. NTIS, AD-A182592.)
11. Dunn, P.; and Reay, D.A.: Heat Pipes. Third Ed., Pergamon Press, 1982.
12. McBride, B.J.; and Gordon, S.: FORTRAN IV Program for Calculation of Thermodynamic Data, NASA TN D-4097, 1967.
13. Brennan, P.J.; and Kroliczek, E.J.: Heat Pipe Design Handbook, Vols. 1 and 2, B & K Engineering, Inc., NTIS n81-700113, 1979.
14. Weast, R.C., ed.: CRC Handbook of Chemistry and Physics. 67th ed., CRC Press Inc., 1986.
15. Achener, P.Y., et al.: Thermophysical and Heat Transfer Properties of Alkali Metals. AGN-8195, Vol. 1, Aerojet-General Nucleonics, San Ramon, CA, 1968.
16. Boyer, H.E.; and Gall, T.L.: Metals Handbook. Desk Edition, American Society for Metals, 1985.
17. Anderson, W.G.: Negative Pressures in Alkali Metal Heat Pipes. AIAA Paper 93-3904, 1993.
18. Frenkel, J.: Kinetic Theory of Liquids. Dover Publications, 1955.
19. Gerald, C.F.: Applied Numerical Analysis, Second Edition. Addison-Wesley Publishing Company, 1978.

REPORT DOCUMENTATION PAGE

Form Approved
OMB No. 0704-0188

Public reporting burden for this collection of information is estimated to average 1 hour per response, including the time for reviewing instructions, searching existing data sources, gathering and maintaining the data needed, and completing and reviewing the collection of information. Send comments regarding this burden estimate or any other aspect of this collection of information, including suggestions for reducing this burden, to Washington Headquarters Services, Directorate for Information Operations and Reports, 1215 Jefferson Davis Highway, Suite 1204, Arlington, VA 22202-4302, and to the Office of Management and Budget, Paperwork Reduction Project (0704-0188), Washington, DC 20503.

1. AGENCY USE ONLY (Leave blank)		2. REPORT DATE April 2000	3. REPORT TYPE AND DATES COVERED Technical Memorandum	
4. TITLE AND SUBTITLE NASA Glenn Steady-State Heat Pipe Code Users Manual Version 2, DOS Input			5. FUNDING NUMBERS WU-839-20-00-00	
6. AUTHOR(S) Leonard K. Tower				
7. PERFORMING ORGANIZATION NAME(S) AND ADDRESS(ES) National Aeronautics and Space Administration John H. Glenn Research Center at Lewis Field Cleveland, Ohio 44135-3191			8. PERFORMING ORGANIZATION REPORT NUMBER E-12113	
9. SPONSORING/MONITORING AGENCY NAME(S) AND ADDRESS(ES) National Aeronautics and Space Administration Washington, DC 20546-0001			10. SPONSORING/MONITORING AGENCY REPORT NUMBER NASA TM-2000-209807	
11. SUPPLEMENTARY NOTES Responsible person, Eric Golliher, organization code 5490, (216) 433-6575. Contact for diskette of executable file and any information on errors and updates.				
12a. DISTRIBUTION/AVAILABILITY STATEMENT Unclassified - Unlimited Subject Categories: 34 and 37 This publication is available from the NASA Center for AeroSpace Information, (301) 621-0390.			12b. DISTRIBUTION CODE Distribution: Nonstandard	
13. ABSTRACT (Maximum 200 words) The heat pipe code LERCHP has been revised, corrected, and extended. New features include provisions for pipes with curvature and bends in "G" fields. Heat pipe limits are examined in detail and limit envelopes are shown for some sodium and lithium-filled heat pipes. Refluxing heat pipes and gas-loaded or variable conductance heat pipes were not considered.				
14. SUBJECT TERMS Heat pipe code; Heat pipe; Heat transmission; Heat transfer			15. NUMBER OF PAGES 43	
			16. PRICE CODE A03	
17. SECURITY CLASSIFICATION OF REPORT Unclassified	18. SECURITY CLASSIFICATION OF THIS PAGE Unclassified	19. SECURITY CLASSIFICATION OF ABSTRACT Unclassified	20. LIMITATION OF ABSTRACT	