

# **A Cryogenic Propellant Production Depot for Low Earth Orbit**

International Space Development Conference

Albuquerque, NM, 24-28 May 2001

Seth D. Potter  
Mark W. Henley  
Sonia Gutierrez  
The Boeing Company  
Huntington Beach, CA

John Fikes  
Connie Carrington  
David Smitherman  
Mark Gerry  
NASA Marshall Space  
Flight Center  
Huntsville, AL

Steve Sutherlin  
Phil Beason  
Sverdrup Technologies  
Huntsville, AL

## **ABSTRACT**

The cost of access to space beyond low Earth orbit can be lowered if vehicles can refuel in orbit. The power requirements for a propellant depot that electrolyzes water and stores cryogenic oxygen and hydrogen can be met using technology developed for space solar power.

A propellant depot is described that will be deployed in a 400 km circular equatorial orbit, receive tanks of water launched into a lower orbit from Earth by gun launch or reusable launch vehicle, convert the water to liquid hydrogen and oxygen, and store up to 500 metric tonnes of cryogenic propellants. The propellant stored in the depot can support transportation from low Earth orbit to geostationary Earth orbit, the Moon, LaGrange points, Mars, etc. The tanks are configured in an in-line gravity-gradient configuration to minimize drag and settle the propellant. Temperatures can be maintained by body-mounted radiators; these will also provide some shielding against orbital debris. Power is supplied by a pair of solar arrays mounted perpendicular to the orbital plane, which rotate once per orbit to track the Sun.

In the longer term, cryogenic propellant production technology can be applied to a larger LEO depot, as well as to the use of lunar water resources at a similar depot elsewhere.

## **INTRODUCTION**

The cost of access to space beyond low Earth orbit can be lowered if space vehicles can be refueled at a Propellant Depot that receives water and uses solar power to convert water into liquid hydrogen and oxygen (LH<sub>2</sub> and LOX), then stores and transfers these cryogenic propellants. The basic concept for production of LH<sub>2</sub> and LOX is through an electrolysis process commonly used in fuel cells. The process "cracks" the water to form hydrogen and oxygen gas, which is then refrigerated at cryogenic temperatures to convert it into liquid propellants. It is expected that such a depot can be deployed in approximately the year 2015. In the nearer-term, a Propellant Depot that only receives, stores, and transfers cryogenic propellants can demonstrate the technology required in a space environment.

The first of these types of Propellant Depot will be emphasized in this paper. It is more complex, requiring significant advances in technology, but it avoids the large volume and safety issues related to containment of cryogenic propellants during launch. Water, in the form of liquid or ice, takes up one third of the volume that would be needed to contain the same mass of liquid hydrogen and oxygen.

Cryogenic propellants are hazardous; hydrogen is extremely volatile and flammable, and liquid oxygen is a very powerful chemical oxidizer. Water, in contrast, is chemically inert. As an incompressible liquid, or as solid ice, water can also sustain high payload accelerations during launch. Future high velocity projectile launch systems could potentially accelerate capsules of water, at several hundred g, to reach orbital velocity. Repeated launches of such a system could potentially transport large masses of water into orbit at a much lower cost than conventional space transportation systems.

In addition, a Propellant Depot that converts water into propellants could serve other future NASA and commercial needs:

- The production concept follows science exploration goals for “following the water”. Finding water in the solar system means there is a chance at finding life and sustaining human life. Development of such depot technology will enable sustainable human missions at any location where water can be found, (i.e., the Moon, Mars, Europa, etc.).
- This baseline concept is for a cryogen production facility in low-Earth-orbit designed to supply human, robotic, and commercial missions with liquid hydrogen (LH<sub>2</sub>), and liquid oxygen (LOX) for high thrust chemical engines, LH<sub>2</sub> for solar thermal propulsion, and excess LOX for human habitation at other stations.
- Production capabilities would enable new commercial markets for reusable high-energy upper stages, satellite services, and water and oxygen for ongoing human operations.

## SYSTEM REQUIREMENTS

The Water-Ice to Cryogen propellant production facility requires a very high power system for “cracking” (electrolyzing) the water and condensing and refrigerating the resulting oxygen and hydrogen. For a propellant production rate of 500 metric tons (1,100,000 pounds) per year, an average electrical power supply of 380 kWe was required. To make the most efficient use of space solar power, electrolysis was performed only during the portion of the orbit that the Depot was in sunlight, so roughly twice this power level was needed for operations in sunlight (slightly over half of the time). This power level mandated large solar arrays, using advanced Space Solar Power technology. A significant amount of this power had to be dissipated as heat, through large radiators.

The propellant state at launch was ground-ruled to be either water (in the form of liquid or ice) or cryogenic propellants. Considering the unknown ascent heating loads and unknown time in orbit before reaching the depot, it was assumed that water was received at the depot as a liquid (with a temperature at the melting point of 273 K). This appears to be a conservative assumption, for if water was received in the form of solid ice, a heat exchanger could make use of the “heat of fusion” (energy absorbed as ice melts) to reduce electrical power and radiator surface area requirements of the Propellant Production Depot. Cryogenic propellants were assumed to be near their normal boiling point at sea level atmospheric pressure, rather than being sub-cooled (which would make them less subject to boil-off during launch and transfer).

Depot oxidizer to fuel (O:F) mass ratios were a consequence of the propellant state (water or cryogen) at launch. The O:F ratio inherent in water is approximately eight to one (8:1), as each molecule of water contains one atom of oxygen, with an atomic weight of 16 and two atoms of hydrogen, each with an atomic weight of 1. An O:F ratio of roughly 6:1 is normally used for chemical H<sub>2</sub>:O<sub>2</sub> propulsion. The Propellant Production Depot is thus expected to produce surplus oxygen gas, which could be vented or could potentially be used for industrial space processes, cold gas station-keeping propellant,

or for human life support (breathing). For this study, the Propellant Production Depot was assumed to liquefy all of the oxygen, and store LOX and LH2 at the 8:1 O:F ratio, whereas the Cryogen Storage Only Depot was assumed to store LOX and LH2 at the 6:1 O:F ratio.

Propellant quantity requirements are determined by Propellant Depot Mission Requirements. Prospective Depot-supported missions are illustrated below in Figure 1. The Depot refuels Orbital Maneuvering Vehicles (OMVs) for maneuvers in LEO, such as satellite and payload transfers, satellite servicing and orbital debris removal. The Depot also refuels Orbital Transfer Vehicles (OTVs) for transfer of payloads between LEO and more distant orbits, such as commercial and government missions to geosynchronous Earth orbit (GEO), science and exploration missions to the Moon, and large telescope delivery to the Earth/Sun L2 LaGrange point.

- Refuel OMVs for transfers in LEO
- Refuel OTVs for transfers to GEO
- Refuel OTVs for L2 and Lunar missions

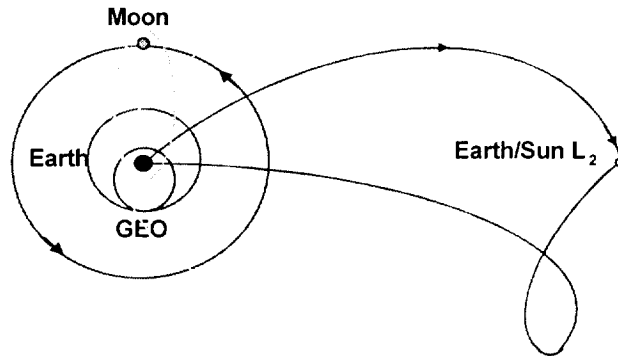

- Propellant for Mars Missions
- Commercial Missions
  - Satellite transfers
  - Satellite servicing
  - Orbital debris re

Mars

Depot propellant will also be required to support Mars missions, the most demanding of which is an all-propulsive (Abundant Chemical Propulsion Stage) mission, expected to require roughly 1,000,000 kg of propellant. While this enormous quantity may be reduced in alternate Mars mission scenarios, this requirement was considered in Propellant Production

**Figure 1. Propellant quantity requirements are determined by Depot Mission Requirements.**

Depot sizing. As the Mars Hohmann Transfer departure window occurs every 2.2 years, approximately 450,000 kg of cryogenic propellant would need to be produced each year to support this mission. For our purposes, the round number of 500,000 kg of was established as a requirement for propellant production per year. As the Mars Transfer Vehicle would be assembled on orbit in advance of the mission, and it could store some of its cryogenic propellant, prior to launch our Propellant Production Depot storage requirement was assumed to be the 500,000 kg of cryogenes produced in one full year of operations.

Considering that a 6:1 O:F ratio is generally used for Oxygen: Hydrogen propulsion; in contrast to the 8:1 O:F ratio for the Propellant Production Depot (PPD), the Cryogen Storage-Only Depot (CSOD) requires a smaller quantity of propellant (the same amount of hydrogen, but less oxygen) to support the same mission model. The corresponding mass of propellant for a 6:1 O:F ratio depot is calculated using the formula:

$$M_{CSOD} = (6 \text{ parts O}_2 + 1 \text{ part H}_2) / (8 \text{ parts O}_2 + 1 \text{ part H}_2) \times M_{PPD} = 7/9 \times 500,000 \text{ kg} = 389,000 \text{ kg}$$

In-orbit assembly requirements were considered concurrently with analyses of propellant tank size and launch options. The Propellant Production Depot was baselined to use eight (8) tank-sets, each

holding 50,000 kg of propellant, whereas the Cryogen Storage Only Depot was baselined to use two (2) tank-sets, each holding 195,000 kg of propellant. Automated on-orbit assembly is assumed to be required for the Propellant Production Depot, as its large systems cannot be launched together and requirements for manned (EVA) assembly or telerobotic assembly would tend to make the systems heavy and expensive. The assembly approach is one of automated docking of system elements, with prescribed interfaces for power and fluid transfer between the various elements. The cryogenic storage-only depot is compact enough that two tank-sets can be launched together as a unit; thus it does not require assembly in orbit.

Propellant tank size was derived based upon the propellant quantity and diameter of available cryogenic propellant tank tooling. In general, because the quantities of propellant are large, large diameter tanks are desired to minimize surface area (heat influx) and mass. The Space Shuttle External Tank (ET) diameter (8 meters) was considered, but the full ET volume was too large for this application, and no practical way was evident to carry shorter ET-derived tanks into orbit. The 5 meter (200 inch) diameter cryogenic oxygen and hydrogen tanks being developed for the Delta IV expendable launch vehicle (ELV) was next in size, and could be launched directly into orbit (see section 1.5). Corresponding propellant tank-set lengths of 12 meters for the Propellant Production Depot, and 30 meters for the Cryogenic Storage-Only Depot were calculated based upon the required propellant mass and volume requirements were calculated reserving some volume (5%) for ullage gas and assuming reasonable separations between tanks.

Depot launches, carrying 5 meter diameter propellant tanks to orbit, were made feasible by using the depot tanks to hold propellants for launch to the final orbit (where they arrive nearly empty). It is assumed that, in the time frame of depot operations, a launch site will be available at the latitude necessary for launching directly into the chosen depot orbit inclination. Depot tank-sets, with an engine, launch in place of a standard Delta IV Heavy cryogenic upper stage. The payload volume, above the full (upper stage) tank-set, is occupied by an additional (empty) tank-set. Other components of the Propellant Production Depot launch using standard Delta IV Heavy ELVs. The total number of launches required is seven. The Cryogenic Storage-Only Depot uses larger tanksets, but because there are only two of them, it may be possible to place the entire depot into orbit in one launch, provided that one (or both) of the two large tank-sets carries propellant for launch.

Orbit altitude was selected to be 400 km circular, based on a preliminary analysis that balanced propellant requirements with atmospheric drag. The altitude is high enough that the Depot in the absence of on-board propulsion, would not re-enter the atmosphere in less than two months, even in the worst (2 sigma) case of solar activity (which increases the thickness of upper atmosphere). A relatively low orbit altitude is desired to minimize the propellant used in OMV retrieval of water payloads or in RLV transportation of cryogenics directly from Earth to the Depot.

An Equatorial orbit inclination was baselined for both types of Depot because of inherent launch and orbit transfer performance benefits, and other advantages. Equatorial orbit offers benefits for conventional launch, from a launch facility on the Equator, including a slight decrease in energy required to reach orbit, large expanses of ocean downrange (for range safety) and a launch opportunity every orbit (about every 1.5 hours). For launch of water payloads using a rail-gun or gas-gun, along a fixed track, an equatorial inclination is essential, as it allows transportation of sixteen payloads into orbit every day (16/day), as opposed to one per day (1/day) for any other orbit inclination. For OTV transportation between the Depot, in an equatorial inclination, and geostationary orbit (GEO, also in an equatorial inclination) the delta V for GEO circularization is reduced substantially. (The required

GEO circularization velocity for an OTV departing from a Depot at 0 degrees inclination is about 1 km/s less than that for an OTV departing from the ISS inclination of 51.6 degrees, or about 300 m/s less than that for an OTV departing from 28.5 degrees).

Depot propulsion propellant requirements are relatively small, compared to the large masses of propellant stored in the Depot for other uses. The LH<sub>2</sub> and LOX stored on the depot can be used for chemical propulsion in a periodic re-boost strategy. For the Propellant Production Depot, with plenty of excess electrical power, continuous, low thrust solar electric propulsion (SEP) for drag make-up would require even less propellant, in the form of xenon/krypton. Another alternative for this type of depot would be to use the excess O<sub>2</sub> as a cold-gas (or potentially, heated gas) propellant. In the case of the Cryogen Storage-Only Depot, H<sub>2</sub> is allowed to boil off, without active refrigeration, and this excess gas can be used for cold-gas (or hot-gas) propulsion. Notably, the heat flux and H<sub>2</sub> boiloff rate is higher on the sunlit side of the orbit, when atmospheric drag is also higher, which is when propulsion is needed.

Electrical power requirements were derived for the Propellant Production Depot considering that roughly 500 metric tons of propellant would have to be processed per year. If the conversion process were continuous, this rate would equate to 15.87 grams per second, however the system is simpler and more efficient when electrical power is used for conversion only during the sunlit portion of the orbit. The 400 km equatorial orbit is in sunlight 61.5% of the time, thus the system must convert water at a rate of 25.8 grams per second while it is in sunlight ( $15.87 \text{ g/s} / 0.615 = 25.8 \text{ g/s}$ ).

Power requirements for this process depend upon design details, but, for our design concept, they are separable into the power requirements for electrolysis (482 kWe), for the hydrogen refrigerator's compressor (55 kWe), and for the oxygen refrigerator's compressor (78 kWe). These major contributors combine to form the basic electrical power requirement for propellant production (617 kWe). To account for power management and distribution losses, potential growth, and other systems which will use relatively small power levels (communications and data handling, electric propulsion, etc.) a margin of 15% was added, to reach a total power requirement of 708 kWe while the Propellant Production Depot is in sunlight.

For the Cryogen Storage-Only Depot, the electrical power requirements are much lower. These requirements depend upon design details, and were not assessed in detail.

Solar array area requirements for the Propellant Production Depot are estimated assuming that NASA's SERT (Space Solar Power Exploratory Research and Technology) program matures related technology sufficiently that an efficiency of 40% will be possible by the year 2015, when the Depot is launched. Considering a slight offset of array pointing, the area required to supply 708 kWe is approximately 1,660 square meters. For the Cryogen Storage-Only Depot, we surmise that solar array area requirements are small enough that body-mounted solar arrays will be sufficient to supply electrical power for this type of depot.

For the Cryogen Storage-Only Depot, body-mounted solar arrays are integrated on the East- and West-facing surfaces of selected rigid structures, and solar array orientation is determined by Depot orientation. In equatorial orbit, the East-facing surface generates power for roughly 20 minutes at the beginning of the orbit's passage into sunlight. Similarly, the West-facing surface generates power for about 20 minutes towards the end of the orbit's passage through sunlight.

Depot orientation was selected through design trades to be fixed with respect to local vertical and the local cardinal points (North South, East and West), using gravity gradient stabilization. The primary reason for is that gravity gradient induced accelerations are sufficient to settle the propellants in large diameter tanks at moderate distances from the center of mass.

Radiator area requirements were derived for the Propellant Production Depot based upon heat rejection from the propellant production process and other heat generating sub-systems. To reject a total of 290 kWt in thermal energy, a radiator area of 1,560 square meters was needed, with both sides free to radiate. Body-mounted arrays were selected to avoid the complexity of passing working fluids through rotating joints, so only one side of each radiator was free to radiate, thus the area requirement doubled (3,120 m<sup>2</sup>).

Radiator orientation for the Propellant Production Depot, with body-mounted radiators, is on the North- and South-facing surfaces, which never are exposed to direct sunlight at high angles of incidence. In the selected Propellant Production Depot design concept, these surfaces offer a large area for body-mounting. The radiators in this orientation also provide some added protection against orbital debris penetration of the tankage.

Propellant launch system analyses included options to send a payload from Earth into a low altitude orbit, and an Orbital Maneuvering Vehicle (OMV) to carry the launch system’s payload from an initial orbit to the Depot. A variety of water delivery methods are possible, depending on the time frame and technology development level for the various systems. For the Propellant Production Depot, water delivery systems could include reusable launch vehicles (RLVs) and gun launch methods (see Figure 2).

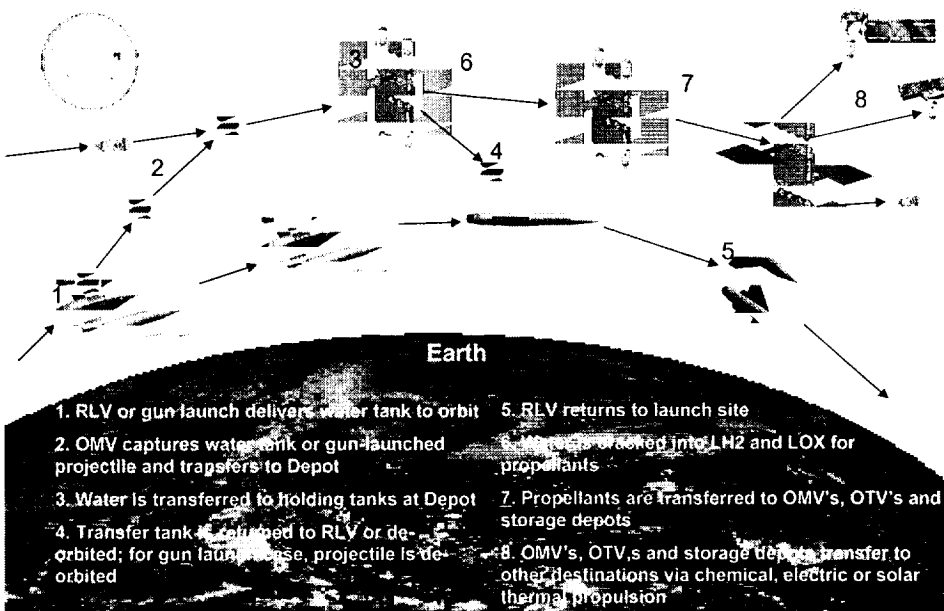

The RLV architecture consists of eight steps from beginning to end. First the RLV delivers a water- or ice-filled tank to an orbit lower than the Depot (nominally 200 km). At 200 km, an OMV captures the RLV’s payload and then maneuvers it to the Propellant Depot. Water is then transferred to holding tanks on the depot. The transferring tank is returned to the RLV or is de-orbited and the RLV returns to its launch site. Water is then converted into LH2 and LOX for propellants. Finally, OMVs and OTVs transfer to other destinations using this propellant.

Figure 2. Water/ice launch architecture for Propellant Production Depot using RLV or Gun Launch

LOX propellants, which are then transferred to OMVs and OTVs and. Finally, OMVs and OTVs transfer to other destinations using this propellant.

Using an RLV, it is anticipated that over 35,000 kg of water would be delivered per launch, requiring roughly 15 launches per year to maintain a baseline propellant production rate of approximately 500,000 kg per year. The OMV propellant requirement is estimated to be 1,266 kg per round trip. OMV propellant analysis by Craig Cruzen of NASA MSFC is included as an appendix to this report. The RLV's large mass is not required to be transported to the Depot orbit and back, and there is no requirement for RLV docking at the Depot.

The Gun-Launch Architecture will complete its mission in six steps. The gun delivers a water projectile to orbit where an OMV captures the projectile and delivers it to the depot. Water is then pulled from the projectile and cracked into LH<sub>2</sub> and LOX propellants. Water projectile is then de-orbited and propellants are transferred to OMVs and OTVs. The OMVs and OTVs then transfer to other destinations.

Several gun launch concepts have been considered, including blast wave, "slingatron", and electromagnetic methods. Each delivery method uses an ice filled projectile with a circularization stage. The projectiles measure approximately 1m in diameter by 10m in length and contain 250 kg to 500 kg of water-ice, which would require 1000-2000 launches per year (i.e., roughly 3-6 launches per day), to meet the Depot's 500,000 kg per year requirement, excluding any propellant required for OMV operations.

Each projectile is launched to a target orbit at 25 km to 75 km below the depot. It is required to have on-board propulsion for an apogee burn to circularize the orbit altitude. A reusable OMV performs rendezvous maneuvers to collect projectiles and deliver them to the depot. The water-ice in the projectile is heated and pumped into storage tanks on the depot.

Six to nine OMVs are required to deliver 4 to 8 projectiles per day to the depot to maintain a 2000 kg per day accumulation rate. About 25% of the water will be required for use as cryogenic propellants to fuel the OMVs. The remaining 75% will be accumulated at the depot for cryogen production, storage, and delivery to other vehicles.

## SYSTEM DESIGNS

### Platform Trade Studies

Several alternative concepts were considered for propellant settling, including rotating, solar inertial, and gravity-gradient facilities. These general approaches are illustrated in Figure 3.

The rotating depot consists of two, three, or more tanks arranged in a spoke-like fashion that rotate around a central hub to generate g-force through a centrifugal effect. It therefore does not need the presence of a planetary gravitational field for propellant settling. However, it requires a de-spin docking port.

The gravity gradient depot utilizes the change in a planet's gravity with altitude for stabilization and propellant settling. As a gravity gradient oriented depot orbit rotates (once per orbit, while keeping the same orientation with respect to the Earth) roughly one third of the "gravity gradient force" is actually due to system rotation. Docking can take place at the ends or center.

A solar inertial depot maintains a fixed orientation with respect to the sun. Its advantage is that it does not require alpha/beta joints for its solar arrays to track the sun. Its disadvantage is that it requires zero-g cryogenic propellant acquisition, a technology that has been studied extensively, but has not yet been demonstrated in space.

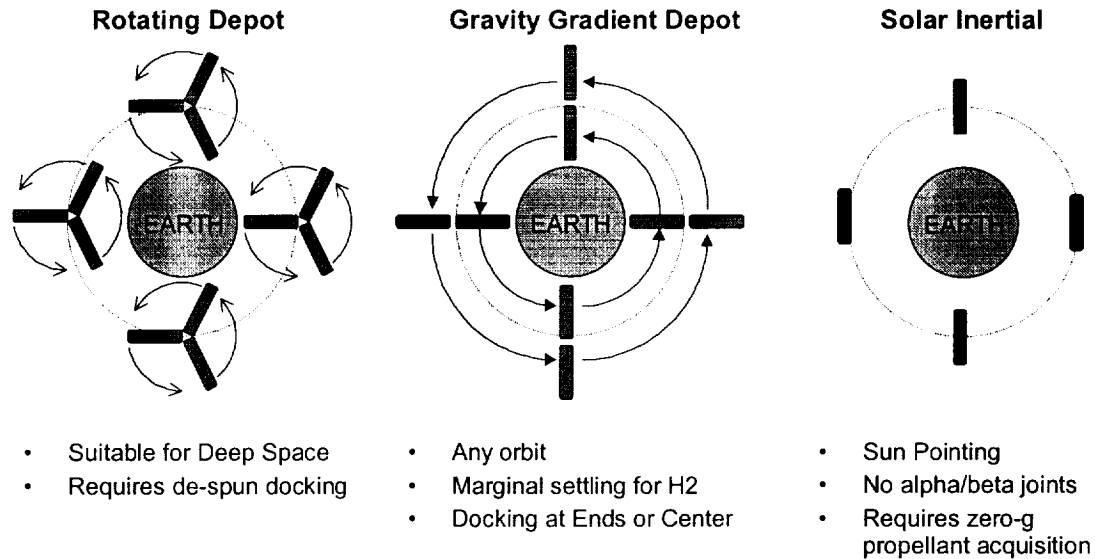

**Figure 3. Several approaches were considered for cryogenic propellant settling.**

### **Propellant Production Depot System Design Overview**

The Propellant Production Depot system design configuration is illustrated in Figure 4. Its gravity gradient configuration allows for propellant settling, while the in-line configuration minimizes drag. Seven key subsystems are called out in this illustration. LOX/LH<sub>2</sub> storage tank sets are mounted in eight locations, and each contains docking port for Orbital Transfer Vehicle propellant transfer. Radiators are mounted flush with the tanks, which also minimizes drag. The solar arrays rotate once per orbit to track the sun. Two docking ports are provided for orbital maneuvering vehicles to transfer water on the central structure, which also contains water storage tanks and an electrolysis system.

Because this Depot is assumed to become an operational in the year 2015, it is designed to use many of the Space Solar Power technology advancements that are planned over the next decade. The system is expected to utilize SSP-related advancements in the areas of solar power generation, power management and distribution (PMAD), advanced structures, robotics, and propulsion. The power system is sized with two large “abacus”-type arrays that produce over 700 kilowatts of power at 150 volts. As the arrays rotate with respect to the gravity-gradient-oriented part of the system, this power is transferred across slip rings. Advanced inflatable structures are used on the solar array and advanced composites are used in other supporting structures. Robotic operations are anticipated for assembly, vehicle docking, propellant transfer, and maintenance functions. Solar-electric propulsion and control moment gyros are shown as the choices for controlling the altitude and attitude of the Propellant Production Depot. The total dry mass of the Propellant Production Depot using the technologies considered here is about 69 metric tonnes, as shown in Table 1. Many of these subsystem technology choices could be revisited in further study.



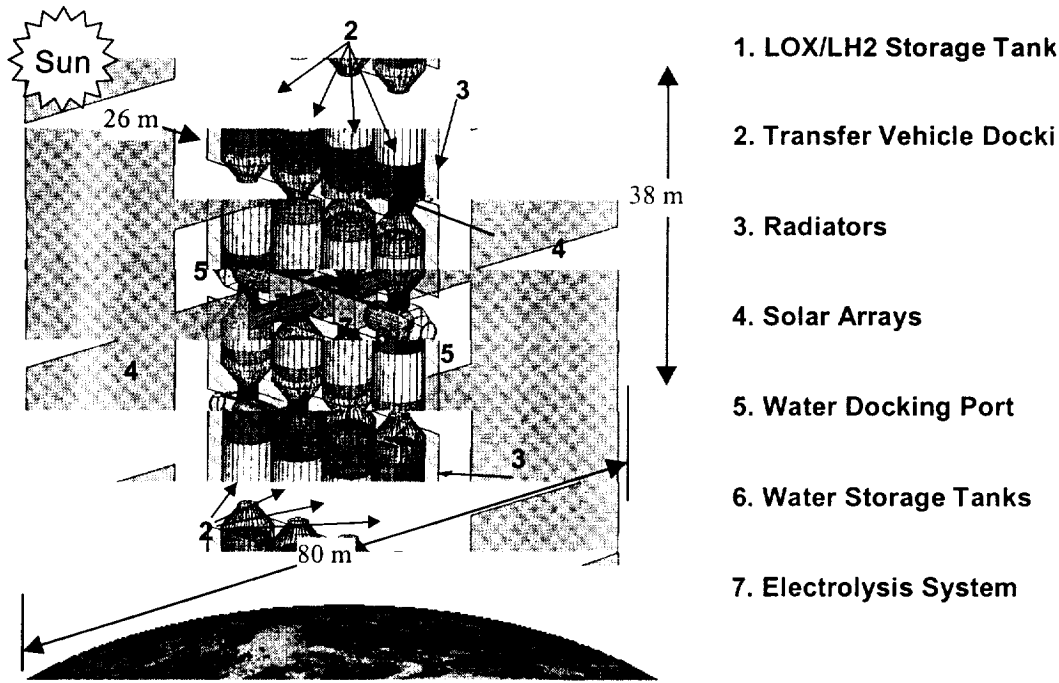

Figure 4. The Propellant Production Depot design includes seven key subsystems.

System Element	Mass (MT)	Comments
Electrolysis Conversion		Devices, Structure; Input Power = 706 kWe
Storage (H2O tanks)	9.001	
Conversion	4.593	
Radiators	1.534	
Cryocooler	1.693	
Structure	0.508	
Add'l Structure Allowance	0.520	Allowance = 3%
Solar Conversion		SLA
Solar Concentrators/Arrays	0.562	Unit Height = 3 m, Width = 10 m, Mass = 0.012 MT, Power = 0.016 MW
Add'l Structure Allowance	0.017	Allowance = 3%
Telecomm & Command	0.338	One set per solar array node (8 sets)
Add'l Structure Allowance	0.010	Allowance = 3%
LOX/LH2 Tanks	18.64	8 LOX/LH2 tanks
Insulation, structure, etc.	8.000	Tank skirts, intertank, vapor-cooled shield, insulation
Integrating Structure	4.790	Abacus, Prop & H2O Tank Structures
PMAD		Cabling & Power Conversion, SPG Power = 706 kWe; Advanced PMAD
Cabling	2.203	Total Length = 3 km @ 0.881 kg/m, Voltage = 0.15 kV
Array Converter Mass	1.011	Mass based on 48 Switches (150 V to 0.15 kV), 0.016 MW Power Out
Electrolysis PMAD Mass	5.503	Mass Includes Voltage Converters, Switches, Harness & PMAD Thermal
Rotary Joints, Switches, Etc.	0.357	Scaled from 79 SPS Study
Attitude Control/Pointing		Sensors, Computers, Control Effectors
Dry Mass	0.701	Thrusters, CMG's, Sensors etc.
Propellant	0.516	10 years, Krypton
Robotics	1.900	7 units @ 200 each, 500 kg infrastructure
Add'l Structure Allowance	0.021	Allowance = 3%
Docking Ports & Structure	6.405	
Add'l Structure Allowance	0.192	
Satellite Mass (MT)	69.015	Without H2O or LOX/LH2

Table 1. Propellant Production Depot Mass Estimate.

## CONCLUSIONS

Technology developed for space solar power can enable efficient cryogenic propellant production from H<sub>2</sub>O, and can pave the way toward further robotic and human exploration and development of space. Production of cryogenic propellant from H<sub>2</sub>O in Earth orbit avoids volume and safety issues related to containment of cryogenics during launch and it allows high acceleration of payload (H<sub>2</sub>O/ice) during launch. Major components of a cryogenic propellant Depot, such as tanks, can be based on existing technology and launched using vehicles that will become available within the next few years.

In the nearer term, flight experiments can be performed on “expended” cryogenic upper stages, on the International Space Station, and/or on the Space Shuttle. This can be followed by deployment of a sub-scale storage only Depot in LEO.

In the longer term, cryogenic propellant production technology can be applied to a larger LEO Depot, and potentially, to the use of lunar water resources at a similar Depot elsewhere (on the Moon, in lunar orbit, or at an Earth-Moon LaGrange point).

## REFERENCES

- Kessler, T.L., P. Frye, and R. Patch, *Solar Thermal OTV-Applications to Reusable and Expandable Launch Vehicles*, 50<sup>th</sup> International Astronautical Congress, Oct. 4-8, 1999, Amsterdam, The Netherlands.
- Kohout, Lisa L. *Cryogenic Reactant Storage for Lunar Base Regenerative Fuel Cells*. Presented at the International Conference on Space Power sponsored by the International Astronautical Federation, Cleveland, OH, June 5-7, 1989.
- Schuster, J. R., F.O. Bennett, M.W. Liggett, C.N. Torre, N.S. Brown, *Evaluation of On-Orbit Cryogenic Propellant Depot Options for the Orbital Transfer Vehicle*. Presented at the 6<sup>th</sup> Cryogenics Symposium AIChE Annual Meeting, Miami Beach, Florida, Nov3-7, 1986.
- Schuster, J.R., et al. *Long Term Orbital Storage of Cryogenic Propellants for Advanced Space Transportation Missions*. Presented at the 20<sup>th</sup> IEEE Annual Electronics and Aerospace Systems Conference, Washington, D.C., October 14-16, 1987.
- Schuster, J.R., T.J Alton, N.S Brown, and U. Heuter, *Evaluation of Cryogenic System Test Options for the OTV On-Orbit Propellant Depot*, Paper AIAA-87-1498. Presented at the AIAA 22<sup>nd</sup> Thermophysics Conference, Honolulu Hawaii, 1987.
- Schuster, John R., et al. *Orbital Cryogenic Depot for Support of Space Transfer Vehicle Operations*. Presented at the 39<sup>th</sup> Congress of the International Astronautical Federation, Bangalore, India, Oct 8-15, 1988.



# A Cryogenic Propellant Production Depot for Low Earth Orbit

International Space Development Conference  
 Albuquerque, NM, 24-28 May 2004

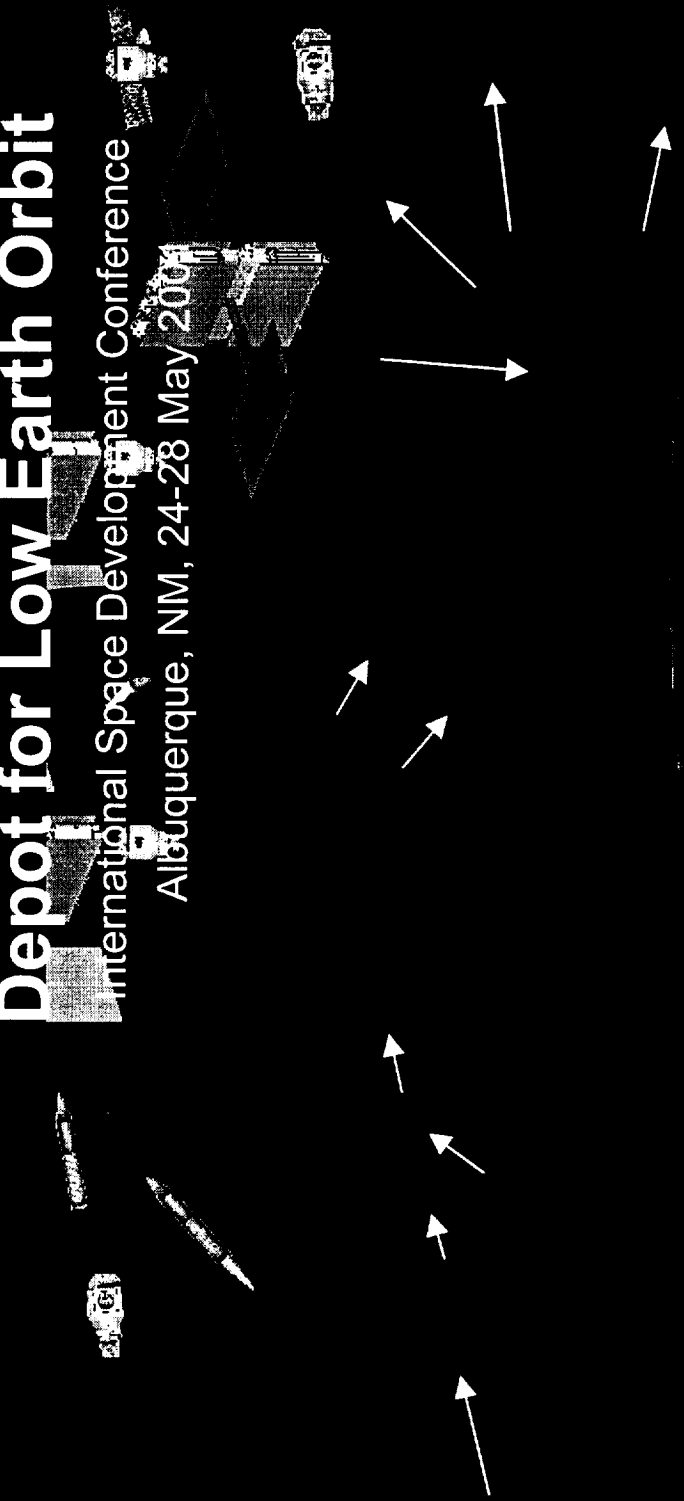

Seth D. Potter  
 Mark W. Henley  
 Sonia Gutierrez  
 The Boeing Company  
 Huntington Beach, CA

John Fikes  
 Dennis Carrington  
 David Smitherman  
 Mark Gerry  
 NASA Marshall Space Flight  
 Center  
 Huntsville, AL

Steve Sutherland  
 Phil Beason  
 Sverdrup Technologies  
 Huntsville, AL

# Propellant Depot Functional Requirements

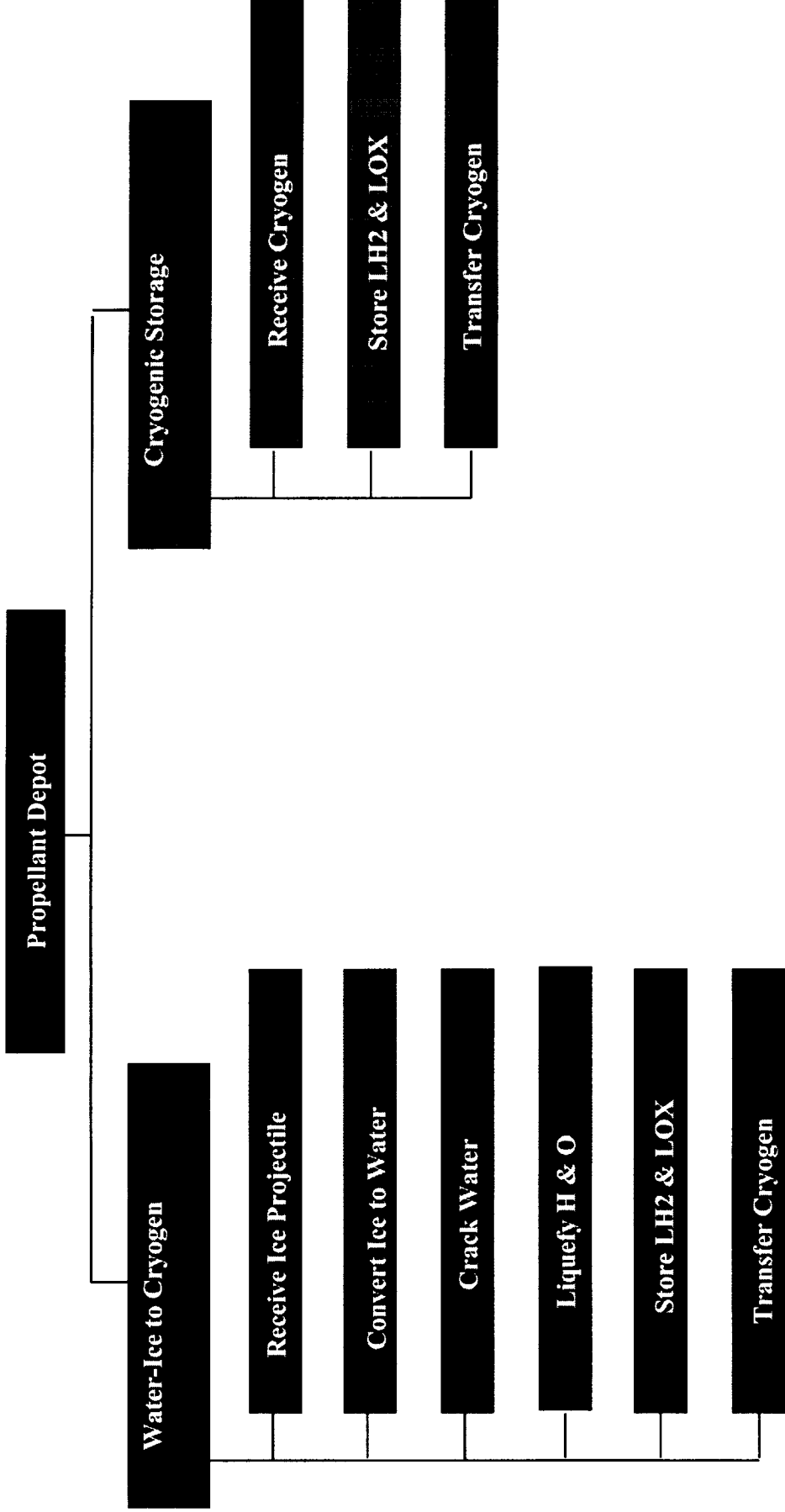

# Propellant Quantity Requirements are Determined by Depot Mission Requirements

- Refuel OMVs for transfers in LEO
- Refuel OTVs for transfers to GEO
- Refuel OTVs for L2 and Lunar missions

## Mars

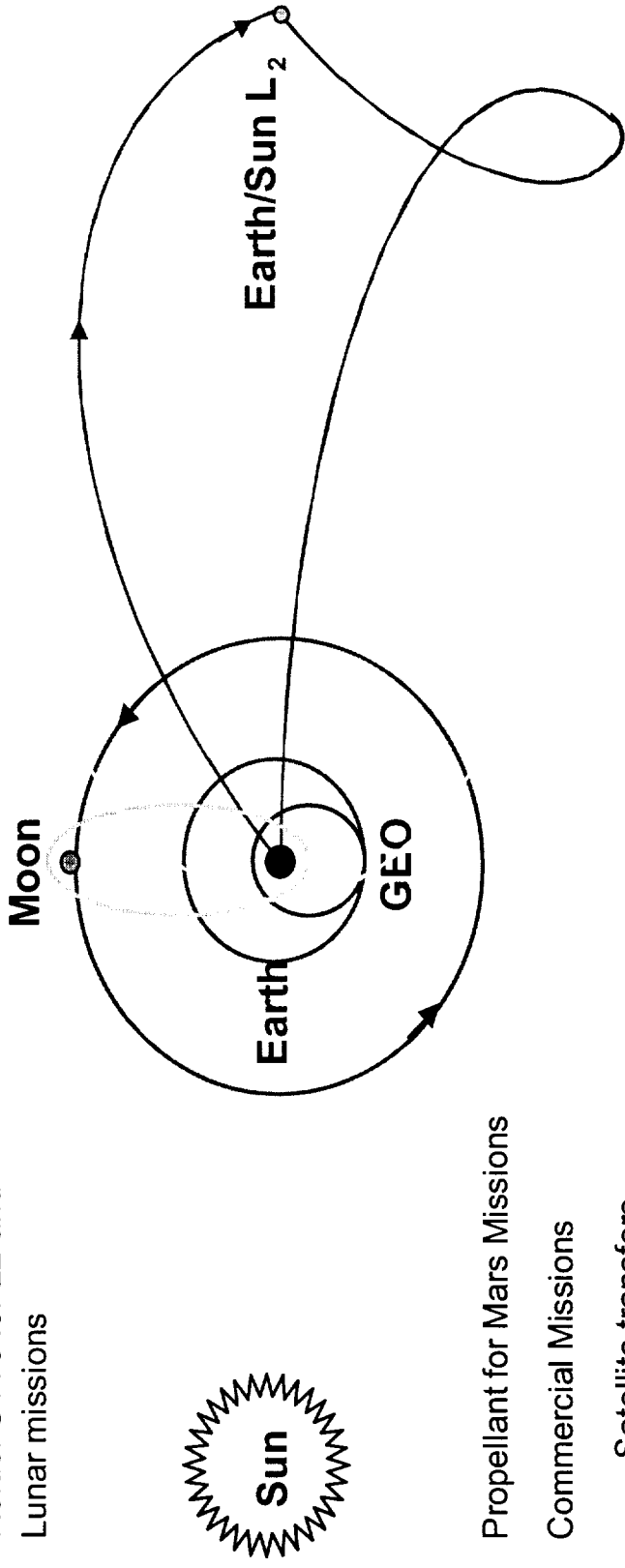

- Propellant for Mars Missions
- Commercial Missions
  - Satellite transfers
  - Satellite servicing
  - Orbital debris removal

# Configuration Details

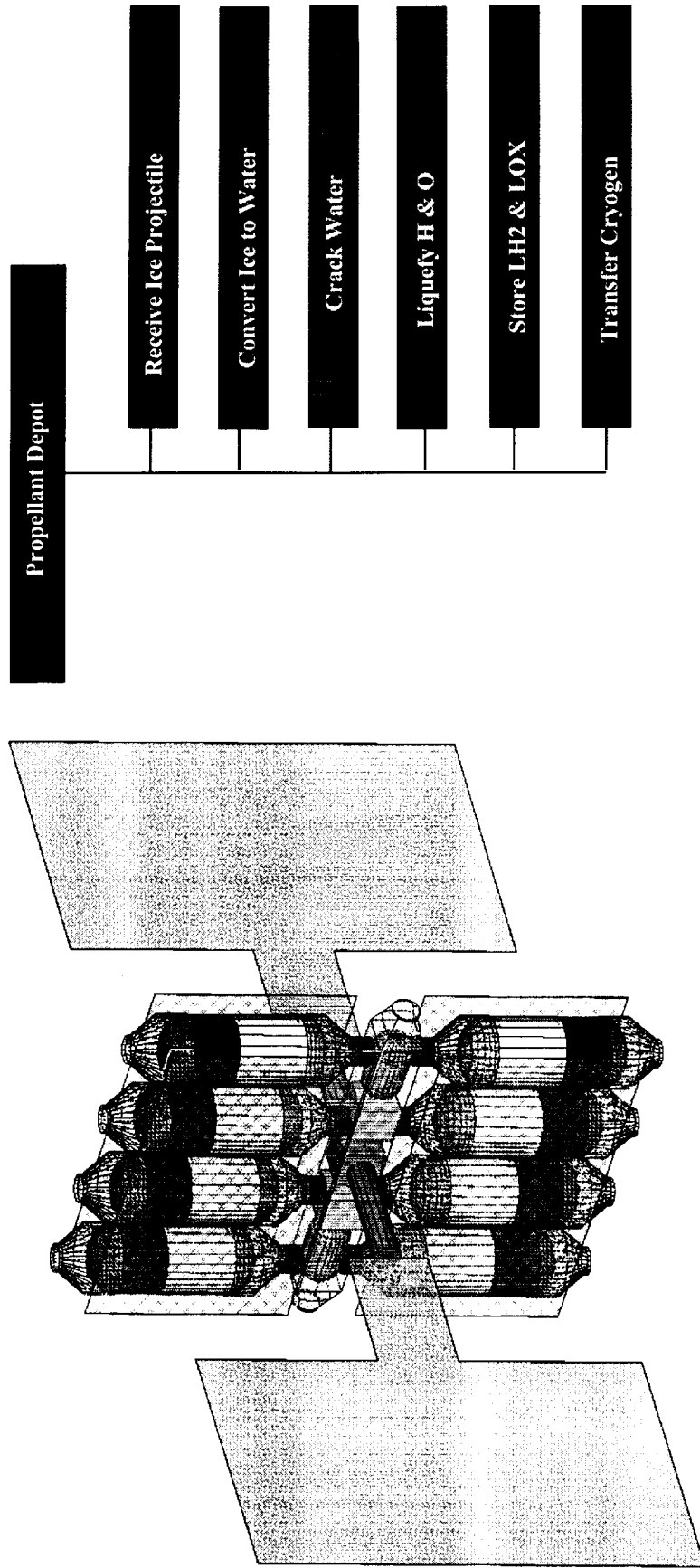

# Missions

## RLV Architecture

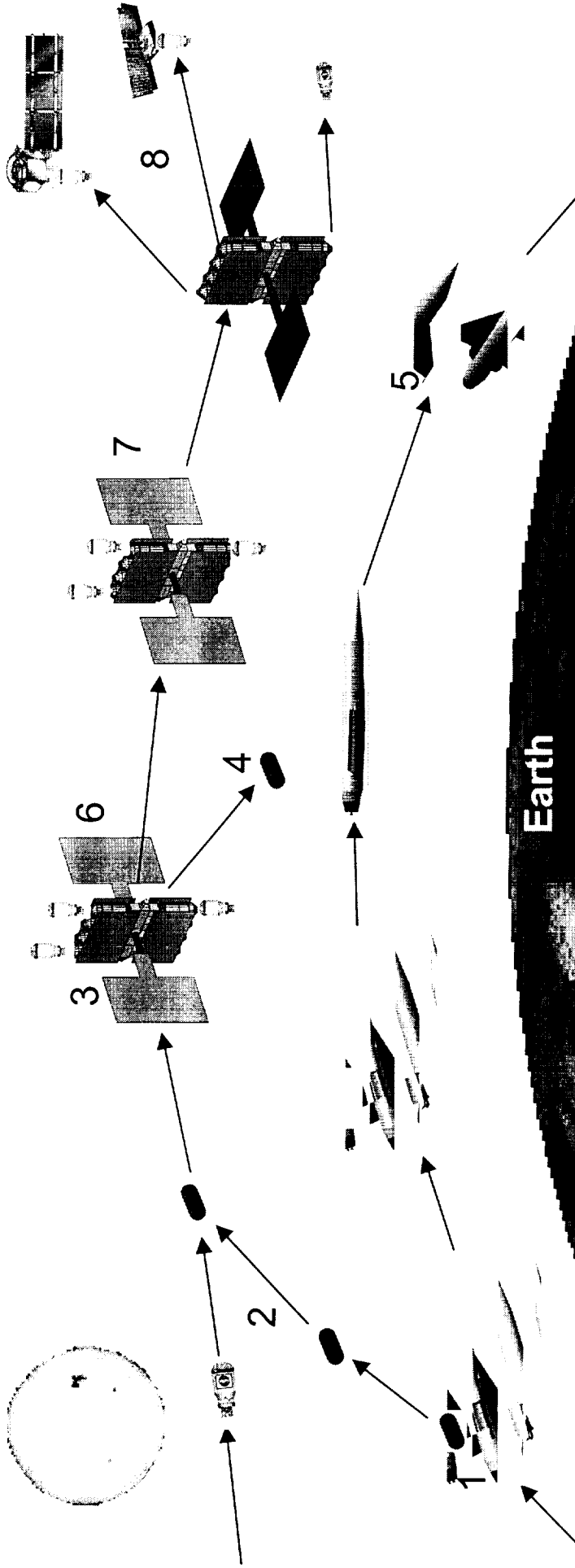

1. RLV delivers water tank to orbit
2. OMV captures water tank and transfers to Depot
3. Water is transferred to holding tanks at Depot
4. Transfer tank is returned to RLV or de-orbited
5. RLV returns to launch site
6. Water is packed into LH2 and LOX for propellants
7. Propellants are transferred to OMV's OTV's and storage depots
8. OMV's OTV's and storage depots transfer to other destinations via chemical, electric or splash-injector propulsion



# Missions

## Gun Launch Architecture

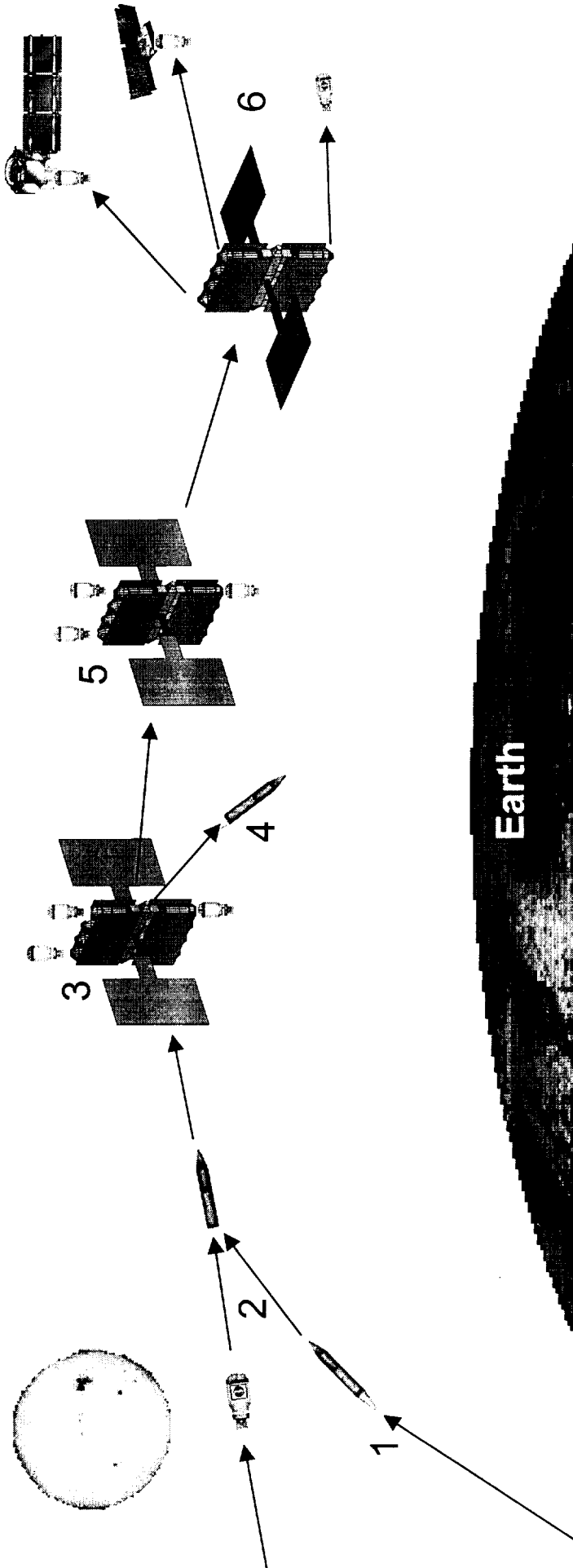

Earth

1. Gun launch delivers water projectile to orbit
2. OMV captures projectile and delivers to Depot
3. Water is pulled from projectile and cracked into LH2 and OX propellants.
4. Projectile is de-orbited
5. Propellants are transferred to OMV's, OTV's and storage depots.
6. OMV's, OTV's and storage depots transfer to other destinations via chemical or electric propulsion





# Approaches to Cryogenic Propellant Settling

**Rotating Depot**

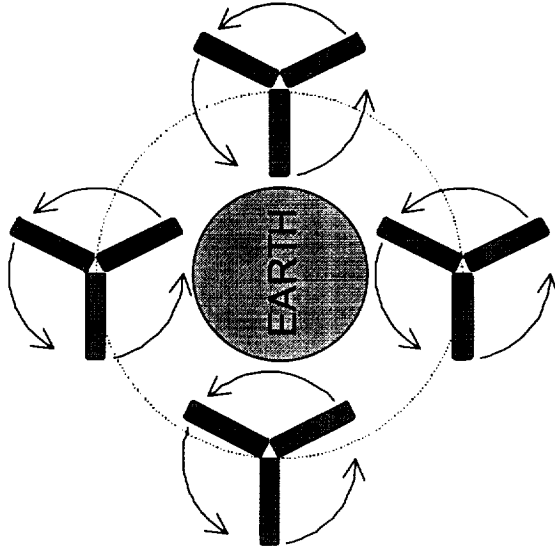

**Gravity Gradient Depot**

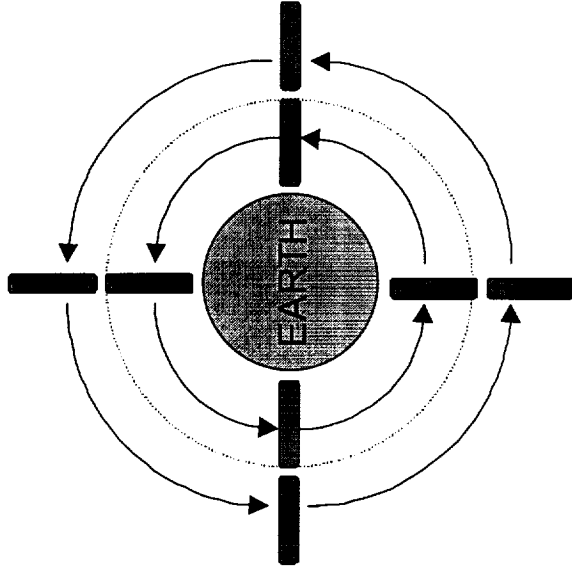

**Solar Inertial**

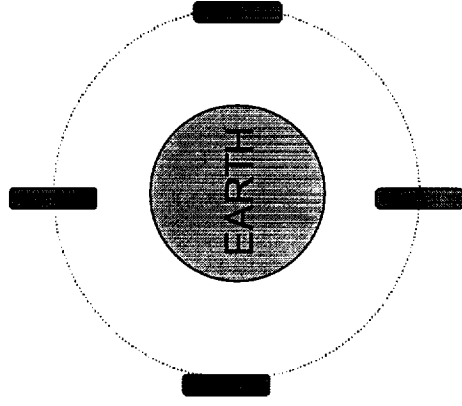

- Suitable for Deep Space
- Requires de-spun docking

- Any orbit
- Marginal settling for H2
- Docking at Ends or Center

- Sun Pointing
- No alpha/beta joints
- Requires zero-g propellant acquisition

# System Concepts for Propellant Settling Approaches

Spinner Concept

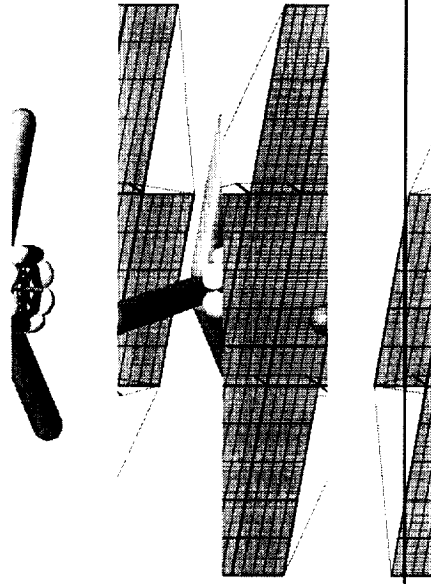

Abacus Quasi-Inertial Concept

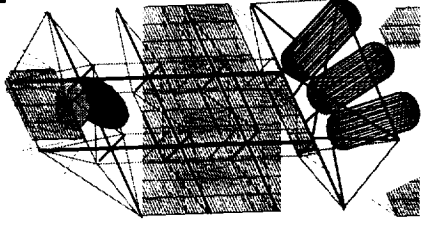

Preliminary Gravity Gradient Concept

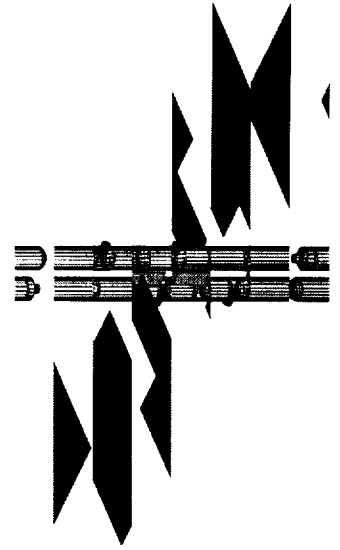

Gravity Gradient Concept

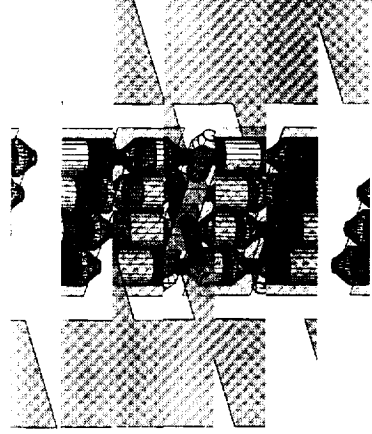

# Gravity-Gradient Forces Can Settle Cryogenic Propellants in Large Tanks

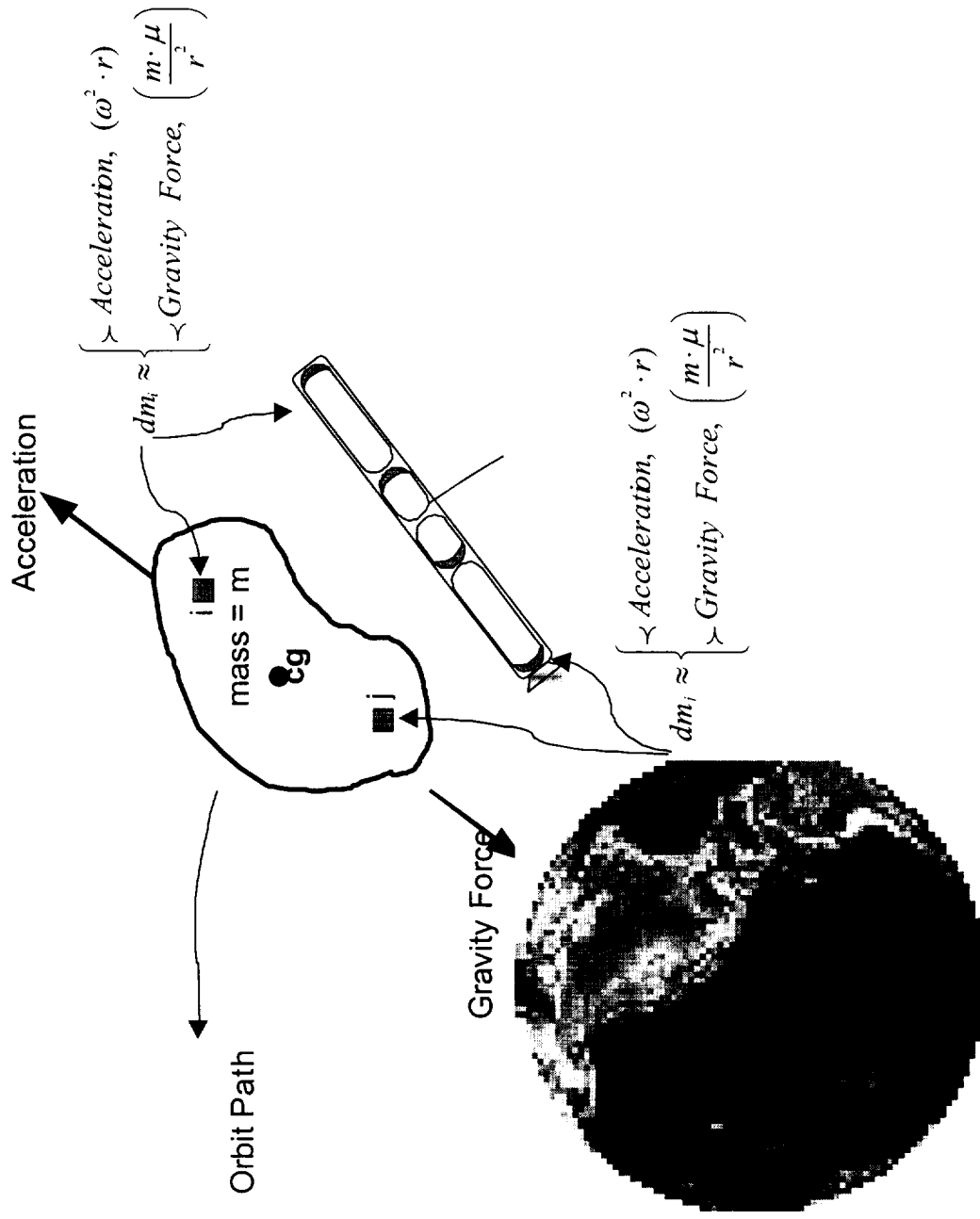

# Propellant Production Depot Design Includes Seven Key Subsystems

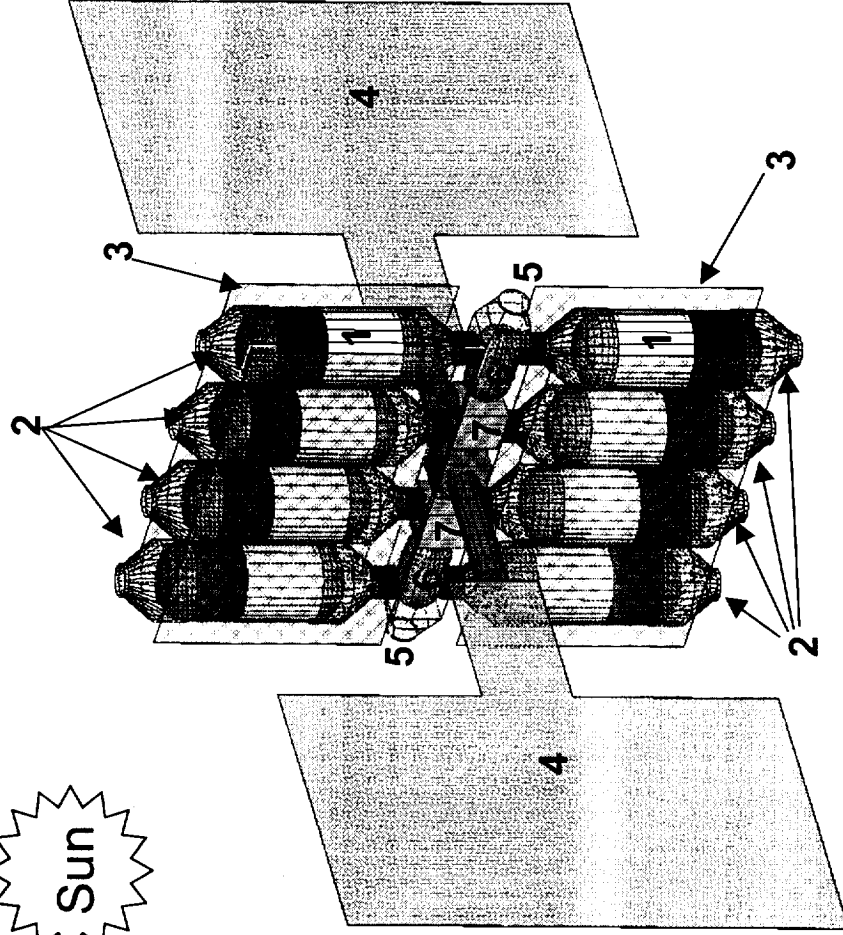
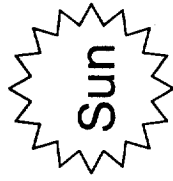

1. LOX/LH2 Storage Tanks

2. Transfer Vehicle Docking Ports

3. Radiators

4. Solar Arrays

5. Water Docking Port

6. Water Storage Tanks

7. Electrolysis System



# System Design Features of the Propellant Production Depot

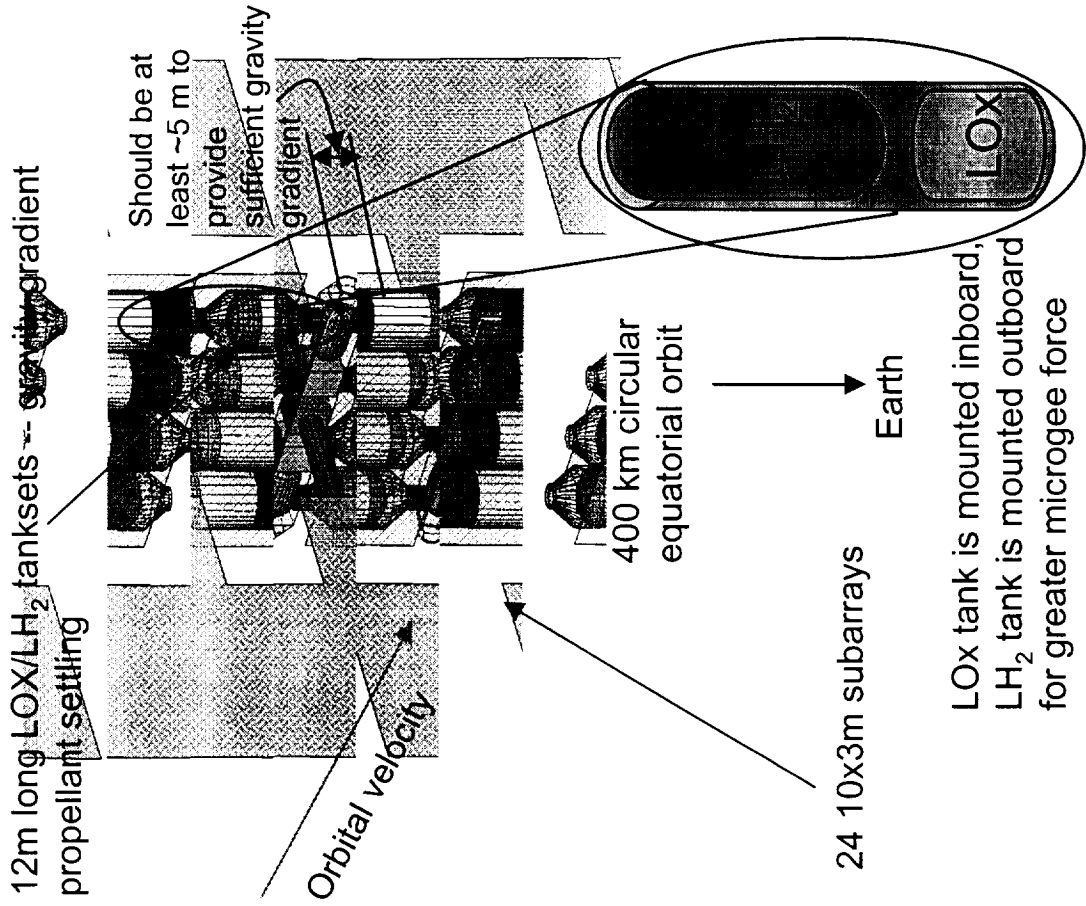

- ENTECH Stretched Lens Array (SLA's)
  - Sized for 706kWe (635kWe delivered to bus)
  - Inflatable abacus structure
- Power Management & Distribution (PMAD)
  - 150V
  - No converters at the arrays
  - Two power conducting slip rings
- 8 Delta IV Heavy-class tanksets
  - 500 MT LOX & LH<sub>2</sub> per year
  - Stoichiometric 8:1 mixture ratio
- Composite truss structure
- Robotics including infrastructure
- Stationkeeping & attitude control
  - SEP 0.5N thrusters
  - 50kWe Hall thrusters
  - CMGs
  - Attitude sensors
  - Krypton stationkeeping propellant for 10 years



## Depot tanks Can Be Launched as Expendable Launch Vehicle Upper Stages

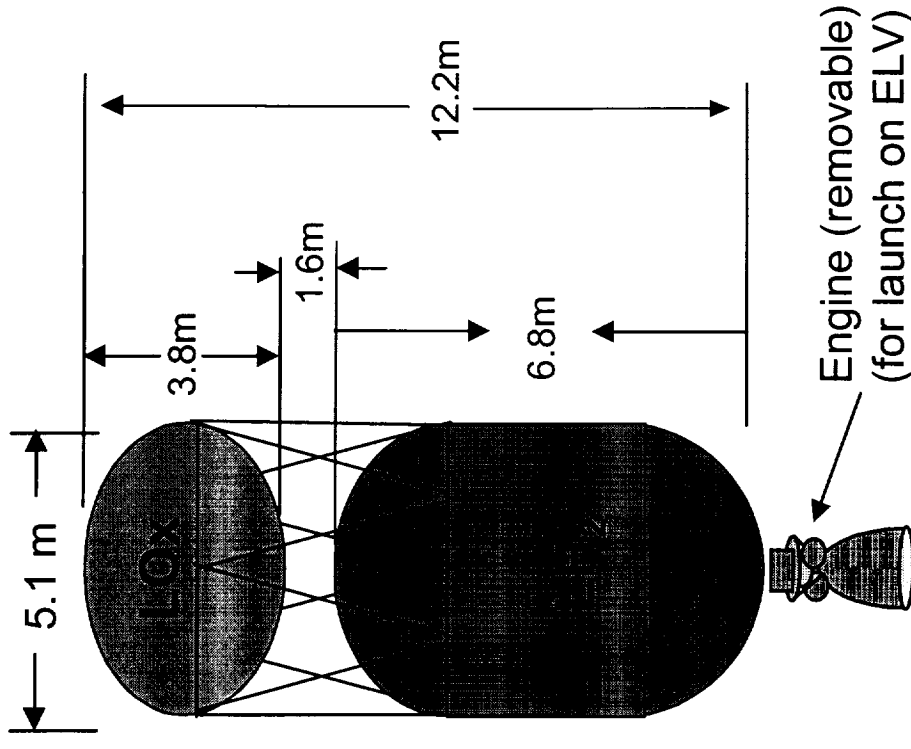

- **Total length per tankset = 3.80 m + 6.8 m + 1.6 m = 12.2 m.**
- **Total propellant mass stored per tankset = 60,914 kg + 7614 kg = 68,528 kg**
- **Number of tanksets needed to meet 500 MT depot requirement  $\geq 500/68.528 = 7.3 \sim 8$ .**

# Three Alternative Thermal Radiator Configurations Were Studied

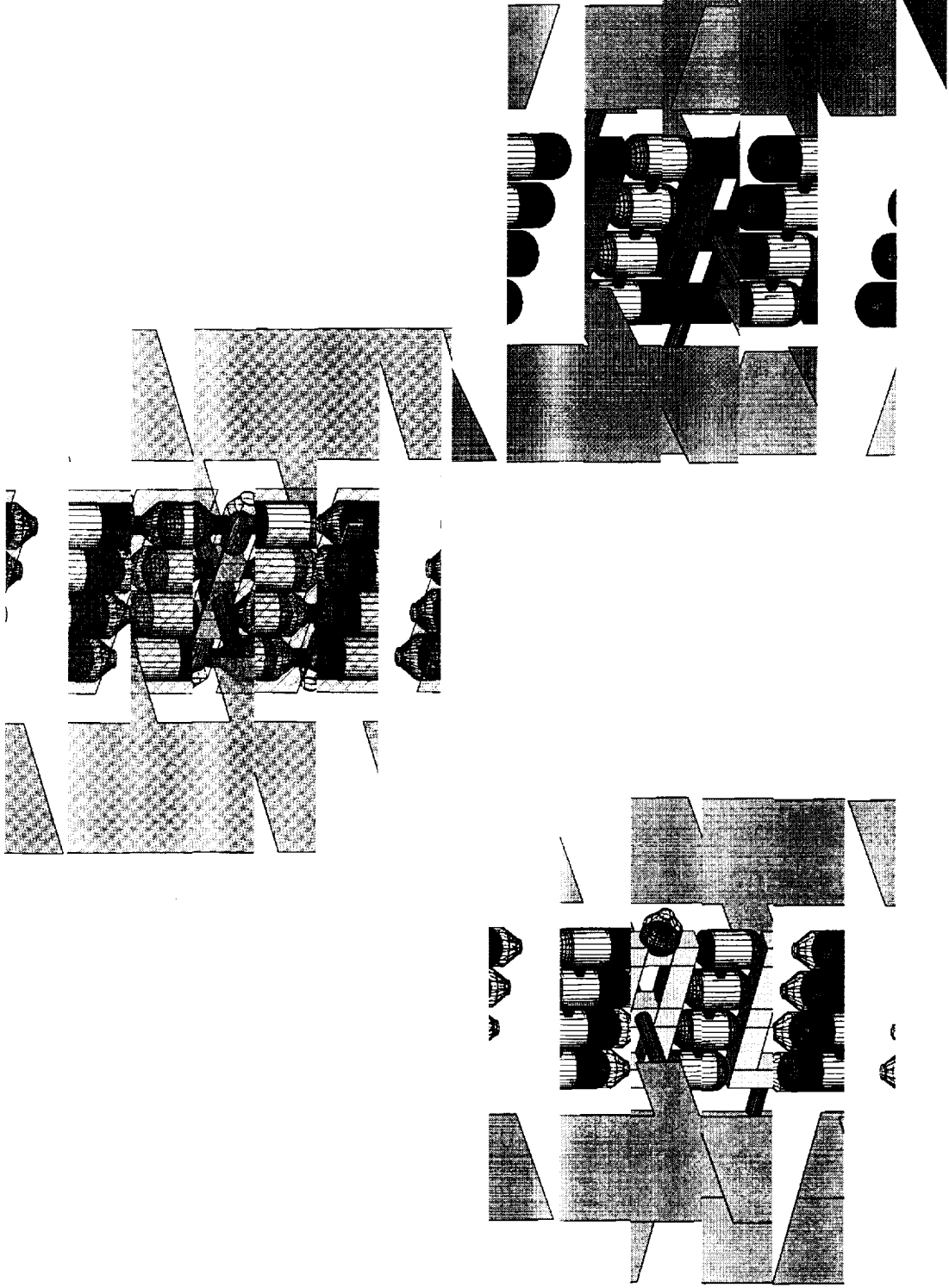

# ENTECH Stretched Lens Arrays Can Supply Power for Propellant Production

ENTECH Stretched Lens Array

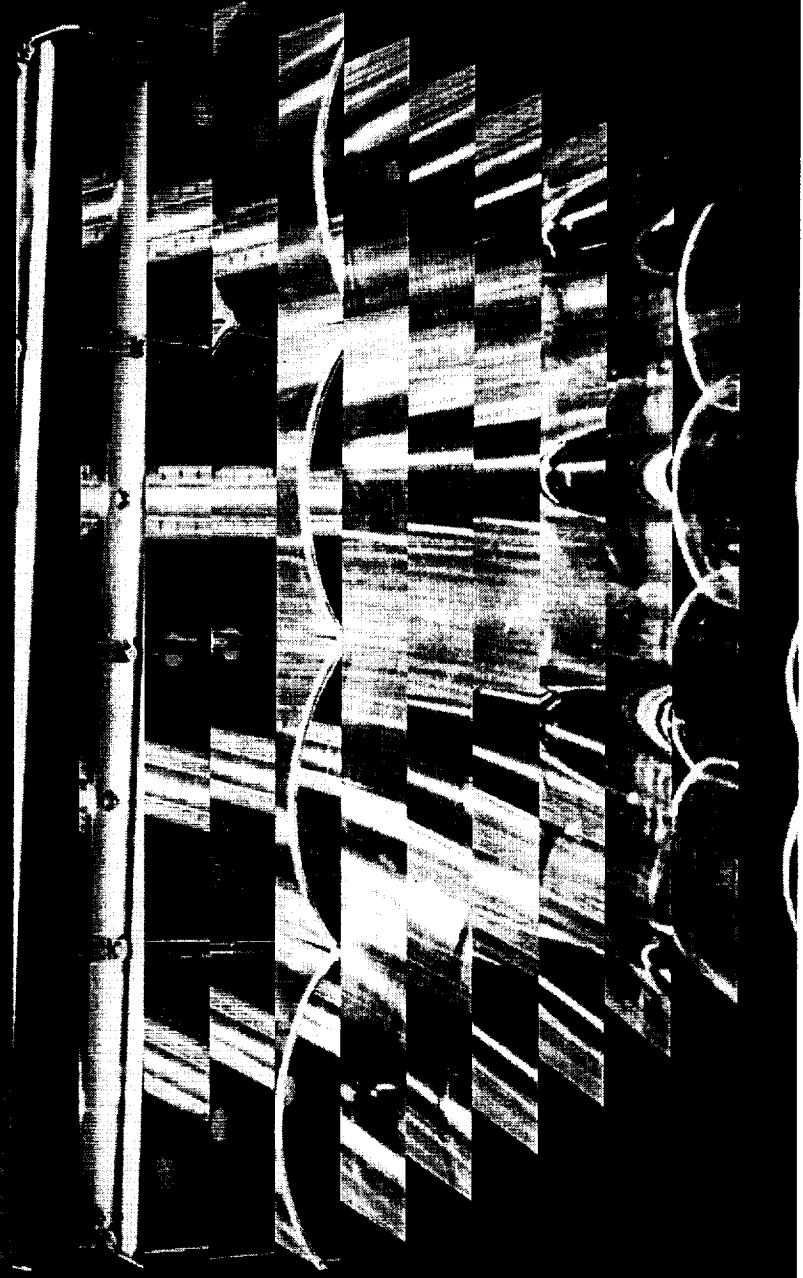



# Electrolysis Uses 617 kWe to Produce More Than a Ton of Propellant Per Day

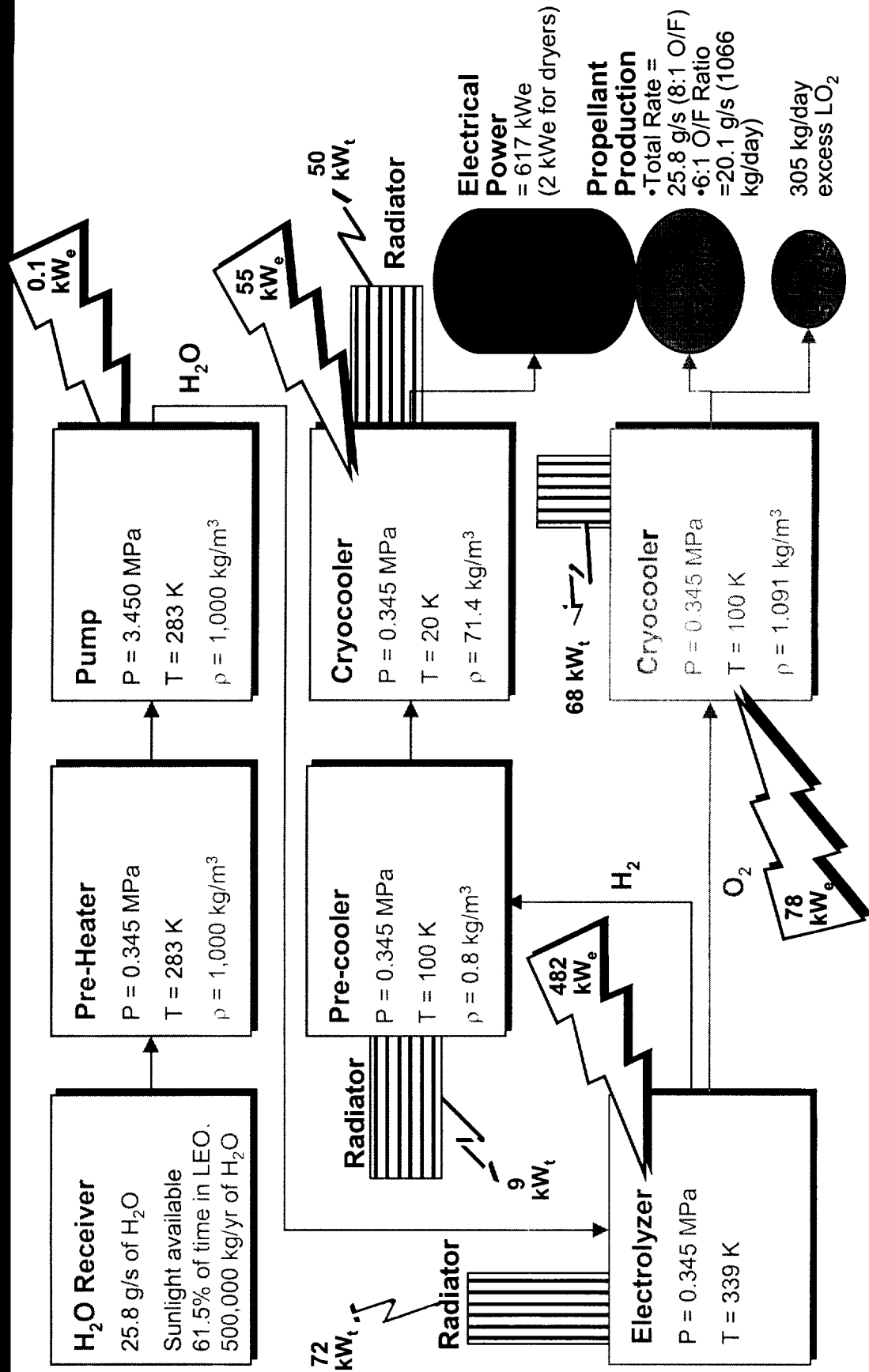

# Propellant Production Depot Configuration Dimensions

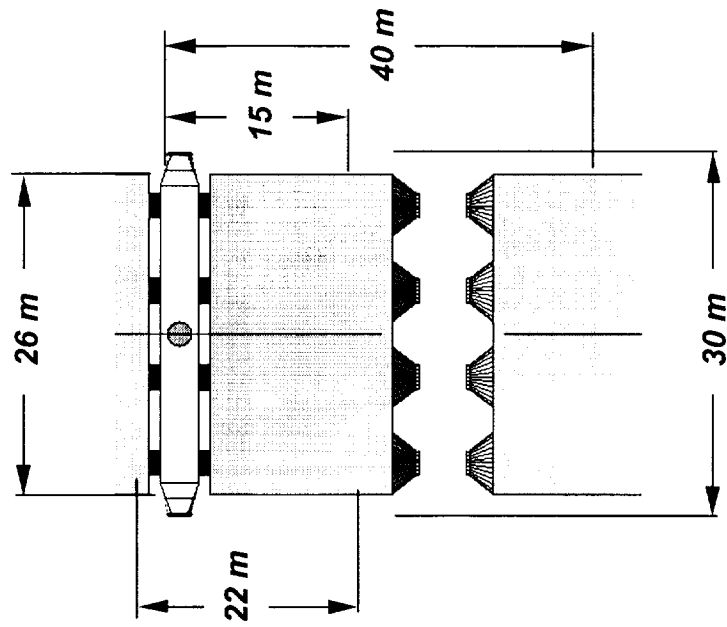
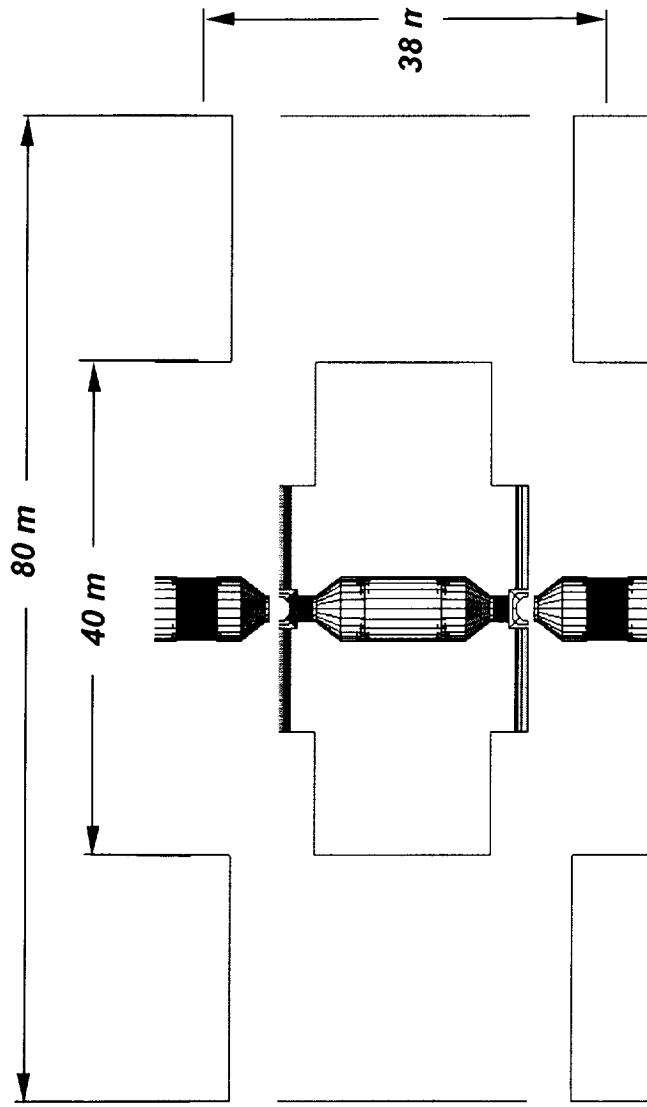

# Propellant Production Depot Mass Estimate

<b>System Element</b>	<b>Mass (MT)</b>	<b>Comments</b>
Electrolysis Conversion Storage (H2O tanks)	9.001	Devices, Structure; Input Power = 706 kWe
Conversion	4.593	
Radiators	1.534	
Cryocooler	1.693	
Structure	0.508	
Add'l Structure Allowance	0.520	
Solar Conversion		
Solar Concentrators/Arrays	0.562	
Add'l Structure Allowance	0.017	
Telecomm & Command	0.338	
Add'l Structure Allowance	0.010	Allowance = 3%
LOX/LH2 Tanks	18.64	SLA
Insulation, structure, etc.	8.000	Unit Height = 3 m, Width = 10 m, Mass = 0.012 MT, Power = 0.016 MW
Integrating Structure	4.790	Allowance = 3%
PMAD		One set per solar array node (8 sets)
Cabling	2.203	Allowance = 3%
Array Converter Mass	1.011	8 LOX/LH2 tanks
Electrolysis PMAD Mass	5.503	Tank skirts, intertank, vapor-cooled shield, insulation
Rotary Joints, Switches, Etc.	0.357	Abacus, Prop & H2O Tank Structures
Attitude Control/Pointing		Cabling & Power Conversion, SPG Power = 706 kWe; Advanced PMAD
Dry Mass	0.701	Total Length = 3 km @ 0.881 kg/m, Voltage = 0.15 kV
Propellant	0.516	Mass based on 48 Switches (150 V to 0.15 kV), 0.016 MW Power Out
Robotics	1.900	Mass Includes Voltage Converters, Switches, Harness & PMAD Thermal
Add'l Structure Allowance	0.021	Scaled from 79 SPS Study
Docking Ports & Structure	6.405	Sensors, Computers, Control Effectors
Add'l Structure Allowance	0.192	Thrusters, CMG's, Sensors etc.
		10 years, Krypton
		7 units @ 200 each, 500 kg infrastructure
		Allowance = 3%
Satellite Mass (MT)	69.015	Without H2O or LOX/LH2



# Seven Launches Can Carry the Propellant Production Depot into Orbit

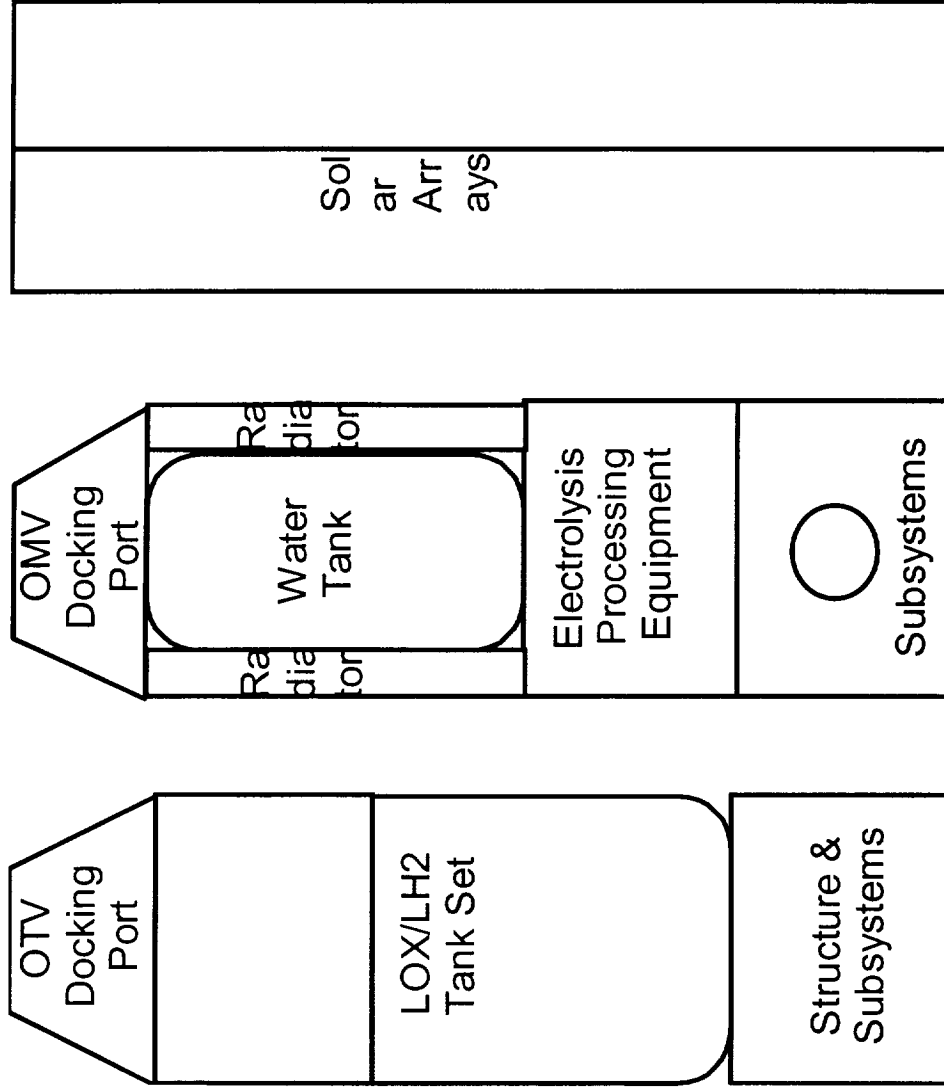

Element 3  
1 Launch

Element 2  
2 Launches

Element 1  
4 Launches



# A Cryogen Storage-Only Depot Can Be Deployed in One Launch

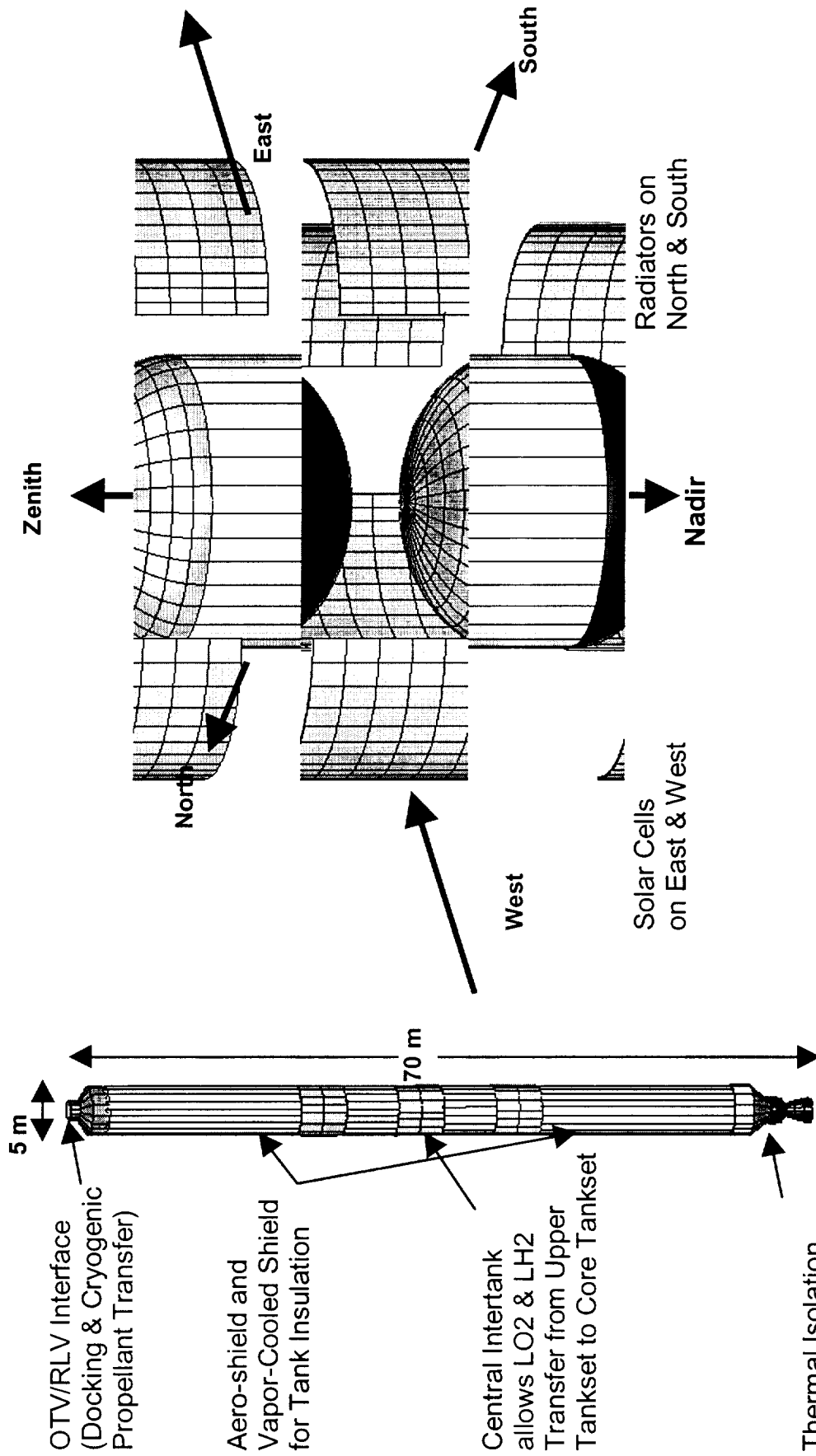

Thermal Isolation between Engine & Core (e.g., composite feedline) [Option to Detach Engine]



# The Depot Can Be Used to Fuel Advanced Vehicles

Medium Upper Stage (DCUS)

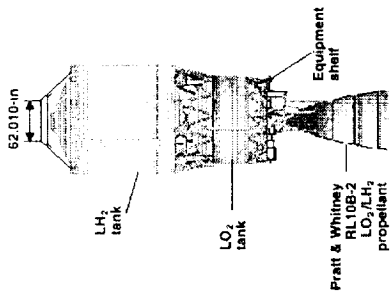

Used on: Delta IV Medium, Medium-412

Heavy Upper Stage (HDCUS)

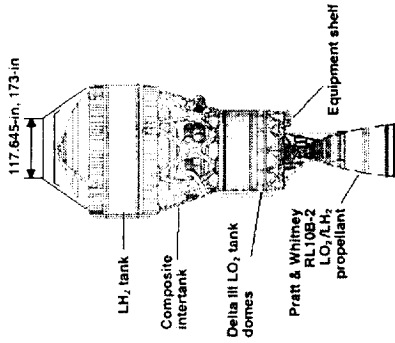

Used on: Delta IV Heavy, Medium-532, Medium-514

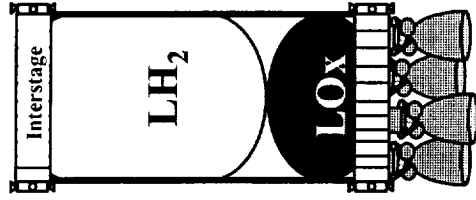

Mars Transfer Stages

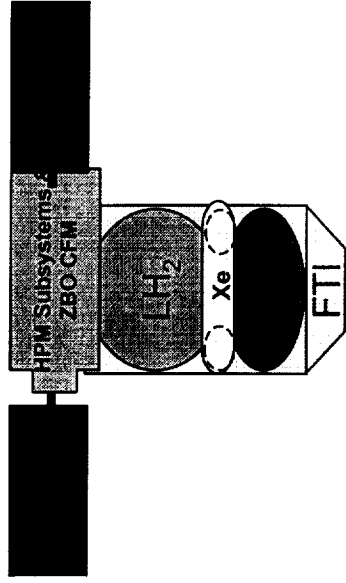

Hybrid Propellant Modules



RLV

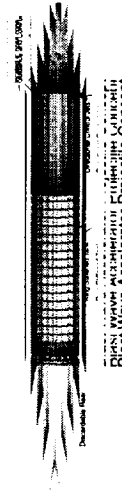

Projectile

# Laser-Thermal Propulsion Using Hydrogen and Power from the Depot Could Reduce "Solar" OTV Trip Times

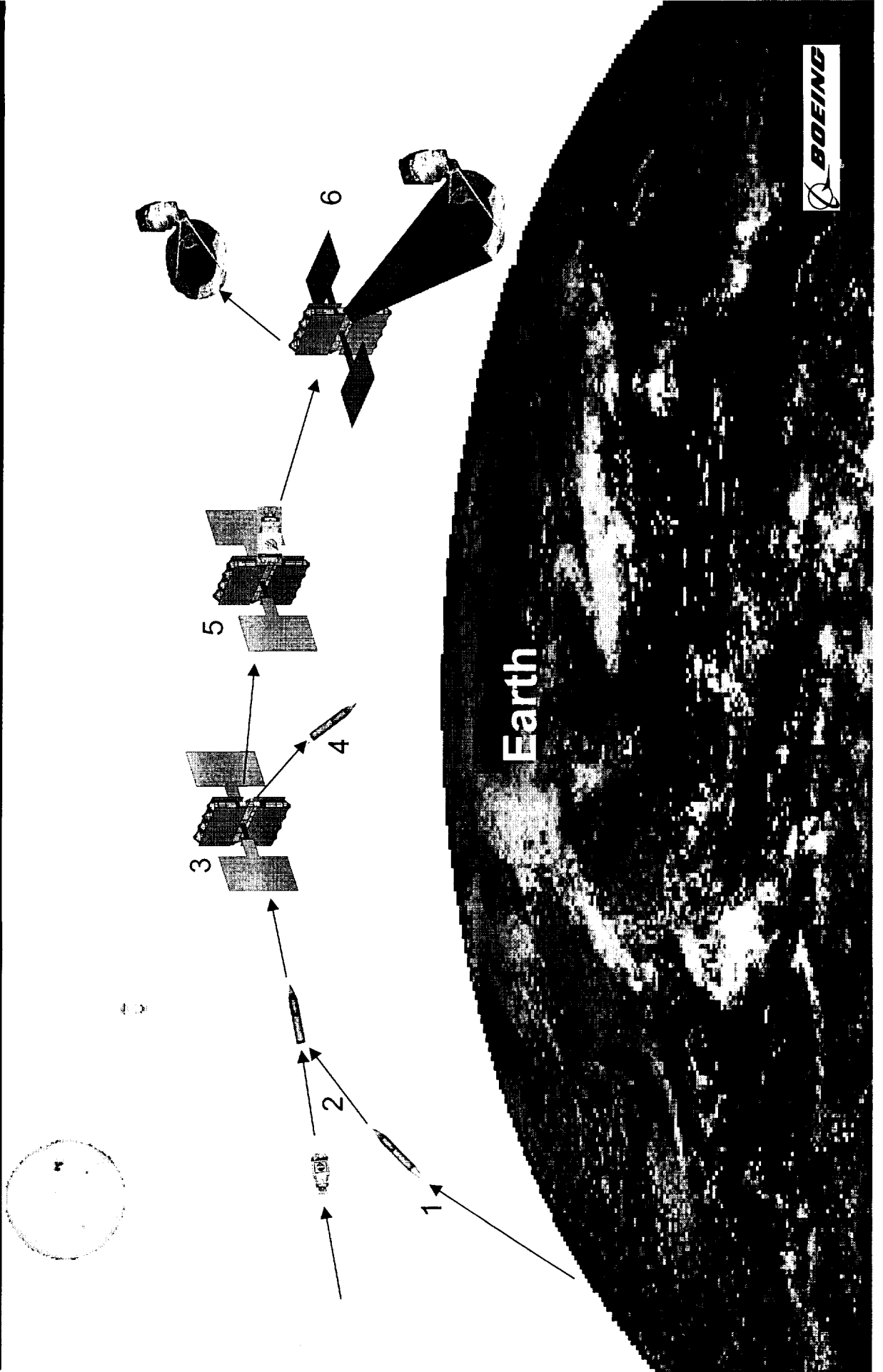

# Shuttle/Free-flyer Technology Flight Experiment Opportunities Summary

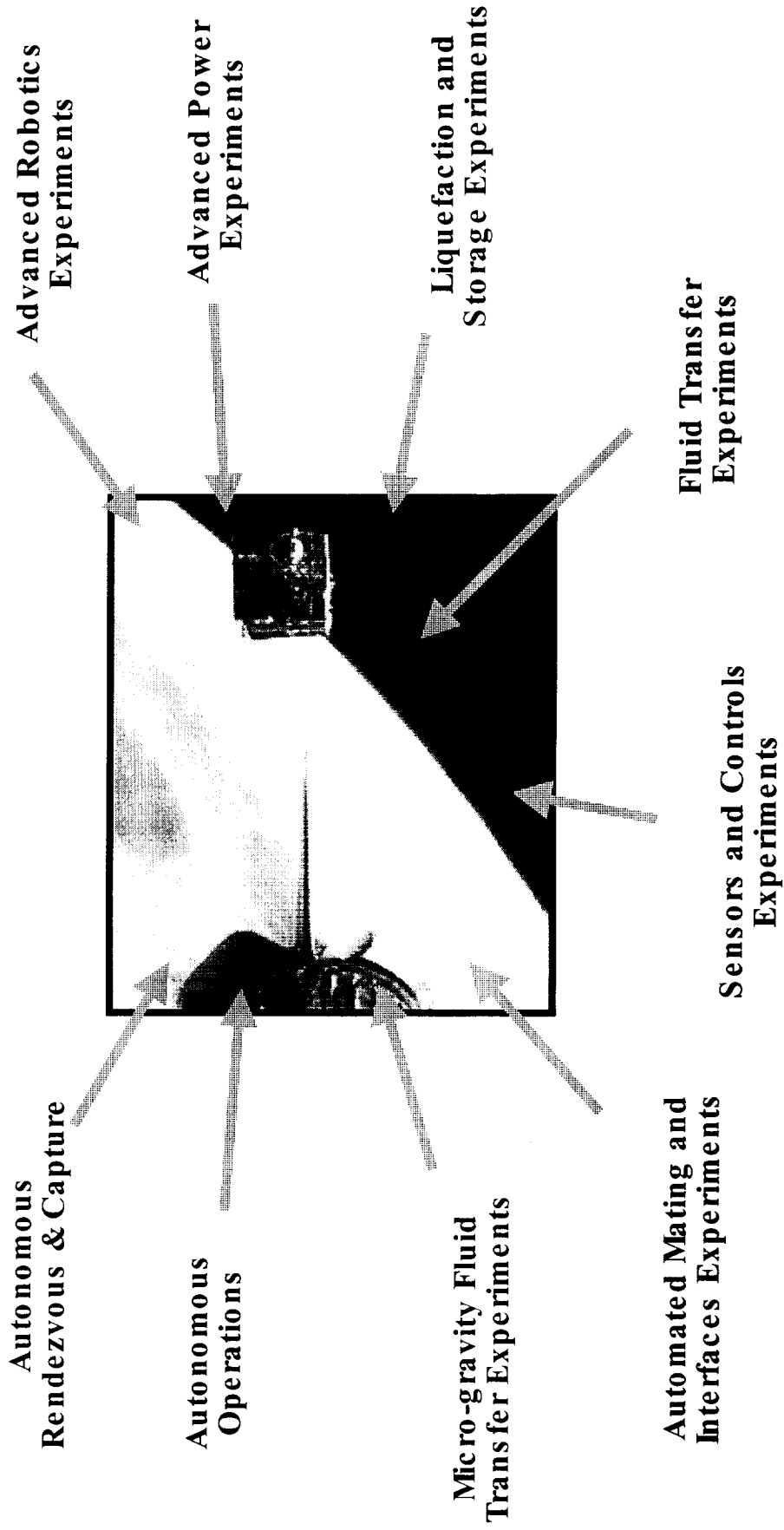



# ISS Technology Flight Experiment Opportunities Summary

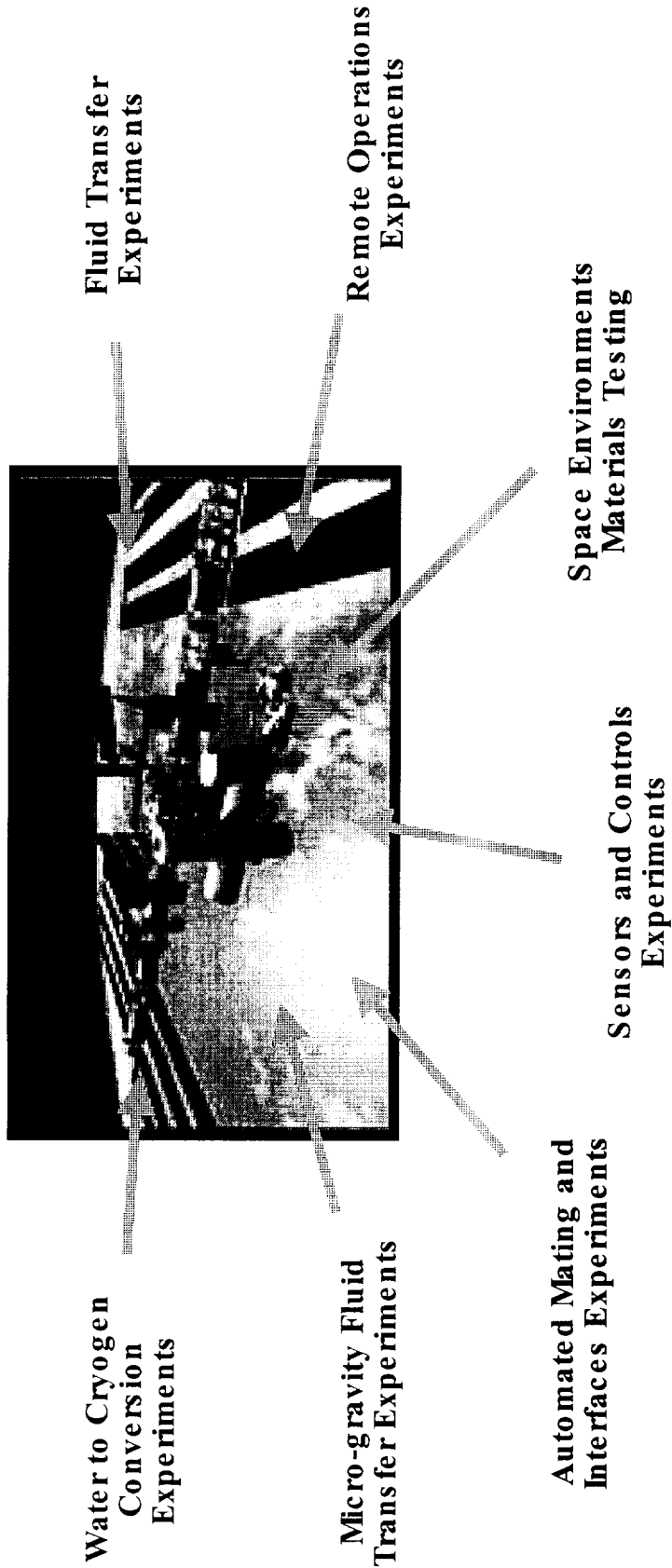

Water to Cryogen  
Conversion  
Experiments

Micro-gravity Fluid  
Transfer Experiments

Automated Mating and  
Interfaces Experiments

Sensors and Controls  
Experiments

Space Environments  
Materials Testing

Remote Operations  
Experiments

Fluid Transfer  
Experiments



# Technology Matures from Ground Development Through Full-Scale Depot

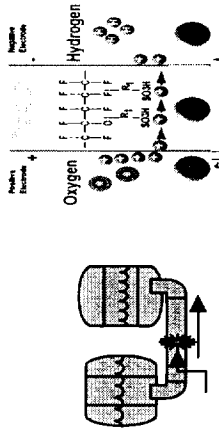

**2002-2008 Technology Development**

▲ Technology Ground Demonstrations

▲ Technology Flight Demonstrations

**2006-2011 Demonstrations**

▲ Flight Demonstrations

**2012-2016 Development for Operations**



## Conclusions

- A Cryogenic Propellant Production Depot in low Earth orbit can store propellant launched by an RLV or Gun Launch system
- The Depot can be used for refueling vehicles in orbit:
  - Orbital Maneuvering Vehicles for transfers in Low Earth Orbit
  - Orbital Transfer Vehicles for transfers to Geostationary Orbit
  - Orbital Transfer Vehicles for L2 and lunar missions
  - Propellant for Mars missions
  - Commercial missions
- The Depot uses an in-line gravity-gradient tank configuration to settle the propellant
  - Major components such as tanks can be based on existing technology
  - Power is supplied by large solar arrays which rotate once per orbit to track the Sun
- A Cryogen Storage-Only Depot can be deployed in the near term
- In the longer term, the Depot technology can be applied to the use of lunar water resources

<input type="checkbox"/>			
<input type="checkbox"/>			
<input type="checkbox"/>			
<input type="checkbox"/>			
<input type="checkbox"/>			
<input type="checkbox"/>			
<input type="checkbox"/>			
<input type="checkbox"/>			

1			
2			
3			
4			
5			
6			
7			
8			

11			
12			
13			
14			
15			
16			
17			
18			
19			
20			
21			

22			
23			
24			
25			
26			
27			
28			
29			
30			
31			

<input type="checkbox"/>			
<input type="checkbox"/>			
<input type="checkbox"/>			