



538115

AIAA 2001-3631

**Compton Gamma Ray Observatory:  
Lessons Learned in Propulsion**

G. Dressler, G. Joseph and H. Behrens  
TRW, Redondo Beach, CA

D. Asato  
NASA GSFC, Greenbelt, MD

R. Carlson  
Rancho Palos Verdes, CA

**37<sup>th</sup> AIAA/ASME/SAE/ASEE Joint Propulsion  
Conference and Exhibit**

**8-11 July 2001  
Salt Lake City, Utah**

For permission to copy or to republish, contact the copyright owner named on the first page.  
For AIAA-held copyright, write to AIAA Permissions Department,  
1801 Alexander Bell Drive, Suite 500, Reston, VA, 20191-4344.

## Compton Gamma Ray Observatory: Lessons Learned in Propulsion

G.A. Dressler\*, G.W. Joseph\*, H.W. Behrens\* (TRW, Redondo Beach, CA),

D.I. Asato\* (NASA GSFC, Greenbelt, MD) and R.A. Carlson (Rancho Palos Verdes, CA)

### ABSTRACT

The Compton Gamma Ray Observatory was the second of NASA's Great Observatories. At 17½ tons, it was the heaviest astrophysical payload ever flown at the time of its launch on April 5, 1991 aboard the Space Shuttle. During initial, on-orbit priming of the spacecraft's monopropellant hydrazine propulsion system, a severe waterhammer transient was experienced. At that time, anomalous telemetry readings were received from on-board propulsion system instrumentation. This led to ground analyses and laboratory investigations as to the root cause of the waterhammer, potential damage to system integrity and functionality, and risks for switching from the primary (A-side) propulsion system to the redundant (B-side) system. The switchover to B-side was ultimately performed successfully and the spacecraft completed its basic and extended missions in this configuration. Nine years later, following a critical control gyroscope failure, Compton was safely deorbited and re-entered the Earth's atmosphere on June 4, 2000. Additional risk assessments concerning viability of A- and B-sides were necessary to provide confidence in attitude and delta-V authority and reliability to manage the precisely controlled reentry. This paper summarizes the design and operation of the propulsion system used on the spacecraft and provides "lessons learned" from the system engineering, investigations into the propellant loading procedures, the initial priming anomaly, mission operations, and the commanded re-entry following the gyro failure.

### INTRODUCTION

The Compton Gamma Ray Observatory (CGRO) was a large scientific spacecraft designed for celestial observations from low Earth orbit. It was the second element launched in NASA's deployment of four "Great Observatories" (HST, CGRO, Chandra-AXAF, SIRTf) and carried instruments dedicated to the highest part of the electromagnetic spectrum. The objective of the CGRO mission was to obtain gamma-ray measurements over the entire celestial sphere with unprecedented sensitivity, spectral range and resolution.

CGRO was launched aboard the Space Shuttle Atlantis (STS-37) on April 5, 1991, and was deployed April 7 into a 457 km circular orbit at 28.5 degrees inclination (Figure 1). At the time of its deployment it set two records for non-military spacecraft: it was the largest spacecraft launched by STS and it had the largest monopropellant propulsion system ever flown.

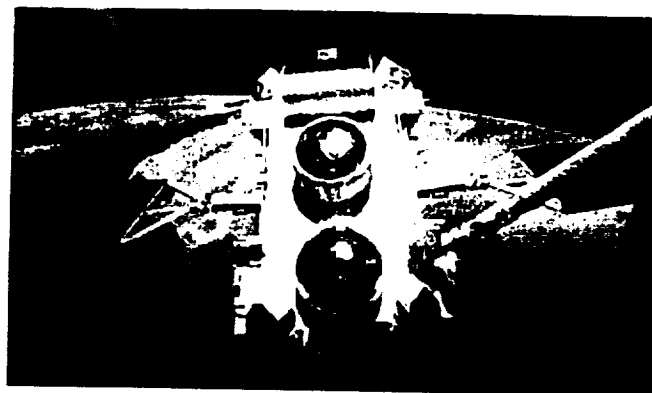

Figure 1. CGRO Deployment from STS-37

After nine years of exciting scientific discoveries<sup>1,2</sup> of very energetic celestial phenomena (far exceeding its minimum mission life of 27 months), CGRO was safely de-orbited with controlled re-entry into the Earth's atmosphere on June 4, 2000. Pieces of the spacecraft survived the re-entry, landing in a remote part of the Pacific Ocean near the equator, approximately 3,862 km (2,400 miles) southeast of Hawaii.

The CGRO mission was a NASA cooperative program managed by the NASA Goddard Space Flight Center (GSFC) and included co-investigators from the United States, Federal Republic of Germany, Netherlands, ESA and United Kingdom. The Observatory carried four highly sophisticated instruments capable of making simultaneous measurements over six decades of energy (20 keV–30 GeV). These instruments were: the Burst and Transient Source Experiment (BATSE), the Oriented Scintillation Spectrometer Experiment (OSSE), the Imaging Compton Telescope (COMPTEL), and the Energetic Gamma Ray Experiment Telescope (EGRET).

The CGRO spacecraft was designed and developed by TRW in Redondo Beach, CA. Table 1 presents a summary of the spacecraft subsystems. The monopropellant hydrazine propulsion subsystem consisted of "A-side" and fully redundant "B-side" sets of thrusters, feed system components and propellant tanks. Although normally inactive during science gathering, the propulsion system was to be used every 2–4 years to reboost CGRO to offset decay in orbital altitude due to atmospheric drag.

The spacecraft's propulsion subsystem had two major on-orbit anomalies during the mission. The first anomaly occurred during checkout and activation of the spacecraft after being released from the Shuttle. Immediately upon opening one of the propellant tank isolation valves, the

\* Member of AIAA

**Table 1. CGRO Spacecraft Subsystems**

<p><b>Science Instruments</b></p> <ul style="list-style-type: none"> <li>• Four main instruments (BATSE, OSSE, COMPTEL, EGRET) comprising approximately 6,300 kg (7 tons)</li> <li>• Continuous detection over 20 KeV to 30 GeV range</li> </ul> <p><b>Structure</b> (bolted aluminum box-girder framework)</p> <ul style="list-style-type: none"> <li>• Mass (loaded): 15,876 kg (35,000 lbm)</li> <li>• Body Size: 4.6 m x 5.5m x 9.1 m (21.3 m SA span)</li> </ul> <p><b>Power Subsystem</b></p> <ul style="list-style-type: none"> <li>• Solar Array Power: two accordion-style, deployable arrays generating 4300 w BOL/3980 w EOL with 396 ft<sup>2</sup> area</li> <li>• Battery Power: six Ni-Cd batteries at 50 A-hr each</li> </ul> <p><b>Thermal Subsystem</b></p> <ul style="list-style-type: none"> <li>• Uses coatings, blankets, louvers, radiators and heaters</li> <li>• Science instruments thermally isolated from spacecraft and each other</li> <li>• Redundant thermostats and heater elements</li> </ul> <p><b>Communications &amp; Data Handling Subsystem</b></p> <ul style="list-style-type: none"> <li>• Standard NASA modular design based on Solar Max and Landsat 4 &amp; 5 spacecraft</li> <li>• S-band telecom using 1.52 m (60 inch) HGA</li> <li>• Two omnidirectional LGAs</li> <li>• Two second generation TDRSS transponders</li> <li>• Uplink at .125 or 1.0 Kbps; downlink at 32 Kbps (256-512 Kbps via TDRSS)</li> <li>• Two NASA standard tape recorders for playback at up to 512 Kbps via HGA and TDRSS</li> <li>• Advanced clock for time accuracy to .0001 second</li> </ul> <p><b>Attitude Control &amp; Determination Subsystem</b></p> <ul style="list-style-type: none"> <li>• 3-axis stabilized, zero momentum biased control system using reaction wheels with magnetic unloading</li> <li>• attitude sensors <ul style="list-style-type: none"> <li>◦ Fixed head star trackers (3)</li> <li>◦ Inertial reference gyros (4)</li> <li>◦ Coarse &amp; fine sun sensors</li> </ul> </li> <li>• Attitude control <ul style="list-style-type: none"> <li>◦ Reaction wheel assemblies (4)</li> <li>◦ Monopropellant rocket thrusters (8)</li> </ul> </li> <li>• Single target pointing control for up to 14 days</li> <li>• Pointing control to <math>\pm 0.5^\circ</math>; measurement to <math>\pm 0.03^\circ</math></li> </ul> <p><b>Propulsion Subsystem</b></p> <ul style="list-style-type: none"> <li>• Hydrazine propellant: 1924 kg (4240 lbm), High Purity</li> <li>• GN<sub>2</sub> pressurant: 17.2 kg (38 lbm)</li> <li>• Four 440 N (100 lbf) Orbit Adjust Thrusters</li> <li>• Eight 22 N (5 lbf) Attitude Control Thrusters</li> <li>• "Blowdown" operating pressure: 2760 kPa (400 psia) BOL to 600 kPa (87 psia) EOL</li> <li>• Four titanium propellant tanks, each with AFE-332 diaphragm</li> <li>• On-orbit refueling module</li> <li>• Safety compliant with NHB 1700.7A</li> </ul>
--

A-side propellant manifold, telemetry indicated that two of the isolation valves had uncommanded changes in the open/close position status and one of the pressure transducers indicated "over-limit" pressure. Since the science activities were not affected, re-activation of the propulsion system was postponed until April 1993 at which time the Observatory orbit had decayed to 350 km.

This two-year interval allowed a comprehensive analysis of the anomaly and detailed development of corrective actions. Ground tests and analyses concluded that, in spite of being "fully" loaded with hydrazine, the A-side propellant manifold had been exposed to very high surge pressures (a "waterhammer" transient). To prevent reoccurrence, a method was successfully developed to safely prime the B-side manifold by opening the isolation valves for very short durations to slowly raise the hydrazine pressure in the downstream manifold to design operating pressure. The B-side Attitude Control Thruster (ACT) manifold was successfully primed April-July 1993 in preparation for restoring the orbital altitude of CGRO to 450 km.

The second propulsion subsystem on-orbit anomaly occurred during the calibration burn segment of the orbit raising operation. The plan was to raise orbit using only the four B-side ACTs. During the test burns, one of the ACTs (designated "ACT-B2") produced unacceptably low thrust. Ground tests determined that the low thrust was most likely related to flexing of the thruster valve seal at high propellant mass flow rate.

To compensate for the low thrust, two of the four Orbit Adjust Thrusters (OATs) would be needed to maintain attitude control during the orbit raising burns. The B-side OAT manifold was successfully pressurized using procedures previously employed to prime the B-side ACT manifold.

The first orbit reboost of the CGRO was completed in December 1993 and restored the orbit to 450 km circular from a low point of 350 km. As predicted, the performance of ACT-B2 became nominal as the operating flow rate decreased, a natural result of the propellant tank pressure decay in blowdown mode. A second orbit reboost was performed in March-June 1997 with nominal performance on all B-side ACTs and OATs.

The propulsion subsystem performed flawlessly during four critical, controlled re-entry burns that ended the CGRO mission on June 4, 2000.

## OVERVIEW OF PROPULSION SUBSYSTEM

Figure 2 shows the propulsion subsystem complete on a buildup fixture prior to transfer to the spacecraft structure. Figure 3 is a schematic of this subsystem. CGRO was the first scientific spacecraft designed for on-orbit refueling of propellant. The on-orbit refueling module contained a NASA-supplied propellant coupling.

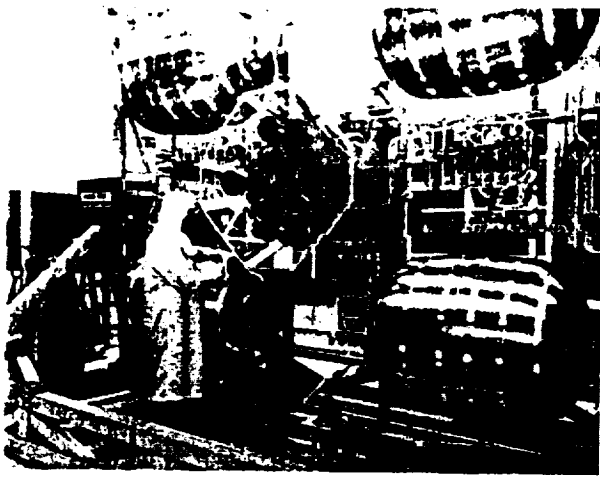

**Figure 2. CGRO Flight Propulsion Subsystem**

The propulsion subsystem consisted of A-side and fully redundant B-side sets of thrusters, feed system components and propellant tanks. As will be seen, it is significant that this design featured functional redundancy with fault isolation capability. Crossover isolation valves permitted full utilization of propellant and provided capability for center-of-mass management by control of the quantity of propellant used from each tank. Details of the design and development of the CGRO propulsion subsystem were given in a previous paper<sup>3</sup>.

The mission tasks for the propulsion subsystem were to provide:

- Orbital altitude restoration (drag make up)
- Attitude control during reboost
- Descent for refueling and on-orbit servicing
- Ascent (from STS servicing orbits)
- Descent for STS retrieval or controlled reentry
- Provide safe hold operating mode in event of loss of gyroscope stabilization.

The system was designed to operate in a pressure blowdown mode over a range of 400 to 87 psia. The four 440 N OATs were to be fired simultaneously to provide  $\Delta V$  impulse for orbit altitude change, orbit maintenance, descent for refueling, ascent and controlled reentry. The OATs were placed on the spacecraft X and Y axes with thrust vectors parallel to the Z-axis (see Figure 2). The OATs were to be off-modulated to provide primary attitude control about the spacecraft pitch and roll axes during the  $\Delta V$  firings. The 22 N ACTs were to provide primary yaw attitude control during operation of the OATs. In the event that one of the OATs failed during firing, its geometric opposite would be automatically shut down and impulse would continue to be provided by the remaining OAT pair.

The ACTs were canted off the spacecraft Z-axis and, when fired appropriately in pairs, could provide control

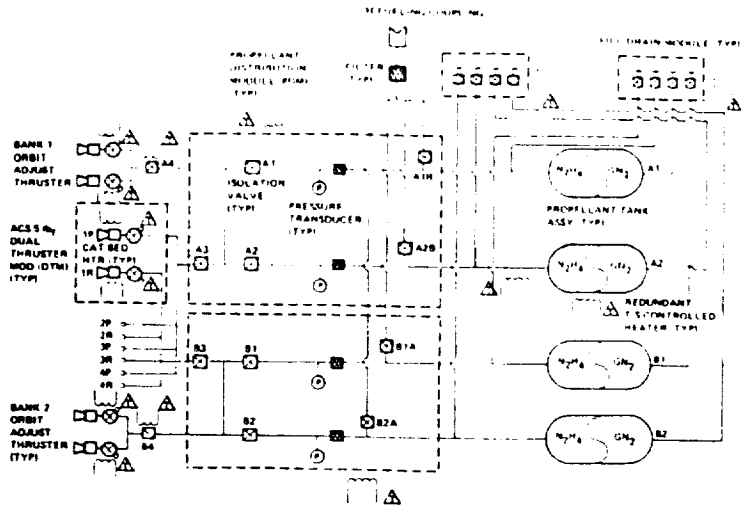

**Figure 3. CGRO Propulsion Subsystem Schematic**

torques about any of the three spacecraft axes. They provided primary yaw control and secondary pitch and roll control during OAT firings. Thrust levels and moment arms about the spacecraft center-of-mass were such that the ACTs could provide complete three-axis control at all times. They were to operate primarily in a pulse mode, but were designed for steady-state operation—a design feature that was used when they were required to backup the OATs for altitude raising.

Of particular significance to following discussions, the subsystem employed multiple latching isolation valves (indicated in Figure 3) to direct and lock off propellant flow. The design of the isolation valve is shown in Figure 4. It is a pressure-balanced, dual coil, solenoid-operated latching shutoff valve with downstream backpressure relief capability. The design features a closure spring to hold the valve closed and a permanent magnet latch to hold the valve open without continuous power drain. The inner solenoid coil is powered to open the valve and the outer coil is powered to close the valve. The critical

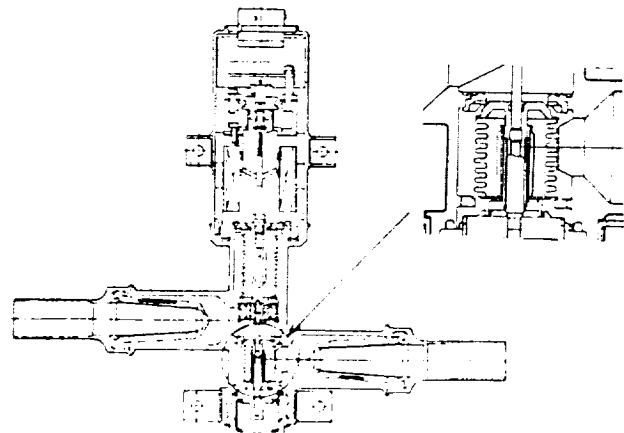

**Figure 4. CGRO Latching Isolation Valve Design**

surface of the poppet is spherically shaped to close on a teflon ring seal. The solenoid and trim (closure) spring are hermetically sealed from propellant by welded bellows assemblies. The spring assembly controlling the backpressure relief function is exposed to the fluid. A 100-micron absolute wire mesh filter is installed in each of the fluid ports. A position switch assembly, which electrically indicates valve position, is located at the top and is integral with the valve. Other than being damaged by above-specification overpressures during the A-side priming attempt, the latching isolation valves performed nominally during the nine years of on-orbit life. Moreover, it was this valve's beyond-specification capability to respond to millisecond-level pulse commands that ultimately provided a means to safely prime the subsystem B-side, thereby enabling the CGRO mission to continue with low risk.

### PROPELLANT LOADING SEQUENCE AND ISSUES

The propulsion system was designed for a STS launch, incorporating two-fault tolerance for propellant leakage and planning to launch "wet" to the thruster valves but unpressurized (at atmospheric pressure) downstream of the tank isolation valves A1, A2, B1 and B2.

In conducting normal leakage tests using nitrogen gas, the leakage rates of isolation valve A2 and crossover isolation valve B1A were determined to exceed specification. The valve leakage problems occurred late in the program, resulting in a Noncompliance Report. A condition for approving CGRO for launch was "demonstration of no continuous liquid leakage" in the launch configuration. This demonstration was accomplished by a partial fueling operation in June 1990 at which time 15 lbm of hydrazine was loaded into the A-side of the system. The system was monitored for liquid leakage; none was observed and therefore launch was approved.

The partial fueling contributed to the surge problem because a different propellant loading system was used for this small mass of propellant.

The loading operation was as follows. Tank A1 fuel and gas fill and drain valves and isolation valves A1, A4, and A3 were opened. The tank was vented and evacuated to 26 inches of mercury (Hg). The gas fill and drain valve was closed and the fuel side evacuated to "30 inches of mercury" (gauge resolution). 15.7 lbm of hydrazine was loaded and the fuel fill and drain valve (FDV) closed. The gas FDV was then opened and pressurized to 15.1 psia. Isolation valves A1, A3 and A4 were then closed and the tanks pressurized to 430 psia. The system was monitored for leakage for 5 days before depressurizing the A-side tanks to 25 psia.

The importance of the above operation is that the "partial fueling" operation utilized a hydrazine supply

consisting of a small tank pressurized to 50 psig (65 psia). This tank's storage time and handling were sufficient for the propellant to become fully saturated with nitrogen gas at 65 psia. Nitrogen gas bubbles which eventually formed in the propellant feed lines came from two sources: residual nitrogen in the system prior to filling (imperfect vacuum), and nitrogen that came out of solution from the hydrazine due to depressurizing the lines to 25 psia until launch and deployment.

The system vacuum before loading hydrazine was estimated at 10 torr (gauge read "30 inches " mercury). This yields a volume ratio of 1.3% when re-pressurized to 14.7 psia. The volume of nitrogen coming out of solution from the hydrazine is less clearly defined. First, available references for nitrogen solubility in hydrazine give different values. It is also unclear how much can be redissolved. The resultant bubble volume ratio ranges from 0.72 to 1.88%. Overall, the combined bubble volume ratio is somewhere between 2.0 and 3.2%. This yields a bubble length of 5.9 to 9.3 cm in the lines between the tank isolation valve (A1) and the thruster isolation valves (A3 & A4), based on a 290 cm total line length. It is also difficult to assess where the bubbles may have collected during the filling process, further complicating the definition of bubble size and location. Analyses and tests described below evaluated the effects of bubble size and location to span the probable distributions.

In January 1991, the B-side manifold, the tank crossover manifold (on-orbit refueling coupler, isolation valves A1B, A2B, B1A, B2A) and the four propellant tanks were loaded with "High Purity Grade" hydrazine using a unique propellant loading system developed by TRW. The propellant loading system incorporated an air-driven positive displacement pump to transfer propellant, an electronic mass flowmeter to monitor the rate of propellant being loaded, and a reservoir propellant tank to remove entrained bubbles before being supplied to the propellant pump.

CGRO was loaded with a total of 1924 kg (4240 lbm) of hydrazine distributed evenly among the four propellant tanks. After closing all of the isolation valves in the propulsion system, the propellant tanks were then pressurized with nitrogen to a flight pressure of 390 psia.

### INITIAL SYSTEM PRIMING EVENT (A-SIDE)

At the completion of the isolation valve leak integrity demonstration and final propellant loading and flight pressurization, the propulsion system was left in the following configuration for launch:

- Hydrazine loaded to the thruster valves
- Manifolds between A-side thrusters and isolation valves A1, A2, A3 and A4 pressurized to 14.7-15.1 psia
- Crossover manifold (on-orbit refueling coupler, A1B, A2B, B1A, B2A) pressurized at 14.7-15.1 psia

- Propellant tanks and manifold down to isolation valves A1, A2, A1B, and A2B pressurized to 390 psia
- B-side propellant tanks and manifolds loaded and pressurized in similar manner as A-side
- All A-side and B-side isolation valves, including all crossover isolation valves, were closed from launch through being released from the Shuttle arm.

On April 7, after being released and establishing the required "safe distance" from the Shuttle, activation of CGRO propulsion was started. Following nominal pre-established planning, the propulsion subsystem activation procedure consisted of a series of commands to open A-side thruster isolation valves in the following sequence: A3, A4, A1, A2. The commands and telemetry responses were:

COMMAND	TELEMETRY
OPEN ISO A3	A3 OPEN
OPEN ISO A4	A4 OPEN
OPEN ISO A1	<ul style="list-style-type: none"> <li>• A1 CLOSED</li> <li>• A1B OPEN</li> <li>• Tank A1 Pressure Transducer Reading Full Scale (510 psia)</li> </ul>

Review of telemetry data confirmed that the anomaly had not affected the health of the rest of the spacecraft. A decision was made to secure the propulsion subsystem and to postpone activation of the subsystem until 1993, when orbit raising of CGRO was anticipated to be necessary.

Suspecting that the propulsion subsystem manifold may have been subjected to unexpectedly high surge pressures, isolation valves A1, A3, A4, A1B were commanded closed to minimize the chance of propellant leakage from potentially damaged lines and components. All valves except crossover A1B were verified to be closed following commanding. The fact that A1B did not show a response to a valid command indicated either that the valve was mechanically damaged and could not function, or that the valve's position indicator had been damaged and was no longer reliably reporting the valve position state.

A team was formed at the NASA GSFC and TRW-Redondo Beach to investigate the anomaly and to assess options for safely activating the CGRO propulsion system<sup>4,5,6</sup>. The results of the investigation were distributed to the NASA centers and to the aerospace industry. This included dissemination of the anomaly and most probable cause via the GIDEP alert system<sup>7</sup>.

#### ANOMALY IMMEDIATE CAUSE DETERMINATION

Initial review of the propulsion system and component design data, spacecraft telemetry data, and

historical precedents quickly concluded that the following events had occurred during the priming sequence:

- Tank isolation valve A1 opened as commanded
- When valve A1 opened, rapid propellant flow occurred resulting in a pressure surge or "waterhammer"
- The pressure surge overstressed the Tank A1 pressure transducer sensing element, causing a "zero shift" that resulted in an off-scale high reading
- The pressure transient, flow surge, and/or resulting dynamic excitation of the fluid system caused the crossover isolation valve (A1B) to change from a "closed" to "open" state, and caused the tank isolation valve (A1) to change from an "open" to "closed" state.

Although there were no indications of propellant leakage through any of the A-side thruster valves, there were significant concerns as to the ability of the A-side isolation and thruster valves to function properly and repeatedly following exposure to high transient pressures. Consequently, an extensive program of analytical modeling and ground testing was undertaken with the objectives of:

- (a) determining whether the CGRO mission should be continued on the A-side or B-side,
- (b) determining least-risk method restoring propulsion subsystem function, and
- (c) establishing the fundamental ("root") cause of the priming pressure transient.

#### SYSTEM ANALYSIS AND MODELING

A coordinated analysis effort was undertaken at TRW to model and understand the dynamic behavior of the GRO propellant supply system. In conjunction with the analytical effort, experiments were conducted at TRW to validate the analysis model. The test setup mimicked the flight configuration for critical parameters such as line diameter, line lengths, number and location of sharp bends, and location of valves. Developmental isolation valves of the same design as used on flight were incorporated in the setup to insure proper transient response to valve opening and closing. Test series were conducted using both water and hydrazine. The analysis model was exercised to predict the pressure spikes and natural frequency response for each test/bubble configuration. A key objective of this work was to use the empirically-calibrated analysis model of the flight system to support decisions on pending activation of CGRO propulsion.

Analysis Model. It is customary to use a lumped parameter approach to study the transient behavior of liquid flow in a complicated propellant feed system. The popularity of such an approach is due to its simplicity and numerical efficiency. In the lumped parameter approach,

spatial variation is ignored, resulting in a set of ordinary rather than partial differential equations. These ODE's can be readily solved by standard integration algorithms, such as Runge-Kutta method.

Various assumptions were made to arrive at the final analysis model. First, the flow was assumed to be incompressible and isothermal. As a result, the energy equation was not considered in the system. This assumption was definitely valid because the Mach number of the flow (either single phase or two-phase) is typically about .001. Another key assumption is that the propellant flow was fully turbulent. Again, this assumption was valid because the typical Reynolds number during the priming event was about  $6 \times 10^4$ , well exceeding the transition Reynolds number of 2000.

The lumped parameter approach appears to be sound. In a system that consists of only a pipe with high pressure at the entrance, it can be shown that closed-form solutions for the natural frequency and pressure history exist. Furthermore, the peak pressure is predicted to be approximately two times the initial pressure difference. Such a simple system corresponds to TRW's Series I (calibration) tests, in which a factor of two of initial pressure difference was observed.

For a more complicated system, such as the flight subsystem and corresponding ground test simulated system, however, numerical analysis (i.e., computerized time-marching calculations) is necessary to predict pressure levels and transients responses. Due to pressure wave interactions arising from complex hydraulic configurations, much larger overpressures were calculated and measured than are estimated from closed form calculations based on simple pipe approximations. The results of the detailed modeling are discussed below.

Empirical Calibration of Model and Comparison of Results. Comparisons between model predictions and test data at various transducer locations were made for tests involving liquid water and initial pressure differences ( $\Delta P$ ) across the latching isolation valve of 50, 100 and 375 psid. In the following comparisons, predictions of the pressure history were made using pressure drop losses across valves based on scaling from specification values, and pressure drop losses along the lines according to standard Moody diagrams.

Comparisons between tests and analysis with water yielded peak pressure and frequency results of the decaying pulses typically within 15 percent of each other. This was true for initial  $\Delta P$ s of 50 psid and 100 psid. The actual decay rates of the pressure pulses were quite a bit faster than calculated, which is due to a smaller amount of damping in the model as compared to the tests.

Examples of these results are shown in Figures 5 and 6. It should also be noted that the pressure ratio of peak pressure after opening the valve to the pressure differential before opening the valve is approximately 5 at

one location ( $K_1$ , per Figures 5 and 6) in the system and 7 at another location ( $K_2$ , per Figure 7).

The same types of tests were done with hydrazine. The peak pressures were, as expected, slightly higher due to the difference in bulk modulus as compared to water (see Figures 8 and 9).

In the last test using hydrazine, performed with a  $\Delta P$  of 375 psid, the A3 valve was closed to prevent too high a pressure peak in this part of the system. Note that at station  $K_1$  the ratio of peak pressure to initial  $\Delta P$  was 5 for both analysis and test, as it was for other tests having lower initial  $\Delta P$  (50 and 100 psid) across the isolation valve.

## GROUND TESTS

The CGRO propulsion subsystem on-orbit anomaly investigation included a comprehensive review of spacecraft-level ground tests, including electrical circuit testing. No credible mechanism was identified that related errors in commands or electrical miswiring to the telemetry response observed during the A-side activation anomaly.

Supported by the surge pressure analytical model (which was calibrated by testing) and by test data using a high fidelity mockup of the CGRO propulsion manifold, the anomaly investigation team reached the following key conclusions<sup>3,5,6</sup>:

- ◆ Larger-than-expected bubble volume was likely left in the manifold downstream of thruster isolation valves A1, A2, A3, and A4 during propellant loading. The primary sources for the large bubble(s) were inadequate evacuation of the propulsion system and nitrogen gas coming out of solution from the hydrazine. The analysis indicated that 2-3.2 percent (5.9-9.3 cm of line length) of the long, large diameter manifold volume may have contained bubbles.
- ◆ Two key errors were cited as the cause of the large trapped bubble volume in the manifold. The first error was the use of a low resolution vacuum gauge on the propellant loading ground support equipment. The second error was the oversight in allowing isolation of the manifold at pressure much lower (14.7-15.1 psia) than the "pad" pressure (65 psia) of the hydrazine supply tank used in the leak integrity demonstration test.
- ◆ The transient flow model developed by TRW showed reasonable correlation to ground test data. It was a useful analytical tool to assess pressurization options for the CGRO propulsion system. The model revealed that the resultant pressure was highly sensitivity to the location and size distribution of the bubbles.

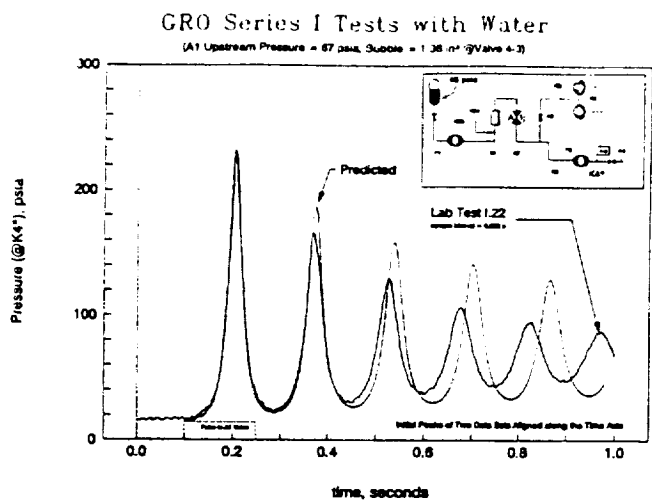

Figure 5. Water/1.36 in<sup>3</sup> Bubble/67 psia Tank

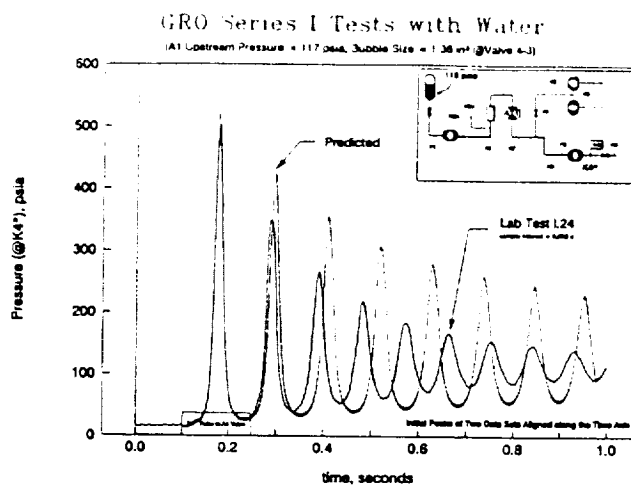

Figure 6. Water/1.36 in<sup>3</sup> Bubble/117 psia Tank

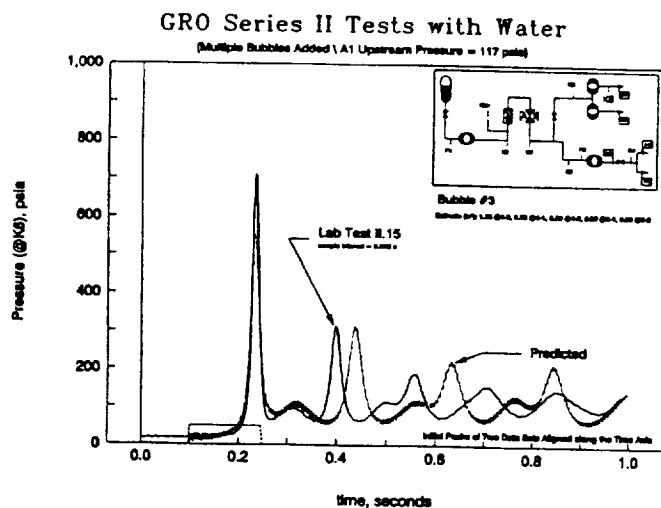

Figure 7. Water/Multiple Bubbles/117 psia Tank

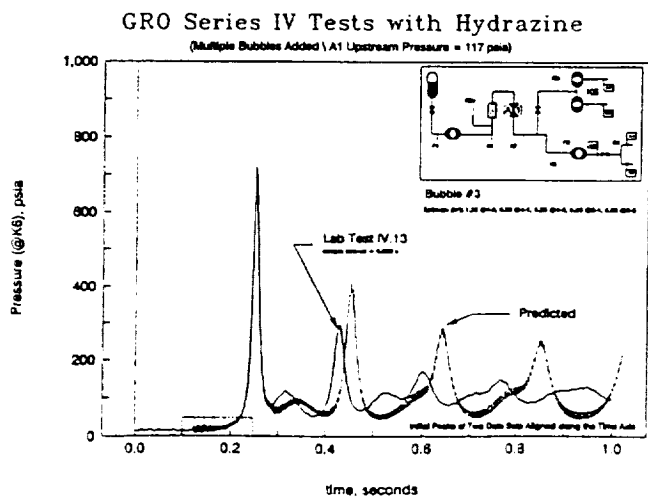

Figure 8. Hydrazine/Multiple Bubbles/117 psia Tank

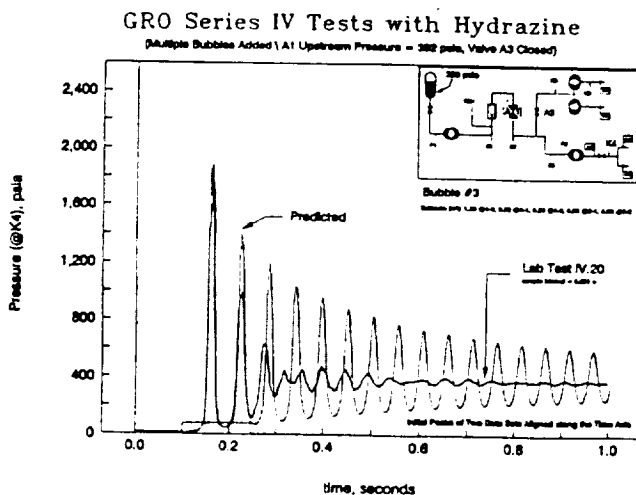

Figure 9. Hydrazine/Multiple Bubbles/392 psia Tank



- A method referred to as "fast cycling" of the isolation valve—opening the isolation valves for very short duration—was demonstrated to be a viable option to safely raise the hydrazine pressure in the manifold to design operating pressure. Using breadboard electronics and refurbished isolation valves, TRW showed that the valve could respond to a command sequence consisting of a valve OPEN command (command to isolation valve "open coil"), followed "N" ms later with a valve CLOSE command (command to isolation valve "close coil").

The JSC/White Sands Test Facility (WSTF) played a critical role in helping the CGRO anomaly investigation team assess risks of the candidate manifold pressurization options<sup>3</sup>. WSTF previously had performed extensive testing to characterize the likelihood of "adiabatic compression decomposition" (ACD) in hydrazine propulsion systems. The basic mechanism of ACD is that a rapid compression of a gas bubble containing hydrazine vapor will heat the gas, which in turn might initiate rapid decomposition of the hydrazine vapor (an exothermic process), thereby causing peak pressures far in excess of the already large waterhammer pressure.

The objectives of the WSTF tests were:

- 1) determine the likelihood of ACD having occurred in the initial priming attempt on CGRO A-side manifold,
- 2) provide additional hydrazine vs. water comparison data for TRW's analytical model, and
- 3) expose an ACT valve to surge pressures of the levels analytically predicted (assuming no ACD) to help assess the state-of-health of A-side thruster valves and the risks of continuing on A-side versus attempting priming on B-side.

The WSTF test setup used simple tubing configurations that replicated CGRO manifold line lengths and diameters, but no attempt was made to replicate individual components, tees, bend angles, etc. A fast response, low pressure-drop ball valve was used in the test setup to simulate the CGRO isolation valve. This test hardware approach permitted many tests to be rapidly performed without risk to the higher value, high fidelity system mockup used at TRW.

The WSTF tests provided data for understanding how surge pressure was affected by factors such as fluid composition (hydrazine versus water), supply pressure, bubble size, and tubing diameters and lengths. Conditions that trigger significant hydrazine decomposition were difficult to define, but the resultant pressures were high enough to rupture one of the tubes during the tests.

While the TRW high fidelity propulsion subsystem mockup initially used water for testing, a final series of tests was performed using hydrazine. Nineteen hydrazine

tests were run with low pressures (67 and 117 psia) upstream and 17 psia downstream of the A1-equivalent isolation valve, and there was a final "moment of truth" test approximating the actual flight conditions with 392 psia upstream and 17 psia downstream. The resulting pressures were high enough to damage the isolation valve: it indicated "closed" only after several commands were sent to close it, and it had gross leakage in the closed position following this test. This test substantiated the suspected damage to CGRO isolation valves A1 and A1B and indicated the need to switch to B-side and use a modified priming sequence to avoid similar damage to isolation valve B1.

The analytical model, calibrated with empirical data, showed that during the on-orbit priming attempt on April 7 the A-side of the CGRO propulsion subsystem had experienced peak surge pressures that ranged from 1,200 to 4,900 psia. These levels are consistent with analysis of pressure loads required to damage the bellows assemblies within the isolation valve.

After assessing the risks and benefits, a decision was made to use fast cycling of the isolation valves on the B-side manifold. The principal advantage of the B-side manifold was that it had not been exposed to the high surge pressure. The isolation valve response characteristics could be assumed to be reasonably close to acceptance test conditions. Further, the "as-launched" pressure conditions in the manifold could be modeled more accurately in the analysis.

The fast cycling method was validated at NASA GSFC with a CGRO-like command and telemetry system and a representative mockup of the CGRO B-side propellant manifold. Key hardware in the test setup were an engineering model CGRO Electrical Interface Assembly (EIA) subdecoder, a breadboard isolation valve driver and a refurbished isolation valve. For safety reasons, water was used instead of hydrazine. The tests characterized the effect on pressurization rate due to factors such as valve pulse width (duration between commands to the isolation valve open and close coils, or effectively the "open time" of the valve), pressure downstream of the isolation valve, and spacecraft voltage. A linear displacement transducer was used to measure movement of the isolation valve poppet as a function of electrical pulse width between commands to the open and close coils. The tests demonstrated that at 8-12 ms (millisecond) open pulse widths, the valve poppet could be safely constrained to within the desired 1-8 percent of the full 90 mil (2.3 mm) stroke.

Results from tests performed at TRW were used to determine response differences between the CGRO-like command and telemetry simulators used in the tests versus the CGRO flight system. The TRW flight operations team developed and validated two critical procedures that significantly increased the reliability and

efficiency of the fast cycling technique. The first procedure assured uninterrupted blocks of electrical pulse widths to the isolation valve open/close coils, up to a maximum of 14 ms duration, using commands issued from the On-Board Computer (OBC). The second procedure was a high rate telemetry patch (64 ms sampling) for the pressure transducer. The capability to monitor transient pressures during the fast cycling operation significantly decreased the time to prime the B-side propellant manifold.

### B-SIDE ACTIVATION & SUBSEQUENT OPERATIONS

The least risk assessment by the anomaly resolution team concluded that only the B-side ACT manifold should be primed to support the orbit raising operation. The ACTs alone could perform the required orbit raising without exceeding their qualification limits. Furthermore, it was determined that the B-side OAT manifold should only be primed just prior to required use of the OATs for the controlled re-entry firings at the end of mission life.

The baseline plan for priming of the B-side ACT manifold assumed that the 64 ms/sample pressure transducer telemetry patch would not provide sufficient sampling of transient pressure data to assess the progress of the priming operation. The baseline procedure was as follows:

- Alternately fast cycle isolation valves B1 and B2 for 500 cycles increasing the valve "open" pulse widths in 1 ms increments from 8 to 12 ms
- Fast cycle isolation valve B3 for 500 cycles increasing the valve "open" pulse widths in 1 ms increments from 8 to 12 ms. On the final 12 ms set, open B3 for 1 minute
- Repeat fast cycling sequence for isolation valves B1, B2 and B3 at 300 cycles, 150 cycles, 100 cycles
- Open isolation valves B1, B3, and B2
- Fast cycle cross-over isolation valves B1A and B2A for 100 cycles increasing valve "open" pulse widths in 1 ms increments from 4 to 12 ms
- Open isolation valves B1A, B2A, A1B, and A2B.

Since about ten thousand valve open/close commands were anticipated, a 30 second wait was imposed between each fast cycle to reduce the thermal stress on the electronics.

While performing the first set of fast cycling with isolation valves B1 and B2, the 64 ms sampling of pressure telemetry was configured to increase the likelihood of capturing the initial cycles of the pressure oscillations. Having established this capability, the pressure telemetry was used to determine when to stop the fast cycling and to command open the isolation valves. Implementing this method reduced the time to complete

the priming operation in half. Roughly 3500 valve fast cycles were required to prime the B-side ACT manifold.

A second propulsion subsystem on-orbit anomaly occurred in May-June 1993 during the calibration burns segment of the orbit raising operation, using the successfully primed B-side. During the initial test firings, one of the four ACTs ("ACT-B2") produced unacceptably low thrust.

While several potential causes were investigated, evidence led to suspecting the thruster valve, in particular the valve's AFE-411 seal area. It was noted that the  $\Delta V$ s performed with relatively cool thruster start temperatures resulted in nominal performance while the  $\Delta V$ s initiated with warmer start temperatures were anomalous. Review of the test history for all the valves in the CGRO lot showed a tendency of the valve to change flow characteristics with varying temperature and exposure to certain fluids. In particular, the acceptance test data show increased  $\Delta P$  with elevated temperature. Further, it was discovered that the valve used on thruster ACT-B2 was listed on a SIR (Supplier Information Request) for anomalous "non-flow" during acceptance testing at elevated temperature. This valve was reworked and later accepted. As further evidence, early in the valve procurement a valve failed flow test (no-flow) due to elevated temperature and the use of alcohol. Both TRW and the vendor investigated the SIR problem and concluded the alcohol flow test fluid had caused the seal to swell and close off the seat opening. The investigation indicated the seal was not sensitive to exposure to hydrazine or water at elevated temperature, so it was concluded that the valve design was acceptable as long as alcohol was not used as the elevated temperature flow test fluid.

Extensive consultations with the thruster valve supplier and ground tests conducted at TRW determined that the low thrust observed on-orbit was most likely related to flexing of the thruster valve seal at high propellant mass flow rate. This was confirmed by a hot fire test series of sixteen test runs at fixed inlet pressure (350 psia) and gradually increasing valve and propellant temperature (from ambient to 220 °F). For reference, the valve temperature reported from the spacecraft during the anomaly period was in the range of 95°F to 120°F. A ground spare CGRO thruster was tested, using two separate, exchangeable valves that were similar to the anomalous flight valve with regard to flow  $\Delta P$  as measured during valve acceptance test.

At elevated valve temperatures, the thruster exhibited degraded performance for the first 14 seconds of a steady state firing, revealing that the seal material caused a flow restriction. The initial thruster chamber pressure was approximately 10% of nominal during the first six seconds of the run. Thruster temperatures and pressures confirmed that this was not a catalyst bed "washout"

condition, but rather one of restricted flow. After six seconds, chamber pressure rose to the normal value and continued such throughout the run. No spiking is observed after recovery, indicating no excess propellant was present in the catalyst bed (i.e., no washout phenomenon). The thruster demonstrated recovery to nominal operation upon the arrival of cooler propellant from the feed system.

To compensate for the low performing ACT-B2 on CGRO, two of the four OATs were required to maintain attitude control during the orbit raising burns. The B-side OAT manifold was successfully pressurized using the fast cycling method to open isolation valve B4. Approximately 400 valve fast cycles were required to prime the B-Side OAT manifold.

The first orbit reboost of CGRO was completed in December 1993. As anticipated, the thrust of ACT-B2 increased to nominal level as the propellant tank "blowdown" pressure decreased with fuel usage. The reboost operation consisted of eleven 60-second burns and seven 90-second burns, and consumed 1045 lbs (474 kg) of hydrazine.

The second orbit reboost was performed March–June 1997 with nominal performance on all B-side ACTs and OATs. The propulsion system also performed flawlessly during the critical controlled re-entry burns that ended the CGRO mission on June 4, 2000.

## SUMMARY OF KEY "LESSONS LEARNED"

### Systems Evacuation and Propellant Loading & Priming

Three areas were identified where preventive measures can be implemented to reduce high pressure surge in propulsion systems: surge pressure analysis and propellant loading procedure; component design evaluation; and system design.

1. Error: CGRO pressure surge analysis assumption of no bubbles in the manifold downstream of the tank isolation valve was incorrect.

- The propellant loading cart gauges did not have sufficiently accurate resolution to verify evacuated pressures less than 10 torr.
- In attempting to simplify the propellant loading technique to support a special valve leak test, the effect of loading supersaturated hydrazine was overlooked.

Preventive Actions: Pressure surge analyses for pressurization of the propellant manifold and during thruster operation shall include worst-case loading assumptions, as dictated by the propellant loading equipment evacuation and pressure monitoring capabilities.

There should always be sufficient time allocated for stored propellant saturation/desaturation prior to loading if large storage pressure changes are expected

to occur. Alternatively, the propellant should be pre-conditioned (i.e., saturated with the flight pressurant) to the state predicted for the on-orbit priming) prior to loading into the subsystem.

2. Error: There was insufficient design evaluation of elements in two components that were especially vulnerable to high surge pressures.

- Bellows. Deformation of latch valve bellows changes the seating force of the poppet. This change in seating force could result in leakage or an inability of the poppet to remain open under flow forces.
- Sensing Diaphragm. Overstress of the diaphragm or damage to the electronics of the pressure transducer could result in the loss of ability to accurately monitor the tank pressure.

Preventive Actions: The selection of propulsion system components shall require demonstrated qualification margin with respect to worst case surge pressure. Incorporating surge pressure reducing devices (see 3. Preventive Actions below) shall be considered as a design option to protect sensitive component elements.

3. Error: The CGRO propulsion system design did not consider use of surge pressure reducing devices. High surge pressure can occur during initial pressurization of a low pressure propellant manifold, during thruster operation, and during repressurization of isolated propellant manifolds (where pressure has been reduced by thermally induced back relief; propellant leakage from isolated thrusters, etc.)

Preventive Actions: Components to reduce the rate of leakage or to reduce the magnitude of surge pressure shall be incorporated in the design, as dictated by the surge pressure analyses, component qualification margins, and propulsion system mission operating plan. Component considerations shall include:

- Series redundant thruster valves offer single fault tolerant design and reduce leakage rate in isolated manifolds. These features present a stronger argument for allowing launching with maximum system pressure up to the thruster valves, thereby reducing surge pressure concerns associated with initial pressurization of low pressure propellant manifolds.
- Pressure surge reducing devices (e.g., orifice, cavitating venturi) can be used to protect components which are more vulnerable to high transient pressures (e.g., pressure transducers; bellows)
- High flow resistance bypass valve to slowly prime the downstream manifolds before opening the isolation valves may be needed for systems with long, large diameter lines or for systems that require

isolation of the propellant manifolds for long durations.

- Slow opening isolation valves need to be developed.

#### Parameters Monitored During On-Orbit Activation

The key telemetry that was monitored during the CGRO on-orbit priming was the propellant manifold pressure. With the 64 ms high sample rate capability, the operations team was able to capture data indicating pressure oscillations during the priming. However, incorporating faster response pressure transducers or adding capability to sample at higher data rates is not cost effective

Design changes that should be considered include:

1. Installing the tank pressure transducer on the gas-side to protect the sensor from high surge pressures. Note, however, that this defeats the capability to resolve rapid transients in the fluid manifolds, which is useful in anomaly resolution.
2. Add pressure transducer downstream of the tank isolation valves to assess pressure conditions of isolated segments of the manifold.

#### Modeling as a Problem Resolution Resource & Guide

The relatively simple one-dimensional, nonsteady, lumped parameter (or electric analog) analysis yields peak pressure results that are remarkably close to test results.

Some rather high overpressures can occur during initial priming (fill and pressurization) of complex propulsion feed systems. It is therefore imperative to do a complete non-steady flow analysis and check for waterhammer effects during the design of a propellant supply system.

The fluid transient flow model proved to be extremely valuable in establishing the anomaly root cause and in guiding flight planning and B-side operations. One of its most pivotal contributions was in showing that bubble distribution and location were major factors in the magnitude of the surge pressure. This was subsequently confirmed by tests performed by NASA GSFC.

For problem resolution, the conditions of bubble size, location and distribution are very difficult to define. More work is needed to study the transient sensitivity to bubbles during priming of an isolated manifold. To compensate for the uncertainty of bubble size and distribution, NASA GSFC relies on tests to validate its transient flow analyses (e.g., in the design of surge pressure suppression orifices).

At TRW, comprehensive fluid dynamic modeling of propulsion systems is performed routinely as part of the design effort leading up to a Critical Design Review. This modeling parametrically evaluates the effects of fill conditions, worst-case bubble loading, system priming transients, and thruster-to-thruster hydraulic interactions. On the Chandra propulsion system, such modeling

identified the need to include surge suppression orifices and venturis, and verified that no excessive waterhammer pressures would be encountered during any mission phase.

#### Adequacy Of and Need For A/B Redundancy

In the case of CGRO, the A/B redundant design of the propulsion system did increase the mission life and enable the safe, controlled re-entry operation. Due to increased subsystem complexity and costs, A/B redundancy should be most appropriate for missions that are high cost (e.g., "Great Observatories", EOS), have long duration, are a critical "national asset" (e.g., TDRSS, GOES, POES, ISS), and are manned.

Full redundancy of components should also be considered for mission critical functions where failure to complete the critical function (e.g., mid-course correction, orbit insertion) would result in mission failure. In many missions, a limited functionally redundant design (as opposed to full A/B system redundancy) should be acceptable if primary component failure would not result in a severely degraded mission.

#### Acceptance Data Trend Analysis

The sensitivity of temperature on the flow characteristics of propellant valves utilizing AFE-411 seal material was recognized early in the CGRO program. Flow tests were conducted on test valves with hydrazine and water at elevated temperatures, and all flight valves were subjected to elevated temperature acceptance tests with water. Acceptance criteria were established which were believed to be adequate for the CGRO application.

Following the ACT-B2 on-orbit anomaly, a thorough review of the acceptance test data revealed the fact that the valve used on thruster B2 exhibited flow characteristics within specification but its pressure drop at elevated temperature was notably higher than other valves in the same lot. This experience underscores the need to do a comparative review of the performance of all components, as well as a pure specification compliance evaluation. In other words, if a lot of components is within specification on a particular parameter but one or more units is noticeably different from the rest of the population, further investigation is warranted to explain the difference and its possible impact on the mission. Had such an evaluation been performed, the subject valve most likely would not have been used for flight.

#### Propulsion Testing Adequacy

Propulsion subsystems are more vulnerable to on-orbit anomalies than other spacecraft subsystems due to constraints that have been placed on systems-level testing. Whether the constraints are based on cost, safety hazards or risk to the flight hardware, the first-time use of the full propulsion subsystem is frequently on-orbit.

Ground systems-level tests could have been performed on the CGRO propulsion subsystem (or even a half-system engineering model), including ground support equipment, that would have identified the problems that contributed to either of the on-orbit anomalies (high surge pressure and ACT-B2). For instance, following CGRO, the Chandra (AXAF) spacecraft propulsion system was mocked up full size and used water as a referee fluid to verify that the system priming transients and thruster-to-thruster interactions were acceptable prior to flight. This testing validated water hammer suppression techniques and components that in large part were the result of the CGRO anomaly experience.

#### Vendor Support and Problem Resolution Teamwork

The NASA CGRO team had excellent support from TRW, organizations within GSFC, sister NASA Centers and component vendors.

The anomaly was fully understood—and the CGRO propulsion mission ultimately successful—because system and component suppliers had in-house capability to do quick turnaround tests in support of critical anomaly investigations. Today there appears to be a trend away from maintaining such a capability in many aerospace businesses.

#### **References**

1. "The Compton Gamma Ray Observatory", N. Gehrels, et. al., *Scientific American*, December 1993
2. "Compton's Legacy: Highlights from the Gamma Ray Observatory", P. Leonard and C. Wanjek, *Sky & Telescope*, July 2000
3. "The Gamma Ray Observatory (GRO) Propulsion Subsystem", J.A. Weatherly, R.A. Carlson and S.C. Hevert, *AIAA-88-3051*, AIAA/ASME/SAE/ASEE 24<sup>th</sup> Joint Propulsion Conference, July 1988
4. "Gamma Ray Observatory Propulsion Anomaly Investigation Final Report", *TRW Report No. GRO.92.63-001*, January 1992.
5. "Gamma Ray Observatory Propulsion Subsystem Pressure Anomaly Study Documentation", *TRW Report No. GRO.92.63.037*, 14 September 1992.
6. "Compton Gamma Ray Observatory Additional Propulsion Analysis Study Documentation", *TRW Report No. GRO.93.63.014*, 9 April 1993.
7. Government-Industry Data Exchange Program (GIDEP) Safe-Alert, "Propulsion System, Hydrazine", *Alert-Safe No. H6-S-94-01*, 14 April 1994.
8. "Gamma Ray Observatory Rapid Compression Special Test Data report", *WSTF Test Reports 92-261-01 and 92-261-02*, 25 September 1992.

