

34/631

To be eventually published in: 46p

Encyclopedia of Physical Science and Technology, Third Edition by Academic Press  
(Final draft dated, March 30, 2001)

**Spacecraft Thermal Control**

Gajanana C. Birur and Georg Siebes  
Jet Propulsion Laboratory  
California Institute of Technology

*Approved 10/18  
2001 123 923*

and

Theodore D. Swanson  
NASA Goddard Space Flight Center

- I. Spacecraft Thermal Control: Description
- II. Spacecraft Thermal Requirements and Space Thermal Environments
- III. Design, Analysis, and Testing
- IV. Thermal Control Hardware
- V. Launch and Flight Operations
- VI. Advanced Technologies for Future Spacecraft

**Glossary**

- Albedo** The fraction of incident solar energy that is reflected of a planetary body
- Astronomical Unit (AU)** The unit used to describe the distance from the sun. Earth's mean AU is 1.000
- Deep space mission** Missions to inner and outer planets, asteroids, or comets as opposed to earth orbiting missions.
- Direct solar flux** The direct solar thermal radiation energy per unit area incident on a spacecraft surface
- Low Earth orbit (LEO)** Orbits whose maximum altitudes are less than approximately 1,000 nautical miles. The orbit periods are about one and one half hours
- Geosynchronous Earth orbit (GEO)** An orbit in the plane of the equator whose period matches the Earth's rotation, thus, the spacecraft remains over the same location of the Earth at all times
- Multilayer insulation (MLI)** Thermal insulation used on spacecraft to reduce the thermal radiative heat loss from the spacecraft. It is made up of several layers of Mylar interspersed with a low conductive netting.
- Operating temperature range** The temperature range over which spacecraft equipment can operate safely
- Non-operating temperature range** The temperature range over which spacecraft equipment must survive without any permanent damage to the functionality of the equipment
- Planetary IR radiation** Thermal emission of a planetary body including its atmosphere

**Radiator** Any spacecraft exterior surface used for radiatively rejecting excess heat from the spacecraft to deep space. These surfaces are generally coated with high emissivity paint or other material in order to obtain maximum thermal radiation from the surface

**Radioisotope heater unit (RHU)** RHUs provide proven and reliable continuous heat to sensitive spacecraft instruments and scientific experiments for deep space missions. Each RHU provides about one Watt of heat, derived from the radioactive decay of plutonium dioxide. The RHU is contained in a protective platinum-rhodium alloy clad or aeroshell

**Radioisotope Thermoelectric Generator (RTG)** A compact space power system, which converts thermal energy from the decay of radioactive materials to electrical current through the use of solid-state thermoelectric converters. The heat may be used to produce electrical power either by a static or a dynamic conversion process. This power supplies a reliable, long-lasting source of electricity that is relatively insensitive to the chilling cold of space and virtually invulnerable to high radiation fields, such as Earth's Van Allen belts and Jupiter's magnetosphere

**Satellite** Any spacecraft orbiting a planetary body. Earth orbiting spacecraft are generally called satellites

**Spacecraft thermal control:** The discipline, which is responsible for maintaining the spacecraft and its components within their allowable temperature limits during the entire life of the spacecraft mission

**Spacecraft mission:** The objectives set out for the spacecraft for its entire life during which it is expected to function according to a set plan and return all the scientific data to earth.

**Thermal environment:** The external surrounding environment of the spacecraft that influences the thermal balance of the spacecraft and its resultant temperatures.

## I. SPACECRAFT THERMAL CONTROL: DESCRIPTION

The Thermal Control System (TCS) is an important part of any spacecraft. It helps maintain the temperatures of engineering equipment and science instruments at safe operating and survival levels during the entire life of the spacecraft. Spacecraft thermal control is essential to ensure reliable operation, long term survival, and accurate science measurements of any spacecraft.

Thermal control of the spacecraft is typically achieved by removing heat from the spacecraft parts that tend to overheat and adding heat to the parts that tend get too cold. The equipment on the spacecraft can get very hot if it is exposed to the sun or have internal heat generation. The parts also can get very cold if they are exposed to the cold of deep space. The spacecraft and instruments must be designed to achieve proper thermal balance. The combination of the spacecraft's external thermal environment, its internal heat generation (i.e., waste heat from the operation of electrical equipment), and radiative heat rejection will determine this thermal balance. It should also be noted that this is seldom a static situation; external environmental influences and internal heat

generation are normally dynamic variables which change with time. For example, spacecraft in orbit around Earth or another planet will have a variable external environment if their orbit passes through the planet's shadow. Each temperature control design is unique to the mission for which it is developed.

### **A. Thermal Control System Components**

The actual hardware that makes up the spacecraft TCS includes radiators, Multi Layer Insulation (MLI) blankets, two-phase devices (such as heat pipes, capillary pumped loops and loop heat pipes), mechanical louvers, thermal straps, heaters, Radioisotope Heater Units (RHUs), thermostats, temperature sensors, mechanical pumps to circulate heat transfer liquids, and thermal switches. Most of the TCS components are passive elements and generally do not involve any mechanical motion in order to function. Mechanical louvers are one exception since they use bimetallic actuators that rotate the louver blades depending on the temperature of the spacecraft surface louver is mounted on. Mechanical pump is another exception where a pump is used circulate a liquid to transfer heat from one spacecraft location to other. A detailed description of the various TCS components is given in Section IV.

All spacecraft whose mission does not require them to go beyond a distance of greater than 1.6 AU from the Sun use photovoltaic solar arrays to generate electric power. The solar arrays on spacecraft are either body mounted panels or deployable arrays. A picture of a typical earth orbiting spacecraft is shown in Figure 1 with its thermal control system. Two deep space spacecraft are shown with their thermal control systems in Figures 2 and 3. The Mars Pathfinder spacecraft, shown with its thermal control system in Figure 2, used solar arrays as the power source since the maximum distance of the spacecraft from the Sun during the mission was less than 1.55 AU. The Cassini spacecraft, designed for a mission to the planet Saturn, is shown in Figure 3. Spacecraft designed for missions to planets beyond Mars typically do not use solar arrays as a power source as the sun's rays are increasingly weak. Instead they have RTGs, a nuclear energy source, to power the spacecraft.

### **B. Spacecraft mission category**

Most spacecraft can be classified as either earth orbiting or deep space spacecraft. Earth orbiting spacecraft, also called satellites, are specifically designed for two types of applications: earth resources and scientific. The earth applications include communications, meteorology, and earth resources. The scientific applications include scientific investigation of earth and its environment, stars and other planets in the solar system, and stars, galaxies, and the universe in general. The deep space spacecraft are designed for missions to planets in the solar system and are primarily for scientific applications. These include missions to inner planets such as Mercury and Venus and outer planets such as Mars, Jupiter, Saturn, Neptune and Pluto and special locations such as the Lagrangian points.

Earth orbiting missions can be generically classified as low earth orbit (LEO), Geosynchronous Earth orbit (GEO), or Molniya orbit. The LEO spacecraft have an orbit altitude of less than 1000 nautical mile and are used for communications, military, and scientific applications. Generally, the orbits are approximately circular but some are elliptical. One type of LEO is the sun synchronous orbit where the orbit plane of the spacecraft is maintained at a nearly fixed angle relative to the sun. This allows the spacecraft to cross the equator at the same local earth time during each orbit. Synchronous orbits are typically used for meteorological and earth resource applications. In designing LEOs, the key challenge of thermal control is to maintain acceptable temperatures for the scientific equipment on the spacecraft. Another key TCS requirement is that the spacecraft temperature be maintained above the minimum survival limit during the spacecraft safe mode when the solar arrays are not pointed to the sun and the only power available is from the onboard battery.

The GEO spacecraft are stationed about 24,000 miles above a particular location on earth and typically used for civilian and military communications and meteorological purposes. They are always in a fixed orientation with respect to earth and rotate along with the earth. At this altitude the spacecraft is in the sun most of the time. The maximum eclipse duration is 72 minutes out of a 24-hour orbit. These spacecraft tend to be communication satellites and as such are very high powered (1 to 10 kW) and the thermal control system needs to remove the heat to keep the transmitters, electronic equipment, and scientific equipment within safe operating and survival temperatures.

Molniya orbits are unusual and characterized by having a very high degree of eccentricity (i.e., they are very elliptical) and have a high inclination angle. Their perigee may be as low as a few hundred miles while their apogee can be many thousands of miles. Accordingly, they go through a wide range of thermal environments. At perigee the earth albedo and earth IR loads are greatest, and there may be free molecular heating caused by a rapid passage through the earth's tenuous, but not negligible, upper atmosphere. At apogee the spacecraft is far away from earth and only solar induced loads are important. For all these types of missions, the actual launch environment and transfer orbital maneuvers, from LEO to GEO for example, must be considered before finalizing the thermal design.

Deep space missions includes planetary orbiters, flybys, landers, rovers, and sample return missions. Examples of planetary orbiters are the Galileo spacecraft, which orbits Jupiter, and the Cassini spacecraft, which will be orbiting Saturn. These spacecraft also flew by several planets before reaching their destinations. Mars Global Surveyor is orbiting and mapping Mars. Mars Pathfinder carried a lander and a rover to Mars in 1997. The Stardust spacecraft is a sample return mission to comet Wild and will bring comet dust back to earth in year 2005. The thermal control challenges in these spacecraft are the varying thermal environments due to the distance from the sun, planetary surface thermal environment and the operation of the instruments on the spacecraft. In addition, the thermal environment of the spacecraft is continually changing from launch to final destination, which requires the TCS to be robust enough to meet the spacecraft thermal requirement. For missions to planets beyond Mars, solar power is not an option because

of the low levels of solar flux at those distances. A Radioisotope Thermal Generator (RTG) is the only option that has been used for these missions.

## **II. SPACECRAFT THERMAL REQUIREMENTS AND SPACE THERMAL ENVIRONMENTS**

There are two factors that determine the development of the thermal control system for a spacecraft. The first factor is the type of thermal requirements for the various engineering and science instruments onboard. As described earlier, the equipment has specific temperature limits within which it will reliably operate or safely survive. Some of the sensitive science equipment may have stringent temperature requirements, whereas some engineering equipment may operate and survive over a wide range of temperature. The second factor is the thermal environment in which the spacecraft has to operate during its mission life. The environments include ground, launch, and space. The space environment depends on whether the particular mission is earth orbiting or a deep space.

### **A. Spacecraft Thermal Requirements**

The spacecraft equipment is generally divided into several subsystems, depending on their function. The standard subsystems on the spacecraft are power, propulsion, telecom, mechanical, thermal, avionics, and science. Each of these subsystems has equipment with specific temperature requirements for reliable operation. These requirements are classified as operating and non-operating requirements. The operating temperature requirements consist of upper and lower limits within which the equipment will safely operate. Similarly the non-operating temperature limits refer to upper and lower limits beyond which the equipment may be permanently damaged.

The temperature limits of various equipment used in the Mars Pathfinder spacecraft are shown in Table 1. As stated earlier, the temperature requirements of a spacecraft depend on the particular equipment carried on the spacecraft. For instance, the hydrazine propellant used on the Pathfinder spacecraft had a lower allowable limit of 10 C, since hydrazine freezes at 2 C. If another propellant were to be used in the spacecraft, the temperature limits would be different. In Table 2 the thermal requirements of a typical spacecraft in a Molnia orbit are shown.

These thermal design requirements are considered specified performance parameters for a given set of conditions. Final performance of the spacecraft is compared to these requirements and validated by either test or analysis. Thermal design requirements are most typically expressed as temperature requirements, but it is not unusual that temperature requirements are also accompanied by requirements addressing temporal temperature stability, spatial gradients, heat flow, and minimum duration for the survival of arbitrary extreme conditions.

Temperature requirements are specified in terms of ranges. Commonly, the temperature range over which the spacecraft is expected to function during nominal operation is referred to as the *Allowable Flight* temperature range. Ultimately, the design is tested over temperature ranges that include a predetermined amount of margin on both sides of this Allowable range. This second range is referred to as *Qualification or Protoflight* range. The spacecraft is expected to function in a predictable manner inside these extended ranges and is also expected to return to performance within specification once temperatures return to the Allowable Flight temperature range. Assembly level tests are performed at the limits of the Protoflight temperature range and the spacecraft is ~~sometimes~~ typically exposed to several temperature cycles between extremes or to long dwell times at the extremes. **This is especially true for Earth orbiting a spacecraft that will be in a cyclic thermal environment as it goes in and out of the Earth's shadow.** The various temperature ranges and the margins normally used in spacecraft design and testing are shown in Figure 4.

## B. Spacecraft Thermal Environments

The thermal environment of the spacecraft is from the external heat sources incident on the spacecraft. The key drivers for the external thermal environment are direct solar, albedo, planetary infrared thermal radiation, and cold deep space. The external environment varies depending on the mission category; earth orbiting spacecraft will have different external thermal environment than will the spacecraft of a planetary mission.

Direct solar radiation has the highest energy content of the sources making up the external environment. The magnitude of the direct solar incident energy on a surface normal to the Sun (also called the solar irradiance) is calculated using the following equation.

$$q_{\text{solar}} = 1367.5(\text{Watts/m}^2)/(\text{AU})^2 \quad (1)$$

For a spacecraft in thermal equilibrium receiving heat only from the Sun and losing heat to space by radiation and *with no internal heat generation*, the heat balance equation reduces to

Absorbed sunlight = Heat radiated to deep space

$$A_P q \alpha = A \sigma \epsilon T_{SC}^4 \quad (2)$$

And the temperature of the spacecraft,  $T_{SC}$ , becomes

$$T_{SC} = (q A_P \alpha / (\sigma A \epsilon))^{1/4} \quad (3)$$

Where

- $A_P$  = Projected area to Sun ( $m^2$ )
- $A$  = Total exposed area ( $m^2$ )
- $q$  = Solar irradiance ( $W/m^2$ )
- $\alpha$  = Surface absorptance in the solar wave band
- $\epsilon$  = Thermal emittance
- $\sigma$  = Stefan-Boltzmann constant,  $5.67 \times 10^{-8} W/m^2 K^4$

The temperature of a spacecraft in sunlight at various distances from the Sun can be computed from Equation 3 using corresponding values of solar intensities. The temperature as function of the two ratios,  $\alpha/\epsilon$ , and  $A_P/A$  is shown in Figure 5 for the solar intensity at Earth. The temperature of a black sphere at different distances, corresponding to various planets, from the Sun is shown in Figure 6.

The next significant thermal environment contributor is albedo, the fraction of the solar energy incident on the planetary body that is reflected. Albedo values range from very low (0.0073 for the Moon) to relatively high (0.8 for Venus). For a spacecraft in LEO the orbital average albedo varies from about 24% to 42%, depending on orbital inclination. The other contributor to the thermal environment is planetary infrared thermal radiation. This is thermal emission from the planet including its atmosphere. For a spacecraft in LEO the orbital average earth IR varies somewhat depending on orbital inclination, but is generally about  $251 W/m^2$ . -All these contributors are shown in Figure 7 for an earth orbiting spacecraft. ~~The Direct Solar, Albedo and Planetary Infrared for LEO and GEO missions are given in Table 3. Note: I suggest deleting this table as albedo varies a lot.~~

The TCS of spacecraft for missions to planets must be designed to handle the relevant thermal environment. Thermal environmental data for various inner planets are given in Table 4. For an orbiting spacecraft with a fixed view of the planet, the incident thermal flux on the various surfaces of the spacecraft can be significantly different and has to be taken into account in the spacecraft thermal design. The significant thermal environment the spacecraft would be exposed to for most of these planetary bodies consists of the direct solar flux and the planetary infrared energy.

The thermal environmental fluxes for outer planets are orders of magnitude smaller compared to the inner planets. Thermal environment for the outer planets is shown in Table 5. The TCS design of a spacecraft for these planets is generally driven by the need to minimize the heat losses from the spacecraft. However, one of the biggest TCS design challenges is to satisfy the thermal requirements during the entire mission with the same spacecraft travelling to both inner and outer planets during its mission.

Any power generated by a photovoltaic array or on-board source, such as an RTG, must also be considered in the thermal design as this electricity (less any radiated away by radio transmitters, lasers, or other such devices) will eventually degenerate to

waste heat. Such waste heat generation will occur at different locations throughout the spacecraft and can further complicate the task of achieving proper temperature levels.

### **III. DESIGN, ANALYSIS, AND TESTING**

Spacecraft thermal design can be defined as a collaborative process to control the thermal energy flowing throughout the spacecraft system in such a way that thermal requirements are met during the entire life of the mission while minimizing the use of all resources. The resources include mass, electrical power, cost and labor to implement the design on the spacecraft, and to operate the spacecraft during its flight. Both analysis and testing form an integral part of the thermal design process.

The mention of temperature control is noticeably absent from this definition. This is for a reason. Temperatures manifest themselves as the results of a heat flow. Only by changing the heat flow can temperatures be changed. This is an important realization. For each spacecraft, a certain amount of heat is dissipated internally. This dissipation is a direct consequence of operating devices that provide the spacecraft with the functionality for which it was designed. Externally, the spacecraft is exposed to the environment of space. The space environment ranges between extremes, from near absolute zero to the fierce heat coming from our sun. This is especially true for spacecraft orbiting a planet such that they go through its shadow. In this case they will undergo significant changes in their ability to radiate waste heat. Additionally, internally generated heat can vary significantly when electrical equipment turns on and off. Maintaining acceptable temperatures between this dynamic internal environment and the varying external environment is a formidable task.

Spacecraft thermal design is an engineering discipline that is readily defined since the underlying physics are fundamental. In all but the most unusual cases, the spacecraft thermal control engineer deals with heat transfer and thermodynamics. On the other hand, spacecraft thermal design is among the most difficult designs to implement. This ambiguity results in a challenge to thermal engineers and the outcome can have a significant impact on the success of a space mission.

The nature of the implementation challenge can be derived from the obvious, but often overlooked, fact that everything has a temperature. Since most temperatures on a spacecraft matter, most of the hardware that constitutes the spacecraft needs to be temperature controlled. This clearly identifies spacecraft thermal engineering as a system level discipline. The resulting design is distributed and integrated with other spacecraft subsystems, often undistinguishable from other hardware. By developing a design which meets the imposed temperature requirements, the thermal subsystem will invariably impose requirements upon other subsystems such as mechanical, power, and science, and in turn these subsystems will impose derived requirements upon the thermal subsystem. This iterative nature of the design process increases with the increasing complexity and compactness of the spacecraft and the complexity of the mission.



## A. Thermal Design Process

Thermal design can be described as a process activity. This activity, shown in Figure 8, is controlled, requires resources, uses inputs and produces outputs. On a high level, the thermal design **Activity** consists of managing heat flows. This activity starts in the early phase of a design, often in the proposal or conceptual phase. As this activity proceeds through various stages, the thermal engineer progresses from simple heat balance calculations and coarse computer analysis, to preliminary designs, developmental testing, increasingly more detailed computer simulations, detailed designs, the realization of the design in hardware, integration of the hardware, thermal testing to validate the design, launch related activities and finally operation of the spacecraft. The various steps of this activity are graphically shown in Figure 9.

Each organization has **Controls** governing the performance of the activities listed above. These controls can be standards. Good examples are standards for safety and quality, such as ISO9000. In addition, each organization has its own policies and best practices. While it is not possible to list all controls, it is important to emphasize that these controls are as much part of the thermal design process as any other element.

Performing the design activity requires **Resources**. Some of these resources consist of elements common to other activities, such as funding and schedule. Other resources consist of thermal control hardware, specifically designed to control heat flows, and facilities to test this hardware on various levels of assembly. These facilities are typically required to simulate aspects of the space environment, such as vacuum, solar heating and the cold of space. Other resources are a well-trained workforce, analytical simulation tools and computational facilities. Lastly, thermal design requires expenditures in mass, volume, and power on the spacecraft. These last three resources are especially valuable since they are consumed by all subsystems of a spacecraft and need to be allocated judiciously.

The thermal design activity is not performed in isolation and requires **Inputs** from other areas. These inputs typically consist of the geometric configuration of the spacecraft and the design details of subsystems. Material data are included in this input, since properties such as thermal capacitance, conductivity and IR and solar radiation characteristics are needed to perform the thermal design. Along with these properties, system and subsystem requirements are necessary inputs to the thermal design. These requirements not only specify temperature, gradient and rate of change requirements, but also establish allocations for power, mass, field of view and physical envelopes. additional inputs include definition of the space environment. The space environment is highly dependent on the mission. For example, designing for a low earth orbit is distinctly different than a designing to go to the outer or inner planets. Related to space environmental inputs are inputs derived from other requirements. These requirements can, for example, limit the material selection to only those materials that will prevent Electro Static Discharge (ESD), or those that can survive all temperatures the spacecraft will encounter throughout its life cycle, or materials which meet stringent out-gassing

and/or particulate contamination specifications. While not a direct thermal requirement, exclusion of certain materials will certainly have an effect on the thermal design.

A critical input to the thermal design activity is the power dissipation of each assembly in various operating modes of the spacecraft and the more detailed duty cycle information at lower levels of assembly. Additional useful information comes from the definition of interfaces. These interfaces are primarily hardware or software interfaces but include organizational interfaces and thermal analysis tool interfaces as well. Sometimes less tangible, but critically important input, is the risk and margin policy that is applicable to the spacecraft thermal design. Balancing design robustness with the consumption of resources is a challenging task in which the thermal design engineer needs to play an active role.

Once controls, resources, and inputs are in place for a particular phase of the thermal design, the activity can proceed to produce **Output**. This output is ultimately a thermal design that maintains temperatures inside of ranges that permit the spacecraft to perform its mission. Along the way analysis and test validate this design. These validations are part of the thermal design output, together with documentation of intermediate results that are needed as inputs to the design process of other spacecraft subsystems.

The thermal design process is highly interactive and as it unfolds, the thermal engineer will spend considerable time obtaining the information necessary to complete the design. Inevitably, design changes in many of the spacecraft subsystems will occur due to science, technical and/or cost considerations, and many of these changes will impact the thermal design. Understanding the process and its phasing is part of the thermal design task.

The need to balance, inherent in the thermal design activity, extends to the most important product resulting from this process – temperatures. The notion that the thermal engineer is designing to achieve a single temperature, preferably room temperature, is incorrect. The preceding paragraph on the thermal design activity lists numerous inputs and requirements. Much of the input information carries a degree of uncertainty that needs to be taken into account by the thermal design. The extent to which uncertainties are allowed to perturb the design is a function of the risk stance of the project and the amount of resources available to create design margin.

It is not uncommon for different equipment on a spacecraft to require different operating temperatures. Instruments, optics, and sensors may require cryogenic temperatures well below – 100 °C, while the structure and spacecraft housekeeping equipment may need to be at near room temperature. This equipment may turn on and off and needs to be at different temperatures at different times. The external thermal environment, such as the presence or lack of direct solar radiation, solar radiation reflected off a planet, and thermal radiation from a planet, also vary greatly depending on orbit. If one further considers, that even input as immutable as the solar constant varies in reality between 1318W/m<sup>2</sup> and 1418W/m<sup>2</sup> for a spacecraft near earth, and spacecraft

orbiting earth or another planet can go in and out of its shadow, it becomes soon apparent that there is no single answer to the frequently asked question "How hot does it get?" Instead, the engineer performing a spacecraft thermal design will attempt to design for reasonable combinations of inputs in such a way that credible worst case scenarios lead to temperatures always within allowable ranges.

## **B. Spacecraft Thermal Design Approach**

Assuming that all inputs needed to perform a spacecraft thermal design have been obtained, the initial task of a thermal design engineer appears simple enough. This task is to establish reasonable ranges for these input parameters and a rationale of how these parameters can stack up to provide extreme but possible scenarios for the thermal design. Two "worst-case scenarios", at a minimum, are usually constructed. Under one set of assumptions all inputs combine to cause extreme but possible hot conditions. These assumptions typically include external environmental conditions of high solar intensities and, if applicable, planetary albedo and IR radiation. These conditions are combined with operating modes and duty cycles that deliver the highest power dissipation. Another important aspect of this procedure is to include an assessment of the degradation of the radiative surface; absorptivity typically increases with time. The other case is the opposite or "cold" case. Minimum environmental inputs and power dissipations characterize this case.

The worst case scenarios are unique to different phases of a space mission but need to encompass all of them. Once this is done, worst case analysis is done for each phase of the mission. Mission phases can include pre-launch operations on the pad, launch, orbit insertion, and several different operating modes. Or, if the mission is to a different planet, the launch is followed by a cruise phase between planets, and possibly aerobraking, landing, planetary surface operations and several other phases unique to a mission. All of these phases impose different thermal environments on the spacecraft.

Once the thermal design has been analyzed under these worst case hot and cold conditions, the result is a range of temperatures. These temperature ranges are compared against the requirements applicable to the respective mission phase. Included in this comparison are gradients and transient temperature variations for which requirements might exist. These types of requirements are more prevalent for an orbiting spacecraft that is eclipsed by the planet.

### **1. Thermal Design Techniques**

The thermal balance of the spacecraft at any point during the mission is achieved when all the heat sources on the spacecraft are balanced by all the heat lost from the spacecraft to space. The heat sources include the external environment and the internal heat generation, while the heat losses from spacecraft are the controlled heat rejection

from radiators and the heat leaks from the MLI insulation. The heat balance for a typical spacecraft can be expressed in following equation.

$$Q_{Solar} + Q_{Albedo} + Q_{EarthIR} + Q_{int\,ernal} = Q_{Radiator} + Q_{Spacecraft} \quad (4)$$

where

$Q_{Solar}$	= heat absorbed by the spacecraft from incident solar
$Q_{EarthIR}$	= heat absorbed by the spacecraft from planetary IR
$Q_{Albedo}$	= heat absorbed by the spacecraft from albedo
$Q_{Radiator}$	= heat rejected from specified radiating surfaces
$Q_{spacecraft}$	= heat rejected from the entire spacecraft except from the radiators

Once launched, heat generated internal to the spacecraft can only be rejected to space. In the vacuum of this environment, the only heat transfer mechanism available is radiation. The basic equation governing radiation heat transfer is presented below

$$Q_{Radiator} = \epsilon_r * A_r * \sigma * (T_r^4 - T_s^4) \quad (5)$$

$$Q_{Spacecraft} = \epsilon_{sc} * A_{sc} * \sigma * (T_{sc}^4 - T_s^4) \quad (6)$$

where

- Q = heat radiated to space from the radiator or the rest of the spacecraft
- $\sigma$  = Stefan Boltzmann constant,  $5.67 \times 10^{-8} \text{ W/m}^2 \text{ K}$
- $\epsilon$  = Thermal emittance
- A = Area,  $\text{m}^2$
- T = Temperature, K

Subscript 'r' refers to radiator, "SC" refers to the spacecraft, and 'S' refers to deep space.

Spacecraft thermal design takes advantage of this situation by controlling the amount of heat that can be rejected in this manner. By far the most common technique is to cover the spacecraft as much as possible with MLI, which serves as an effective, lightweight radiation barrier. Then openings for radiators are cut out the MLI in strategic locations and a measured amount of heat is allowed to escape. The balance between the insulated area and the open area controls the overall heat balance of the spacecraft and thereby the overall spacecraft temperature.

The radiator opening in the insulation usually exposes an aluminum surface, or other material capable of conducting heat efficiently. These surfaces are treated on the external side with a coating that permits radiative heat rejection at high efficiencies. This

is typically achieved by applying very specialized white or black paints. The insulation wrapped around the spacecraft is Multi Layer Insulation (MLI), which consists of up to 30 highly reflective layers of Mylar or Kapton, separated by thin layers of netting made from low conductivity materials such as Dacron, to avoid contact between the radiation layers (i.e., a thermal short). The solar absorptance and thermal emittance of typical radiator coatings and MLI are given in Table 6.

A radiator has a fixed size. That translates into a nearly constant amount of heat being rejected to space for a reasonable range of temperatures. The size of the radiator has to be large enough to reject the maximum amount of heat encountered during the mission. However, there are many credible operating modes where the spacecraft does not dissipate its maximum amount of heat while the radiator continues to reject heat much as before. This leads to a reduction of overall spacecraft temperatures. If this reduction reaches a lower permissible limit, survival heaters to maintain acceptable temperatures augment the internal dissipation. On other occasions, it may be desirable that temperatures not change much when parts of the spacecraft are turned off. In these cases, the internal heat dissipation is augmented by make-up heaters. All these actions and responses are monitored by temperature sensors that provide a constant surveillance of the overall spacecraft health. Selection of suitable sensors and selection of strategic location of sensors and heaters is an important part of the thermal design activity. Many of the devices mentioned here are essential to thermal control. A separate section of this article is devoted specifically to thermal control hardware and will provide a more detailed description of these items.

It should be noted that the use of heaters requires electrical power from the spacecraft. This may be a significant design issue since spacecraft always have limited power available, and sometimes when power is needed the most it is the least available. An example of this would be an emergency safe-hold situation where the spacecraft has lost attitude control for some reason (and thus the solar arrays are not pointed at the sun and only battery power is available), and yet all equipment must be maintained within survival temperatures until control can be reestablished. If electrical power is not readily available, the thermal designers may choose to use other techniques, such as mechanical louvers or variable conductance heat pipes to modulate the effective radiative capacity of the radiator.

Most of the thermal design approach described so far is limited to the external interface of the spacecraft with its environment. The dominant activity here is heat rejection. In almost all cases the heat is not dissipated directly on the radiator. As desirable as this close proximity between heat source and sink may be, physical and functional constraints lead to internal heat dissipation remote from the radiators. This identifies another key element of the thermal design activity, heat distribution. Heat internal to the spacecraft is often distributed by conduction through the solid materials of the spacecraft structure. This mode of heat transfer is described by the following equation:

$$Q = \frac{A}{L} * k * (T_{hot} - T_{cold}) \quad (7)$$

where

Q = heat conducted, W

A = cross section of conduction path, m<sup>2</sup>

L = length of conduction path, m

k = conductivity of material, W/m K

T = temperature, K

Heat distribution serves two purposes. The more obvious one is the task of providing a path for the heat to flow from the source to the radiator. A second element is the task of lowering heat densities. As electronic packaging is miniaturized, volumetric power densities escalate and can reach the equivalent of multiple solar constant at mounting interfaces. The ability to reject heat at a certain temperature is directly related to the heat density (amount of heat per unit area). Therefore, the density of the internal heat has to be lowered to the values at which the radiator can reject it without exceeding specified temperatures.

The task of heat distribution is accomplished by providing heat conduction path to spread the internally dissipated heat and to let it flow to the radiators with the least amount of resistance. The temperature rise between the heat source and the heat sink is directly proportional to the thermal resistance of the conduction path. It is one of the more prominent goal of the thermal design to keep these temperature rises to a minimum. Most spacecraft structures are fabricated from Aluminum Alloys, which combine structural strength with low weight and high thermal conductivity. A spacecraft design is highly integrated. Most thermal conduction paths are also structural load bearing members. This symbiosis points immediately to the need for close cooperation between the configuration, structural, and thermal engineers. A lack of cooperation often becomes evident when problems manifest themselves in later phases of the lifecycle.

## 2. Margins and thermal design requirements

Design margin provides performance beyond that which is needed. Margin is a resource that is traded on a system level in the same way as weight or power. **Experience has shown, that margin is an essential part of the design process.** It is the buffer that compensates for uncertainties and unexpected events. This is of paramount importance, since a spacecraft cannot be serviced or repaired once it is launched, and there are numerous uncertainties in the design, testing, integration, and operational phases of a spacecraft.

Although there is consensus that margin is essential for a spacecraft thermal design, there is a wide variety of opinions on the right amount of margin to apply. Golden

rules don't exist. In their absence, the engineering team uses accumulated past experience. Frequently the team looks back to past successful missions of a similar nature to use as a reference point. This is prudent practice but if there is no forward looking element in the team soon the design turns stagnant and progress towards advanced designs for future missions is impeded. Thus a constructive debate about margin is healthy and should be a part of the design process.

### 3. Thermal Design Example

To illustrate what has been discussed, an example of a simplified spacecraft thermal design is described next. For this example we assume an earth orbiting spacecraft. The spacecraft flies over the poles and the equator is in the plane of the ecliptic. For simplicity, a cube represents the spacecraft. The spacecraft and its orbit are shown in Figure 10.

The energy balance on the spacecraft is given by

$$Q_{Solar} + Q_{Albedo} + Q_{EarthIR} + Q_{internal} = \epsilon_{radiator} * A_{radiator} * \sigma * (T_{radiator}^4 - T_{space}^4) \quad (8)$$

For the nadir facing surface of a 1 meter black cube, the results of a computer simulation for a typical low earth orbit are shown in Figure 11. In our example, in order to simplify the problem, heat loads averaged over the orbit are assumed. This permits steady state calculation using the above equation. This approach is often taken during early design phases when feasibility is more of a concern than exact results. Average incident heat fluxes ( $W/m^2$ ) for all surfaces are shown in Table 7.

The actual absorbed amount of heat depends on the thermo-optical properties of the actually selected surface coating and is calculated according to:

$$\begin{aligned} Q_{solar} &= \alpha * q_{Solar} * Area \\ Q_{Albedo} &= \alpha * q_{Albedo} * Area \\ Q_{PlanetIR} &= \epsilon * q_{PlanetIR} * Area \end{aligned}$$

Let us further assume that the internal power dissipation is 150 W and that the Space temperature is 0 Kelvin (note: 0 Kelvin is an ideal case; a typical spacecraft in LEO might see sinks on the order of 200 to 230 Kelvin on its Earth facing side). It is obvious that the east or west facing surfaces receive the least amount of environmental heat since they are parallel to the solar vector. If we also assume that all other surfaces are well enough isolated by MLI, so that their contribution to the overall heat exchange is negligible, then we obtain:

$$(\alpha * (0.0 + 41.3) + \epsilon * 60.6) * A + 150 = \epsilon * A * \sigma * T^4 \quad (9)$$

This equation shows that for a given environment and internal dissipation, the temperature is a function of the a/e ratio and the radiator area. Since in an “off” mode the internal dissipation needs to be made up by heaters consuming scarce power, the most typical design goal is to minimize survival heater power consumption while meeting temperature requirements. Frequently, this goal is synonymous with reducing the radiator size. This can be achieved by minimizing the a/e ratio. Materials that exhibit the desired properties include white paints and second surface mirrors like aluminized Kapton or silver backed Teflon. Their  $\alpha/\epsilon$  ratio is typically near 0.15/0.85. If this number is applied to the equation above we obtain:

$$T^4 = 1.22^9 + \frac{3.11^9}{A}$$

*or*

$$A = \frac{3.11^9}{T^4 - 1.22^9}$$

(10)

Similarly, for the nadir-facing surface, one would obtain:

$$T^4 = 4.45^9 + \frac{3.11^9}{A}$$

*or*

$$A = \frac{3.11^9}{T^4 - 4.45^9}$$

(11)

For a desired temperature of 27 °C (300 K), the required area in this example is 0.45 m<sup>2</sup>. That means that about half of the surface needs to be covered with MLI. If, on the other hand, the nadir-facing surface had been selected, the required area would be 0.85 m<sup>2</sup>.

A less intuitive answer develops, when the question is asked: What is the heater power requirement for the two design options if a minimum temperature of 0 °C is desired in the “off” mode? Using the equations above, it can be determined that the nadir-facing radiator, although larger, requires 45 W whereas the smaller radiator would require 95 W. The apparent paradox is explained by the fact that the nadir facing radiator is large because its environmental heat load is about 3.5 times higher and the internally generated heat is not dominating the overall heat rejection need. The situation for the smaller radiator is just the opposite. Here the internal load is almost 6 times higher than the external load. Consequently, a change in internal heat dissipation has a much larger effect on the smaller radiator than the larger radiator.

In the end, other considerations need to be factored in to come to a conclusion. And the outcome is not always the same. If mass or space constrain the design space, the



smaller radiator is likely to be selected. The same is true if temperature stability is of concern. If power is the overriding concern then the larger radiator is selected. Typically, power, mass and stability are of concern and the problem appears to be over constrained. This is where creativity and communication skills of the thermal control engineer will help solve the problem

### **C. Thermal Analysis**

Throughout the life cycle of a spacecraft, analysis is used as an important engineering tool. At first, effective analysis can consist of simple calculations amenable to a pocket calculator or spreadsheet program. But as the design progresses and becomes more detailed, the complexity of required calculations goes up and computer programs specifically developed for this purposes are employed.

These programs fall generally into two classes. One type performs calculations related to the radiative exchange of heat which is surface and geometry driven. The other type incorporates the results of the radiation calculations and adds linear conduction through solid material as well as heat source and sink terms and the effects of thermal mass. In addition, the user can program any logic into these solvers that maybe required to emulate unique spacecraft thermal behavior, including the time varying nature of the thermal sink and internal rate of heat generation.

Modern radiation analysis tools employ a Monte Carlo Ray Trace technique type of method to simulate the actual exchange of energy by the photons involved in the radiation heat transfer process. These computer tools require surface geometry and surface property information. This information is used to construct a computer model of all spacecraft surfaces participating in the radiation exchange. This part of the simulation model is combined with a simulation of the space environment to yield radiation “conductances” and heat fluxes. The space environment simulation includes planetary IR and albedo information for orbiting spacecraft, as well as trajectory information for interplanetary missions. Ray tracing is computationally very intensive and each model run produces a large amount of output. Therefore, thermal engineers control the level of detail that is being simulated judiciously, which results in idealized models that capture the essence of the heat transfer without including the level of detail needed for manufacturing. Knowing how to create small enough models which retain adequate fidelity is a matter of judgement and training.

Most thermal solvers use the finite differencing scheme to solve a set of coupled partial differential equations describing a system of lumped capacitance nodes and conductors between these nodes. Included in the conductors are any radiation conductors obtained from the radiation analysis described above. The network thus established is equivalent to an R-C network in the electrical domain. Solvers for the type of equations governing the numerical solution have been well established for many years and modern solvers direct their focus on additional functionality in the areas of design support through goal seeking algorithms, pre and post processing of data, integration with other tools and CAD and friendlier user interfaces. The thermal engineer uses these tools to

completely formulate an analytical simulation of the spacecraft thermal behavior including all transient events that may be a design driver. These analytical models are valuable tools for the engineer to study sensitivities and predict performance of a design and the fast turn-around facilitates more design iterations with the goal being to arrive at a system-optimized design (as opposed to a locally optimized design).

#### **D. Testing**

The thermal design is validated in a test of the flight spacecraft in a facility that simulates anticipated flight environments. This is accomplished by installing the spacecraft in a thermal vacuum chamber in such a way that non-flight thermal influences are minimized. A high vacuum is standard in these tests. In many facilities, specially designed solar simulators can produce high fidelity solar beams using powerful arc lamps and collimating optics. Liquid Nitrogen-filled shrouds installed along the perimeter of the thermal vacuum chamber form an enclosure that simulates the cold conditions of space. Liquid helium filled shrouds are sometimes employed if a colder thermal sink is needed. In recent years IR heaters are increasingly substituted for solar simulation because of the high facility cost associated with performing a high fidelity solar test. Due to the difference in spectrum, IR simulation can not verify the values of solar absorptivity for illuminated spacecraft surfaces. Another deficiency in IR simulation is the lack of collimation relative to that of the Sun. However, IR testing can introduce external heating equivalent to that of solar heating and the overall spacecraft heat balance can be simulated in the test. A representative 25-ft diameter thermal vacuum chamber used for spacecraft thermal tests is shown Figure 12. In Figure 13, the Cassini spacecraft in the JPL 25-foot thermal vacuum test chamber is shown. The spacecraft was tested in the flight configuration and simulated space environment for its worst hot and cold conditions. The simulation of the spacecraft heat balance is the primary goal in designing a thermal vacuum test for the purpose of verifying the thermal design and has led to the name for this type of test: *Thermal Balance Test*.

In the thermal balance test a known, flight like heat balance is established between the spacecraft and its external environment. Temperatures are allowed to equilibrate and are recorded for subsequent correlation with the computer models. It is important to understand the limitations of a given thermal vacuum test and account for these in the analytical model. Equilibrium conditions are typically established for worst case hot and cold conditions, as well as survival conditions. If critical gradient or temporal stability requirements need to be verified, special test sequences are incorporated to simulate such conditions. With the help of computer controlled simulated heat sources, often arrays of quartz lamps and reflectors, it is possible to simulate the transient behavior of an orbiting spacecraft going periodically in and out of eclipse. It is challenging to correlate this type of simulated environment to the spacecraft's thermal response. In this case, calorimeters are used as flux sensors. These calorimeters are constructed with the same surface coating as the spacecraft surfaces that are being illuminated by the quartz lamp. Because the calorimeter has the same radiative properties as the actual spacecraft surface, it will absorb heat just as the spacecraft will. These

calorimeters are then placed in strategic locations to measure the amount of heat absorbed by the spacecraft. These data are recorded and later correlated with the thermal model.

During the thermal test phase of a project's life cycle, other tests are performed while the opportunity exists. Some of these tests verify functional performance of the spacecraft. Other tests are designed to calibrate spacecraft performance over a range of temperatures. A routine test that is performed at this time is the margin test or "system level protoflight or qualification test". These tests are designed to demonstrate margin and design robustness. Cycling and/or dwell tests are performed at temperature levels beyond those expected in flight, but, limited by assembly level protoflight limits. The number of cycles performed, and the degree of excess above/below the design temperatures, is generally specified by the qualification procedures of the sponsoring organization. During these tests it is not necessary to simulate the anticipated flight environment. In fact, the objective of these tests is to force the Spacecraft temperatures beyond expected flight temperatures. Sometimes that means that part of the thermal control system have to be disabled.

An important aspect of thermal design is the correlation of test data with the thermal model. Since thermal tests typically occur late in the project life cycle and shortly before shipping to the launch site, they are usually performed under a tight schedule. Inevitably, the test uncovers discrepancies between expectations and actual performance. These discrepancies result from artifacts of the test configuration which is not present in the flight configuration of a spacecraft. Discrepancies can also result from the real behavior of the hardware that has not been adequately understood, or they may be caused by poorly understood test conditions. At this phase of the design, the thermal engineer will carefully review the credibility and quality of the data obtained in the thermal test. The processing of these data can be a daunting task since it is not uncommon for hundreds of telemetry channels to be recorded once per minute for a test lasting 2-3 weeks. Out of this data review emerges a picture of how the spacecraft behaved under test conditions. Predictions from an analytical model for the same test conditions are then compared to the test data. Differences exceeding a preset threshold are flagged and the likely causes for these differences are evaluated. Modifications are then made to the test model to reflect the newly determined established physical condition and a new set of predictions is made. It should be noted that the veracity of the test data and its interpretation must also be addressed. This process continues in an iterative fashion until satisfactory correlation is achieved. Depending on sensitivity, correlation within 1 °C to 5 °C are typically desired. The correlated test model of the spacecraft is then analytically returned to the flight environment and flight predictions are generated. If any of these predicts exceed allowable flight temperatures, the correlated model is used to evaluate design options. If the redesign is significant, a retest maybe required and the correlation process is repeated. At the end of this process, the correlated test model is then used to simulate the spacecraft performance in all of its various mission phases. It is not difficult to see that this is an intense period of time for the thermal engineer.

#### **IV. THERMAL CONTROL HARDWARE**

The actual implementation of the thermal design developed for a spacecraft is accomplished by using various pieces of thermal control hardware. The thermal control hardware used on spacecraft include a wide range of materials, coating, and equipment. The most common thermal hardware components used on any spacecraft are the MLI blankets, radiators with high emissive coatings, heaters, and temperature sensors. The TCS designs incorporating these pieces of equipment are generally simple passive designs. As the total thermal power to be managed on the spacecraft increases along with more stringent thermal requirements, the TCS requires more sophisticated thermal hardware to implement the design. The thermal hardware that fall into this category include mechanical louvers, heat pipes, capillary pumped loops and loop heat pipes, thermal straps, special thermal insulation needed for Martian surface environment, mechanical pumps circulating cooling liquids, and high thermal conductivity materials.

#### **A. Thermal insulation**

Thermal insulation is the single most important thermal hardware used in the spacecraft TCS. For all the earth orbiting and on most of the deep space spacecraft operating in vacuum, all the heat loss from the spacecraft by thermal radiation to the deep space. MLI blankets are used on the outer surfaces of all these spacecraft to minimize the heat loss. The MLI blankets are typically 10 to 30 layers of 0.25 mil thick metalized Mylar sheets separated by a mesh made of a low thermal conducting material such as Dacron, Nomex, silk, or other material. The MLI acts as radiation barrier for the heat radiated from the spacecraft surface to the cold space. The external layer of the MLI blanket are usually made out of 1 to 2-mil aluminized Kapton which is much more rugged than the Mylar and provides protection during installation and handling during tests. The many layers of an MLI blanket are held together by either by stitching around the edges or the use of tabs or buttons spaced at some regular interval. A detailed construction of the MLI is shown in Figure I14.

The mass of the MLI blanket vary depending on the number of layers of Mylar and also the thickness of the exterior Kapton layer. Most of the 15-layer MLI blanket fabricated at JPL and used on spacecraft have a mass of around 600 to 700 gms per square meter depending on the size of the blanket. The effective emittance provided by of these blankets varies from 0.01 to 0.05 depending on the area of the blanket. The larger (over a square meter) the size of the blanket the lower will be the effective emittance. Effective emittance value of 0.005 have been observed for blanket of 10 square meter size.

For spacecraft operating in an environment where gas is present, such as Martian surface where a 8 to 10 torr CO<sub>2</sub> is present, a different kind of thermal insulation is required. Typical thermal insulation materials used for these applications are foam and aerogel. On Mars Pathfinder lander, a foam insulation was used, whereas, for the microrover, a silica aerogel was used as the thermal insulation.

#### **B. Radiators and louvers**

Radiators are an important part of the spacecraft thermal control. Radiators are the only means by which the heat can be rejected from the spacecraft in a controlled way. They are sized so that they can reject the minimum amount of heat in order to keep the spacecraft from exceeding its maximum temperature during the hottest conditions during the mission. Radiators are typically made of aluminum plates that are either an integral part of the spacecraft structure or separately mounted units. The radiator surfaces have high emissivity coating in order to reject the maximum amount of heat at a given temperature. The heat generated in the electronics equipment inside the spacecraft is transferred to the radiator generally by direct conduction when the equipment is mounted directly to the radiator. In some cases two-phase devices such as heat pipes, capillary pumped loops, or loop heat pipes are used to transfer the heat from the heat generating equipment to the radiator. In these cases, the two-phase devices are attached to the backside of the radiator over the entire length. In many cases, when the area is large, the radiators are made of thin aluminum face sheets sandwiching a honeycomb core to reduce the mass of the radiator. In these cases, the heat pipes are embedded inside the honeycomb core.

The radiators are sometime controlled by mechanical louvers. These devices look and function much like Venetian blinds in front of a window. Radiators and louvers on an earth orbiting spacecraft instrument (EOS-MLS) are shown in Figure 15. Louvers compensate for heat balances that vary over large ranges, for example when the spacecraft is partially shut down or when the spacecraft distance to the sun becomes large enough to have a noticeable effect on the external heating of the spacecraft. Since a bi-metallic actuator sensing the radiator temperature passively controls louvers, these devices have the additional advantage to compensate to some degree for uncertainties inherent in any thermal design. The standard louvers used on the spacecraft have a fixed number of blades (16-blades or 8 blades on JPL spacecraft) and have eight bimetallic spring actuators with each one controlling one or two blades. The actuators can be set to open the blades and expose the radiator over small temperature range, typically about 10 C. The blades which are made of thin aluminum sheet have a very low surface emissivity, thus when they are in a closed position, the covered surface of the radiator would have low emissivity resulting in a low heat rejection from the radiator. The details of the construction of the JPL louver is shown in Figure 16.

Radiator heat rejection rate can also be modulated by variable conductance heat pipes, capillary pumped loops, or loop heat pipes. In response to a signal (generated either passively or actively), these devices can vary their effective thermal conductance from the equipment to the radiator surface, thus modulating the ability of the radiator to reject heat.

### **C. Heaters and thermostats**

Electric heaters are used on the spacecraft to keep the equipment temperatures from going below their allowable limits. Two types of heaters typically used on spacecraft are film heaters and cartridge heaters. By far the most commonly used type is the film heater

due to its flexibility to be installed on both flat and curved surfaces. These are made of electrical resistance filaments sandwiched between two layers of Kapton attached to the leads. The heaters come in various sizes to fit any applications on the spacecraft. Typically the heater power densities on the film heaters is limited to less than five Watts per square inch. These are installed on the surface of the particular equipment that needs to be heated using a pressure sensitive adhesive.

The heaters used on the spacecraft will always have some sort of control over their operation. Depending on the purpose of the heater, different types of control are used. The most common type is the thermostatic control using bimetallic mechanical thermostat which opens or closes the heater circuit at a pre set temperature. The standard thermostat is a hermetically sealed can containing a switch driven by a snap action bimetallic actuator. The set point at which the thermostat opens can be selected to suit ones application, however, there is a dead band over which the thermostats will close. The dead band chosen for thermostats typically range from 5 to 10 C. Typical thermostats used on spacecraft are shown in Figure 17.

#### **D. Heat pipes, capillary pumped loops, and loop heat pipes**

These are heat transfer devices based on two phase working fluids. Heat pipes are enclosed self-contained tubes containing a working fluid and have grooves or wicks along the inside walls of the tube. They operate on the principle of capillary pressure that is developed in the grooves or wicks when the liquid is in contact. The heat pipes remove heat from a hot source such as electronics box to a cold heat sink such as a radiator. The working fluid in the pipe at the hot location evaporates and the vapor flows along the tube to the cooler end due to the induced pressure gradient between the hot and cold ends of the pipe. The vapor carries with it the latent heat of vaporization which is released at the cold end. The heat is conducted along the wall to the cold sink such as the radiator. The condensed liquid in the pipe returns to the hot end by the capillary forces generated in the wick. This completes the cycle of heat transfer operation inside the heat pipe. A schematic of the heat pipe concept is shown in Figure 18. The effective thermal conductivity of the heat pipes greatly exceed that of material such as copper and at the same time are much lighter than the solid conducting devices. The longer the distance needed to transfer the heat more efficient is the heat pipe compared to the solid conductor.

Heat pipes are being increasingly used on spacecraft since the eighties. The most common type used is the aluminum heat pipe containing ammonia as working fluid. There are several other two-phase technologies such variable conductance heat pipes, capillary pumped loops and loop heat pipes which are being used on spacecraft now. In the case of capillary pumped loops and loop heat pipes, all the wicking action is provided by a wick located in the evaporator which is the hot side of the pipe. Liquid is supplied to this wick by a dedicated liquid line fed from the radiator. The vapor generated by the absorption of heat at the evaporator is conducted back to the radiator where it is condensed back to a liquid, thus releasing heat. The advantage of these heat pipes is that they have thin flexible lines to transport the vapor and liquid and are lighter than regular

heat pipes for transporting heat over long distances. They can also maintain tight temperature control and, if necessary, conduct very large amounts of heat. Three capillary pumped loops are used on recently launched the spacecraft (EOS-TERRA in 2000) and loop heat pipes have been used on several operational communication satellites.

#### **E. Miscellaneous thermal hardware**

Some of the other thermal hardware used on spacecraft for thermal control purposes include thermal straps, heat switches, sun shades, and mechanical pumps. Thermal straps are used when heat need to be transferred from heat generating device but need to be structurally isolated from the vibrations of the heat sink. A typical thermal strap has a flexible strap with metal brackets at each end to attach the strap to the heat source and sinks. Heat switches are used to control the heat flow depending on the temperature of the heat source. There are mechanical heat switches where an actuator either makes or breaks the thermal contact to achieve the switching action. The bimetallic springs and wax actuators are used provide the mechanical action.

Mechanical pumps are used to circulate a single phase liquid to remove heat from the hot equipment and transfer it to a cold sink. These pumps are used on short space missions such as Space Shuttle and International Space Station. Recently, they have been used on the Mars Pathfinder mission where these pumps operated continuously for seven months circulating Refrigerant 11 liquid to remove heat from the electronics to an external radiator. Mechanical pumped cooling systems provide enormous flexibility in removing heat from the heat generating equipment and rejecting it at the radiator are being increasingly considered for thermal control of future spacecraft.

### **V. LAUNCH AND FLIGHT OPERATIONS**

The function of the spacecraft thermal control is not only to provide temperature control during flight of the spacecraft but also during the ground testing and launch phase of the mission. Another key function of the thermal control engineer is to monitor the thermal health of the spacecraft during the entire period of the spacecraft life. This is called the flight operations and primarily involves monitoring the temperatures of the various spacecraft components to ensure they are in compliance with the thermal requirements.

A properly designed thermal control system should operate more or less autonomously during flight operations. However, if it is necessary to make changes (due to equipment failure, unexpected conditions, etc.) it may be possible to modify the operation of the thermal control system if the spacecraft is provided with the requisite telemetry and on-board control reprogrammability.

Despite the best attempts during I&T to exactly simulate flight conditions, the thermal environment during the ground testing and launch period is, inevitably, very different from that during the flight. The key difference in ground testing is the absence of the cold deep space and also the other solar and planetary related fluxes. Also, due to

limitations in the size of available thermal vacuum chambers many spacecraft are tested without their deployed solar array. These differences must be accounted for analytically. The purpose of ground testing is to check that various equipment on the assembled spacecraft are functioning accurately and reliably. These tests involve several hours of operation of the equipment causing the equipment to which may overheat if the heat is not removed

The pad environment is also very different from in-flight operations. Often the spacecraft must be protected from the ambient environment by a temperature and contamination controlled tent. Filtered, temperature controlled air is often blown into the spacecraft for this purpose. The early launch phase is usually not a problem thermally as it is very short and the spacecraft's thermal capacitance is generally enough to prevent unacceptable temperature swings. However, transition to the final orbit or escape trajectory can be challenging as the spacecraft might not have its flight configuration or solar orientation.

In addition to verifying that heaters and other thermal components operate correctly during ground testing, it is important to correlate the ground test data to the analytical thermal model. Good correlation between analytical predictions and test data is an indicator that the spacecraft thermal control system is well designed. Once launched the flight data is then compared to analytical predictions to verify the design and help diagnose and correct any discrepancies. Corrective measures may include modifications to operational procedures, changes in thermostat set points, use of redundant thermal control devices, and other measures. In addition, information gleaned from evaluation of the flight data can constitute valuable "lessons learned" for future missions.

## **VI. ADVANCED TECHNOLOGIES FOR FUTURE SPACECRAFT**

Like other spacecraft subsystems, thermal control technologies must evolve over time to meet ever more demanding spacecraft and instrument thermal control requirements. Clearly, the purpose of new NASA missions is to achieve new science which inevitably requires more sensitive measurements, greater pointing accuracy, operation in more challenging environments, and other such issues. In order to achieve this new science the demands on the engineering subsystems will naturally increase. Conventional thermal control technology, such as heaters, MLI, heat pipes, louvers, specialized radiator coatings, etc., are even often now inadequate. For example, numerous recently launched spacecraft (e.g. TERRA, Mars pathfinder, etc.) and others in the development stage (ICESAT, Swift, Mars Exploration Rover, etc.) utilize "new" technology, such as two-phase heat transport devices and long life mechanical pumps, simply to meet mission requirements. However, even these recent technology innovations will clearly be inadequate for planned future missions.

As spacecraft and instruments become more sophisticated, the thermal control subsystem must also improve. Increasingly, thermal design is more and more intimately tied to other parts of the spacecraft and affects, and is affected by, other subsystems.



These interrelationships greatly complicate the thermal design effort. Some of the current drivers necessitating advanced thermal control include:

- tighter temperature control requirements (  $\pm 1$  °C vs. the  $\pm$  perhaps 20 °C of earlier equipment
- tight temperature control over very large areas in order to maintain dimensional stability for large mirrors, optical benches, antennas, or similar devices
- temperature control at deep cryogenic temperatures ( $< 4$  K) for optics and instruments
- extremely challenging thermal environments (near the sun or very deep space)
- advanced thermal control with minimal resources (i.e., heater power, control circuitry, mass and volume allowances, etc.) from the spacecraft
- highly integrated spacecraft and instrument designs which restrict use of conventional approaches to thermal design
- minimal ground testing and qualification efforts (due to schedule, cost, or other constraints)
- miniaturization of spacecraft resulting in high power density components inside needing efficient heat removal devices

Accordingly, in order to meet these new challenges it is important to develop advanced thermal control technology. A variety of efforts are underway. These include:

- specialized thermal control coatings which can change their effective emissivity in response to a control signal. Current concepts involve the use of MEMS scale thermal louvers, polymer devices utilizing the electrochromic effect, and thin flaps of insulation that can be held close to, or off of, a surface by utilizing an electrostatic effect
- two-phase heat transport devices capable of operating at deep cryogenic temperatures for sensors, optics, and instruments
- devices utilizing phase change materials to greatly increase the effective "thermal capacitance" of a device, which will improve thermal stability under changing thermal loads/environments. Phase change materials absorb or discharge a great amount of energy when melting or solidifying
- heat pumps to allow radiative heat rejection when the temperature of the thermal sink is near or above the desired control temperature
- advanced cryocoolers (based on the Stirling cycle, reverse Brayton cycle, adiabatic demagnetization, pulse tube effect, or other thermal cycle) for cooling sensors
- advanced thermal insulation material for environments with a low, but non-negligible atmosphere (e.g., Mars and planetary environments, **high altitude balloons, etc.**)
- improved analytical models for simulating the performance of thermal control designs under ground test, launch, and flight conditions
- long life pumps (mechanical, EHD, etc.) for circulating a coolant

- miniaturized thermal control devices suitable for microsats and nanosats
- materials with very high thermal conductivity (e.g., various forms of carbon and artificial diamond)
- two-phase heat transport devices capable of isothermalizing very large structures
- devices capable of absorbing very high heat fluxes (hundreds of  $W/cm^2$ ) from lasers, electronic chips, power converters, and similar high energy devices
- cooling technologies embedded with sensors, electronic chips, or other devices
- improved temperature measurement devices integrated with on-board controllers and software

Improved thermal control technology is ultimately driven by the need for such capability, and created by the imaginations of thermal engineers. In addition to improved performance, many of the new technologies identified above are robust and flexible in their applicability. This can significantly enhance a designer's options when developing a thermal control concept for a given spacecraft.

## ACKNOWLEDGMENTS

The work described in this paper was partially carried out at the Jet Propulsion Laboratory, California Institute of Technology, under a contract with the National Aeronautics and Space Administration. The authors like to thank several people who provided help during the preparation of this article. At the Jet Propulsion Laboratory: Ray Becker who reviewed the article; Siina Haarpanen who put together several of the tables and pictures; and Glenn Tsuyuki, Art Avila, Gary Kinsella, and Gary Mulhern who provided some of the pictures used in this article.

## REFERENCES:

1. Agrawal, B., (1986), Design of Geosynchronous Spacecraft, Prentice-Hall Inc., Englewood, New Jersey.
2. Clawson, J.F, "Thermal Environments" Jet Propulsion Laboratory, JPL Internal Document D-8160, January 1991
3. Fleeter, R., (1995), MicroSpaceCraft, The Edge City Press, Reston, VA.
4. Gilmore, D., (editor), (1994) Spacecraft Thermal Control Handbook, Aerospace Corporation, Los Angeles.
5. Griffin, M. D. and French, J. R., (1991), Space Vehicle Design, AIAA Education Series, American Institute of Aeronautics and Astronautics, Washington D.C., 1991
6. Krotiuk, W. J., editor, (1990), Thermal-Hydraulics for Space Power, Propulsion, and Thermal Management System Design, Volume 122 Progress in Astronautics and Aeronautics, American Institute of Aeronautics and Astronautics, Washington D.C.
7. Larson, W. and Wertz, J., editors, (1992), Space Mission Analysis and Design, Space Technology series, Microcosm, Inc., Torrance, California, 1992.

8. Spacecraft Thermal Control, NASA SP-8105, May 1973.
9. Thermal Radiation Heat Transfer, NASA SP-164, 1968

## Tables and Figures

Table 1. Temperature Requirements of Spacecraft Equipment (Mars Pathfinder)

Spacecraft Equipment Component	Flight Allowable, Operating, °C		Flight Allowable, Non Operating, °C	
	Low	High	Low	High
<b>CRUISE STAGE</b>				
Cruise Solar Array	-50	77	-70	77
Parachute Canister & Motor	-45	40	-45	40
Propellant Tank	10	45	10	45
Thruster Valve	20	110	20	50
Propellant Lines	10	45	10	45
Integrated Pump Assembly	-30	40	-30	40
Sun Sensor Head	-40	65	NA	NA
Heatshield – Outer Surface	-150	NA	-150	NA
RAD Motor	-40	55	-55	70
<b>LANDER</b>				
Equipment Shelf	-55	55	-55	55
Petal Solar Arrays	-90	25	-120	50
Gas Generator	-40	0	-50	50
Petal Actuators	-40	20	-60	40
Lander Th. Batteries	-55	35	-75	35
Radar Altimeter Antennas	-100	60	-100	60
Solid State Power Amplifier	-20	50	-50	55
Deep Space Transponder	-30	50	-30	50
Electronic Module	-35	50	-50	50
<b>ROVER</b>				
Mobility/Structure	-80	40	-100	50
Battery	-40	45	-55	60
Cameras	-85	25	-85	25

Table 2 Component Temperature Requirements for Earth Orbiting Spacecraft

<b>Spacecraft subsystem</b>	<b>Operating (°C)</b>	<b>Non-Operating (Survival) (°C)</b>
ACS	-20 to 50	-40 to 60
C&DH Electronics	-20 to 50	-40 to 60
Communication Units	-20 to 50	-40 to 60
Antennas	-100 to 40	-130 to 50
Battery (lithium ion)	-10 to 40	-10 to 40
Electronics	-10 to 40	-20 to 50
Solar Array Panels	-50 to 55	-75 to 70
Flexible Harness	-50 to 55	-75 to 70
Propulsion System	-20 to 40	-40 to 50
VEC Radiators	-40 to 40	-60 to 60
VEC Electronics	-20 to 50	-40 to 60
Actuators	-55 to 50	-80 to 70
Spacecraft Bus	-50 to 40	-70 to 60
Instruments	-20 to 40	-30 to 50

*del. t.*

Table 3 Low and Geosynchronous Earth Orbit Thermal Environment

<b>Thermal Radiation</b>	<b>Perihelion W/m<sup>2</sup></b>	<b>Aphelion W/m<sup>2</sup></b>	<b>Mean W/m<sup>2</sup></b>
<b><u>Low Earth Orbit (LEO)</u></b>			
Direct Solar	1414	1323	1367.5
Albedo (global annual average)	<del>varies 0.30</del> <del>± 0.01</del>	<del>varies 0.30</del> <del>± 0.01</del>	<del>varies 0.30</del> <del>± 0.01</del>
Planetary Infrared (global annual average)	234 ± 7	234 ± 7	234 ± 7
<b><u>Geosynchronous Earth Orbit (GEO)</u></b>			
Direct Solar	1414	1323	1367
Albedo			
Subsolar Peak	7.19	6.72	6.95
Orbit Average	2.72	2.54	2.63
Planetary Infrared	5.52	5.52	5.52

Table 4. Thermal Environment for Various Inner planets of solar system

<b>Thermal Radiation</b>	<b>Perihelion W/m<sup>2</sup></b>	<b>Aphelion W/m<sup>2</sup></b>	<b>Mean W/m<sup>2</sup></b>
<b>Mercury</b>			
Direct Solar	14462	6278	9126
Albedo (subsolar peak)	0.12	0.12	0.12
Planetary Infrared (subsolar peak)	12700	5500	8000
(darkside minimum)	6	6	6
<b>Venus</b>			
Direct Solar	2650	2759	2614
Albedo	0.8	0.8	0.8
Planetary Infrared	153	153	153
<b>Earth's Moon</b>			
Direct Solar	1414	1323	1367
Albedo	0.073	0.073	0.073
Planetary Infrared			
Subsolar peak	1314	1226	1268
Minimum	5.2	5.2	5.2
<b>Mars</b>			
Direct Solar	717	493	589
Albedo (subsolar peak)	0.29	0.29	0.29
Planetary Infrared			
Maximum: near subsolar	470	315	390
Minimum: near polar caps	30	30	30

Table 5

## Thermal Environment for the Outer Planets of the Solar System

<b>Thermal Radiation</b>	<b>Perihelion W/m<sup>2</sup></b>	<b>Aphelion W/m<sup>2</sup></b>	<b>Mean W/m<sup>2</sup></b>
<u>Jupiter</u>			
Direct Solar	56	46	51
Albedo	0.343	0.343	0.343
Planetary Infrared	13.712700	13.4	13.6
<u>Saturn</u>			
Direct Solar	16.8	13.6	15.1
Albedo	0.3420.8	0.342	0.342
Planetary Infrared	4.7	4.5	4.6
<u>Uranus</u>			
Direct Solar	4.1	3.4	3.7
Albedo	0.343	0.343	0.343
Planetary Infrared	0.72	0.55	0.63
<u>Neptune</u>			
Direct Solar	1.54	1.49	1.51
Albedo	0.282	0.282	0.282
Planetary Infrared	0.52	0.52	0.52
<u>Pluto/Charon</u>			
Direct Solar	1.56	0.56	0.88
Albedo	0.47	0.47	0.47
Planetary Infrared	0.8	0.3	0.5



Table 6 Thermal properties of spacecraft surfaces

Spacecraft surface	Typical application	Solar absorptance	Thermal emittance
White paint	Radiator, antenna reflector	0.2 to 0.3	0.8 to 0.9
Black paint	Interior structure, solar array	0.9	0.9
Optical solar reflector	Radiator	0.1 to 0.2	0.8 to 0.9
Teflon with silver backing	Radiators, thermal insulation	0.1 to 0.15	0.7 to 0.9
Kapton film (aluminum backing)	Thermal insulation	0.3 to 0.5	0.5 to 0.7
Aluminum tape, deposited aluminum	Propellant tanks	0.15	0.05
Anodized aluminum	Interior structure	0.2 to 0.6	0.6 to 0.9
Gold	Interior structure	0.2 to 0.3	0.02
Solar cells	Solar panels	0.65 to 0.75	0.8
MLI*	Exterior surface thermal insulation		0.01 to 0.05

\* Effective values; dependant on number of internal layers, external surface, and area of the blanket

Table 7 Average incident heat fluxes ( $W/m^2$ ) for all surfaces of the design example

	Zenith	Nadir	East	West	Flight	Trailing
Solar	452.4	48.7	0	0	331.9	331.9
Albedo	0	148.1	41.3	41.3	41.3	41.3
Planet IR	0	211.7	60.6	60.6	60.6	60.6
Total	452.4	408.5	101.9	101.9	433.8	433.8

Figure 1. Thermal Control System of Landsat-7, an Earth Orbiting Spacecraft launched April 15, 1999

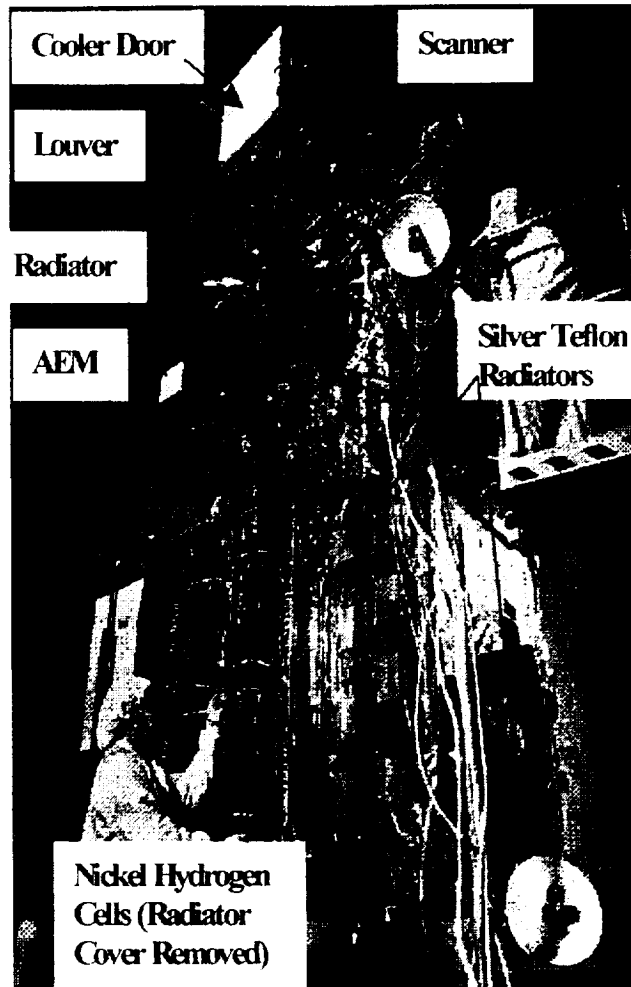

Figure 2. Mars Pathfinder spacecraft and its thermal control system

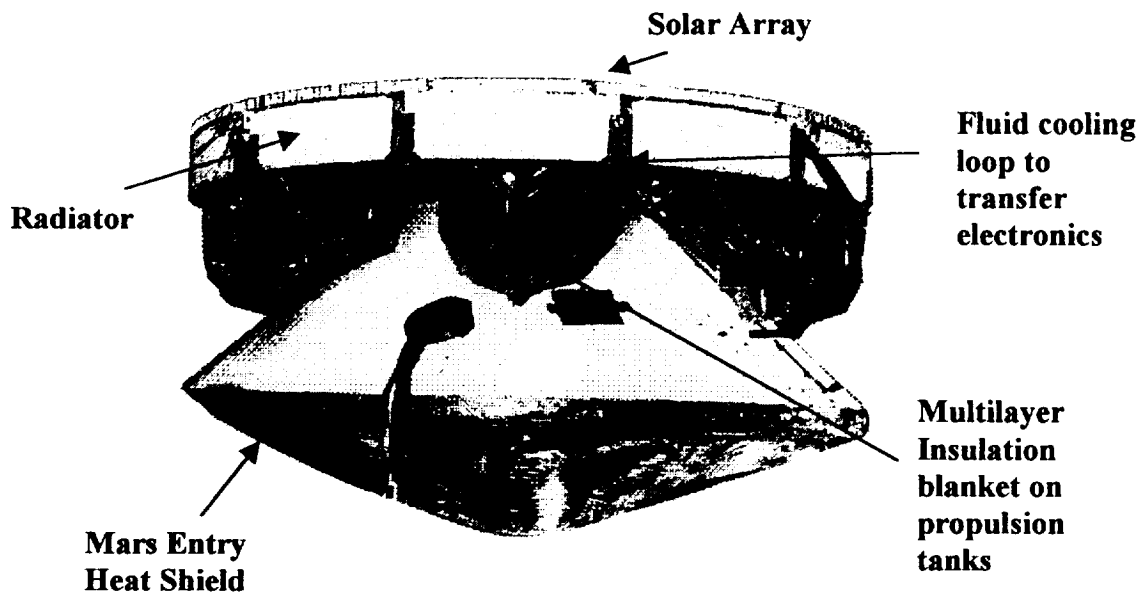

Figure 3. Thermal Control System of an Interplanetary System (Cassini spacecraft)

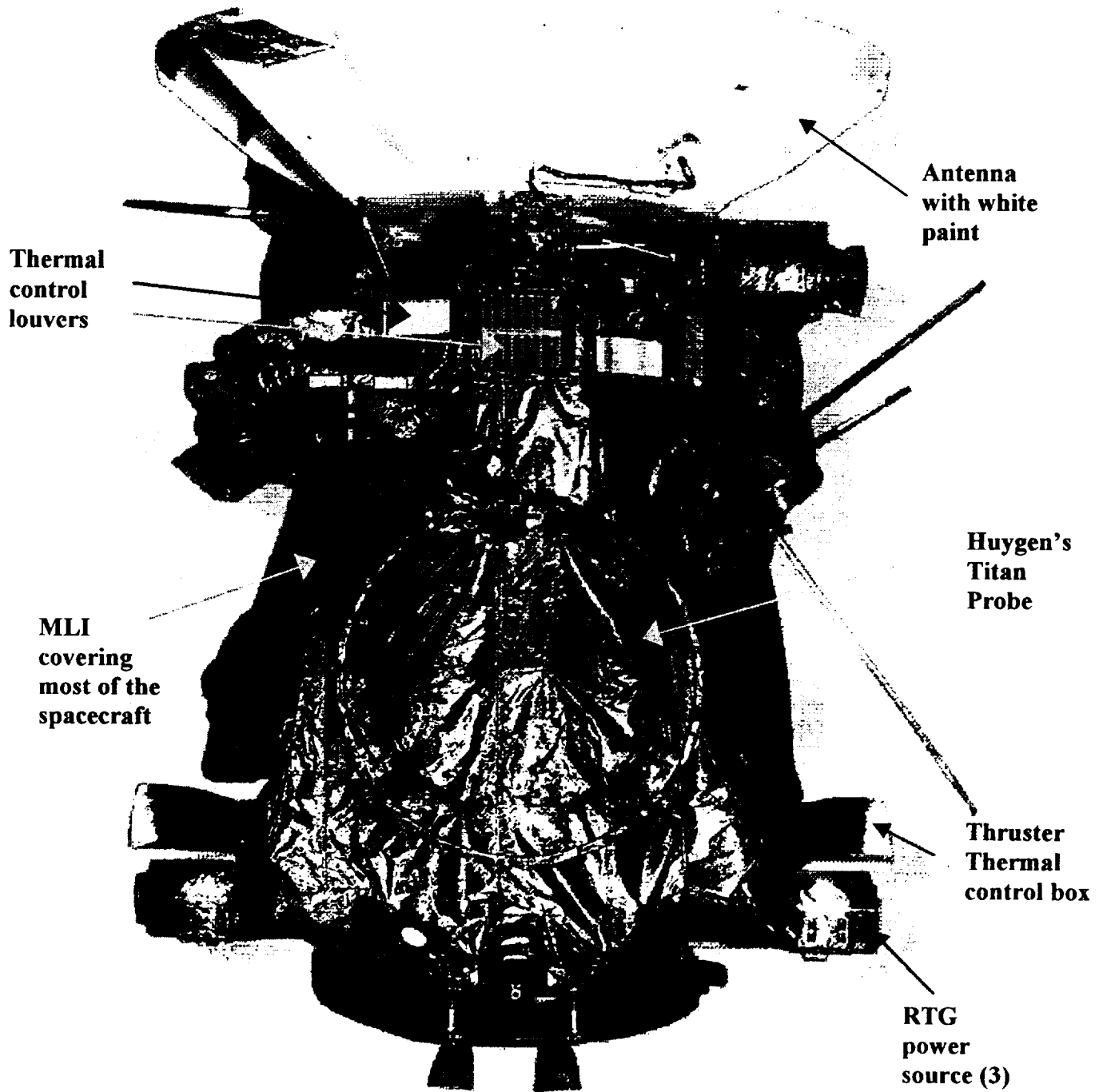

Figure 4. Thermal requirements and margins for tests and design

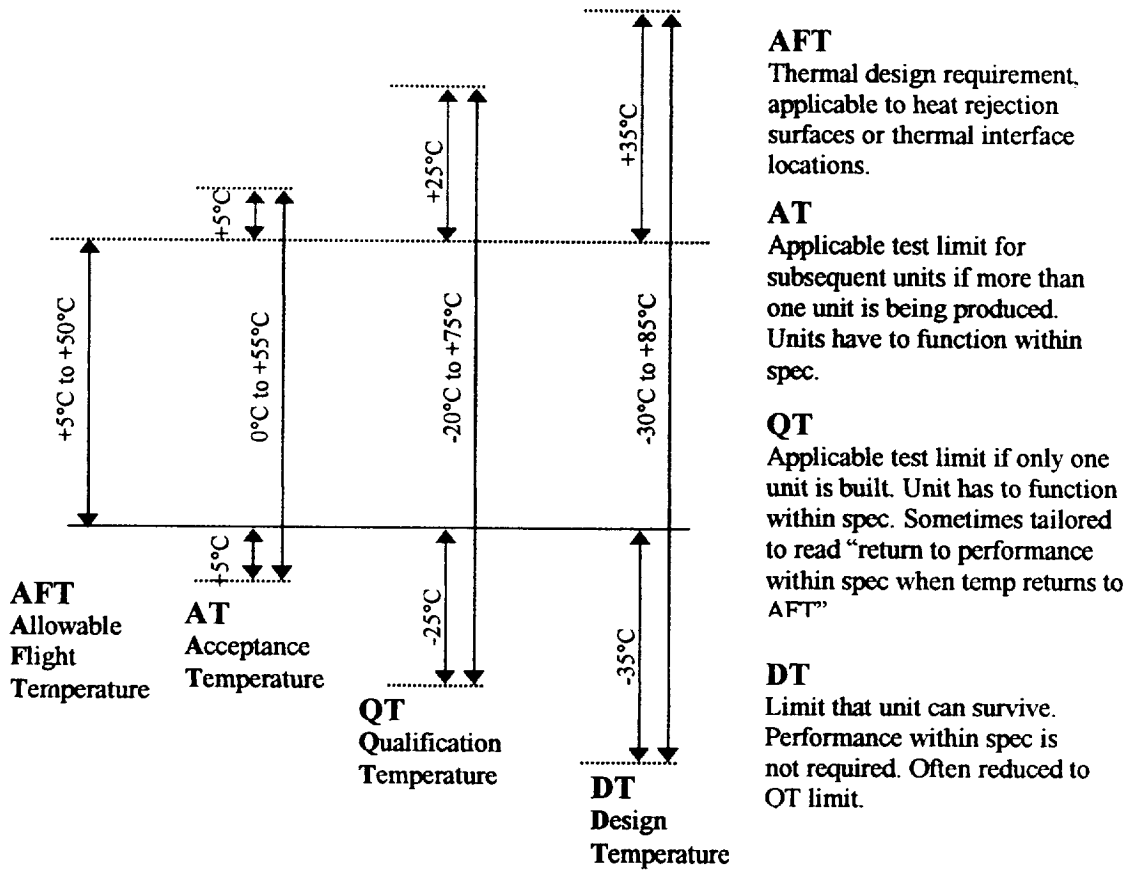

Figure 5 Spacecraft temperature as a function of  $\alpha/\epsilon$  and projected area to total area ratio

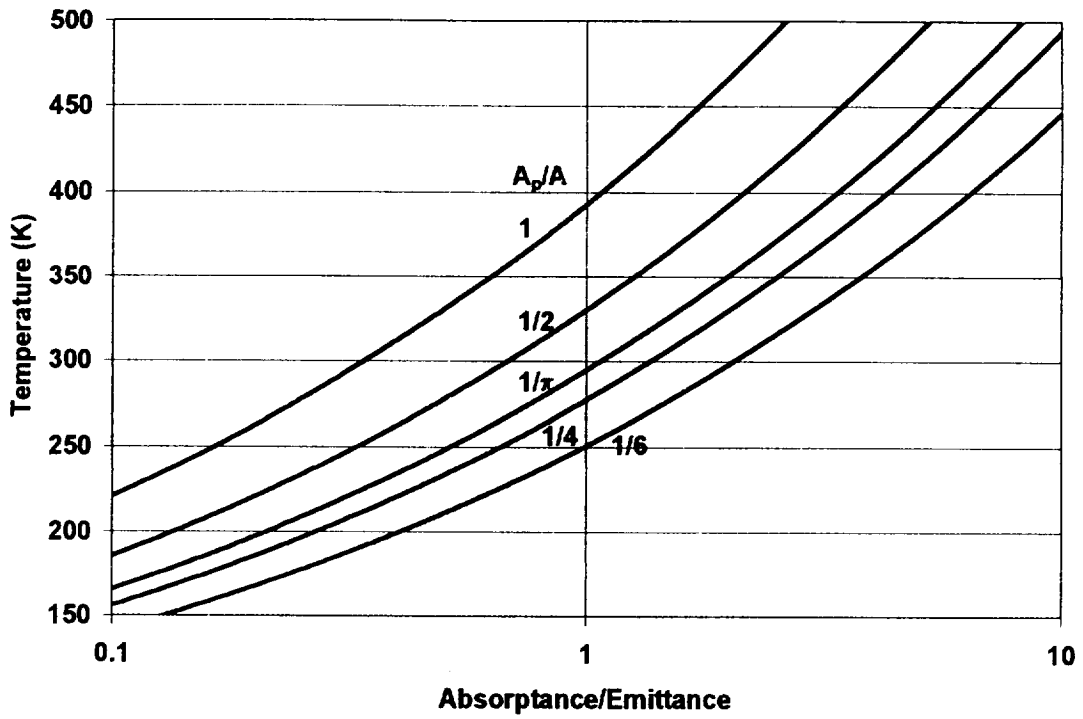

Figure 6. Temperature of a black sphere exposed to sunlight at different planets

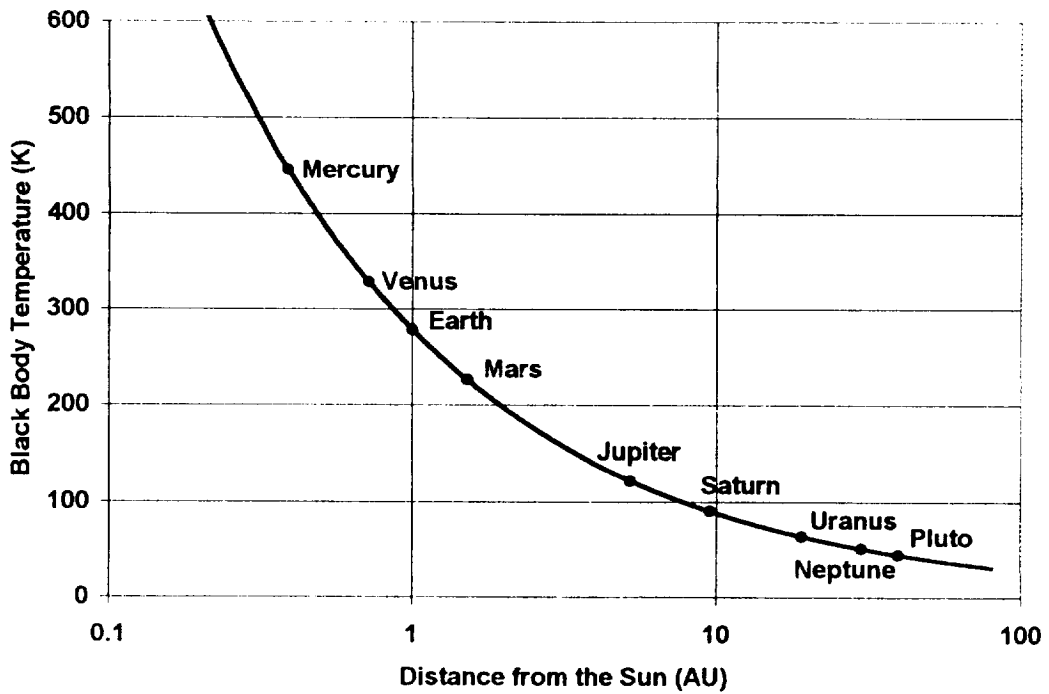

Figure 7. Environmental heat flux for an orbiting spacecraft

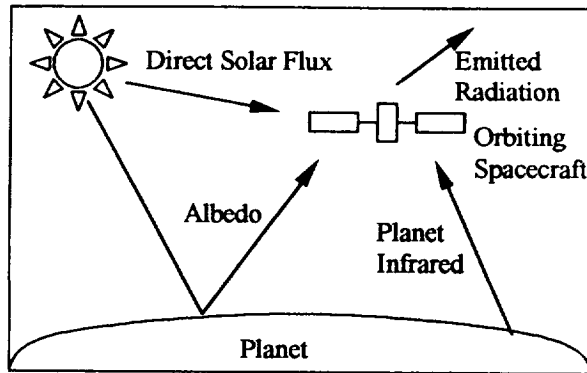

Figure 8. Thermal design process

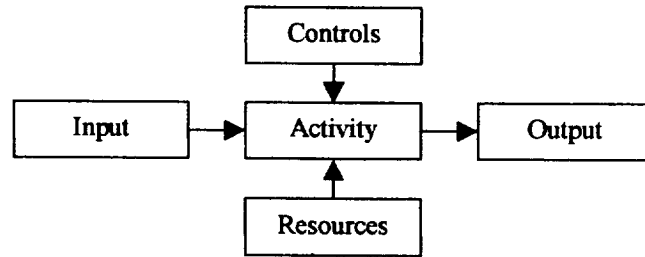

Figure 9. Details of the spacecraft thermal design activities

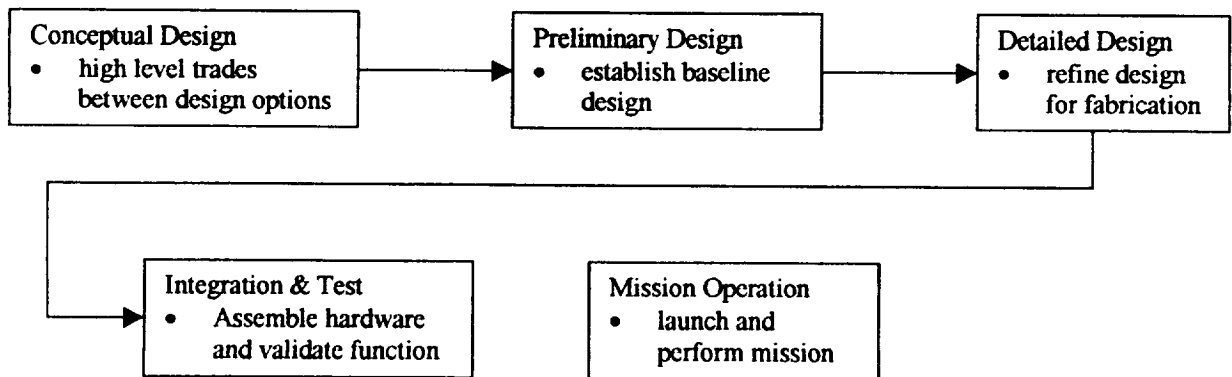

Figure 10. Thermal design example of simple earth orbiting spacecraft

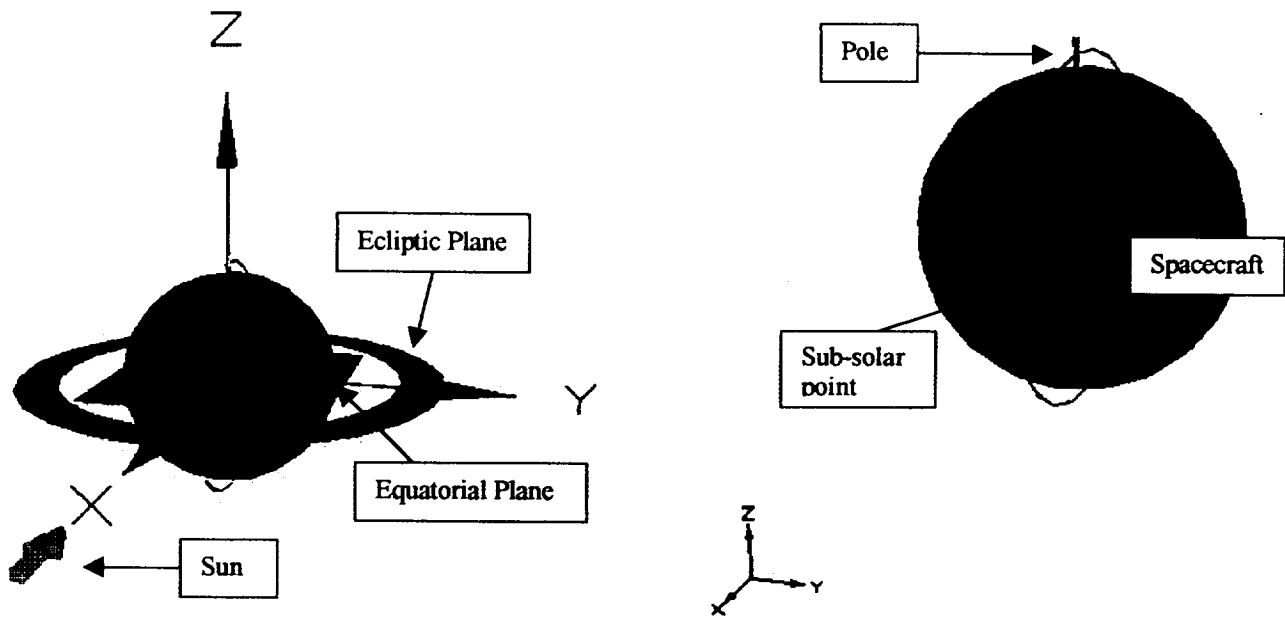

Figure 11. External heat flux on the nadir facing panel of the spacecraft

### Typical Environment for a Low Earth Orbit Radiator Facing Nadir

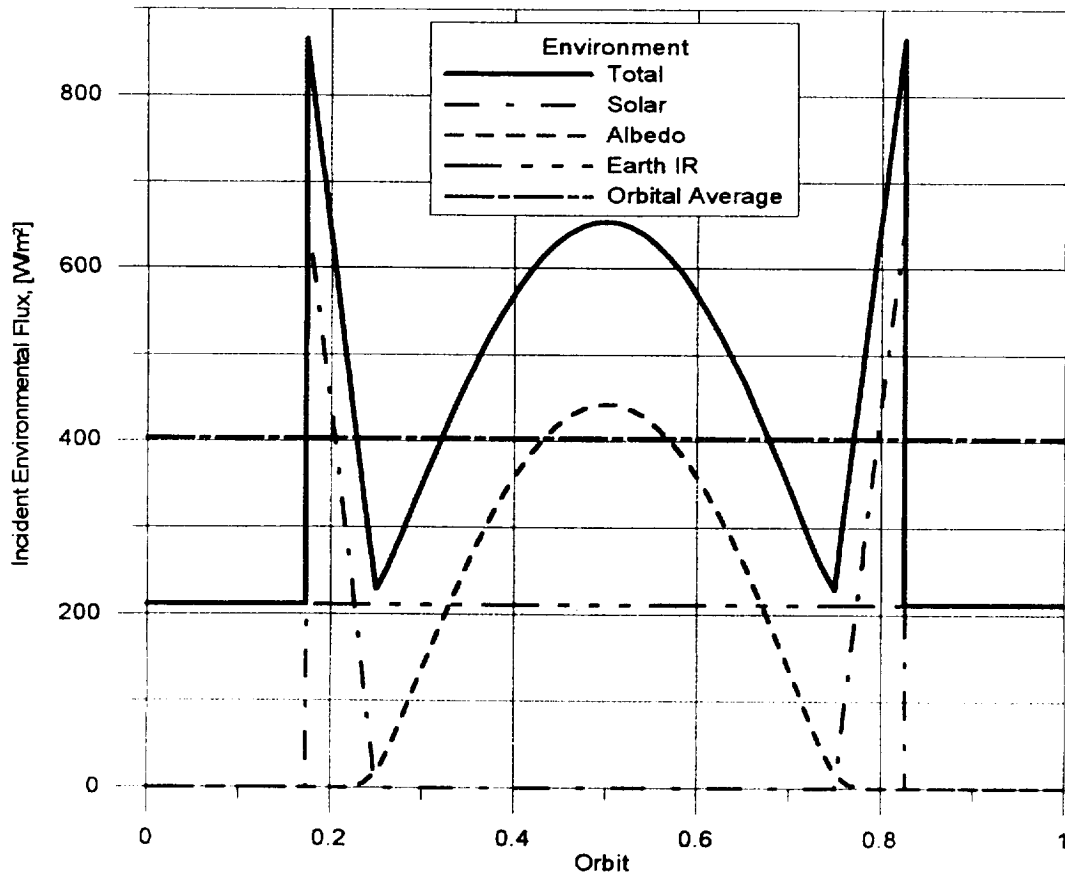
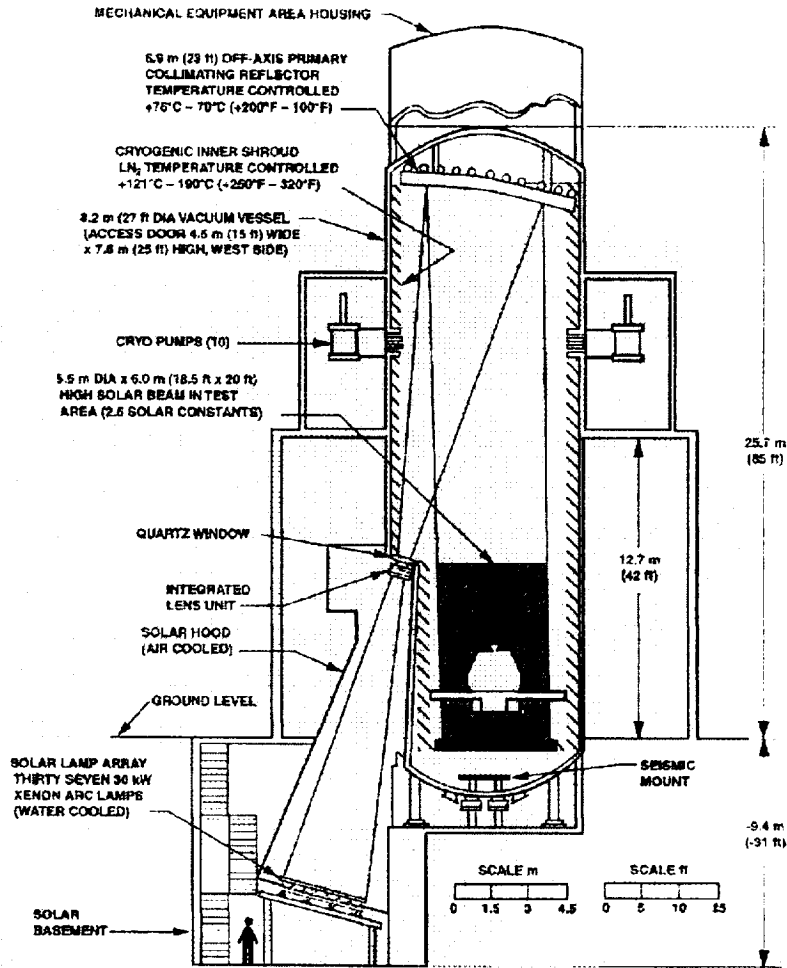



Figure 12. JPL 25-ft thermal vacuum chamber



JPL 7.6 m (25 ft) SPACE SIMULATOR CROSS SECTION (LOOKING EAST) BUILDING 160

Figure 13. Cassini spacecraft in the JPL 25-ft thermal vacuum test chamber

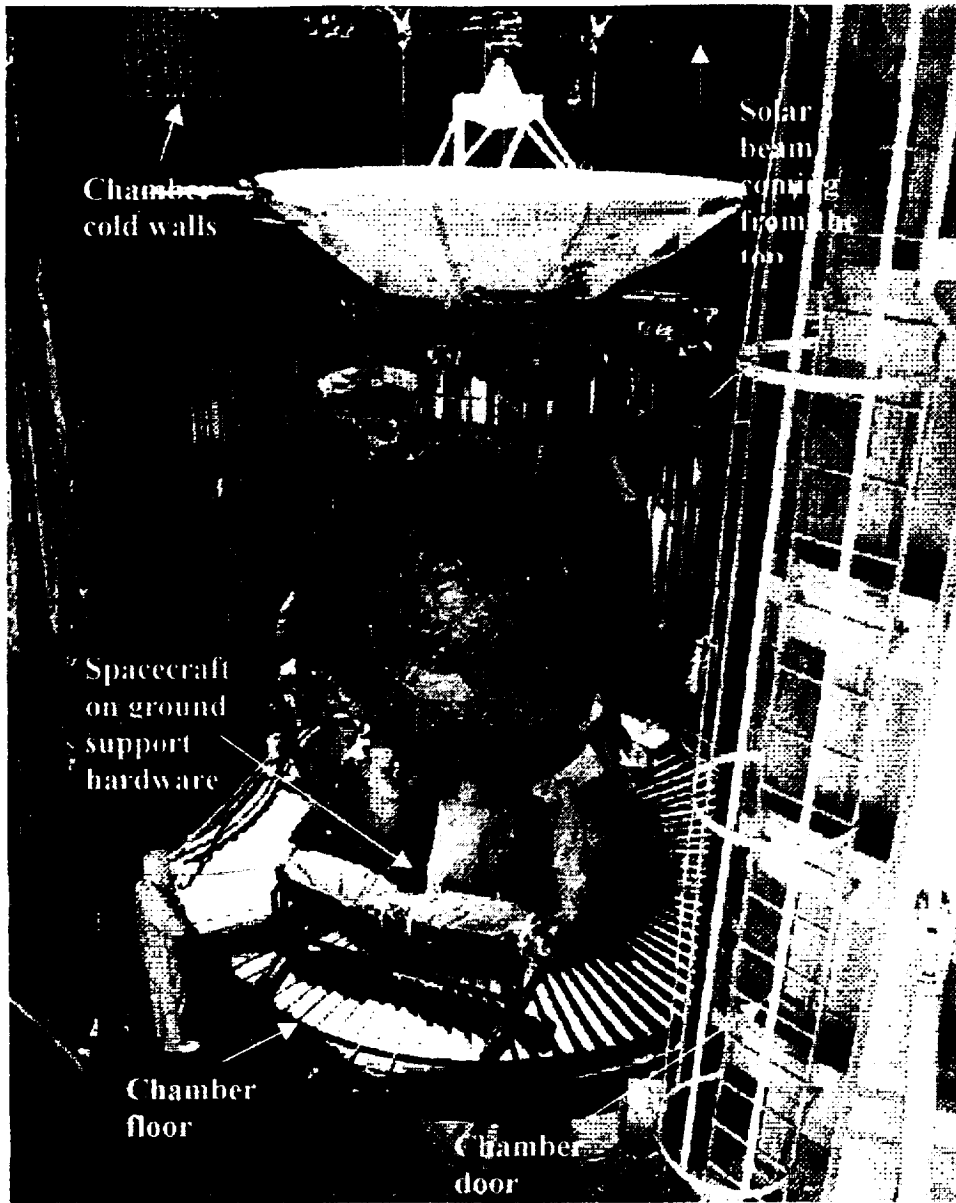

Figure 14. Multilayer thermal insulation used on spacecraft

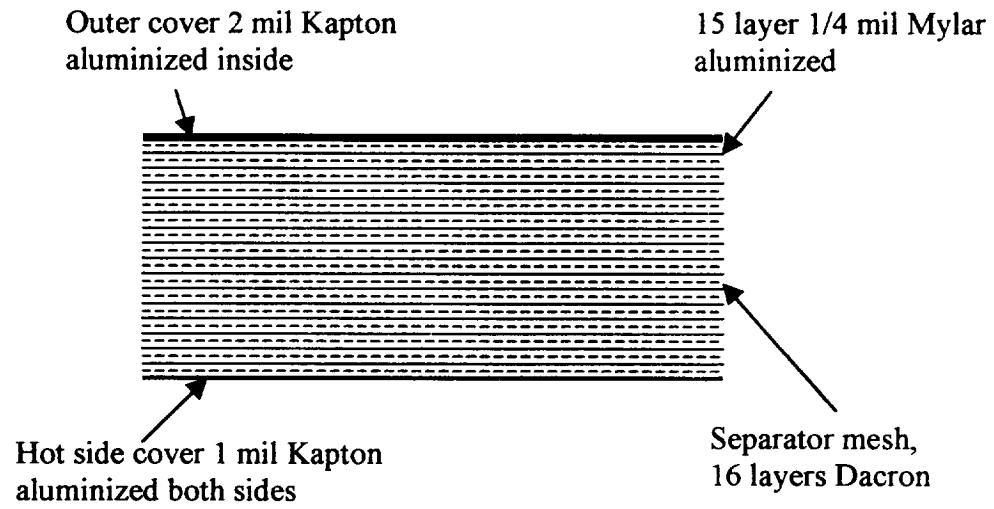

Figure 15. Mechanical louvers used on EOS-MLS spacecraft radiators

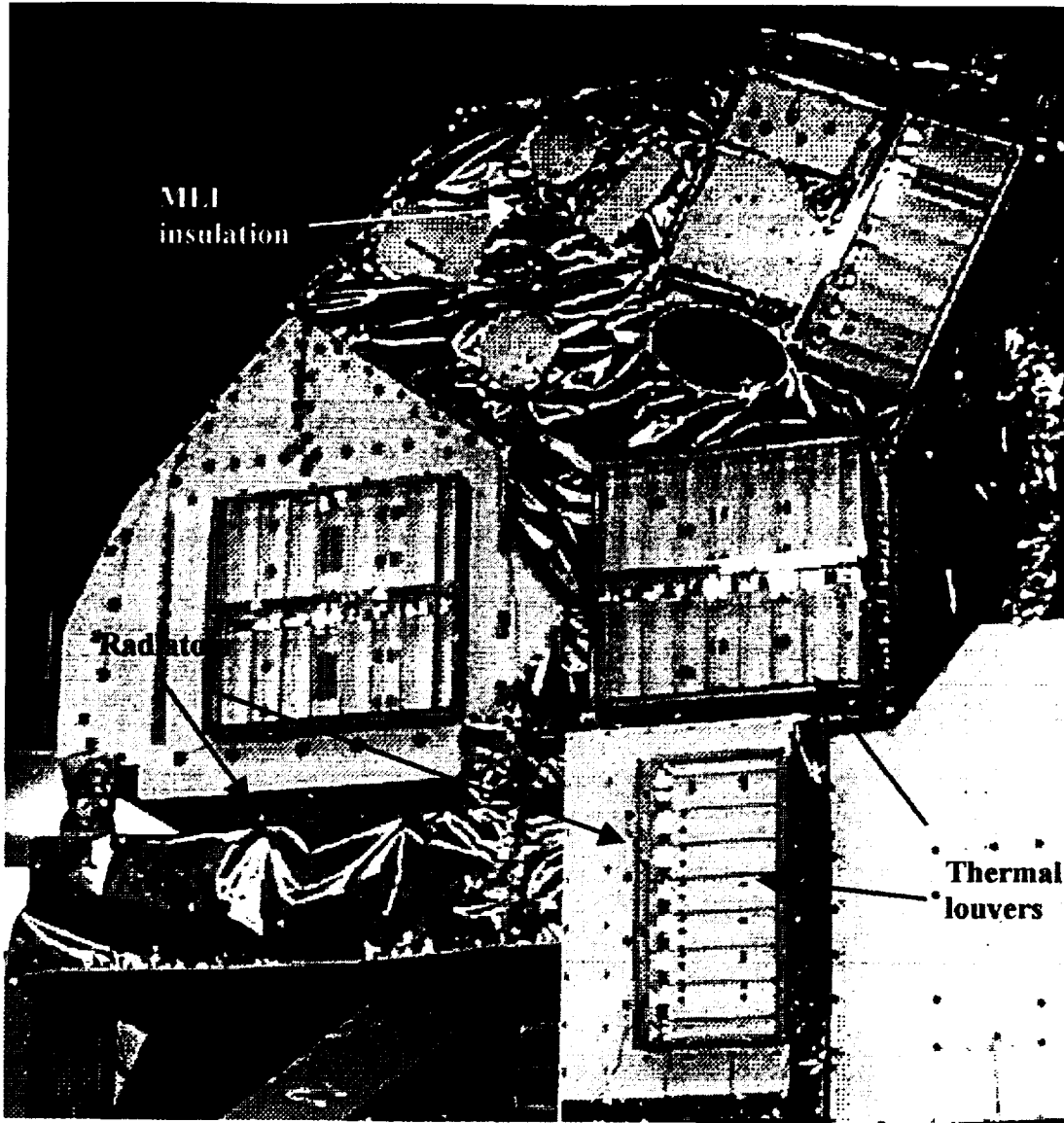

Figure 16. Construction details of a mechanical Louver used on spacecraft

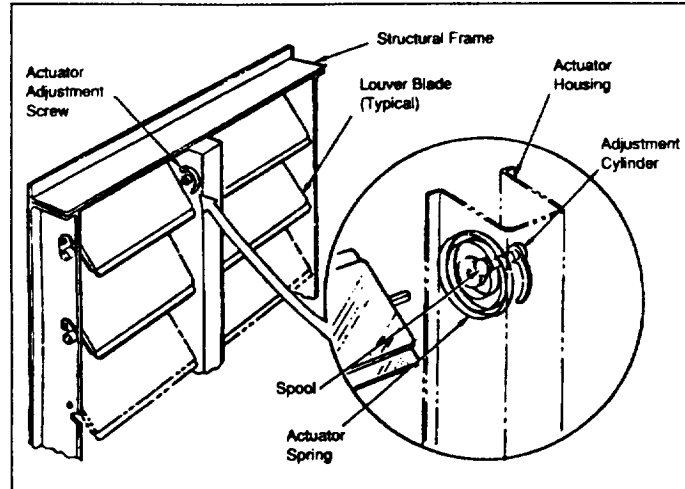

Figure 17. Construction details of a thermostat used on spacecraft

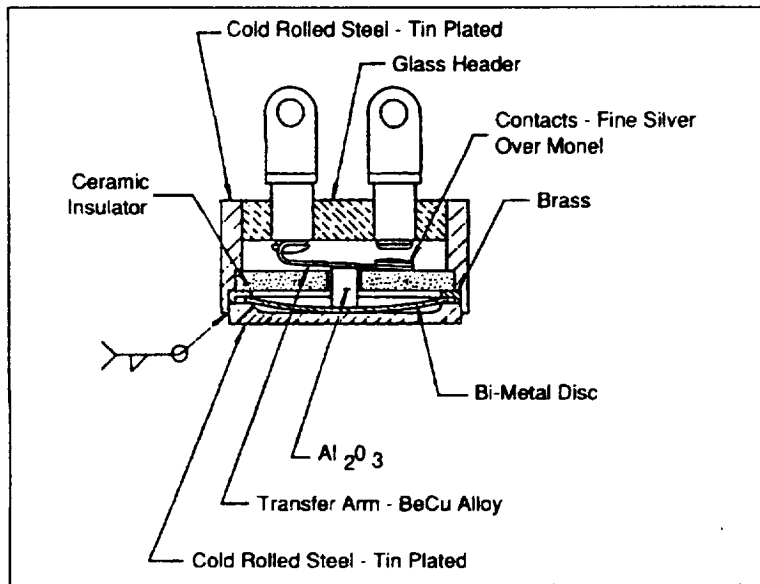

Figure 18. Heat pipe operation

