

NASA/TM-2001-211057

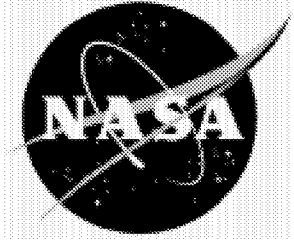

Rollout and Turnoff (ROTO) Guidance and Information Displays

Effect on Runway Occupancy Time in Simulated Low-Visibility Landings

*Richard M. Hueschen, Walter W. Hankins III, and L. Keith Barker
Langley Research Center, Hampton, Virginia*

December 2001

The NASA STI Program Office . . . in Profile

Since its founding, NASA has been dedicated to the advancement of aeronautics and space science. The NASA Scientific and Technical Information (STI) Program Office plays a key part in helping NASA maintain this important role.

The NASA STI Program Office is operated by Langley Research Center, the lead center for NASA's scientific and technical information. The NASA STI Program Office provides access to the NASA STI Database, the largest collection of aeronautical and space science STI in the world. The Program Office is also NASA's institutional mechanism for disseminating the results of its research and development activities. These results are published by NASA in the NASA STI Report Series, which includes the following report types:

- TECHNICAL PUBLICATION. Reports of completed research or a major significant phase of research that present the results of NASA programs and include extensive data or theoretical analysis. Includes compilations of significant scientific and technical data and information deemed to be of continuing reference value. NASA counterpart of peer-reviewed formal professional papers, but having less stringent limitations on manuscript length and extent of graphic presentations.
- TECHNICAL MEMORANDUM. Scientific and technical findings that are preliminary or of specialized interest, e.g., quick release reports, working papers, and bibliographies that contain minimal annotation. Does not contain extensive analysis.
- CONTRACTOR REPORT. Scientific and technical findings by NASA-sponsored contractors and grantees.
- CONFERENCE PUBLICATION. Collected papers from scientific and technical conferences, symposia, seminars, or other meetings sponsored or co-sponsored by NASA.
- SPECIAL PUBLICATION. Scientific, technical, or historical information from NASA programs, projects, and missions, often concerned with subjects having substantial public interest.
- TECHNICAL TRANSLATION. English-language translations of foreign scientific and technical material pertinent to NASA's mission.

Specialized services that complement the STI Program Office's diverse offerings include creating custom thesauri, building customized databases, organizing and publishing research results . . . even providing videos.

For more information about the NASA STI Program Office, see the following:

- Access the NASA STI Program Home Page at <http://www.sti.nasa.gov>
- Email your question via the Internet to help@sti.nasa.gov
- Fax your question to the NASA STI Help Desk at (301) 621-0134
- Telephone the NASA STI Help Desk at (301) 621-0390
- Write to:
NASA STI Help Desk
NASA Center for AeroSpace Information
7121 Standard Drive
Hanover, MD 21076-1320

NASA/TM-2001-211057

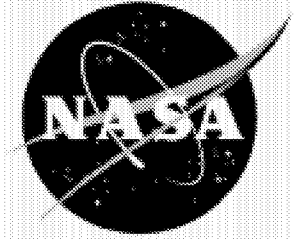

Rollout and Turnoff (ROTO) Guidance and Information Displays

Effect on Runway Occupancy Time in Simulated Low-Visibility Landings

*Richard M. Hueschen, Walter W. Hankins III, and L. Keith Barker
Langley Research Center, Hampton, Virginia*

National Aeronautics and
Space Administration

Langley Research Center
Hampton, Virginia 23681-2199

December 2001

Available from:

NASA Center for AeroSpace Information (CASI)
7121 Standard Drive
Hanover, MD 21076-1320
(301) 621-0390

National Technical Information Service (NTIS)
5285 Port Royal Road
Springfield, VA 22161-2171
(703) 605-6000

Acronyms

CG	center of gravity
DGPS	differential global positioning system
DIST	distance
ELEV	elevation
EX	exit
G	ground speed
GPS	global positioning system
HGS	head-up guidance system
HUD	head-up display
LaRC	Langley Research Center
LVLASO	low-visibility landing and surface operations
MAC	mean aerodynamic chord
MAN	manual
MLS	microwave landing system
NAV	navigation
ROT	runway occupancy time
ROTO	rollout and turnoff
RTCA	RTCA, Inc—private, not-for-profit corporation functioning as advisory committee to Federal Aviation Administration
RVR	runway visual range
RWY	runway
SEL	select
TD	touchdown
VE	exit speed

Abstract

This report examines a rollout and turnoff (ROTO) system for reducing the runway occupancy time for transport aircraft in low-visibility weather. Simulator runs were made to evaluate the system that includes a head-up display (HUD) to show the pilot a graphical overlay of the runway along with guidance and steering information to a chosen exit. Fourteen pilots (airline, corporate jet, and research pilots) collectively flew a total of 560 rollout and turnoff runs using all eight runways at Hartsfield Atlanta International Airport. The runs consisted of 280 runs for each of two runway visual ranges (RVRs) (300 and 1200 ft). For each visual range, half the runs were conducted with the HUD information and half without. For the runs conducted with the HUD information, the runway occupancy times were lower and more consistent. The effect was more pronounced as visibility decreased. For the 1200-ft visibility, the runway occupancy times were 13 percent lower with HUD information (46.1 versus 52.8 sec). Similarly, for the 300-ft visibility, the times were 28 percent lower (45.4 versus 63.0 sec). Also, for the runs with HUD information, 78 percent (RVR 1200) and 75 percent (RVR 300) had runway occupancy times less than 50 sec, versus 41 and 20 percent, respectively, without HUD information.

Introduction

Air travelers are familiar with flight delays, especially during bad weather. To facilitate higher airport throughput, the National Aeronautics and Space Administration has been looking at technology to increase traffic flow in general and sustain it even in low-visibility weather. Airport throughput is directly related to the capacity of its runways. Runway capacity when not limited by factors such as in-trail separation is inversely proportional to runway occupancy time. The Langley Research Center (LaRC) has been conducting research to develop systems for reducing runway occupancy time as described.

From 1974 to 1981, LaRC sponsored research efforts to develop navigation, guidance, and automatic control for the rollout and turnoff operation (refs. 1 to 4). These efforts were motivated by a new landing navigation system under development at that time—a microwave landing system (MLS)—and a proposed buried-wire navigation system. These systems had the potential to provide both precise longitudinal and lateral position information of the location of the aircrafts on the runway and exits (both critical for rollout and turnoff under low-visibility condi-

tions). References 1 to 4 detail the development of an automatic rollout and turnoff system and present simulation results. None of these efforts addressed the development of guidance for manual pilot control of the rollout and turnoff operation. Additionally, problems remained in obtaining the desired precision for longitudinal position information and burying a system of navigation wires along the runway centerline and exits.

In the 1980's the global positioning system (GPS), a satellite navigation system, was under development. Flight test experiments, beginning in 1990 which used various differential GPS (DGPS) navigation systems, showed that DGPS provided both precise lateral and longitudinal aircraft position information without the problems associated with MLS and the buried-wire navigation (refs. 5 to 7). These findings provided the impetus for LaRC to sponsor research, beginning in 1994, for the development of a rollout and turnoff system using DGPS that provided guidance for both manual and automatic control of a transport aircraft (refs. 8 and 9). These efforts resulted in system designs and simulation results for a Boeing MD-80 and a Boeing MD-11 aircraft and preliminary recommendations for head-up display (HUD) guidance symbology for manual

(pilot) control and monitoring of automatic control.

In 1996 LaRC began efforts to develop manual HUD guidance for rollout and turnoff operations by using a motion-based cockpit simulation. These efforts culminated in successful flight tests of an experimental system, called the rollout and turnoff (ROTO) system, in *clear-weather* conditions at Hartsfield Atlanta International Airport in August 1997 (refs. 10 and 11). The ROTO system was part of a research system developed under the Low-Visibility Landing and Surface Operations (LVLASO) Program. This system also provided the pilot with taxi guidance on a HUD and situational information via an airport map that was displayed on a navigation display (ref. 12). Analysis of the flight test data showed that the mean runway occupancy time (ROT) for the ROTO system was essentially the same as that for current aircraft operations at Hartsfield Atlanta Airport (ref. 10). This result was not a surprise because the deceleration profile used in the ROTO system design was based on the nominal deceleration profile performed by pilots for the rollout and turnoff operation in clear-weather conditions. One performance improvement for the ROTO system was that the standard deviation of runway occupancy time was half that of the Hartsfield Atlanta commercial aircraft operations ROT data (ref. 10). The commercial ROT data were computed from position data recorded for the same period of time as the flight tests.

For the flight test described, NASA safety regulations did not permit data acquisition for low-visibility conditions where significant benefits are anticipated. Therefore, to quantify low-visibility benefits of the ROTO system, an experiment was conducted in the Langley Visual Motion Simulator, which was also used for flight test development. With commercial and research test pilots as subject pilots, a large number of automatic landings were made to all runways of the Hartsfield Atlanta Airport with and without use of the ROTO system. After each landing, the subject pilot manually decelerated the aircraft to turnoff speed while the autoland system tracked runway centerline. After deceleration, the pilot

manually steered the aircraft clear of the runway. ROT data were recorded with and without the use of the ROTO system guidance and information for two reduced runway visual range (RVR) distances—300 and 1200 ft.

The main objective of this experiment was to quantify the level of ROT reduction when using the ROTO system in reduced visibility through statistical analysis of the recorded ROT data. This report describes the ROTO system including the HUD guidance symbology, the experiment, test procedures, test runs, and the statistical results.

ROTO System Description

This section presents an overview of the ROTO guidance system used in this investigation. Additional information on the ROTO system is found in reference 11.

The ROTO system provides the pilot with deceleration and centerline tracking guidance and situational information on a HUD to perform the rollout and turnoff operation. Prior to touchdown the system allows the pilot, via an exit selection switch, to either manually select an exit or command the system to select an exit for subsequently clearing the runway. After touchdown, the system provides predictive-and-control HUD graphics for deceleration to the turnoff speed of the selected exit and subsequent exit steering.

The heart of the system is software that receives inputs from a rotary exit selection switch, a DGPS navigation system, and aircraft sensors as illustrated in figure 1. The software computes guidance and situational information to drive symbology shown on a HUD.

Software

The ROTO software consists of four parts shown within the large block of figure 1: Exit selection, Guidance, Runway database, and Symbol generation and display.

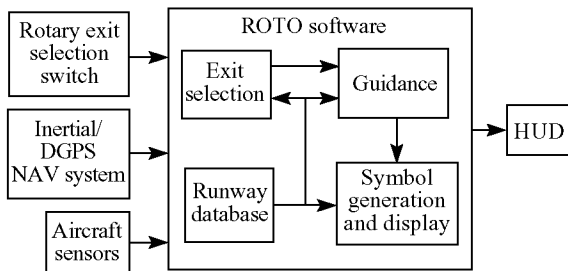

Figure 1. ROTO system.

The exit selection software receives inputs from a 10-position rotary exit selection switch, and logic determines if the exit is to be set by the pilot or the ROTO system. A sketch of the rotary exit selection switch used for the experiment is shown in figure 2.

Prior to touchdown, if the pilot sets the switch to the AUTO SEL position, the system selects an exit for which the system would provide deceleration guidance and situational information after landing. The system selects the closest exit (from exits defined in the runway database) for which the aircraft can attain the *nominal* exit turnoff speed with a constant deceleration of 6.5 ft/sec² assumed from touchdown to the exit. If the pilot sets the switch to position 1, the system will select exit 1 as defined in the runway database; if set to position 2, the system selects exit 2, et cetera. For the experiment, positions 7 and 8 were unusable due to simulator hardware wiring limitations.

If the exit selection switch is set to the PLAN VIEW position, a runway plan view (to be described in more detail later), showing the relative locations of the exits defined in the runway database, is momentarily displayed on the HUD. The exit selected by the ROTO system is shown in the plan view when set to this position. If the pilot sets the switch to any other switch position within 5 sec, the plan view will continue to be displayed and will show the selected exit for the position selected as described. If the pilot does not set the switch to a different position within 5 sec, the HUD display will revert to the symbology for approach to touchdown. All HUD symbology is described in detail in the next section “HUD Symbology.”

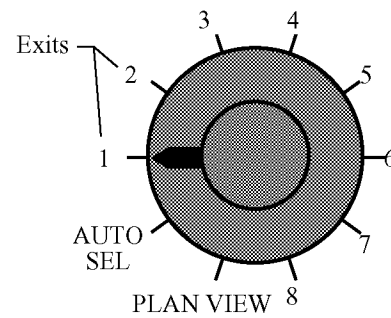

Figure 2. ROTO rotary exit selection switch.

After touchdown if the AUTO SEL position is set and the computed deceleration required to attain the *maximum* exit speed (as defined in the runway database) exceeds 10 ft/sec² for at least 1 sec, the system automatically selects the next available exit that satisfies the 6.5 ft/sec² constant deceleration condition. Alternatively, if the pilot (at any time) turns the switch to select a specific exit, the system provides guidance and situational information for that exit.

The guidance software provides information for driving HUD symbology that helps the pilot to decelerate the aircraft (so that the exit speed is achieved as the aircraft arrives at the exit) and to track the runway and exit centerlines. This software provides speed error, predicted exit speed, the location where the aircraft will attain the selected exit speed, and the predicted track position of the aircraft (up to 4 sec in the future).

Deceleration guidance is provided in the form of a displayed speed error. At main gear touchdown, the speed error computation is begun and constantly updated as the difference between a desired speed profile value and the ground speed measurement. The desired speed profile is generated at main gear touchdown and whenever a new exit is selected after touchdown. The speed profile decreases from the touchdown speed to the *nominal* exit speed (as defined in the runway database) at a runway location generally just prior to the start of the turnoff (the distance from this location to the start of the turnoff was named a buffer distance). This location is calculated in real-time and offset by a buffer distance parameter defined as a function of the exit speed. The

buffer distances for high-, mid-, and low-speed exits are, respectively, 200, 120, and 0 ft.

The equations used to compute the speed profile are summarized in the appendix. The development of the equations is described in reference 13 as the standard nonlinear speed profile.

The speed profile is a nonlinear deceleration profile representative of the deceleration profile shape that results when pilots perform the rollout and turnoff operation without deceleration guidance. Initially at touchdown, aerodynamic drag and main gear wheel friction result in a low level of deceleration. Then as the reverse thrust increases and the pilot uses the brakes, the deceleration increases to some maximum. As the exit nears, reverse thrust is lowered and removed as is braking to decrease deceleration.

An example of the deceleration profile for a typical computed ROTO speed profile is shown in figure 3 as a function of the normalized distance to the exit. This profile represents the deceleration profile shape that typically results when pilots decelerate an aircraft without any deceleration guidance.

The runway database software contains, for each runway, the coordinates for the threshold, length, and true heading. It also contains, for each exit, the distance to the start of the turnoff and the *nominal* and *maximum* exit speeds. The accuracy of the positional data is on the order of 1 ft which meets the RTCA Special Committee-193 (Terrain and Airport Data Bases) draft requirements of 0.5 m.

In the database, the exits for the Hartsfield Atlanta Airport were treated as three types: high-speed exits (30° angle turnoffs), mid-speed exits (45° angle turnoffs), and low-speed exits (90° angle turnoffs). The *nominal* speeds were set in the database for high-, mid-, and low-speed exits, respectively, as 50, 15, and 8 knots. The *maximum* exit speeds were set, respectively, to 60, 20, and 12 knots.

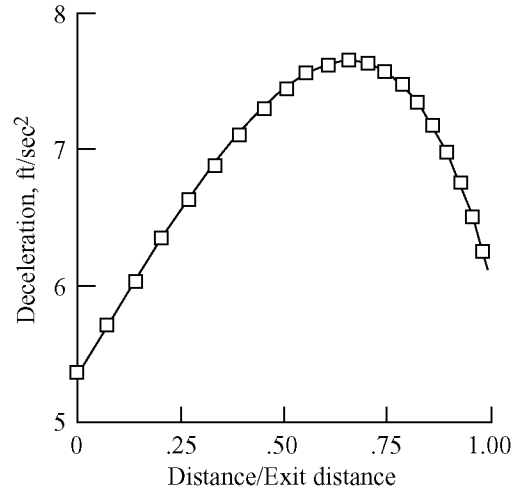

Figure 3. Example of nonlinear deceleration for computed speed profile.

HUD Symbology

There are two primary sets of HUD symbology: one for approach and the other for rollout and turnoff. A secondary set of symbology (the runway plan view) was referred to earlier in the discussion of exit selection in the previous section.

Approach

Figure 4 shows the approach HUD symbology that is displayed until main gear touchdown occurs. Much of the symbology is like that of the flight dynamics head-up guidance system (HGS) which is based on an inertial guidance HUD concept (ref. 14). This symbology is important for landing the aircraft manually but not for this experiment because the autoland system was used for that operation. Thus, only the symbology that was added for the ROTO system will be described here.

The ROTO additions are the glidepath aim point (two rectangular objects), the ROTO box, and the symbols outlining the runway and selected exit. The ROTO box shows the selected exit, its nominal speed, and the distance available to the exit for decelerating to that speed from the

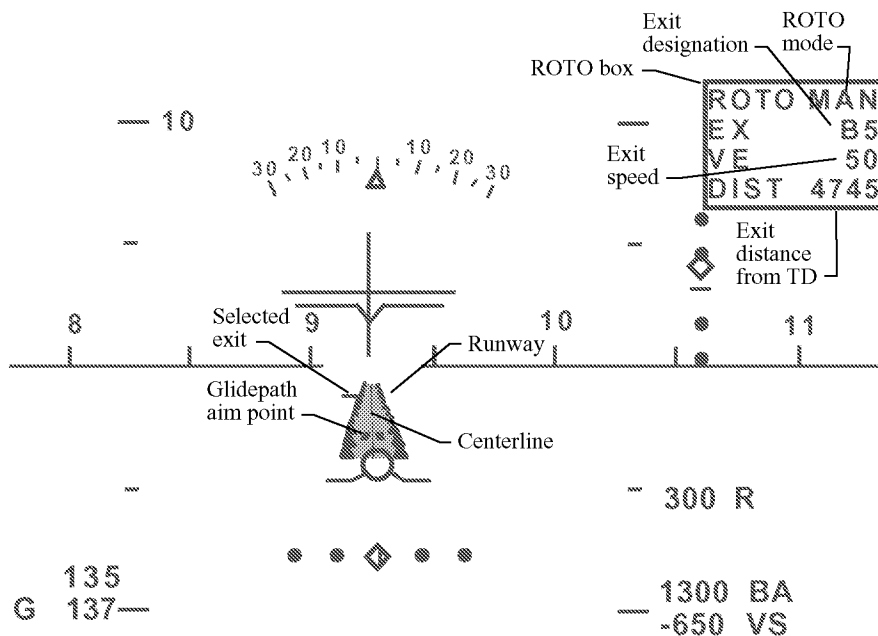

Figure 4. Approach symbology.

assumed touchdown location. The ROTO mode text in the upper right-hand corner of the ROTO box (MAN) is a placeholder to indicate if a potential future autopilot control system is engaged for tracking the computed ROTO guidance. If the ROTO autopilot is engaged, the text MAN would change to something like AUTO. This text has nothing to do with the automatic and pilot exit selection discussed earlier.

The glidepath aim point objects are located 1000 ft from the runway threshold where nominally the real glidepath markers are painted on the runway. The selected exit symbols show the pilot the relative distance that this exit is from runway threshold and on which side of the runway the exit is located.

As previously stated, the pilot may use the exit selection switch to temporarily display a plan view of the runway exits on the HUD (fig. 5) for review of the exit locations relative to each other. The selected exit is identified by the text on the second line in the ROTO box and by the path drawn on the plan view of the exits. (See fig. 5.) The text identifier for each exit is shown

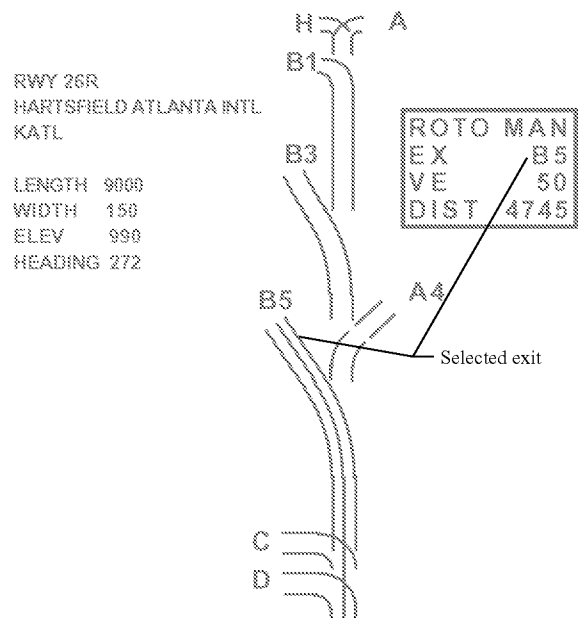

Figure 5. Plan view of runway exits.

by each exit on the display. At the upper left of the display, text information identifies the runway in use and the airport as well as runway length, width, elevation, and magnetic heading.

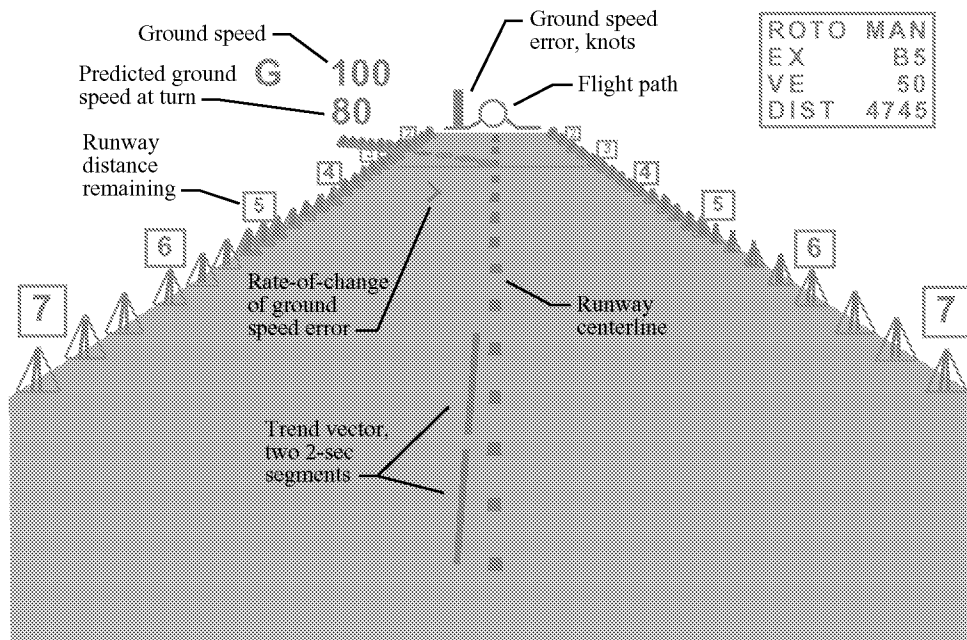

Figure 6. Rollout symbology immediately after touchdown.

Rollout

Figure 6 shows the HUD symbology after main gear touchdown. Most of the approach symbology is removed at touchdown and some new symbology is added. The only approach symbology remaining are the edges and centerline of the runway, the selected exit, the ROTO box, and the flight path symbol (circle with “wings” shown at end of runway). Symbology added are the ground speed error, ground speed, predicted ground speed at the turn, rate of change of ground speed error (>), trend vector, and runway distance remaining numbers.

The ground speed error, shown by a bar, is located on the left wing of the flight path symbol (fig. 6). The bar moves up and down according to the ground speed error and the left wing is its zero reference. It is the main guidance for decelerating the aircraft to turnoff speed immediately after touchdown. If the bar is above the left wing, the aircraft speed is faster than the speed profile value; if below, slower. Thus, when the speed error bar is barely visible, the aircraft speed is essentially the same as the speed profile value.

A companion symbol to the speed error bar is the greater-than symbol (>). It represents the rate of change of the ground speed error. If the symbol is above the left wing reference, the speed error changes in the positive direction at a rate proportional to its distance from the reference and, correspondingly, changes in the negative direction if below. For example, if the speed error bar was below the left wing, the pilot could reduce this negative speed error by adjusting the aircraft deceleration to place the greater-than symbol above the reference. When the speed error becomes small the pilot would then adjust the deceleration to place it at the wing reference indicating that the speed error is not changing.

The ground speed in knots is displayed to the left of the speed error bar (G 100 in fig. 6). The predicted exit speed is displayed below the aircraft ground speed (80 in fig. 6) and is continuously updated by using current position and ground speed and assuming constant deceleration. The pilot may use this speed as a cross-check of the speed error bar; for example, when the pilot adjusts the aircraft deceleration with reverse thrust and brakes to achieve a small speed error

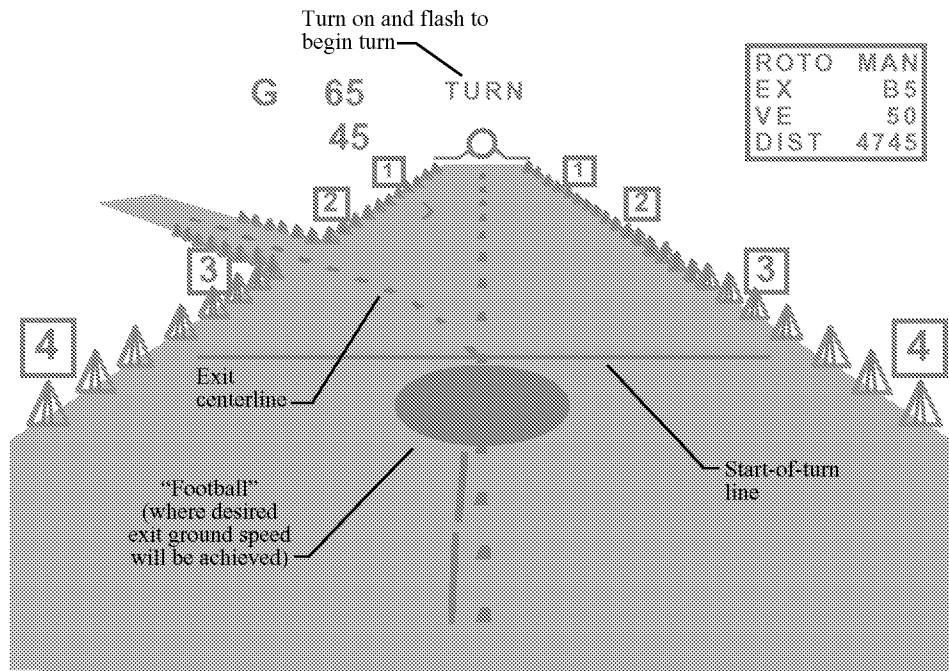

Figure 7. Rollout symbology near exit.

bar, this speed will have a value close to that shown in the ROTO box. Alternately, if the pilot chooses to arrive at the exit with a speed either lower or higher than the speed in the ROTO box, the pilot can adjust the deceleration so that the predicted exit speed is the turnoff speed the pilot desires.

The trend vector shows the predicted path of the nose of the aircraft with two arc segments; the arc ends indicate the location in 2 and 4 sec, respectively. It can be used for runway centerline tracking and is particularly useful for turning off the runway in low visibility. For turnoff, the pilot adjusts the turn rate so that the trend vector overlays the exit centerline.

Values for runway distance remaining (indicating thousands of feet remaining to the end of the runway) are shown in boxes along both runway sides. They are drawn at the same positions as the runway remaining signs in the real world.

The “football” (fig. 7) is another guidance symbol for decelerating the aircraft to the turnoff speed of the selected exit. This symbol shows

where on the runway the exit speed will be achieved with the current deceleration (if constant deceleration is assumed). Therefore, the pilot can adjust the aircraft deceleration so that the football is located just in front of the symbolic start-of-turn line to attain the desired speed at the turnoff. The football moves toward the aircraft with increased deceleration and, conversely, away from the aircraft with reduced deceleration.

Computation of the football and start-of-turn line begins at touchdown; however, they do not normally come into view until the aircraft gets closer to the selected exit because of the resolution and perspective of the display. Thus, the normal operation for using the HUD deceleration guidance is to initially use the speed error bar and then make a transition to the football guidance when it comes into view. Once the transition to the football is made, the pilot can focus on centerline tracking and deceleration at the same time because the football is located near the turnoff location.

An advisory message (TURN) is displayed (fig. 7) 3 sec before the start of the turnoff if

the *maximum* turnoff speed can be realized without exceeding 10 ft/sec² deceleration. After 1 1/2 sec it begins to flash and is removed after being displayed for 5 sec.

Simulator Description

The Langley Visual Motion Simulator (VMS), shown in figure 8, is a six degree-of-freedom motion-based simulator (ref. 15). The simulator has a “glass” cockpit that represents a modern-day transport aircraft. Both sides contain control-loaded rudder systems. The left side contains a tiller for nose wheel steering and a throttle quadrant is located in the center aisle stand. The cockpit is outfitted with four collimated window display systems to provide an out-the-window visual scene which is driven by an Evans and Sutherland ESIG 3000/GT computer-generated image system. Since the simulator does not have a HUD the ROTO HUD symbology video was mixed with the out-the-window scene (Hartsfield Atlanta International Airport) video to emulate the HUD.

The simulator was driven by nonlinear, rigid body dynamics of a Boeing 737-100 transport aircraft. The engine model (Pratt and Whitney JT8D) had full nonlinear dynamics to account for reverse thrust activation time as well as thrust buildup delays due to engine spoolup. A

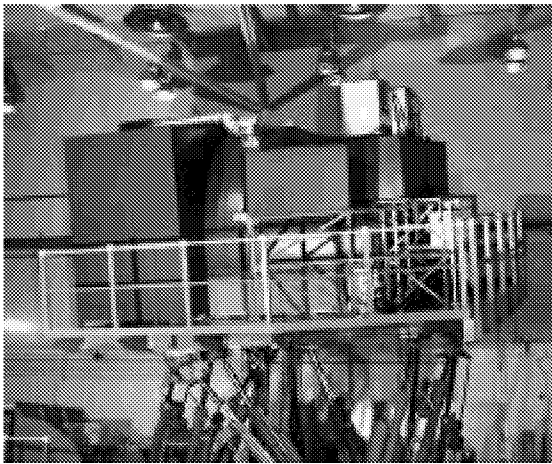

Figure 8. Langley Visual Motion Simulator.

high-fidelity landing gear model was used to account for manual braking. These high-fidelity models provide a high level of realism that was deemed essential for this experiment.

The nominal aircraft landing parameters are given in table 1.

Table 1. Simulated Aircraft Landing Parameters

Weight, lb.....	85 000
CG, percent MAC.....	20
Reference airspeed, knots.....	135
Flap deflection, deg	40

Experiment

As stated in the introduction, the main objective of the experiment was to quantify how much ROT would be reduced when using the ROTO HUD guidance in low-visibility conditions. Thus, test runs were made, and ROT data were recorded for later statistical analysis for four test conditions: with and without HUD guidance for 300-ft RVR and with and without HUD guidance for 1200-ft RVR. Without HUD guidance the pilot operated the aircraft as is currently done in low-visibility conditions; that is, the pilot performed manual deceleration while the autoland system steered the aircraft down the runway. After deceleration, the pilot visually located an exit and then steered the aircraft from the runway by using only the out-the-window scene.

Test Runs and Subject Pilots

Twenty test runs were considered reasonable for a subject pilot to perform per simulator session. One hundred and forty test runs per test condition were judged sufficient to provide statistical significance for analysis of the recorded ROT data.

Fourteen pilots participated in the experiment: six airline pilots with varying levels of experience in Boeing 737, Airbus A320, and Boeing 777 aircraft; three research pilots; two business jet pilots; one retired Boeing 747 captain; one

Table 2. Test Conditions for Pilots

Pilot	300-ft RVR		1200-ft RVR	
	Without guidance	With guidance	Without guidance	With guidance
1	√	√	√	
2	√	√	√	
3	√	√	√	
4	√		√	√
5	√	√		
6	√			
7	√	√		√
8		√		
9		√	√	
10			√	√
11			√	√
12				√
13				√
14				√

Table 3. Order of Landings for Test Runs

Run	Runway for landing
1	8L
2	27L
3	27R
4	26R
5	26L
6	9R
7	8R
8	9L
9	8L
10	27L
11	27R
12	26R
13	26L
14	9R
15	8R
16	9L
17	26R
18	26L
19	9R
20	8R

commuter pilot; and one engineer pilot. The goal was to use mostly airline and business jet pilots because the authors felt that the ROTO system would initially have the most benefit in airline and business jet aviation. However, due to budget

limitations, some commercial pilots had to be found on a voluntary basis. Also, most of the commercial pilots were not available for all conditions during the experiment time period. Thus, the same pilots were not available for all conditions.

Individual pilots performed 20 test runs for each condition in which they participated flying the simulator from the left position. Table 2 shows the test conditions that each pilot flew.

Landings were made to each end of the four runways of Hartsfield Atlanta International Airport. Consecutive landings to the same runway were avoided to prevent learned behavior from run to run; that is, the order of the landings was predefined to keep subjects from easily remembering the location and deceleration required to turn off at a given exit. The order of the landings is shown in table 3 and a sketch of the exits, in the direction towards the terminal, is shown in figure 9.

Each run included a pure crosswind of 10 knots blowing directly from the north. The crosswind resulted in touchdowns offset from runway centerline. Although the autoland system steered the aircraft back to runway centerline while the pilot decelerated the aircraft, the pilot needed to monitor that the aircraft was being maintained near runway centerline. Therefore, the effect of the crosswind was to potentially add additional workload for the pilot. The runway friction was set for a dry runway for all test runs.

The ROT, recorded for each test run, was defined as the time interval between when the aircraft passed over the threshold and when the entire aircraft was clear of the runway edge; that is, when both wingtips, horizontal stabilizer tips, and tail were clear.

Test Procedures

Prior to the start of a simulator session the subject pilot was given a briefing, approximately 1/2 hr long, on the ROTO system. Then the pilot

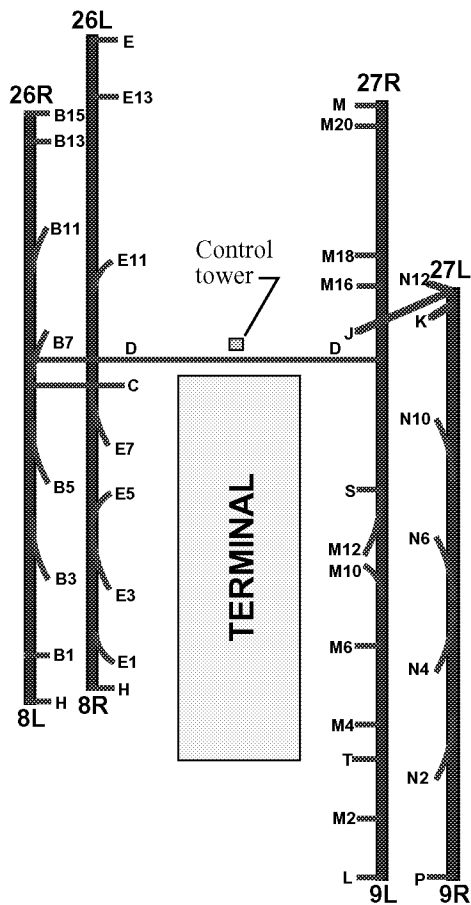

Figure 9. Hartsfield Atlanta runway exits towards terminal.

was briefed on the safety procedures for the motion-based operation and the simulator controls and instruments. Next, training runs were conducted (nominally three to five runs) until the pilot was comfortable with the ROTO guidance, operation of the simulator, and test run procedures. During training, the pilot was asked to perform the rollout and turnoff operation like he would with passengers aboard. In other words, they were asked to use decelerations that they felt would be acceptable to passengers. The initial training runs were made in clear weather conditions and the last one or two in reduced visibility. All training was performed on runway 9L which was used sufficiently later in the test run sequence

so that the pilots were not likely to remember its exit layout. For each simulator session, the experiment conductor and an experiment observer “rode” with the subject pilot in the simulator.

Prior to each run, the aircraft was initialized on the glideslope centerline and very near or on the localizer centerline in a landing configuration 1 nm from touchdown (approximately 300 ft in altitude) and trimmed at the reference airspeed. The speed brakes (spoilers) were armed for automatic deployment at touchdown and the autoland and autothrottle systems were engaged.

The pilot tasks in chronological order were to

1. Select exit on the runway using a Jeppesen paper map
2. Rotate exit selection switch to exit that is desired (runs with guidance) and, if desired, use automatic selection and/or runway plan view display
3. Ask computer operator to start the simulation and then monitor aircraft operation and, for guidance runs, ROTO HUD approach display to main gear touchdown
4. Disengage autothrottle at main gear touchdown
5. Decelerate the aircraft for runway turnoff; for guidance runs try to arrive at the exit with the specified exit speed by keeping the speed error small (speed error bar slightly visible if at all); if desired, control with footbrake when visible by keeping it just in front of the start-of-turn line
6. Disengage autopilot (to disable centerline tracking)
7. Turn aircraft onto the exit using rudder pedal and/or tiller nose-wheel steering and continue taxi until aircraft is completely clear of runway

Results and Discussion

To quantify the level of ROT reduction, various means and standard deviations of recorded ROT data were computed. Note from table 2 that each pilot did not fly every test condition; therefore, the analysis entails comparing means and standard deviations for each individual pilot and also for six groups of pilots. Group one (pilots 1, 2, 3, 5, and 7) consisted of those that performed runs both with and without guidance for the 300-ft RVR. Group two (pilots 4, 10, and 11) consisted of those that performed runs both with and without guidance for the 1200-ft RVR. The other four groups were those seven-pilot groups used for each test condition. (As shown in table 2, some in each of these four groups did not fly both with and without guidance for a given RVR.) Group three (for 300-ft RVR without guidance) consisted of pilots 1, 2, 3, 4, 5, 6, and 7. Group four (for 300-ft RVR with guidance) consisted of pilots 1, 2, 3, 5, 7, 8, and 9. Group five (for 1200-ft, without guidance) consisted of pilots 1, 2, 3, 4, 9, 10, and 11. Group six (for 1200-ft with guidance) consisted of pilots 4, 7, 10, 11, 12, 13, and 14.

The bar graphs of figures 10 and 11 show the means and standard deviations of the ROT for each subject pilot that participated in the 300-ft RVR. The means and standard deviations for those that participated in the 1200-ft RVR are shown in figures 12 and 13.

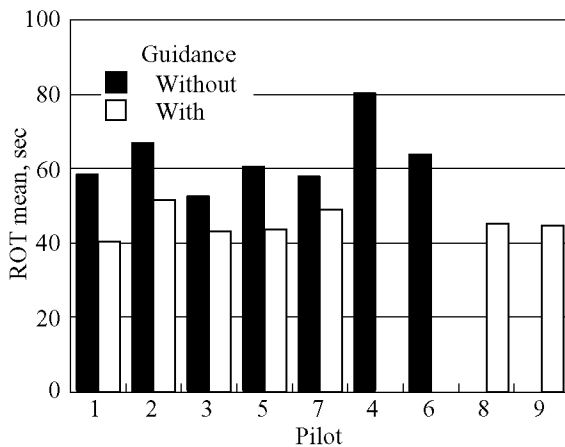

Figure 10. ROT mean for subject pilot for 300-ft RVR.

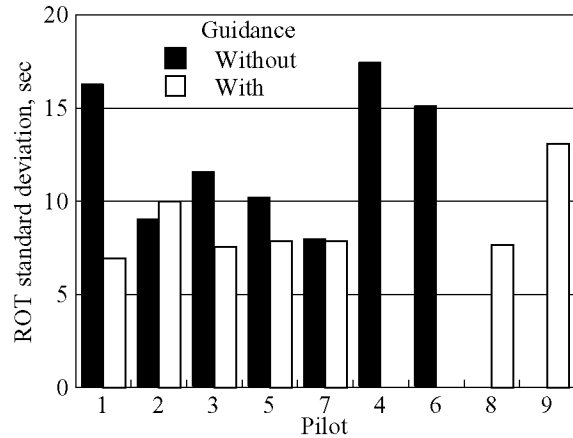

Figure 11. ROT standard deviation for subject pilot for 300-ft RVR.

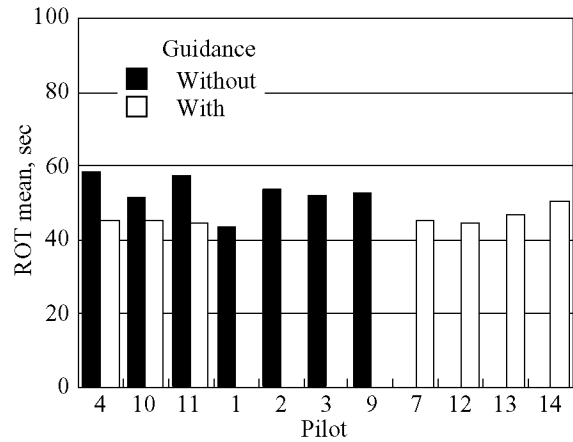

Figure 12. ROT mean for subject pilot for 1200-ft RVR.

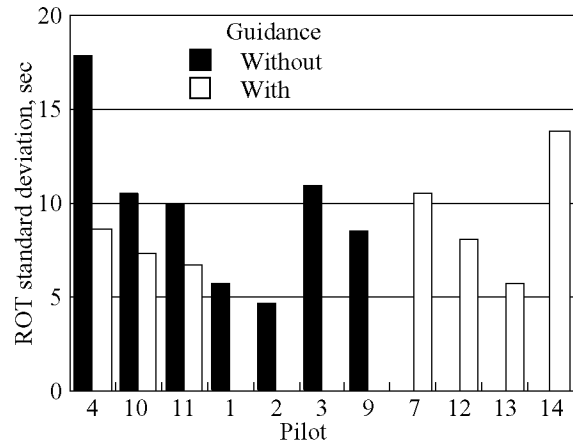

Figure 13. ROT standard deviation for subject pilot for 1200-ft RVR.

For each of the group one pilots (1, 2, 3, 5, and 7), figure 10 shows the mean with guidance is smaller than the respective mean without guidance. Figure 12 shows the same result for the group two pilots (4, 10, and 11). This result suggests that those pilots who only flew test runs without guidance would have had lower ROT means when performing test runs with the guidance. Likewise, the data suggest just the opposite for those who only flew runs with guidance. The data also show that all those who flew only runs without the guidance have mean ROT times higher than those who only flew with the guidance. So, generally, it is concluded that the mean ROT would be lower on a per pilot basis when the ROTO guidance is used.

The standard deviations with guidance for pilot groups one and two are all lower except for pilot 2. (See figs. 11 and 13.) However, for pilot 2, the difference between the standard deviations with and without guidance is relatively small. So, the use of ROTO guidance generally produced runway occupancy times that were more consistent on a per pilot basis.

The ROT means and standard deviations for pilot groups one and two are shown in table 4. As discussed earlier, group one (for the 300-ft RVR) contained five pilots (5 times 20 = 100 runs) and group two (for the 1200-ft RVR) contained three pilots (3 times 20 = 60 runs). To compare statistical results of the 300-ft RVR and the 1200-ft RVR, means and standard deviations for the 300-ft RVR were computed for the first 60 runs conducted and for the 100 runs performed. Thus, table 4 shows the means and standard deviations of the 300-ft RVR for both 60 and 100 runs.

Table 4 shows that, for the 1200-ft RVR, the ROT mean with guidance is 19 percent less than that without guidance (45.1 versus 55.8 sec), whereas for the 300-ft RVR and 60 runs, the improvement was 24 percent (45.0 versus 59.5 sec). The statistics for 60 and 100 runs for the 300-ft RVR are essentially the same.

The ROT means and standard deviations for pilot groups three, four, five, and six are shown in

Table 4. ROT Means and Standard Deviations for Subsets of Test Runs

[Runs that subject pilots flew both with and without guidance are included]

RVR, ft	Without guidance		With guidance	
	ROT mean, sec	ROT standard deviation, sec	ROT mean, sec	ROT standard deviation, sec
300 (100 runs)	59.4	12.1	45.5	8.9
300 (60 runs)	59.5	13.8	45.0	9.4
1200 (60 runs)	55.8	13.4	45.1	7.4

Table 5. ROT Means and Standard Deviations for All Test Runs

RVR, ft	Without guidance		With guidance	
	ROT mean, sec	ROT standard deviation, sec	ROT mean, sec	ROT standard deviation, sec
300	63.0	15.1	45.4	9.4
1200	52.8	11.2	46.1	9.0

table 5. Each of these groups represent one test condition and, therefore, the 140 test runs that were conducted for each test condition were used to compute the means and standard deviations shown in this table. Although some of the pilots in each of these groups did not perform runs both with and without guidance, computation of these statistics was judged reasonable based on examining the means of individual pilots shown in figures 10 and 12. In addition to the earlier discussion of the individual pilot ROT means, pilots 1, 2, and 3 who only performed runs without guidance for 1200-ft RVR (fig. 12) did perform runs with and without guidance for 300-ft visibility (fig. 10). With guidance, they all had means that were smaller than those without guidance. Also, pilot 4 who only made runs without guidance for the 300-ft RVR made runs for the 1200-ft RVR both with and without guidance. For the 1200-ft RVR for pilot 4, the mean

ROT with guidance was lower than that without guidance. Again, as stated earlier, these observations suggest that on a per pilot basis the mean ROT will decrease when the guidance is used. Therefore, computation of ROT means and standard deviations including all test runs for each test condition appeared reasonable.

With the inclusion of all test runs, the mean ROT for the 1200-ft RVR is 13 percent less with guidance (46.1 versus 52.8 sec). For the 300-ft RVR the mean ROT is 28 percent less (45.4 versus 63.0 sec).

The data of tables 4 and 5 show that, with guidance, the pilots were able to get the aircraft off the runway faster and more consistently (as indicated by the standard deviations in the tables). The effect was more pronounced with decreased visibility.

Also, with guidance the ROT means are essentially the same regardless of RVR. This result implies that the use of ROTO has the potential to render runway capacity insensitive to changing visibility conditions.

The standard deviations with guidance in both tables 4 and 5 are all smaller than those without guidance. This difference implies that the use of guidance will result in runway occupancy times with less dispersion.

The ROT data were also analyzed by examining the cumulative probability of the ROT data being less than a given time. Figure 14 shows plots of the computed probabilities for the four test conditions as the percentage of ROT times that were less than or equal to a given time selected on the abscissa axis.

The landing speed used in the simulation tests was 135 knots, which is representative of the landing speeds for the heavy transport aircraft class. The mean ROT for the landing of the heavy transport aircraft class in clear weather for the currently operational environment is around 50 sec (ref. 16); therefore, the 50-sec time was used as a reference.

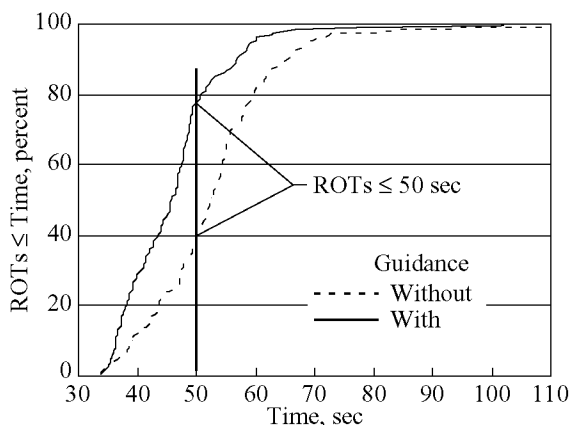

(a) 1200-ft RVR.

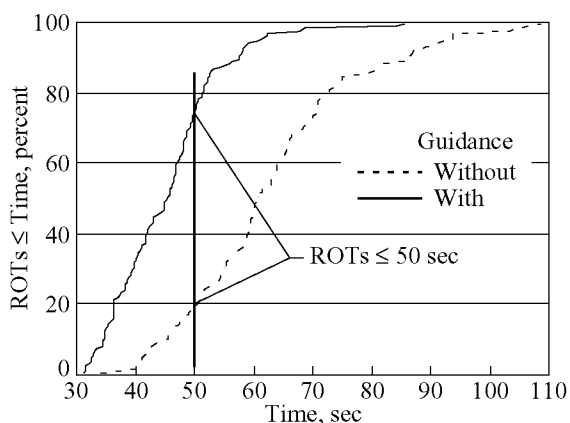

(b) 300-ft RVR.

Figure 14. ROTs less than or equal to a specified ROT.

The probability plots show, for a time of 50 sec, that with guidance, 78 percent of the runway occupancy times for the 1200-ft RVR and 75 percent for the 300-ft RVR were less than or equal to 50 sec versus 41 percent and 20 percent, respectively, without guidance. This analysis, like the analysis of the ROT mean numbers, also shows that the ROTO guidance reduces runway occupancy time in low-visibility conditions and that the reduction is greater for decreased visibility. Also, like the ROT mean analysis, the probability curves indicate that, with the ROTO guidance, ROT is insensitive to the visibility level since the curves for guidance are nearly alike.

Concluding Remarks

Statistical analysis of data from piloted simulations has shown that the LaRC-developed ROTO (rollout and turnoff) guidance and information system can reduce runway occupancy time (ROT) of transport aircraft in low-visibility operations.

When analyzing the ROT data for only those pilots that flew both with and without the ROTO guidance system, the mean ROT with guidance for 1200-ft RVR was 19 percent less than that without guidance (45.1 versus 55.8 sec). For 300-ft RVR, the mean ROT with guidance was 24 percent less than that without guidance (45.0 versus 59.5 sec). For the ROT data generated by all pilots that were used for a test condition (justification for including pilots who did not fly both

with and without ROTO was established by examining individual pilot performance), the mean ROT with guidance was also less than that without guidance. The mean ROT with guidance for 1200-ft RVR was 13 percent less than that without guidance (46.1 versus 52.8 sec). For 300-ft visibility, the mean ROT with guidance was 28 percent less than that without guidance (45.4 versus 63.0 sec).

Analysis of data also showed that, when using the ROTO system, runway occupancy time was insensitive to the visibility levels tested. The ROT means were essentially the same and the standard deviations were similar for tested visibility levels at 300- and 1200-ft RVR. Thus, the use of the ROTO system could become part of a solution that would maintain airport clear weather capacity in reduced-visibility weather.

Appendix A

Equations for Nonlinear Deceleration Speed Profile

The symbols used in this appendix are defined as follows:

a	acceleration, ft/sec ²
c_n	distance of navigational reference point from aircraft nose, ft
c_1	known constant, ft/sec ²
c_2	known nondimensional constant
d_{buf}	constant distance from start of exit turn at which to achieve exit speed, ft
k	dimensionless constant in speed profile
v	ground speed of airspeed, ft/sec
Δv	difference between ground speed and profile speed, ft/sec
v_c	profile (commanded) speed, ft/sec
$v_{e,\text{nom}}$	nominal selected exit speed, ft/sec
v_o	speed at start of profile; touchdown ground speed, ft/sec
x	current distance of navigation reference along runway, ft
x_e	exit distance on runway, ft
x_o	distance of navigation reference point at start of speed profile, ft
ξ	nondimensional distance

Distance is measured along the runway centerline, positive in direction of landing.

Define a convenient variable to represent a nondimensional distance as

$$\xi = \frac{x - x_o}{x_e - d_{\text{buf}} - x_o - c_n}$$

and a constant gain k to control the maximum deceleration as

$$k = \frac{v_o - v_{e,\text{nom}}}{v_o}$$

Then the commanded ground speed of the aircraft is given by the nonlinear speed profile as

$$v_c = v_o - (v_o - v_{e,\text{nom}}) \xi e^{k(\xi-1)}$$

Hence for a given location on the runway, the speed error is

$$\Delta v = v - v_c$$

The speed error is shown graphically to the pilot on a HUD. The pilot responds with reverse thrust and/or braking to track the speed profile.

The aircraft decelerates along the speed profile from some initial condition on the runway to an exit. This deceleration as a function of the nondimensional distance is

$$a = c_1(1 + k\xi) e^{-k} \left[1 - c_2 \xi e^{k(\xi-1)} \right] e^{k\xi}$$

where the known constants c_1 and c_2 are

$$c_1 = v_o \left(\frac{v_o - v_{e,\text{nom}}}{x_e} \right)$$

$$c_2 = 1 - \frac{v_{e,\text{nom}}}{v_o}$$

The analytical analysis in reference 13 gives further examples of different speed profiles.

References

1. Pines, S.; Schmidt, S. F.; and Mann, F.: *Simulation, Guidance and Navigation of the B-737 for Rollout and Turnoff Using MLS Measurements*. NASA CR-144959, 1975.
2. Pines, S.; Schmidt, S. F.; and Mann, F. I.: *Automated Landing, Rollout, and Turnoff Using MLS and Magnetic Cable Sensors*. NASA CR-2907, 1977.
3. Pines, S.; and Hueschen, R. M.: *Guidance and Navigation for Automatic Landing, Rollout, and Turnoff Using MLS and Magnetic Cable Sensors*. AIAA-78-1296, Jan. 1978.
4. Pines, Samuel: *Terminal Area Automatic Navigation, Guidance, and Control Research Using the Microwave Landing System (MLS). Part I—Automatic Rollout, Turnoff, and Taxi*. NASA CR-3451, 1981.
5. Vallot, Lawrence; Snyder, Scott; Schipper, Brian; Parker, Nigel; and Spitzer, Cary: *Design and Flight Test of a Differential GPS/Inertial Navigation System for Approach/Landing Guidance*. *NAVIGATION*, vol. 38, no. 2, Summer 1991, pp. 103–122.
6. Van Graas, Frank; Diggle, David W.; and Hueschen, Richard M.: *Interferometric GPS Flight Reference/Autoland System*. *NAVIGATION*, vol. 41, no. 1, Spring 1994, pp. 57–81.
7. Rowson, Stephen V.; Courtney, Glenn R.; and Hueschen, Richard M.: *Performance of Category IIIB Automatic Landings Using C/A-Code Tracking Differential GPS*. *NAVIGATION*, vol. 41, no. 2, Summer 1994, pp. 127–143.
8. Goldthorpe, Steve H.; Kernik, Alan C.; McBee, Larry S.; and Preston, Orv W.: *Guidance and Control Requirements for High-Speed Rollout and Turnoff (ROTO)*. NASA CR-195026, 1995.
9. Goldthorpe, S. H.; Dangaran, R. D.; Dwyer, J. P.; McBee, L. S.; Norman, R. M.; Shannon, J. H.; and Summers, L. G.: *Guidance and Control Design for High-Speed Rollout and Turnoff (ROTO)*. NASA CR-201602, 1996.
10. Hueschen, Richard M.; Hankins, Walter W.; and Barker, L. Keith: *Description and Flight Test of a Rollout and Turnoff Head-Up Display Guidance System*. 17th Digital Avionics System Conference (Bellevue, WA), Nov. 3–5, 1998.
11. Johnson, Edward J., Jr.; and Hyer, Paul V.: *Roll-Out and Turn-Off Display Software for Integrated Display System*. NASA/CR-1999-209731, 1999.
12. Young, Steven D.; and Jones, Denise R.: *Flight Demonstration of Integrated Airport Surface Movement Technologies*. NASA/TM-1998-206283, 1998.
13. Barker, L. Keith; Hankins, Walter W., III; and Hueschen, Richard M.: *Speed Profiles for Deceleration Guidance During Rollout and Turnoff (ROTO)*. NASA/TM-1999-209829, 1999.
14. Bray, R. S.; and Scott, B. C.: *A Head-up Display for Low-Visibility Approach and Landing*. AIAA-81-0130, Jan. 1981.
15. Telban, Robert J.; Cardullo, Frank M.; and Houck, Jacob A.: *Developments in Human Centered Cueing Algorithms for Control of Flight Simulator Motion Systems*. AIAA-99-4328, 1999.
16. Lee, Derrick D.; Smith, Alexander; Cassell, Rick; and Bassam, Abdul-Baki: *NASA Low Visibility Landing and Surface Operations (LVLASO) Runway Occupancy Time (ROT) Analysis*. AIAA 18th Annual Digital Avionics System Conference, Oct. 1998.

REPORT DOCUMENTATION PAGE			Form Approved OMB No. 0704-0188	
Public reporting burden for this collection of information is estimated to average 1 hour per response, including the time for reviewing instructions, searching existing data sources, gathering and maintaining the data needed, and completing and reviewing the collection of information. Send comments regarding this burden estimate or any other aspect of this collection of information, including suggestions for reducing this burden, to Washington Headquarters Services, Directorate for Information Operations and Reports, 1215 Jefferson Davis Highway, Suite 1204, Arlington, VA 22202-4302, and to the Office of Management and Budget, Paperwork Reduction Project (0704-0188), Washington, DC 20503.				
1. AGENCY USE ONLY (Leave blank)	2. REPORT DATE December 2001	3. REPORT TYPE AND DATES COVERED Technical Memorandum		
4. TITLE AND SUBTITLE Rollout and Turnoff (ROTO) Guidance and Information Displays <i>Effect on Runway Occupancy Time in Simulated Low-Visibility Landings</i>			5. FUNDING NUMBERS WU 728-60-30-01	
6. AUTHOR(S) Richard M. Hueschen, Walter W. Hankins III, and L. Keith Barker				
7. PERFORMING ORGANIZATION NAME(S) AND ADDRESS(ES) NASA Langley Research Center Hampton, VA 23681-2199			8. PERFORMING ORGANIZATION REPORT NUMBER L-18084	
9. SPONSORING/MONITORING AGENCY NAME(S) AND ADDRESS(ES) National Aeronautics and Space Administration Washington, DC 20546-0001			10. SPONSORING/MONITORING AGENCY REPORT NUMBER NASA/TM-2001-211057	
11. SUPPLEMENTARY NOTES				
12a. DISTRIBUTION/AVAILABILITY STATEMENT Unclassified-Unlimited Subject Category 03 Distribution: Standard Availability: NASA CASI (301) 621-0390			12b. DISTRIBUTION CODE	
13. ABSTRACT (Maximum 200 words) This report examines a rollout and turnoff (ROTO) system for reducing the runway occupancy time for transport aircraft in low-visibility weather. Simulator runs were made to evaluate the system that includes a head-up display (HUD) to show the pilot a graphical overlay of the runway along with guidance and steering information to a chosen exit. Fourteen pilots (airline, corporate jet, and research pilots) collectively flew a total of 560 rollout and turnoff runs using all eight runways at Hartsfield Atlanta International Airport. The runs consisted of 280 runs for each of two runway visual ranges (RVRs) (300 and 1200 ft). For each visual range, half the runs were conducted with the HUD information and half without. For the runs conducted with the HUD information, the runway occupancy times were lower and more consistent. The effect was more pronounced as visibility decreased. For the 1200-ft visibility, the runway occupancy times were 13 percent lower with HUD information (46.1 versus 52.8 sec). Similarly, for the 300-ft visibility, the times were 28 percent lower (45.4 versus 63.0 sec). Also, for the runs with HUD information, 78 percent (RVR 1200) and 75 percent (RVR 300) had runway occupancy times less than 50 sec, versus 41 and 20 percent, respectively, without HUD information.				
14. SUBJECT TERMS Head-up display guidance; Rollout and turnoff deceleration guidance; Runway occupancy time; Low-visibility guidance			15. NUMBER OF PAGES 22	
			16. PRICE CODE	
17. SECURITY CLASSIFICATION OF REPORT Unclassified	18. SECURITY CLASSIFICATION OF THIS PAGE Unclassified	19. SECURITY CLASSIFICATION OF ABSTRACT Unclassified	20. LIMITATION OF ABSTRACT UL	