

5/19/04/14/33

Multiplexed Readout of Thermal Bolometers with Superconducting Transition Edge Thermometers

Dominic J. Benford, Christine A. Allen, James A. Chervenak,
Mino M. Freund, Alexander S. Kuttyrev[†], S. Harvey Moseley,
Richard A. Shafer & Johannes G. Staguhn[†]

NASA - Goddard Space Flight Center, Code 685, Greenbelt, MD 20771
[†] Raytheon/ITSS

Erich N. Grossman, Gene C. Hilton, Kent D. Irwin,
John M. Martinis, Sae-Woo Nam & Carl D. Reintsema

NIST - Boulder, MS 814.03, Boulder, CO 80305

Abstract

History shows that in astronomy, more is better. In the near future, direct detector arrays for the far-infrared and submillimeter will contain hundreds to thousands of elements. A multiplexed readout is necessary for practical implementation of such arrays, and has been developed using SQUIDs. The technology permits a 32×32 array of bolometers to be read out using ~ 100 wires rather than the >2000 needed with direct wiring. These bolometer arrays are made by micromachining techniques, using superconducting transition edge sensors as the thermistors. We describe the development of this multiplexed superconducting bolometer array architecture as a step toward bringing about the first astronomically useful arrays of this design. This technology will be used in the SAFIRE instrument on SOFIA, and is a candidate for a wide variety of other spectroscopic and photometric instruments.

Keywords: bolometer, far-infrared, submillimeter, superconducting, SQUID, detector array, multiplexer, transition edge sensor

Introduction

Advances in bolometer fabrication have made possible the construction of submillimeter-wavelength cameras with up to 100 direct-detection bolometer elements (e.g., CSO - SHARC (Wang *et al.* 1996), JCMT - SCUBA (Holland *et al.* 1996), IRAM 30m (Kreysa *et al.* 1998)). Currently, the sensitivity of these instruments is background-limited, so deep- and wide-field surveys are limited by the number of detectors and the amount of observing time available. During the past decade, the number of bolometers in large arrays has doubled approximately every 2 years. Within the next few years, kilopixel arrays will be needed for the next generation of astronomical instruments for ground-based, airborne (SOFIA) and spaceborne platforms. In order to achieve a leap to a thousand detectors, a scalable detector architecture must be demonstrated. Such an architecture should deal with both the fabrication of an array and the electronics used to read it out. Specifically, multiplexed readouts are necessary for kilopixel-class arrays. In this paper, we present first results for an architecture which can be readily scaled

to kilopixel arrays using superconducting sensors and a multiplexed amplifier technique (Chervenak *et al.* 1999) to reduce the wiring overhead.

Detector arrays using this technology are currently being developed for use in the SAFIRE instrument for SOFIA (Shafer *et al.* 2001) and for a ground-based spectrometer (Benford *et al.* 2001). A common figure of merit for bolometers is the Noise Equivalent Power (NEP). This is the power that yields a signal-to-noise ratio of unity in a 1Hz bandwidth, and is expressed in units of W/\sqrt{Hz} . For SAFIRE, observations of the CII line at 1900GHz (158 μ m) with a spectral resolving power of 1000, the maximum NEP for the detectors must be $10^{-17} W/\sqrt{Hz}$. NEP can be converted into an equivalent noise temperature $T_N = NEP/(2k\sqrt{\Delta\nu})$ (Phillips 1988). In the above case, this yields a noise temperature of around 8K. While not achievable with heterodyne spectrometers due to the quantum limit, direct detection has no such restriction.

Superconducting Thermal Bolometers

The transition between a superconducting and a normal state can be used as an extremely sensitive thermometer. A thin film, held at its transition temperature, requires only a tiny amount of power to warm it above its transition, increasing the resistance by a large fraction. In fact, the superconducting transition can be very sharp, yielding a dimensionless sensitivity defined as $d \log R / d \log T \approx 1000$ at best. Recently, we have fabricated thin film superconducting bilayers of molybdenum and gold (Benford *et al.* 2000) and molybdenum and copper (Irwin *et al.* 2000). One such transition is shown in Figure 1; it features a bilayer with 400Å of molybdenum and 750 Å of gold, yielding a normal resistance of 220m Ω . Near its transition temperature of 450mK, the sensitivity approaches 1100. By varying the thicknesses of the bilayer materials, the transition temperature may be selected to suit the astronomical application.

Because the transition region is narrow (~ 1 mK) compared to the temperature above the heat sink (150mK above a 3 He refrigerator at 300mK), the TES is nearly isothermal across the transition. In use as a detector, the power applied to raise the TES into its transition region is nearly constant. This has the effect that the response becomes linear to better than 1%, substantially better than the typical linearity achieved with semiconducting thermistors.

In order to make a detector of the appropriate sensitivity, we have fabricated monolithic linear silicon bolometers using micromachining techniques (Figure 2). These bolometers have slim silicon legs that provide thermal isolation and a 1mm² absorber to couple to the far-infrared light. The thermal conductance at the operating temperature determines the optical power that the device is optimized for; current arrays are being fabricated for operation with ≈ 1 pW of optical loading. These linear bolometer arrays can be folded such that the legs (and, therefore, electrical connections) are hidden completely behind the absorber, allowing close-packing perpendicular to the array. The folding is possible because the silicon membranes become flexible at the 1 μ m thickness used. In this way, a two-dimensional array of large size can be made with near unity filling factor.

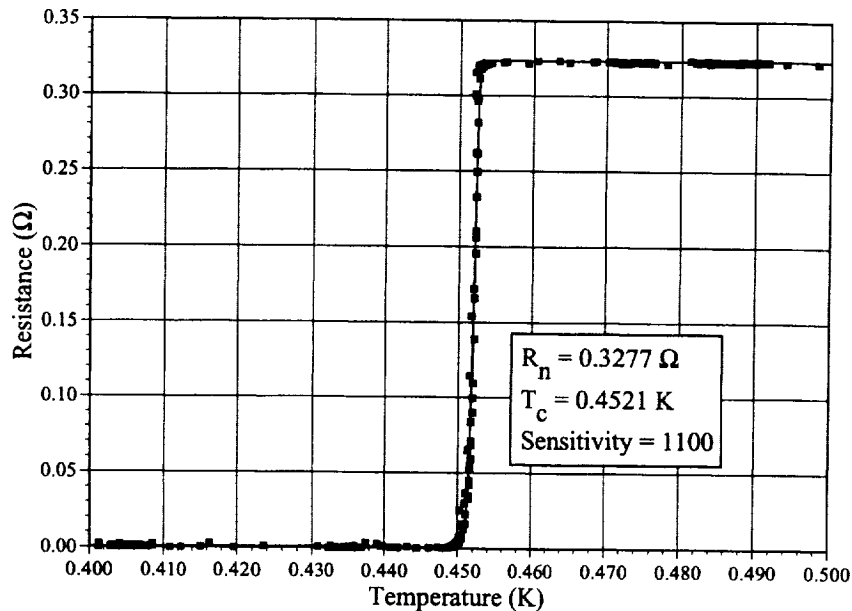

Figure 1. Superconducting transition at 444mK for a Mo/Au bilayer.

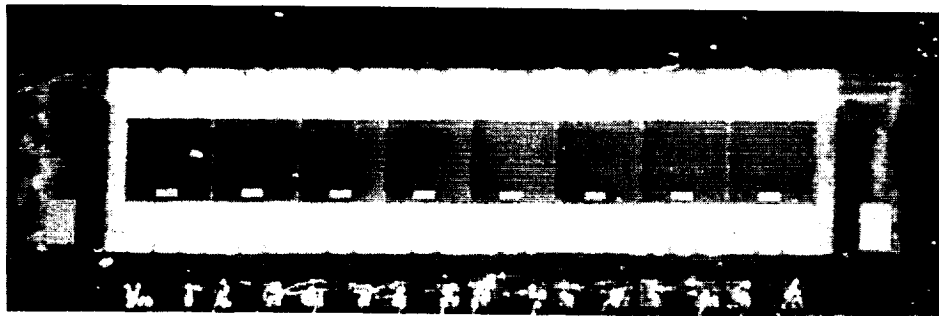

Figure 2. A single element from the middle of a linear array of TES bolometers. The absorber is 1mm on a side.

SQUID Multiplexer / Amplifier

A low-impedance detector such as a superconducting TES is well-matched by a superconducting SQUID amplifier. From a fundamental standpoint, a SQUID amplifier functions as a magnetic flux to voltage converter, with extremely low output voltage noise. A voltage-biased TES in series with a pickup inductor placed near a SQUID will induce a changing flux through the SQUID when the TES resistance changes. This changing flux results in an output voltage which is a periodic function of the input, as shown in Figure 3. The SQUID amplifier uses the technique of Welty & Martinis (1993), in which the first stage SQUID is used to drive a series array of SQUIDs which yield a voltage gain of 100. This Series Array Amplifier can produce an output voltage of the order of a millivolt, readily amplified by room-temperature electronics.

In order to remove the inconvenience of a periodic and strongly nonlinear output, a digital linearization circuit has been built. A second inductor, for feedback, is also placed near the SQUID. Any change in the output voltage of the SQUID is reapplied to the feedback coil with opposite sign, bringing the SQUID back to its original total input flux. This has the effect of nulling the SQUID (i.e., its net flux can be kept near zero at all times) and linearizes the SQUID response so that the problem of handling a periodic output need not be tackled.

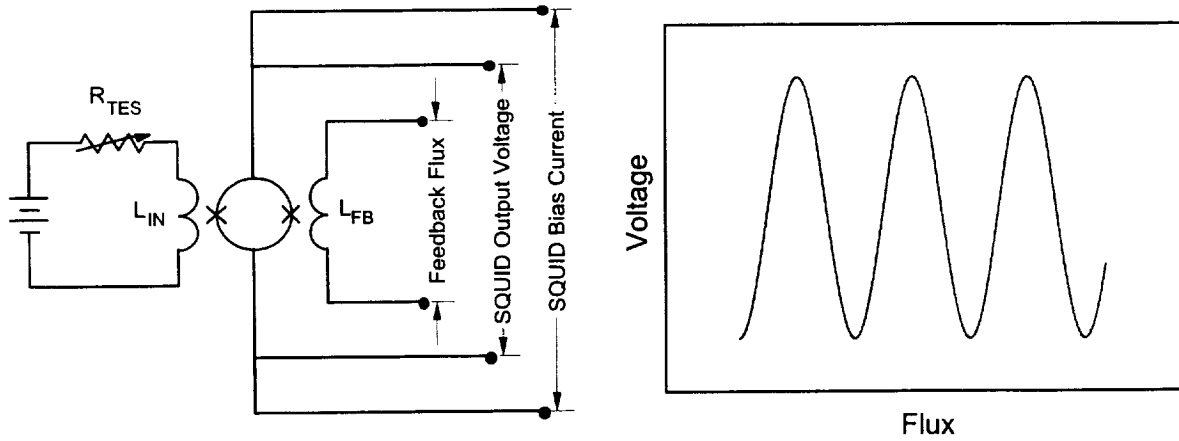

Figure 3. (L) A single SQUID amplifier circuit and (R) its transfer function.

A SQUID amplifier can be switched rapidly between an operational state and an inoperational, superconducting state by biasing the SQUID with roughly $100\mu\text{A}$ of current. If we stack n SQUIDs in series with $n+1$ electrical address leads as shown Figure 4, driving current between an adjacent pair of leads will result in only one SQUID being operational. With the other SQUIDs in the superconducting state, the output voltage across the entire array is exactly the voltage across the one active SQUID. In this manner, only one amplifier is necessary for n detectors, although at a data rate n times faster. This is *time-division multiplexing*. Adding in connections for a common TES bias and feedback signal, and a total of $n+7$ wires are needed.

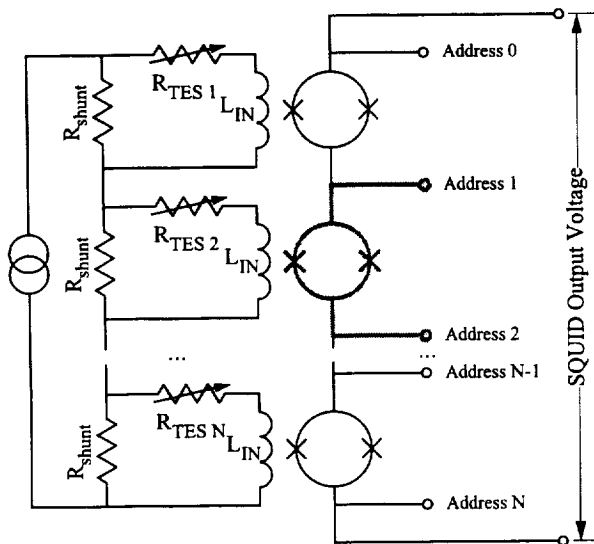

Figure 4. A multiplexed SQUID amplifier reading out n detectors. A total of $n+7$ wires are needed (assuming ganged biases).

A 1×8 SQUID multiplexer has been built (Figure 5) and tested using the circuit described in Chervenak *et al.* (1999). One triangle and one sine wave inputs were fed into a cold electronics setup so as to mimic the modulation of a signal from infrared light. The multiplexed amplifier was switched between these inputs, amplified, and digitized. A sample time series of data at this point is shown in Figure 5 of Chervenak *et al.* (1999). This data can be demultiplexed to recover the original input waves, which demonstrates the excellent fidelity of the amplifier (Figure 6). Furthermore, crosstalk between channels is a maximum of 2% (although this depends on the readout speed). Adjacent channels in a Nyquist-sampled detector array would have many times this level of optical crosstalk, so the multiplexer has sufficient adjacent channel rejection for most purposes.

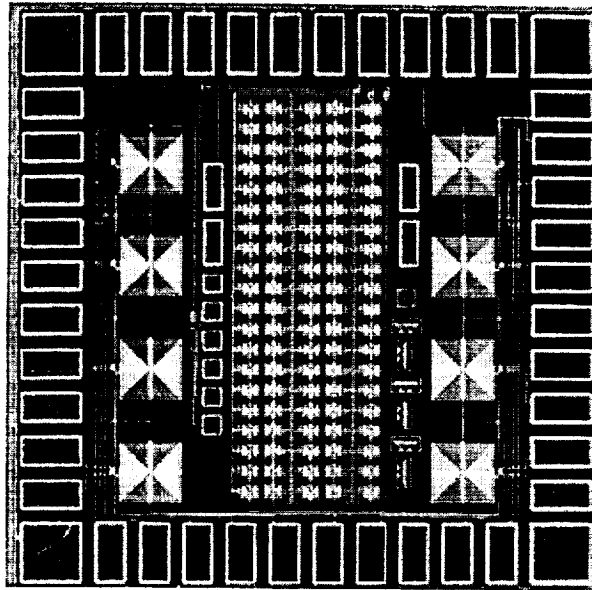

Figure 5. SQUID Multiplexer/Amplifier for 8 detectors; the 4 input coils flank the 100-element series array on the left and right sides.

It should be pointed out that the TES is biased at all times, and is low-pass filtered using an inductor with time constant $L/R \approx 2\mu\text{s}$ to a response time slower than the multiplex switching time. Effectively, the TES self-integrates so that the multiplexer *samples* an integrated signal; no loss of signal-to-noise is introduced even though the signal from each TES is read out for a shorter time. This is true provided that the noise of the SQUID is substantially less (by a factor of more than \sqrt{n}) than that of the TES. Furthermore, in order to remain stable, the devices must be sampled faster than $f_{LR} = (3 + 2\sqrt{2})f_{TES} \approx 100 \text{ kHz}$.

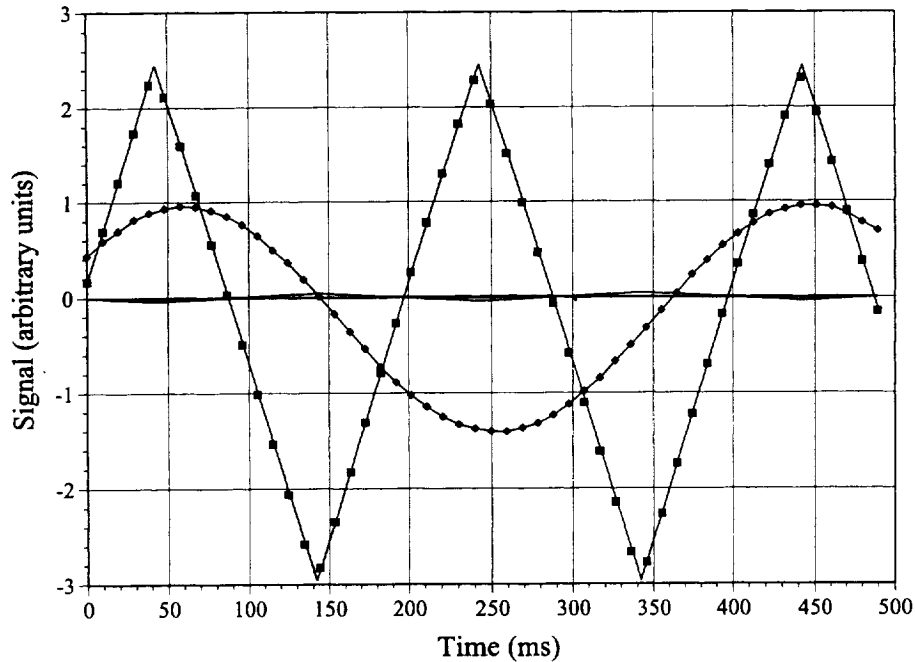

Figure 6. Crosstalk measured for 8 detectors read out simultaneously; one triangle wave and one sine wave excitation were applied.

Performance of Multiplexed SQUID Readout

Optical performance was measured in a test setup designed to calibrate low-background detectors for SPIRE (Hargrave *et al.* 1999). This setup used a helium-cooled blackbody consisting of a textured, black, carbon-loaded epoxy (Epotek 920) wall in a gold-coated cavity. Selectable apertures allow the throughput to the blackbody to be chosen. The blackbody can be heated to cover temperatures between 2K and 40K. A metal-mesh bandpass filter at 350 μ m wavelength (850GHz) with a fractional bandpass of $\sim 1/10$ reduced the total transmitted power to be within the range of our bolometers, which were designed to saturate (i.e., be driven normal) at 5pW. The result of the blackbody calibration is shown in Figure 7, where the measured power has been corrected for a bolometer absorptivity of 90%. The measured response follows the theoretical power very well up to a saturation power of 2.1pW, about half the designed value. The excellent linearity of TES bolometers is one of their best features.

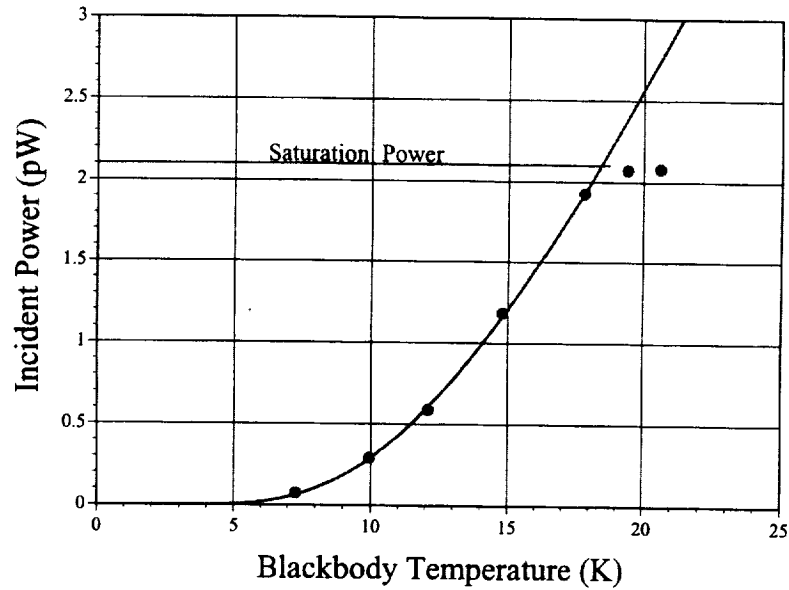

Figure 7. Measured and theoretical power versus blackbody temperature for a helium-cooled calibration source, assuming a detector absorptivity of 90%.

In addition to calibration with the blackbody, the test setup permits an external source to be used. In order to reduce the optical load to an acceptable level, a 1% transmissive neutral density filter is placed in the beam. The time constant was measured by using a rapidly chopping blade with a hot/warm load. An upper limit of $\tau \leq 2\text{ms}$ was found, limited by the speed of the chopper. A Fourier transform spectrometer was used to measure the frequency response, which was limited by the bandpass filter. No bandwidth degradation due to inefficiencies in the absorbing coating were seen. Also, a beam map was made, and excellent rejection of out-of-beam power was found.

In Figure 8, we show the Noise Equivalent Power (NEP) of a TES bolometer using an Aluminum/Silver bilayer operating at a transition temperature of 568mK. The NEP over the desired 10-100Hz bandwidth is $2.8 \times 10^{-17} \text{W}/\sqrt{\text{Hz}}$. The phonon noise calculation is shown as a solid line, demonstrating that phonon-limited performance has been obtained. Over a 100GHz bandwidth at 850GHz, this noise level corresponds to a detector noise temperature of 3.2K. The measured noise levels of lower-transition (440mK) devices have been about 20% above the phonon noise level, indicating excess noise which is believed to arise from edge effects where the bilayer thicknesses are not well defined. Recent results using Molybdenum/Copper bilayers appear not to have this excess noise.

Finally, we have used the multiplexer to read out 8 detectors simultaneously while observing a chopped hot/cold load. The data, read out in real time like a strip chart, are shown in Figure 9. This demonstration showed that time domain multiplexing/demultiplexing of the signals from 8 bolometers was feasible in real time with high fidelity. Furthermore, we have measured the photon noise in this situation, showing that it is ~ 10 times the electrical noise including the detector and multiplexer noise contributions.

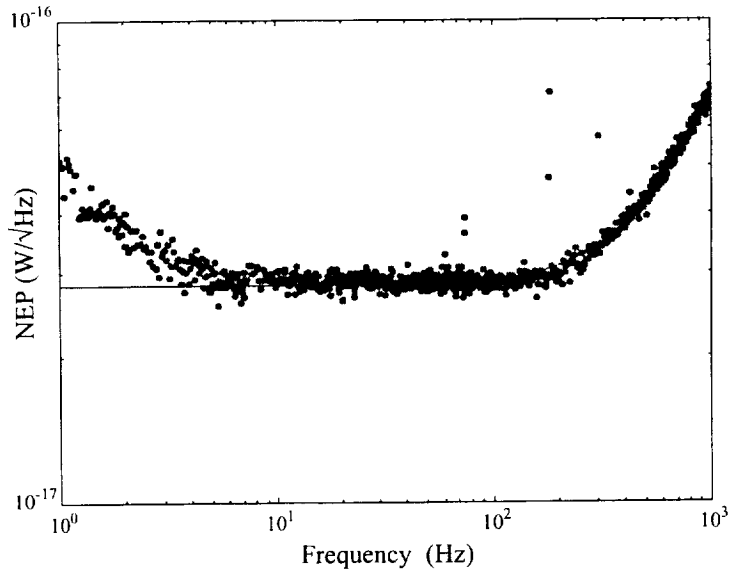

Figure 8. NEP of a detector operating at 568mK. The phonon noise calculation is shown as a solid line, demonstrating that phonon-limited performance has been obtained over the 10-100Hz signal band.

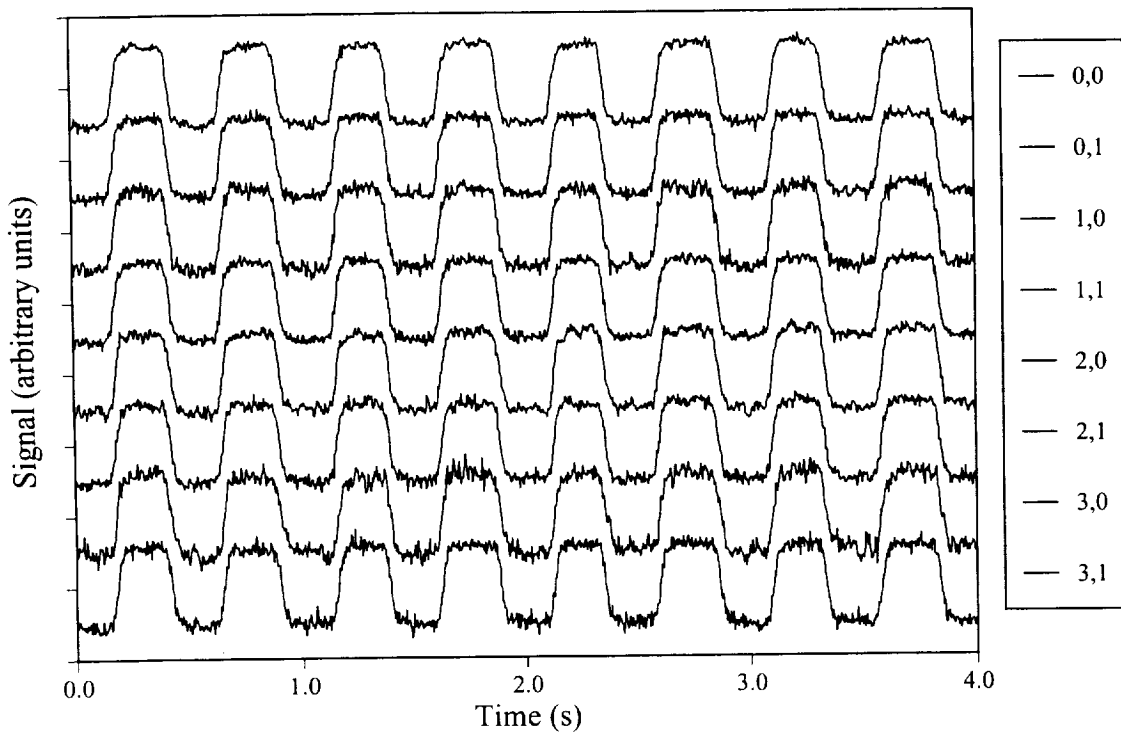

Figure 9. Multiplexed detection of 8 detectors viewing a chopped hot/cold load, read out simultaneously and demultiplexed on-the-fly.

Conclusion

We have demonstrated superconducting transitions in Mo/Au and Mo/Cu bilayers which look promising for use as TES films on sensitive bolometers. Noise Equivalent Powers consistent with phonon noise have been measured, and optical efficiency of 90% has been achieved. A multiplexed SQUID amplifier has been fabricated and is shown to provide low-noise, high-fidelity readout of several TES detectors with a single signal output. We have validated the use of time-division multiplexing for reading background-limited TES bolometers while observing optical sources. This architecture can be extended to large-format (thousands of detectors) bolometer arrays, having application in future far-infrared instruments such as SPIFI on the AST/RO telescope and SAFIRE on the SOFIA observatory.

References

- Benford, D.J. *et al.*, 2000, *Int J. IR MM Waves*, **21** (12), 1909.
- Benford, D.J., Maffei, B., Moseley, S.H., Pajot, F., Phillips, T.G., Rioux, C. & Shafer, R.A. 2000, *BAAS*, **197**, 53.03
- Chervenak, J.A., Irwin, K.D., Grossman, E.N., Martinis, J.M., Reintsema, C.D. & Huber, M.E. 1999, *Appl. Phys. Lett.*, **74**, p.4043
- Hargrave, P.C. *et al.* 2000, *NIMA*, **444**, 427-431
- Holland, W.S. *et al.* 1996, *Int J IR MM Waves*, **17**, p.669
- Irwin, K.D., Hilton, G.C., Martinis, J.M., Deiker, S., Bergren, N., Nam, S.W., Rudman, D.A. & Wollman, D.A. 2000, *NIMA*, **444**, 184-187
- Kreysa, E. *et al.* 1998, *Proc. SPIE #3357, Advanced Technology MMW, Radio, and Terehertz Telescopes*, T.G. Phillips, ed., p.319
- Phillips, T.G. 1988, in *Millimetre and Submillimeter Astronomy*, Wolstencroft & Burton, eds., p.1
- Shafer, R.A., Moseley, S.H., Ade, P.A.R., Benford, D.J., Dwek, E., Pajot, F., & Stacey, G.J. 2000, *BAAS*, **197**, 53.02
- Wang, N.W. *et al.* 1996, *Applied Optics*, **35**, p.6639
- Welty, R.P. & Martinis, J.M. 1993, *IEEE Trans. App. Superconductivity*, **3**, p.2605