

NASA/TP-2002-211441

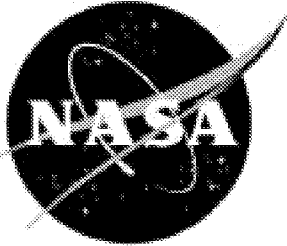

Piloted Simulation Assessment of a High-Speed Civil Transport Configuration

*E. Bruce Jackson and David L. Raney
Langley Research Center, Hampton, Virginia*

*Louis J. Glaab
Lockheed Martin Engineering & Sciences Corporation, Hampton, Virginia*

*Stephen D. Derry
Langley Research Center, Hampton, Virginia*

March 2002

The NASA STI Program Office . . . in Profile

Since its founding, NASA has been dedicated to the advancement of aeronautics and space science. The NASA Scientific and Technical Information (STI) Program Office plays a key part in helping NASA maintain this important role.

The NASA STI Program Office is operated by Langley Research Center, the lead center for NASA's scientific and technical information. The NASA STI Program Office provides access to the NASA STI Database, the largest collection of aeronautical and space science STI in the world. The Program Office is also NASA's institutional mechanism for disseminating the results of its research and development activities. These results are published by NASA in the NASA STI Report Series, which includes the following report types:

- **TECHNICAL PUBLICATION.** Reports of completed research or a major significant phase of research that present the results of NASA programs and include extensive data or theoretical analysis. Includes compilations of significant scientific and technical data and information deemed to be of continuing reference value. NASA counterpart of peer-reviewed formal professional papers, but having less stringent limitations on manuscript length and extent of graphic presentations.
- **TECHNICAL MEMORANDUM.** Scientific and technical findings that are preliminary or of specialized interest, e.g., quick release reports, working papers, and bibliographies that contain minimal annotation. Does not contain extensive analysis.
- **CONTRACTOR REPORT.** Scientific and technical findings by NASA-sponsored contractors and grantees.
- **CONFERENCE PUBLICATION.** Collected papers from scientific and technical conferences, symposia, seminars, or other meetings sponsored or co-sponsored by NASA.
- **SPECIAL PUBLICATION.** Scientific, technical, or historical information from NASA programs, projects, and missions, often concerned with subjects having substantial public interest.
- **TECHNICAL TRANSLATION.** English-language translations of foreign scientific and technical material pertinent to NASA's mission.

Specialized services that complement the STI Program Office's diverse offerings include creating custom thesauri, building customized databases, organizing and publishing research results . . . even providing videos.

For more information about the NASA STI Program Office, see the following:

- Access the NASA STI Program Home Page at <http://www.sti.nasa.gov>
- Email your question via the Internet to help@sti.nasa.gov
- Fax your question to the NASA STI Help Desk at (301) 621-0134
- Telephone the NASA STI Help Desk at (301) 621-0390
- Write to:
NASA STI Help Desk
NASA Center for AeroSpace Information
7121 Standard Drive
Hanover, MD 21076-1320

NASA/TP-2002-211441

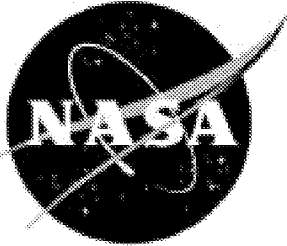

Piloted Simulation Assessment of a High-Speed Civil Transport Configuration

*E. Bruce Jackson and David L. Raney
Langley Research Center, Hampton, Virginia*

*Louis J. Glaab
Lockheed Martin Engineering & Sciences Corporation, Hampton, Virginia*

*Stephen D. Derry
Langley Research Center, Hampton, Virginia*

National Aeronautics and
Space Administration

Langley Research Center
Hampton, Virginia 23681-2199

March 2002

The use of trademarks or names of manufacturers in this report is for accurate reporting and does not constitute an official endorsement, either expressed or implied, of such products or manufacturers by the National Aeronautics and Space Administration.

Available from:

NASA Center for AeroSpace Information (CASI)
7121 Standard Drive
Hanover, MD 21076-1320
(301) 621-0390

National Technical Information Service (NTIS)
5285 Port Royal Road
Springfield, VA 22161-2171
(703) 605-6000

Contents

Symbols and Abbreviations vii

Summary. 1

Introduction 2

Simulated Aircraft Model. 3

 Cycle 2B Model Origins 3

 General Vehicle Specifications 3

 Operational Concerns 3

 Aerodynamics 3

 Modifications to Low-Speed Aerodynamic Database 4

 Control Laws 4

 Control Surface Function Allocation 5

 Propulsion 5

 Engine Failure Modification 5

 Landing Gear 6

 Terrain Contact Model 7

 Center of Gravity and Loading Envelope 7

Test Description 7

 Visual Scene and Head-Up Display 7

 Test Protocol 7

 Test Organization. 8

 Data Collection Procedures 8

Takeoff Tasks 8

 Introduction to Maneuvers for Takeoff Tasks. 8

 HUD Guidance and Pilot Performance Metrics 9

 Determination of Takeoff Speeds 10

 Noise Requirements 11

 Results of Takeoff Maneuvers 12

 Acoustic Profile Takeoff (Task 2010) 12

 Acoustic Programmed Lapse Rate Takeoff (Task 2030). 13

 Rejected Takeoff Maneuvers With 0-, 15-, and 35-Knot Crosswinds (Tasks 1050, 1051, and 1052) 14

 One-Engine-Out Takeoff (Task 7035). 15

 Minimum Control Speed on Ground (Task 7030). 17

Approach and Landing Tasks 17

 Approach and Landing Task Definition 17

 Head-Up Display for Landing Tasks 18

 Summary of Handling Qualities Ratings for Approach and Landing Tasks. 19

Nominal Configuration 19

 Nominal Approach and Landing (Task 4020) 19

 Nominal Approach and Landing With Flight Director (Task 4025) 19

Precision Landing (Task 4050)	20
Use of Automatic Flap Reconfiguration During Final Segment of Landing Tasks	20
Landing From Lateral Offset With Moderate Turbulence (Task 4062)	20
Landing From Lateral Offset in Category I, Visibility Conditions With Moderate Turbulence (Task 4066)	21
Landing From Vertical Offset With Moderate Turbulence (Task 4072)	22
Landing From Vertical Offset in Category I Visibility Conditions With Moderate Turbulence (Task 4076)	22
Go-Around (Task 4080)	22
Go-Around With Minimum Altitude Loss (Task 4085)	22
Approach and Landing With 15-Knot Crosswind (Task 4090)	23
Approach and Landing With 35-Knot Crosswind (Task 4095)	23
Landing in Category IIIa Visibility Conditions (Task 4100)	24
Failure Configurations	24
Approach and Landing With Jammed Control (Task 4110)	24
Dynamic V_{mc1-2} (Task 7050)	24
Manual Throttle Landing (Task 7095)	24
Batch Assessment of Ref-H Backside Characteristics	25
Unaugmented Landing With Longitudinal SCAS Inoperative (Task 7110)	25
Unaugmented Landing (Task 7100)	26
All-Engines-Out Landing (Task 7090)	26
Up-and-Away Tasks	26
Velocity-Altitude Display	26
Recovery From Limit Flight Envelope Tasks	26
Recovery Initiation Criterion	27
Determination of Maximum Angle of Attack	27
Batch Simulation Analysis of Longitudinal Nose-Down Control Authority	27
Batch Simulation Analysis of High-Angle-of-Attack Lateral-Directional Stability and Control	28
Results for Stall Maneuvers	29
Demonstration of Nose-Down Control Authority and Evaluation of Required Pitch Acceleration Criterion	29
Cooper-Harper Ratings for Nonturning Stall Maneuvers	30
Cooper-Harper Ratings for Turning Stall Maneuvers	31
Engine-Out Stall (Task 7070)	31
Engine-Out Turning Stall (Task 7080)	31
Diving Pullout (Task 5060)	31
Operations After Failure and Upset Recovery	32
Ripple Unstart (Task 7060)	32
Inadvertent Speed Increase (Task 6050)	33
Two-Axis Upset (Task 6060)	33
Directional Control With One Engine Inoperative (Task 7010)	34
Lateral Control With One Engine Inoperative (Task 7020)	34
Minimum Control Speed in Air (Task 7040)	34
Center-of-Gravity Shift at High Speed (Task 6040)	34

Trajectory Management	35
Profile Climb (Task 3030)	35
Emergency Descent (Task 5070).....	36
Profile Descent (Task 3050)	36
Climb, Cruise, and Descent.....	37
Transition to Level Flight (Task 3020)	37
Transition to Supersonic Cruise (Task 3022)	37
Level Flight Transition to Climb (Task 3040).....	37
Transition to Supersonic Descent (Task 3060)	37
Transition to Transonic Descent (Task 3062)	37
Airspeed Change in Subsonic Climb (Task 3070).....	37
Transonic Deceleration (Task 3074)	37
Airspeed Change in Low Altitude Cruise (Task 3076)	37
Heading Change in Transonic Climb (Task 3080)	38
Heading Change in Supersonic Cruise (Task 3084)	38
Heading Change in Low-Altitude Cruise (Task 3086)	38
Heading Change in Terminal Control Area (TCA) Descent (Task 3088).....	38
Miscellaneous Task.....	38
Configuration Change in Straight Flight With Moderate Turbulence (Task 4012).....	38
Quantitative Metric.....	38
Summary of Results	39
Takeoff Tasks	39
Approach and Landing Tasks	40
Up-and-Away Tasks	41
Determination of Airspeeds	42
Noted Deficiencies	42
Conclusions	43
Takeoff Tasks	43
Approach and Landing Tasks	43
Up-and-Away Tasks	44
References	45
Appendix A—Description of Control Laws Used in Piloted Reference-H Assessment	252
Appendix B—Simulator Facility Description	272
Appendix C—Pilot Biographies and Comments	282
Appendix D—Flight Cards.....	378
Appendix E—Guidance Algorithms	440
Appendix F—Algorithm for Calculation of Cabin Pressure Altitude for Emergency Descent Maneuver.....	453
Appendix G—Quantitative Summary Metric	456
Appendix H—Lessons Learned From This Study.....	458
Appendix I—Head-Up Display Symbolology	460

Symbols and Abbreviations

AEO	all engines operating
ANOPP	NASA Aircraft Noise Prediction Program
ARI	aileron-to-rudder interconnect
Avg	average
app	approach
C_L	lift coefficient
C_{l_β}	body axis lateral stability derivative
$C_{l_{\delta_a}}$	rolling moment due to aileron deflection
C_{n_β}	body axis directional stability derivative
$\left(C_{n_\beta}\right)_{\text{dyn}}$	dynamic directional stability, $C_{n_\beta} \cos \alpha - \frac{I_{zz}}{I_{xx}} C_{l_\beta} \sin \alpha$
$C_{n_{\delta_a}}$	yawing moment due to aileron deflection
CGI	computer-generated image
CHR	Cooper-Harper rating
CHR_{def}	Cooper-Harper rating deficiency
CHR_{max}	maximum Cooper-Harper rating assigned to given task
CHR_{req}	target Cooper-Harper maximum rating for given task
CLN	centerline noise, EPNdB
Cat	landing weather category
\bar{c}	mean aerodynamic chord
cg, CG	center of gravity
$d\gamma/dV$	change in trim flight-path angle with airspeed
ELEV1	left elevator segment
ELEV2	right elevator segment
EPNdB	effective perceived noise level in decibels
FAA	Federal Aviation Administration

FAR	federal aviation regulations
GS	ground speed, knots
GW	gross weight, lb
g, G	acceleration due to gravity, 32.2 ft/sec ²
HQ	handling qualities
HSCT	High-Speed Civil Transport
HSR	high-speed research
HUD	head-up display
h	altitude of center of gravity, ft
I_{xx}	aircraft moment of inertia about body X -axis, slug-ft ²
I_{xz}	product of inertia about X and Z body axes, slug-ft ²
I_{yy}	aircraft moment of inertia about body Y -axis, slug-ft ²
I_{zz}	aircraft moment of inertia about body Z -axis, slug-ft ²
IAS	indicated airspeed, knots
ID	identification
ILS	Instrument Landing System
inop	inoperative
KEAS	equivalent airspeed in knots
LaRC	Langley Research Center
LCDP	lateral control divergence parameter, $\left(C_{n_{\beta}} + \frac{I_{xz}}{I_{xx}} C_{l_{\beta}} \right) - \left(C_{l_{\beta}} + \frac{I_{xz}}{I_{zz}} C_{n_{\beta}} \right) \frac{C_{n_{\delta_{\alpha}}} + \frac{I_{xz}}{I_{xx}} C_{l_{\delta_{\alpha}}}}{C_{l_{\delta_{\alpha}}} + \frac{I_{xz}}{I_{zz}} C_{n_{\delta_{\alpha}}}}$
LE	leading edge
LEF	symmetric leading-edge flap deflection, positive down, deg
LEF1	left outboard leading-edge flap segment
LEF2	left inboard leading-edge flap segment

LEF3	right inboard leading-edge flap segment
LEF4	right outboard leading-edge flap segment
M	Mach
M_d	maximum dive Mach, 2.6
M_{mo}	maximum operating Mach, 2.4
MFC	final cruise mass case (GW = 384862 lb)
MFTF	mixed flow turbofan
MIC	initial cruise weight
M13	mass case 13 (GW = 649914 lb)
max	maximum
min	minimum
mod	moderate
N_v	normal acceleration used to define optimum flare
N_z	normal acceleration, ft/sec ²
NPRM	notice of proposed rule making
NR	not rated
n_{task}	number of different tasks included in study
OEO	one engine out
PIO	pilot-induced oscillation
PLR	programmed lapse rate
PNF	pilot not flying
p	body axis roll rate, positive right wing down, deg/sec
p/β	lateral-directional control law
QSAE	quasi-static aeroelastic
q	body axis pitch rate, positive nose up, deg/sec
q_{max}	maximum pitch rate, deg/sec

<i>R</i>	tire load factor
Ref-H	Reference-H configuration
RFLF	recovery from limit flight
RTO	rejected takeoff
RUD1	lower rudder segment
RUD2	middle rudder segment
RUD3	upper rudder segment
<i>r</i>	body axis yaw rate, positive nose right, deg/sec
SCAS	stability and control augmentation system
SDB	Structural Dynamics Branch at LaRC
SD1	left outboard spoiler-slot deflector
SD2	left inboard spoiler-slot deflector
SD3	right inboard spoiler-slot deflector
SD4	right outboard spoiler-slot deflector
S.L.	sea level
SLN	sideline noise, EPNdB
TCA	terminal control area
TE	trailing edge
TEF	symmetric trailing-edge flap deflection, positive down, deg
TEF1	left outboard trailing-edge flaperon
TEF2	left outboard trailing-edge flap
TEF3	left inboard trailing-edge flaperon
TEF5	right inboard flap
TEF6	right inboard trailing-edge flaperon
TEF7	right outboard trailing-edge flap
TEF8	right outboard trailing-edge flaperon

TOGA	takeoff go-around
turb	turbulence
V_{app}	approach speed, knots
V_c	commanded climb speed, knots
V_d	maximum diving speed, knots
$V_{(L/D)_{max}}$	velocity for maximum lift-drag ratio, knots
V_{lo}	liftoff speed, knots
V_{man}	maneuvering speed, knots
V_{mca}	minimum control speed in air with one engine out, knots
$V_{mcg}, VMCG$	minimum control speed on ground with one engine out, knots
$V_{mcl-2}, VMCL-2$	minimum control speed in landing configuration with two engines out, knots
$(V_{min})_{dem}$	minimum required demonstration speed, knots
V_{mo}	maximum operating speed, knots
V_{mu}	minimum unstick speed, knots
V_r	takeoff rotation speed, knots
V_{ref}	reference airspeed, knots
V_1	takeoff decision speed, knots
V_2	engine-out safety speed, knots
V_{35}	speed at obstacle height of 35 ft, knots
VF	vortex fence
VHD	velocity-altitude display
VMS	Langley Visual Motion Simulator
X, Y, Z	body axes (see fig. 2)
x, y, z	coordinates
x_{lo}	horizontal distance parallel to runway centerline from brake release to liftoff, ft
x_{obs}	horizontal distance parallel to runway centerline from brake release to specified obstruction clearance altitude, ft

x_{TD}	touchdown location along runway X -axis
y_{TD}	touchdown location along runway Y -axis
α	angle of attack, deg
β	sideslip angle, positive nose left, deg
γ	flight-path angle, deg
$\dot{\gamma}/V$	longitudinal control law
δ_e	elevator deflection, positive trailing edge down, deg
δ_h	horizontal tail deflection, positive trailing edge down, deg
θ	pitch attitude
σ	standard deviation
30×60	Langley 30- by 60-Foot Tunnel

Summary

An assessment of a proposed configuration of a High-Speed Civil Transport (HSCT) was conducted in the fall of 1995 at the Langley Research Center. This configuration, known as the Industry Reference-H (Ref-H) configuration, was designed by the Boeing Commercial Airplane Group as part of their work in the High-Speed Research Program. The configuration includes a conventional tail, a cranked-arrow wing, four mixed-flow turbofan engines, and capacity for approximately 300 passengers. This aircraft was 311 ft long with a 130-ft wingspan and a maximum takeoff gross weight of 649 914 lb. The assessment was to evaluate and quantify operational aspects of the configuration from a pilot's perspective, with the primary goal to identify potential deficiencies. Results from this study may be applied to enhance future HSCT configurations.

This assessment was aimed at evaluating the Ref-H configuration at many points of the aircraft envelope to determine the suitability of the vehicle to accomplish tasks along typical mission profiles as well as in emergency or envelope-limit conditions. Pilot-provided Cooper-Harper ratings and comments constituted the primary vehicle evaluation metric. Incidents of nacelle, tail, or wingtip ground strikes during takeoff and landing; repeated occurrence of control saturation or rate limiting during a particular task; or unfavorable propulsive influences on the flight characteristics of the vehicle were of particular interest. The assessment was performed by using the Langley Visual Motion Simulator and incorporated the release of the simulation database known as Ref-H Cycle 2B.

The model of the control system was based on industry-provided control laws for the longitudinal and lateral directional axes as well as control surface allocation and mixing logic. The simulation model used in the Ref-H assessment test used control systems that featured flight-path rate command, flight-path hold, and airspeed hold in the longitudinal control laws and a roll rate command, sideslip command, and bank angle hold in the lateral-directional control laws. The control surface models used in the assessment

included the effect of hinge moments upon actuator rate and position authority.

During the evaluation, several deficiencies in the vehicle configuration were uncovered in addition to control law deficiencies. Vehicle deficiencies include limited roll and yaw control power; this leads to a tendency for pilot-induced oscillations during lateral maneuvering and susceptibility of the modeled engine inlets to unstart during typical certification maneuvers. An inlet unstart occurs when a disturbance to the flight condition causes the normal shock wave, usually contained inside the inlet throat, to be ejected from the inlet to form an exterior shock wave. This shock wave leads to large reaction forces on the airframe because of a sudden loss of mass flow through the engine and a corresponding loss of thrust, a rise in drag, and changes in the underwing pressure distribution. Control law deficiencies included a coupling between thrust changes and pitch acceleration, a tendency for vertical flight-path excursions ("ballooning") during landing flap extension, high-angle-of-attack recovery problems, and minor lateral-directional control tuning requirements.

Tasks that were especially difficult and may present opportunities for further study include the 35-knot crosswind landing and recovery from turning stalls. An inability to meet emergency descent cabin pressure altitude guidelines was demonstrated. The difficulty in landing the aircraft without substantial control augmentation was also demonstrated, and the degradation of flying qualities associated with an auto-throttle failure was documented.

Other results of the assessment included a demonstration of a decrease in runway environment noise if a programmed lapse rate takeoff maneuver is employed in which throttles and flaps are automatically reconfigured by a control mechanism and the demonstration of a flight-path, flight-envelope display. Several dynamic minimum engine-out airspeed limits were demonstrated as well. Several simulation hardware and software deficiencies were uncovered during the course of the assessment.

Introduction

An assessment of a proposed configuration of a High-Speed Civil Transport (HSCT) was conducted in the fall of 1995 at the Langley Research Center (LaRC). This configuration, known as the Industry Reference-H (Ref-H) configuration, includes a conventional tail, a cranked-arrow wing, four mixed-flow turbofan engines, and capacity for approximately 300 passengers. This aircraft was 311 ft long with a 130-ft wingspan and a maximum takeoff gross weight of 694 914 lb. See reference 1 for a comprehensive description of the Ref-H configuration. The purpose of the assessment was to evaluate and quantify operational aspects of the configuration from a pilot's perspective with the primary goal to identify potential configuration deficiencies rather than to critique a particular control, display, or guidance concept.

This study was aimed at evaluating the Ref-H configuration at many points of the aircraft envelope to determine the suitability of the vehicle to accomplish typical mission profile tasks as well as emergency or envelope-limit tasks. The assessment maneuver set was performed by five pilots who evaluated 52 different tasks. The maneuvers chosen for piloted evaluation included demanding maneuvers, such as emergency descents, engine failure scenarios and stalls, as well as routine maneuvers such as takeoffs, climbs, turns, descents, and approaches and landings. Pilot-provided Cooper-Harper ratings (CHRs) and comments constituted the primary vehicle evaluation metric. Five additional demonstration maneuvers included in the assessment task list required only pilot comments. A limited batch analysis of the Ref-H configuration was also conducted to provide complementary information to support piloted real-time simulation work.

Although the flight dynamics of the simulated vehicle were inextricably linked with aspects of the control system, the evaluation pilots were urged, to the best of their ability, to look beyond the immaturity of the flight control laws and to identify deficiencies associated with the vehicle aerodynamics, control surfaces, and landing gear configuration. For this reason, incidents of nacelle, tail, or wingtip ground strikes during takeoff and landing; repeated occurrence of control saturation or rate limiting during a particular task; or unfavorable propulsive influences on the flight

characteristics of the vehicle were of primary interest. An assessment of takeoff noise characteristics of the Ref-H configuration was also conducted.

The assessment was performed by using the third major release of the simulation database (known as Ref-H Cycle 2B). This simulation model included detailed models of the Ref-H aerodynamics, mass and inertia, landing gear, control system elements, and propulsion systems. The aerodynamics model included the steady-state effects of airframe bending under flight loads (quasi-static aeroelastic effects). The propulsion model featured an engine inlet model that included inlet unstart calculations as well as engine response dynamics due to throttle and inlet start/unstart transients.

The model of the control system was based on industry-provided control laws for the longitudinal and lateral directional axes, as well as control surface allocation and mixing logic. The simulation model for the Ref-H assessment test used control systems that featured flight-path-rate command/flight path and air-speed hold ($\dot{\gamma}/V$) in the longitudinal axis, and a roll-rate/sideslip command and bank angle hold law in the lateral directional axes (p/β). The control surface models used in the assessment include the effect of hinge moments on actuator rate and position authority.

A qualitative rating metric was formulated that attempted to provide a consistent measure of preparedness, based on pilot ratings of the current simulation, as compared with what would be expected from a transport aircraft with acceptable flying qualities. The calculation of the CHR deficiency yielded a metric value of 23.0 percent for this assessment; 100 percent represented adequate flying qualities for all tasks evaluated and 5 percent represented an abysmal evaluation. To facilitate a better understanding of this metric the following examples are offered:

1. If all tasks were rated 3 CHR points (equivalent to a full CHR level) too poor, then the metrical score would be 5.0 percent. This instance would be an example of all tasks that required Level I flying qualities but received Level II or III marks during the evaluation.
2. If all tasks were evaluated to be 1 CHR point too poor, the metrical score would be 36.8 percent. This instance would be an example of tasks that

required Level I flying qualities but received CHRs of 4.5 (Level II).

3. If *half* the tasks were determined to be 1 CHR point too poor, the metrical score would be 60.7 percent. This instance would be half the tasks required Level I flying qualities but received CHRs of 4.5.

Simulated Aircraft Model

Cycle 2B Model Origins

This Ref-H assessment was based on the Cycle 2B version of the aircraft mathematical model. This model was documented by the Boeing Commercial Airplane Group in July 1995 as the third release in a series of increasingly detailed mathematical models of the Ref-H design in reference 2. Cycle 2B included models for aerodynamics, inertia, engines, landing gear, and flight control surface actuation systems. These models included quasi-static elastic flexible aerodynamic effects, actuator hinge moments, and an engine inlet model that modeled the supersonic inlet unstart phenomenon.

The aerodynamic model was based on a combination of wind tunnel and computational fluid dynamics studies of the Ref-H design; these ranged from low subsonic to Mach 2.4 supersonic wind tunnel studies. In addition, finite-element structural models were evaluated for strength, rigidity, and flutter dynamic predictions; information from these computations was used to predict the effect of steady flight loads upon aerodynamic stability derivatives.

General Vehicle Specifications

The design vehicle is approximately 311 ft long with a wingspan of approximately 130 ft with a maximum gross takeoff weight of 649 914 lb and a maximum zero fuel weight of 350 000 lb. The fuselage has a maximum diameter of approximately 12 ft and is intended to carry approximately 300 passengers in three seating classes.

Operational Concerns

The need to operate within the existing airspace system mandates that the HSCT mix with subsonic

traffic in the terminal environment and operate at subsonic speeds. These conditions require the design vehicle to fly most approaches on the “backside” of the drag curve, that is, in the flight regime where an increase in power is required to trim for a decrease in speed. This unconventional throttle activity could require extensive retraining of flight crews to successfully accomplish; however, this undesirable backside characteristic can be alleviated by using a fairly high bandwidth autothrottle system. During these tests, landings were performed with and without autothrottles. In addition, a “deadstick” landing with all engines out was performed; this approach was flown at a higher airspeed on the “frontside” of the drag curve.

Noise concerns have led to the examination and design of automatic flap deployment schedules on takeoff and landing maneuvers. Also, a programmed lapse rate (PLR) takeoff procedure was devised to schedule the autothrottle system during takeoff. These aspects of the Ref-H design were explored in these tests.

A fuel-optimal climb profile that included loft and pushover maneuvers was designed to provide maximum range. This profile was examined during this assessment for operational feasibility.

An operational HSCT will probably include some type of electronic vision system to avoid having to use a mechanical nose-droop system for takeoffs and landings, and flight-envelope protection (e.g., angle of attack and acceleration limits) will also probably be built into the flight control system. Neither of these systems were examined in this assessment, however. The geometry of the Ref-H configuration was modeled in the simulation so that an accurate assessment of tail strike, nacelle strike, and wingtip strike could be made during takeoff and landing operations.

Aerodynamics

The Ref-H configuration design has a cranked-arrow planform, a conventional aft tail, and four underslung engines. A three-view drawing and a three-quarter rear view are presented in figure 1. The control devices include a software-gearred horizontal stabilizer and elevator, a three-segment rudder on a fixed vertical fin, eight wing trailing-edge flaps/flaperons, four leading-edge flaps, a “vortex fence” device, and four “spoiler-slot deflectors.”

Modifications to Low-Speed Aerodynamic Database

This section provides details of modifications to the Cycle 2B aerodynamic database. The unmodified aerodynamic database, as documented in reference 2, was modified just prior to commencement of the piloted evaluations supporting this assessment. All simulated research flights were performed with these aerodynamic modifications installed.

As a result of performing initial batch analysis using the Ref-H Cycle 2B aerodynamic database, a significant discrepancy between existing data obtained in the Langley 30- by 60-Foot Tunnel (test 71) and the Ref-H Cycle 2B aerodynamic database was found. This discrepancy involved the low-speed lateral-directional stability derivatives, C_{l_β} and C_{n_β} , as modeled in the Ref-H Cycle 2B release.

The data used for the evaluation of the Cycle 2B database were obtained from test 71, which used a 4.6-percent sting-mounted Ref-H model tested at a Reynolds number of approximately 1.94×10^6 . Sting effects were quantified through the use of a “dummy” sting, used during the error analysis portion of the wind tunnel experiment, to specifically determine the exact effect the sting mounting system would have on the resulting data. Wind tunnel blockage and wall effects were considered to be of no significant magnitude due to the large test section of the tunnel compared with the size of the model. As a result of the sting error analysis and lack of wall effects, the data from test 71 are believed to be of high quality.

Accurate modeling of C_{l_β} and C_{n_β} is essential to obtain accurate handling qualities (HQ) ratings from a piloted simulation. Figures 2 and 3 present C_{l_β} and C_{n_β} as a function of angle of attack for data from test 71, Cycle 2B, and Cycle 2B modified databases. From these figures the differences between the test 71 data and unmodified Cycle 2B data are apparent. The lack of agreement in C_{l_β} was caused through improper modeling of the effects of leading-edge flap deflection. Unmodified Cycle 2B aerodynamics did not include the effect of leading-edge flap deflection on the lateral-directional stability derivatives. Also evident in figures 2 and 3 is a general lack of agreement

involving C_{n_β} at angles of attack greater than 10° .

Because a large portion of this assessment involved maneuvers with the leading-edge flaps deflected combined with the vehicle frequently maneuvering at high angles of attack, an effort was made to resolve these problems to improve the quality of this assessment. This information was used to develop the modifications to the Cycle 2B aerodynamic database. The resulting modification was subsequently installed, evaluated, and verified in the Ref-H simulation.

A distinct improvement in the agreement between the test 71 data and modified Cycle 2B data is apparent in figures 2 and 3. The aerodynamic modification of the Cycle 2B data produced values of both C_{l_β} and C_{n_β} that were much closer to values predicted from the test 71. The derivative C_{n_β} for zero flap deflection is very accurately reproduced by the Cycle 2B data, as shown in figure 2, although some differences were still evident for C_{l_β} . These data are presented to provide information regarding the basic airframe characteristics since none of the assessment maneuvers involved subsonic operation with leading- and trailing-edge flaps undeflected. The flap-deflected case, as shown in figure 3, is representative of the takeoff powered approach flight condition, which is the vehicle configuration for all takeoff, stall, and landing maneuvers. Accurate modeling of the aerodynamic properties is a high priority. As can be seen in figure 3, the unmodified data would have been unacceptable, with values of C_{l_β} off by a factor of 3 at angles of attack around 10° . Although substantial differences still exist for C_{n_β} , the aerodynamic modification improved the aerodynamic simulation and good agreement exists at a larger range of angle of attack.

Overall, the selection of the modified Cycle 2B aerodynamic database greatly enhanced the value of this study.

Control Laws

The simulation model used in this assessment employed custom-designed control laws that featured flight-path-rate command/flight path and airspeed

hold ($\dot{\gamma}/V$) in the longitudinal axis, and a roll-rate/sideslip command and bank angle hold law in the lateral directional axes (p/β). These control laws were developed by the Boeing Commercial Airplane Group and McDonnell Douglas Aircraft Corporation, respectively, and were implemented in the Langley simulation model. These control laws were designed to provide (1) stabilization and control authority over several flight regimes and (2) rudimentary autoflap-autothrottle capability sufficient to perform the various tasks in these tests. Because these control laws did not necessarily reflect the final control law selected for a potential production HSCT aircraft, the pilots were reminded that evaluation of these control laws was not the main focus of the assessment. The control laws used in the piloted assessment are described in appendix A and also in references 3 through 5.

Control Surface Function Allocation

The method of utilizing the available control surfaces for various flight control functions is described in detail in appendix A. The four leading-edge flaps were deployed symmetrically as camber-changing devices; of the eight trailing-edge flaps, half were used as symmetric flaps and half as flaperons to provide both roll and camber-changing effects. The outboard trailing-edge flaps were set to a deflection of 0° at higher speeds to prevent roll reversal. The elevator and stabilizer segments were used as pitch control devices, and commands to the elevator and stabilizer were geared 2:1. The rudder was separated into three segments, with the upper segment set to a deflection of 0° at higher speeds to prevent flutter in an actual aircraft. (Following this assessment, an error was found in this implementation: the lower rudder segment instead of the upper segment was locked out at higher speeds. This error is thought to have insignificant effects on the results presented, however.)

Propulsion

The Ref-H design included two mixed flow turbofan engines under each wing that would be capable of producing approximately 53 200 lb of thrust at a mass flow rate of 780 lb/sec each at sea level static conditions. Each engine was equipped with a downstream mixer nozzle with a 50-percent aspiration ratio. The axisymmetric inlet included a translating center-body

spike to adjust the location of the shock wave at cruising speeds.

An important part of this propulsion model was the engine inlet model. During supersonic flight, shock waves ahead of the inlet lower the Mach of the flow as it approaches the inlet. For free-stream Mach below 1.5, the shock structure ahead of the inlet keeps the flow entering the inlet subsonic. During flight above Mach 1.5, the mixed compression inlet admits supersonic flow to the inlet, which is further decelerated by a system of shocks that terminate with a normal shock at the inlet throat. If this normal shock wave is ejected from the inlet due to a disturbance either upstream or downstream of the inlet, the mass flow through the inlet (now completely subsonic) is greatly reduced and the inlet is unstarted. An engine with an unstarted inlet suffers a dramatic reduction in thrust; this causes large reaction forces and moments on the aircraft.

The engine model included in this simulation allowed for varying levels of detail on engine and inlet operations. At the highest complexity level (engine complexity level 5), the engine inlet model reacted to flight conditions that could cause an inlet unstart. In general, the inlet model was sensitive to changes in free-stream sideslip angle or angle of attack that might cause the outboard engine inlets to unstart at cruise conditions. The assessment explored the impact of this sensitivity; one task was designed to simulate a “ripple” unstart effect in which an inboard engine failure causes the neighboring outboard engine to unstart. Several engine failures in subsonic flight were also evaluated.

The outboard engines were located 31.2 ft from the centerline of the aircraft and were canted inward 2.4° and downward 3.25° relative to the centerline. The inboard engines were located 17.4 ft from the centerline and were canted inward 1.0° and downward 5.7° .

Engine Failure Modification

One minor error in the engine simulation section of the Cycle 2B data was identified during *engine-out* batch analysis. This error involved the amount of thrust generated by the failed engine, where a relatively small amount of positive thrust was observed for the failed engine. An investigation into

this anomaly revealed that the failed engine thrust results were based on data that assumed the engine was operating in a normal manner at the mass flow rate of the failed engine. Because thrust was a function of mass flow rate and other parameters and there was still substantial mass flow rate existing for a failed engine, a resulting positive thrust was generated.

A simplistic engine failure model was developed and incorporated into the simulation to produce more realistic amounts of thrust in the event of an engine failure. Table 1 gives the engine thrust for a given Mach and altitude. These values of thrust were similar to the values of ram drag for flight-idle thrust levels specified in reference 2. At the point that an engine failure was initiated, the thrust from the failed engine would blend linearly to the thrust in table 1.

Landing Gear

The landing gear modeled in the Cycle 2B simulation consisted of a nose gear and three sets of main gears located at fuselage station 2220.2 and arranged in left, center, and right sets of tires abreast of each other. The main gears were located approximately 156 ft behind the cockpit and had a 17.7-ft stance. The nose gear was located approximately 55 ft behind the cockpit. Maximum turning angle of the nose gear was $\pm 15^\circ$.

In response to new pitch/roll clearance information received subsequent to the release of the Cycle 2B model, the landing gear stance was determined too narrow and strut lengths incorrect. To better match this new information, the simulated locations of the right and left main gear struts were moved outward from ± 106 in. to ± 130 in. on either side of the vehicle centerline (Y -axis). The value of 106 in. used in Cycles 1 and 2B reflects the center of the strut itself, whereas 130 in. corresponds to the center of the outboard tires. The waterline (Z -axis) of the fully extended main gear was moved from 10.0 in. to 19.6 in. to make the main gear 9.6 in. shorter. The waterline of the fully extended nose gear was moved upwards from 15.0 in. to 23.0 in. to make it 8 in. shorter. Strut travel remained unchanged at 24 in. for both. This modified geometry more accurately reflected aircraft behavior when touching down with a nonzero bank angle.

The original Cycle 2B landing gear provided nose wheel brakes. This configuration was believed to be unrealistic; therefore, the brakes for the nose gear were disabled. Brakes remained enabled on all three main gears.

As a result of some initial testing and evaluation of the Ref-H simulation during crosswind ground handling maneuvers, the amount of skid angle needed to track the runway centerline became an issue. Pilot comments indicated that the large amount of skid angle (as much as 6° in a 35-knot crosswind with aircraft speeds above 100 knots) was unrealistic. This unrealistic artifact could cause problems maintaining the aircraft within the runway bounds during crosswind evaluations. A modification to the cornering-force model, obtained from the Structural Dynamics Branch (SDB) at LaRC, was based on extensive work performed on the model of the Space Shuttle main gear tire. This model included data from a candidate $50 \times 2 - 20$ HSCT tire tested at the Langley Aircraft Landing Dynamics Facility.

The SDB cornering-force model differed significantly from the model contained in the Ref-H Cycles 1, 2A, and 2B models. The Ref-H Cycle 2B model employed a tire side-force coefficient that was a function of aircraft speed and cornering angle, but the SDB model used a tire side-force coefficient that was a function of normal load and cornering angle. Basically the SDB model was speed insensitive, and the Ref-H Cycle 2B model was speed sensitive. Also, the Ref-H Cycle 2B model assumed that the total side force generated by the tire was linear in normal load at a given speed, whereas the SDB model provided a variable side-force coefficient based on normal force.

Data for the two models are given in figure 4 where side-force coefficient is plotted against tire skid angle for various combinations of speed and tire load. For the Ref-H configured for the maximum takeoff gross weight ($GW = 649914$ lb), a nominal tire load factor R per tire is approximately 0.7 for the main centerline gear and 0.5 for the outboard main gears. Nominal load factor is the actual load on the tire divided by the rated load of the tire, which is 57000 lb. As can be seen from figure 4, similar results were obtained from the two different models at speeds below 50 knots. This agreement rapidly deteriorates as speed increases. Typical tire skid angles encountered during this

assessment were about 2° for the 35-knot aborted take-off maneuver. From figure 4 for a condition requiring a skid angle of 2° for the SDB model at 150 knots and the maximum tire load factors for takeoff weight mass case (M13), the Ref-H Cycle 2B model would have required a skid angle of approximately 5.0° . Based on comments from the LaRC project pilot, the rate limit for the nose-gear steering actuator was increased from 45 deg/sec to 60 deg/sec.

Terrain Contact Model

Tests were added to check for terrain contact with the following aircraft points: outboard engine nacelles, wingtips, and tail skid. A simulation run would be terminated if any of these fuselage points contacted the ground. The coordinates for these points were taken from an unpublished Boeing document and are given in table 2.

Center of Gravity and Loading Envelope

The Ref-H design had an operating empty weight of 279 080 lb and a maximum taxi weight of 650 000 lb. Final cruise weight was modeled as 384 862 lb and maximum takeoff weight was 649 914 lb, which corresponded to a wing loading of 54.2 and 91.5 lb/ft² for landing and takeoff, respectively. The center-of-gravity (cg) design envelope varied from as far forward as 48.1 percent to as far aft as 56.6 percent mean aerodynamic chord (\bar{c}) and was a function of aircraft weight for all tasks except the cg shift task 6040. Various tasks were flown at these extremes, as well as intermediate values of weight and cg appropriate for the task. All mass cases used in this study for simulation initial condition definition are given in table 3.

Test Description

Visual Scene and Head-Up Display

A computer-generated imagery (CGI) system representing runway 26L at the Denver International Airport provided the out-the-window scene on monitors to the pilot's front and left side windows via a mirror-beam-splitter arrangement. Boxes representing the desired and adequate touchdown performance bounds for the landing task were included on the CGI image.

The head-up display (HUD) symbology was also mixed with the CGI image on the front window. Additional information concerning the test facility and equipment is given in appendix B.

Test Protocol

Five test pilots participated in the assessment. A package describing the experiment setup with flight cards that defined each evaluation task was supplied to the pilots prior to their participation. Biographies summarizing the pilots' backgrounds are presented in appendix C along with transcriptions of comments the pilots made while they were rating the various assessment tasks.

Each pilot flew the simulation in sessions lasting no more than 2 hr and was accompanied by an investigator who conducted the test session, recorded pilot ratings and comments, and performed duties of the pilot not flying (PNF). Each pilot was limited to no more than two sessions per day, with at least a 2-hr break between sessions. No more than 10 sessions were flown by any pilot.

A briefing was held prior to each of the major blocks of tasks (see section "Test Organization") that described the major aim of that block, the procedures to follow, and the function and arrangement of displays unique to that block. Each task was specifically defined by a maneuver flight card which described the pilot procedures and the desired and adequate task performance criteria. Prior to evaluating each new task, the pilot studied the flight card for that task, and the investigator briefed him on the procedure for the task and answered any questions the pilot had. Appendix D presents copies of the flight cards that include maneuver segment definitions, initial conditions, and performance criteria for each of the tasks.

The simulation operator entered the task ID; this reset the simulation to specific initial conditions, weather conditions, cockpit display arrangement and format, and armed operators touch-panel triggers (if required) to fail or unstart engines or simulated fuel transfer pumps, et cetera, depending on the task.

After the run, one or more displays in the cockpit provided a series of numerical scores for various performance standards for each evaluation segment of the

particular task. The display included a classification of the numerical score for each standard as “desired,” “adequate,” or “inadequate,” according to the performance standards spelled out on each flight card. For example, the landing cards had two segments: approach (above 400 ft) and precision landing (below 400 ft). The scorecard display in the cockpit could be cycled between the two segments, and it listed the performance score values and categories for each segment. This information was visible to the pilot and was reviewed with the pilot by the investigator after each run.

During the course of maneuver evaluations, the pilot was allowed to perform the maneuver as many times as necessary to be able to provide CHRs and pilot comments that would thoroughly characterize the maneuver. No distinction was made between “practice” or “data” runs. Evaluating maneuvers in this fashion permitted any learning curve effect to be analyzed. The final run or runs could be considered data runs if desired because these were the runs the pilot used to develop his quantitative score. During the runs, pertinent comments by the pilot were written on the flight card by the investigator.

When the pilot was satisfied that no improvement could be made in his performance of the task, he was asked to provide a numerical rating using the CHR scale (fig. 5) and justification for the rating. Usually there were several ratings, depending on the number of evaluation segments in the task, and separate ratings were obtained for the longitudinal axis and the lateral directional axes. The verbal justifications and ratings were recorded on a microcassette recorder. These comments were transcribed and are found in appendix C.

Test Organization

The test was organized into eight blocks, which roughly translated into 5 days (10 sessions) of simulator sessions for each pilot. Table 4 shows the organization of the tasks performed in this test.

Data Collection Procedures

The following types of data were collected for each task:

1. An electronic run log was maintained to track pilot, task, run number, date, time, and pilot ratings.
2. A videocassette recorded the combined forward field-of-view CGI and HUD symbology. In addition, a video mix of the forward image, a closeup of the pilot’s left hand on the sidestick, an over-the-shoulder image including the throttle quadrant, and the head-down primary flight display were recorded on videocassette. All video recordings included the hot mike audio from the cockpit. These recordings provided the ability to rapidly review maneuvers and produced valuable material for presentations.
3. The pilots used a hand-held microcassette recorder to dictate their comments and justification for each rating; this recorder was the primary pilot comment collection method. Recordings generated with this system were later transcribed into a text file. (See appendix C.) An audiotape cassette and videocassette recordings of the hot mike audio from the cockpit were used as the backup system to the hand-held microcassette.
4. Digital time history data of 238 simulation parameters, recorded at 20 Hz, were generated and stored on a mass storage system for all 803 runs. These data were used to determine quantitative results of pilot and aircraft performance. In addition to time history data, a summary log was automatically generated and stored for each data run. Summary log data files contained parameters such as initial conditions, run length, and the maximum, minimum, and root-mean-square value of selected parameters.

Takeoff Tasks

Introduction to Maneuvers for Takeoff Tasks

The takeoff assessment block of maneuvers evaluated a series of normal and emergency operational states. Two different noise abatement procedures were considered, as well as rejected takeoffs due to engine failure and a takeoff maneuver with one engine out (OEO). Additionally, a maneuver designed to determine the minimum control speed on the ground V_{mcg} was included. Execution of these maneuvers served to evaluate the Ref-H configuration in this portion of the low-speed operating envelope.

As previously stated, two different noise abatement takeoff procedures were used in this assessment. One procedure, referred to as “the acoustic profile takeoff procedure” (task 2010), is considered to be the procedure that an HSCT would use if it were in service today. The procedure adheres to all safety of flight and noise abatement regulations currently established for subsonic transports. The other procedure evaluated was referred to as “the acoustic programmed lapse rate takeoff procedure” (task 2030) and featured automatic management of thrust and symmetric leading- and trailing-edge flaps. Operation of the vehicle in this manner has been identified in references 6 through 9 as a way to drastically reduce jet noise suppression requirements.

The PLR procedure embodies several operations not permitted by current FAA regulations such as automatic thrust and symmetric changes in leading- and trailing-edge flaps below 400 ft, along with the ability to accelerate to and operate at 250 knots (approximately $V_2 + 49$ knots). Piloted simulation results to date indicate general acceptance by the pilots of the PLR procedure with no obvious safety of flight problems. One safety of flight aspect of the PLR procedure was that thrust levels were designed to satisfy second segment takeoff climb gradient requirements in the event of an engine failure during reduced thrust operation. The PLR procedure decreases the reliance of this class of vehicle on jet noise suppressors and was included in the tasks because it may be a viable noise abatement procedure at the time an HSCT vehicle enters service.

Engine failure emergency maneuvers included rejected takeoffs (RTOs), OEO continued takeoffs, and the V_{mcg} demonstration maneuver. All RTO maneuvers (tasks 1050 to 1052) simulated an engine failure just prior to reaching V_1 . A crosswind component was incorporated with the RTO maneuvers to determine whether the Ref-H configuration had enough control authority from combined nose-gear and rudder steering to handle this type of emergency maneuver. The takeoff maneuver with OEO (task 7035) simulated a takeoff with an engine failure occurring just after the aircraft had passed the decision speed V_1 . The last takeoff maneuver was the V_{mcg} demonstration maneuver, which was included to determine the minimum controllable speed on the ground with an engine failure. In this maneuver, no cornering

forces were assumed available from the nose gear. This maneuver is required to demonstrate that the aircraft is controllable with an engine failed during the rotation segment for the liftoff maneuver. To examine the worst possible scenario, the lightest takeoff weight, which was the final cruise mass case (MFC), was used for this maneuver. The V_{mcg} must occur below the specified rotation speed V_r for that aircraft weight. The first pilot to perform the test sequence evaluated a series of engine failure speeds until the pilot was just able to keep the aircraft deviation from the runway centerline within the desired limits. The desired performance was ± 30 -ft lateral distance from the runway centerline. Once V_{mcg} was determined, all the other pilots were asked to evaluate the maneuver at only that engine failure speed. See table 4 for a complete listing of the takeoff tasks.

Pilot ratings were obtained for all takeoff maneuvers except the V_{mcg} (task 7030), which was a demonstration maneuver. Takeoff maneuvers were broken into segments to provide a more accurate and detailed pilot assessment of the maneuvers. Definitions of the takeoff maneuver segments are contained in the flight cards in appendix D.

HUD Guidance and Pilot Performance Metrics

Various HUD elements were displayed to the pilot to facilitate the HQ ratings task. Rotation guidance included information regarding rotation rate and rotation acceleration, as well as target pitch attitude. Incorporation of this system was intended to standardize the rotation task and provide adherence to consistent, specified, performance parameters such as steady-state pitch rate and pitch accelerations. The desired rotation guidance profile began at rotation speed V_r , and used a pitch acceleration of 1.5 deg/sec^2 , a steady-state pitch rate of 3.0 deg/sec , and a deceleration of 2.5 deg/sec^2 . Desired bounds for pilot control are in the flight cards (appendix D). Definitions of the rotation guidance elements and performance bounds are shown in figure 6.

Velocity-vector guidance was provided for the airborne sections of the takeoff maneuvers. Once airborne, an automatic HUD reconfiguration occurred. The reconfiguration removed some elements visible during the rotation task, such as the tail scrape bar, target pitch attitude indicator, pitch rate error brackets,

and reduced the size of the pitch attitude reference marker. The automatic HUD reconfiguration also added a velocity-vector guidance marker. The velocity-vector guidance marker presented longitudinal and lateral guidance information to the pilot during the airborne phases of the takeoff maneuver. The pilots' task was to place the commanded velocity vector on top of the velocity-vector guidance symbol. The airborne takeoff HUD guidance elements and pilot performance bounds are shown in figure 7.

For the acoustic profile takeoff maneuver (task 2010), the velocity-vector guidance symbol provided information to accelerate to and maintain the desired climb speed V_c . The lower limit of travel was a 3-percent climb gradient, which came into play mostly during the OEO takeoff (task 7035). For the acoustic PLR takeoff (task 2030), the velocity-vector guidance indicator was constrained to remain on the 4-percent climb gradient, which simplified the longitudinal portion of the takeoff significantly. Lateral guidance was a combination of lateral distance from the runway centerline, track angle, bank angle, and roll rate. The lateral velocity-vector guidance symbol commanded the pilot to adjust the velocity vector to follow the extended runway centerline; this was the same for all takeoff maneuvers. Details regarding the generation of the velocity-vector guidance symbol motions can be found in appendix E.

Determination of Takeoff Speeds

As part of the development of the takeoff maneuver block, a series of analyses was conducted to determine the appropriate takeoff reference speeds. The aircraft was configured with all leading-edge flaps at 30° and all trailing-edge flaps at 10° with the maximum takeoff weight mass case (M13). It was determined that $V_1 = 166$ knots combined with $V_r = 174$ knots produced a balanced field length of 9389 ft. Figure 8 presents results for the OEO takeoff (task 7035) and the RTO maneuvers at 0-knot crosswind (task 1050) to illustrate the merit of the selection of V_1 and V_r . The data presented in figure 8 are for runs that produced results closest to the statistical mean for these maneuvers. Altitude and airspeed are presented as a function of distance from brake release. Engine failure location and cg obstacle height are also indicated in the figure. As can be seen, the distance required to accelerate to V_1 , experience an engine fail-

ure, and bring the aircraft to a stop was 8831 ft. The distance required to accelerate the aircraft to V_1 , experience an engine failure, and continue the takeoff to the obstacle height was 9389 ft. The difference between the total distance required for the RTO maneuver (task 1050) and the distance needed to climb to the obstacle height of the takeoff maneuver with OEO (task 7035) was approximately equal to that traveled at the V_1 decision speed for 2 sec; this is part of the FAA certification requirements.

Table 5 presents results of a statistical analysis of all takeoff maneuvers performed by the five research pilots. The mean and standard deviation of x_{lo} , V_{lo} , θ_{max} , x_{obs} , and V_{35} are presented and the number of samples are indicated for the acoustic profile, acoustic programmed lapse rate, and OEO takeoff maneuvers. Maximum pitch attitude was 11.61° for fully extended main landing gears and 10.22° for fully compressed main landing gears with zero bank angle. Minimum unstick speed V_{mu} was calculated to be 182 knots for fully extended main landing gear. FAA regulations require that lift-off speeds for all engines operating be $1.1 \times V_{mu} = 200$ knots and $1.05 \times V_{mu} = 191$ knots for the OEO case. From table 5, the requirements on minimum liftoff speed are close to being satisfied. An increase of V_r or decrease of target pitch rate or target pitch attitude may be required. It should also be noted that pilots would frequently need to arrest the rotation rate during the OEO takeoff maneuvers to capture the designated liftoff pitch attitude, which is different from conventional takeoffs that employ a smooth, continuous pitch rotation to capture climb attitudes. The speed V_2 is defined from the V_{35} of the OEO takeoff (task 7035) and is 201 knots. In table 5, the liftoff speeds for the OEO takeoff (task 7035) were lower than for the other two tasks. This difference results because the pilots were able to achieve a higher pitch attitude before liftoff because of the lower level of acceleration of the OEO takeoff task and shows that pilots often did not have sufficient time to rotate the aircraft to the pitch attitude of 10.5° for the normal operating maneuvers before becoming airborne. Note that the distance required to clear the 35-ft obstacle for task 7035 defines the takeoff field length of 9389 ft, which would permit this aircraft to operate from many major airports.

The FAA safety flight regulations require a four-engine aircraft to be able to maintain a 3-percent climb

gradient with an engine failed. To determine the application of this requirement to the Ref-H configuration, a static trim analysis was performed. Figure 9 presents the thrust required to maintain either a 3-percent climb gradient with one engine failed or a 4-percent climb gradient with all engines operating as a function of indicated airspeed. Data are presented for the acoustic PLR takeoff (task 2030), which used an automatic flap system. Data are also presented for the acoustic profile and OEO takeoffs (tasks 2010 and 7035), which used fixed leading- and trailing-edge flaps. This figure shows that the minimum speed at which the aircraft can maintain a 3-percent climb gradient with a failed engine is approximately 184 knots for automatic flaps and 182 knots for the fixed flaps. Because these speeds are below V_2 , as determined from the OEO takeoff evaluation, V_2 remained at 201 knots. Also shown in figure 9 is the first cutback thrust level of 75 percent for the acoustic PLR takeoff (task 2030). One requirement imposed on the acoustic PLR takeoff procedure (task 2030) was that the thrust level never be allowed to go below the OEO 3-percent climb gradient thrust until the altitude was greater than 400 ft. This requirement is an interpretation of the FAA safety of flight regulations pertaining to all aircraft and is applied here in an effort to demonstrate the relative flight safety of this maneuver. Also shown in figure 9 is the thrust required to maintain a 4-percent climb gradient with all engines operating (AEO) for both flap scenarios. One obvious detail shown in figure 9 is that the optimized automatic flap schedule requires more thrust than the flap setting of $LEF = 30^\circ$, $TEF = 10^\circ$. This situation is incorrect and needs to be resolved.

The data shown in figure 9 are required to determine the amount of thrust cutback for the acoustic profile takeoff procedure (task 2010) and also as a check of the thrust that should be automatically selected during the transition to the speed-hold segment of the acoustic PLR takeoff maneuver (task 2030). The cutback thrust level used for acoustic profile takeoff (task 2010) was based on the thrust required to maintain a 4-percent climb gradient plus a 3-percent increase in thrust to account for turbulence effects. For a climb speed V_c of 219 knots, the cutback thrust from figure 9 is 52 percent. As a result of incorrectly using the automatic flap deflections to determine the thrust required for the fixed flaps, the thrust level for task 2010 was 55 percent. The amount of error resulted in roughly a 4.5-percent secondary climb gradient instead of a

4.0-percent climb gradient. Another error discovered after the assessment had begun was that V_2 should have been the V_{35} for OEO takeoff (task 7035) instead of the V_{35} for AEO (task 2010). Using the correct V_2 would have produced $V_c = 201 + 10 = 211$ knots, which would have required approximately 55 percent thrust to maintain a 4-percent climb gradient. Figure 9 also illustrates the benefit of operating at a higher speed, as is shown by almost a 10-percent decrease in thrust required for flight at 250 knots as compared with flight at 219 knots. This level of thrust reduction significantly reduces the amount of source noise produced and offsets the increase in ground observer noise because of the lower trajectory.

Overall, the effect of using automatic flap trim data to determine the appropriate cutback thrust level for the acoustic profile takeoff (task 2010) tended to cancel the effect of the error in V_c in the noise calculations. Sideline noise levels are not significantly affected by thrust reductions performed at the altitude used for the acoustic profile takeoff (ref. 7). Centerline noise is also not expected to change significantly because the difference between the corrected acoustic profile takeoff procedure and what was actually flown would be a slightly shallower and slower post-cutback climb at approximately the same thrust setting. Because aircraft source noise largely depends on throttle setting and the change in trajectory would be small, centerline noise would not be expected to change significantly.

Noise Requirements

A portion of this assessment was to evaluate the ability of the aircraft to meet takeoff noise restrictions expected to be in place in the future. This evaluation was accomplished through the application of the Aircraft Noise Prediction Program (ANOPP) developed by LaRC (ref. 10). Trajectory data from the real-time piloted simulation were combined with the acoustic engine data that formed the input to ANOPP. ANOPP, in turn, can generate noise predictions for any user-specified microphone location. The source noise model used accounted for jet mixing noise only. No corrections, such as jet shielding, airframe reflective noise, were applied to the data. Although 15 dB of jet noise suppression was assumed in the thrust simulation model, noise results are presented for the unsuppressed mixed flow turbofan (MFTF) engine. The

figure of merit employed for the noise evaluation facet of this assessment was the jet noise suppression required to satisfy specified noise regulations. One takeoff noise metric was sideline noise (SLN), defined as the maximum level of noise (in effective perceived noise level in decibels (EPNdB)) along a line parallel to and displaced 1476 ft to the side of the runway centerline extending from the point adjacent to where the aircraft becomes airborne. The other takeoff noise metric was centerline noise (CLN), the noise at a fixed point along the extended runway centerline and located at 21325 ft from brake release and measured in EPNdB.

Currently, permissible levels of aircraft noise are dictated by Federal Aviation Regulations (FAR) Part 36, Stage 3 (ref. 11). The Environmental Impact Element of the High-Speed Research Program has provided a recommendation for noise certification based on the historical trend of increasingly restrictive noise regulations. The goal of the anticipated noise metric was to develop a rational estimation of the noise regulations that may be prevalent when an HSCT aircraft applies for certification in the future. The estimation uses the levels of noise generated by current modern subsonic transports, such as the Boeing 747-400, as a guideline. In fact, the anticipated noise requirement employs the noise generated by the Boeing 747-400 for CLN and approach noise to determine values for these two metrics.

The recommended noise requirement specifies a reduction of sideline noise by 1 EPNdB, of centerline noise by 5 EPNdB, and of approach noise by 1 EPNdB with respect to existing FAR Part 36, Stage 3 noise regulations. Figure 10 presents the layout of the noise measurement system. The permissible noise is a function of aircraft weight. Based on the maximum takeoff weight (M13, GW = 649 914 lb), takeoff noise levels for the anticipated noise requirement are CLN = 99.1 EPNdB and SLN = 100.7 EPNdB. The approach noise limit is 102.2 EPNdB, based on final cruise weight (MFC, GW = 384 862 lb).

Results of Takeoff Maneuvers

Acoustic Profile Takeoff (Task 2010)

The acoustic profile takeoff maneuver was designed to replicate, as closely as possible, current

noise abatement takeoff procedures. As such, the leading- and trailing-edge flaps remained in a fixed position and no engine thrust cutbacks were performed below 400 ft. Reference airspeeds were calculated based on Ref-H Cycle 1 and Cycle 2B data as previously outlined. A manual thrust cutback was performed at an altitude of 700 ft, where net thrust was reduced to 55 percent of maximum by the PNF. The rate of thrust reduction was adjusted so that the pilot was not required to command low g (i.e., $N_z < 0.7$) during the cutback pushover.

Generally task 2010 was not difficult to perform; however, some aspects of the maneuver were evaluated as less than desired. One aspect that received some negative comments was the pitch rotation guidance. Pilots were not accustomed to following guidance during the rotation phase of the takeoff maneuver. They also indicated that the system could be improved through changes in display format and logic to make it acceptable.

Overall, pilots frequently had difficulty staying within desired limits and even exceeded adequate bounds as shown in figure 11. Analysis of the data indicates that this difficulty was probably caused by a combination of control law and aircraft limitations. As shown in figure 11, almost full elevator deflection was used between 1 to 2 sec after rotation initialization; this indicates the aircraft was operating near its maximum capabilities, possibly causing some control response anomalies. The control law was not originally designed to support on-ground aircraft operations. It was modified to provide adequate functionality for this assessment project and should be reevaluated prior to any other applications of this control law. Additionally, the vortex fence, which was used to provide added nose-up pitching moment, was not functioning properly for the takeoff maneuvers of this assessment project.

Lift-off pitch attitude, defined as the maximum pitch attitude attained for landing gear altitudes less than 1 ft, was usually in the desired range and was less than $\pm 0.5^\circ$ from the specified target. Once airborne, pilots generally had little difficulty following the velocity-vector guidance that provided information to accelerate to and maintain the desired climb speed and also track the extended runway centerline. Problems were encountered, however, during the single manual

thrust cutback. One problem involved the rapid push-over that was required to follow the velocity-vector guidance to maintain constant airspeed. The backside nature of the Ref-H configuration at the climb speed exacerbated flight-path corrections required to maintain constant airspeed. During this maneuver segment, thrust was required to be reduced gradually so that the pilot did not cause a rapid pitchover while maintaining airspeed; this resulted in a normal acceleration excursion. Generally normal acceleration was kept above 0.7g, which should avoid any significant potential passenger discomfort problems. Another minor problem encountered was some velocity-vector guidance jumpiness because of turbulence even though the guidance law employed complementary-filtered airspeed.

Noise calculations were performed for all evaluations of the acoustic profile takeoff (task 2010). Generally, pilots were able to perform the maneuver reasonably well during the first attempt. Subsequent maneuver evaluations were only used to develop a familiarity with the maneuver, which enhanced the CHR and comments. As a result, all maneuver evaluations were used to produce takeoff noise results. Trajectory information from the piloted simulation runs was used as input to ANOPP, which produced estimates of the ground noise.

Figure 12 presents SLN plotted against CLN and illustrates the amount of noise suppression required to meet the anticipated noise restrictions. The shaded areas represent the amount of effective noise suppression required for the Ref-H configuration to satisfy the anticipated noise restriction and uses an optimistic estimate for approach noise. From figure 12, a large amount of noise suppression would be required to meet the anticipated noise regulations if the standard acoustic takeoff (task 2010) was flown. Also note that the noise suppression was being driven by SLN requirements not CLN requirements. The suppression required for task 2010 would be approximately 20 dB. Currently, the Cycle 2B database only assumes 15 dB and produces a situation where the aircraft would not be able to meet the anticipated noise requirement. Also the resulting noise was not significantly affected by which pilot was performing the maneuver as demonstrated by the standard deviation of approximately 0.25 EPNdB for both SLN and CLN. Mean values of SLN and CLN, to the nearest EPNdB, were 123 and 106, respectively.

Pilot ratings are given in figure 13 for the takeoff maneuvers. For the average acoustic profile takeoff maneuver (task 2010), the ratings were a mid to high Level I (i.e., CHR < 3.5) for all segments. The segment receiving the worst rating was the rotation segment for the longitudinal case, where three of the five pilots rated it 4, which reflected some difficulty performing the rotation for liftoff. Another segment that received some level II ratings was the climb segment for the longitudinal case, where two of the five pilots rated it 4 because of increased pilot workload during the thrust cutback portion of the maneuver.

Acoustic Programmed Lapse Rate Takeoff (Task 2030)

The acoustic PLR takeoff procedure (task 2030), incorporating automatic changes of leading- and trailing-edge flaps and thrust, greatly reduced the noise produced by the aircraft during takeoff. It was included as a result of the potentially significant reductions in noise suppression required and the possibility that a similar maneuver could potentially be employed for HSCT operations. The maneuver was designed to take advantage of possible changes in FAA regulations regarding automated systems and procedures that may be available to an HSCT aircraft when it enters service. Similar acoustic PLR takeoff procedures have been previously evaluated, using other HSCT piloted simulations, and have been initially determined to be a viable takeoff operation.

The significant features of the PLR procedure are

1. Automatic control of thrust and symmetric leading- and trailing-edge flaps
2. Low-altitude (<50 ft) initial thrust reduction, which maintains thrust above the 3-percent climb gradient level for OEO
3. Low initial climb gradient which produces an accelerating climb that reaches an advantageous aerodynamic performance speed ($V_c = V_2 + 49 = 250$ knots) prior to passing over the centerline microphone position
4. A secondary thrust cutback to maintain best aerodynamic performance speed prior to passing over the CLN microphone position

All these features of the PLR procedure will, of course, need to be accepted by the FAA before this procedure can be employed. However, indications to date are encouraging. No significant pilot concerns regarding the PLR procedure have been observed; most pilots actually preferred the PLR procedure over the acoustic profile takeoff procedure. Results from the two procedures are presented in figure 14, which shows thrust, leading- and trailing-edge flap deflections, altitude, and airspeed as a function of distance from brake release.

Guidance and tasks for the acoustic PLR takeoff maneuver (task 2030) were very similar to the acoustic profile takeoff maneuver (task 2010). One difference was the operation of the velocity-vector guidance symbol. Operation was constrained to the desired climb gradient, which for the acoustic PLR takeoff maneuver (task 2030) was always 4 percent, instead of providing airspeed guidance information. This constraint simplified the airborne longitudinal task by providing a constant desired climb angle. Another difference between the two takeoff maneuvers was that leading- and trailing-edge flaps were automatically adjusted in the acoustic PLR takeoff; this was an attempt to produce optimum aerodynamic performance. The automatic flap schedule was based on Mach and altitude.

Figures 12 and 15 show that a large amount of noise suppression will be required to meet the anticipated noise regulations if the acoustic profile takeoff (task 2010) is flown. One of the merits of the PLR procedure (task 2030) was its effectiveness in reducing SLN by using the low-altitude thrust cutback. Because a higher climb speed was used for the PLR procedure, a lower thrust was required to maintain a 4-percent climb gradient as shown in figure 14. The lower thrust resulted in a limited increase of CLN despite the much lower CLN microphone crossing altitude of the PLR procedure. From figure 15, the required jet noise suppression is still determined by SLN even though SLN was reduced approximately 8 EPNdB as a result of the PLR procedure.

Pilot ratings for task 2030 are given in figure 13. The acoustic PLR takeoff (task 2030) received identical ratings as the acoustic profile takeoff (task 2010) for the takeoff roll segment, which is expected because no differences between these maneuvers are encountered in this segment. One difference of pilot

ratings observed for the two takeoff maneuvers was the longitudinal portion of rotation segment. Pilots felt that the rotation segment was easier to perform as a result of not having to rapidly increase pitch attitude immediately after liftoff to follow the velocity-vector guidance to capture the climb speed. Although the rotation segment ended at liftoff, pilots tended to rate this segment of task 2030 better than the same segment of task 2010 as a result of increased workload immediately after liftoff. Future applications of this maneuver may extend the rotation evaluation segment to the obstacle height. Lateral ratings for the rotation segment were again identical for both takeoff maneuvers.

Longitudinal ratings for the climbout segment were slightly better for task 2030 (as shown in fig. 13) by two of the pilots giving a rating for 2030 of 3 instead of 4. Pilot comments frequently indicated maneuver 2030 was preferable to 2010 because no large pitch transients caused by large changes of commanded flight-path angle occurred and following a constant flight path was easy given the $\dot{\gamma}/V$ control law. Lateral CHRs for the climb segment were slightly worse for the PLR maneuver.

Pilot comments supporting the small increase in CHR rating for the PLR maneuver indicated that, because the longitudinal task was much easier for the PLR takeoff, the pilots were able to focus more attention on the lateral task and observed a slight tendency to S-turn across the runway centerline if the guidance was followed too closely. This tendency was a minor problem with the takeoff guidance law and should be improved. For the PLR task, no problems were identified regarding the automatic takeoff flap transition that was initiated at 35 ft. These automatic flap transitions are still a significant certification issue, however.

Rejected Takeoff Maneuvers With 0-, 15-, and 35-Knot Crosswinds (Tasks 1050, 1051, and 1052)

The RTO maneuvers were performed with an engine failure occurring at a speed that would require the pilot to abort the takeoff. The engine failure speed was specified to be slightly lower than the decision speed V_1 (166 knots). Pilots were aware however, at the beginning of the run, of the pending engine failure. In addition, the level of crosswind was varied to determine its effect on the combined pilot and aircraft

performance. The task of the pilots for the RTO maneuvers was to accelerate the aircraft to the engine failure point then apply maximum braking to bring the aircraft to a complete stop. Desired lateral performance was to keep the aircraft cg within ± 10 ft of the runway centerline with adequate performance being ± 27 ft. The only significant guidance available to the pilot was the velocity vector, which was used to track the runway centerline. Crosswinds used were 0, 15, and 35 knots perpendicular to the runway. The engine that failed was always the right outboard (upwind) engine, which exacerbated the tendency of the aircraft to weathervane into the crosswind.

Figure 16 presents indicated airspeed, distance from runway centerline, rudder deflection, and nose-gear steering angle as a function of distance from brake release for representative RTO maneuvers for each of the crosswinds. One observation regarding this maneuver was that the effect of increased crosswind caused the aircraft to accelerate more slowly and decelerate more quickly as a result of constantly operating at large sideslip and skid angles. Accelerating and stopping distances were decreased approximately 300 ft due to the 35-knot crosswind. Another observation was that pilots had little trouble maintaining the aircraft within the desired boundaries of ± 10 ft from runway centerline. Maximum rudder deflection was only approximately 20° for the 35-knot crosswind, and maximum nose-gear steering angles were on the order of 5° . Overall, the aircraft exhibited ample control authority and performance to execute this maneuver within desired boundaries for crosswinds up to 35 knots.

The CHRs for the RTO maneuvers (tasks 1050, 1051, and 1052) are given in figure 13. The effect of crosswind increased the difficulty of the maneuver somewhat but not enough to increase the CHRs by a full unit. CHRs for this maneuver were generally 3 to 4, with one pilot assigning the maneuver 1. The average CHR rating was 2.8 indicating Level I performance. Pilots generally needed multiple runs to become proficient in the simulated task and produce desired results, although no pilot needed more than three attempts to complete any one maneuver. Results also indicate that if the pilot had not been briefed to expect an engine failure, larger errors and subsequently worse CHRs may have resulted. Overall the aircraft was able to be brought to a complete stop in about 8200 ft for the zero crosswind scenario. The air-

craft had adequate nose-gear steering and rudder authority to compensate for the weathervaning and engine out, as shown in figure 16. Some pilots also used differential braking to help steer the aircraft at higher speeds. Pilot comments also indicated that the nose-gear steering had too much authority at higher speeds and the gearing should be reduced. This problem could easily be rectified through incorporation of speed sensitive nosewheel steering gains to soften the response of the aircraft to rudder inputs at elevated speeds, as currently used on large aircraft.

One-Engine-Out Takeoff (Task 7035)

The OEO takeoff maneuver (task 7035) was designed to evaluate the ability of the aircraft to continue a takeoff after an outboard engine failed. The engine failure occurred immediately after the aircraft reached the decision speed, V_1 ; therefore, the pilot was required to continue the takeoff. The HUD guidance was the same as for the acoustic profile takeoff maneuver, which commanded the pilot to capture and maintain the desired climb airspeed ($V_c = 219$ knots) after liftoff. For this maneuver the pilot had the additional task of centering the sideslip indicator with rudder pedal inputs.

Some differences in the guidance law were observable by the pilots during this maneuver as compared with the acoustic profile takeoff. One difference involved the lower limit of the velocity-vector climb guidance. The lower limit was set to a 3-percent climb gradient and prevented the guidance law from commanding too low a climb gradient while attempting to accelerate to and maintain airspeed. During normal operations, the aircraft had sufficient excess power to accelerate at a climb gradient above 3 percent; this resulted in the longitudinal guidance being based solely on airspeed. However, immediately after liftoff when the aircraft was operating at a low speed with an engine failed, the available acceleration was less than that commanded by the velocity-vector guidance law; this resulted in short periods of time when the pilot would be commanded to follow the 3-percent climb gradient. Once sufficient aerodynamic performance was achieved at higher airspeeds, the velocity-vector guidance law reverted to airspeed guidance. Another difference in the HUD guidance involved the control of sideslip angle through the use of rudder pedal inputs combined with information from the sideslip

indicator. Obviously, during normal takeoff operations, controlling sideslip angle was not necessary because it was always at or near zero. During the OEO takeoff task, however, the pilot had to actively control sideslip angle. The sideslip indicator presented complementary-filtered sideslip angle.

Pilots had little difficulty performing the OEO takeoff maneuver up to the point of rotation initialization. Once rotation was begun and the nosewheel lifted from the runway, pilots had some difficulty keeping the aircraft within desired bounds, as shown in figure 17. This figure presents indicated airspeed, lateral distance from runway centerline, rudder deflection, and rudder pedal inputs as a function of distance from brake release for the five pilots. The data in figure 17 stop at liftoff for each of the examples. This figure shows that once the aircraft began the rotation maneuver, significant lateral error was built up; this may have been caused by the lack of visual cues regarding runway centerline once rotation was initiated. Also maximum rudder deflection was not used. Another problem encountered was some elevator and stabilizer rate limiting, as shown in figure 11. This problem was more pronounced for the OEO takeoff maneuver (task 7035) because pilots were distracted by the lateral task and could not focus on maintaining a specified rotation rate profile.

Once airborne the aircraft exhibited ample control authority to handle the asymmetric thrust situation. One benefit of the closely packed engines, typical of HSCT configurations, was that the amount of yawing moment produced due to a failed engine was relatively small. Figure 18 provides information regarding the deflection of the rudder and differential aileron, altitude, and airspeed for the entire OEO takeoff maneuver. From figure 18 the rudder deflection required is seen to be only about 10° to 15° immediately after liftoff and decreases to a steady-state value of approximately 8° once the aircraft reaches climb speed for four of the five pilots. Differential aileron deflection is also small compared with the maximum amount available. Overall, the Ref-H aircraft had adequate control authority to perform the OEO takeoff maneuver.

One pilot (pilot B) flew the maneuver with the sideslip display indicator on the HUD being driven by lateral acceleration at the cg, which was done accidentally during the early stages of the piloted research evaluations. This type of display is generally what is

used in current aircraft and replicates the functionality of the turn coordinator, which is just a ball in a curved glass tube. Lateral accelerations displace the ball from the center of the instrument; this requires the pilot to “kick the ball” (i.e., left ball movement requires the pilot to push the left rudder pedal) to maintain coordinated flight. Based on preliminary evaluations, the sideslip indicator drive logic was modified to use complementary filtered sideslip angle, which is a parameter used by the directional control law. For the maneuver evaluations where lateral acceleration at the cg was selected to drive the sideslip indicator, the pilot commanded rudder to zero out the lateral acceleration. As a result, the aircraft maintained a significant amount of sideslip (shown in fig. 19) because the aircraft reached a trim point at the high sideslip angles. Figure 18 shows the effect of increased sideslip angle on aircraft performance, where the climb rate achieved by pilot B was much lower than the other four pilots.

Pilot comments regarding the OEO takeoff maneuver identified that it was a little more difficult to perform than the normal operation takeoff maneuvers (tasks 2010 and 2030). See figure 13 for the CHRs for all takeoff maneuvers and the appropriate flight card (appendix D) for a complete definition of the maneuver segments and pilot performance criteria. The first segment of the task, centerline tracking, was rated an average lateral CHR of 3.8 with three of the five pilots delivering Level II ratings. This level could be from the oversensitive nosewheel steering law combined with the engine failure and could be reduced with speed sensitive steering as was mentioned for the RTO tasks. During the second segment, takeoff rotation, pilots commented on the lack of external visual cues or guidance to maintain the aircraft within the desired boundaries, even though the aircraft had enough control authority, as shown in figure 17. As a result, pilots rated the lateral portion of the rotation segment a CHR of 4.2 with four of the five pilots rating it Level II. Improvements in guidance and/or other visual cues could reduce this rating.

The longitudinal portion of the rotation segment was also rated slightly worse than the same segment for tasks 2010 and 2030. Pilot comments reflected problems regarding the increased workload introduced by the lateral task resulting from the asymmetric thrust, and they rated this segment an average longitudinal CHR of 3.6. Pilot comments for the airborne segment of this maneuver indicated that the longitudinal

portion was not much different than task 2010 and actually pointed out that it was slightly easier to perform than task 2010; however, those comments were not reflected in the CHR ratings. Average longitudinal CHR ratings for airborne segments of tasks 2010 and 7035 were all approximately the same. Pilots rated the lateral portion of the task an average CHR of 3.8, with three of the five pilots providing Level II ratings. Comments regarding this portion of the maneuver indicated that it was not too difficult to perform once the proper amount of rudder pedal bias was determined. Overall, the maneuver was rated a low Level II, which was acceptable given the fact that this is an emergency maneuver. Additional pilot comments regarding the HUD and guidance logic suggested that the guidance law could be improved, although no specific options were offered.

The effect of the different drive logic for the sideslip indicator, as experienced by pilot B, may have increased his CHR for the lateral-directional portion of the third segment (climb) because maintaining flight at significant sideslip angles is somewhat more difficult. However, the CHR delivered by pilot B for the lateral-directional portion of the climb segment was only one unit higher than pilots A and C.

Minimum Control Speed on Ground (Task 7030)

Task 7030 was designed and executed to determine the minimum controllable rotation airspeed on the ground in the event of an engine failure. Nose-gear cornering forces were zeroed out for this maneuver and the MFC was selected. This maneuver was intended to verify that the speed V_{mcg} was below the rotation speed for the lowest possible takeoff weight. The first pilot to complete task 7030 was asked to perform the maneuver for a series of engine failure speeds and maintain the aircraft to within ± 30 ft of runway centerline. Once the minimum engine failure speed that produced the maximum permissible lateral excursion was identified, that speed was defined as V_{mcg} . Four other pilots successfully demonstrated the maneuver with the engine failure occurring at V_{mcg} , which was determined to be 127 knots. Figure 20 presents percent net thrust from engine 4, rudder deflection, aircraft heading and track angle, and lateral distance from runway centerline as a function of time for a representative demonstration of task 7030. From figure 20, the pilot-control law combination required

less than 1 sec to develop full rudder deflection to counter the asymmetric thrust caused by the engine failure. Once the engine failed, aircraft heading error increased until the airspeed reached approximately 150 knots, where sufficient rudder control was available to counter the asymmetric thrust condition and arrest the increase of aircraft heading error. The maximum lateral excursion occurred, however, when the track angle of the aircraft was realigned with the runway centerline, which lagged behind the aircraft heading due to landing gear skidding. The rotation speed for the takeoff maneuver was 174 knots, which was determined for the aircraft with the maximum takeoff weight (M13) mass case. A speed of 127 knots correlates well with an expected rotation speed for the MFC of 128 knots.

Approach and Landing Tasks

Approach and Landing Task Definition

The approach and landing tasks included in the piloted assessment were divided into two blocks. The first block included approach and landing tasks with the aircraft in the nominal configuration. The second block included tasks with various failures. Table 4 gives the complete set of approach and landing tasks.

The aircraft was configured in the MFC for all approach and landing tasks, with the weight set at 384 862 lb and the cg located at 53.2 percent \bar{c} . The tasks were generally divided into two segments, each of which was assigned a separate CHR for longitudinal control and for lateral control. The first segment consisted of an Instrument Landing System (ILS) approach tracking task, as illustrated in figure 21. This segment typically began with the vehicle trimmed at an equivalent airspeed of 200 knots in level flight at an altitude of 1500 ft. The pilot performed a 30° localizer capture followed by an airspeed reduction to the final approach speed of 157 knots. Autothrottles were engaged in most cases; therefore, the airspeed change was performed automatically. The pilot continued to track the ILS approach path, performing a 3° glide-slope capture at a distance of approximately 5 nmi from the runway. Segment 1 continued until the aircraft reached an altitude of 400 ft, at which point, segment 2 of the task ensued. Desired and adequate performance specifications for the ILS tracking task are defined in figure 21. The

tasks included light or moderate turbulence as indicated on the flight cards in appendix D.

The second segment of the approach and landing consisted of the flare and touchdown task. This segment was initiated at the termination of the ILS tracking task (altitude of 400 ft) as shown in figure 21. The final approach segment of the landing tasks included an automatic reconfiguration of leading- and trailing-edge flaps that was initiated at 390 ft, was ramped in over a period of 18 sec, and finished at an altitude of approximately 150 ft. The impetus for this automatic flap reconfiguration is the trade-off between noise constraints and the desire to reduce the aircraft pitch attitude during final approach and touchdown. The autoflap protocol used in this assessment involved configuring the aircraft for a low-speed-low-noise approach to an altitude of 390 ft, at which point the vehicle passes a critical noise-measuring station. Flaps and leading-edge devices were then automatically commanded to a high-lift-low-pitch attitude setting of LEF 10° and TEF 30° for the final flare and touchdown; therefore, the potential for tail strike was reduced and an improved runway viewing angle was provided. The time histories presented in figure 22 show that this flap reconfiguration reduces the approach attitude by about 5°. However, the flap reconfiguration also requires a throttle increase of approximately 12 percent to maintain the nominal approach speed of 157 knots; this illustrates the contrast between the low-noise (low thrust) flap settings and the low-pitch attitude flap setting.

The pilot continued to track the glide slope through the automatic flap reconfiguration, which was completed at a gear altitude of 150 ft. At a gear altitude of 100 ft, the pilot disarmed the autothrottles. At a gear altitude of approximately 55 ft, the pilot initiated a flare and manually retarded the throttles, attempting to achieve main gear contact with the runway at the target touchdown location within the desired sink rate tolerances. Desired and adequate performance specifications for sink rate and touchdown dispersion are shown in figure 21. The task criteria used to define desired and adequate touchdown performance differed slightly from those used in a previous Ref-H control law down-select simulation study performed at Ames Research Center in the fall of 1995. The desired and adequate sink rate criteria were set at 3 and 6 ft/sec, respectively, as indicated on the flight cards shown in appendix D. These numbers are more stringent than

the 4- and 7-ft/sec touchdown performance specifications that were used in the earlier Ref-H simulation; this factor should be noted when comparing handling quality ratings between the two experiments. After main gear contact, the pilot derotated the vehicle to place the nose gear on the ground. The simulation was terminated shortly after nose-gear contact.

Head-up Display for Landing Tasks

A diagram of the HUD that was used for the approach and landing tasks is shown in figure 23. The basic visual scene and HUD used for these tasks were the same as those described in the section “Test Description” except for the following:

1. Gear altitude shown to right of commanded flight-path indicator with airspeed shown to left and distance measuring equipment indication shown directly beneath the commanded flight-path indicator
2. Dashed flight-path offset indicator shown in figure 23 appeared on display only when actual flight path at cg differed from commanded flight path by more than 0.5° for altitudes greater than 100 ft and 0.25° for altitudes less than 100 ft
3. Primary guidance supplied for approach and landing consisted of ILS glide slope and localizer symbology presented on HUD as shown in figure 23
4. Flight-path guidance symbol, having form of magenta circle, also presented on HUD during only one task, nominal approach and landing with flight director (task 4025); operation of this guidance symbol described in appendix E; as in many tasks in this study, flight-path guidance was not presented in most tasks to prevent pilots from focusing on assessment of guidance symbology rather than potential configuration deficiencies
5. Additional symbol that appeared on HUD during final segment of landing tasks was tail-strike indicator bar shown in figure 23; this symbol took form of red and white “barber pole,” which appeared on HUD to indicate pitch attitude at which tail strike would occur as function of aircraft altitude; during go-around tasks, this symbol gave pilots positive indication of maximum pitch attitude they could command at

their current altitude without incurring a tail strike

6. Flare alert cue was presented on HUD which appeared at gear height of 100 ft; this symbol took the form of two segmented horizontal bars located below commanded flight-path indicator as shown in figure 23; the flare cue moved vertically on HUD until it contacted commanded flight-path indicator at a gear height of 55 ft, then the pilots followed the upward motion of flare cue with flight-path command to a final flight-path angle of -0.2° in the ideal case (further detail regarding operation of flare alert cue is in appendix E)

Summary of Handling Qualities Ratings for Approach and Landing Tasks

Figure 24 presents the CHRs assigned by the five pilots to each approach and landing task. The tasks that included an ILS approach tracking segment were given Level I ratings generally for both longitudinal and lateral directional axes, with several low Level II ratings (CHR of 4). The exceptions were the manual-throttle approaches, where several CHRs of 5 were given to the ILS approach task, and the unaugmented approaches, where the CHRs ranged from 5 to 7 for control of the unaugmented aircraft in the ILS approach.

The flare, touchdown, and derotation segment of the tasks was given predominantly Level II ratings for the longitudinal control, with the most notable exceptions being the lateral offset tasks and the crosswind landing tasks. These tasks and their ratings will be discussed in greater detail later. Generally, the most problematic tasks were those that stressed lateral-directional control, which may be due in part to the immaturity of the lateral-directional control law that was used in this assessment. However, it is also possible that the difficulties encountered during these tasks were due to inadequate lateral-directional control authority in the final approach configuration.

Nominal Configuration

The tasks described in this section were conducted with the aircraft in the nominal configuration. The results of the task performances that are shown may not represent the best possible touchdown perfor-

mance that is achievable for this aircraft due to immaturity of the control laws. Rather, the performance results are more appropriate for relative comparisons between tasks or even between different simulations. The results are significant in that they (1) provide an outside bound on the performance that should be achievable with this control response type, (2) reveal whether major configuration issues such as tail or nacelle strike were encountered during the landings, and (3) reveal potential control authority deficiencies for a particular task.

Nominal Approach and Landing (Task 4020)

Segment 1 of task 4020 covered the approach at altitudes from 1500 ft to 400 ft and included ILS localizer and glide-slope captures, as noted on the flight card in appendix D. The task was initiated at an altitude of 1500 ft on a heading for a localizer intercept of 30° . All pilots were able to achieve desired performance during the ILS approach with levels of effort that were considered to be moderate or lower. No significant aircraft control deficiencies were revealed by this segment of the task, although pilot D did remark that he would prefer tighter turn coordination from the lateral-directional control law. The CHRs assigned by the pilots for this segment of the task are shown in figure 24.

Segment 2 of the task involved the flare, touchdown, and derotation maneuvers and covered the portion of the landing from 400 ft to touchdown. The predominantly Level II longitudinal ratings reflect some minor difficulties in using the control law to perform extremely precise spot landings. Another contributing factor was the stringency of the performance criteria for the touchdown sink rate task. Performance results in terms of touchdown locations and sink rates for this task are shown in figure 25. The figure shows that adequate performance or better was achieved in most runs. More than half the runs, however, did not achieve desired performance in terms of the touchdown location, and very few of the runs actually achieved both desired touchdown location and sink rate.

Nominal Approach and Landing With Flight Director (Task 4025)

Task 4025 was very similar to the nominal approach and landing task with the addition of a

pursuit flight director that operated as described in appendix E. Pilot comments indicated that the addition of this flight director to the nominal approach and landing task actually caused the workload for segment 1 to increase slightly by providing a higher bandwidth pursuit task than the raw ILS approach. The CHRs in figure 24 for segment 1 of this task show that although pilot A improved his longitudinal rating by 1 point, pilots B and D degraded their longitudinal ratings by 1 point.

The CHRs for the flare, touchdown, and derotation segment of this task are also shown in figure 24. They are quite similar to the CHRs of segment 2 from the previous task (task 4020). Figure 25 shows that the typical touchdown performance results did not differ dramatically from those observed for the previous task without the flight director.

Precision Landing (Task 4050)

Task 4050 was initiated at an altitude of 400 ft and essentially duplicated segment 2 of the nominal approach and landing (task 4020). This duplication allowed the pilots to concentrate on rating the final segment of the landing and provided a check for changes in the ratings due to possible learning effects. No major changes in the longitudinal ratings are apparent between segment 2 of task 4020 and this task, but two pilots did change their lateral-directional ratings from 3 to 4. This change may reflect what one pilot described as a minor but annoying tendency for aggressive longitudinal corrections to inadvertently disturb the lateral directional axes during the final segment of the landing. Figure 25 shows the touchdown performance results for this task and those of the previous two tasks. The dispersions of the performance results for all three tasks appear quite similar.

Use of Automatic Flap Reconfiguration During Final Segment of Landing Tasks

The time histories presented in figure 22 showed that the automatic flap reconfiguration reduced the approach attitude by about 5° and required a throttle increase of approximately 12 percent to maintain the nominal approach speed of 157 knots. The $\dot{\gamma}/V$ control law automatically reduced pitch attitude in response to the automatic flap reconfiguration to

maintain the flight path commanded by the pilot. The concern was that this automatic reduction in pitch attitude at such a low altitude might be disconcerting to the pilots. A review of the transcribed pilot comments (appendix C) for the nominal approach and landings (tasks 4020 and 4050) illustrates that pilot response to the automatic flap reconfiguration as implemented in this investigation was mixed, and at least one pilot was strongly opposed to this practice. Those negative comments regarding the use of the automatic flap reconfiguration were directed at the flight-path ballooning that resulted from the reconfiguration. This ballooning is a deficiency of the control law and not of the automatic reconfiguration itself. A simple open-loop correction to the control law could prevent this flight-path ballooning during the automatic reconfiguration. The acceptability of the automatic flap reconfiguration should not, therefore, be judged based on the artifact of the flight-path ballooning that was experienced in the Langley Visual Motion Simulation (VMS). The acceptability of this procedure is more appropriately assessed based on factors such as the pitch-down it produces and the throttle adjustment it requires. Pilots also expressed great concern regarding the safety issues associated with the automatic flap reconfiguration, such as the potential for asymmetric automatic flap deployment due to a failure.

Landing From Lateral Offset With Moderate Turbulence (Task 4062)

The lateral offset landings were among the most challenging tasks included in the approach and landing portions of the test matrix. As flight card 4062 from appendix D indicates, the task was initiated at an altitude of 400 ft with a lateral offset of 300 ft from the centerline of the runway. At an altitude of 225 ft, the test conductor called "Correct," and the pilot executed a lateral correction to acquire the runway extended centerline. The bank angle tolerance for desired performance specified that bank angle should be 5° or less by the time the vehicle passed through 50 ft, and the pilots found it necessary to aggressively execute the maneuver to achieve this objective. Several times sufficient bank angles were experienced at altitudes low enough to terminate the run by incurring a wingtip strike. Figure 26 shows the maximum bank angle that was experienced below an altitude of 50 ft for each run. About 35 percent of the runs violated the operational limit of 5°.

The CHRs for this task, shown in figure 24, reveal a broader disparity among pilots than most tasks, indicating inconsistent pilot performance as various problems were experienced in the execution of this rather taxing maneuver. The longitudinal CHR of 8 that was given by pilot A was due to what the pilot expressed as spillover of large lateral sidestick inputs into longitudinal stick deflections.

Pilot D gave CHRs of 7 to the longitudinal and lateral-directional control laws for this maneuver. This rating was due to the general dissatisfaction of the pilot with the turn coordination of this control law, a deficiency which became most pronounced during the aggressive lateral correction that was required to execute this maneuver. The version of the lateral-directional architecture used in this experiment did not include lateral-directional command cross feeds that could provide better turn coordination.

The touchdown performance results for task 4062 are shown in figure 27. Touchdown dispersions and sink rates demonstrate a wider lateral spread when compared with the nominal approach and landing tasks of figure 25, and more instances of short touchdowns were observed. Figure 28 shows representative time histories for the landing from lateral offset, task 4062, for each pilot. The pilots initiated the correction with a bank to the left of approximately 15° at a rate of about 10 deg/sec. This maneuver typically caused rate limiting for the trailing-edge flaperon devices. (Control allocation for the Ref-H configuration called for trailing-edge surfaces 1, 3, 6, and 8 to operate as flaperons, whereas surfaces 2, 4, 5, and 7 operated as flaps only.) The lateral correction was then arrested with a bank to the right of between 10° and 15° . The pilots then slowly leveled the wings as they lined up with the center of the runway. It was during this protracted rollout that the operational bank angle constraint was violated in about 35 percent of the runs, as shown in figure 26. The time histories in figure 28 show that the flaperon devices were frequently rate limited during this maneuver. The reconfiguration of the automatic flaps at an altitude of 390 ft reduces the differential roll authority of the flaperons because the trailing-edge devices are at their maximum downward deflection after the reconfiguration is complete. This reduction means that roll inputs can only be generated by raising the flaperons on one wing. The frequent occurrence of actuator rate limiting during the lateral

offset maneuver suggests that, after the automatic flap reconfiguration, flaperon authority may be insufficient for the pilots to confidently perform this aggressive lateral correction. A possible solution might be to reallocate trailing-edge surfaces 2 and 7, currently designated as flaps only, to the role of flaperons. This solution would necessitate equipping these surfaces with higher bandwidth actuators, and associated weight penalties would probably incur. Occasional instances of rudder position and rate saturation were also noted during the lateral offset tasks.

A CHR of 10 was given by pilot B to the lateral-directional control for this task. This pilot experienced two pronounced instances of pilot-induced oscillations (PIOs) in roll during this maneuver—an event that was not encountered during any of the other approach and landing tasks. The time histories of these runs shown in figure 29 reveal extensive rate limiting of the lateral control surfaces during the PIOs. The time histories of bank angle demonstrate that the pilot was performing the maneuver more aggressively during the runs in which PIO was encountered. The time histories illustrate that after the automatic flap reconfiguration, inadequate roll authority is present to perform such an aggressive lateral maneuver with this flaperon control surface allocation.

Landing From Lateral Offset in Category I, Visibility Conditions With Moderate Turbulence (Task 4066)

Task 4066 was essentially the same as the previous task (4062) with the exception of the Category I visibility conditions, which were simulated using the CGI to produce a breakout of 200 ft with visibility of 0.5 nmi. However, somewhat improved CHRs were assigned to this task by pilots A and B. (See fig. 24.) Flight card 4066 shows that the correction maneuver for this task was initiated when the test conductor called “runway in sight.” Although technically the ceiling used in the CGI visual breakout effect was set at 200 ft, definite visual indications of the runway were actually visible at a gear altitude of about 225 ft. The call that initiated the maneuver actually occurred at a higher altitude than the call for task 4062. The earlier initiation permitted the maneuver to be performed with less aggressiveness and, when combined with the learning aspect of having performed task 4062 earlier, resulted in fewer difficulties with the maneuver. Touchdown performance results for this task are

shown in figure 27, and the maximum bank angle that was experienced below an altitude of 50 ft is shown in figure 26. Both figures show that the performance results for task 4066 appear similar to results from the previous task.

Landing From Vertical Offset With Moderate Turbulence (Task 4072)

The correction for the vertical offset landings was again initiated at an altitude of 225 ft when the test conductor called "Correct." The ILS glide-slope indicator reflected an offset of 500 ft from the aim point down the runway, as indicated on the flight card shown in appendix D. The maneuver itself was much more benign than the lateral correction, although the pilots tended to land long as a result of the offset. The longitudinal CHRs (shown in fig. 24) were generally Level II. This rating was indicative of the difficulty involved in performing the correction, based entirely on visual cues, with sufficient precision to achieve the desired touchdown performance criteria.

Landing From Vertical Offset in Category I Visibility Conditions With Moderate Turbulence (Task 4076)

The addition of fog did not affect the pilot ratings for task 4076. As with task 4066, the correction was actually initiated at a slightly higher altitude than in the previous task. The CHRs for this task are in figure 24.

Go-Around (Task 4080)

The 100-ft go-around task required the pilot to disengage the autothrottle lever, press the takeoff go-around (TOGA) button on the throttle lever, and advance the throttles to the maximum setting while pitching to a target climbout attitude of 17°. Each pilot commented on the mechanical deficiencies associated with the physical elements of this throttle arrangement. Despite these mechanical deficiencies, the performance of the go-around maneuver generally met the desired task criteria. The pilots were able to quickly achieve a positive rate of climb and could capture the target climbout attitude with acceptable precision. A minor tendency to overshoot or oscillate about the target climbout attitude was noted and would seem to be a natural consequence of conducting an attitude-oriented climbout task with a flight-path oriented con-

trol response type. Future versions of the go-around tasks should probably specify performance criteria based on a target climb gradient rather than a target attitude for use with the $\dot{\gamma}/V$ control law. The longitudinal CHR of 7 assigned by pilot D was based on dissatisfaction with the mechanical operation of the autothrottle disengage lever, the TOGA switch, and the mechanical deficiencies of the throttle levers, rather than an aircraft performance or control issue. All CHRs for task 4080 are given in figure 24.

Elevator rate limits were sometimes encountered at the initiation of the 100-ft go-around maneuver, but comments of the pilots indicate they felt that control was not in jeopardy at any point during the task. Figure 30 shows the minimum gear altitudes and maximum elevator deflections that were experienced for each of the runs. Elevator position limits were encountered on approximately 25 percent of the 100-ft go-arounds.

Go-Around With Minimum Altitude Loss (Task 4085)

As flight card 4085, shown in appendix D, indicates, the go-around maneuver for this task was initiated at an altitude of 30 ft; this makes the maneuver more aggressive than the 100-ft go-around. Figure 30 shows that control surface position limits were experienced at the initiation of the go-around maneuver in about 35 percent of the runs for task 4085 but only briefly. Pilot comments demonstrate a feeling of positive control throughout the execution of this maneuver. The momentary saturation of elevator during initiation of the go-around maneuver is typical of a surface that is appropriately sized for the go-around task. Some minor tendency to overshoot or oscillate about the target climbout attitude was noted as for the previous task. The longitudinal CHR of 7 given by pilot D again was based on dissatisfaction with the operation of the TOGA switch and the mechanical deficiencies of the throttle levers rather than an aircraft performance or control issue. The CHRs for task 4085 are shown in figure 24.

Figure 31 shows typical time histories from the 30-ft go-around task for each pilot. A minimum gear height of between 10 and 15 ft was typical. Of the five runs shown, it is apparent that pilot B was the most aggressive, incurring elevator rate limits and

momentary saturation. A pitch “bobble” was also apparent as pilot B attempted to arrest his aggressive pitch-up at the target climbout attitude of 17° . By immediately advancing the throttle levers to the maximum setting at the start of the maneuver, the pilots were able to quickly arrest their descent and establish a positive rate of climb. Although the engine model time constant at the approach condition is approximately 1 sec, rate limits in the model caused the time histories of the thrust response to this rapid, large-amplitude throttle advance to resemble a lag with a time constant of approximately 4 sec. The pilots found the speed of the propulsive response to be generally acceptable. In no instance was a tail strike incurred. A key factor in avoiding a tail strike was the use of the tail strike indicator bar on the HUD, as shown in figure 23. Although the target pitch attitude for the go-around was 17° , the tail strike bar on the HUD enabled the pilot to adjust the aggressiveness with which he achieved this attitude; thereby, tail strike was avoided. Figure 32 shows tail height and gear height time histories from the five representative runs that were presented in figure 31. For most runs, the minimum gear height was actually lower than the minimum tail height. A discrete change in gear height is apparent in several of the time histories; this corresponds to landing gear retraction called for by the pilot during the abort.

Approach and Landing With 15-Knot Crosswind (Task 4090)

Pilots found the crosswind landing tasks, in which a constant crosswind component was present, to be highly challenging. The first of these involved a 15-knot crosswind (task 4090). As the CHRs (fig. 24) illustrate, the first segment of this task, which included localizer tracking and glide-slope capture, received Level I or low Level II ratings for both longitudinal and lateral-directional control. Pilot comments include positive remarks generally about the controllability of the aircraft during this crabbed portion of the approach, but all pilots noted some dissatisfaction with the HUD in this task. The crabbed approach caused the velocity-vector symbol on the HUD to be positioned at a great distance from the ILS glide-slope and localizer indicators; this produced an exceptionally wide scan pattern for the pilots to cover. The inclusion of a flight director would have diminished this display problem.

The second segment of task 4090 included the flare, touchdown, and derotation maneuvers. The pilots were directed to decrab the aircraft for the touchdown during this segment; this maneuver proved to be somewhat problematic. Marginally adequate performance was achieved with concerted effort, and pilot comments indicate difficulty in controlling touchdown sink rates in the decrabbed condition. The CHRs for this segment indicate varying degrees of frustration with the touchdown and were generally Level II. It is not certain at this point whether the difficulty with the decrab maneuver was due to deficiencies in the control laws or crosswind aerodynamic characteristics of the aircraft in the landing configuration. Touchdown performance results for this task are shown in figures 33(a) and (b). High touchdown sink rates are apparent for many of the runs. Figures 33(c) and (d) show the aircraft heading alignment with the runway at touchdown. Most of the 15-knot crosswind landings exceeded the desired alignment tolerance of 2° but were within the 4° adequate tolerance.

Approach and Landing With 35-Knot Crosswind (Task 4095)

The first segment of the 35-knot crosswind approach and landing task (task 4095) was quite similar to the 15-knot task and received comparable CHRs. (See fig. 24.) The greater crosswind caused the visual distance on the HUD between the crabbed velocity-vector symbol and the glide-slope and localizer indicators to be even greater.

The longitudinal and lateral-directional CHRs for the flare, touchdown, and derotation segment of this task reflect the extreme difficulty associated with performing the decrab maneuver in the 35-knot crosswind. Touchdown performance was usually outside the adequate tolerances, and sink rates were often excessive, as shown in figures 33(a) and (b). Figures 33(c) and (d) show that most of the 35-knot crosswind landings exceeded the adequate tolerance for the aircraft heading alignment with the runway at touchdown, which would tend to produce high lateral gear loads. Wingtip and nacelle strikes were a concern during the decrab, but figures 33(c) and (d) show that most landings did not exceed the aircraft geometry strike envelope at touchdown, although several did violate the operational bank angle limit of 5° . Lateral gear load design tolerances and whether the gear arrangement includes the use of steerable trucks may

also impact the amount of decrab which must be performed prior to touchdown.

Figure 34 shows representative time histories for the final portion of the 35-knot crosswind landings for each pilot. Relatively large amplitude flaperon commands and some flaperon rate limiting are apparent during the decrab maneuver. Rudder deflections appear to be moderate through the decrab to the point of main gear contact. The angle of sideslip for the decrabbed configuration in the 35-knot crosswind is approximately 14° . The time histories of sideslip angle indicate that some pilots preferred to partially decrab the aircraft prior to the flare while others performed a more rapid decrab maneuver during the final moments of flight. Pilot comments were highly negative regarding control of the decrab in the 35-knot case. The poor pilot ratings highlight the need to develop a reliable procedure for crosswind landings.

Landing in Category IIIa Visibility Conditions (Task 4100)

Task 4100 was unrealistic in that it was performed without the use of a flight director in Category IIIa visibility conditions. The HUD provided localizer and glide-slope information, but below altitudes of about 150 ft, scaling of the ILS caused the task to be essentially open loop. The pilots were comfortable performing the segment 1 ILS approach portion of the task without a flight director. The CHRs for segment 2 reflect the general dissatisfaction of the pilots with performing the final flare and touchdown without a flight director, although a vertical flare cue was still provided for this portion of the task. (See fig. 24.) With the visual breakout set at 50 ft, the runway remained out of sight from the cockpit almost all the way to main gear touchdown.

Failure Configurations

Tasks 4110, 7050, and 7095 were conducted with the aircraft or the aircraft flight control system in off-nominal configurations. The CHRs for these tasks are included in figure 24.

Approach and Landing With Jammed Control (Task 4110)

The stabilizer was jammed at zero deflection for task 4110, leaving only the elevator to provide pitch

control authority. The task was identical to the nominal approach and landing (task 4020) in all other respects. Admittedly, the zero-deflection stabilizer jam is not the worst case in terms of identifying control authority limits. Pilots noted only a minor impact on inner-loop control resulting from the surface jam. The reduced pitch control authority appeared to make the pitch attitude response to flight-path angle command changes slightly more oscillatory. Pilots tended to comment that they observed somewhat greater overshoot and bobble in pitch attitude in response to stick pulses.

Dynamic V_{mcl-2} (Task 7050)

For task 7050 the vehicle was trimmed on the nominal approach path at an altitude of 1000 ft with the inboard starboard engine (number 3) failed. A minimum approach airspeed of 140 knots was identified by the first pilot by successive reduction in demonstrated recovery speed. This speed was used in subsequent evaluations of this task by the other pilots. Shortly after initiation of the run, the outboard starboard engine (number 4) was failed. The pilot then disengaged autothrottles and recovered to the original approach speed and glide slope. The throttles were not advanced to maximum once engine 4 failed but rather were manually adjusted to recapture the nominal approach path and target airspeed of 140 knots. The task was terminated after recovery to the nominal approach path. Transients due to the failure of the outboard engine were minor and controllable, and the recovery was generally benign. The CHRs assigned by the pilots for this task averaged 3 (fig. 24), reflecting the repeatability and confidence with which they were able to perform this recovery. Typical time histories from runs performed by each pilot are shown in figure 35. Large rudder deflections were typically observed during the recoveries, and the maximum roll angle was usually 6° or less.

Manual Throttle Landing (Task 7095)

No difficulties were encountered with manual control of airspeed in this backside approach condition (task 7095), and the relatively low workload on the longitudinal stick associated with the $\dot{\gamma}/V$ control law appears to leave the pilot ample time to focus on airspeed control. The nominal approach speed was increased by 5 knots, from 157 to 162, for the manual

throttle tasks. No pitch bobbles resulted from the manual throttle adjustments that were made to regulate airspeed. Most pilot comments were directed at the high breakout forces and poor ergonomics of the physical throttle levers themselves, a deficiency that was partially overcome by reducing the number of throttle levers to two for all manual throttle tasks, including the unaugmented landing tasks 7110 and 7100. The CHRs assigned by the pilots ranged from Level I to mid Level II (fig. 24); this reflected the increased workload on the approach due to manual throttle operation combined with the poor ergonomics of the throttle arrangement. Figure 36 shows time histories of two typical manual throttle approaches and an autothrottle approach. The throttle traces illustrate that frequent adjustments were required to maintain the approach airspeed. For throttle inputs of the size used to produce the thrust changes shown in figure 36, the propulsive response resembles a first-order lag with a time constant of approximately 1 sec. (This is in contrast to the 4-sec response to larger throttle inputs observed during the go-around tasks. The slower response was imposed by rate limits included in the engine model.)

Batch Assessment of Ref-H Backside Characteristics

The pilot should perceive the speed instability associated with a backside configuration only when the approach is performed with autothrottles deactivated. The piloted Ref-H assessment contained several tasks that required the pilot to control throttles manually during the approach, particularly task 7095 (manual throttle landing). A batch assessment of the backside characteristics of the Cycle 2B configuration was performed to augment the results of these manual throttle approach tasks. Figure 37 shows thrust-required curves for the Ref-H Cycle 2B configuration at two different flap settings that were produced using a batch version of the simulation. The aircraft was trimmed on a glide slope of -3° with landing gear down, vortex fences retracted, and a weight of 384 862 lb. The impact that flap setting has on the backside transition airspeed, indicated by $V_{(L/D)_{\max}}$, is apparent in the figure. The approach flap schedule for the leading- and trailing-edge devices used in the piloted assessment corresponds most closely to the trim curve for LEF 40° /TEF 8° . Therefore the backside transition airspeed for the aircraft in this configuration is approximately 200 knots. Because the slopes of the curves differ at the nominal approach speed of 157 knots, $d\gamma/dV$ may be significantly influenced by

the flap setting chosen for landing approach. In fact, for the LEF 40° /TEF 8° setting, $d\gamma/dV$ was calculated to be 0.103 deg/knot, whereas for the LEF 30° /TEF 20° setting, $d\gamma/dV$ was calculated to be as low as 0.060 deg/knot.

Because the automatic flap schedule used in the piloted Ref-H assessment was dependent on airspeed and $d\gamma/dV$ appeared to vary with flap setting, the automatic flap schedule could possibly produce an effective $d\gamma/dV$ that differed significantly from the bare airframe $d\gamma/dV$. Figure 38, produced to investigate this possibility, shows thrust-required curves for the LEF 31.0° /TEF 6.8° and LEF 41.3° /TEF 11.9° settings with landing gear down on a glide slope of -3° and vortex fences retracted. The automatic flap schedules shown in appendix A call for these leading- and trailing-edge settings to be used for Mach of 0.28 and 0.22, while linearly interpolating for intermediate Mach as airspeed varies during the approach. The approach is actually conducted at Mach of approximately 0.24 and an airspeed of 157 knots. Because the two thrust-required curves shown in figure 38 are so similar at the approach speed of 157 knots, the effective $d\gamma/dV$ produced by varying the flap settings between these two conditions (due to minor airspeed excursions during the approach) clearly will not differ significantly from that produced by a constant approach flap setting. Therefore the addition of a velocity-dependent automatic flap schedule does not significantly alter the effective $d\gamma/dV$, which at the approach airspeed based on these trim curves is about 0.080 deg/knot. This value indicates that the Ref-H Cycle 2B configuration should exhibit Level II flying qualities during a manual throttle approach according to reference 12.

Unaugmented Landing With Longitudinal SCAS Inoperative (Task 7110)

For task 7110, the pitch stability and control augmentation system (SCAS) was replaced with a direct link from the stick commands to the control actuators, whereas the lateral-directional SCAS remained active. Throttles were controlled manually. Pilots noted very high workload associated with longitudinal control of the unaugmented, mildly unstable airplane. Despite the high workload in the longitudinal axis, very little contamination of the lateral axis was noted. The lateral control law appeared to reject disturbances resulting from the constant longitudinal deviations to the point

that the pilots were essentially able to attain good localizer captures and desirable lateral performance while devoting little conscious effort to the lateral-directional task. The pilots were able to control the bare airframe sufficiently to achieve marginally adequate longitudinal task performance. The longitudinal CHRs ranged from 5 to 7 for both segments of this task. (See fig. 24.)

Unaugmented Landing (Task 7100)

For task 7100, both the longitudinal and lateral-directional SCASs were eliminated; thus the pilot was left in control of the bare airframe. Throttles were controlled manually. This task was definitely the most taxing in terms of demands on the attention of the pilot. Landing the fully unaugmented aircraft appeared to be at the threshold of the control capabilities of the test pilots. In several instances, momentary lapses of attention resulted in significant and potentially catastrophic deviations from the desired vehicle attitude and trajectory. The ratings reflect very high workloads throughout the approach in the longitudinal and lateral directional axes. Level III ratings were awarded to this task by several pilots. (See fig. 24.)

Time histories of the longitudinal stick activity for the augmented nominal approach and landing (task 4020) and unaugmented landing (task 7100) are shown in figure 39 for pilot E. The plots show traces from 600 ft to touchdown, although the tasks were actually initiated at 1500 ft and included the localizer and glide-slope captures. A dramatic increase in stick activity is apparent, as expected, for the unaugmented landings. Elevator activity exhibiting a similar trend is also shown in the figure.

All-Engines-Out Landing (Task 7090)

The scenario for task 7090 was somewhat contrived, but it afforded an opportunity to assess controllability of the vehicle with all engines inoperative. As flight card 7090 in appendix D indicates, the task was initiated with all engines inoperative at a condition from which it was known that the aircraft could easily reach the desired landing box on the runway. The task procedure and the initial altitude of 3000 ft, airspeed of 200 knots, and distance of 5 nmi from the runway threshold were established based on preevaluation runs with the project checkout pilot. The pilots' impressions of the attitude and flight-path control

were positive, subject to the limitations of the validity of the model fidelity regarding the impact of the inoperative engines on the aircraft flight dynamics and control laws. (See fig. 24 for CHRs.) No loss of surface actuation capacity due to total engine failure was simulated. Trajectory management and energy management would be a significant problem; this issue was not addressed by the task.

Up-and-Away Tasks

Velocity-Altitude Display

Some of the up-and-away tasks made use of a specialized cockpit display developed for this study. Figure 40 shows a schematic of this display, known as the velocity-altitude display (VHD). Depicted on the display is the present position of the vehicle in the aircraft velocity-altitude envelope, the actual trajectory since liftoff, the desired trajectory (if applicable), a projected trajectory based upon current flight-path angle, velocity, longitudinal acceleration, and load factor (predicted 40 sec ahead). (A photograph of an actual display is shown in fig. B5.)

This display was initially developed to support the profile climb task, but it was discovered to be useful for the descent (profile and emergency) tasks as well. It was also used as an "envelope indicator" for other up-and-away tasks.

Recovery From Limit Flight Envelope Tasks

All commercial transport aircraft are required to demonstrate that a specific margin exists between normal operation speeds and stall speeds. Generally, minimum approach speed is dictated by the stall speed. Because cranked-arrow wing configurations such as the Ref-H do not stall in a conventional manner, a series of demonstration maneuvers at minimum speed and maximum angle of attack was formulated to verify that controlled flight exists at the minimum speeds required for certification purposes. All recovery from limit flight (RFLF) tasks involved the pilot's maneuvering the aircraft to a low-speed, high-angle-of-attack situation, then attempting to recover to wings-level flight at the recovered angle of attack. This task was required to verify the capability of the aircraft to safely operate at these conditions.

Recovery Initiation Criterion

Initial attempts to define a recovery initiation airspeed were abandoned in favor of using the angle of attack as the recovery initiation criterion. The HUD airspeed indicator, located next to the commanded velocity vector, was unreadable at the high-angle-of-attack conditions experienced during these maneuvers. Also, the minimum airspeed originally specified for recovery initiation (180 knots) was higher than approach reference airspeed V_{ref} . For these reasons, recovery initiation was based upon reaching a maximum angle of attack that was readily observable on the HUD.

All stall maneuvers were performed with fixed thrust levers, and the pilot was required to attempt to maintain a deceleration rate of 3 knots/sec (approximately 5.8 ft/sec^2 at 10 000 ft) until recovery was called for by the PNF. Cockpit motion was not used for these runs because of the large levels of aircraft maneuvering encountered. Figure 41 shows angle of attack, rate of change in airspeed, and bank angle for a representative turning stall maneuver. See table 6 for the various scenarios and aircraft conditions used for the stall maneuver set.

Determination of Maximum Angle of Attack

Determination of the maximum demonstration angle of attack was based on preliminary evaluation runs of the nonturning stall maneuvers (tasks 5010 and 5020) in conjunction with a calculation of $(V_{min})_{dem}$ for approach. The stall at idle power maneuver (task 5010) was initially performed with the pilot decelerating to 110 knots before initializing the recovery. The stall at maximum takeoff power (task 5020) required the pilot to decelerate to 156 knots before initializing the recovery. From these runs, the angle of attack achieved when the aircraft reached the recovery airspeed was found to be approximately 21° for both tasks. The calculation of $(V_{min})_{dem}$ was based on an approach speed goal of 160 knots and a maximum landing weight of 402 000 lb and produced a value of $(V_{min})_{dem}$ of 123 knots at an angle of attack of approximately 20° . Therefore the maximum demonstration angle of attack of 21° was determined to be satisfactory. The maximum demonstration angle of attack of 21° would also permit a takeoff $(V_{min})_{dem}$ as low as 187 knots for the 649 914 lb maximum takeoff gross

weight mass case (M13). The assumed recovered angle of attack was based on an initial stability analysis of the vehicle, which indicated that directional stability would exist at angles of attack below 13° . Therefore, the recovered angle of attack was set to 13° .

Batch Simulation Analysis of Longitudinal Nose-Down Control Authority

A batch analysis of the ability of the Ref-H configuration to maneuver at and recover from high angles of attack was conducted as part of this assessment. During this portion of the study, both longitudinal and lateral-directional stability and control properties were evaluated. The longitudinal analysis focused on the ability of the aircraft to generate sufficient nose-down pitch accelerations and pitch rates, whereas the lateral-directional analysis focused on both stability and control issues.

Figure 42 presents information regarding the ability of the aircraft to generate nose-down pitch accelerations to recover from a high-angle-of-attack situation. Pitch acceleration and indicated airspeed are plotted as a function of angle of attack. Data are presented for assumed level flight with quasi-static aeroelastic (QSAE) aerodynamics, automatic flaps based on Mach, minimum thrust, and the final cruise mass case (MFC). Mach was determined from the angle of attack at an altitude of 10 000 ft. The aircraft was trimmed in pitch. Nose-down pitch rate authority was then calculated by applying full nose-down control; that is, $\delta_h = 15^\circ$ and $\delta_e = 30^\circ$. One set of data was calculated with the assumption that the pilot kept the thrust at minimum during the recovery and the other with the assumption that full thrust was commanded and developed at the instant of recovery. Modeling thrust effects in this manner simulates a situation where the pilot has allowed the aircraft to get to a low airspeed situation while maintaining minimum thrust, followed by commanding and developing full thrust before initiating the pitch recovery; this is considered a worst case scenario.

The required pitch acceleration of -4 deg/sec^2 , as described in reference 13, is included in figure 42 to illustrate the point at which the aircraft satisfies this requirement. From this figure, the scenario with minimum thrust, which closely represents the conditions

experienced for turning and nonturning stall maneuvers (tasks 5010 and 5040), can be seen to satisfy the pitch acceleration requirement up to an angle of attack of approximately 20° . This value corresponds approximately to an airspeed of 123 knots, which marginally meets the minimum speed required. If full thrust was being produced at the moment of pitch recovery initialization, then the nose-down pitch acceleration capability of the Ref-H configuration would be reduced significantly. The aircraft can meet the pitch acceleration criterion of -4 deg/sec^2 up to an angle of attack of 18° , which corresponds to a speed of 130 knots. Therefore, the aircraft does not meet the nose-down pitch acceleration criterion under all possible scenarios, and a strong case could be made to limit the maximum angle of attack to 18° . The engine package had an average effective moment arm of approximately 8 ft, which could be reduced to zero with a thrust axis change of 10° . Because it would take a finite amount of time for the engines to develop full thrust, the vehicle would respond more like the minimum thrust case initially. The Ref-H configuration demonstrated marginal nose-down pitch control for maneuvers which were flown with constant minimum thrust and the MFC based on batch analysis. A similar analysis performed with the maximum takeoff M13 and maximum thrust required pitch acceleration up to angles of attack higher than 27° .

Batch Simulation Analysis of High-Angle-of-Attack Lateral-Directional Stability and Control

During the course of pilot evaluations, pilots frequently had trouble recovering from the turning stall maneuvers. A lateral-directional stability analysis was conducted to determine whether any aerodynamic problems associated with the Ref-H configuration were responsible for the problems encountered during recovery from high-angle-of-attack turning flight. Figure 43 shows body axis directional stability C_{n_β} and body axis lateral stability C_{l_β} as functions of angle of attack. As for the data from figure 42, data are presented with QSAE aerodynamics, automatic flaps based on Mach, and the MFC being used. Mach was determined from the pitch-trimmed angle of attack at an altitude of 10000 ft. From figure 43 it can be seen that the Ref-H loses directional stability for angles of attack above 14° . However lateral stability remains stable up to an angle of attack of approximately 22° .

The differences between the angles of attack where the stability derivatives become unstable pose a question about which one to base the maximum angle-of-attack limit.

Figure 44 presents two commonly used stability and control parameters that quantify the high-angle-of-attack capabilities of an aircraft: the dynamic directional stability parameter $\left(C_{n_\beta}\right)_{\text{dyn}}$ and the lateral control divergence parameter (LCDP). These parameters are defined in references 14 and 15.

Both parameters involve combinations of C_{n_β} and C_{l_β} along with the mass properties of the vehicle to provide a more comprehensive analysis of the stability and control characteristics than independent analysis of C_{n_β} and C_{l_β} . As for the data from figures 42 and 43, data in figure 44 are presented using QSAE aerodynamics, automatic flaps based on Mach, and the MFC. Mach was determined from the pitch-trimmed angle of attack for an altitude of 10000 ft.

The parameter $\left(C_{n_\beta}\right)_{\text{dyn}}$ represents the unaugmented stability of the vehicle and its ability to maintain constant flight. Changes in $\left(C_{n_\beta}\right)_{\text{dyn}}$ indicate aircraft instability above an angle of attack of 21° . This instability implies that flight above an angle of attack of 21° would be difficult and require a stability augmentation system. The LCDP parameter quantifies the closed-loop lateral control characteristics of the vehicle. It defines the aircraft response to lateral control inputs. A negative LCDP indicates that the nose of the aircraft would move in an opposite direction than intended by the pilot due to sideslip buildup. A positive LCDP indicates that the aircraft would roll in the intended direction. This analysis was performed with and without aileron-to-rudder interconnect (ARI). As seen from figure 44, the incorporation of an ARI increased the usable angle-of-attack range up to approximately 19° , which was a 5.5° increase from the case without ARI. The directional control law used for this assessment attempted to control complementary-filtered sideslip angle; therefore, specifically assigning a value of effective ARI was difficult. However,

lateral maneuvering in the region where the LCDP, with ARI, was either marginally stable or unstable resulted in undesirable flying qualities and frequent aircraft departures from controlled flight.

Results for Stall Maneuvers

An analysis of pilot performance was performed in which the maximum sideslip angle and maximum angle of attack were determined for all symmetric thrust stall maneuvers attempted. These data are presented in figure 45 and illustrate the widely ranging performance experienced for this set of maneuvers. At angles of attack of 30° , the assumption was that the vehicle had reached an unrecoverable condition and was beyond the point of meaningful aerodynamic data. As seen in figure 45, only small amounts of sideslip developed for most of the nonturning stall maneuvers (tasks 5010 and 5020). Figure 45 also shows that a wide scatter of maximum angles of attack occurs through the course of the maneuver evaluations. The variation in maximum angle of attack was largely due to inconsistencies in the rate of deceleration during the maneuver entry phase. The increased amount of sideslip developed for the turning stall maneuvers was caused by the lateral maneuvering required during the recovery segment of the maneuver, which taxed the independent directional control law beyond its capabilities.

Controlling the rate of airspeed decay was complicated by the $\dot{\gamma}/V$ control law, the back-sided aerodynamic characteristics of the aircraft in this flight regime, and a lack of substantial rate of airspeed decay information available to the pilots. The $\dot{\gamma}/V$ control law hampered the maneuver entry through its attempts to maintain a constant flight-path angle as airspeed was decreased by increasing pitch attitude. A characteristic of the Ref-H configuration, for takeoff speeds less than approximately 250 knots and approach speeds less than 200 knots, was that more thrust was required to fly slower as a result of rapidly increasing drag. This characteristic leads to an unstable situation where the rate of speed decrease continues to grow as the pilot approaches the maximum demonstration angle of attack. If the pilot did not monitor the rate of airspeed decay, a rapid loss of airspeed developed; this resulted in a higher than desired maximum angle of attack.

Sideslip excursions were much more prevalent for the turning stall maneuvers (tasks 5040 and 5050), which required the pilot to level the wings of the aircraft as part of the recovery process. Figure 45 shows that the amount of sideslip developed varied for a given maximum angle of attack. The variance of sideslip angle was determined to be dependent on how aggressively the pilot leveled the wings of the aircraft. A discussion of variations of maximum sideslip angle for the turning stall maneuvers is given later.

As stated previously, the rate of airspeed decay had a significant effect on the maximum angle of attack during a piloted simulation stall maneuver. Figure 46 shows the effect of stall entry speed on maximum angle of attack as a function of time for two attempts of the stall at idle power (task 5010). In one attempt (951205 run 028), the pilot developed a much higher rate of airspeed decay; this resulted in the aircraft attaining a higher than desired maximum angle of attack and eventually departing from controlled flight. Figure 46 shows the rate of airspeed decay reached almost 15 ft/sec^2 (approximately 8 knots/sec) at the time the pilot attempted to recover. In the other attempt (951205 run 030), the same pilot maintained the lower rate of airspeed decay as angle of attack was increased to 21° and performed a nominal recovery to below an angle of attack of 13° .

Several control law anomalies were experienced during the execution of the stall maneuvers. One longitudinal control law problem, already stated, was its adverse effect on the rate of airspeed decay. However, control law anomalies affected the recovery portion of both maneuver attempts, as shown by a subsequent uncommanded increase of angle of attack when the pilot releases the nose-down stick input. This anomaly is shown at approximately 62 sec and 76 sec for run 028 and run 030 in figure 46 and is characterized by a rapid movement of the elevator from the full nose-down position to the full nose-up position at or near its rate limit when the pilot relaxes his nose-down command. Overall, pilots needed to monitor angle of attack during recovery to ensure complete recovery.

Demonstration of Nose-Down Control Authority and Evaluation of Required Pitch Acceleration Criterion

Previous batch analysis of the nose-down control authority simulated ideal stall conditions when the aircraft was trimmed in straight and level flight. As a

result of the batch analysis, the Ref-H configuration was determined to be barely capable of generating acceptable levels of pitch acceleration at the maximum demonstrated angle of attack. However, during the course of piloted evaluations, the nose-down control performance indicated by the batch analysis was not being realized. Variations of certain key variables were observed that were the result of the piloting procedures specified for the stall maneuvers.

Key variables that affect the maximum pitch acceleration at a given angle of attack, such as airspeed, pitch rate, current pitch acceleration, and rate of change of angle of attack, were undergoing significant variations from the values assumed for the batch analysis. As a result, the data in figure 42 present optimistic vehicle performance. Results from actual real-time piloted evaluations were usually far below the predicted performance in figure 42.

Figure 47 presents data for a representative run for stall at idle power maneuver (task 5010). From this figure, the maximum amount of pitch acceleration generated during the recovery was achieved when the elevator and horizontal tail reached their position limits, which is indicated by the vertical line labeled "Recovery" in the figure. The low amount of pitch acceleration was caused by a combination of factors. At the point of recovery, a slightly higher angle of attack, approximately 22° , was reached, airspeed was almost 10 knots below the 1g trim speed as shown in figure 48, and the pitch rate was approximately -1 deg/sec; these conditions had an adverse impact on the amount of pitch acceleration available. From figure 42, a decrease of 1.0 deg/sec² in pitch acceleration was due to the increased angle of attack. The airspeed decrease of 10 knots in real-time data reduced dynamic pressure and pitch acceleration by an additional 15 percent. Analysis of the effect of pitch rate on pitch acceleration indicates that pitch acceleration was decreased approximately 0.1 deg/sec² for each 1 deg/sec of pitch rate. The combination of the angle of attack, airspeed, and pitch rate produced a predicted pitch acceleration of approximately -2.4 deg/sec², which is demonstrated by the data in figure 47.

During the course of this study, turning stall maneuvers produced varying results. Some pilots had no difficulty performing the turning stall maneuvers, whereas other pilots had great difficulty performing

the same maneuver. An attempt was made to determine the differences and reasons behind the discrepancies. The batch analysis of the LCDP parameter indicated a problem would exist for lateral maneuvering flight above an angle of attack of 19° . This was substantiated through a review and analysis of the real-time piloted data. Figure 49(a) presents angle of attack, pilot stick inputs (both longitudinal and lateral), and bank angle as functions of time for two attempts of task 5050. One of the attempts resulted in a complete departure of the vehicle (951129 run 027); the other, a normal recovery (951201 run 097). Figure 49(b) presents the additional information for sideslip angle and rudder deflection along with angle of attack for the same conditions as figure 49(a).

From these figures, even though the pilot-initiated recovery at an angle of attack of only 18° for the 951129 run 027, a large PIO developed. Examining the pilot stick inputs shows that for the 951129 run 027 data an aggressive lateral input to level the wings was issued by the pilot, simultaneously with a nose-down command, at around 51 sec into the maneuver. This input immediately caused sideslip to build up rapidly even though the rudder was moving at its rate limit to oppose the sideslip buildup, as shown in figure 49(b). The pilot initially was able to reduce angle of attack, but the lateral PIO that developed caused him to become distracted and not continue to force the nose down. Eventually, at time equal to about 65 sec, the stick was released completely; a longitudinal departure of the vehicle resulted. Conversely, in the maneuver attempt that resulted in a nominal recovery, 951201 run 097, the pilot issued a larger nose-down pitch command initially, followed by a delayed and much smaller lateral control input, as shown in figure 49(a). As can also be seen in figure 49(a), the pilot was able to smoothly reduce bank angle and level the wings. Figure 49(b) shows that for the nominal recovery run, sideslip angle was limited to approximately 5° with only 10° to 12° of rudder deflection. Overall, the effect of the recovery method significantly changed the resulting time history data and directly influenced the pilot ratings.

Cooper-Harper Ratings for Nonturning Stall Maneuvers

The resulting CHR ratings for the stall maneuvers are given in figure 50. The nonturning stall maneuvers

(tasks 5010 and 5020) received high Level I and low to mid Level II flying quality ratings for the longitudinal portions of the task. Some of the longitudinal ratings were influenced by the $\dot{\gamma}/V$ control law. Pilots commented that the longitudinal control law introduced problems regarding the control of airspeed decay during stall maneuver entries and also produced uncommanded nose-up elevator deflections during maneuver recoveries. These traits are considered to be highly undesirable for this class of maneuvers.

As pointed out in the discussion of figures 42 and 47, the effective pitch acceleration experienced by the pilots during the stall recoveries ranged from -2.0 to -3.0 deg/sec² due to nonideal recovery conditions. Only two pilots commented that the aircraft had any nose-down control power deficiencies for the nonmaximum thrust stall maneuvers (tasks 5010, 5040, and 5050). The maximum thrust stall maneuver, task 5020, was performed with the maximum takeoff mass case M13 and had ample control power available. The two pilots who did mention nose-down control power as an issue only indicated minor deficiencies existed, which could indicate that a pitch acceleration capability of -4.0 deg/sec² may not be required for this class of aircraft. The pitch acceleration requirement of -4.0 deg/sec² was determined from an extensive piloted analysis using fighter-type aircraft. All stall maneuvers were performed with the cockpit motion base inactive because of problems with its use for these large-amplitude, high-rate maneuvers. Lateral ratings for the nonturning RFLF maneuvers were generally Level I, with one pilot rating the lateral portion of the maximum-thrust stall maneuver (task 5020) a CHR of 4. These ratings reflect the fact that few lateral difficulties were encountered performing these maneuvers.

Cooper-Harper Ratings for Turning Stall Maneuvers

The CHRs for the turning RFLF maneuvers were considerably higher than for the nonturning with CHR ratings well into the Level II range and Level III flying quality ranges. (See fig. 50.) Pilots frequently had difficulty controlling the vehicle during recovery from turning flight at high angles of attack. These difficulties correlated well with the stability and control analysis performed by using LCDPs. Individual pilot recovery techniques employed during the recoveries of the turning stall maneuvers had a large effect on the

resulting aircraft response. Limited lateral control inputs were required for flight at angles of attack above 19°.

Engine-Out Stall (Task 7070)

Task 7070 represented a straight-ahead stall with asymmetric power (number 4 engine at idle thrust). Despite a design goal for the lateral-directional control law to maintain low sideslip angle, four of the five pilots observed a PIO or departure from controlled flight during the recovery pushover on at least one run; this led to high Level II ratings in the lateral directional axes. (See fig. 50.) A time history of a typical run is shown in figure 51; a PIO is evident from the pilot's lateral input in figure 51(a) as well as the oscillation appearing in figure 51(b) in the trailing-edge devices around 80 sec into the run.

Engine-Out Turning Stall (Task 7080)

Task 7080 was a repeat of task 7070 with a 30° bank toward the dead engine (right bank angle). As in previous maneuvers involving recovery from limit angle of attack, these recoveries were begun at an angle of attack of 21°. Some pilots were more successful at recovering from this stall by being careful not to make inputs in the lateral axis until airspeed was increasing; others had more difficulty. Some sensitivity to deceleration rates was noted. High Level II ratings were assigned for the lateral directional axes. (See fig. 50.) Figure 52 shows an example of this maneuver in which the aircraft departs from controlled flight, as evidenced by the angle-of-attack trace exceeding 100° in figure 52(c). Figure 53 gives an example time history for this maneuver in which the aircraft is successfully recovered from the stall. Comparing figure 52(a) with figure 53(a), a major difference can be seen in pilot technique between departure and successful recovery providing nose-down pitch input prior to rolling the wings level.

Diving Pullout (Task 5060)

Task 5060, a simulated certification maneuver, highlighted some difficulties with power changes in cruise conditions coupling into the pitch axis of the control law, as well as the need to reconsider this demonstration maneuver for supersonic aircraft. From level flight at Mach 2.4, a pushover to a 7.5° dive was

initiated at normal acceleration levels of approximately 0.5g, and this flight path was maintained until Mach 2.5 was reached. At that point the pilot was to bring the throttles to idle and simultaneously attempt to pull the aircraft out of the dive at a normal acceleration level of 1.5g. Figures 54 and 55 show an example of this maneuver.

Problem areas were uncovered in performing this maneuver: the engine inlets would unstart during the pushover; a coupling between large throttle inputs and longitudinal acceleration existed, leading to very large normal acceleration excursions, which is a problem with the gamma control response type in performing this maneuver.

Performing the initial pushover is not difficult, according to the pilots, although they all mentioned the need for acceleration onset (rate) information. The change in angle of attack at the inlet face of the engine associated with the 0.5g pushover, however, would unstart the inlets, rendering the remainder of the task meaningless. This task was therefore performed with the logic associated with simulating an unstart disabled so that the engine inlets would artificially remain started (normal shock remaining in the inlet) for the complete maneuver.

When the target Mach was reached, the pilot would retard the throttles rapidly (a throttle “chop”). The throttle chop inevitably resulted in an uncommanded pitch down of the aircraft, which appears to have been caused in part by the control law design. The design of the $\dot{\gamma}/V$ control law included a direct signal path from longitudinal acceleration to the elevator, which caused a large degree of thrust-to-pitch coupling to be apparent at this Mach. As shown in figure 54(a), the elevator is deflected trailing edge down (positive) in response to the throttle chop without a change in the pilot stick position.

A pullup was usually initiated simultaneously with the throttle chop; however, the only (immediate) effect of pulling aft on the control stick was to drive the commanded flight-path marker (displayed on the HUD) upwards. This effect occurred while the vehicle was pitching down and actual flight path was decreasing in response to the throttle chop, leading to what the pilots termed a “split” between actual and commanded flight path. This split was very confusing to the pilot when experienced for the first time. Figure 55(a) shows one pullout maneuver in which the stick is

pulled aft at the same time as the throttle chop; figure 55(b) shows a significant difference between commanded flight path and actual flight path starting at about 40 sec into the maneuver.

After the transient pitchdown from the throttle chop, the control law would then attempt to correct what was now a large flight-path error by pitching up rapidly, and a large positive acceleration level would be observed in most runs (except when the pilot avoided commanding a large “split” between commanded and actual flight path, as shown in both figs. 54(b) and 55(b)). This response could, in some runs, exceed the positive structural limit of the vehicle. Only by carefully modulating the control stick and allowing only a small disparity between actual and commanded flight path could large positive normal accelerations be avoided. This careful modulation is expected to be unrealistic to perform in an operational vehicle; however, with practice the pilots were able to attain adequate performance in the longitudinal axis (maximum load factor of $\pm 0.5g$ for target), leading to a mid Level II rating (two pilots gave it a Level III rating). All pilots found only minor problems in the lateral directional axes, giving consistent Level I ratings to this task. The CHRs for this task are found in figure 50.

Operations After Failure and Upset Recovery

Ripple Unstart (Task 7060)

Task 7060 simulated an inboard engine failure coupled with inlet unstarts on the inboard and neighboring outboard engines at cruise conditions. The pilot was asked to damp resulting aircraft dynamics and restore the aircraft to an appropriate flight condition. These tests were performed with motion cueing disabled because of large amplitude accelerations that were not reproducible by the motion cueing system. Sample time histories of this maneuver are found in figures 56 and 57. In these maneuvers, engine 3 was failed and the inlets of engines 3 and 4 were artificially unstarted and then the inlet of engine 4 was allowed to restart.

During the course of the evaluations, this failure–ripple-unstart combination inevitably resulted in sympathetic unstarts of all engines, probably because of excursions in angles of attack and sideslip at the inlet

face (as Mach increases, the acceptable cone angle for local flow at each inlet narrows). Also the appropriate pilot response was to (1) damp resulting yawing and pitching motions, (2) maintain altitude, (3) bring all four throttle levers to idle, (4) wait for Mach to decay below Mach 2.2, (5) gradually bring up the “good” inboard engine throttle levers, and (6) bring up the outboard engine throttle levers. At this point, the task was terminated, and the pilot was asked to evaluate the maneuver according to the evaluation criteria.

If the throttles were brought up too quickly (before inlet flow conditions allowed a restart), a vibratory response in engine thrust was experienced (as shown in the gross thrust trace of engine 2 in fig. 56(c)). Flight conditions above Mach 2.2 appear to make it difficult to restart the inlets of the operational engines in this configuration.

Several pilots commented on the unpredictability of sideslip control through rudder pedals, and some evidence of this appears in the maneuver, as shown in figure 56. At 35 sec, a sharp increase in sideslip angle (fig. 56(e)), bank and heading angles (fig. 56(f)), and lateral acceleration (fig. 56(g)) appeared but was not caused by pilot or control system inputs (figs. 56(a) and (b)); this uncommanded motion remains unexplained.

Another simulation anomaly is apparent during this maneuver. The engine model gives an increase in thrust in the remaining good engines when the inlets first unstart (see the gross thrust signal traces in fig. 56(c) at 5 sec and similarly in fig. 57(c) at 7 to 10 sec); this increase in thrust is believed to be caused by an error in the engine model.

The pitch-down and low acceleration spike at engine unstart, evident at 5 sec in figures 56(f) and (g) and at 10 sec in figures 57(f) and (g) is due to an anomaly in the longitudinal control system described in the section “Diving Pullout (Task 5060)”; this large acceleration excursion led pilot C to give the longitudinal task a Level III rating of 7, and pilot D rated the longitudinal task an 8. (See fig. 50.)

Pilot comments and ratings indicated this task to be a Level II to III. One pilot noted that some better annunciation of which engine had failed would be useful and commented that the stick force per g was

too light; this comment was made in many of the high-speed tasks. Several pilots commented that the rudder pedal forces were too high. Pilot D said the workload was probably CHR 5, but the criteria-based performance (due in part to the longitudinal control law anomaly and the inability to control sideslip adequately with rudder) led him to rate both axes Level III.

Inadvertent Speed Increase (Task 6050)

Task 6050 simulated a certification maneuver that began at cruise conditions and involved pushing the nose over at a specified normal acceleration level, counting 5 sec, and then initiating a 1.5 g pullout. This task was performed without motion cues and with the engine inlet unstart feature disabled because inlet unstarts were experienced consistently during the pushover maneuver during pretest checks. A typical time history of this maneuver is found in figure 58.

The only difficulty most pilots indicated in performing this task was judging normal acceleration rates of increase and decrease because of the inadequate cues provided by the numerical acceleration display on the HUD. The single numeric performance standard of not exceeding M_d led to the CHR of 1 by pilot B. Pilot D declined to rate this task but stated “doesn’t appear difficult to perform.” This task appears to be Level I, but the task definition needs improvement with some additional performance standards beyond maximum Mach. An analog readout of g could also improve the ability of a pilot to perform the task with precision. Some pilots mentioned that the stick force per g needs to be increased, and complaints about the HUD format were also made (too large a scan pattern to take in sideslip, g , and flight-path angle). (See fig. 50 for CHRs for this task.)

Two-Axis Upset (Task 6060)

Task 6060 was similar to task 6050. This task simulated another certification maneuver in which the aircraft is placed in an unusual attitude (nose-down 6° and bank angle of 15°) at cruise Mach and altitude conditions from which a 1.5 g recovery is made. This task was performed without motion cues and with the engine inlet unstart feature disabled because inlet unstarts were experienced consistently during the pushover maneuver during pretest checks. A typical time history of this maneuver is found in figure 59.

Fairly consistent Level II pilot ratings were assigned this task by most pilots. They complained of the lack of an analog readout for g and realistic motion cues to judge the rates of pushover and pullup, and stick forces were mentioned again as being too light. The CHRs for task 6060 are found in figure 50.

Directional Control With One Engine Inoperative (Task 7010)

Task 7010 was to evaluate the controllability of the configuration at low speed in high sideslip conditions by requiring the pilot to make wings-level (flat) turns with a heading change of 15° in less than 20 sec while maintaining airspeed and altitude. These maneuvers were performed without motion cues because of limitations of the motion platform. Typical time histories are found in figures 60 and 61.

This task was flown in the “backside” flight regime, which complicated the longitudinal task, leading to Level II pilot ratings. Two pilots indicated that the high friction level of the manual throttle quadrant had an effect on their longitudinal ratings. (The friction level of the quadrant used in this study was not adjustable.) Figure 60(c) shows airspeed variations by one pilot as much as 20 knots around the desired target equivalent airspeed of 167 knots; figure 61(c) shows that another pilot was able to hold the airspeed within ± 8 knots of the desired 167 KEAS.

On several runs lateral control was lost. Figure 60 is an example of a departure during this maneuver. Figure 61 is an example of a successful maneuver. The task was given Level III ratings by three pilots who experienced departures and Level II ratings by those that did not; these ratings indicate a flying qualities “cliff” in the lateral axis. Figure 50 contains the ratings for task 7010.

Lateral Control With One Engine Inoperative (Task 7020)

Task 7020 was flown with the same initial condition as task 7010, except that the heading changes were affected by coordinated turns. For consistency, this task was performed with the motion base off. A typical time history is found in figure 62.

This task, which consisted of making heading changes with coordinated turns, was considered much easier than task 7010; this opinion is reflected in the

borderline Level I to II ratings in both sets of CHR. (See fig. 50.) Again the throttle friction was cited as detracting from potentially better ratings longitudinally. Two pilots indicated problems with the roll response at this flight condition, which one characterized as “abrupt” and the other as “having too much residual roll” and “roll rate not snubbing quickly enough.”

Minimum Control Speed in Air (Task 7040)

Task 7040 was a demonstration of minimum control speed in air in the climb configuration. The task was set up by having the pilot perform a maximum performance takeoff at a low weight condition, followed by an aggressive climb to decelerate to the target demonstration airspeed of 120 knots. At this airspeed, the right outboard engine was failed and the pilot would attempt to maintain control of the aircraft while lowering the nose to increase airspeed to 140 knots. A maximum heading and bank angle deviation was specified. Motion cues were not provided for this task because of motion platform performance limitations. A typical time history is given in figure 63.

Several pilots commented on the inappropriateness of trying to control pitch attitude (during the deceleration) with a flight-path control law; this combination affected the longitudinal ratings to an unknown degree. One pilot (pilot A) demonstrated a PIO could be entered if sideslip (displayed on the HUD) was controlled tightly but could be avoided if sideslip angle was ignored. Pilot A experienced several PIOs and assigned this task a Level III rating; the other pilots tended to assign Level I to II ratings. (See fig. 50.) Overall this task may be considered Level II. A speed V_{mca} of 120 knots was demonstrated.

Center-of-Gravity Shift at High Speed (Task 6040)

Task 6040 consisted of a demonstration of the robustness of the control law to variations in longitudinal cg at cruise conditions; this simulated a runaway fuel transfer pump. The cg was moved (mathematically) forward at a constant rate until the vehicle became uncontrollable; then the task was repeated while the cg was shifted aft at a constant rate.

Forward centers of gravity ahead of 0 percent \bar{c} were imposed until nose-up-elevator-stabilizer authority was exceeded. Aft centers of gravity

between 73 and 75 percent led to an abrupt longitudinal instability that exceeded the structural limits of the airframe. Between these two extremes, very few differences were apparent in the response of the vehicle in all axes except for a gradual decay in airspeed due to increased trim drag. When the simulation was flown hands-off, the $\dot{\gamma}/V$ control law was self-trimming and maintained flight path as long as it had adequate control authority.

No CHRs were collected for this demonstration. This task was run with the engine complexity flag set to 4 to avoid inlet unstarts that were experienced during checkout runs.

Trajectory Management

Profile Climb (Task 3030)

Task 3030 represented an attempt to follow a flight path to cruise conditions immediately after takeoff in a fuel-optimal fashion. The task was performed with motion cues on and with inlet unstarts enabled. The desired trajectory was precomputed and displayed on the VHD along with actual and forecast trajectory and present position. In addition, the flight director symbol was presented on the HUD and displayed a recommended flight path to intercept and track the desired trajectory. (No directional steering information was presented, however.) The optimal trajectory required a subsonic acceleration to intercept and follow the V_{mo} boundary, a small loft and transonic pushover to supersonic conditions, followed by flight along the V_{mo}/M_{mo} boundary after accelerating beyond Mach 1.0.

The longitudinal task was to follow the projected optimal trajectory by using the VHD and the flight director. Pilots did not find this task difficult to perform, with the exception of what appeared to be too much breakout in the longitudinal axis of the stick. One pilot noted that it was difficult to make small corrections in vertical flight-path angle due to the extent of the longitudinal breakout.

The lateral-directional task was to maintain runway heading within 2° (desired) and bank angle within 5° (desired). The flight director provided no lateral steering information (commanded heading equaled current heading). With no bank angle, the velocity-

vector guidance and flight-path marker were coincident (if on the optimal trajectory). When the vehicle was banked, however, a difference arose between actual heading and actual horizontal flight-path angle proportional to angle of attack, and thus the pilot felt obligated to increase bank angle towards the correct “track” angle. This unintentional miscue led to several violations of the desired heading angle criteria. In addition, several pilots commented on a “jerky” motion cue when making small bank angle inputs; the source of this discrepancy remains unresolved.

Originally this task was scheduled to require approximately 40 min from takeoff to reaching initial cruise at Mach 2.4; however, checkout sessions showed that the simulated aircraft lacked enough excess thrust to be able to reach cruise conditions. This discrepancy appears to have been caused by a problem with the engine model. As a result, this particular task in most attempts was ended after about 27 min, at approximately Mach 1.4. One attempt was made to get through the engine problem by diving beyond V_{mo} without success.

Figure 64(a) shows samples of the longitudinal trajectories flown, with an expanded view about the envelope at Mach 1 and altitude of 30 000 ft in figure 64(b). As can be seen in these diagrams, the pilots were able to follow the precomputed trajectory fairly easily up until the thrust level decayed at Mach 1.4. (The attempts to dive through the barrier at Mach 1.4 are displayed as well as nominal runs.) In figures 65 and 66, the subsonic performance of the real-time nonlinear simulation was higher than forecast by the optimal trajectory generator, as evidenced by the transonic pushover occurring approximately 100 sec earlier than precomputed.

The difficulty in accelerating beyond Mach 1.4 in this task was investigated, and a problem in the thrust calculation of the engine model was uncovered. Figure 67 shows the results of a Mach sweep at constant altitude and angle of attack of 4° for both the “simple” (i.e., always started) and “complex” (i.e., unstarts enabled) inlet model options; a large thrust deficiency appears between Mach 1.4 and 1.5 for the complex inlet (unstarts enabled). The thrust deficiency is believed to be the cause of the inability to accelerate and climb beyond Mach 1.4. This anomaly did not affect any of the other tasks, however.

Up until this thrust deficiency occurred, following the precomputed climb profile using the VHD and HUD guidance elements was not difficult (aside from the directional steering miscue mentioned previously). The guidance algorithms for this task are given in appendix E.

With only a small amount of variability, the pilots rated this task borderline Level I to II in longitudinal axis and Level II in the lateral directional axes. (See fig. 50.)

Emergency Descent (Task 5070)

The final trajectory management task (task 5070) was to perform an emergency descent procedure, initiated from final cruise conditions, after the introduction of a simulated cabin breach and loss of pressure through a fixed-diameter exit. A simple isentropic flow nozzle was modeled with a throat area of 1 ft^2 and with the assumptions: cabin volume was 30000 ft^3 , initial cabin pressure altitude was 8000 ft, and cabin environmental control system could replenish one quarter of the cabin air each minute at all conditions. The goal was to meet the proposed Notice of Proposed Rulemaking (NPRM) values of maximum cabin altitude to remain below 40000 ft and for the cabin altitude to exceed 25000 ft for no more than 2 min (ref. 16). The calculations for cabin pressure dynamics are found in appendix F.

The emergency descent procedure followed by all pilots was to roll the airplane to maximum bank (limited to 35° by the control law) into a spiral dive at V_{mo} while simultaneously bringing all throttles to idle.

The VHD was used to monitor the approach to, intercept of, and tracking of V_{mo} as a function of altitude. One pilot suggested that normal acceleration limits be depicted about the predicted flight-path symbol. Several pilots noted that the predicted flight-path symbol was too active. This activity was due to turbulence affecting the prediction, which used unfiltered normal acceleration and airspeed to predict the trajectory 40 sec ahead of present location on the VHD. Table 7 gives values of V_{mo} and V_d for the Ref-H configuration that were design requirements at the time of this study.

Descents in which the inlets were intentionally unstarted for the entire descent were attempted, and a few runs were made in which the landing gear was extended to simulate activating a drag-producing device. Figure 68 shows the maneuver that provided the quickest descent, which included extension of the landing gear and a spiralling descent. Figure 69 shows the same trajectory relative to the airspeed-altitude envelope of the vehicle. In this run, the cabin altitude exceeded 25000 ft for 139 sec. (See fig. 68(f).) The aerodynamics related to extending the landing gear in supersonic flight were not correctly modeled in the Cycle 2B release of the simulation. Landing gear drag coefficient was a function of angle of attack alone. At V_{mo} of 475 KEAS, landing gear extension added an additional drag force on the order of 40000 lb to the basic vehicle aerodynamics. This additional drag force corresponded to an increase in drag coefficient of 0.0074.

In every attempt the cabin altitude ceiling of 40000 ft was avoided; however, the second constraint of remaining above the cabin altitude of 25000 ft for less than 2 min was not met on any attempt with any technique that remained within the flight envelope of the aircraft (for the assumed cabin rupture dynamics outlined in appendix F). Allowing a steeper bank angle during an emergency descent might prove a partial solution or adding additional drag through increased flap deflections.

From a control standpoint, this maneuver was considered Level I by all but pilot A, who had difficulty judging the intercept to limits of V_{mo} . Figure 50 contains the CHRs for task 5070.

Profile Descent (Task 3050)

Task 3050 simulated the execution of a descent to the terminal environment from final cruise conditions. A typical time history is shown in figure 70, and a plot of the trajectory relative to the aircraft flight envelope is shown in figure 71. All pilots commented on the usefulness of the VHD presentation. Pilot B noted that pitch attitude remained between 4° and 7° below the horizon during the entire descent. Pilot C noticed a difficulty in making small changes to flight path because of large breakout forces, and pilot D missed having guidance information on the HUD. Pilot E noted a moderate workload to stay on path. This task

was run with the engine inlet unstart model disabled to avoid inlet unstarts that were experienced during checkout runs. The CHRs for task 3050 are found in figure 50.

Climb, Cruise, and Descent

Transition to Level Flight (Task 3020)

Task 3020 represented a leveling off at subsonic speeds with a typical time history found in figure 72. Pilot A found the stick forces to be too low and had difficulty meeting the criteria for g . Pilot C encountered some undesirable throttle to pitch coupling. Pilot D had difficulty with airspeed control because of an error in implementation of the display of airspeed error on the HUD: the acceleration diamond registered nonzero acceleration while climbing at constant Mach. Overall the pilots rated this maneuver Level II longitudinally and Level I in the lateral directional axes. (See fig. 50.)

Transition to Supersonic Cruise (Task 3022)

In task 3022, the pilots were asked to level off from a climb at supersonic cruise conditions. Figure 73 shows a typical time history for this maneuver. Pilot A found the stick forces to be too low and workload to keep heading within specified bounds to be moderate. Pilot D noted the discrepancy on the acceleration diamond on the HUD. Pilot E did not evaluate this task. This task was run with the engine inlet unstart model disabled to avoid inlet unstarts that were experienced during checkout runs. CHRs for this task are in figure 50.

Level Flight Transition to Climb (Task 3040)

Task 3040 called for the initiation of a climb of 1500 ft/min from low subsonic cruise conditions of 10000 ft and 250 KEAS while maintaining airspeed in the climb. A typical time history is found in figure 74. Pilot B found that precise control of rate of climb required moderate effort. Pilot C noted the absence of tick marks at 1500 ft/min on the vertical speed meter. Pilot D did not evaluate this task. See figure 50 for CHRs.

Transition to Supersonic Descent (Task 3060)

Task 3060 required the pilots to initiate descent rates of 1000, 2000, and 4000 ft/min from supersonic cruise conditions. A sample time history of a 4000-ft/min trial is found in figure 75. Pilot E described the stick as very sensitive: ± 200 ft/min resulted from putting a “breath of air” on the stick. Pilot D did not evaluate this task. This task was run with the engine inlet unstart model disabled to avoid inlet unstarts that were experienced during checkout runs. CHRs are found in figure 50.

Transition to Transonic Descent (Task 3062)

Task 3062 duplicated task 3060 except that the descents were initiated from high subsonic (Mach 0.95) conditions. Pilot E noted a strong coupling between throttle and pitch attitude; this is probably related to the control law anomaly described in the diving pullout task (task 5060). Pilot D did not evaluate this task. A sample time history in which the pilot stabilized at descent rates of 1000, 2000, and 4000 ft/min in sequence is shown in figure 76. The CHRs are given in figure 50.

Airspeed Change in Subsonic Climb (Task 3070)

Task 3070 called for a change in airspeed from 250 to 350 KEAS while maintaining a climb of 1500 ft/min, starting at 10000 ft. Pilot A noted a high workload associated with maintaining vertical speed but rated it Level I regardless. Pilot E noted as much as 1.5° split between commanded and actual flight path due to throttle activity. Pilot D did not evaluate this task. A sample time history is found in figure 77, and CHRs are given in figure 50.

Transonic Deceleration (Task 3074)

Task 3074 called for a deceleration from Mach 0.99 to Mach 0.9 and an acceleration back to Mach 0.99, while in level flight at 41000 ft. Pilots A and E complained about the coupling between throttle activity and flight-path motion. Pilot D did not evaluate this task. A sample time history is found in figure 78, and CHRs are in figure 50.

Airspeed Change in Low Altitude Cruise (Task 3076)

Task 3076 was a change in airspeed from 350 to 250 KEAS and an acceleration back again to

350 KEAS while in level flight at 35000 ft. Pilots A and E again mentioned the coupling of throttle motions to flight path, which is believed to be the same anomaly reported in the diving pullout task (task 5060). Pilot C noted that “chasing altitude was more demanding” in awarding this a CHR of 4 longitudinally. (See fig. 50.) Pilot D did not evaluate this task. A sample time history is found in figure 79.

Heading Change in Transonic Climb (Task 3080)

Task 3080 was to make heading changes of 30° using bank angles of 15° and 35° at high subsonic climb conditions, while maintaining a climb of 2000 ft/min and Mach 0.92. Pilot A noted high stick roll forces and unusual cockpit motion cues. Pilot C noted the absence of roll index ticks at 35° on the HUD and primary flight display. Pilot E noted excessive workload in the roll axis. (See fig. 50 for ratings.) A sample time history is shown in figure 80. As shown in figures 80(c) and (d), maintaining Mach and climb rate during the steeper turns of 35° was not possible even with full throttle (fig. 80(a)).

Heading Change in Supersonic Cruise (Task 3084)

Task 3084 called for heading changes of 20° using bank angles of 15° and 35° at final cruise conditions. Pilot A found the use of the heading readout misleading because of angle-of-attack difference (at nontrivial bank angles) and tended to roll out early. Pilot C noted a high breakout in the lateral axis of the control stick. Pilot E rated this task a CHR of 4 because of sideslip excitation during rollout of 35°. All pilots noted insufficient power to maintain Mach and altitude in a bank turn of 35°, as shown in figure 81. This task was run with the engine inlet unstart model disabled to avoid inlet unstarts that were experienced during checkout runs. (See fig. 50 for CHRs.)

Heading Change in Low-Altitude Cruise (Task 3086)

The heading change of 60° with a bank angle of 30° in task 3086 was performed at 15000 ft and 350 KEAS. Pilot C indicated a jabbing technique was required on the side-stick inceptor. Pilot D missed having a velocity-vector guidance marker on the HUD and noted a tendency for roll rate to “coast” and damp poorly; this led to a small PIO tendency. Pilot E noted the control law did not want to hold the desired bank angle. Maintaining airspeed was not a problem at this

subsonic flight condition, however. A typical time history from pilot E is shown in figure 82, and the CHRs are given in figure 50.

Heading Change in Terminal Control Area (TCA) Descent (Task 3088)

The final heading change evaluation in task 3088 called for a heading change of 90° using bank angles of 15° and 35°, during a 1000 ft/min descent at 250 KEAS starting at 10000 ft. Pilot A complained of large forces required (using his right arm) to make throttle changes compared with light stick forces (left arm) and noted that he was using the wrong arms for fine and coarse control (pilot A was right-handed). Pilot E noted the throttle to flight-path coupling was a nuisance and did not like the imprecision of bank angle hold. Pilot D did not evaluate this task. A typical time history for a maneuver with bank angle of 35° is found in figure 83. The CHRs are given in figure 50.

Miscellaneous Task

Configuration Change in Straight Flight With Moderate Turbulence (Task 4012)

Task 4012 called for a level deceleration at 1500 ft from 250 to 157 KEAS while extending the landing gear, and then retraction of the gear and acceleration back to 250 KEAS. The design of the control laws should have made this a hands-free task because the $\dot{\gamma}/V$ control law provided both flight-path command and airspeed control (through the autothrottles). However, most pilots (except for B) stayed in the control loop, noted some wandering of flight path and altitude during the maneuver, and chose to enter the pitch loop. Pilot C commented on an “annoying pitch bobble” in response to autothrottle activity. Pilot E said it took a “great deal of effort” to maintain altitude within the desired range of ± 50 ft. Pilot D did not evaluate this task. Pilot B remained out of the loop and awarded this maneuver the only perfect rating (CHR of 1) of his evaluation. A typical time history from pilot E can be found in figure 84, and the ratings are found in figure 50.

Quantitative Metric

As an element of the High-Speed Research Program, this assessment was required to provide a

quantitative “score” or metric of the relative readiness of the aircraft configuration for production. This metric would allow subsequent assessments to track the progress in the maturity of design of the vehicle. Because the assessment was based upon preliminary data, this score should not be considered to reflect the preparedness of a real vehicle; however, a consistent measure of preparedness, based upon pilot ratings, of the current simulation is useful.

To generate such a metric, each task was assigned a target flying qualities level, that is, CHR Level I or Level II, based upon the anticipated frequency of that task being performed. Normal operational tasks were considered “common” and required to have Level I (i.e., $CHR \leq 3.5$) flying qualities; other tasks were judged to be “infrequent” or “emergency,” requiring Level II ($CHR \leq 6.5$) average handling qualities for the worst average segment CHR. The worst (numerically largest) pilot rating for any segment of each task was then selected. A CHR “deficiency” or difference between the worst CHR awarded by any pilot and the desired level boundary was calculated for any task that did not meet its required flying qualities level. These rating deficiencies were summed and divided by the number of tasks to obtain an average CHR deficiency of 1.47.

To calculate a relative score, a formulation was used that would generate a value between 0 and 100 percent, where 0 equates to some very bad (large) average CHR deficiency and 100 percent corresponds to all tasks having adequate pilot ratings. This formulation was obtained by using the exponential function of the negated average CHR deficiency, which yields a metric value of 23 percent for this assessment. The equation is given as follows with \vee representing taking the maximum selection:

For each task,

$$CHR_{\max} = \vee_{\text{Pilots}} \left[\vee_{\text{Segments}} (CHR) \right]$$

$$CHR_{\text{req}} = \begin{cases} 3.5 & (\text{task occurrence is common}) \\ 6.5 & (\text{task occurrence is infrequent or emergency}) \end{cases}$$

$$CHR_{\text{def}} = \begin{cases} 0 & (CHR_{\max} \leq CHR_{\text{req}}) \\ CHR_{\max} - CHR_{\text{req}} & (CHR_{\max} > CHR_{\text{req}}) \end{cases}$$

For the overall study,

$$\text{Metric} = \exp \left(\frac{\sum \text{CHR}_{\text{def}}}{n_{\text{tasks}}} \right)$$

To better understand the significance of this metric, some hypothetical results may be considered. If in a given study, the CHR deficiency for every task happened to be a full CHR level (3 CHR points), the metrical score would be 5 percent. If instead the CHR deficiency was only 1 CHR point for each task, the score would improve to 36.8 percent. If only *half* the tasks were 1 CHR rating point below the target level, this same formulation would yield a numerical score of 60.7 percent.

Appendix G gives the complete list of 51 tasks for which CHRs were obtained, as well as the classification of each task, the target flying qualities level, the maximum (worst) average CHR and appropriate assessed flying qualities level, and the rating deficiency in CHR units.

Summary of Results

The maneuver set developed for this study was considered to be a useful and comprehensive set of maneuvers that provided assessments over a broad range of operating and certification conditions. Only minor modifications to the maneuver set are envisioned to support future high-speed research (HSR) assessment efforts. Appendix H contains a list of lessons learned from this study that may assist in the design of future experiments of this nature.

Takeoff Tasks

Minor handling quality and performance deficiencies of the Ref-H configuration were observed for the takeoff maneuvers. These deficiencies involved inconsistent rotation performance and resulted from a combination of the modified $\dot{\gamma}/V$ control law and marginal longitudinal control power. The version of the $\dot{\gamma}/V$ control law used for the Ref-H assessment was not initially designed with takeoff rotations in mind. It was modified to perform adequately during real-time simulation evaluation runs. A larger elevator

and/or horizontal tail could alleviate the minor problems associated with takeoff rotations as well as with proper functioning of the vortex fence. The vortex fence was not active during takeoff operations because of an unchecked simulation implementation error. Further simulation runs made with the vortex fence operating correctly decreased deflections of horizontal tail and elevator approximately 10 to 20 percent. As a result of the vehicle tail strike limit, minimum unstick speed V_{mu} determined the minimum rotation speed with leading- and trailing-edge flaps set to 30° and 10° , respectively. However, the Ref-H vehicle was still capable of operating from a 10 000-ft long runway. If the requirement for a shorter runway emerged, improvements, such as different flap settings, gear lengths, could be made to the Ref-H vehicle to shorten the takeoff field length.

The longitudinal $\dot{\gamma}/V$ and lateral-directional p/β control systems worked adequately for the Ref-H assessment project. Some interpretation of results and detailed analysis of the real-time data were required to assess the unaugmented Ref-H configuration. Potential improvements to both the longitudinal and lateral-directional control systems were identified as a result of this study.

Regarding noise abatement procedures, the advanced PLR takeoff procedure would be required to meet the anticipated noise regulations. No handling quality problems were encountered performing either the standard or PLR acoustic procedures. Pilot comments generally indicated that the PLR procedure posed no serious handling quality problems and could be a viable takeoff procedure. Noise results indicated that the standard acoustic takeoff procedure will require significant noise suppression to decrease sideline noise to acceptable levels. Sideline noise also determined the amount of noise suppression required (13 dB, EPNdB) for the PLR procedure.

Approach and Landing Tasks

The automatic flap protocol used in this assessment involved configuring the aircraft for a low-speed, low-noise approach to an altitude of 390 ft, at which point the vehicle passes a critical noise-measuring station. Flaps and leading-edge devices were then automatically commanded to a high-lift, low-pitch attitude setting for the final flare and touch-

down; thereby tail strike concerns are reduced and an improved runway viewing angle is provided. Pilot comments and CHRs generally reflected acceptance of the automatic flap reconfiguration from a flying qualities perspective, although this acceptance was not unanimous. Several pilots also expressed concern regarding the safety issues associated with the automatic flap reconfiguration.

The most difficult landing tasks were those that stressed the lateral-directional control of the vehicle, particularly the lateral offsets and crosswind landings. Frequent instances of flaperon rate limiting were observed during these tasks after the automatic flap reconfiguration. After the automatic flap reconfiguration, remaining roll authority may be inadequate to reliably perform an aggressive maneuver such as the lateral offset landing task. A potential solution would be to allocate trailing-edge surfaces 2 and 7 as flaperons. A well-developed PIO was encountered in two instances during the 300-ft lateral offset landing tasks. Whether this PIO tendency is an artifact of the immature version of the lateral-directional control law or is indicative of inadequate roll authority after the automatic flap reconfiguration is unclear. This uncertainty suggests that future simulations of flying qualities and flight tests should closely examine aggressive lateral-directional tasks such as the lateral offset landing.

Difficulties were encountered during the final decrab maneuver in the crosswind landings, particularly in the 35-knot case, which highlight the need to examine crosswind landing procedures, control issues, and aerodynamic characteristics in greater detail. Touchdown performance for the 35-knot crosswind was usually outside adequate tolerances and sink rates were often excessive.

Those tasks designed to stress control authority (go-arounds, dynamic $V_{\text{mcl-2}}$, and landing with jammed control) were awarded relatively good CHRs, although occasional control surface rate limits were encountered. Pilot comments for the 30-ft go-around were positive regarding their ability to control the pitch-up and to rapidly arrest their descent.

Pilot comments indicate that the tasks conducted in degraded modes were challenging and seemed to be separated into two groups. The first group, including

the landing with jammed control, manual throttle landing, and all-engines-out landing, received borderline Level I to II ratings. No major control problems were revealed, although a higher workload was noted for these tasks. The manual throttle approaches on the backside of the thrust-required curve resulted in low Level II CHRs and did not seem to pose a major problem for this configuration.

The second group of landings in degraded modes included the inner-loop augmentation failures and received borderline Level II to III ratings. Severe increases in pilot workload were noted—to the point that momentary lapses of attention could have potentially disastrous results. This workload increase suggests that the dynamics of the bare airframe were at the threshold of the control capability of the test pilots and confirms the supposition that degradation to the bare airframe dynamics is not an acceptable failure condition.

Up-and-Away Tasks

Several tasks demonstrated the inappropriateness of a $\dot{\gamma}/V$ control law response type in which the pilot controls flight path instead of elevator position. In particular, the stall series (recovery from limit flight) as well as the minimum control speed in air task caused concern that the pilot had a high workload to control angle of attack through second-guessing the $\dot{\gamma}/V$ control law. This concern highlights the need for an angle-of-attack override or protection such that the control law reverts to more conventional control when near an angle-of-attack limit.

The target maximum demonstration angle of attack selected for the Ref-H assessment project was 21° and was based on preliminary evaluations of the stall flight tasks along with a minimum required demonstration speed $(V_{\min})_{\text{dem}}$ calculation. Control law anomalies combined with less-than-adequate pilot guidance frequently produced maximum angles of attack higher than 21° . Pilots could generally perform the maneuvers; however, some aircraft departures were experienced, especially for the turning stall tasks. Subsequent analysis of the real-time piloted data combined with a detailed evaluation of stability and control parameters suggests that the upper angle-of-attack limit for the Ref-H, as it is modeled in Cycle 2B, be set at 18° to 19° . This conclusion is

based on lateral-directional and longitudinal stability and control limitations.

The nose-down pitch acceleration capability of the Ref-H vehicle during the recovery portion of tasks 5010, 5040, and 5050 of the stall maneuvers was marginal based on batch analysis compared with a requirement for pitch acceleration of -4.0 deg/sec^2 . Piloted evaluations produced nose-down pitch accelerations significantly below batch analysis predictions because of nonideal recovery conditions. Pilots frequently experienced nose-down pitch accelerations that were only approximately 65 percent of the specified requirements. Pilot comments, however, did not indicate that the lack of effective nose-down pitch acceleration was a large concern and generally expressed comfort with the demonstrated performance, which indicates that the nose-down pitch acceleration criterion of -4.0 deg/sec^2 may be too high for this class of vehicle.

Of the tasks included in the up-and-away evaluation, perhaps the most important finding is the inability to match the performance targets for the emergency descent in spite of significant effort to allow the vehicle to descend quickly. Some means of providing additional drag and/or cabin repressurization will be required to meet the goal of allowing the cabin altitude to exceed a pressure altitude of 25000 ft for no more than 2 min following a hull breach at early cruise conditions. This condition is especially difficult to meet because the aircraft is relatively heavy, causing maximum operating speed V_{mo} to be reached at a shallower angle of descent.

Another area of concern is the apparent sensitivity of the engine inlets to moderate maneuvering. At cruise conditions, inlet unstarts were experienced for normal acceleration pushovers of 0.7g or higher as well as in response to an engine failure. Because of thrust-to-pitch coupling with this configuration, restarts of engine inlets were not possible until lower Mach was attained where the sensitivity of the inlet is lower.

The design of the $\dot{\gamma}/V$ control law included a direct signal path from longitudinal acceleration to the elevator, which caused a large degree of thrust-to-pitch coupling to be apparent at higher speeds. This coupling was highlighted in the diving pullout task, in

which the aircraft pitches down in reaction to a reduction in throttle while the pilot is commanding nose-up pitch; this led to a large discrepancy between commanded flight path and actual flight path. This error is eventually removed by the control law in a dramatic way; this led to unacceptable normal accelerations.

The lateral control axis experienced several PIOs and a few departures during engine-out stall recovery, engine-out directional control demonstration, and minimum control speed in air demonstration. These problems are believed to be caused by stability and control deficiencies of the Ref-H configuration at high angles of attack. In addition, the inability of the control law to damp small roll rates and hold bank angles was noted.

An inability to continue the initial climb to cruise conditions was caused by an error in the engine model.

Stick loading needs to be increased at higher Mach so stick force per g remains relatively constant; stick breakout forces need to be decreased to allow for precision maneuvering at cruise conditions.

Minor discrepancies in symbology include the lateral steering miscue in the profile climb task, the air-speed acceleration display discrepancy noted on several tasks, and the excessive throttle friction.

The use of a velocity-altitude envelope display facilitated the optimal climb and the profile and emergency descent tasks by providing flight-path prediction information. This prediction needs to be refined by adding filtering to remove noise and by adding information about normal acceleration limits.

Determination of Airspeeds

Demonstrations of minimum controllable airspeeds following an engine failure were performed for three scenarios: runway takeoff V_{mcg} , climb V_{mca} , and landing with one engine out V_{mcl-2} . In addition, several reference airspeeds were either calculated or referenced in the course of this investigation; table 8 contains the various airspeeds associated with this study.

Noted Deficiencies

The deficiencies, by task area uncovered in the course of this investigation, are as follows:

Takeoff deficiencies:

- Takeoff rotation

Marginal longitudinal control authority

Takeoff speed is tail-strike limited (V_r needs to be increased to 180 knots)

Approach and landing deficiencies:

- Automatic flap reconfiguration on final approach

Poses safety concerns

Pilot acceptance not unanimous

Resulted in vertical flight-path excursion (“ballooning”)

Requires manual thrust compensation when autothrottles are inactive

- Roll control power

Inadequate with leading-edge flap at 0° and trailing-edge flap at 30° ; suggests allocation of trailing-edge devices 2 and 7 as flaperons

- Crosswind landing

Control of decrab is difficult; appropriate decrab technique not determined

- Unaugmented airframe dynamics

Unacceptable failure condition

At threshold of control capability of pilots

Up-and-away deficiencies:

- Emergency descent

Insufficient drag devices to descend fast enough from cruise conditions without exceeding maximum operating speed V_{mo}

- Throttle-to-pitch coupling
 - Abrupt throttle motion leads to excessive normal forces
- Lateral-directional control
 - Loss of control during wings-level heading changes with one engine out
- Longitudinal control
 - Low-speed tasks show difficulties of controlling airspeed or angle of attack with $\dot{\gamma}/V$ control law
- Operation at required maximum angle of attack (i.e., 20°)
 - Lateral control becomes difficult if not impossible above angle of attack of 19° (LCDP analysis)
 - Nose-down pitch authority insufficient based on current specifications (i.e., pitch acceleration of -4 deg/sec^2) above angle of attack of 19°

Conclusions

Takeoff Tasks

1. Only minor handling quality and performance deficiencies of the Reference-H configuration were observed for the takeoff maneuvers. These deficiencies involved takeoff rotation performance and resulted from a combination of the control law, marginal longitudinal control power, and tail strike limits.
2. The takeoff field length of the Reference-H configuration was determined to be approximately 9400 ft for the takeoff mass case (M13). Reductions of takeoff field length could be accomplished through the incorporation of different leading- and trailing-edge flap settings or lengthening the main landing-gear struts, if required.
3. Pilots did not generally like the rotation guidance employed for this study. Improvements are considered mandatory.

4. Rotation speed V_r should be increased to approximately 180 knots to alleviate tail strike problems with the leading- and trailing-edge flaps in the current takeoff positions (i.e., leading-edge flap at 30° , trailing-edge flap at 10°). This change will affect the takeoff field length, however.
5. General pilot acceptance based on handling quality criteria of automatic thrust and flap deflection changes, as employed by the acoustic programmed lapse rate takeoff (task 2030), was obtained. Safety concerns regarding this maneuver were not addressed explicitly.
6. Noise results indicate the level of suppression required to meet future noise regulations can be reduced by approximately 7 dB through the incorporation of the acoustic programmed lapse rate takeoff profile maneuver (task 2030) as compared with the standard acoustic takeoff maneuver (task 2010).
7. Emergency takeoff maneuvers, such as rejected takeoffs (tasks 1050, 1051, and 1052) and one-engine-out takeoff (task 7035), were rated as borderline Level I to II Cooper-Harper rating. This rating is considered to be acceptable because these maneuvers simulate emergency conditions and only occur infrequently.
8. Minimum control speed on the ground V_{mcg} was determined to be 127 knots.

Approach and Landing Tasks

1. Use of automatic flap reconfiguration on short final approach resulted in a decrease in pitch attitude of approximately 6° and a concurrent increase in trim thrust of 12 percent. Pilot acceptance of the automatic flap reconfiguration at 390 ft above ground level as implemented in this investigation was not unanimous, and at least one pilot was strongly opposed to this practice. This procedure poses safety issues associated with reconfiguring so close to the ground.
2. The automatic reconfiguration frequently produced a positive vertical flight-path excursion as the aircraft descended below 390 ft, the altitude at which reconfiguration was initiated. This deficiency could be corrected by providing an automatic attitude compensation for the flap change.

3. The most difficult landing tasks were the lateral offsets and crosswind landings, which emphasized the lateral-directional control of the vehicle. Pilot control of the final decrab maneuver in the 35-knot crosswind landings was particularly difficult.
4. During the lateral offsets and crosswind landings, frequent instances of flaperon rate limiting were observed after the automatic flap reconfiguration; this indicated roll control power deficiency in the final approach configuration. Allocating trailing-edge surfaces 2 and 7 as flaperons instead of flaps would provide additional roll control authority during this phase of flight.
5. The Reference-H configuration falls in the Level II category according to the existing Military Specification (AFFDL-TR-69-72) criteria for backside landing operations. The manual throttle approaches on the backside of the thrust-required curve received borderline Level I to II Cooper-Harper ratings and did not pose a major problem for this configuration. However, pilots must be prepared to advance the throttles to compensate for the automatic flap reconfiguration when in manual throttle control.
6. Pilot comments and performance for the go-around of 30 ft reflect a positive ability to control the pitch-up and to rapidly arrest the descent. In no instances was a tail strike incurred. Other tasks designed to stress control authority (dynamic two-engines-out minimum control speed V_{mcl-2} on landing and approach and landing with jammed control) received borderline Level I to II ratings. Occasional instances of control surface rate limits were observed during these tasks, but no activity which consistently indicated a control power deficiency was apparent.
7. The dynamics of the unaugmented aircraft are at the threshold of the test pilots' control capability. Landing tasks which involved flight control augmentation failures received borderline Level II to III ratings. Severe increases in pilot workload were noted, to the point that momentary lapses of attention could have potentially disastrous results. Degradation to the unaugmented airframe dynamics is not an acceptable failure.

8. The minimum control airspeed with two engines out (V_{mcl-2}) was determined to be 140 knots.

Up-and-Away Tasks

1. The maximum required angle of attack, based on desired approach speed at which stabilized flight must be maintained, was determined to be 20° .
2. Based on batch analysis, the desired recovery pitch-down acceleration of -4.0 deg/sec^2 is achievable only up to an angle of attack of 19° .
3. Pilot comments did not generally support the prediction based on analysis that pitch acceleration was inadequate for stall recoveries. This lack of support implies that the pitch acceleration criterion of -4.0 deg/sec^2 is too high for transport aircraft.
4. The augmented Reference-H configuration becomes unstable at an angle of attack of 19° , based on an analysis of the lateral control divergence parameter. This instability indicates that lateral maneuvering flight above this angle of attack may not be possible.
5. The ripple unstart task demonstrated that an inlet unstart on an outboard engine would generate sufficient sideslip angle and angle-of-attack variations that the other engine inlets would unstart as well. In addition, manual attempts to perform inlet restarts were not successful above Mach 2.2.
6. Automatic compensation for engine inlet unstart is needed.
7. A loss of control was experienced in wings-level, uncoordinated turns with one engine out; this indicated a problem with the lateral-directional control law.
8. Throttle-to-pitch coupling was very high in cruise flight, which indicated a problem with the longitudinal control law.
9. Low-speed angle of attack and airspeed control is difficult.
10. Additional drag-generating devices are needed to assist in performing an emergency descent from cruise conditions to meet FAA guidelines for this maneuver.
11. Minimum control speed in air was determined to be 120 knots.

References

1. Boeing Co.: *Reference H License Agreement Between the Boeing Company and the National Aeronautics and Space Administration*. The Boeing Co., 1991.
2. Dornfeld, G. M.; Lanier, J. K.; Milligan, K. H.; Parker, J. M.; Phillips, B. A.; and Stephens, A. T.: *High Speed Civil Transport Reference H—Cycle 2B Simulation Data Base*. NASA Contract NAS1-20220, Boeing Co., 1995.
3. Jackson, Bruce; Glaab, Louis; Raney, Dave; Derry, Stephen; Kraft, Ray; Coleman, Ed; Ray, Jim; Princen, Norm; Preston, Jeff; Yingling, Dave; and Williams, Todd: *Reference H Assessment Summary*. Formal Report, Boeing Co., Mar. 8, 1996.
4. Kraft, Raymond; Duffy, Keith S.; Coleman, Edward E.; and Shaw, John L.: *Flight Control System for NASA Simulation*. HSCT-BE49B-L95-013,14 (Contract NAS1-20220), Boeing Co., Aug. 18, 1995.
5. Williams, Todd M.; Rossitto, Ken; and Von Klein, Terry: *Candidate Control Laws—Milestone Report*. CRAD-9408-TR-0977 (Contract NAS1-20220), McDonnell Douglas Aerosp., Sept. 30, 1995.
6. Grantham, William D.; Smith, Paul M.; and Deal, Perry L.: *A Simulator Study for the Development and Evaluation of Operating Procedures on a Supersonic Cruise Research Transport To Minimize Airport-Community Noise*. NASA TP-1742, 1980.
7. Olson, E. D.: *Advanced Takeoff Procedures for High-Speed Civil Transport Community Noise Reduction*. SAE Tech. Paper Ser. 921939, Oct. 1992.
8. Glaab, Louis J.; Riley, Donald R.; Brandon, Jay M.; Person, Lee H., Jr.; and Glaab, Patricia C.: *Piloted Simulation Study of the Effect of High-Lift Aerodynamics on the Takeoff Noise of a Representative High-Speed Civil Transport*. NASA/TP-1999-209696, 1999.
9. Riley, Donald R.; Glaab, Louis J.; Brandon, Jay M.; Person, Lee H., Jr.; and Glaab, Patricia C.: *Piloted Simulation Study of a Dual Thrust-Cutback Procedure for Reducing High-Speed Civil Transport Takeoff Noise Levels*. NASA/TP-1999-209698, 1999.
10. Zorumski, William E.: *Aircraft Noise Prediction Program Theoretical Manual*. NASA TM-83199, Part 1, 1982.
11. Noise Standards: Aircraft Type and Airworthiness Certification. Code of Federal Regulations, Part 36, Title 14 (Parts 1–59), FAA, Jan. 1996, pp. 719–791.
12. Chalk, C. R.; Neal, T. P.; Harris, T. M.; Pritchard, F. E.; and Woodcock, R. J.: *Background Information and User Guide for MIL-F-8785B(ASG), “Military Specification—Flying Qualities of Piloted Airplanes,” AFFDL-TR-69-72*, U.S. Air Force, Aug. 1969. (Available from DTIC as AD-860856.)
13. Ogburn, Marilyn E.; Foster, John V.; Nguyen, Luat T.; Breneman, Kevin P.; McNamara, William G.; Clark, Christopher M.; Rude, Dennis D.; Draper, Marjorie G.; Wood, Craig A.; and Hynes, Marshall S.: High-Angle-of-Attack Nose-Down Pitch Control Requirements for Relaxed Static Stability Combat Aircraft. *NASA High-Angle-of-Attack Technology Conference—Volume I*, J. R. Chambers, W. P. Gilbert, and L. T. Nguyen, eds., NASA CP-3149, Vol. I, Pt. 2, 1992, pp. 639–658.
14. Lutze, F. H.; Durham, W. C.; and Mason, W. P.: *Development of Lateral-Directional Departure Criteria*. NASA/LaRC Project NCC1-158, June 1992.
15. Grafton, Sue B.; and Nguyen, Luat T.: *Wind-Tunnel Free-Flight Investigation of a Model of Cranked-Arrow-Wing Fighter Configuration*. NASA TP-2410, 1985.
16. *Standards for Approval for High Altitude Operation of Supersonic Transport Airplanes*. Federal Register, vol. 54, no. 224, Nov. 22, 1989, pp. 48538–48546.

Table 1. Modified Thrust for Engine Out

Mach	Thrust, lb, at altitude of —		
	0 ft	2000 ft	4000 ft
0	0	0	0
0.1	-1429.9	-1329.5	-1234.9
0.2	-3011.8	-2800.3	-2601.0
0.3	-4901.1	-4556.9	-4232.6
0.4	-6878.9	-6396.0	-5940.7

Table 2. Body Coordinates Used To Determine Ground Strikes

Point	x, in.	y, in.	z, in.
Outboard nacelle	2710.5	±374.4	130.0
Wingtip	2654.4	±777.9	162.6
Tail skid	3435.7	0	269.5

Table 3. Reference-H Mass Cases

Mass case	GW, lb	I_{xx} , slug-ft ²	I_{yy} , slug-ft ²	I_{zz} , slug-ft ²	I_{xz} , slug-ft ²	cg, percent \bar{c}
Maximum takeoff weight, M13	649914	4552820	51814400	55762300	448324	48.1
Initial cruise weight, MIC	614864	4782250	50271800	54465000	361635	52.5
Final cruise weight, MFC	384862	3185260	43953900	46653700	155467	53.2

Table 4. Assessed Tasks

Task	Task name
Takeoff	
2010	Acoustic profile takeoff
2030	Acoustic PLR takeoff
1050	Rejected takeoff with 0-knot crosswind
1051	Rejected takeoff with 15-knot crosswind
1052	Rejected takeoff with 35-knot crosswind
7035	One-engine-out takeoff
7030	Minimum control speed on ground
Nominal approach, landing, go-around	
4020	Nominal approach and landing
4025	Nominal approach and landing with flight director
4050	Precision landing
4062	Landing from lateral offset with moderate turbulence
4066	Landing from lateral offset in visibility conditions with Category I, moderate turbulence
4072	Landing from vertical offset with moderate turbulence
4076	Landing from vertical offset in visibility conditions with Category I, moderate turbulence
4080	Go-around
4085	Go-around with minimum altitude loss
Approach and landing with weather and failures	
4090	Approach and landing with 15-knot crosswind
4095	Approach and landing with 35-knot crosswind
4100	Landing in Category IIIa visibility conditions
4110	Approach and landing with jammed control
7050	Dynamic V_{mc1-2}
7095	Manual throttle landing
7110	Unaugmented landing with longitudinal SCAS inoperative
7100	Unaugmented landing
7090	All-engines-out landing

Task	Task name
Trajectory management	
3030	Profile climb
5070	Emergency descent
3050	Profile descent
Recovery from limited flight envelope	
5020	Stall with maximum takeoff power
5010	Stall with idle power
5040	Turning stall with idle power
5050	Turning stall with thrust for level flight
7070	Engine-out stall
7080	Engine-out turning stall
5060	Diving pullout
Operations after failure, upsets	
7060	Ripple unstart
6050	Inadvertent speed increase
6060	Two-axis upset
7010	Directional control with one engine inoperative
7020	Lateral control with one engine inoperative
7040	Minimum control speed in air
6040	Center-of-gravity shift at high speed
Climb, cruise, descent	
3020	Transition to level flight
3022	Transition to supersonic cruise
3040	Level flight transition to climb
3060	Transition to supersonic descent
3062	Transition to transonic descent
3070	Airspeed change in subsonic climb
3074	Transonic deceleration
3076	Airspeed change in low altitude cruise
3080	Heading change in transonic climb
3084	Heading change in supersonic cruise
3086	Heading change in low-altitude cruise
3088	Heading change in TCA descent
Miscellaneous tasks	
4012	Configuration change in straight flight with moderate turbulence

Table 5. Takeoff Performance Data

Parameter	Acoustic profile takeoff (task 2010)		Acoustic programmed lapse rate takeoff (task 2030)		One-engine-out takeoff (task 7035)	
	14 samples		11 samples		13 samples	
	Mean	σ	Mean	σ	Mean	σ
x_{10} , ft	6486	143	6880	68	6794	246
V_{10} , knots	198	2.2	199	1.0	190	2.7
θ_{max} , deg	10.2	0.36	10.0	0.24	10.6	0.53
x_{obs} , ft	7942	413	9077	1089	9389	560
V_{35} , knots	209	5.0	213	6.6	201	3.5

Table 6. Recovery From Limited Flight Task Scenarios

Task	Mass case	Thrust	Type of entry
5010	Final cruise weight, MFC	Idle	Nonturning
5020	Maximum takeoff weight, M13	Full thrust	Nonturning
5040	Final cruise weight, MFC	Idle	Turning
5050	Final cruise weight, MFC	Thrust for level flight	Turning

Table 7. Design Maximum Operating and Diving Speeds
for Reference-H Configuration

Altitude, ft	V_{mo} , KEAS	V_d , KEAS
0	350	420
25500	350	420
29300	350	452
40200	427	545
47000	475	545
52839	475	545
53000	475	543
54000	475	530
55000	475	518
55244	475	515
56000	466	505
57000	455	493
58000	445	482
59000	434	470
60000	424	459
61000	414	448
62000	404	438
63000	395	428
64000	385	417
65000	376	408
66000	367	398
67000	359	389
68000	350	379
69000	342	370
70000	334	362
71000	326	353
72000	318	345
73000	311	337
74000	304	329
75000	297	321
76000	290	314
77000	283	307
78000	276	299
79000	270	293
80000	264	286

Table 8. Reference Speeds Used in or Determined From This Assessment

Speed	Definition	KEAS
V_1	Takeoff decision speed	166
V_2	Engine-out safety speed	209
V_{35}	Speed at 35-ft obstacle height	See table 5
V_{app}	Approach speed	157
V_c	Commanded climb speed	Varied per task
V_d	Maximum diving speed	See table 7
V_{lo}	Liftoff speed	See table 5
V_{man}	Maneuvering speed	133
V_{mca}	Minimum control speed in air with one engine out	120
V_{mcg}	Minimum control speed on ground with one engine out	127
V_{mc1-2}	Minimum control speed in landing configuration with two engines out	140
$(V_{min})_{dem}$	Minimum required demonstration speed	123
V_{mo}	Maximum operating speed	See table 7
V_{mu}	Minimum unstick speed in takeoff configuration	182
$V_{(L/D)max}$	Velocity for maximum lift-to-drag ratio in approach configuration	See figure 37
V_r	Takeoff rotation speed	174

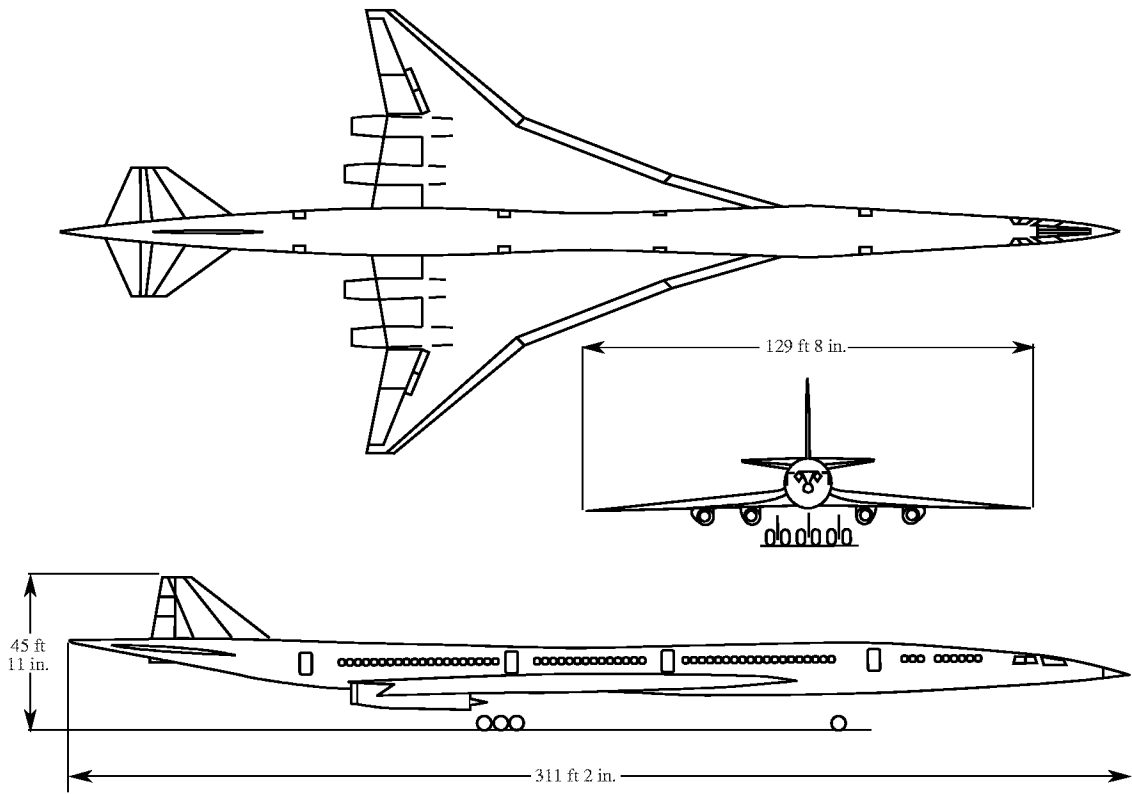

(a) Three-view drawing.

Figure 1. Reference-H configuration.

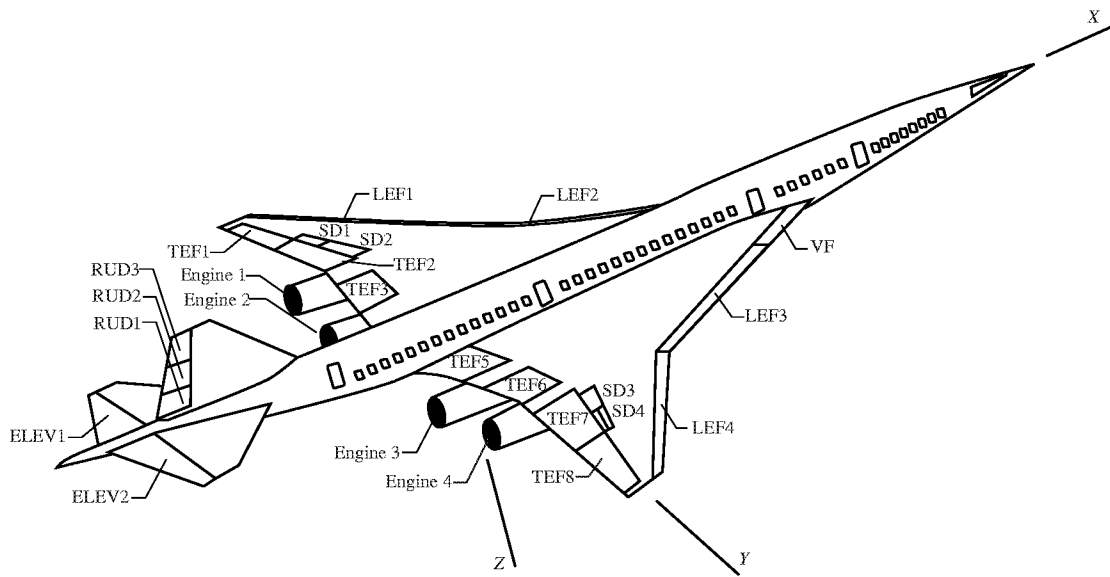

(b) Three-quarter rear view showing control surface identifications and axis systems employed.

Figure 1. Concluded.

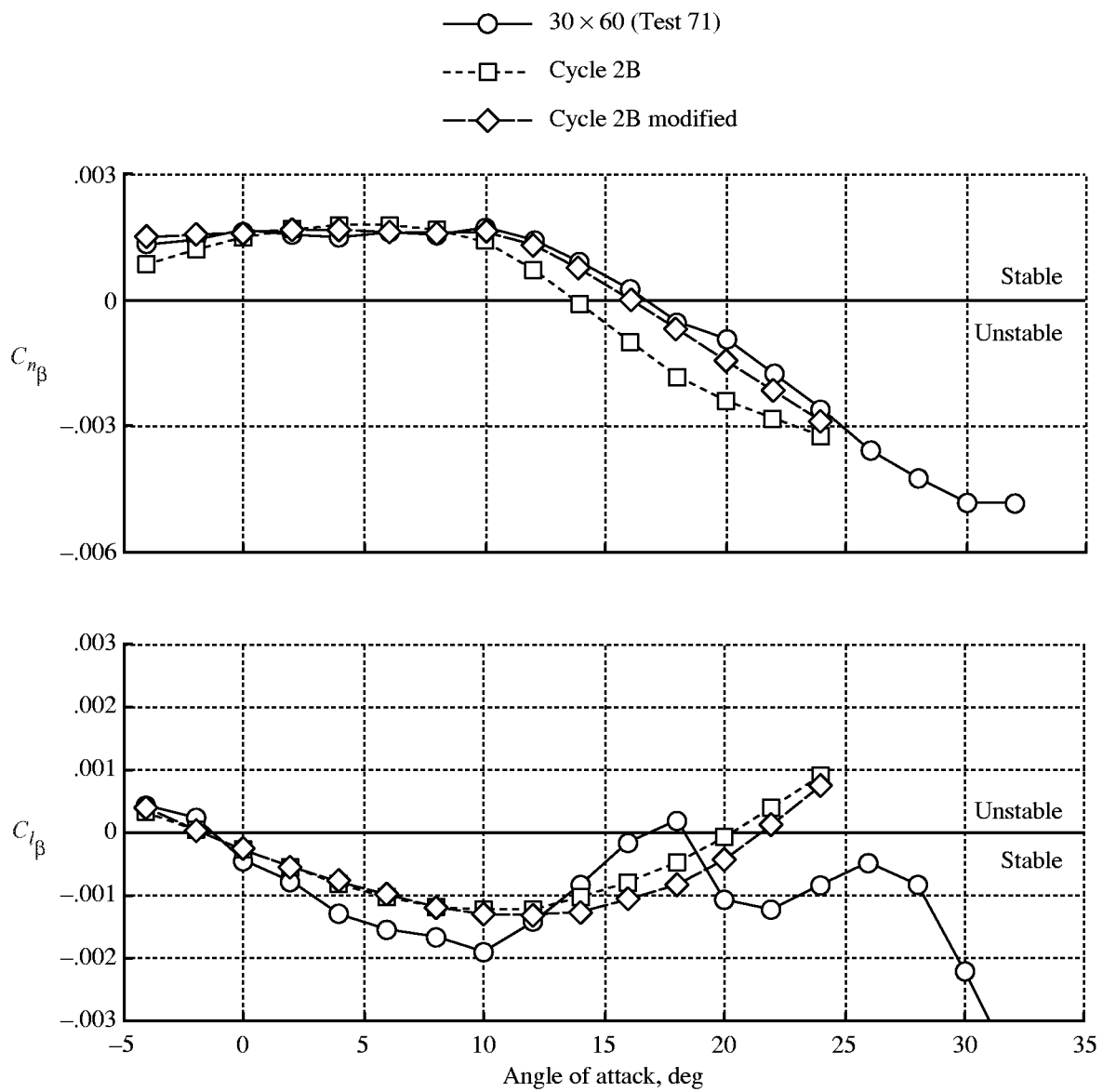

Figure 2. $C_{n\beta}$ and $C_{l\beta}$ as function of angle of attack with all control surfaces at 0° . Cycle 2B data obtained with aircraft out-of-ground effect; Mach = 0.30; rigid aerodynamics.

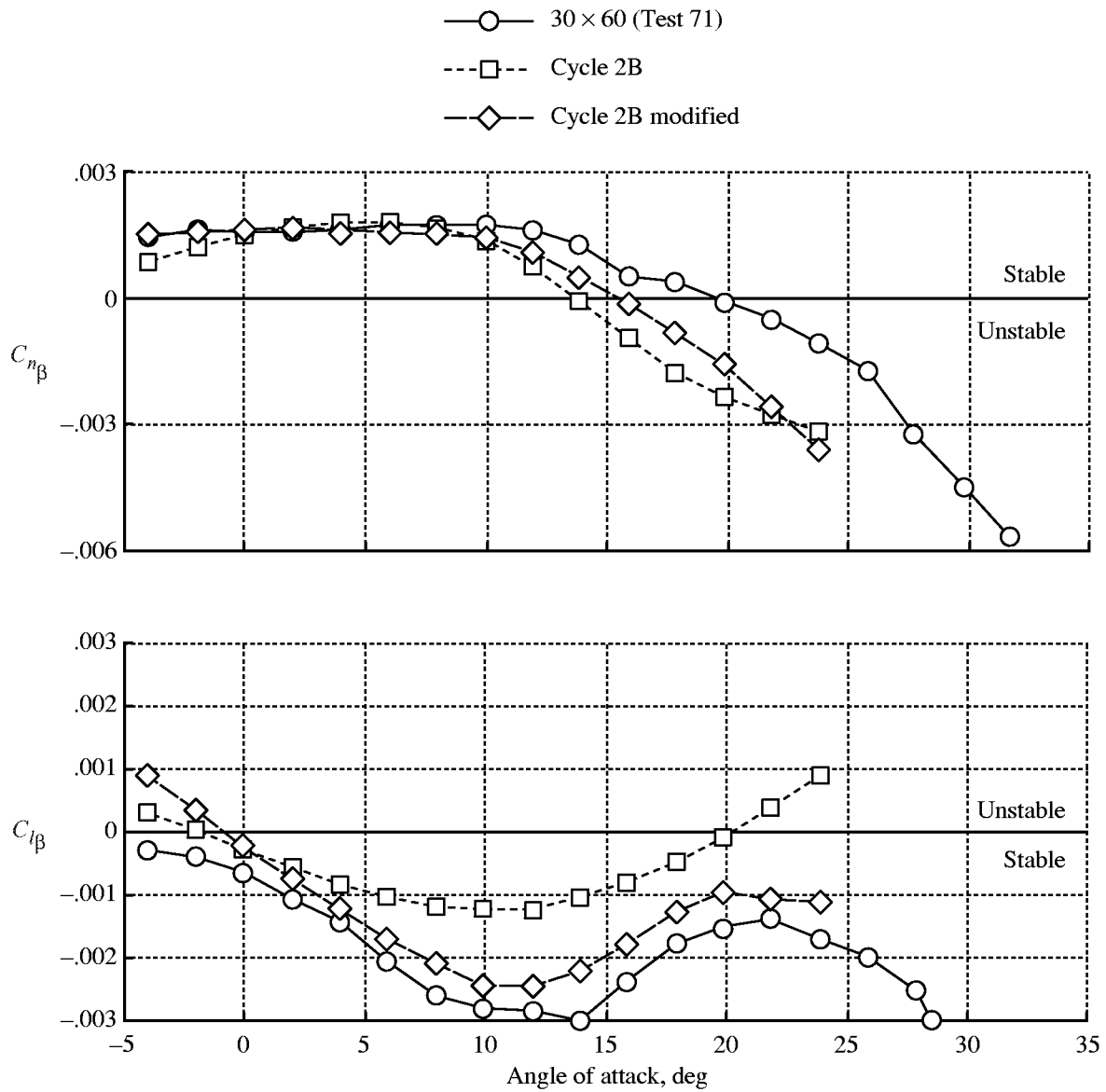

Figure 3. $C_{n\beta}$ and $C_{l\beta}$ as function of angle of attack with leading-edge flaps at 30° and trailing-edge flaps at 10° . Cycle 2B data obtained with aircraft out-of-ground effect; Mach = 0.30; rigid aerodynamics.

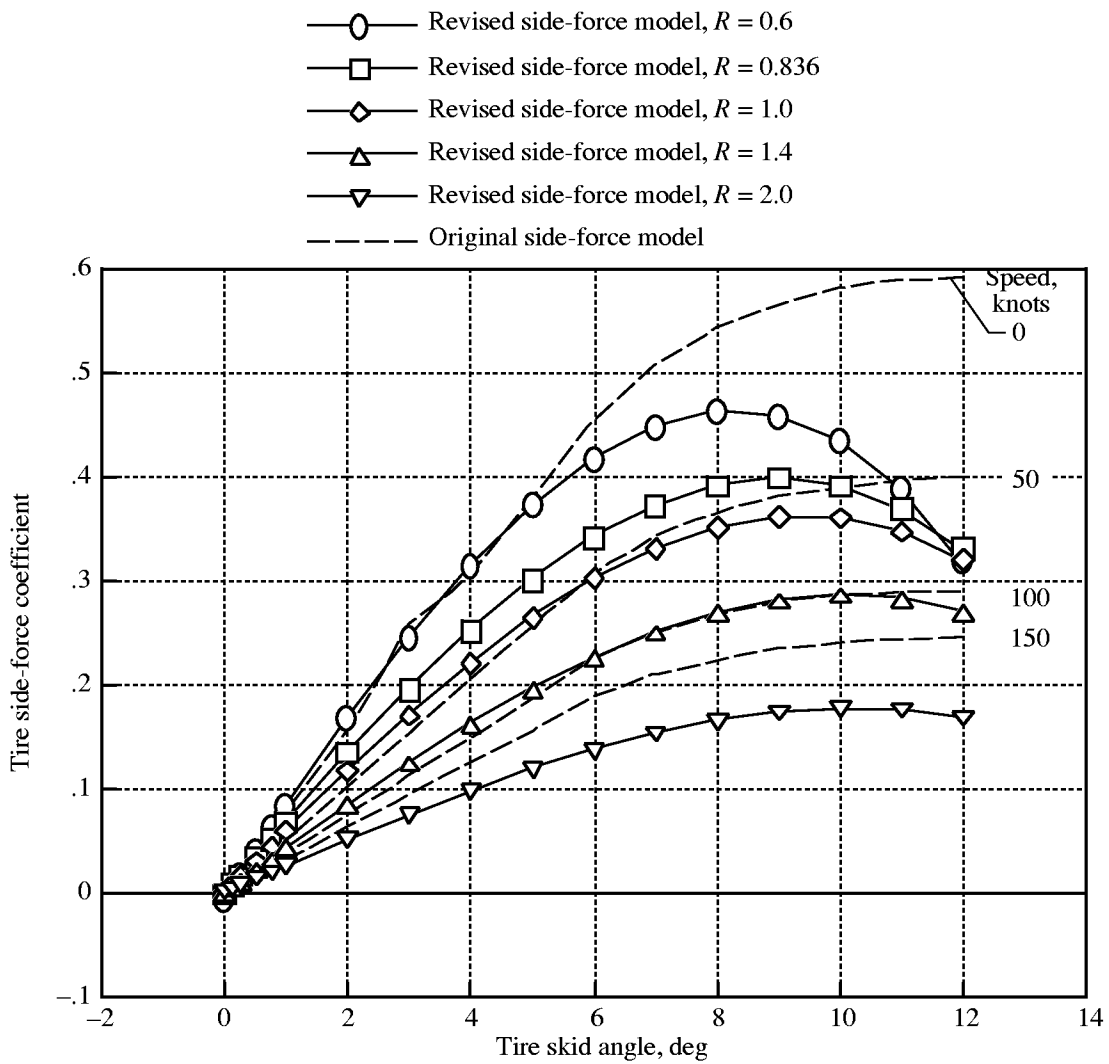

Figure 4. Data from original Ref-H Cycles 1, 2A, and 2B cornering model and Structural Dynamics Branch cornering model (revised).

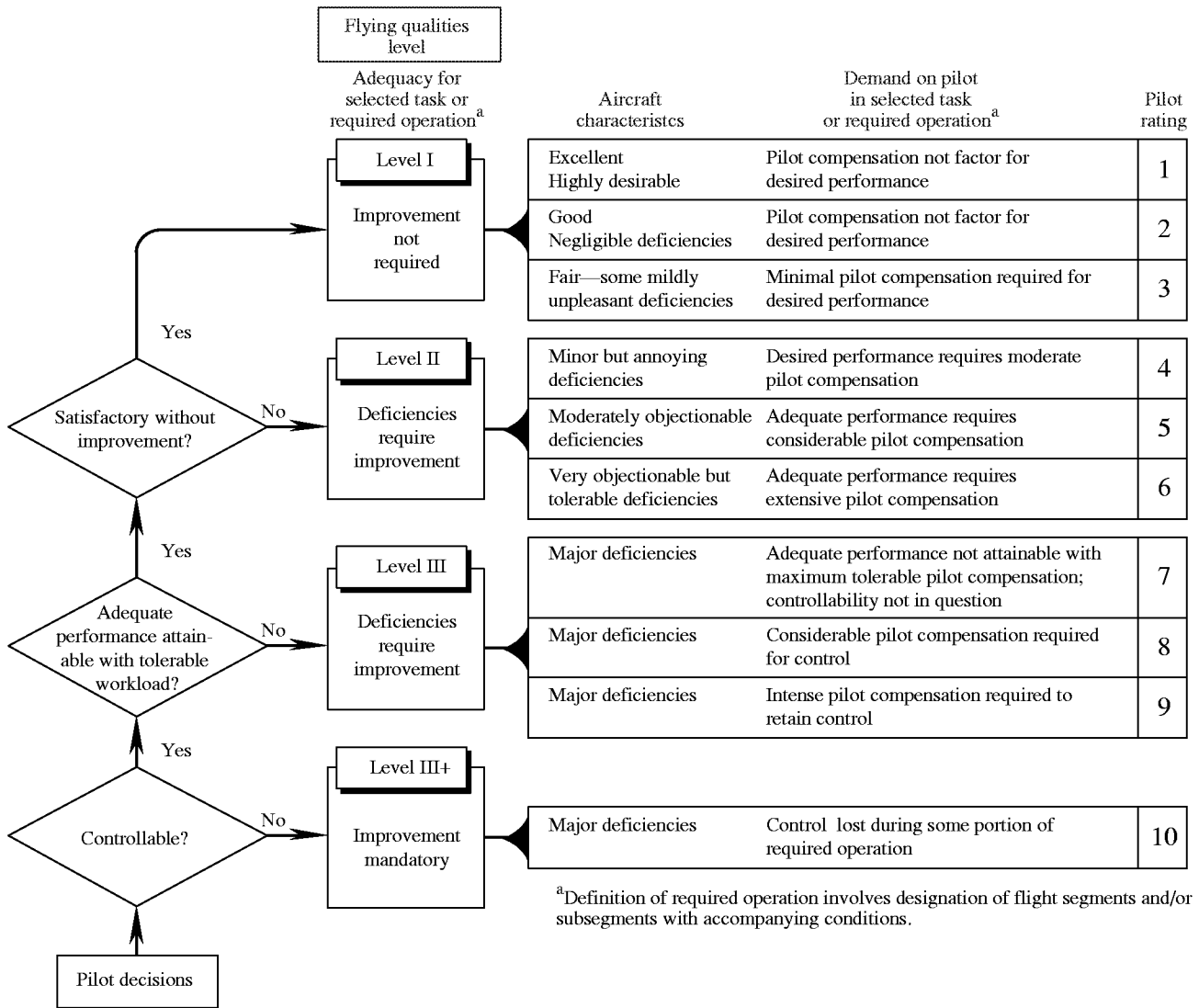

Figure 5. Cooper-Harper flying qualities rating scale.

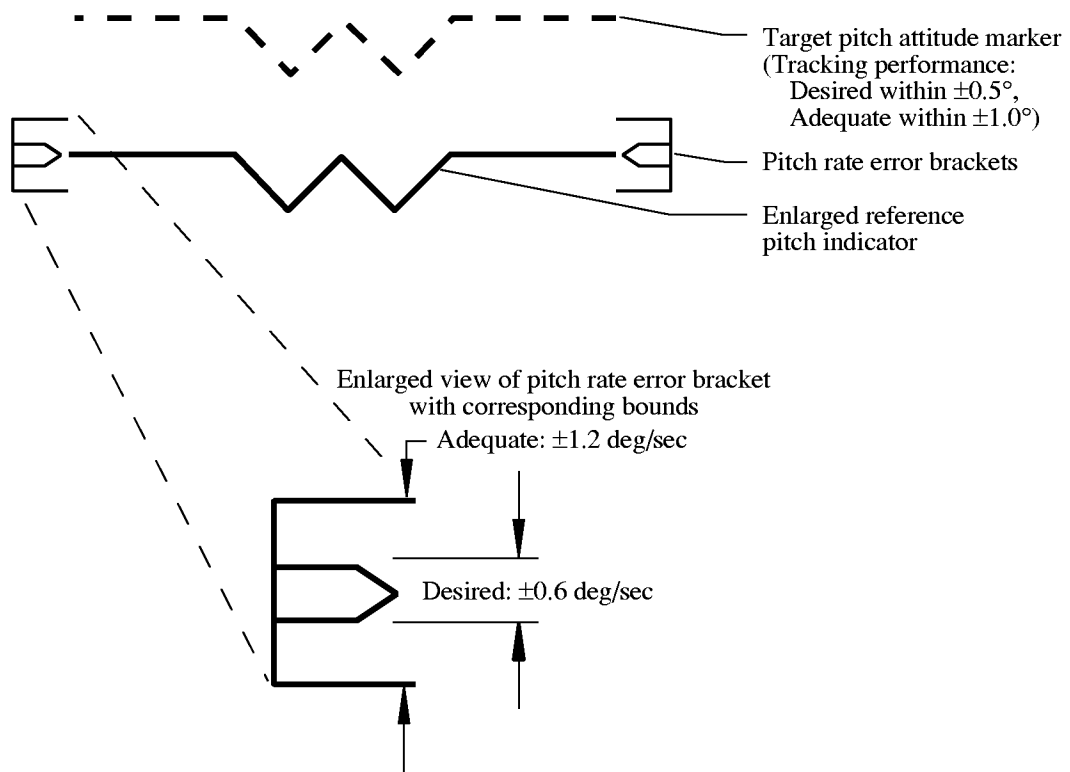

Figure 6. Pitch rotation HUD guidance used for takeoff maneuvers.

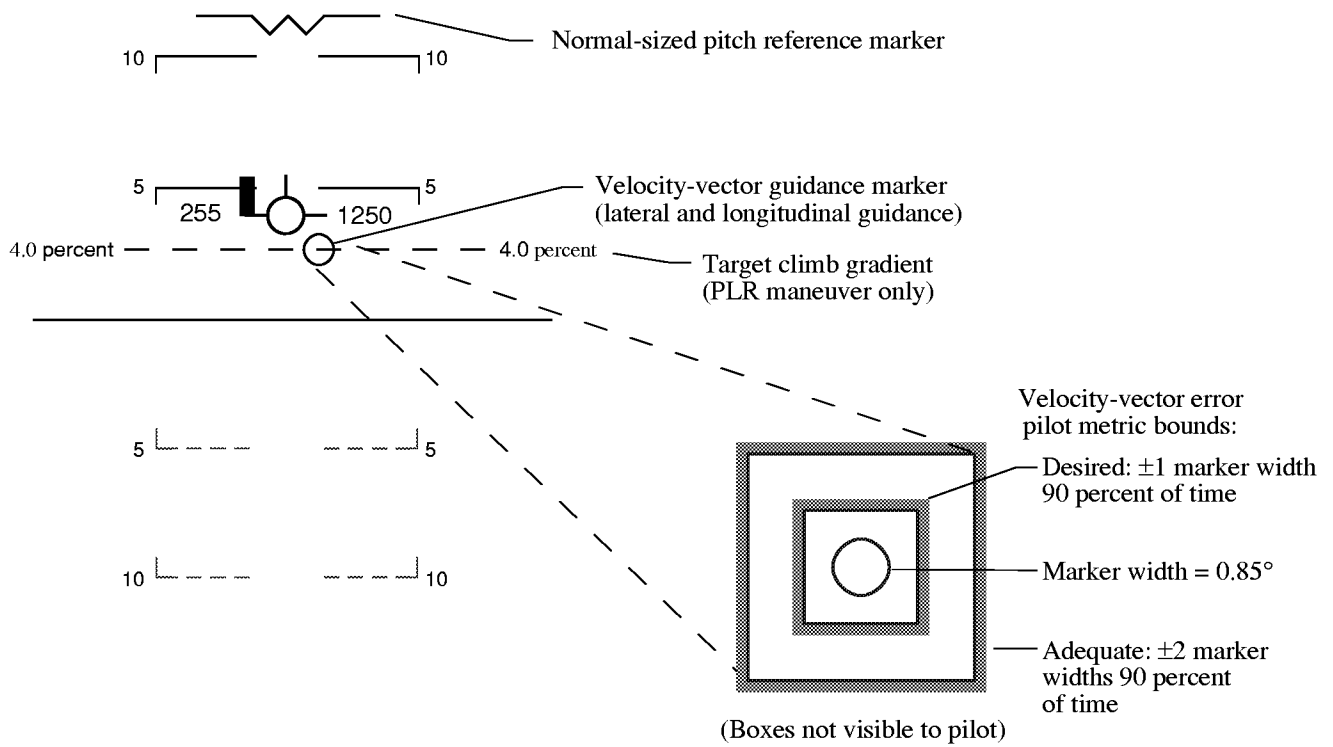

Figure 7. Pilot performance bounds used during climbout maneuver segments.

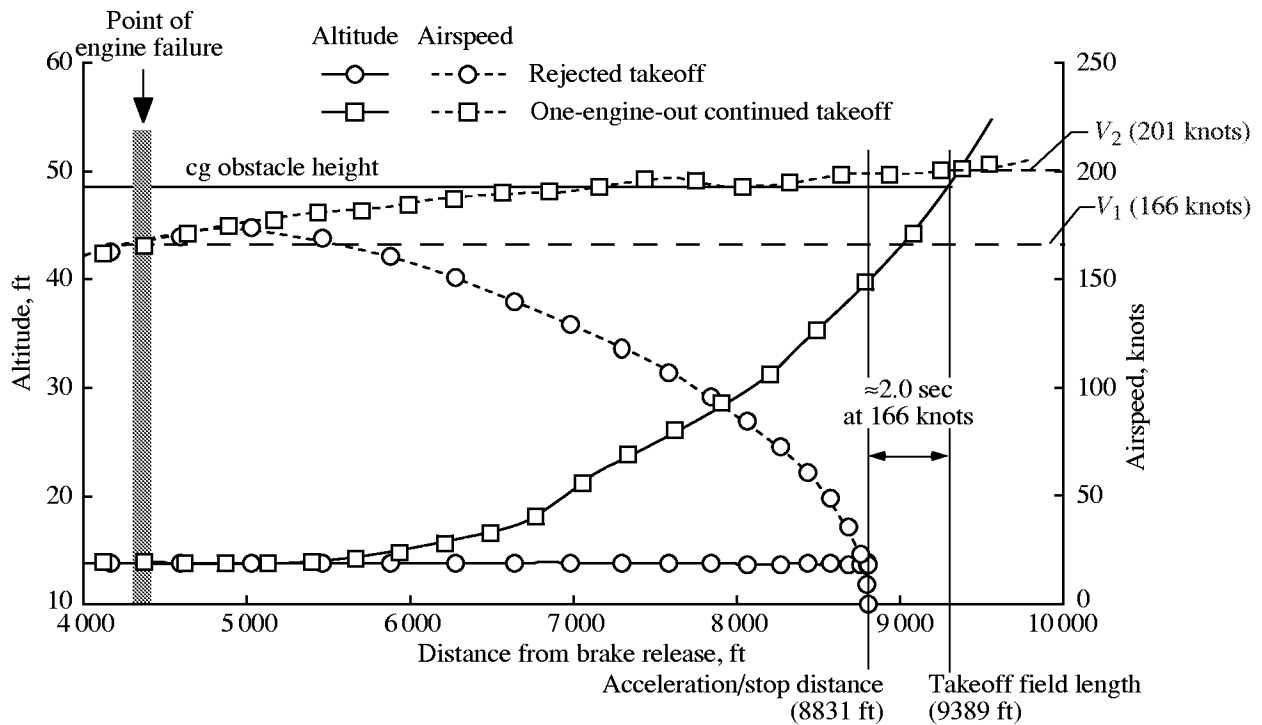

Figure 8. Demonstration of V_1 and V_r speeds. M13; leading-edge flaps at 30° ; trailing-edge flaps at 10° .

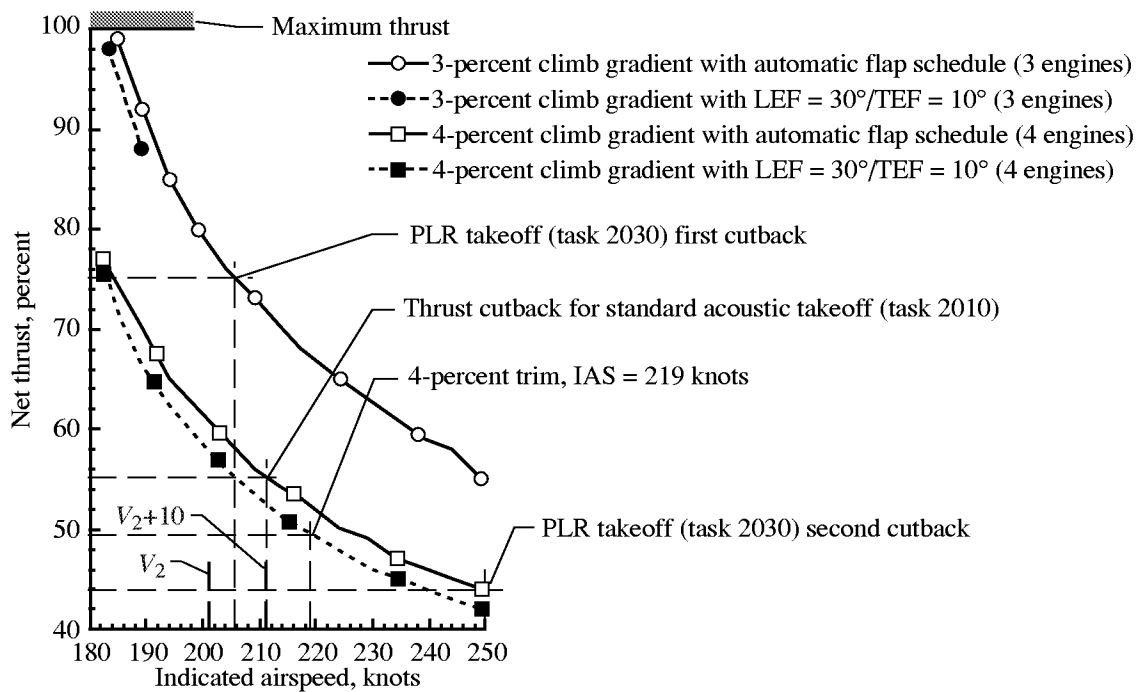

Figure 9. Trim analysis of Ref-H configuration to support rotation speed, climb speed, and level of thrust cutback calculations.

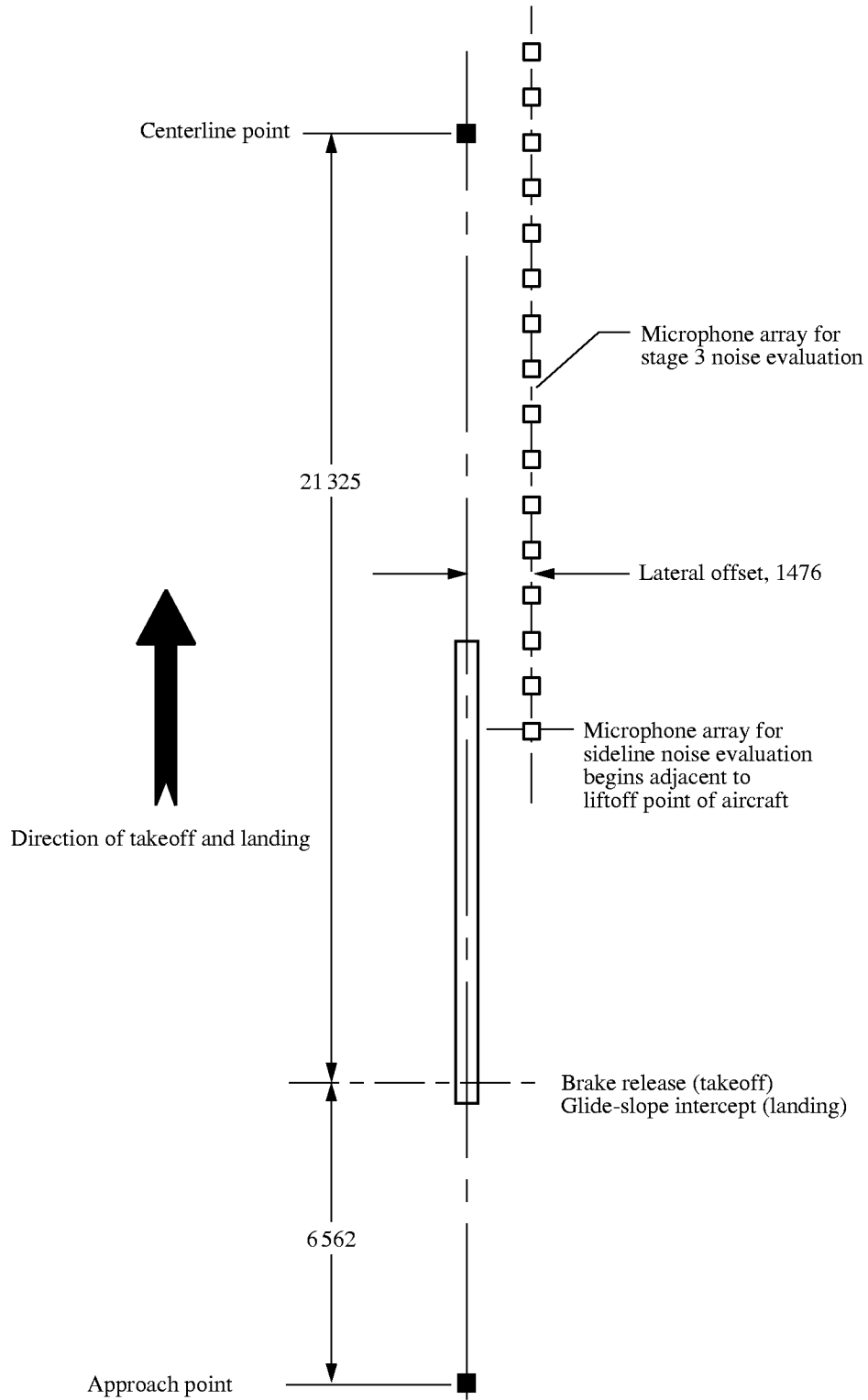

Figure 10. Layout of noise measurement system based on FAR Part 36 (ref. 11). Dimensions are in feet.

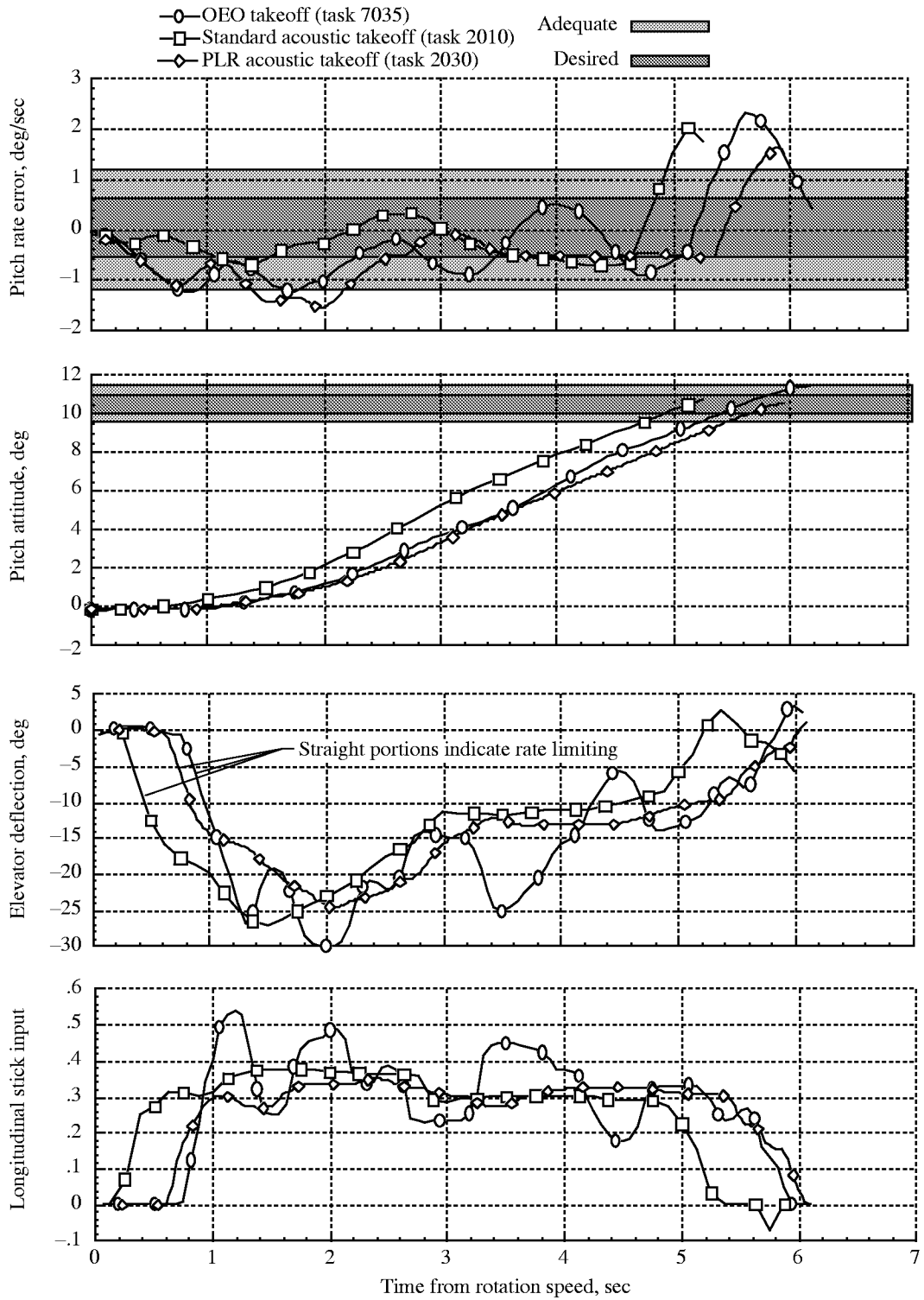

Figure 11. Typical time histories of pilot performance during takeoff rotation.

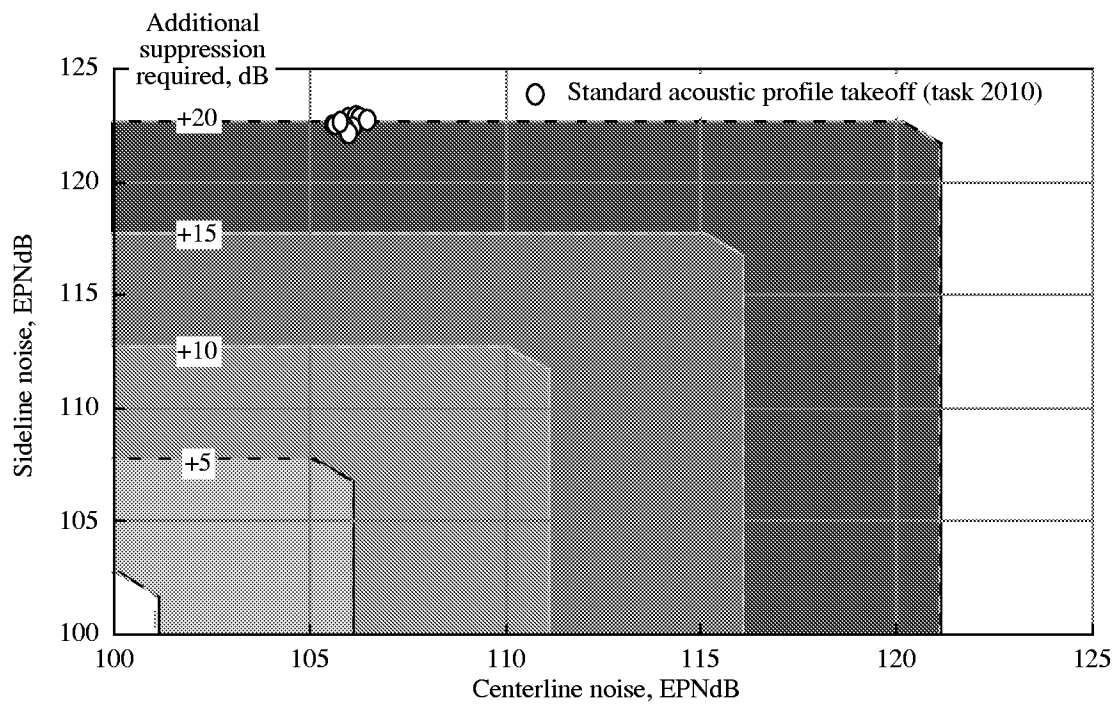

Figure 12. Noise results for 12 standard acoustic profile takeoff maneuvers. Noise suppression required to meet stage 3 minus 1, 5, 1 noise levels indicated by shaded boundaries; approach noise assumed at or below 99.2 EPNdB.

Legend

CHR level	Description	CHR value		
Level I	Satisfactory	1	2	3
Level II	Marginal	4	5	6
Level III	Deficient	7	8	9
Level III+	Uncontrollable	10		

Task	Flight card name	Longitudinal axis						Lateral-directional axis							
		Pilot					avg	σ	Pilot					avg	σ
		A	B	C	D	E			A	B	C	D	E		
Runway centerline tracking segment															
2010	Acoustic profile takeoff	Not rated						1	2	4	3	3	2.60	1.14	
2030	Acoustic PLR takeoff							1	2	4	3	3	2.60	1.14	
1050	Rejected takeoff—0-knot crosswind							1	3	3	4	3	2.80	1.10	
1051	Rejected takeoff—15-knot crosswind							1	3	3	4	3	2.80	1.10	
1052	Rejected takeoff—35-knot crosswind							1	3	3	4	3	2.80	1.10	
7035	One-engine-out takeoff	4	5	4	3	3	3.80	0.84							
Takeoff rotation segment															
2010	Acoustic profile takeoff	2	4	4	4	3	3.40	0.89	2	2	3	2	4	2.60	0.89
2030	Acoustic PLR takeoff	1	3	3	4	3	2.80	1.10	1	2	3	2	4	2.40	1.14
7035	One-engine-out takeoff	4	3	3	4	4	3.60	0.55	4	5	3	5	4	4.20	0.84
Climb segment															
2010	Acoustic profile takeoff	1	3	4	4	3	3.00	1.22	1	2	3	2	3	2.20	0.84
2030	Acoustic PLR takeoff	1	3	3	3	3	2.60	0.89	1	2	4	3	3	2.60	1.14
7035	One-engine-out takeoff	2	3	4	4	3	3.20	0.84	4	5	4	3	3	3.80	0.84

Figure 13. Cooper-Harper ratings for takeoff maneuvers.

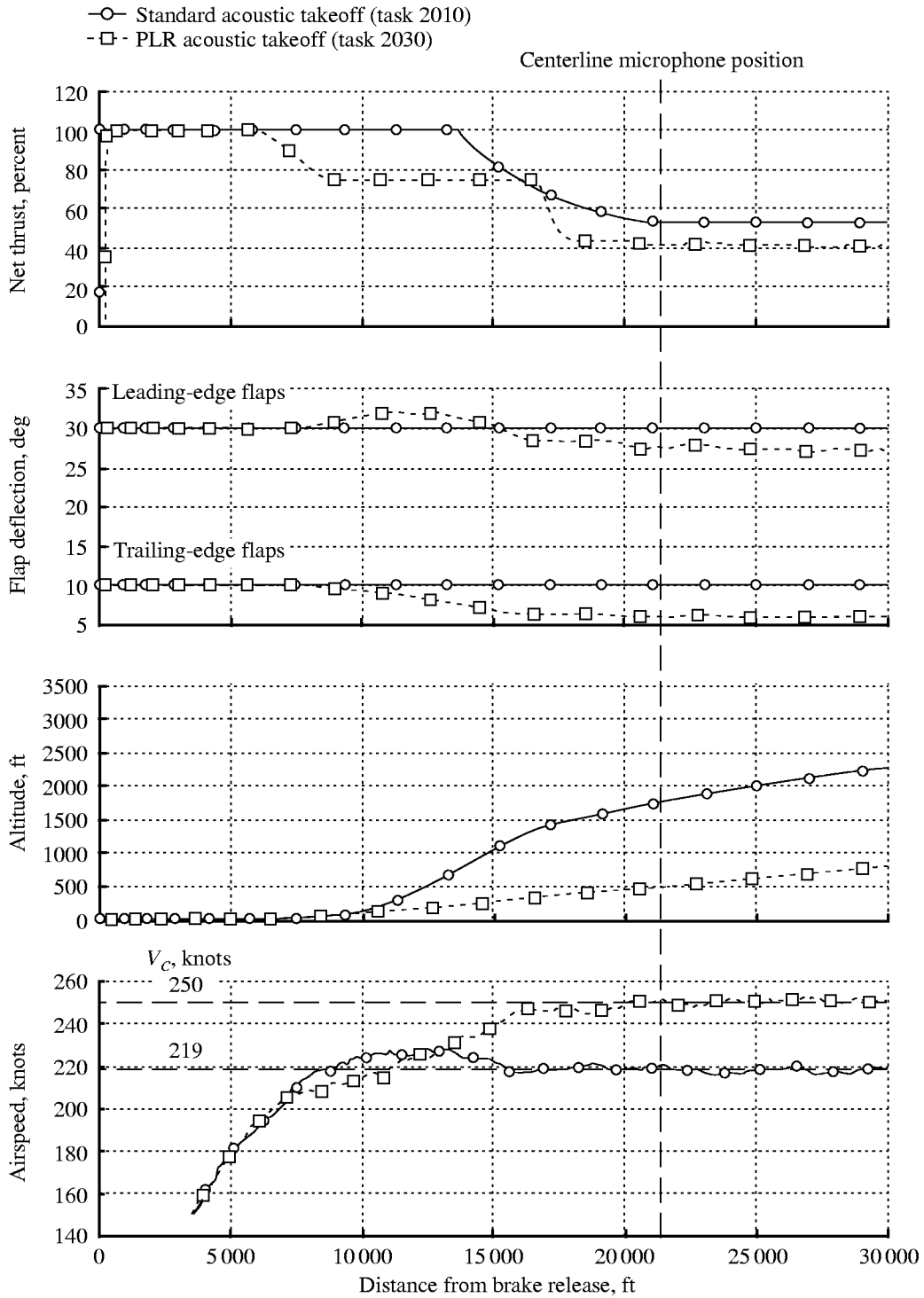

Figure 14. Thrust, leading- and trailing-edge flap deflections, altitude, and airspeed as function of distance from brake release for evaluations of standard acoustic and PLR takeoff procedures.

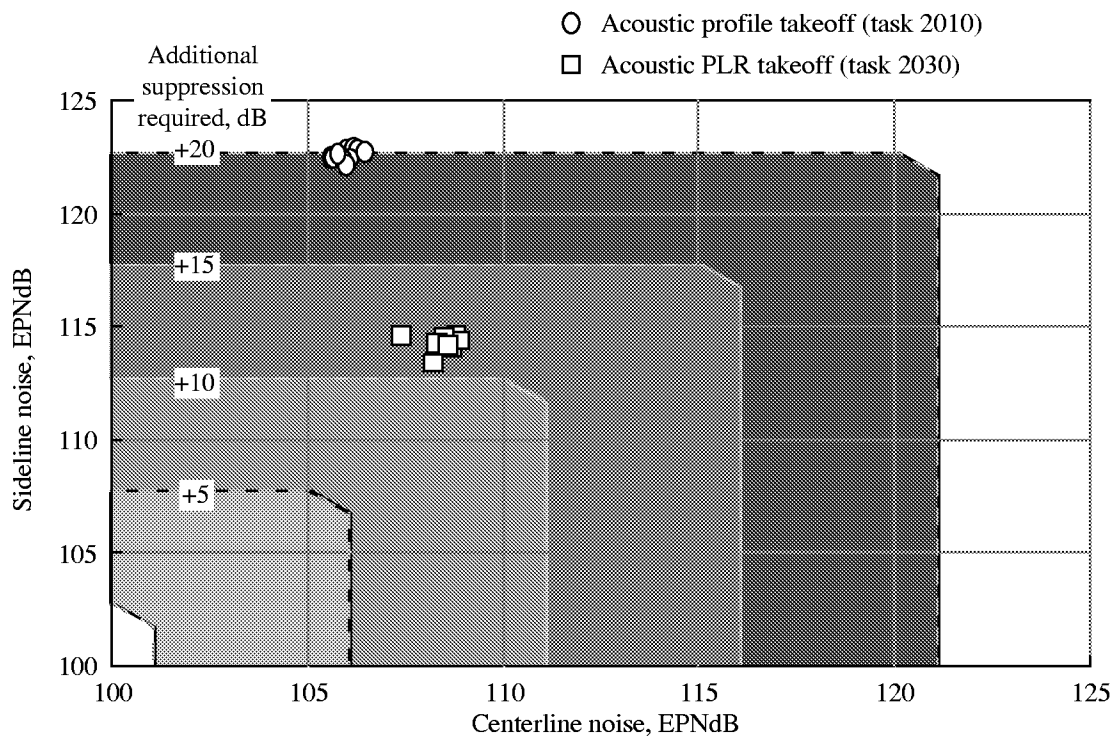

Figure 15. Noise results for 12 acoustic profile takeoffs (task 2010) and 10 acoustic PLR takeoffs (task 2030). Noise suppression required to meet stage 3 minus 1, 5, 1 noise levels indicated by shaded boundaries; approach noise assumed at or below 99.2 EPNdB.

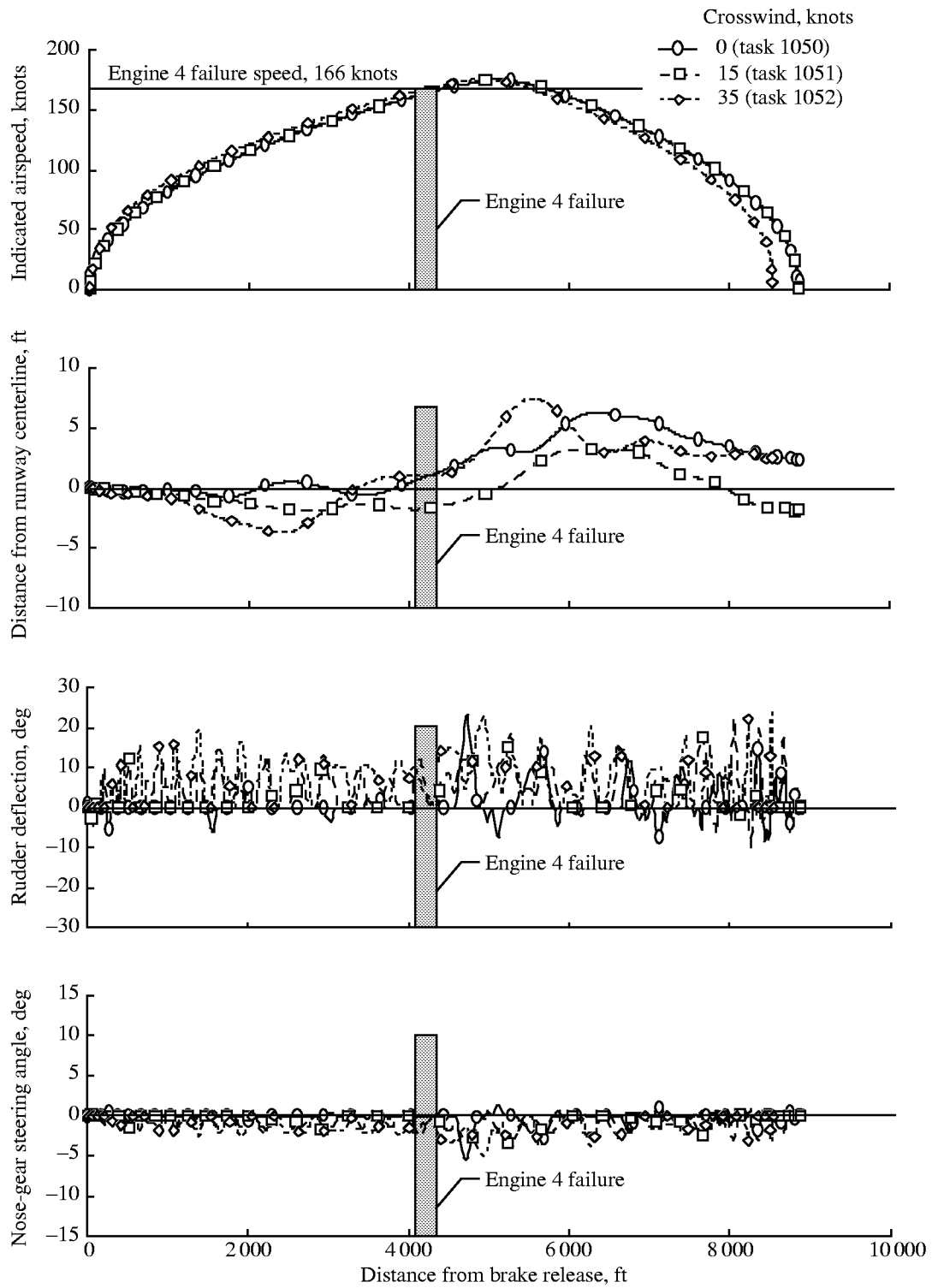

Figure 16. Indicated airspeed, lateral distance from runway centerline, rudder deflection, and nose-gear steering angle as function of distance from brake release for RTO with various crosswinds.

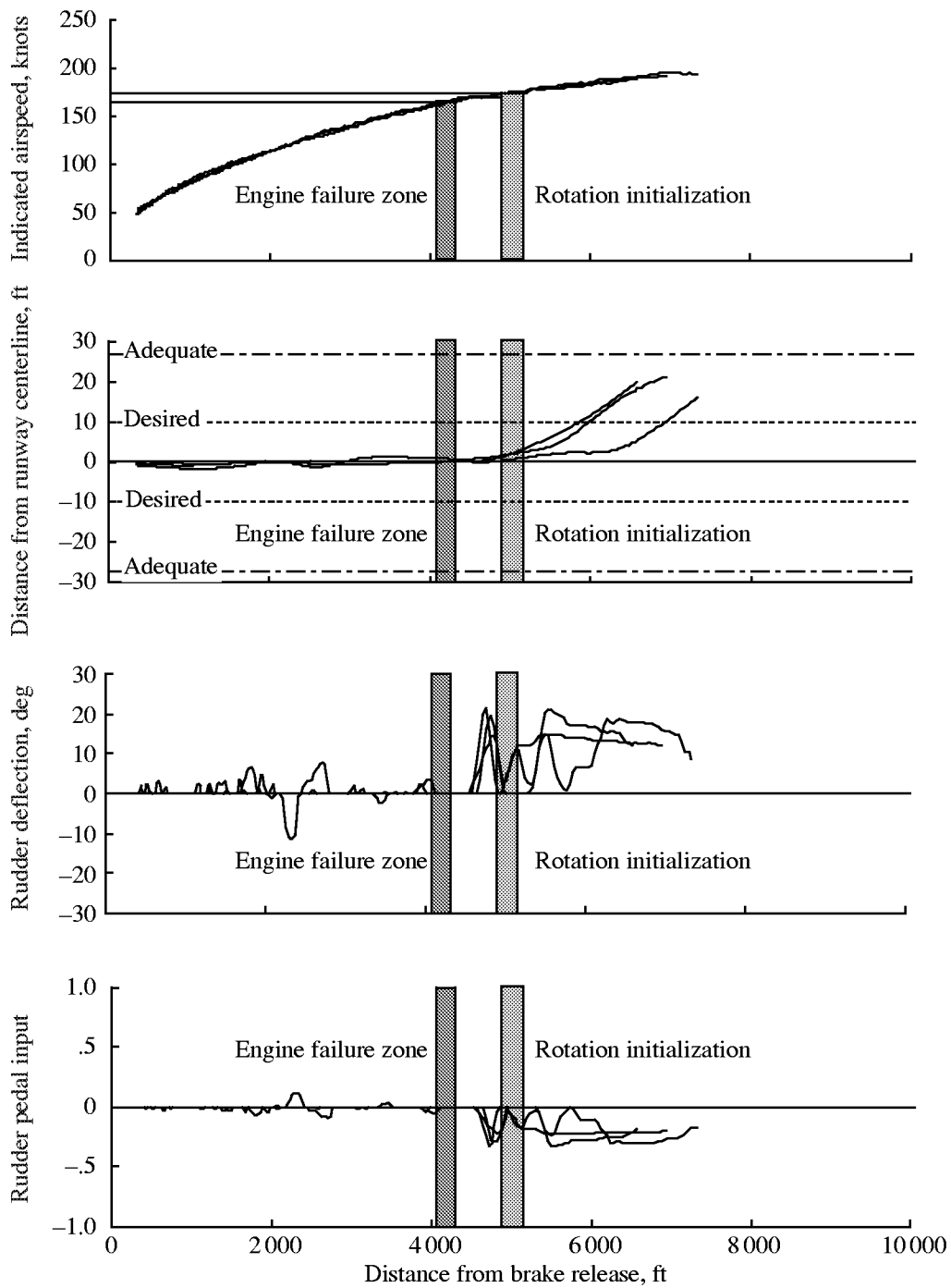

Figure 17. Indicated airspeed, lateral distance from runway centerline, rudder deflection, and rudder pedal input as function of distance from brake release to liftoff for evaluation of OEO takeoff (task 7035).

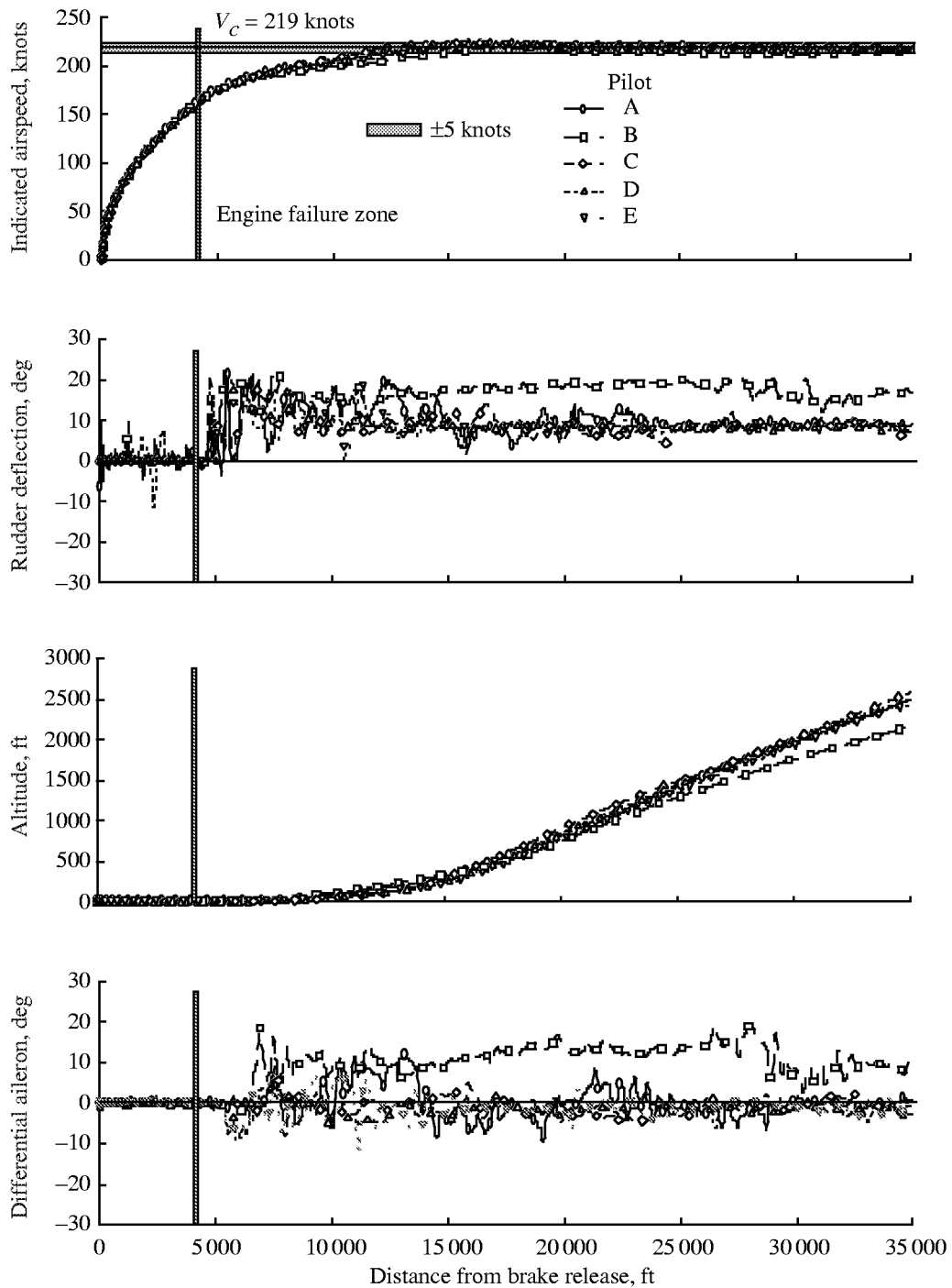

Figure 18. Indicated airspeed, rudder deflection, altitude, and differential aileron command. Data presented for entire maneuver for evaluation of OEO takeoff (task 7035).

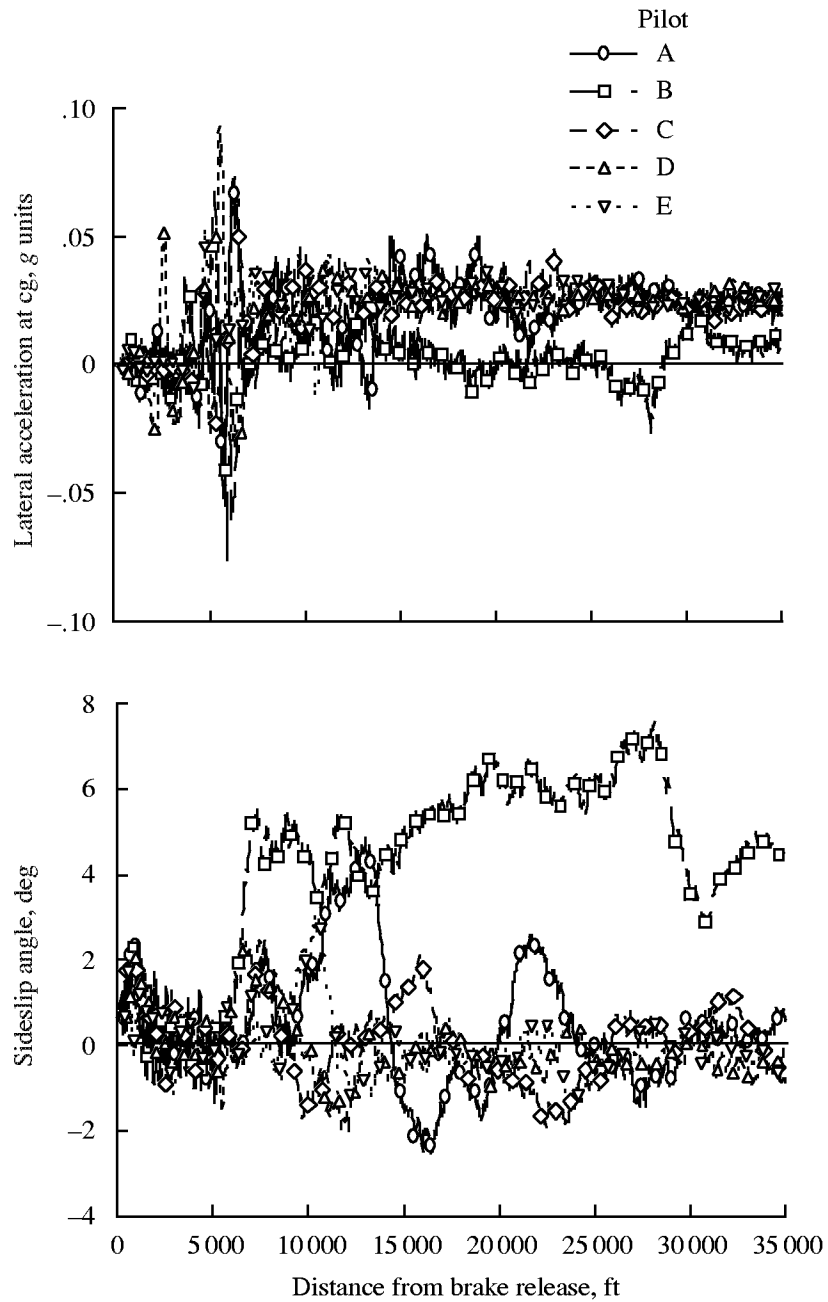

Figure 19. Lateral acceleration at cg and sideslip angle as function of distance from brake release. Data presented for entire maneuver for evaluation of OEO takeoff (task 7035).

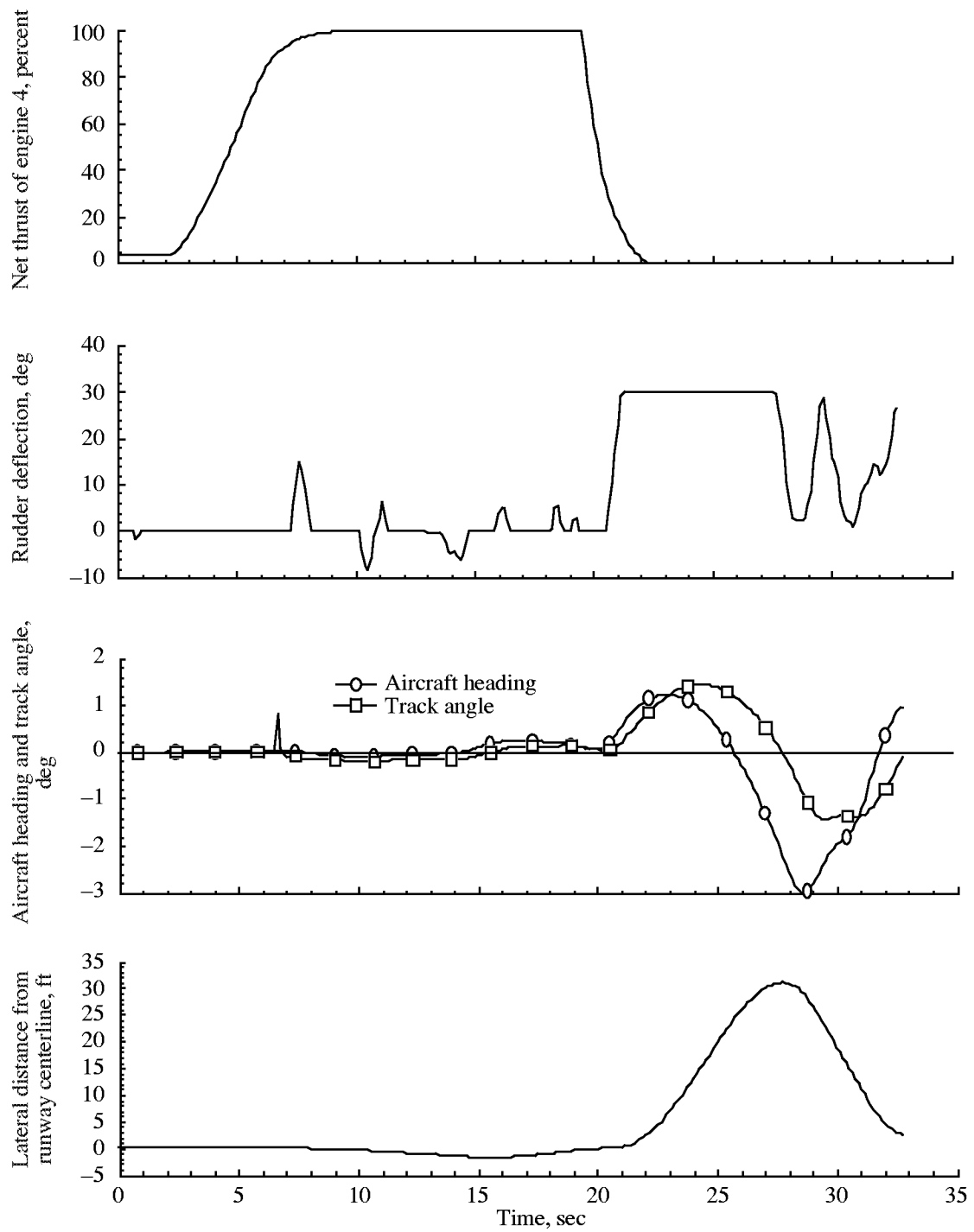

Figure 20. Time histories for net thrust of engine 4 (right, outboard), rudder deflection, aircraft heading and track angle, and lateral distance from runway centerline for representative V_{mcg} (task 7030).

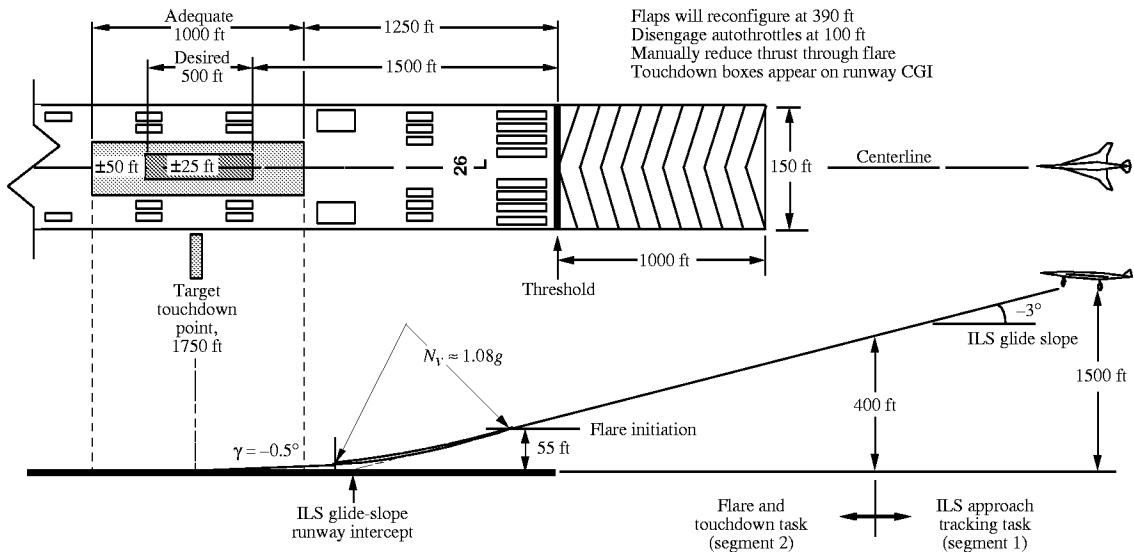

Figure 21. Approach and landing task definitions and performance tolerances.

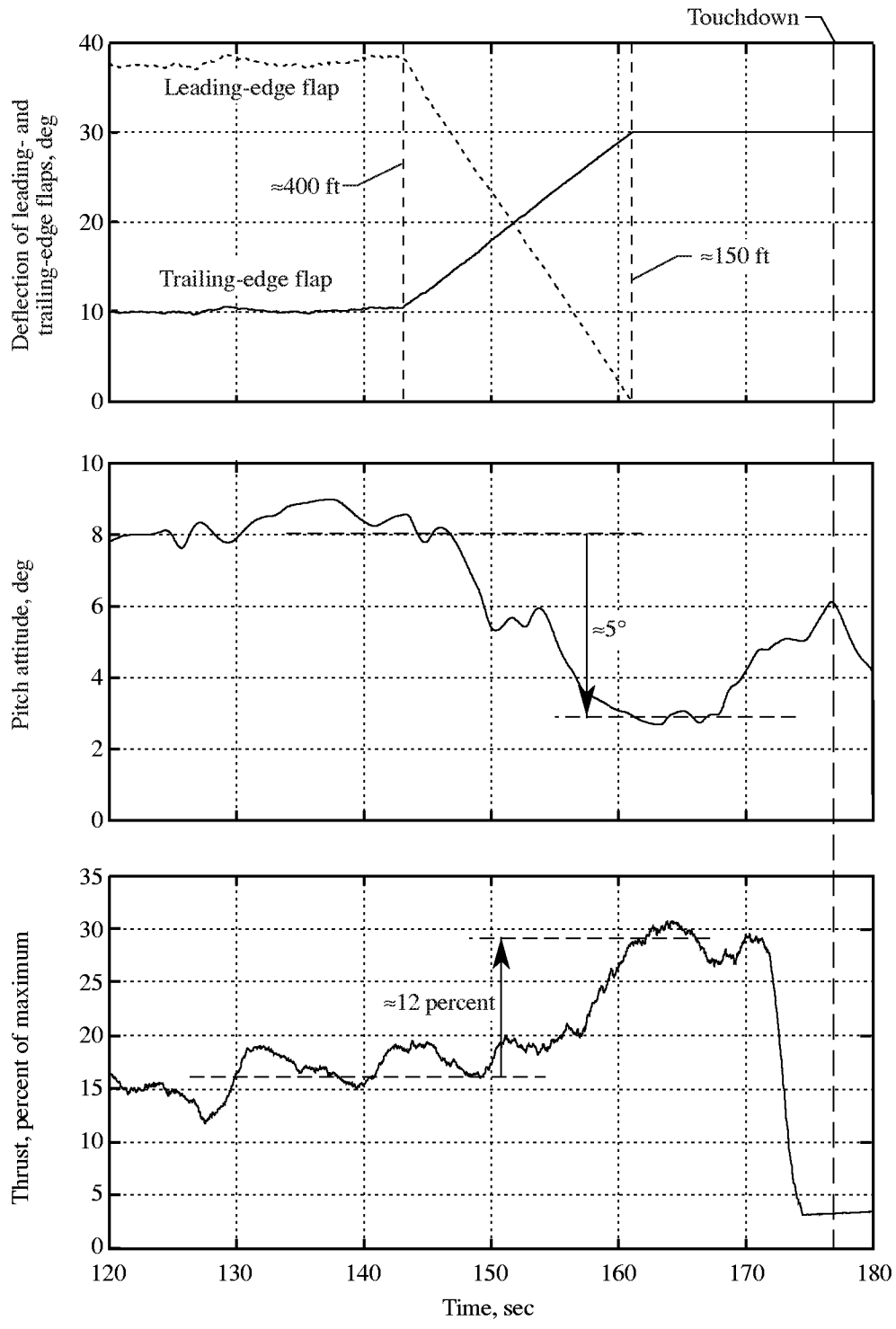

Figure 22. Time histories for surface positions, pitch attitude, and thrust response to automatic flap reconfiguration.

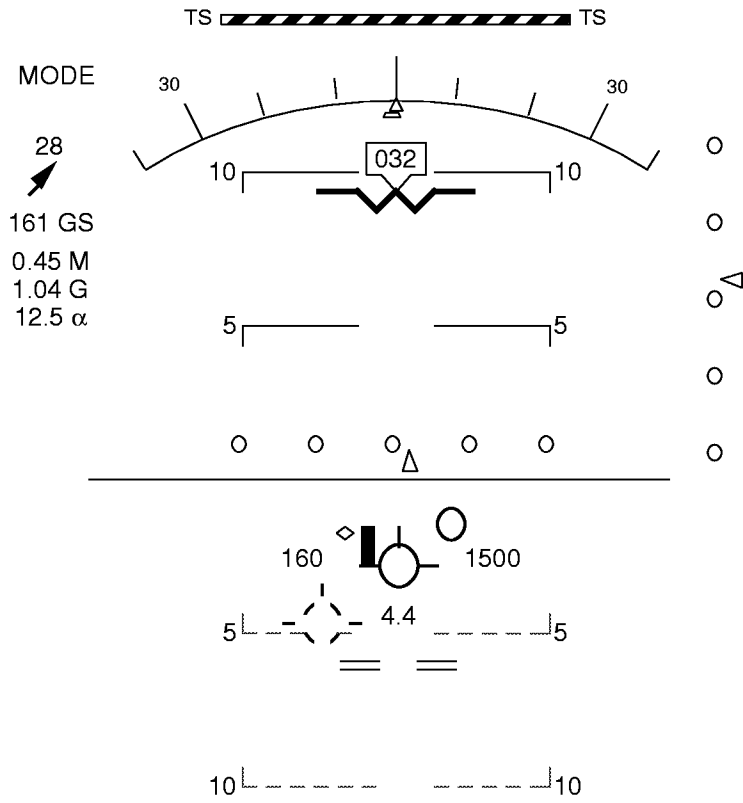

Figure 23. Diagram of HUD used for approach and landing tasks.

Legend

CHR level	Description	CHR value		
Level I	Satisfactory	1	2	3
Level II	Marginal	4	5	6
Level III	Deficient	7	8	9
Level III+	Uncontrollable	10		

Task	Flight card name	Longitudinal axis						Lateral-directional axis							
		Pilot					avg	σ	Pilot					avg	σ
		A	B	C	D	E			A	B	C	D	E		
Localizer and glideslope intercept segment (h > 400 ft)															
4020	Nominal approach and landing	2	2	4	3	3	2.80	0.84	2	3	4	4	3	3.20	0.84
4025	Nominal app. and landing with flight director	1	3	4	4	3	3.00	1.22	3	3	4	4	3	3.40	0.55
Precision landing segment (h < 400 ft)															
4020	Nominal approach and landing	3	4	5	5	4	4.20	0.84	2	3	5	3	3	3.20	1.10
4025	Nominal app. and landing with flight director	3	4	5	5	3	4.00	1.00	2	3	5	4	2	3.20	1.30
4050	Precision landing	2	4	5	5	4	4.00	1.22	2	3	5	4	4	3.60	1.14
4062	Landing from lateral offset—mod. turb.	8	4	5	7	4	5.60	1.82	5	10	5	7	4	6.20	2.39
4066	Landing from lateral offset—cat. I/mod. turb.	3	4	5	7	4	4.60	1.52	4	6	5	7	4	5.20	1.30
4072	Landing from vertical offset—mod. turb.	4	4	5	7	3	4.60	1.52	2	3	5	3	3	3.20	1.10
4076	Landing from vertical offset—cat. I/mod. turb.	4	4	5	7	3	4.60	1.52	2	3	5	3	4	3.40	1.14
4080	Go-around (100 ft)	4	3	3	7	4	4.20	1.64	2	2	3	3	2	2.40	0.55
4085	Go-around with min. alt. loss	2	4	3	7	4	4.00	1.87	2	2	3	3	3	2.60	0.55
Localizer and glideslope intercept segment (h > 400 ft)															
4090	Crosswind approach and landing—15 knots	3	2	4	4	3	3.20	0.84	2	2	4	4	3	3.00	1.00
4095	Crosswind approach and landing—35 knots	3	3	4	4	3	3.40	0.55	2	2	4	4	3	3.00	1.00
4100	Cat IIIa minimums landing	2	2	3	4	3	2.80	0.84	2	2	3	4	4	3.00	1.00
4110	Approach and landing with jammed control	1	2	3	4	3	2.60	1.14	2	2	3	4	3	2.80	0.84
7050	Dynamic VMCL 2	1	3	3	5	3	3.00	1.41	2	3	3	4	3	3.00	0.71
7095	Manual throttle landing	2	3	5	5	4	3.80	1.30	1	2	5	4	3	3.00	1.58
7110	Unaugmented landing—longitudinal axis mop.	6	5	6	7	6	6.00	0.71	2	4	3	4	3	3.20	0.84
7100	Unaugmented landing	7	5	7	7	6	6.40	0.89	5	5	7	6	4	5.40	1.14
7090	All engines out landing	2	3	4	4	3	3.20	0.84	2	2	3	4	3	2.80	0.84
Precision landing segment (h < 400 ft)															
4090	Crosswind approach and landing—15 knots	3	5	6	7	6	5.40	1.52	2	4	6	4	4	4.00	1.41
4095	Crosswind approach and landing—35 knots	10	7	7	7	5	7.20	1.79	10	9	7	7	6	7.80	1.64
4100	Cat IIIa minimums landing	4	3	6	10	4	5.40	2.79	6	3	6	10	6	6.20	2.49
4110	Approach and landing with jammed control	1	3	5	5	4	3.60	1.67	1	2	5	4	3	3.00	1.58
7095	Manual throttle landing	1	4	3	5	5	3.60	1.67	1	2	3	4	3	2.60	1.14
7110	Unaugmented landing—longitudinal axis mop.	6	5	7	7	6	6.20	0.84	1	4	4	4	3	3.20	1.30
7100	Unaugmented landing	7	6	7	7	6	6.60	0.55	5	5	7	6	3	5.40	1.48
7090	All engines out landing	2	3	5	5	3	3.60	1.34	2	2	6	4	3	3.40	1.67

Figure 24. Cooper-Harper ratings assigned by pilots for each approach and landing task.

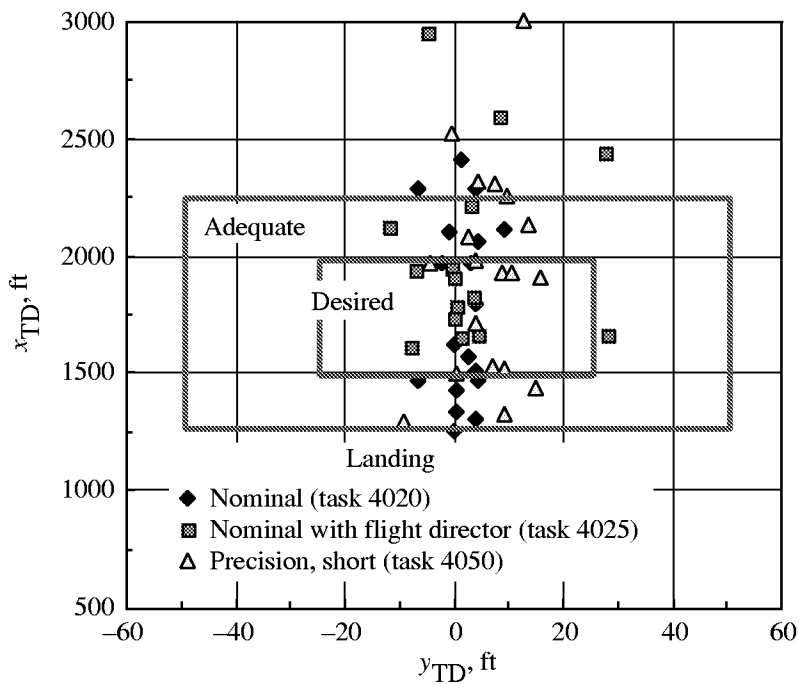

(a) Touchdown dispersions.

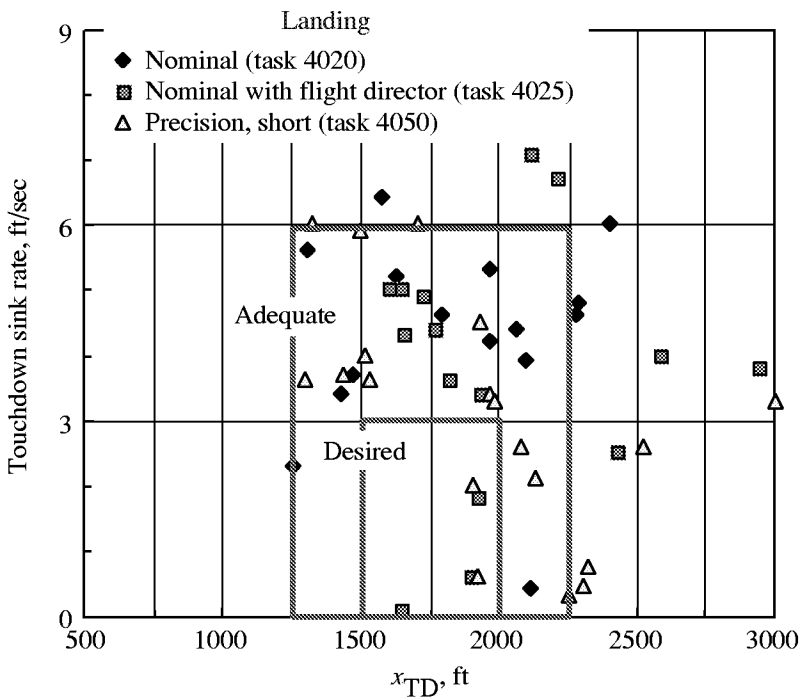

(b) Touchdown sink rates.

Figure 25. Touchdown performance for nominal approach and landing (tasks 4020, 4025, and 4050).

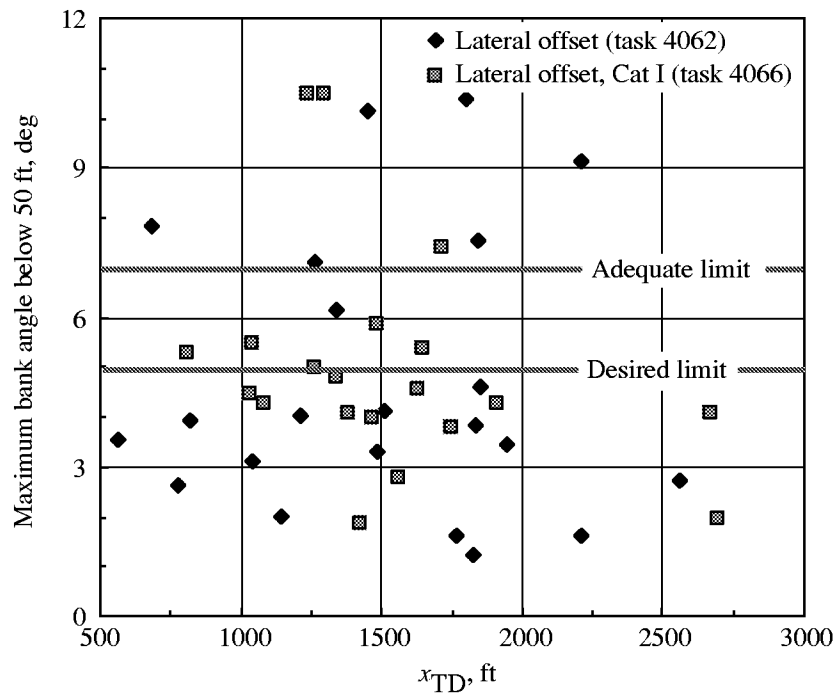
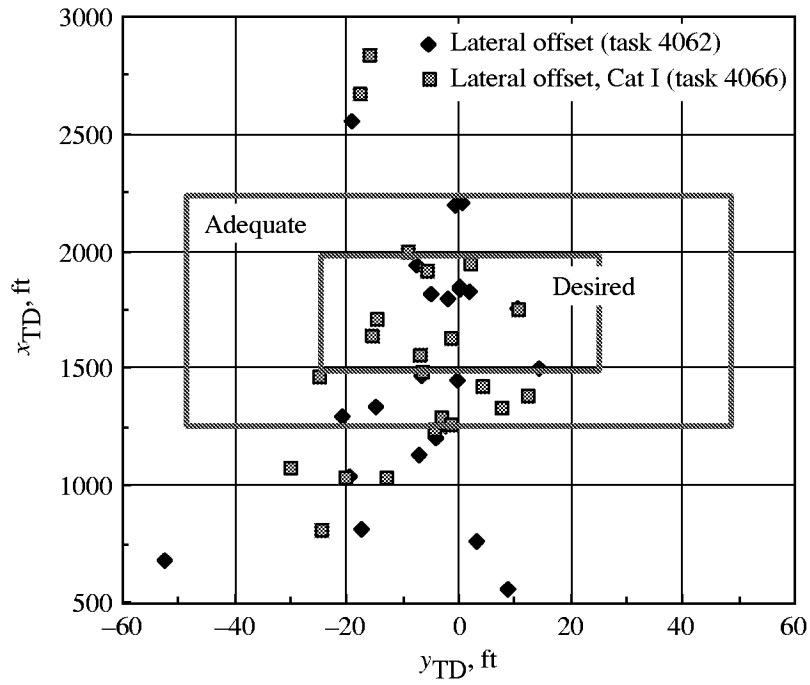
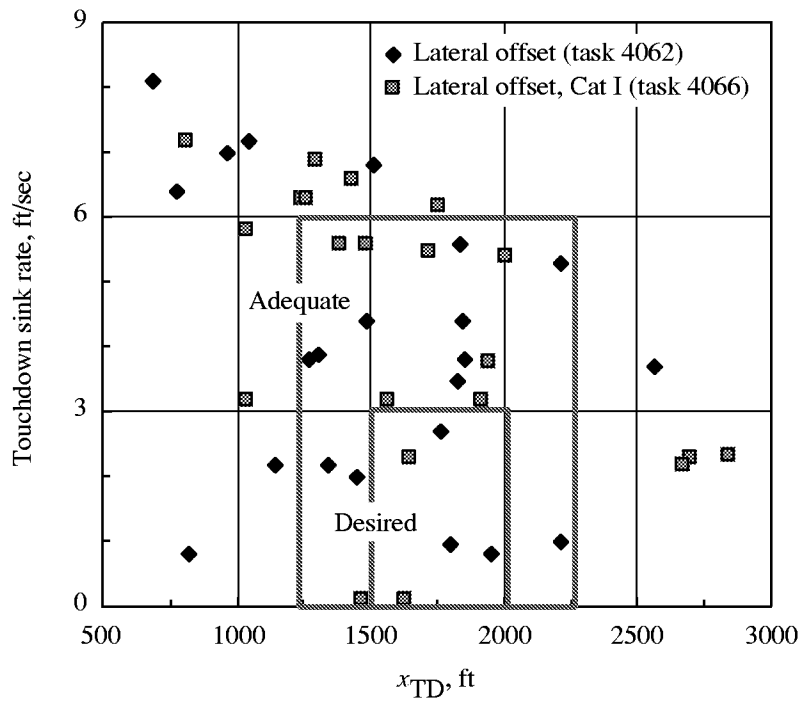

Figure 26. Bank angle performance for lateral offset landing (tasks 4062 and 4066).



(a) Touchdown dispersions.



(b) Touchdown sink rates.

Figure 27. Touchdown performance for lateral offset landing (tasks 4062 and 4066).

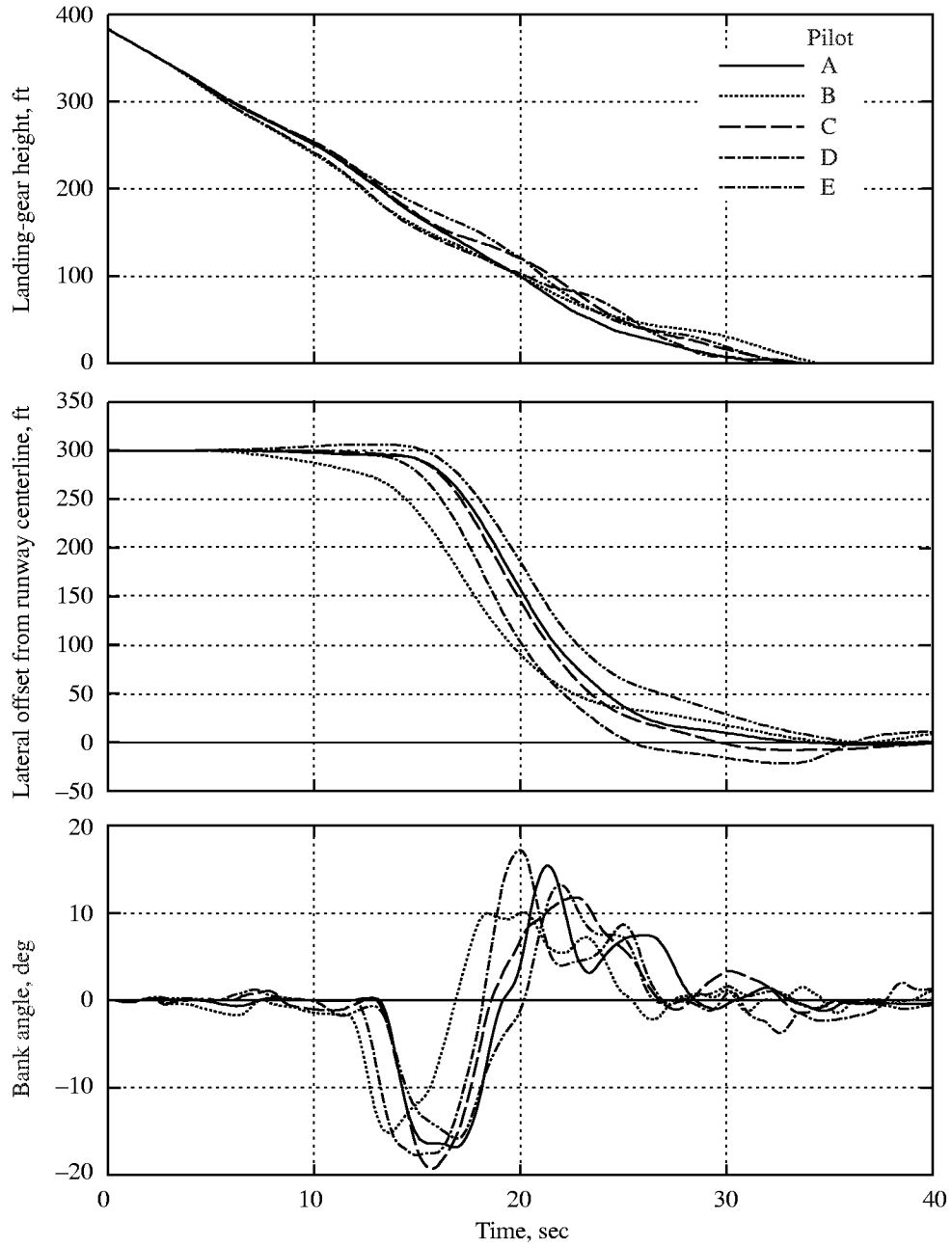

Figure 28. Typical time histories for lateral offset landing (task 4062).

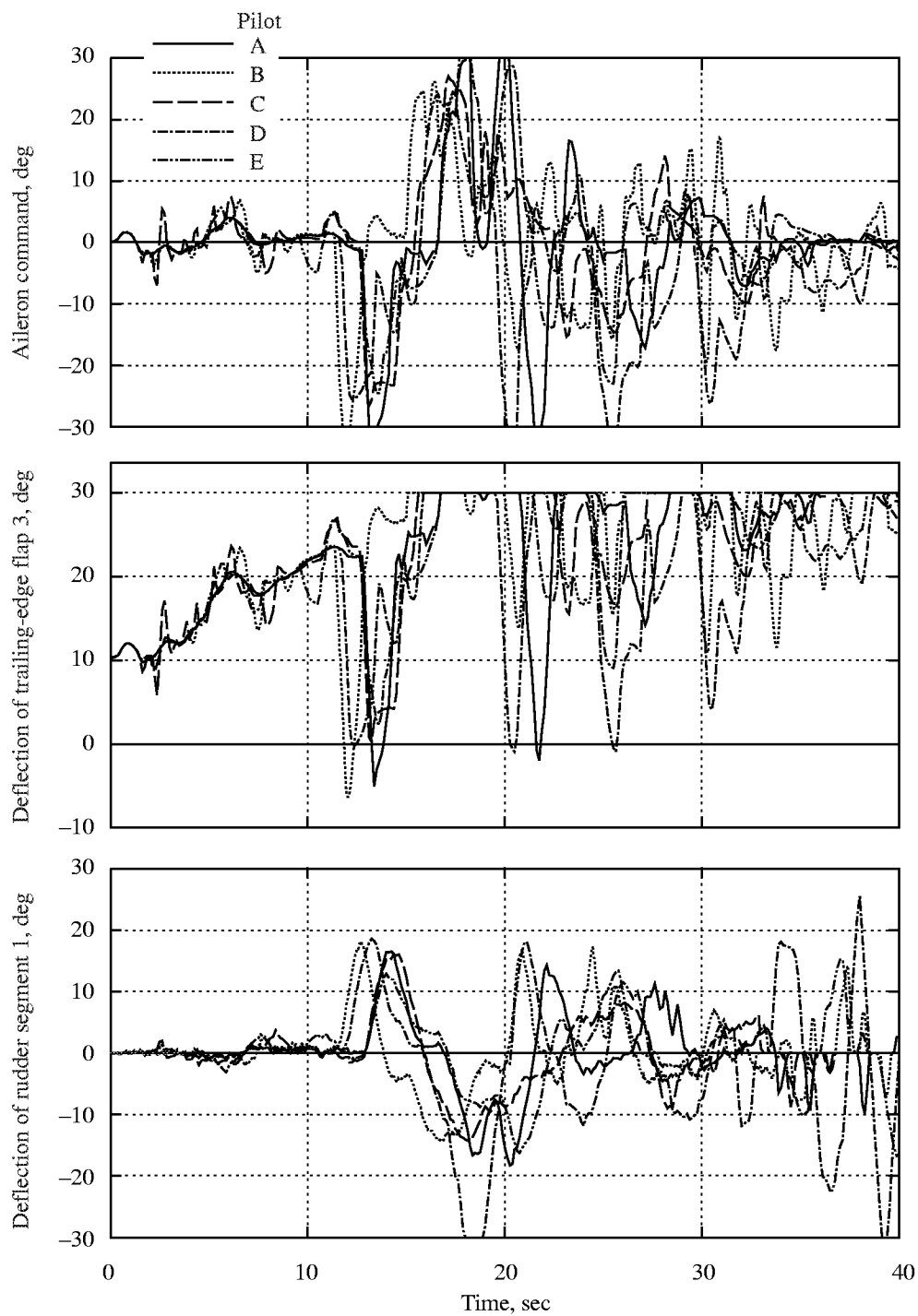

Figure 28. Concluded.

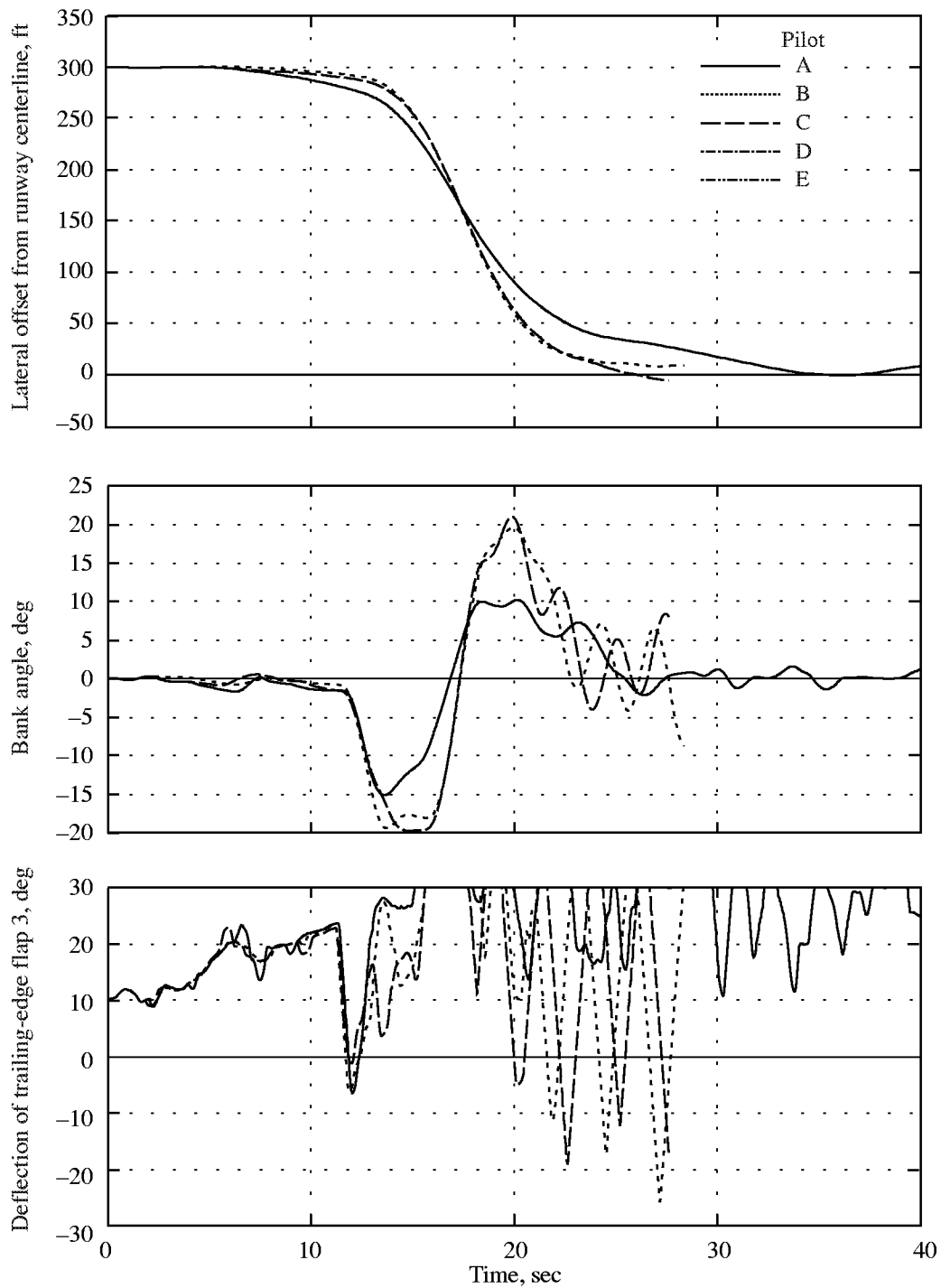

Figure 29. Typical time histories for PIOs encountered during lateral offset landing (task 4062).

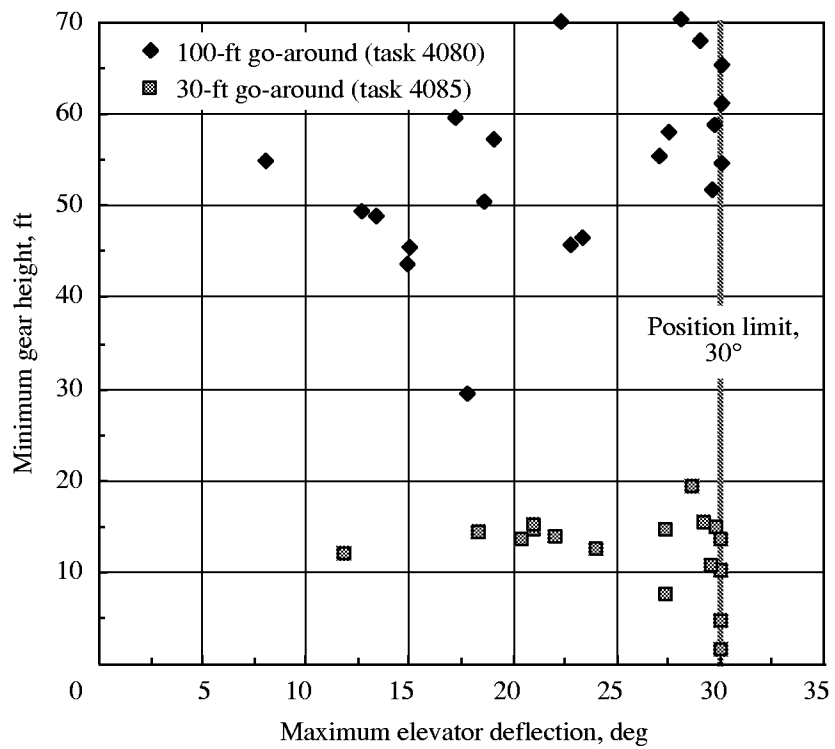

Figure 30. Minimum gear height as function of maximum elevator deflection for aborted landing (tasks 4080 and 4085).

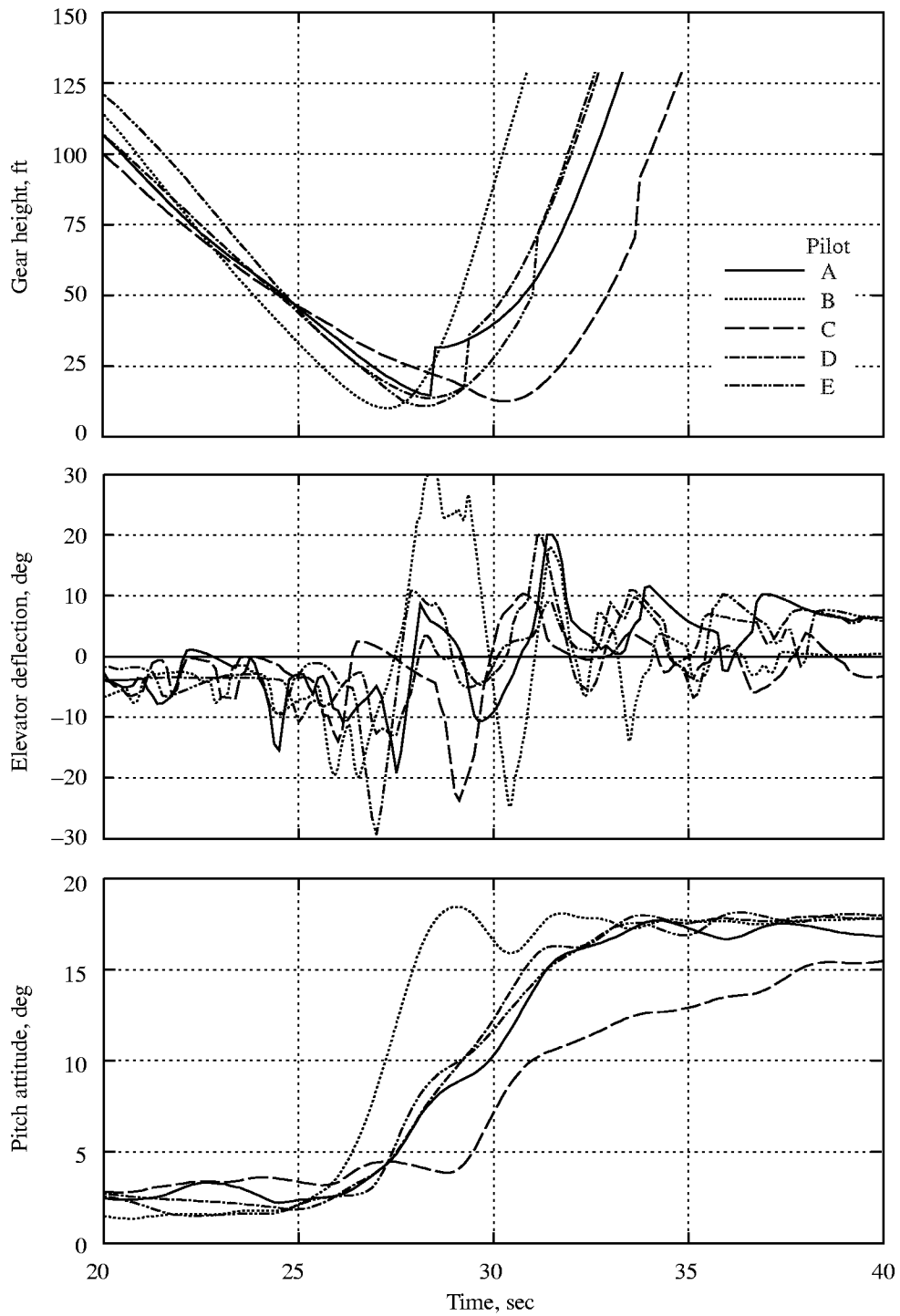
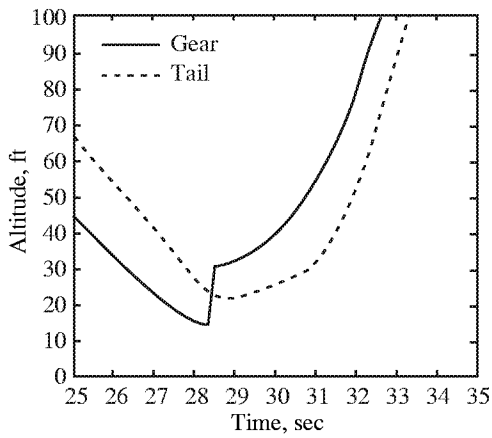
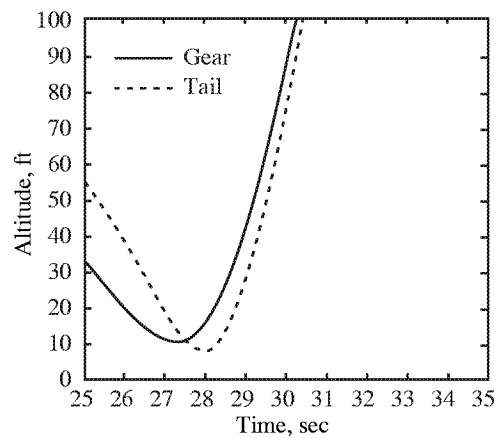

Figure 31. Typical time histories for 30-ft landing abort (task 4085).



(a) Pilot A.



(b) Pilot B.

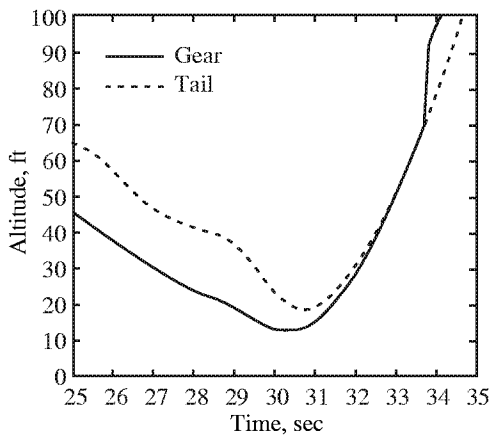

(c) Pilot C.

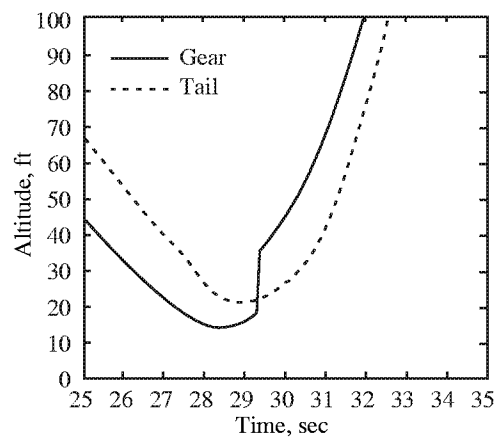

(d) Pilot D.

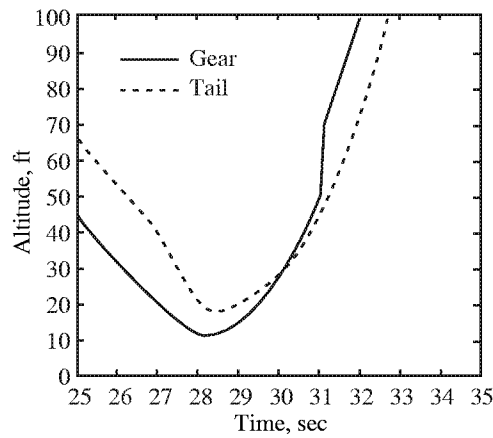

(e) Pilot E.

Figure 32. Gear altitude and tail altitude from representative time histories for 30-ft landing abort (task 4085).

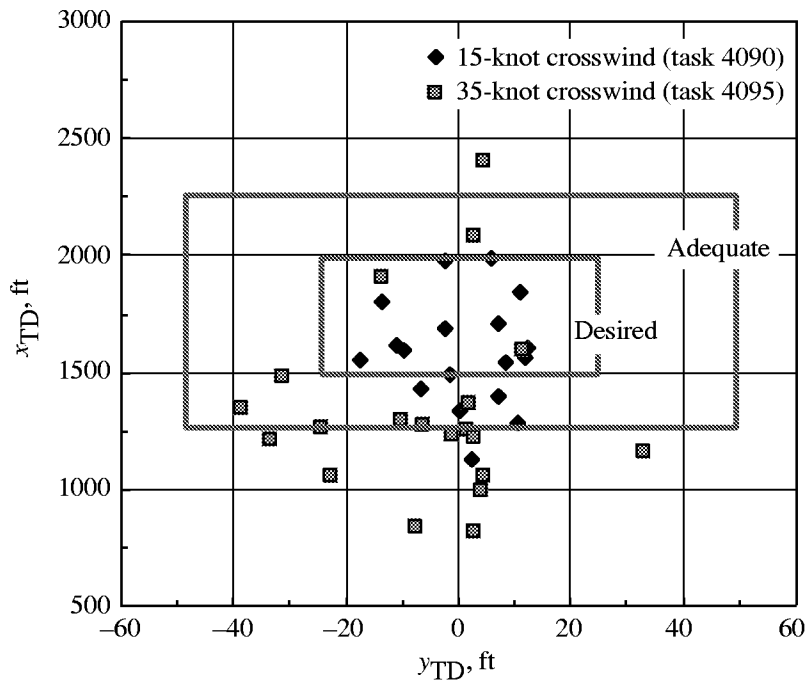

(a) Touchdown dispersions.

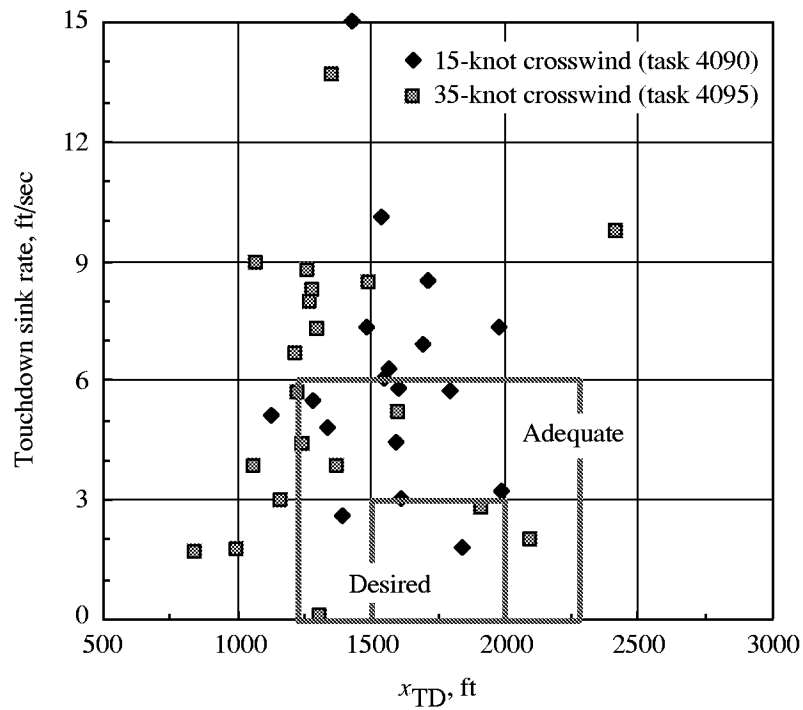

(b) Touchdown sink rates.

Figure 33. Touchdown performance for crosswind approach and landing (tasks 4090 and 4095).

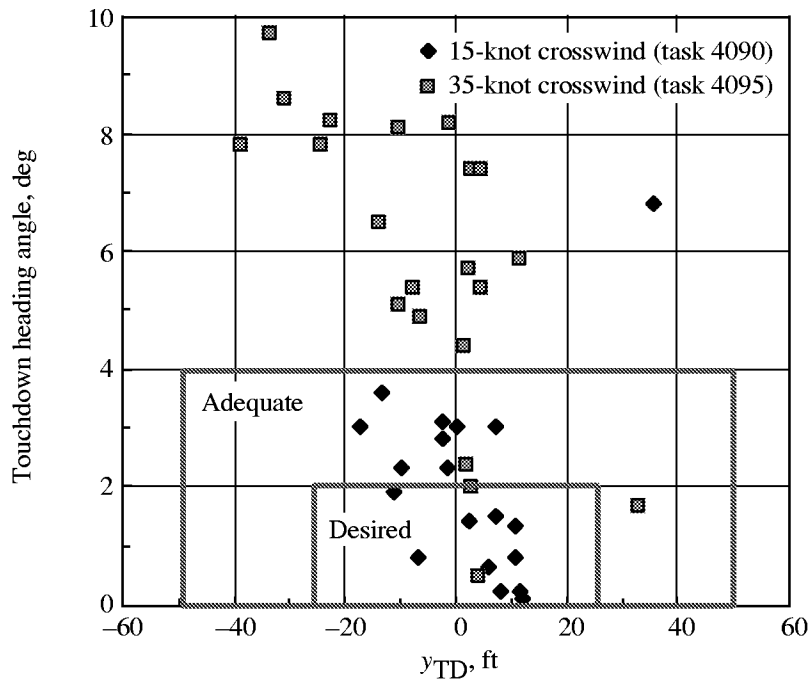

(c) Touchdown heading.

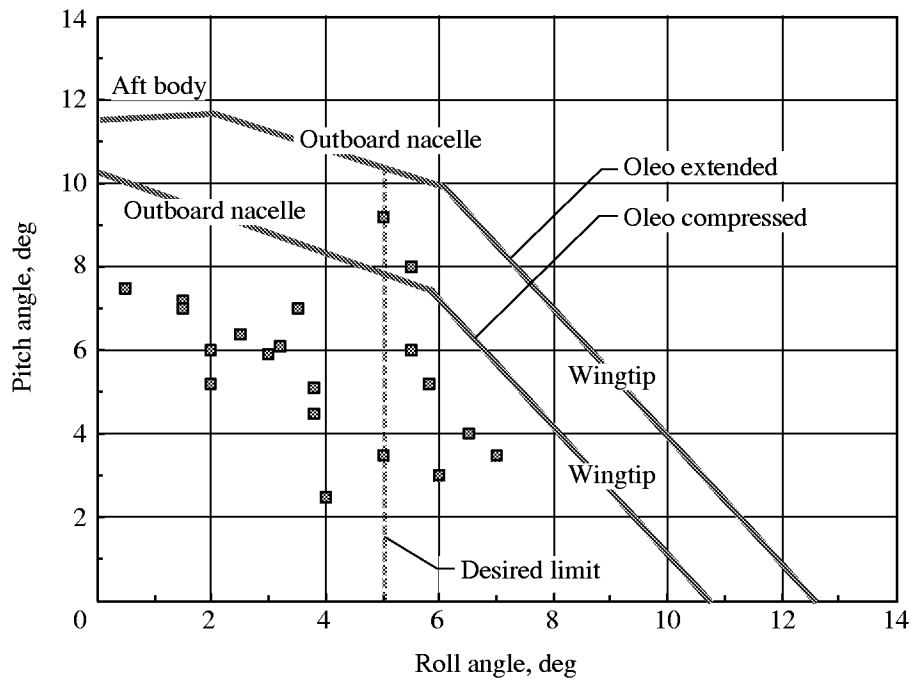

(d) Touchdown geometry strike envelope with data from 35-knot crosswind landing.

Figure 33. Concluded.

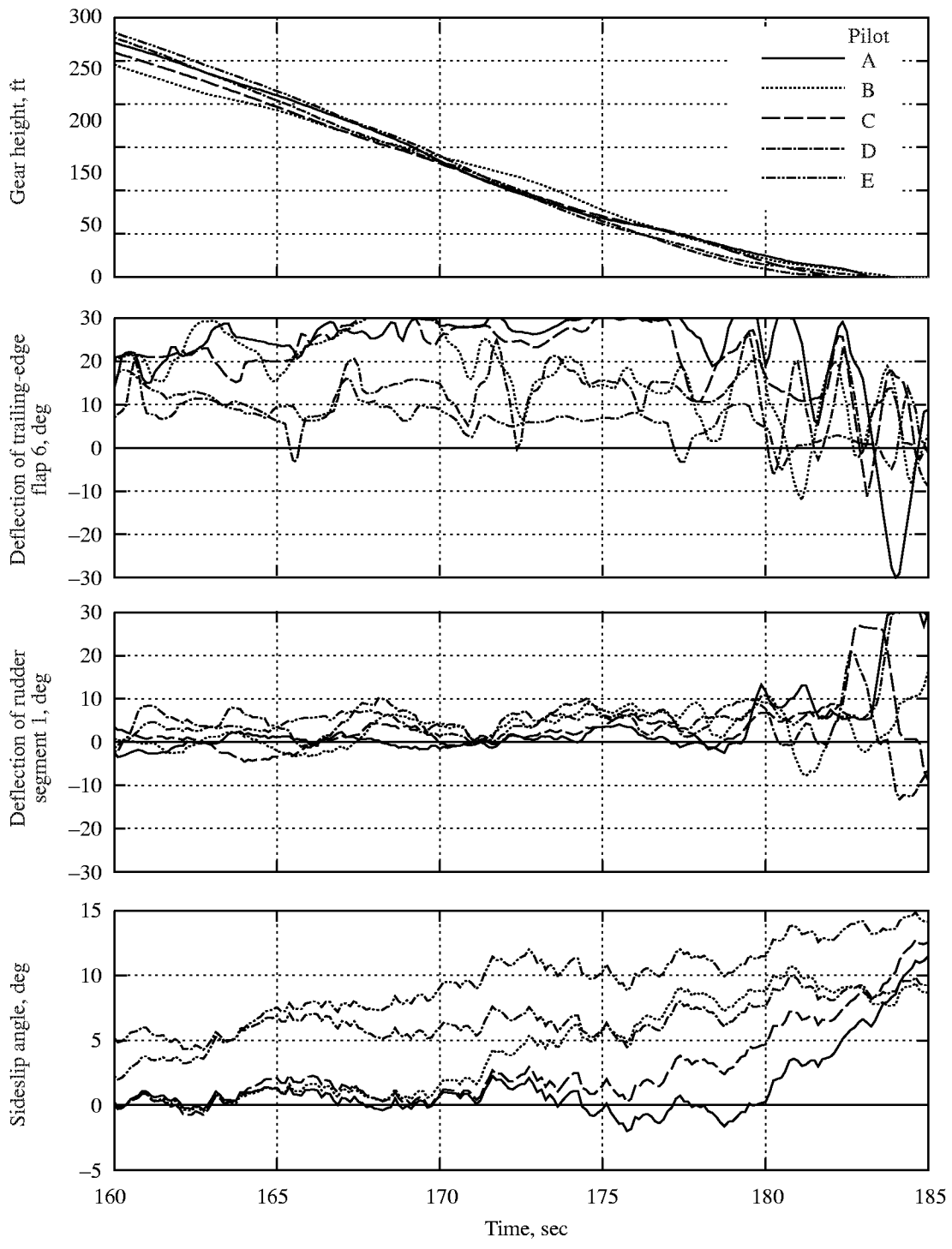

Figure 34. Typical time histories for final segment of landing with 35-knot crosswind (task 4095).

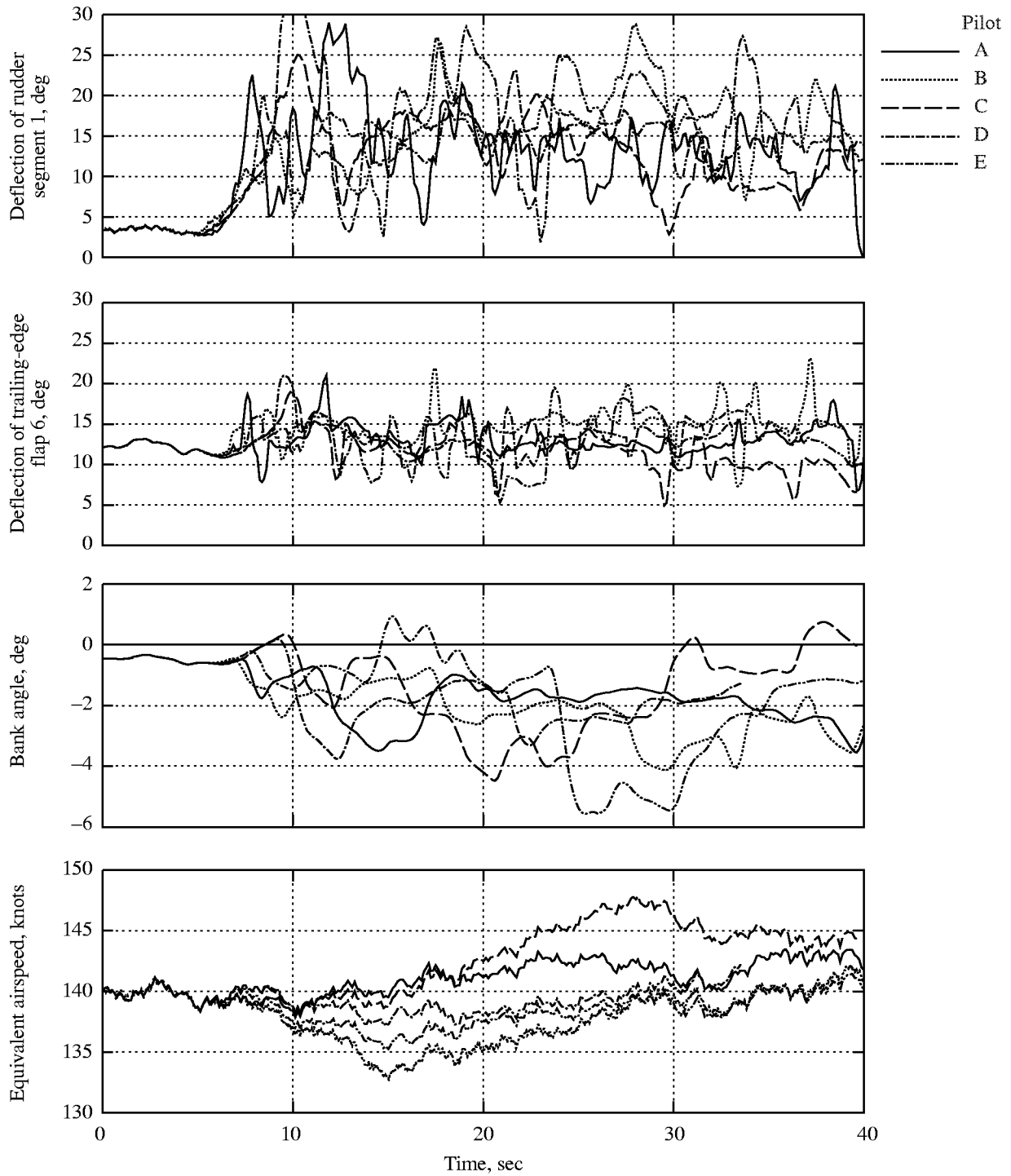

Figure 35. Typical time histories for $V_{\text{mc1-2}}$ demonstration (task 7050).

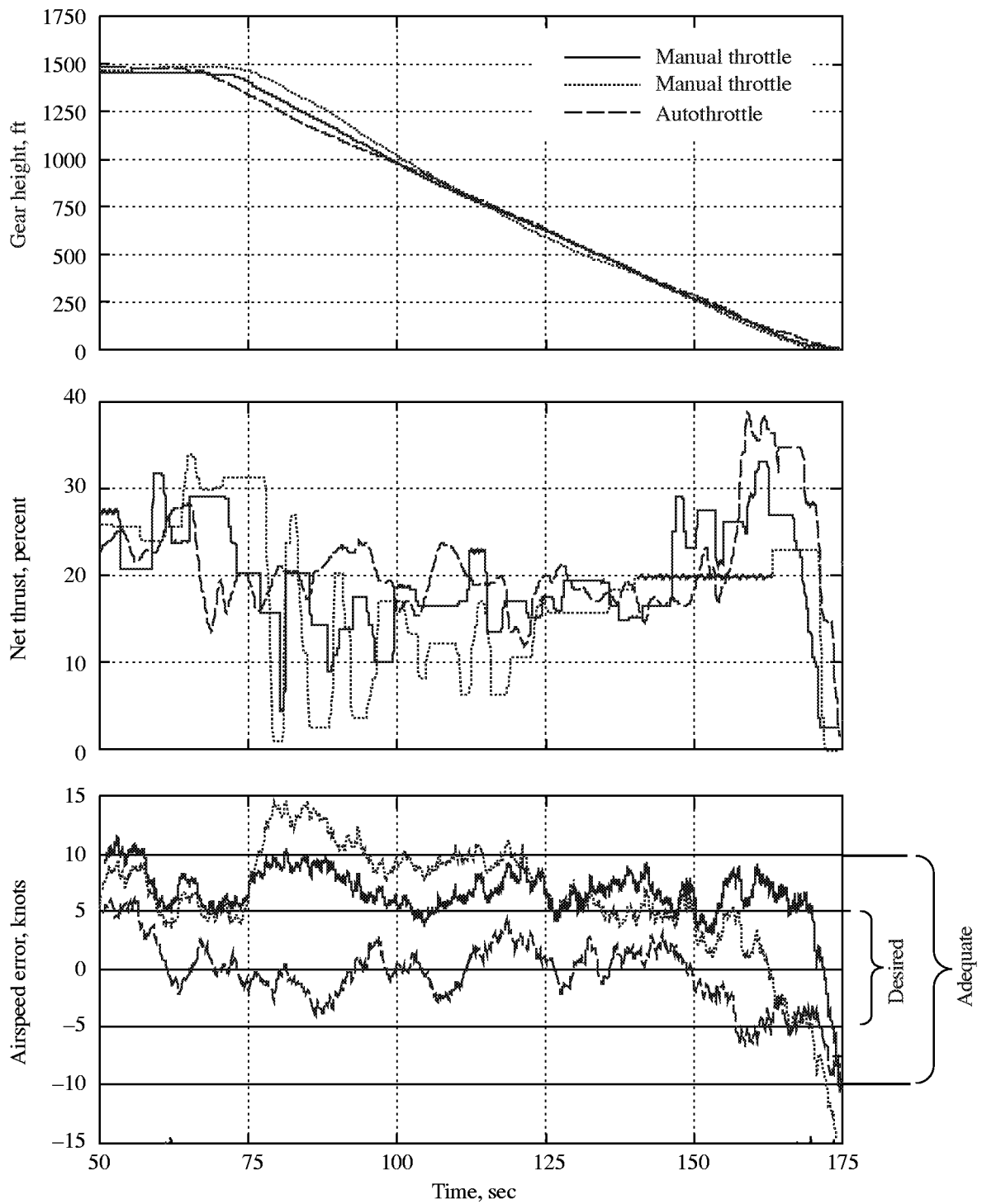

Figure 36. Typical time histories for manual throttle approach (task 7095).

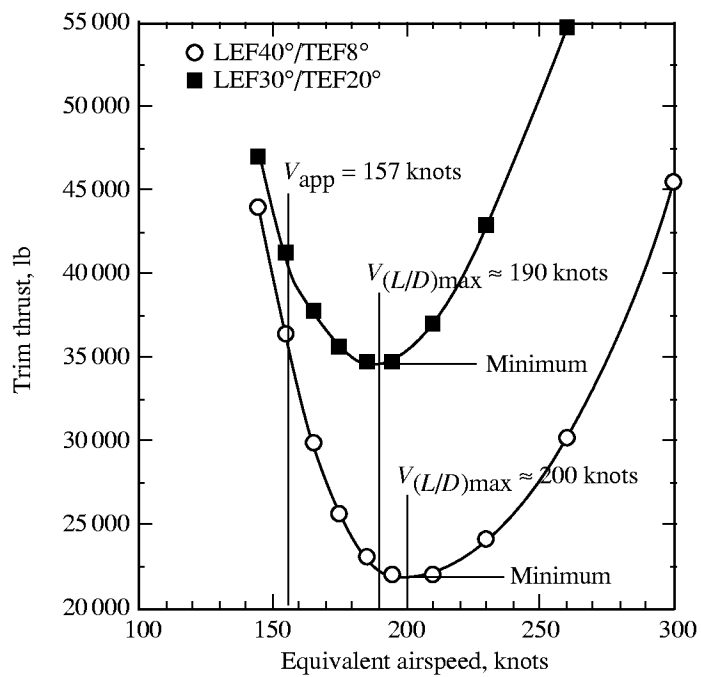

Figure 37. Thrust-required curves showing backside transition airspeeds for two different flap settings. Gear down; glide slope, -3° ; vortex fences retracted.

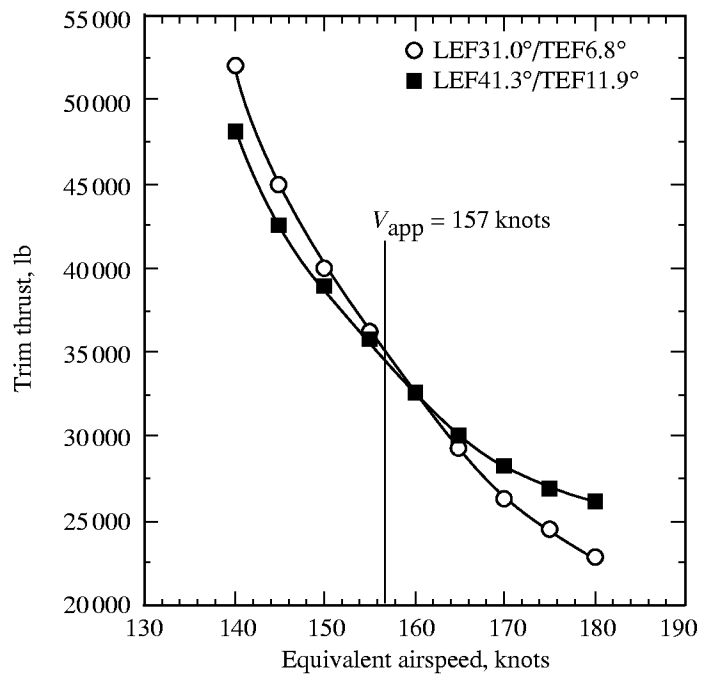

Figure 38. Thrust-required curves for two approach flap settings. Landing gear down; glide slope, -3° ; vortex fences retracted.

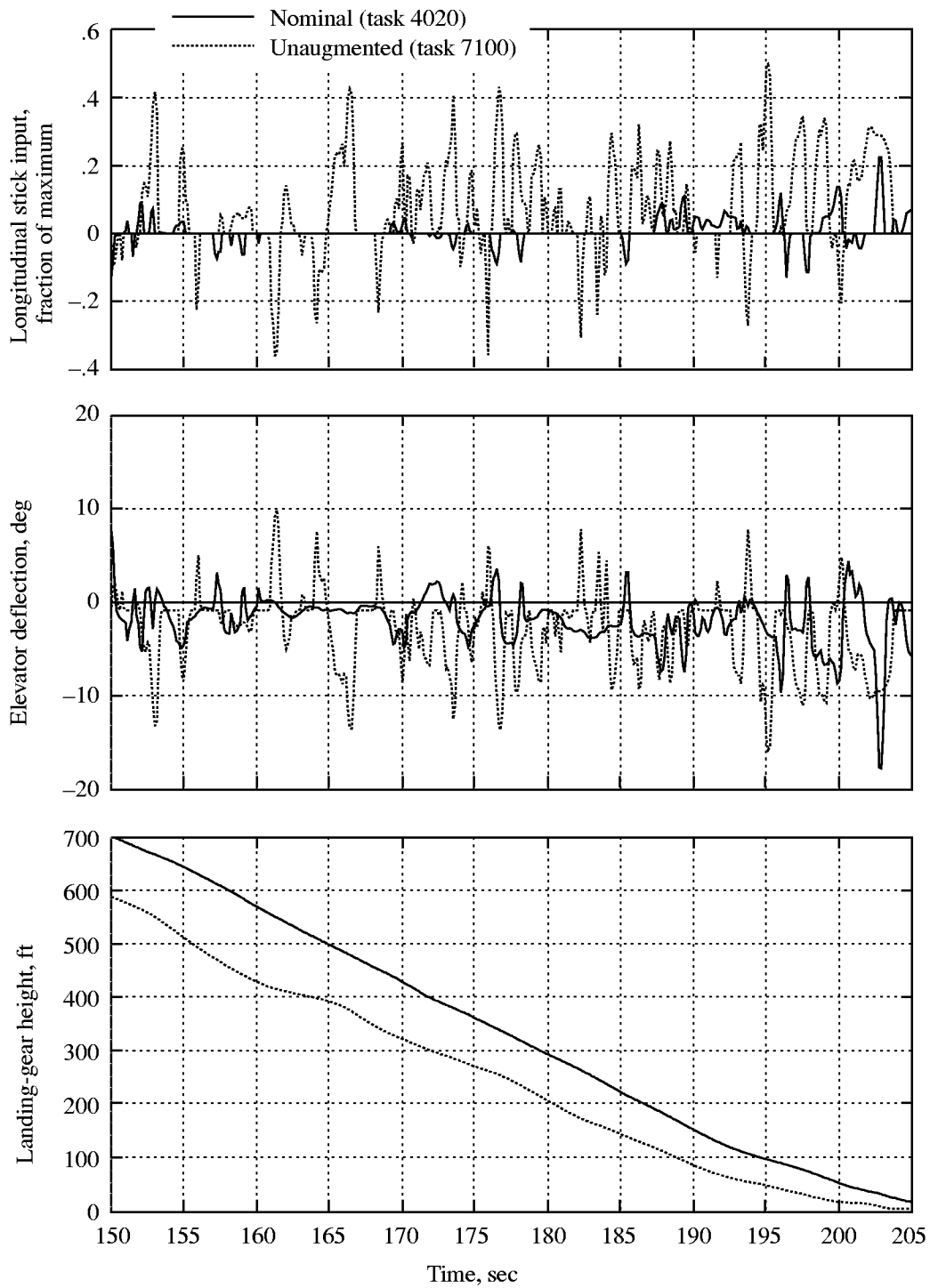

Figure 39. Typical time histories for nominal and unaugmented landings (tasks 4020 and 7100) for Pilot E.

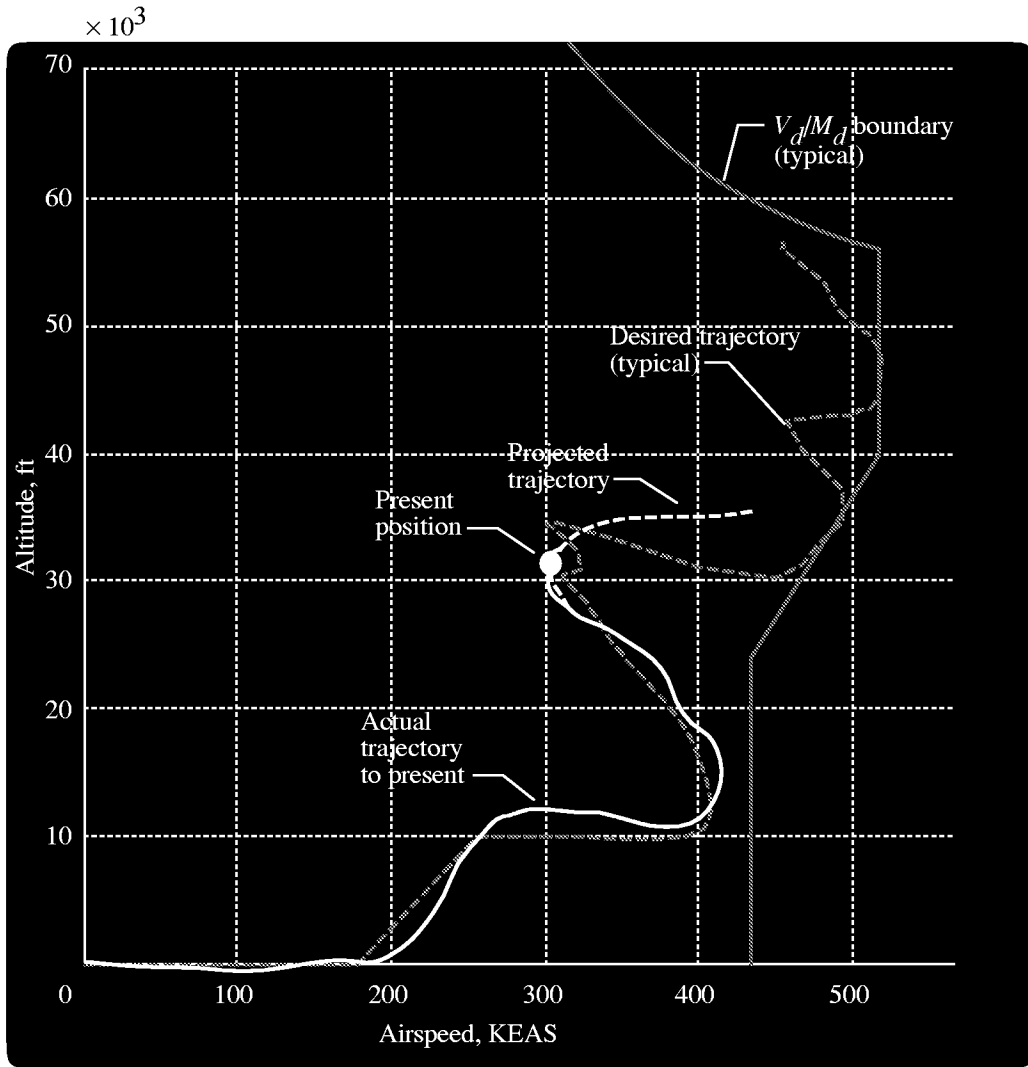

Figure 40. Schematic of velocity-altitude display.

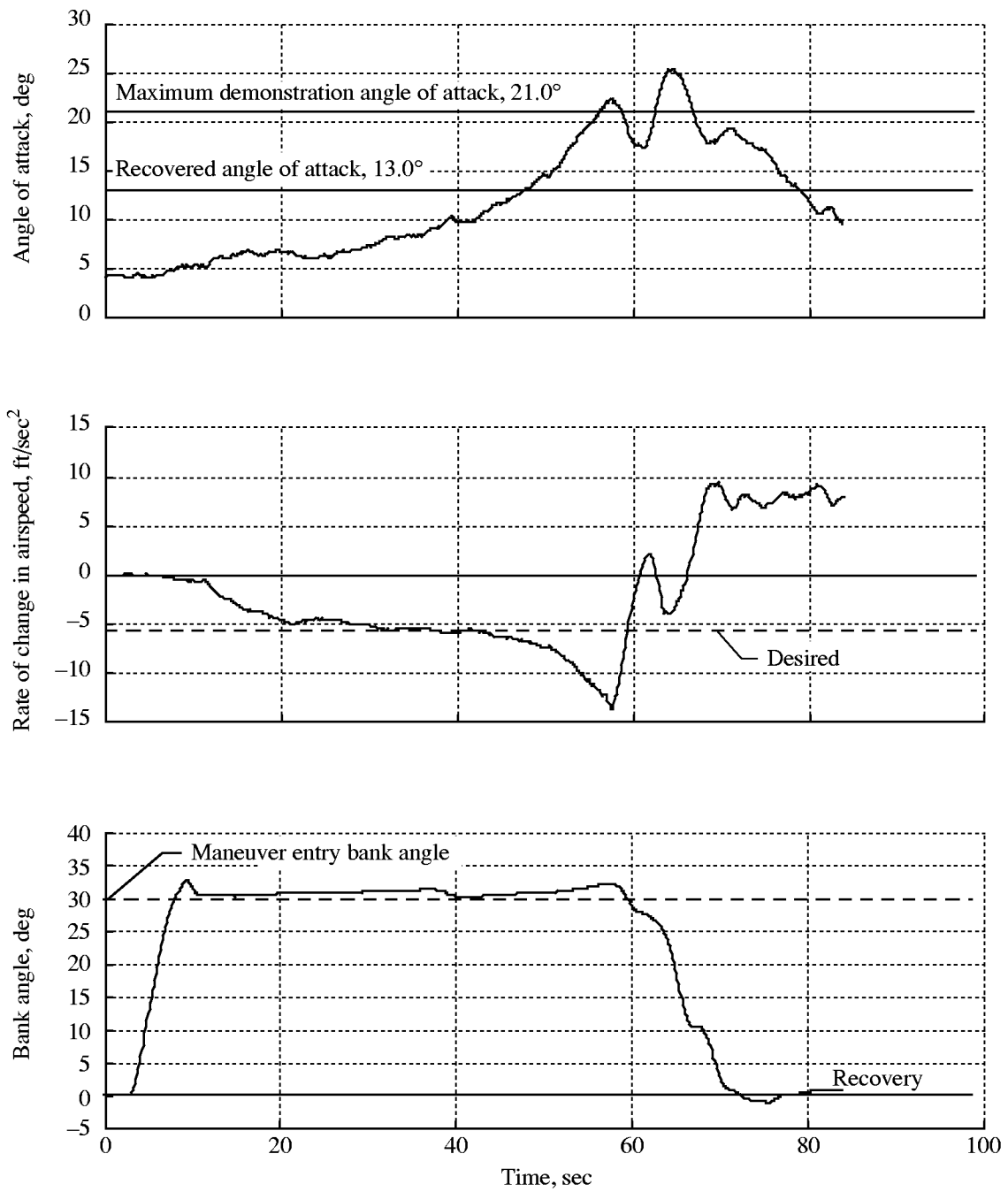

Figure 41. Typical time histories for data from minimum thrust turning RFLF maneuver (task 5040).

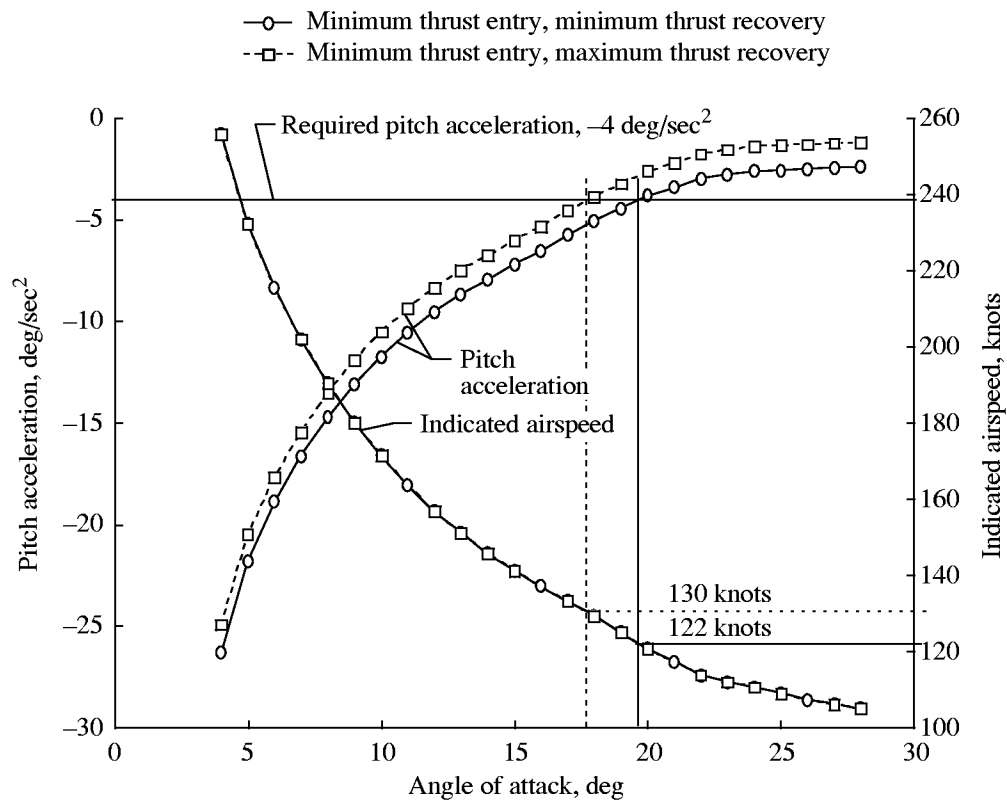

Figure 42. Pitch acceleration and indicated airspeed as function of pitch-trimmed angle of attack. Constant minimum thrust during maneuver entry and recovery; minimum thrust maneuver entry with maximum thrust recovery; assumed perfect 1g flight.

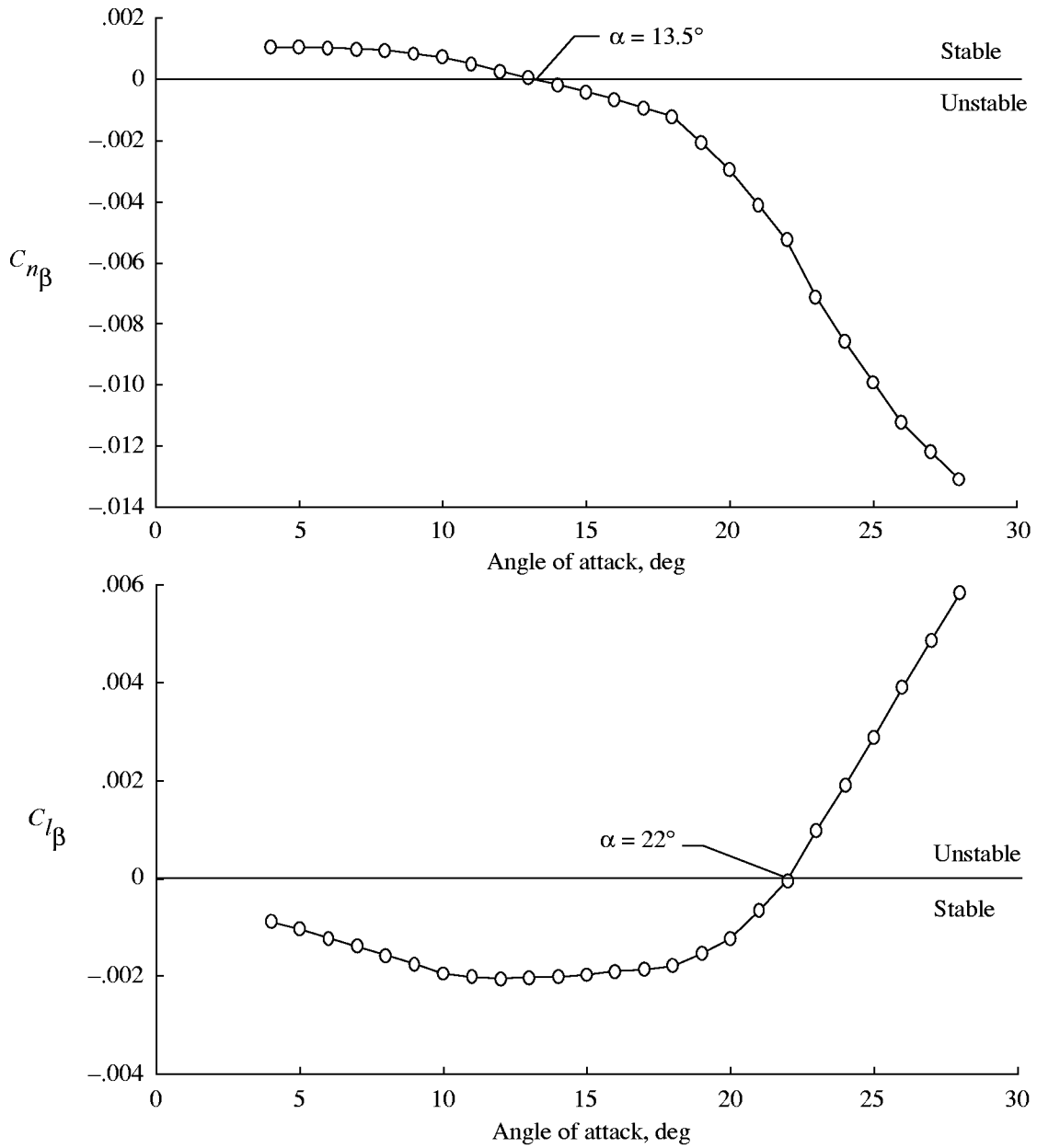

Figure 43. $C_{l\beta}$ and $C_{n\beta}$ as function of angle of attack for Ref-H configuration. Automatic flaps based on Mach; Mach calculated from pitch-trimmed C_L ; QSAE aerodynamics.

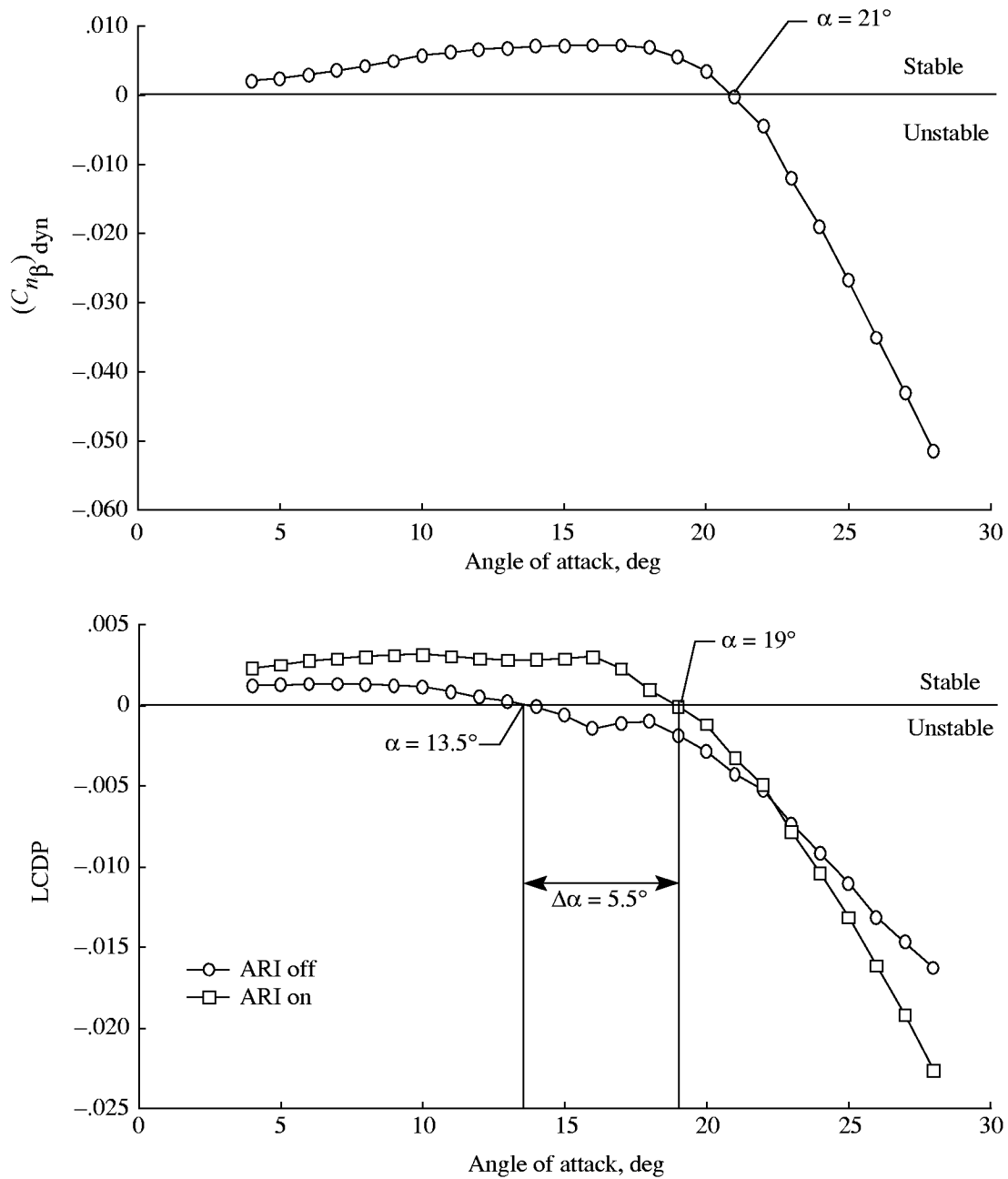
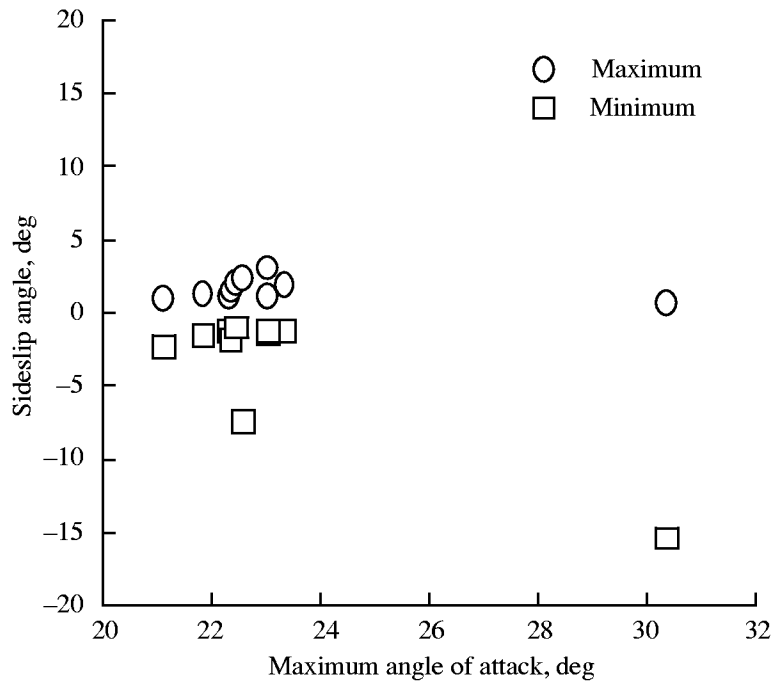
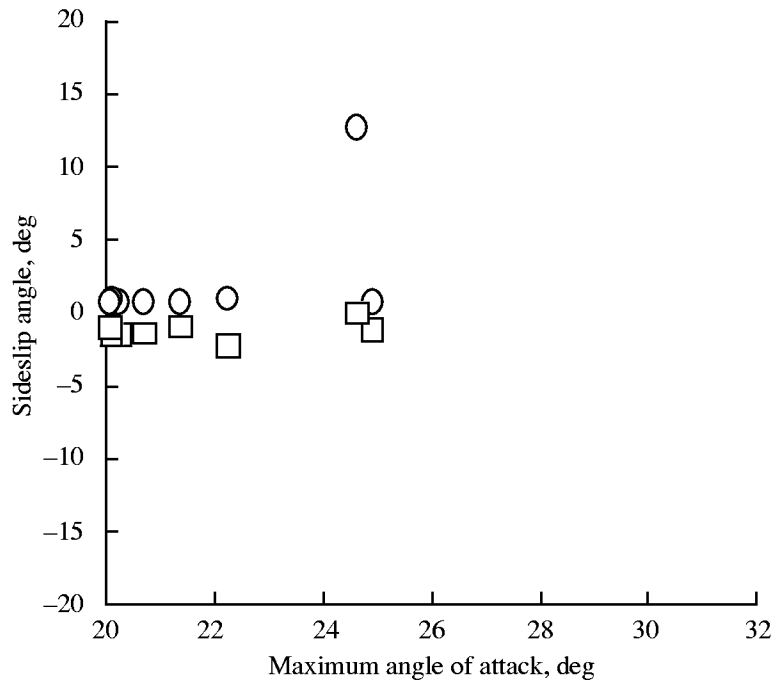

Figure 44. $(C_{n\beta})_{dyn}$ and LCDP as function of angle of attack for Ref-H configuration. Automatic flaps based on Mach; Mach calculated from pitch-trimmed C_L ; QSAE aerodynamics.



(a) Nonturning RFLF maneuver, idle power (task 5010).



(b) Nonturning RFLF maneuver, maximum takeoff power (task 5020).

Figure 45. Pilot performance for all symmetric thrust RFLF maneuvers.

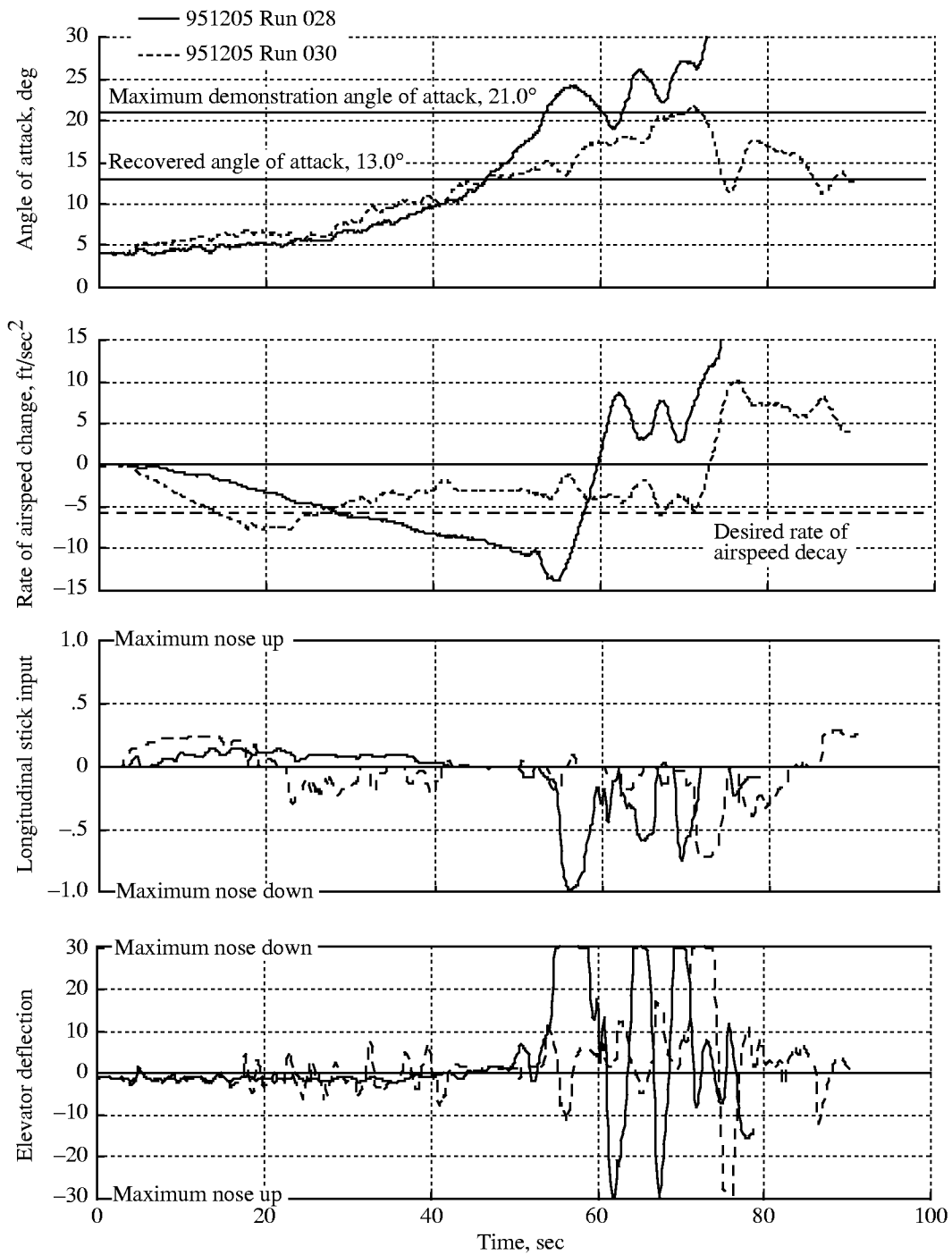

Figure 46. Effect of airspeed decay on maximum angle of attack. Maneuver evaluations performed by Pilot D.

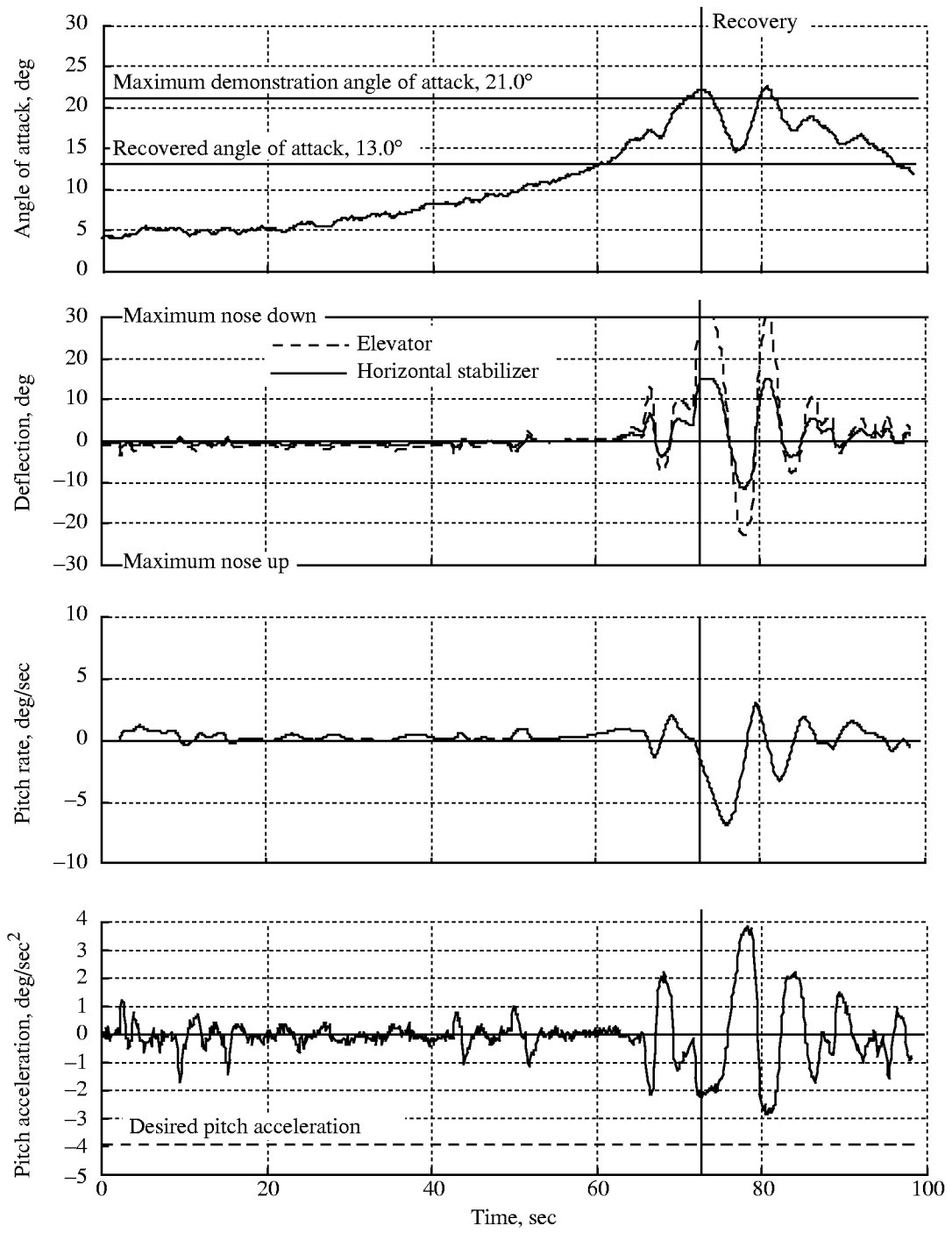

Figure 47. Time histories for effective nose-down control authority from minimum thrust nonturning RFLF maneuver (task 5010).

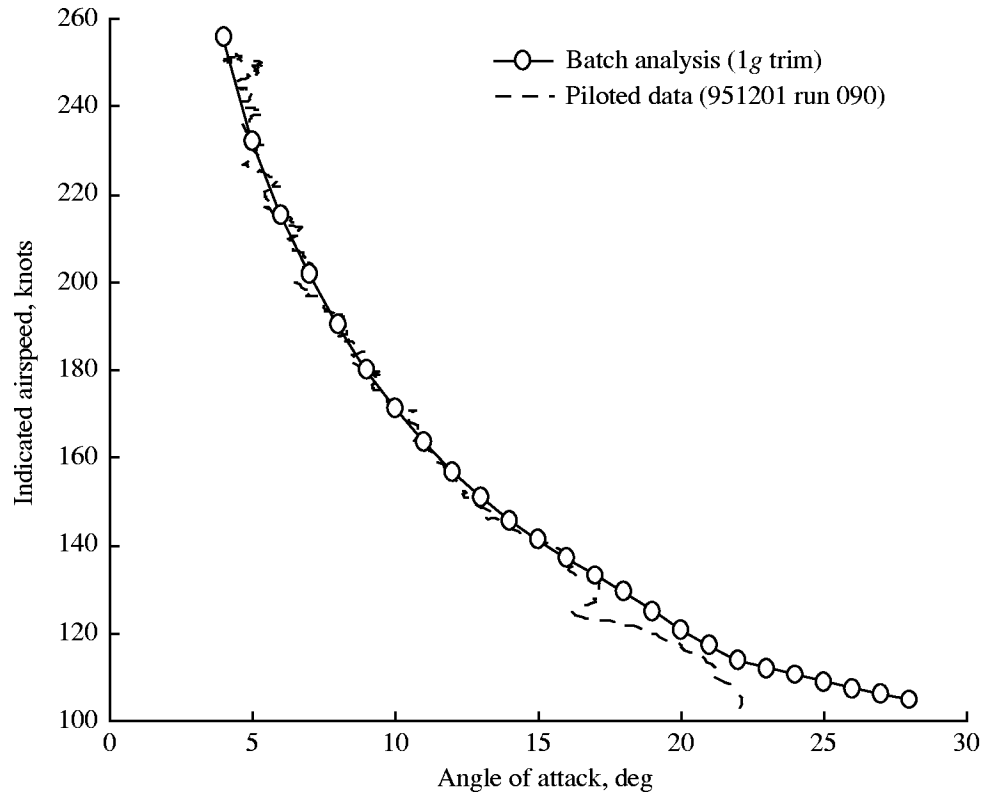
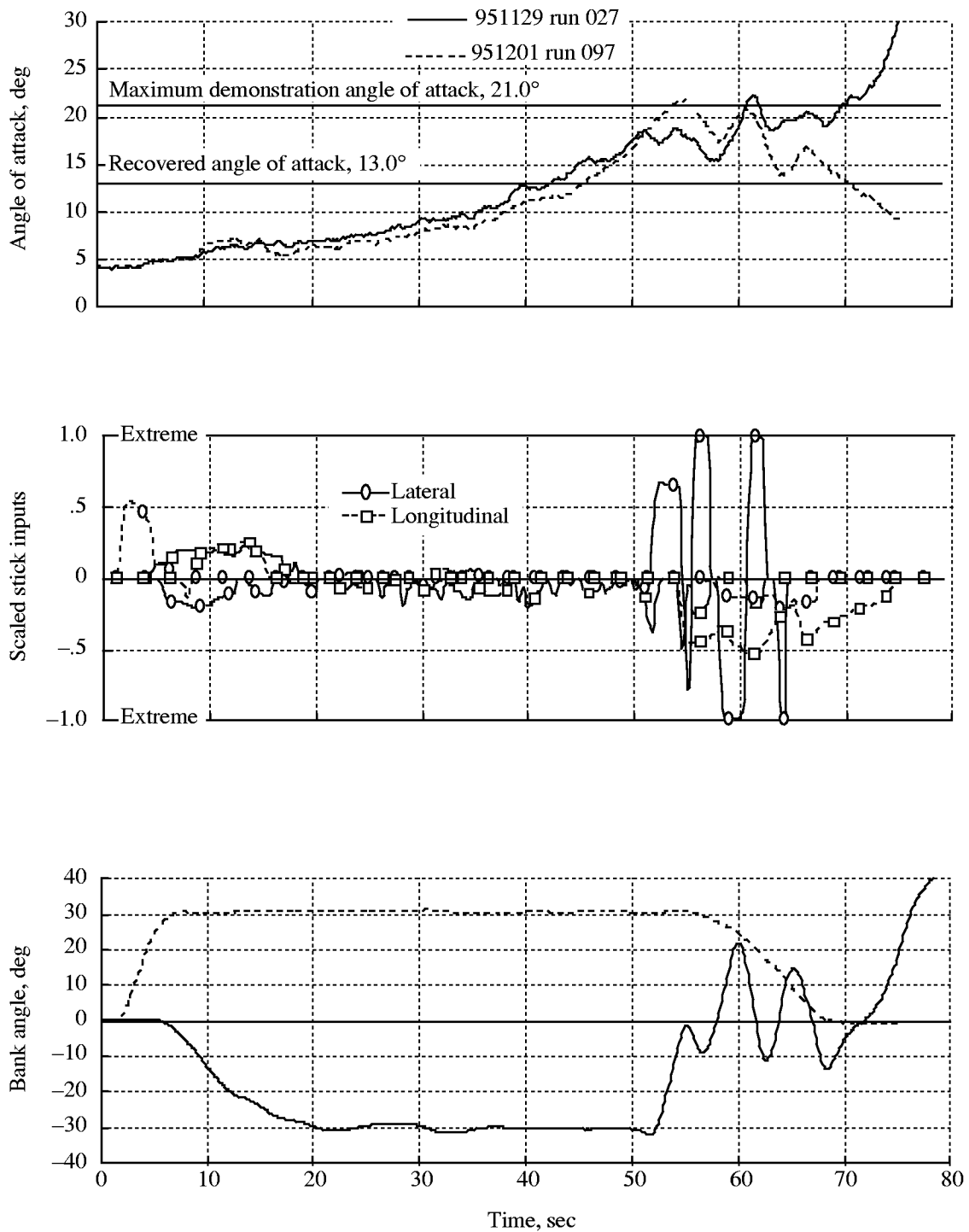
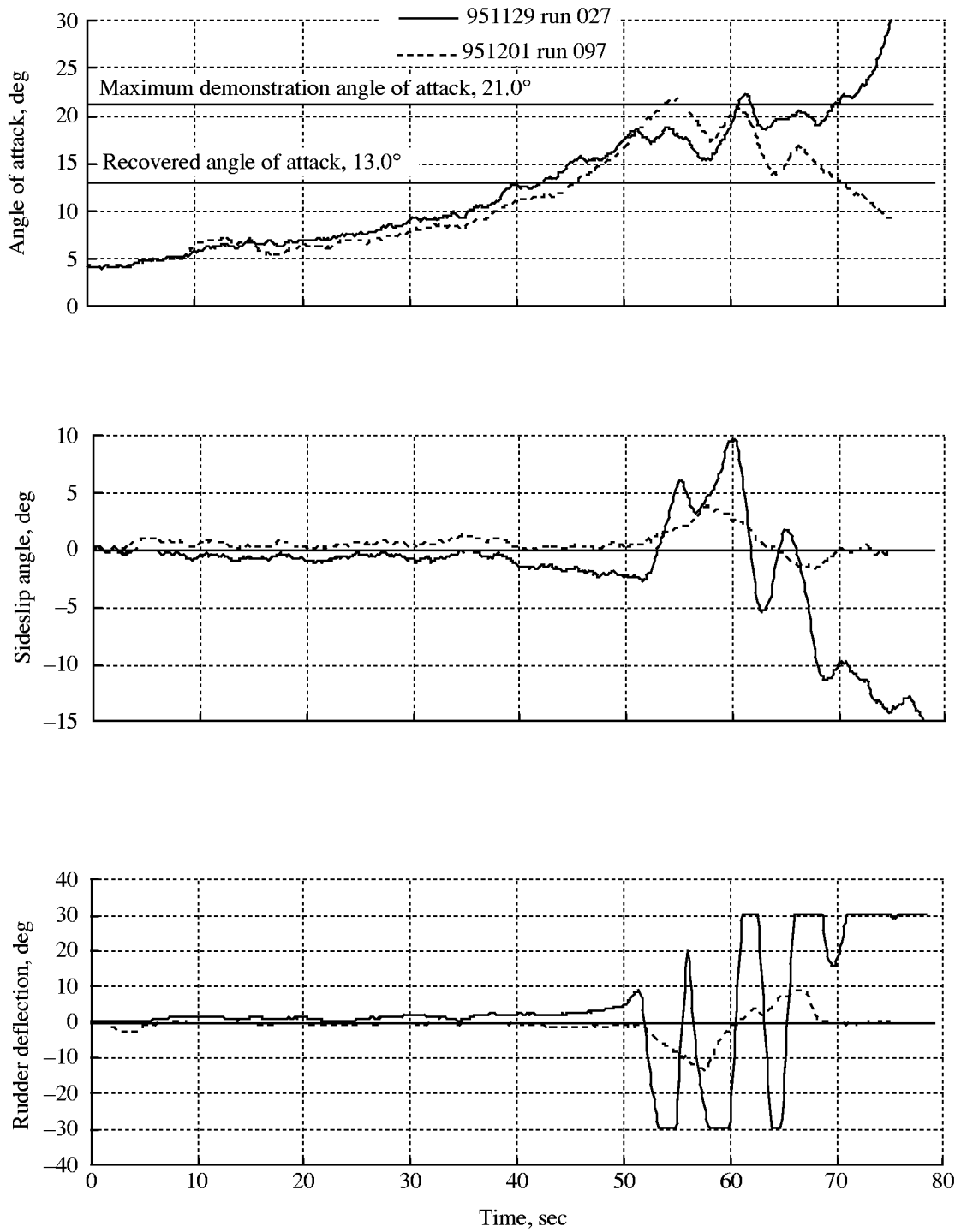

Figure 48. Indicated airspeed as function of angle of attack for data from batch analysis and piloted simulation time history from minimum thrust nonturning RFLF maneuver (task 5010).



(a) Angle of attack, stick inputs, and bank angle.

Figure 49. Time history for turning thrust for level flight RFLF maneuver (task 5050) from two evaluations.



(b) Angle of attack, sideslip angle, and rudder deflection.

Figure 49. Concluded.

Legend

CHR level	Description	CHR value		
Level I	Satisfactory	1	2	3
Level II	Marginal	4	5	6
Level III	Deficient	7	8	9
Level III+	Uncontrollable	10		

Task	Flight card name	Longitudinal axis						Lateral-directional axis							
		Pilot					avg	σ	Pilot					avg	σ
		A	B	C	D	E			A	B	C	D	E		
Recovery from limit flight envelope															
5020	Stall—max takeoff power	NR	3	5	3	3	3.50	1.00	NR	2	2	2	4	2.50	1.00
5010	Stall—idle power	NR	NR	3	5	3	3.67	1.15	NR	NR	3	3	2	2.67	0.58
5040	Turning stall—idle power	NR	4	3	5	3	3.75	0.96	NR	4	8	6	4	5.50	1.91
5050	Turning stall—TFLF	NR	4	8	5	4	5.25	1.89	NR	4	8	6	3	5.25	2.22
7070	Engine-out stall	4	3	5	5	3	4.00	1.00	7	4	8	10	4	6.60	2.61
7080	Engine-out turning stall	10	3	6	5	4	5.60	2.70	10	5	6	6	4	6.20	2.28
5060	Diving pullout	4	4	8	7	5	5.60	1.82	2	2	3	2	3	2.40	0.55
Operations after failure, upsets															
7060	Ripple unstart	4	2	7	8	4	5.00	2.45	4	4	5	8	4	5.00	1.73
6050	Inadvertent speed increase	4	1	2	NR	3	2.50	1.29	2	2	2	NR	3	2.25	0.50
6060	2-axis upset	4	4	4	5	3	4.00	0.71	5	2	3	3	4	3.40	1.14
7010	Directional control with one engine inop.	3	4	3	5	4	3.80	0.84	9	9	8	4	5	7.00	2.35
7020	Lateral control with one engine inop.	2	3	4	5	3	3.40	1.14	2	3	4	5	4	3.60	1.14
7040	Minimum control speed—air	8	3	5	5	3	4.80	2.05	8	5	5	5	3	5.20	1.79
Trajectory management															
3030	Profile climb	4	2	5	3	3	3.40	1.14	4	2	5	5	3	3.80	1.30
5070	Emergency descent	7	4	4	5	4	4.80	1.30	8	3	4	2	3	4.00	2.35
3050	Profile descent	2	3	4	4	4	3.40	0.89	2	2	4	2	3	2.60	0.89

Figure 50. Cooper-Harper ratings summary for up-and-away maneuvers.

Legend

CHR level	Description	CHR value		
Level I	Satisfactory	1	2	3
Level II	Marginal	4	5	6
Level III	Deficient	7	8	9
Level III+	Uncontrollable	10		

Task	Flight card name	Longitudinal axis						Lateral-directional axis							
		Pilot					avg	σ	Pilot					avg	σ
		A	B	C	D	E			A	B	C	D	E		
Climb, cruise, and descent															
3020	Transition to level flight	4	2	4	5	3	3.60	1.14	2	2	3	2	2	2.20	0.45
3022	Transition to supersonic cruise	3	3	3	5	NR	3.50	1.00	4	2	3	2	NR	2.75	0.96
3040	Level flight trans. to climb	1	4	3	NR	3	2.75	1.26	1	2	3	NR	3	2.25	0.96
3060	Transition to supersonic descent	3	3	3	NR	5	3.50	1.00	2	2	3	NR	2	2.25	0.50
3062	Transition to transonic descent	2	3	3	NR	5	3.25	1.26	2	3	3	NR	2	2.50	0.58
3070	Airspeed change in subsonic climb	3	3	3	NR	4	3.25	0.50	2	3	3	NR	2	2.50	0.58
3074	Transonic deceleration	4	3	3	NR	4	3.50	0.58	2	2	3	NR	2	2.25	0.50
3076	Airspeed change in low altitude cruise	5	3	4	NR	4	4.00	0.82	2	3	3	NR	2	2.50	0.58
3080	Heading change in transonic climb	2	3	4	4	2	3.00	1.00	2	3	4	3	4	3.20	0.84
3084	Heading change in supersonic cruise	2	3	3	3	2	2.60	0.55	3	3	3	3	4	3.20	0.45
3086	Heading change in low altitude cruise	2	3	4	4	3	3.20	0.84	2	3	4	4	4	3.40	0.89
3088	Heading change in TCA descent	5	3	4	NR	4	4.00	0.82	2	4	4	NR	4	3.50	1.00
Miscellaneous tasks															
4012	Config. change in straight flight – mod. turb.	3	1	4	NR	4	3.00	1.41	2	1	3	NR	3	2.25	0.96

Figure 50. Concluded.

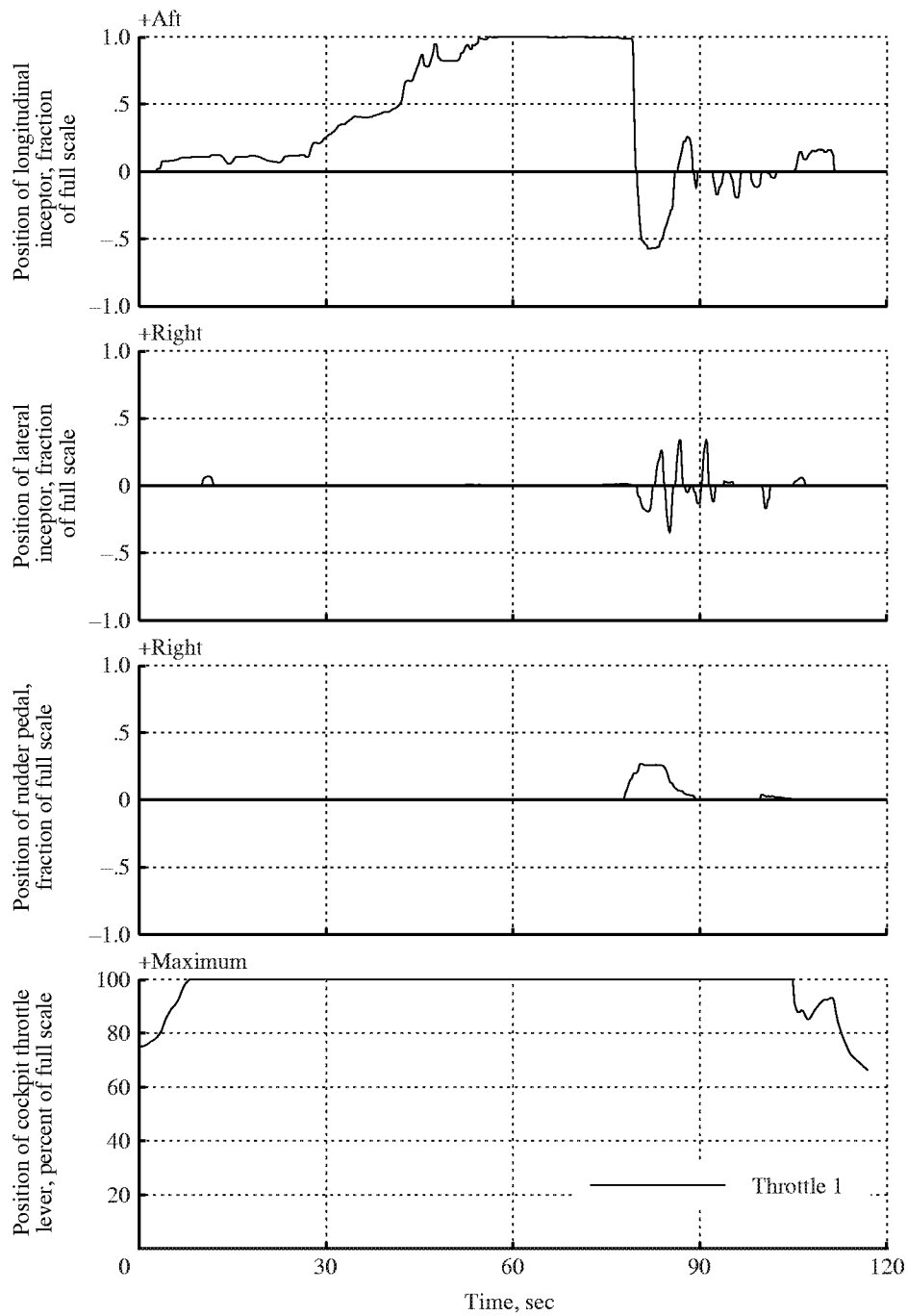

(a) Longitudinal and lateral stick inputs, rudder pedal inputs, and percent of maximum power lever 1.

Figure 51. Typical time histories for engine-out stall (task 7070).

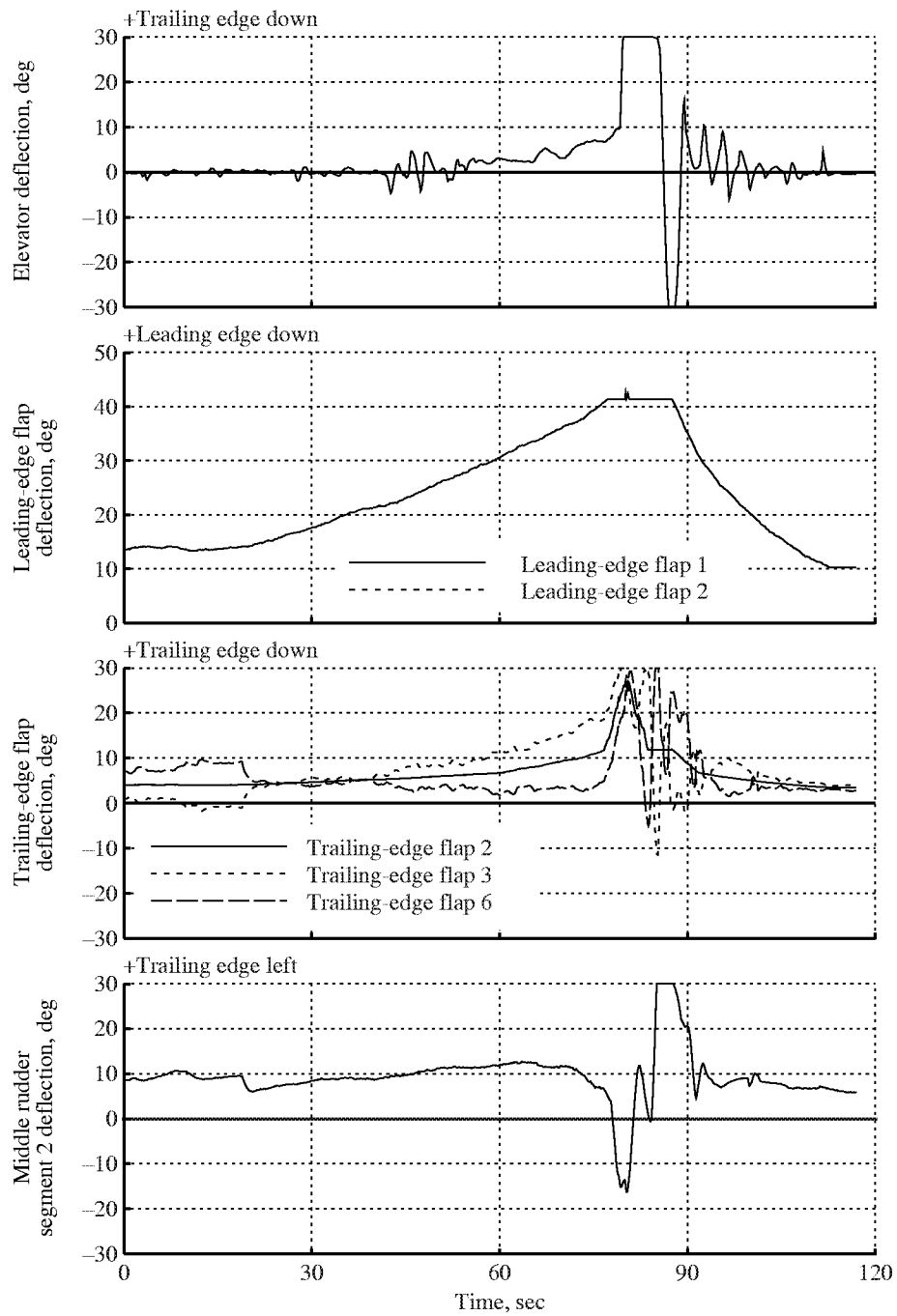

(b) Deflection of elevator; leading-edge flap segments 1 and 2; trailing-edge flap segments 2, 3, and 6; and middle rudder segment 2.

Figure 51. Continued.

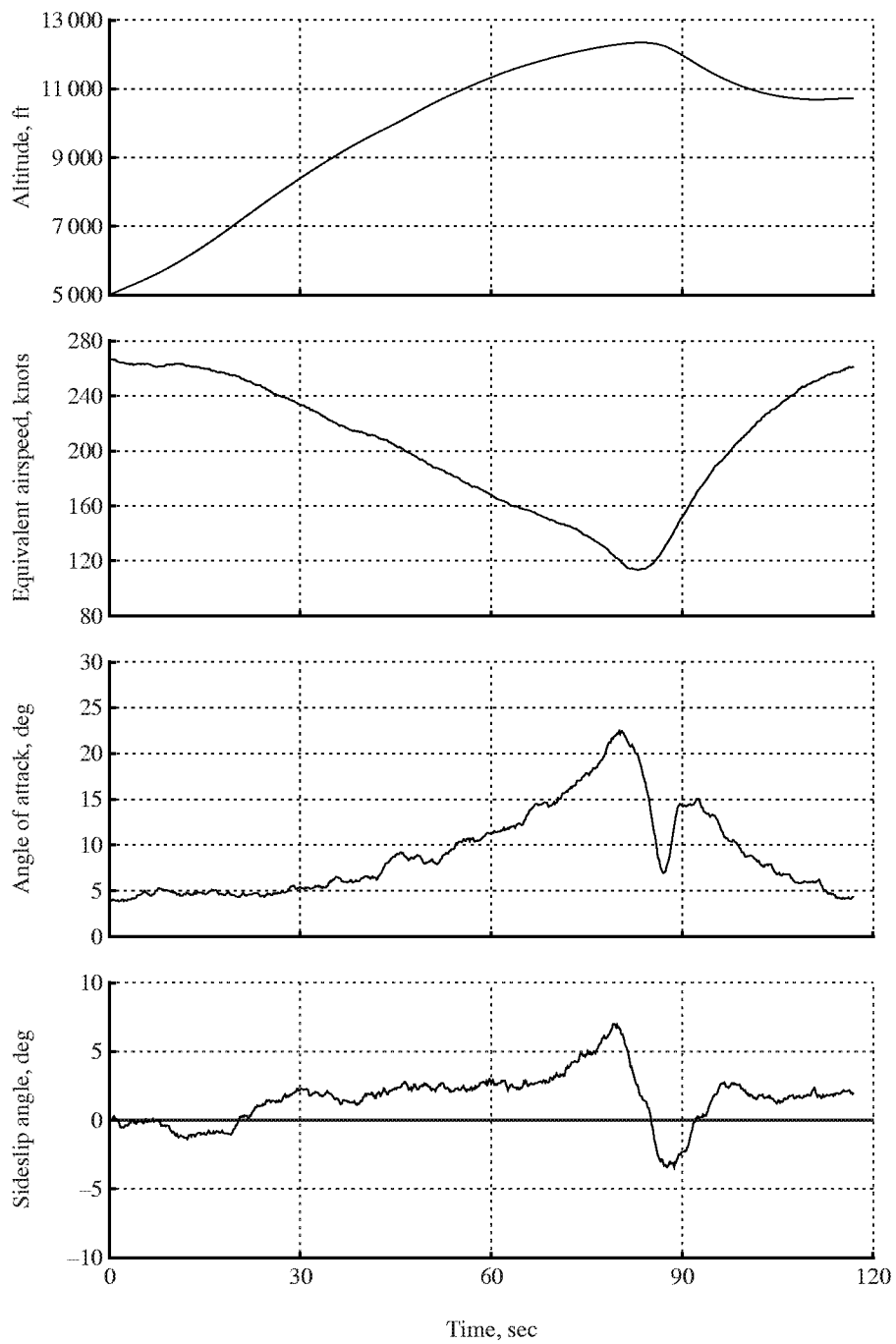

(c) Altitude, equivalent airspeed, angle of attack, and sideslip angle.

Figure 51. Continued.

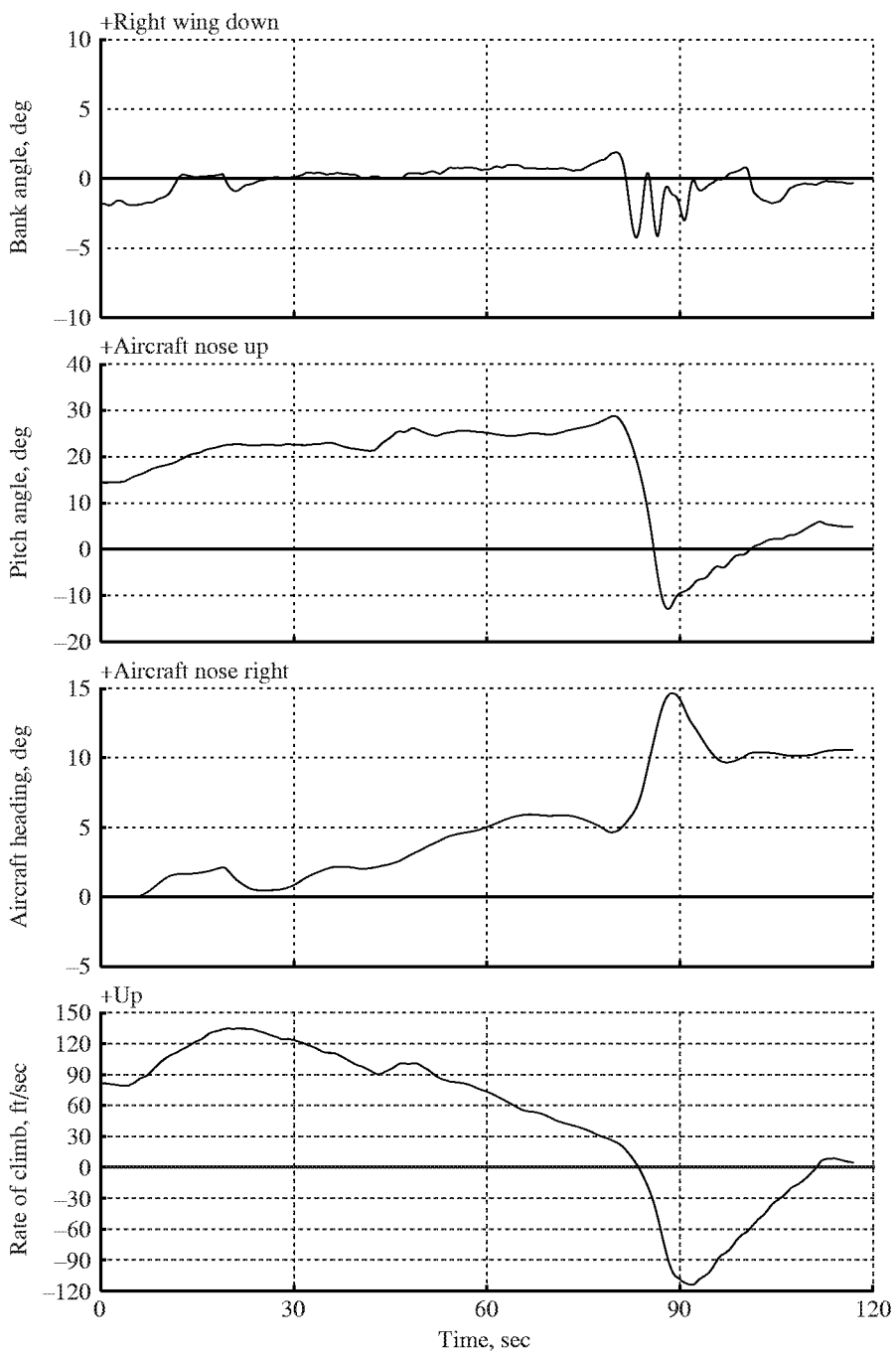

(d) Euler angles and rate of climb.

Figure 51. Continued.

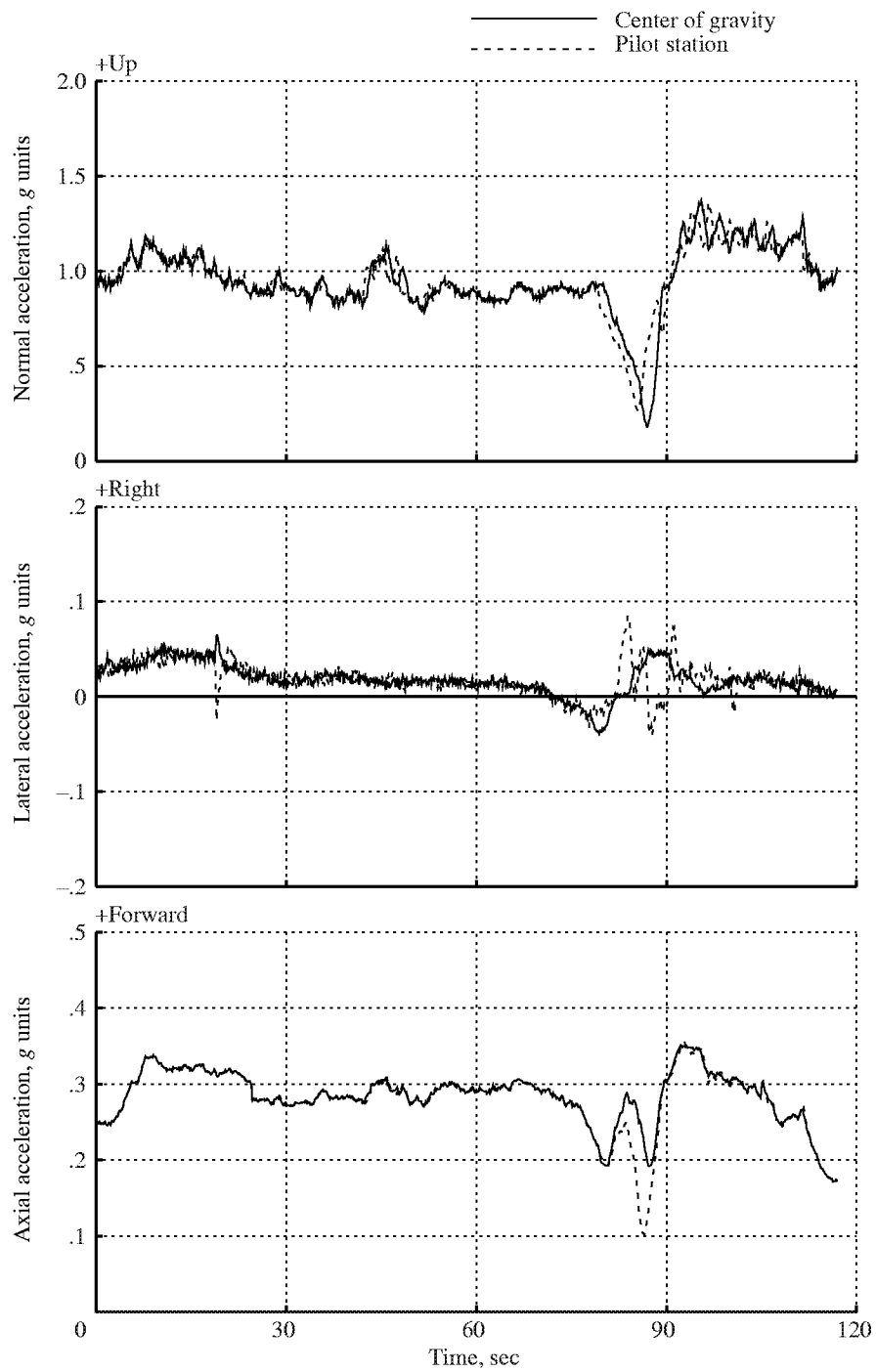

(e) Linear accelerations at center of gravity and pilot station.

Figure 51. Concluded.

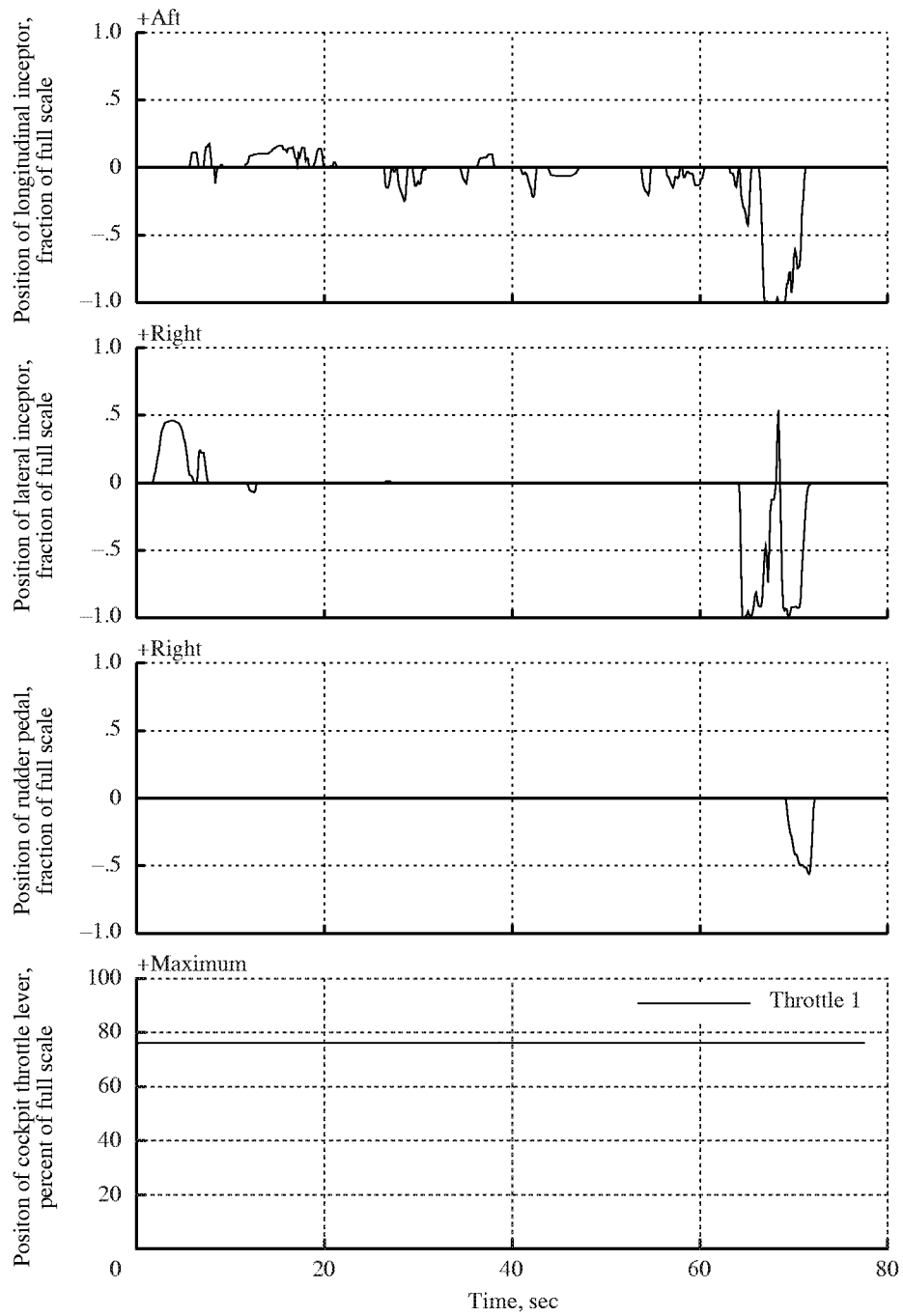

(a) Longitudinal and lateral stick inputs, rudder pedal inputs, and percent of maximum power lever 1.

Figure 52. Typical time histories for engine-out turning stall (task 7080) departure.

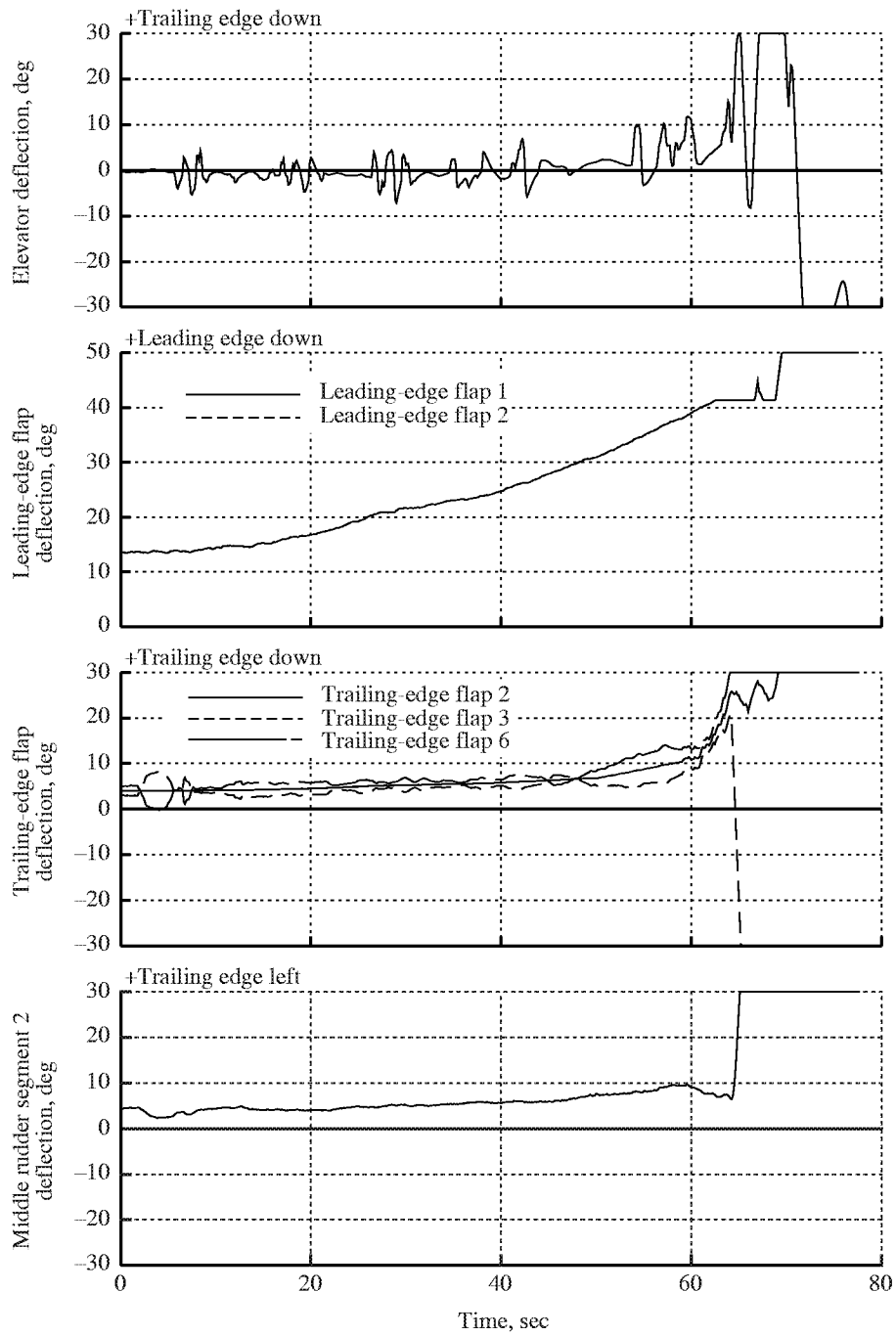

(b) Deflection of elevator; leading-edge flap segments 1 and 2; trailing-edge flap segments 2, 3, and 6; and middle rudder segment 2.

Figure 52. Continued.

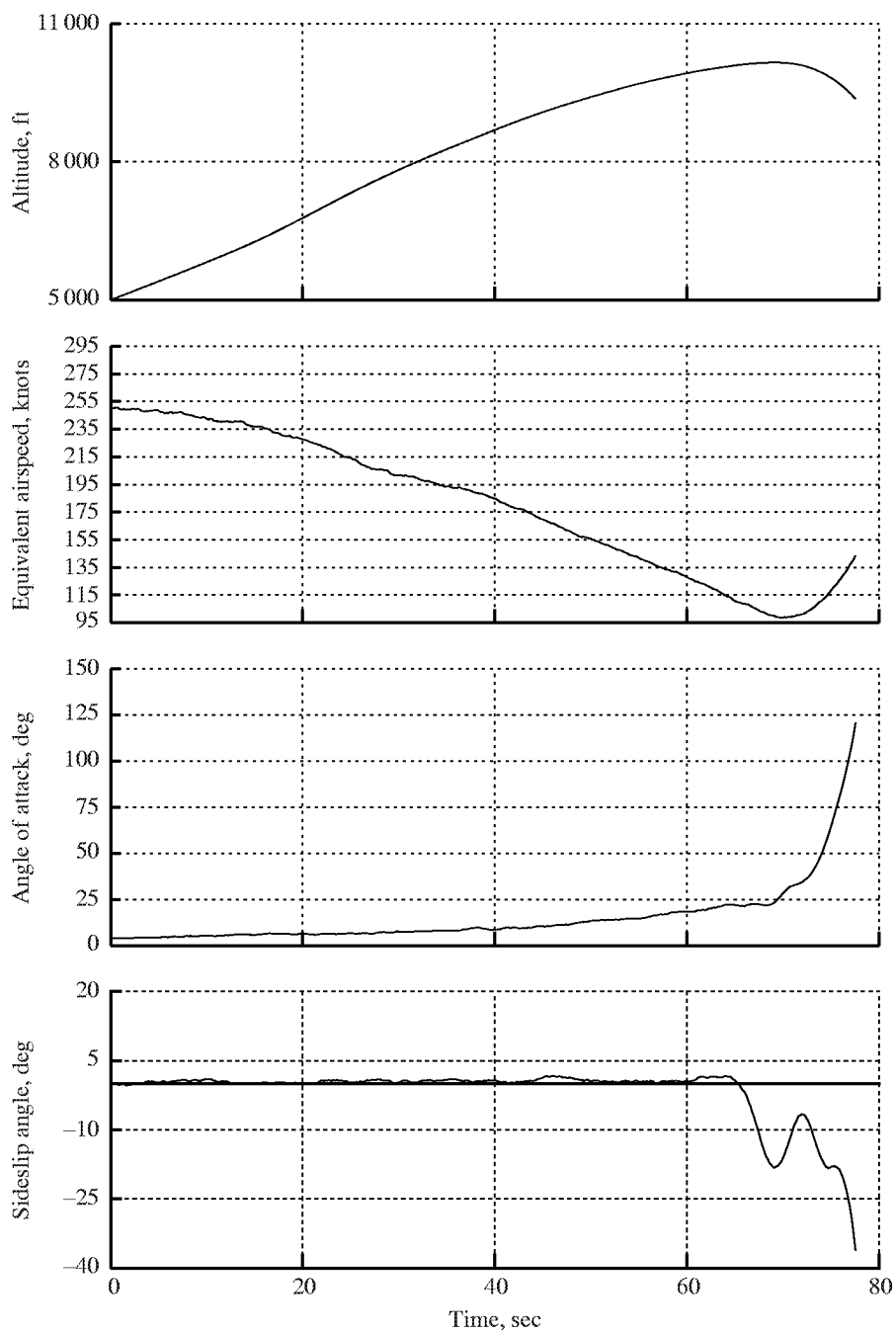

(c) Altitude, equivalent airspeed, angle of attack, and sideslip angle.

Figure 52. Continued.

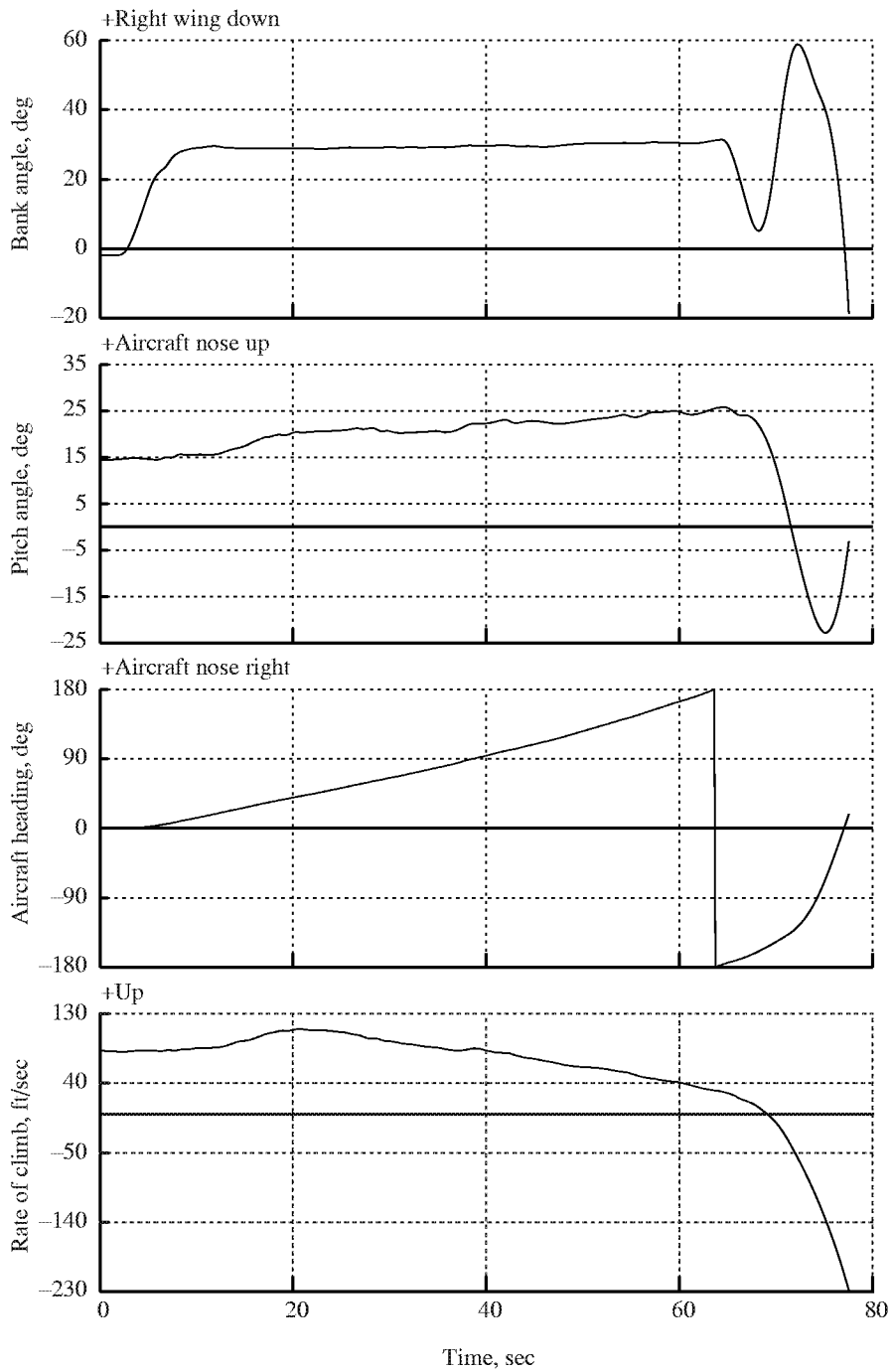

(d) Euler angles and rate of climb.

Figure 52. Continued.

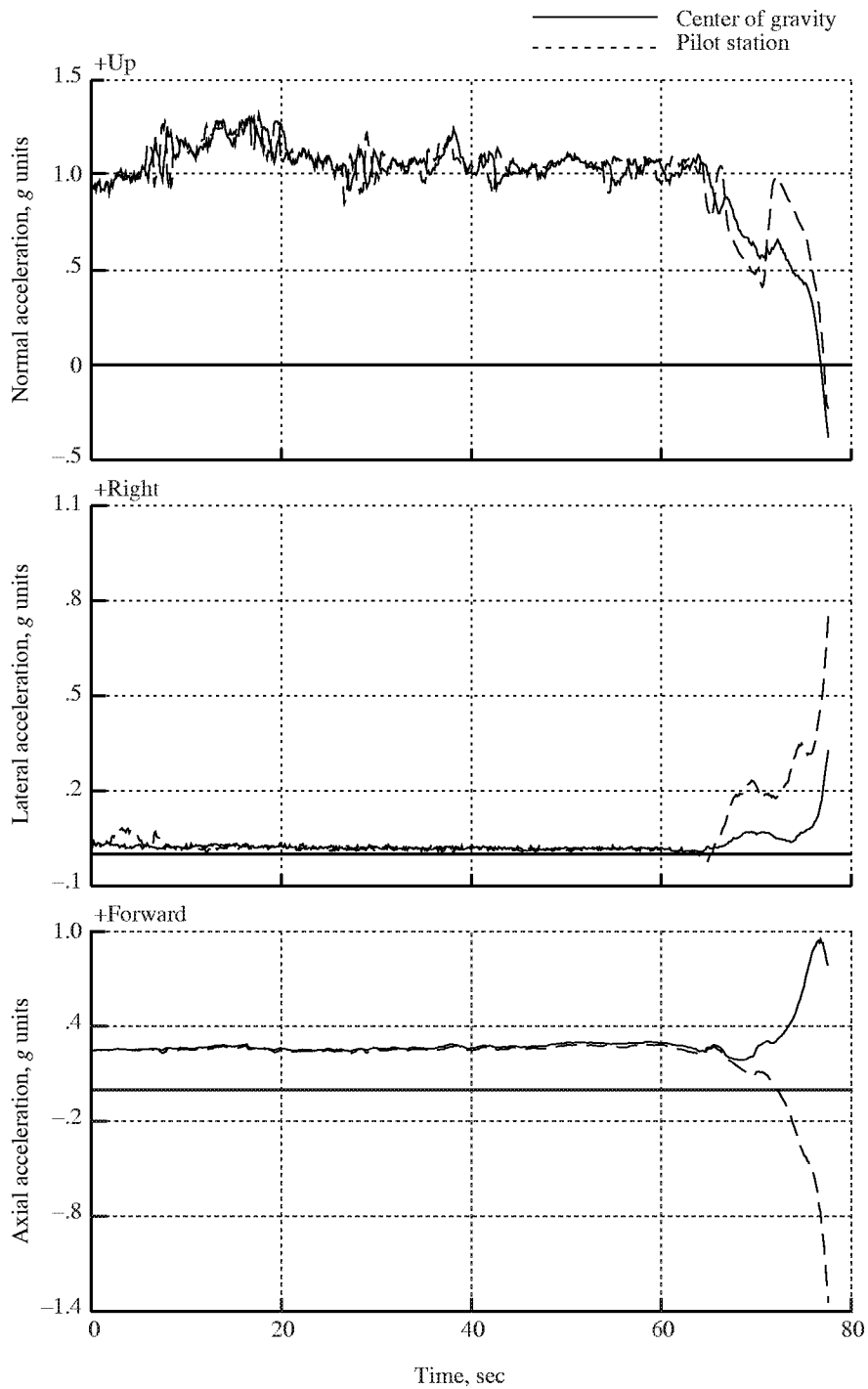

(e) Linear accelerations at center of gravity and pilot station.

Figure 52. Concluded.

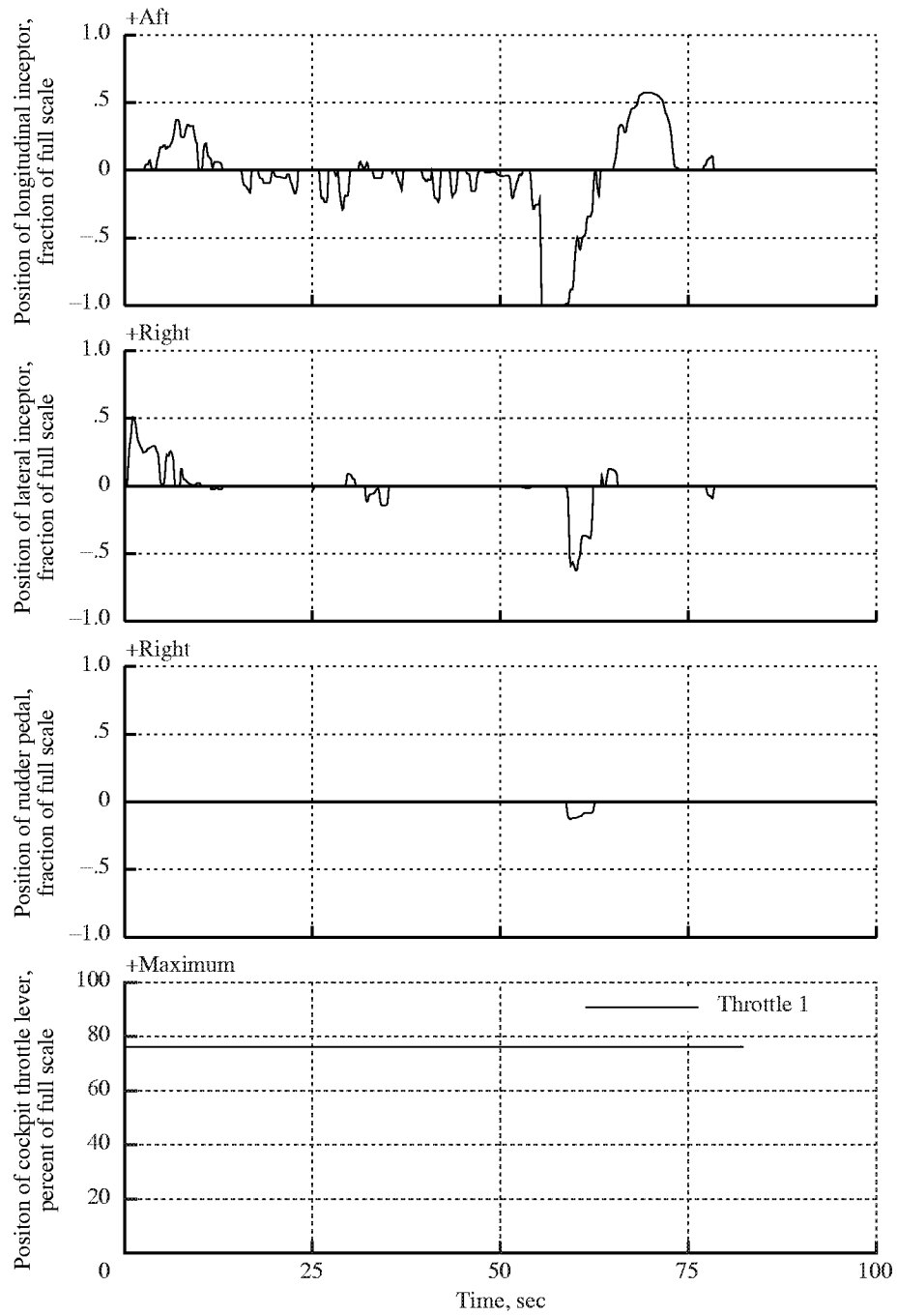

(a) Longitudinal and lateral stick inputs, rudder pedal inputs, and percent of maximum power level 1.

Figure 53. Typical time histories for engine-out turning stall (task 7080) with recovery.

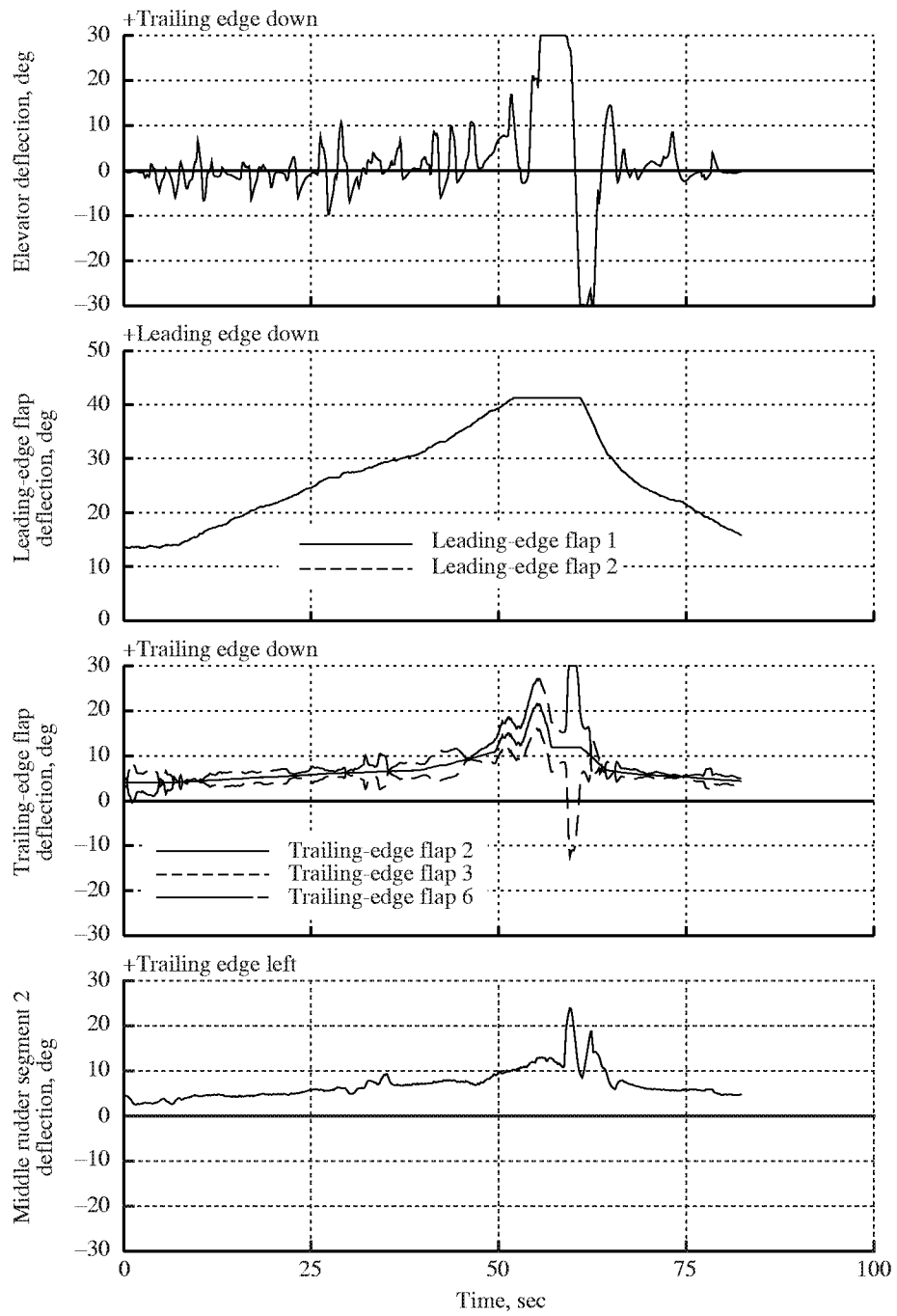

(b) Deflection of elevator; leading-edge flap segments 1 and 2; trailing-edge flap segments 2, 3, and 6; and middle rudder segment 2.

Figure 53. Continued.

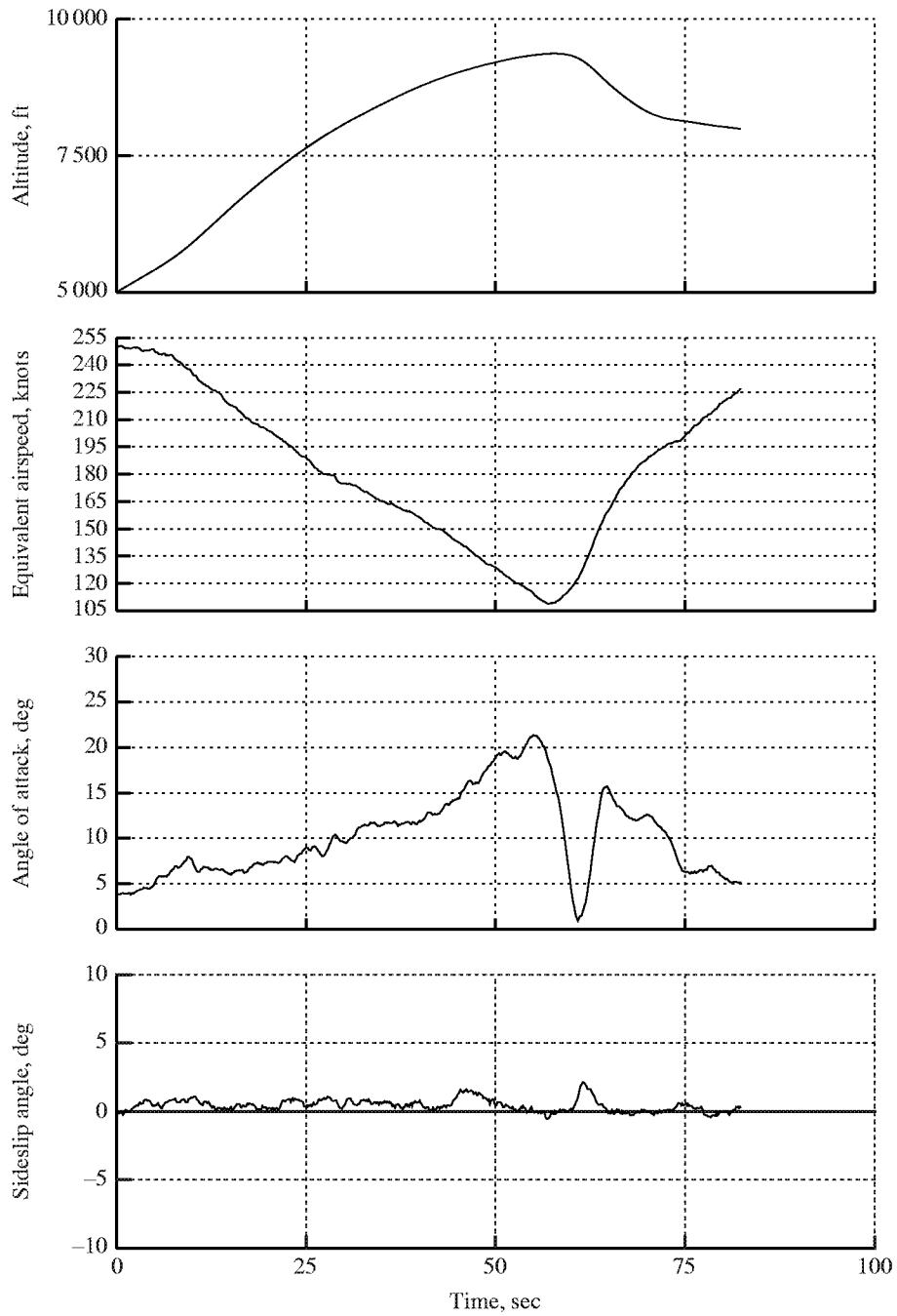

(c) Altitude, equivalent airspeed, angle of attack, and sideslip angle.

Figure 53. Continued.

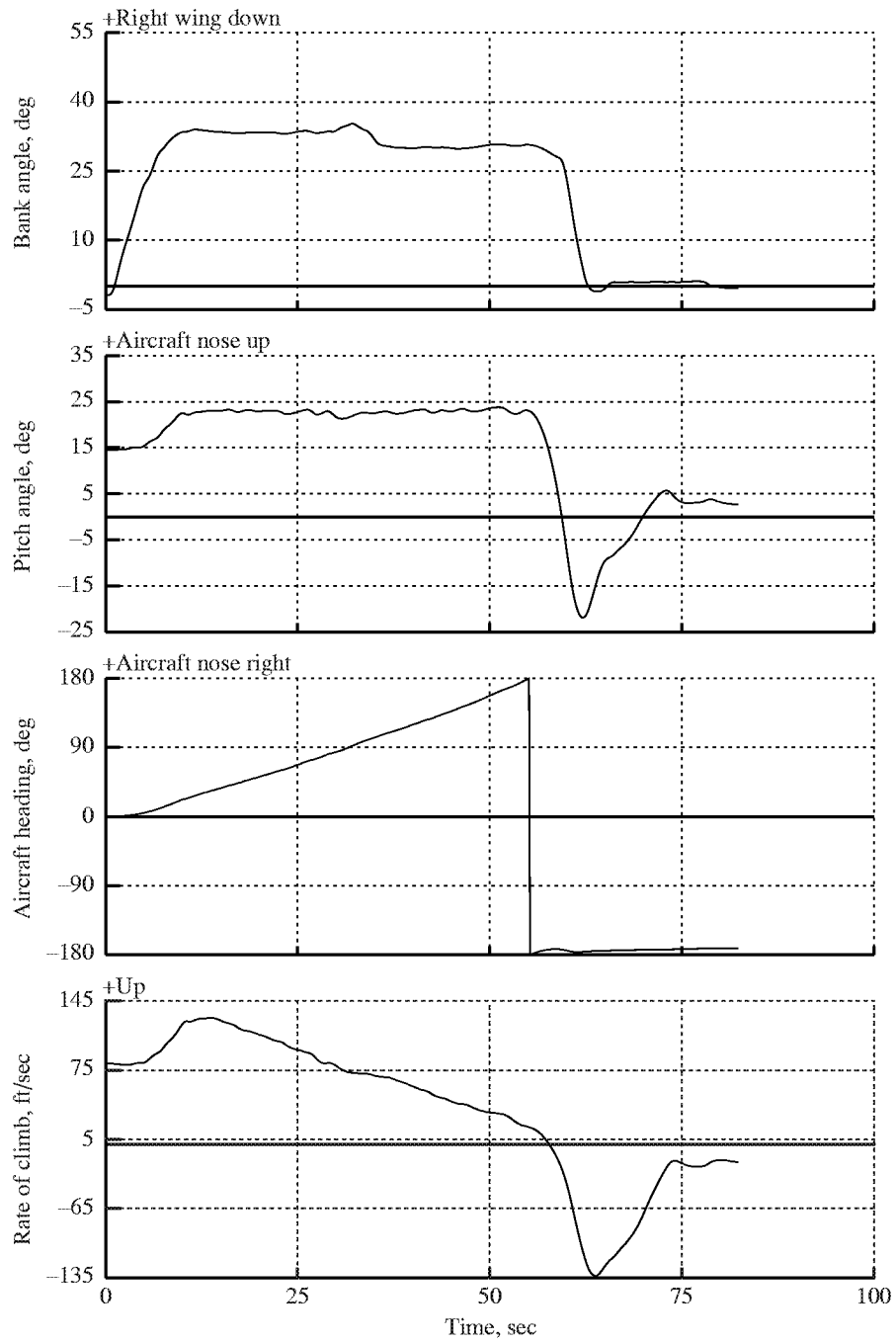

(d) Euler angles and rate of climb.

Figure 53. Continued.

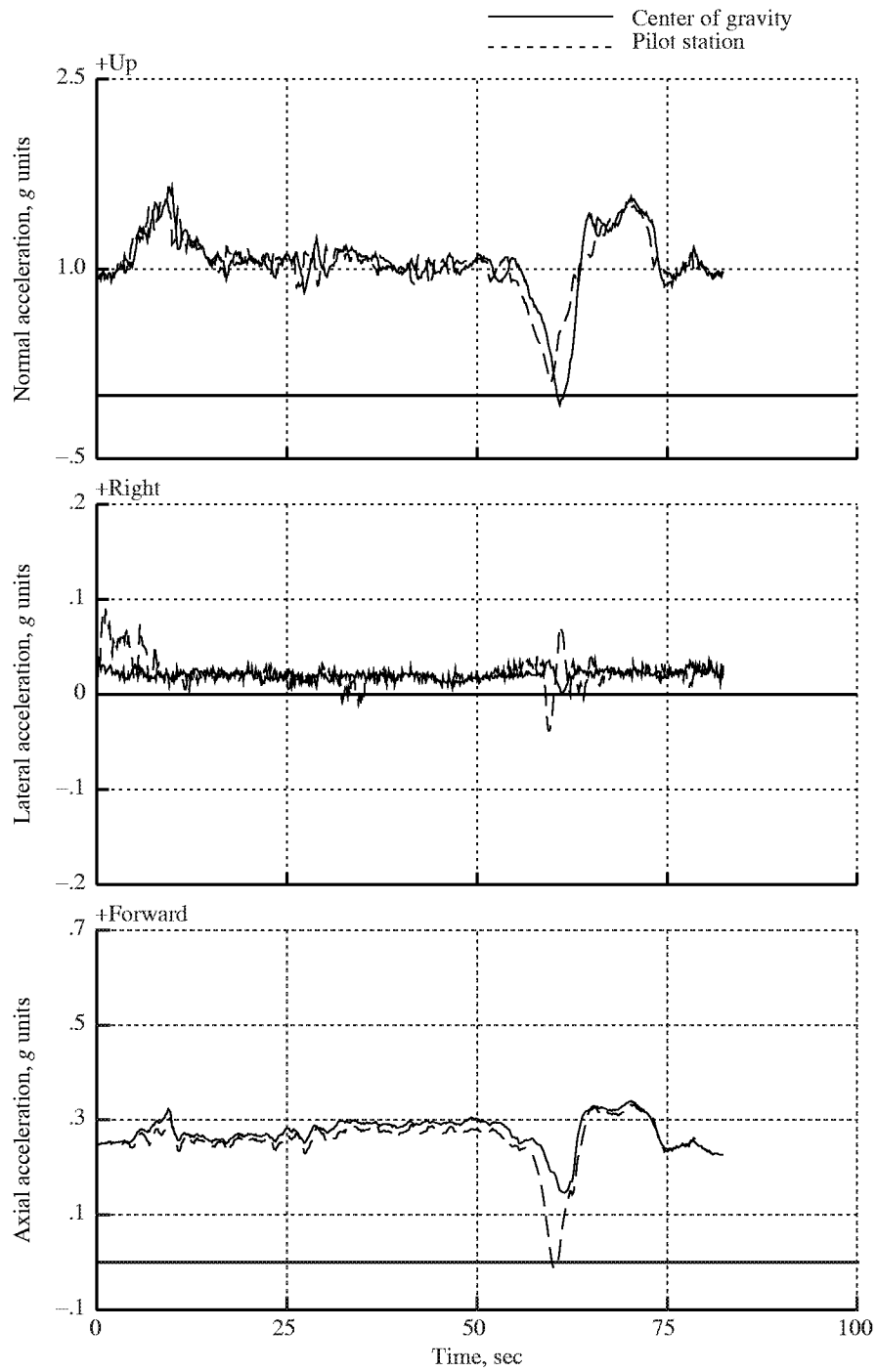

(e) Linear accelerations at center of gravity and pilot station.

Figure 53. Concluded.

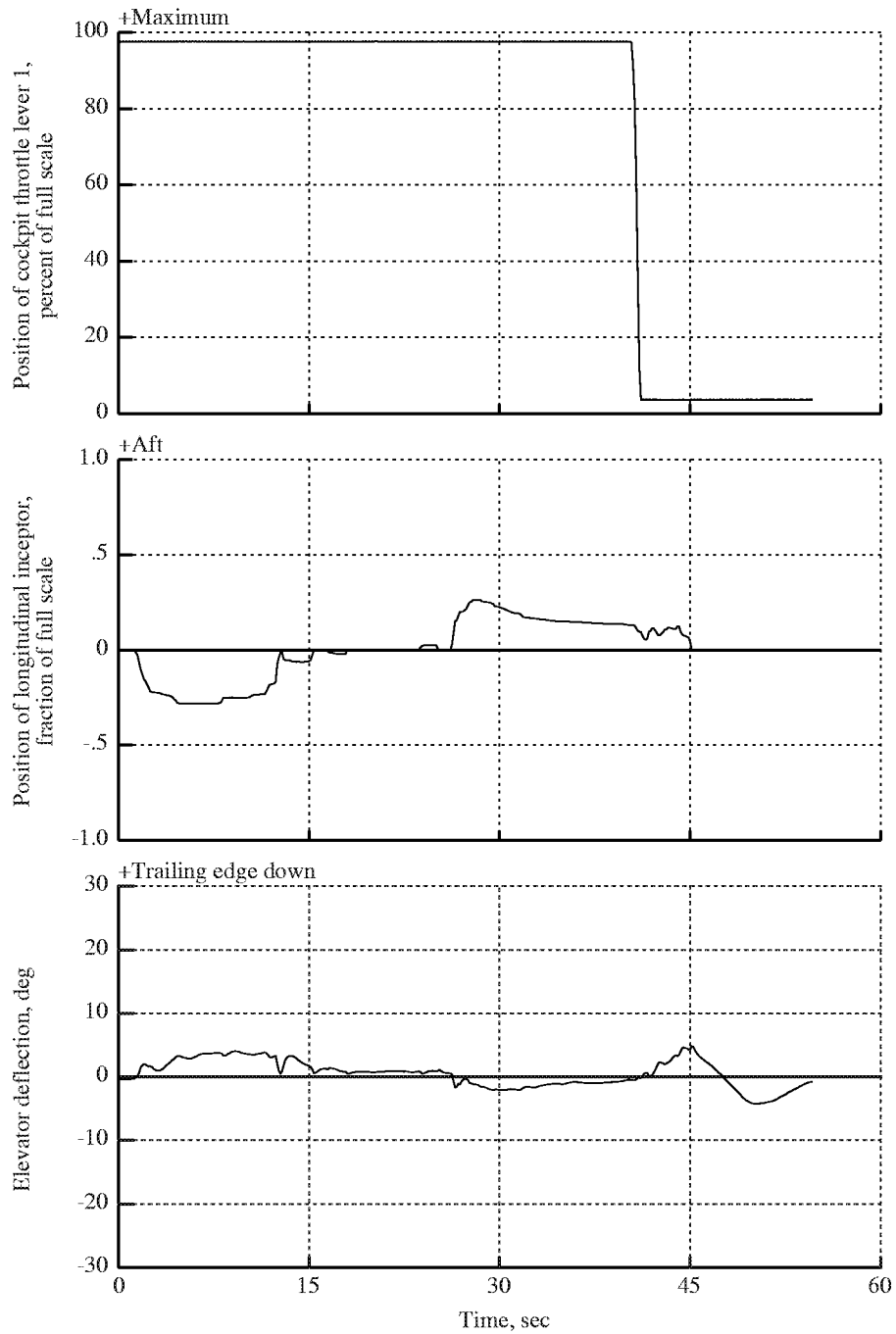

(a) Power lever angle for engine number 1, longitudinal stick input, and elevator deflection.

Figure 54. Typical time histories for diving pullout (task 5060) for Pilot B.

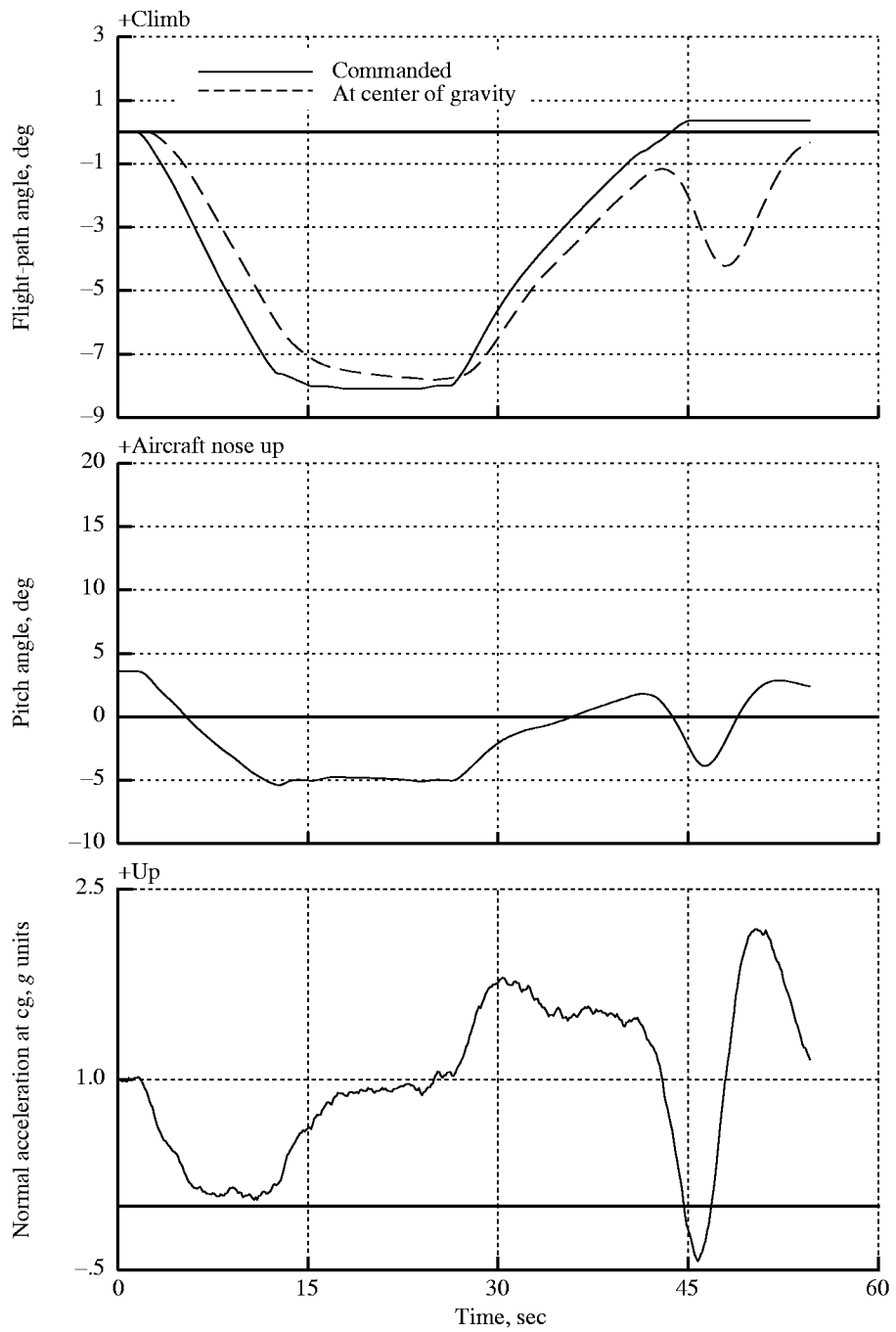

(b) Commanded and actual flight-path angles, pitch angle, and normal acceleration at center of gravity.

Figure 54. Concluded.

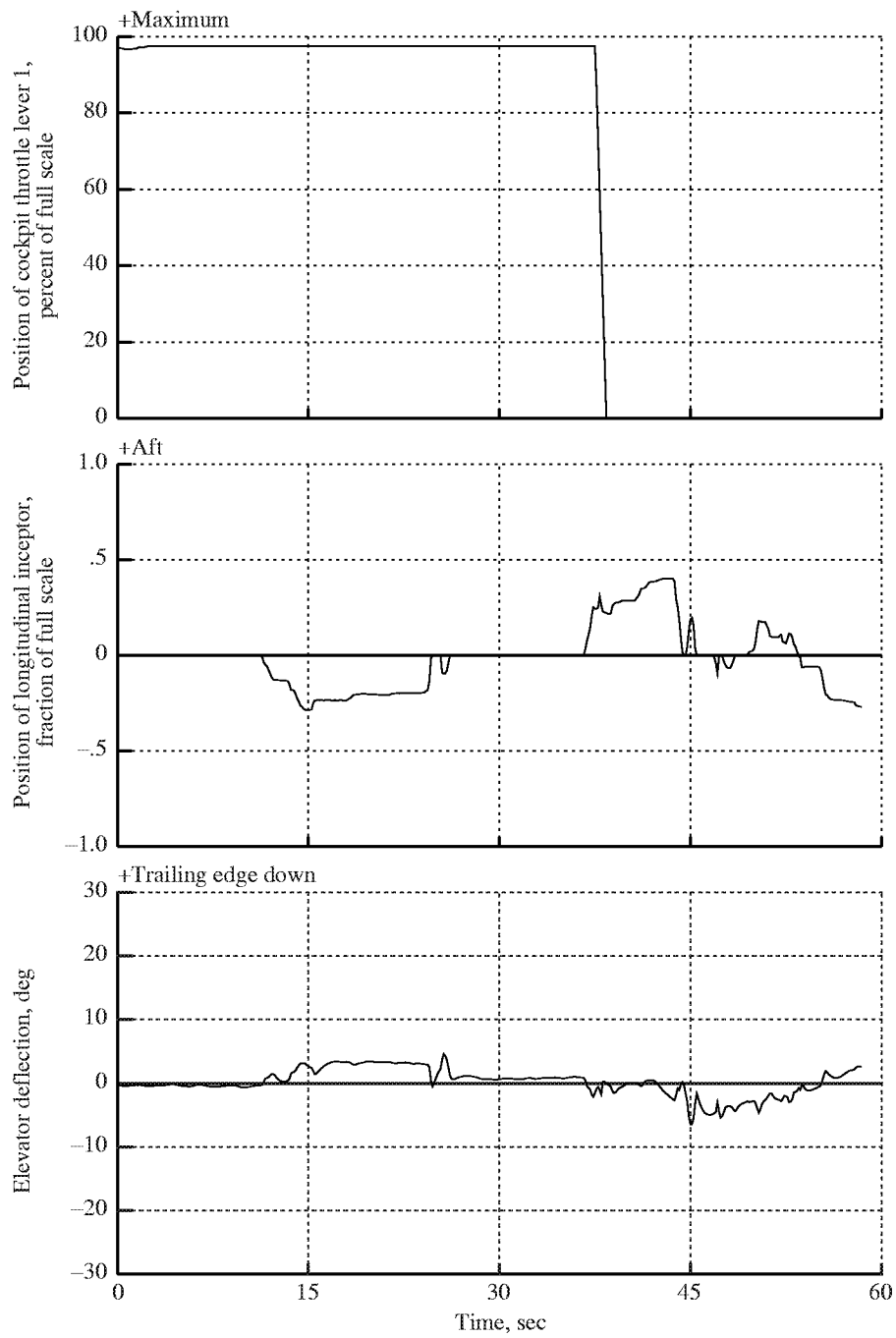

(a) Power lever angle for engine number 1, longitudinal stick input, and elevator deflection.

Figure 55. Typical time histories for diving pullout (task 5060) for Pilot A.

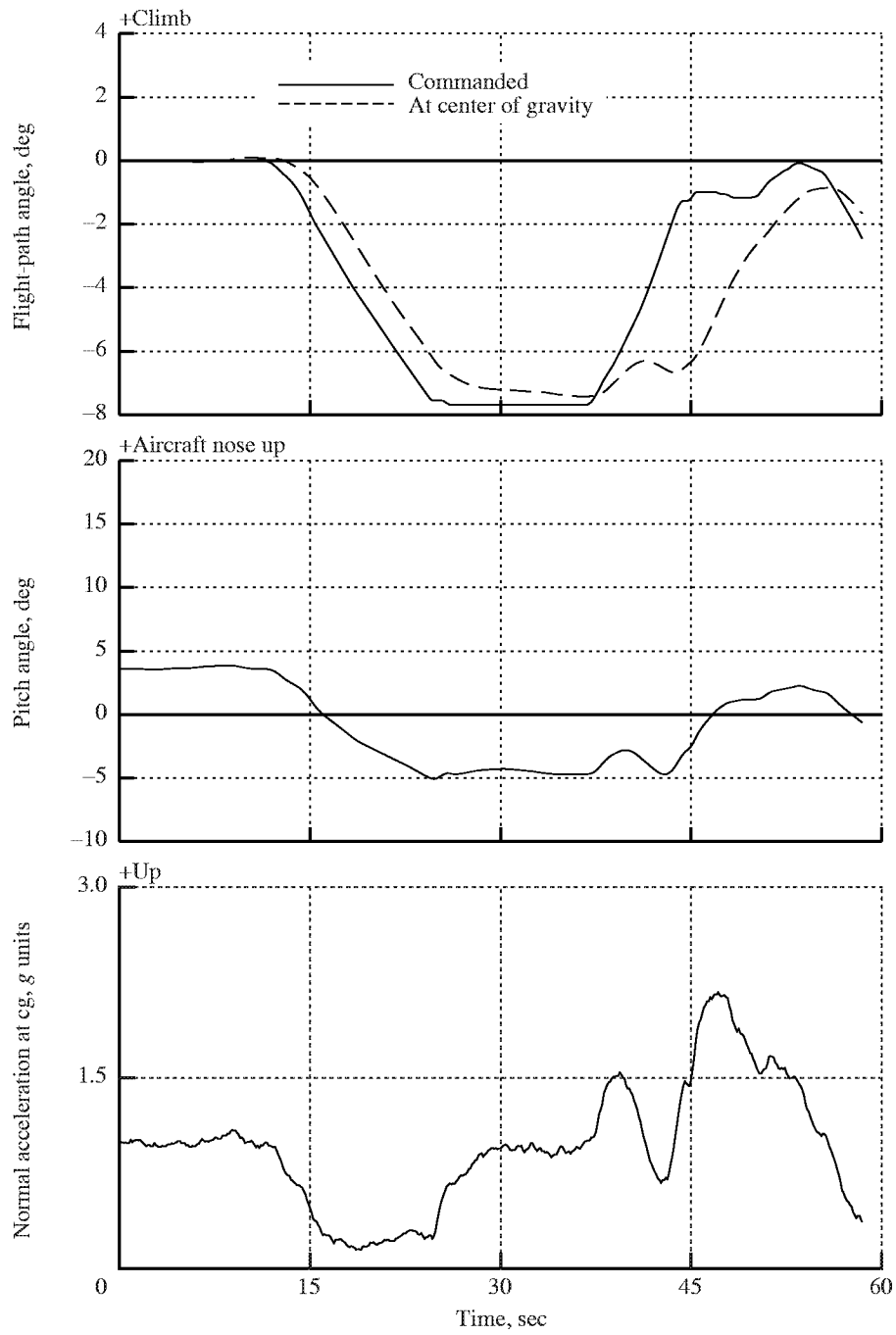

(b) Commanded and actual flight-path angles, pitch angle, and normal acceleration at center of gravity.

Figure 55. Concluded.

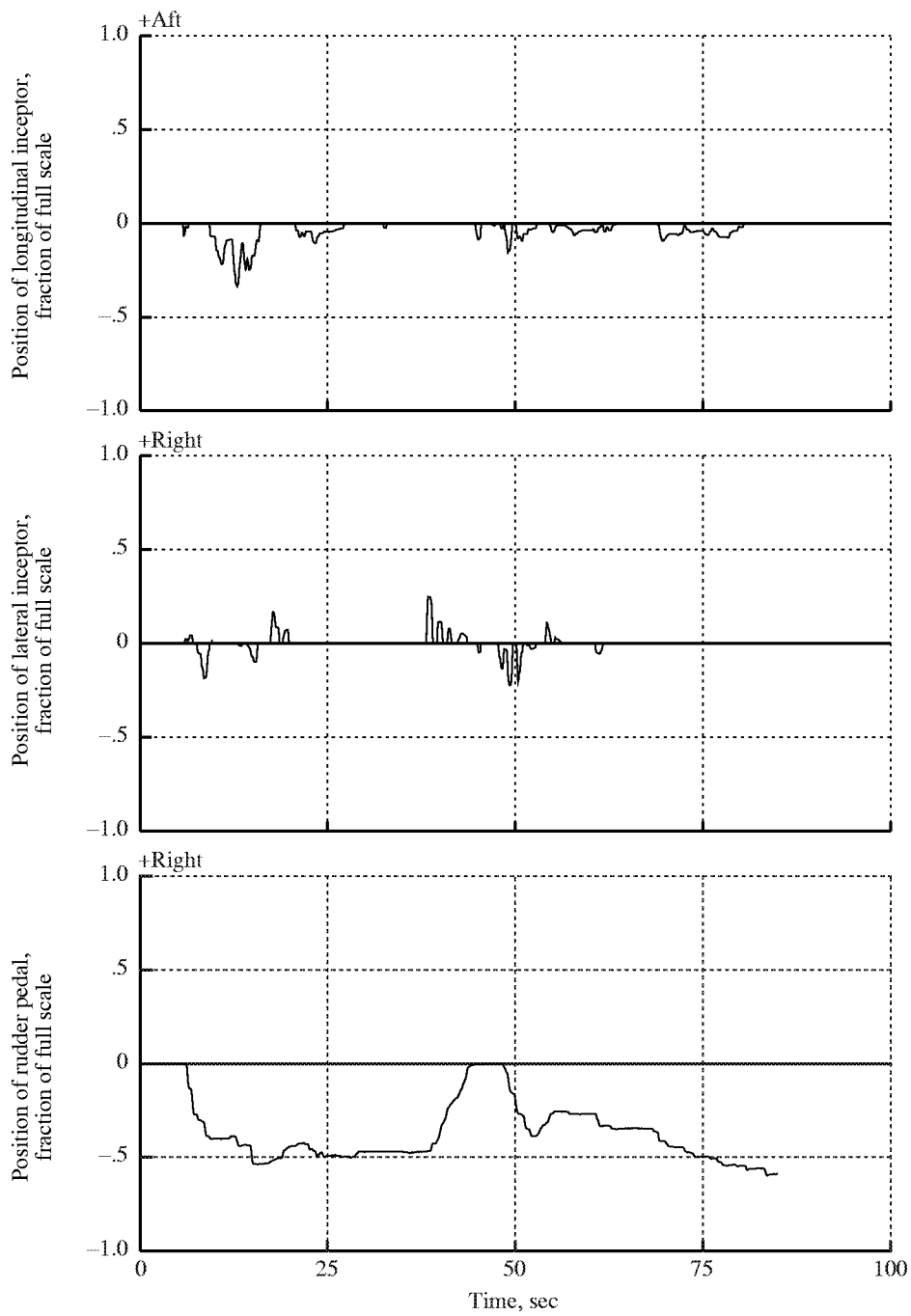

(a) Longitudinal and lateral stick inputs, and rudder pedal inputs.

Figure 56. Typical time histories for ripple unstart (task 7060) for Pilot B.

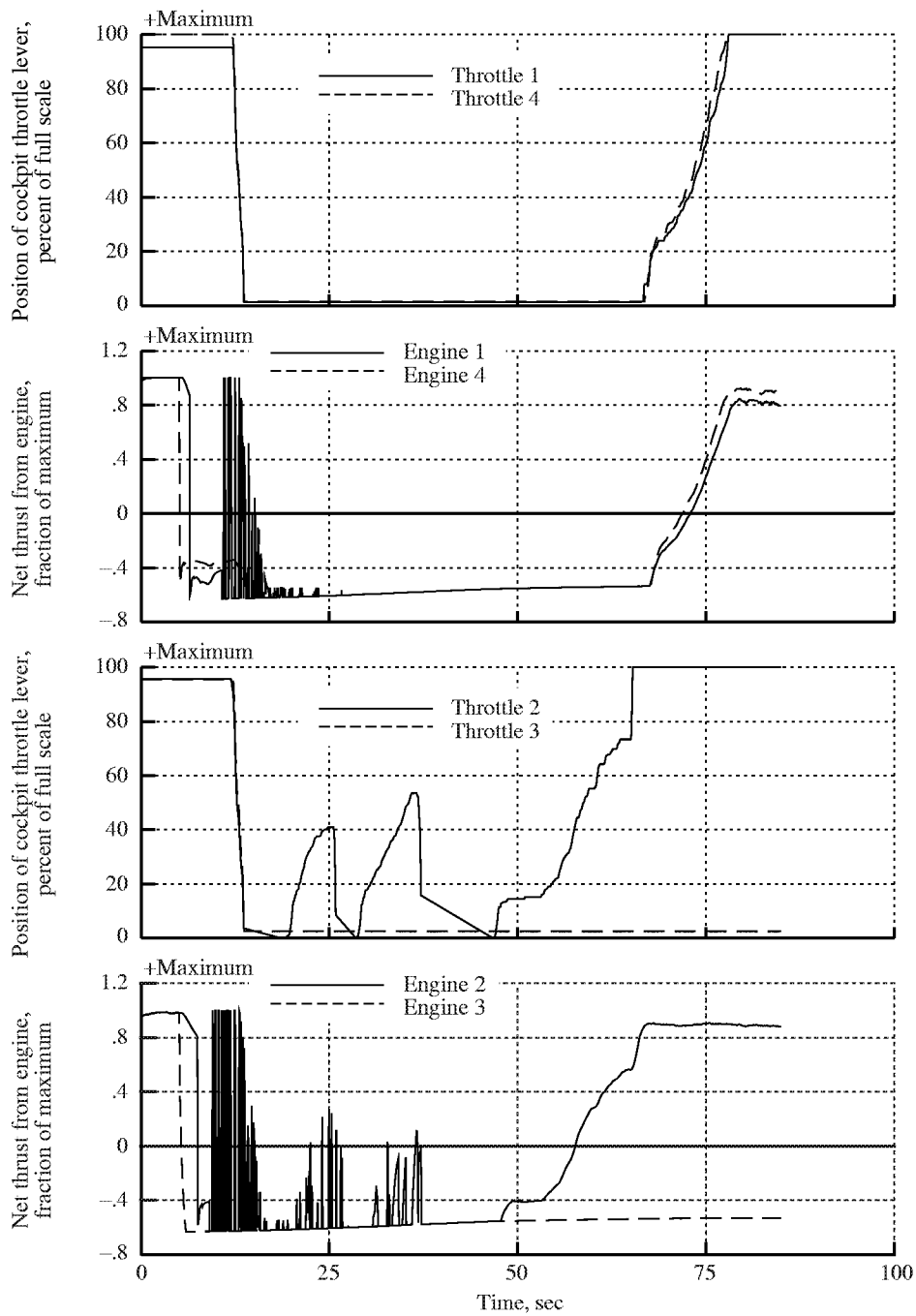

(b) Power lever angle deflection and net thrust for all four engines.

Figure 56. Continued.

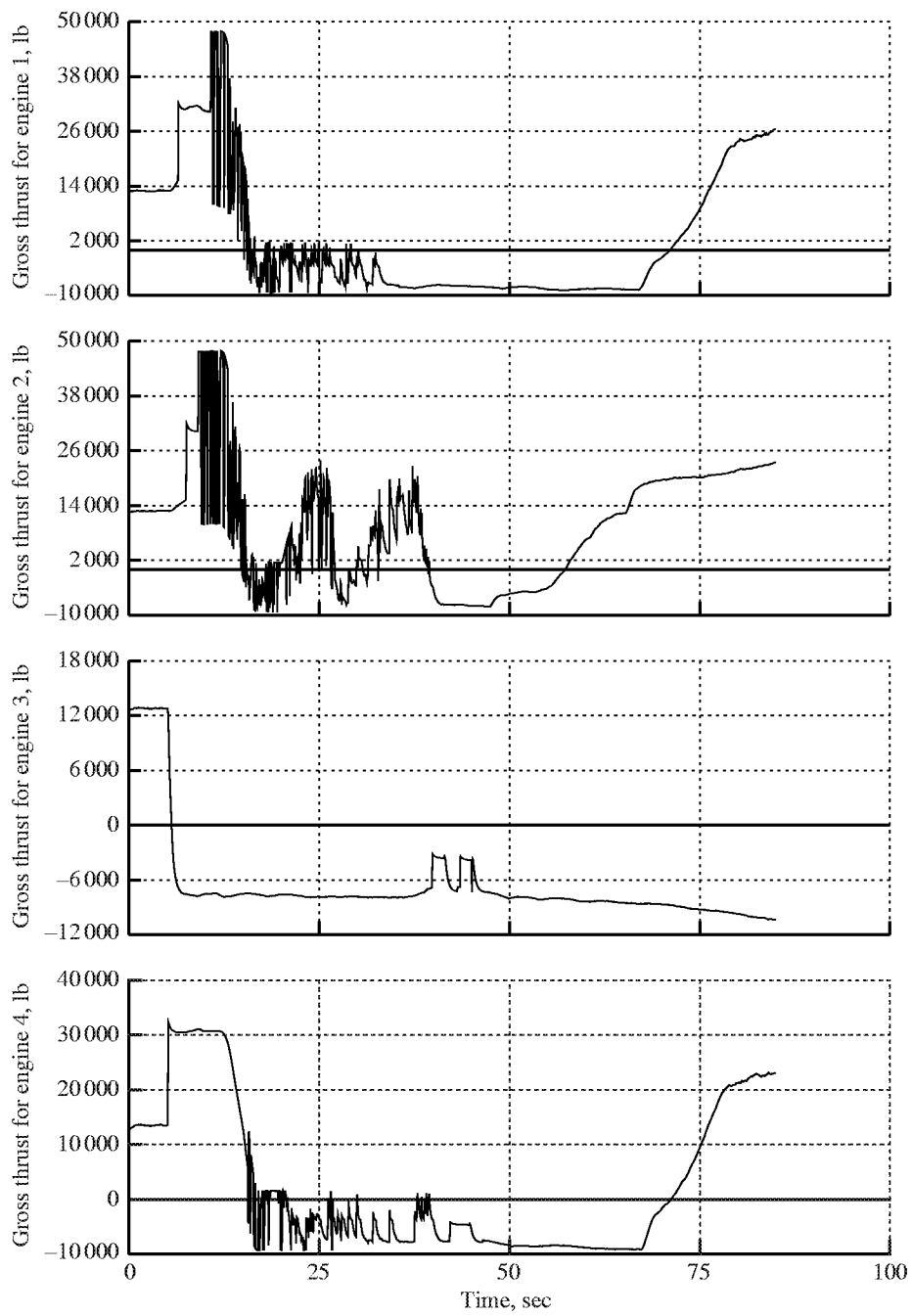

(c) Gross thrust for each engine.

Figure 56. Continued.

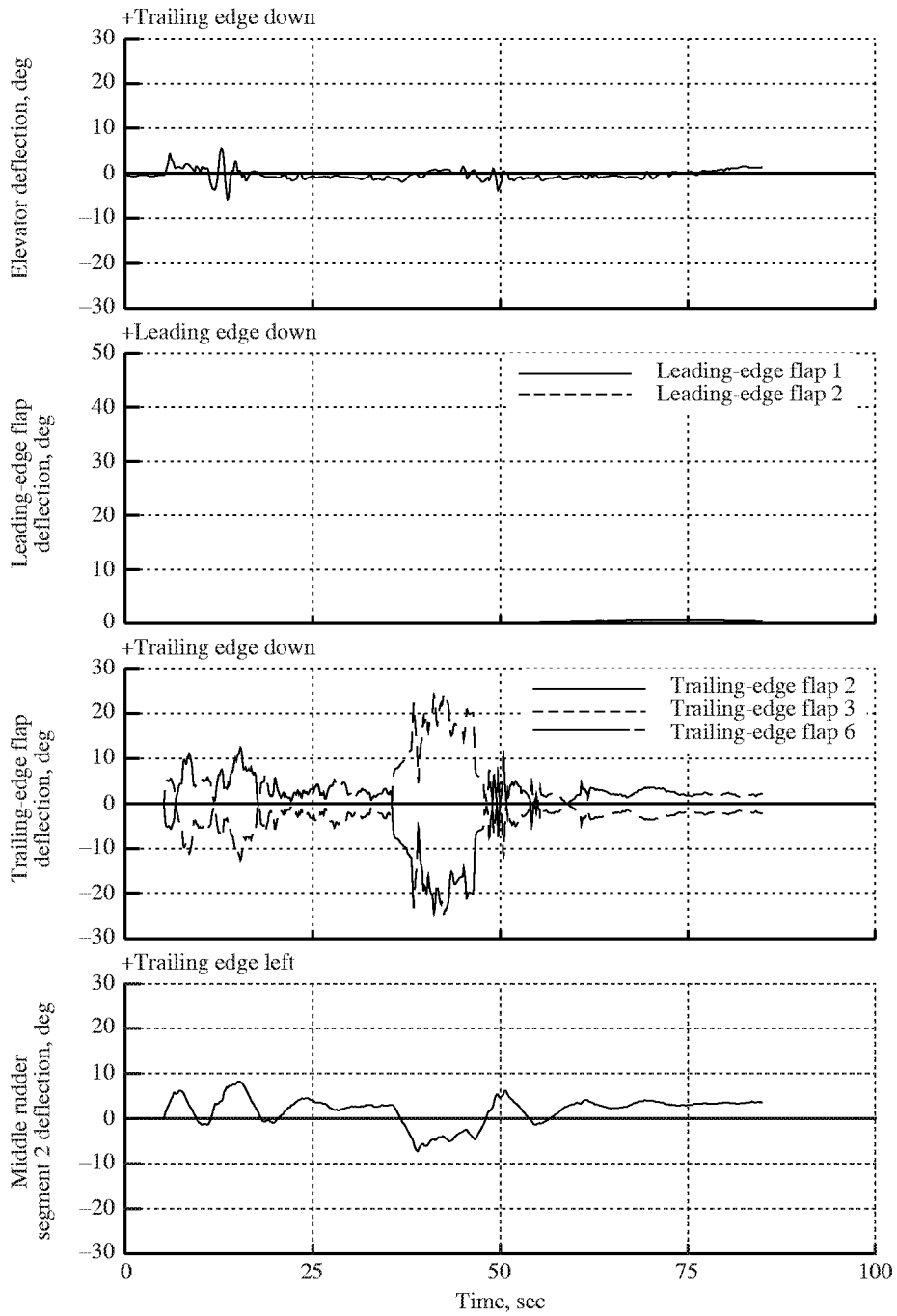

(d) Deflection of elevator; leading-edge flap segments 1 and 2; trailing-edge flap segments 2, 3, and 6; and middle rudder segment 2.

Figure 56. Continued.

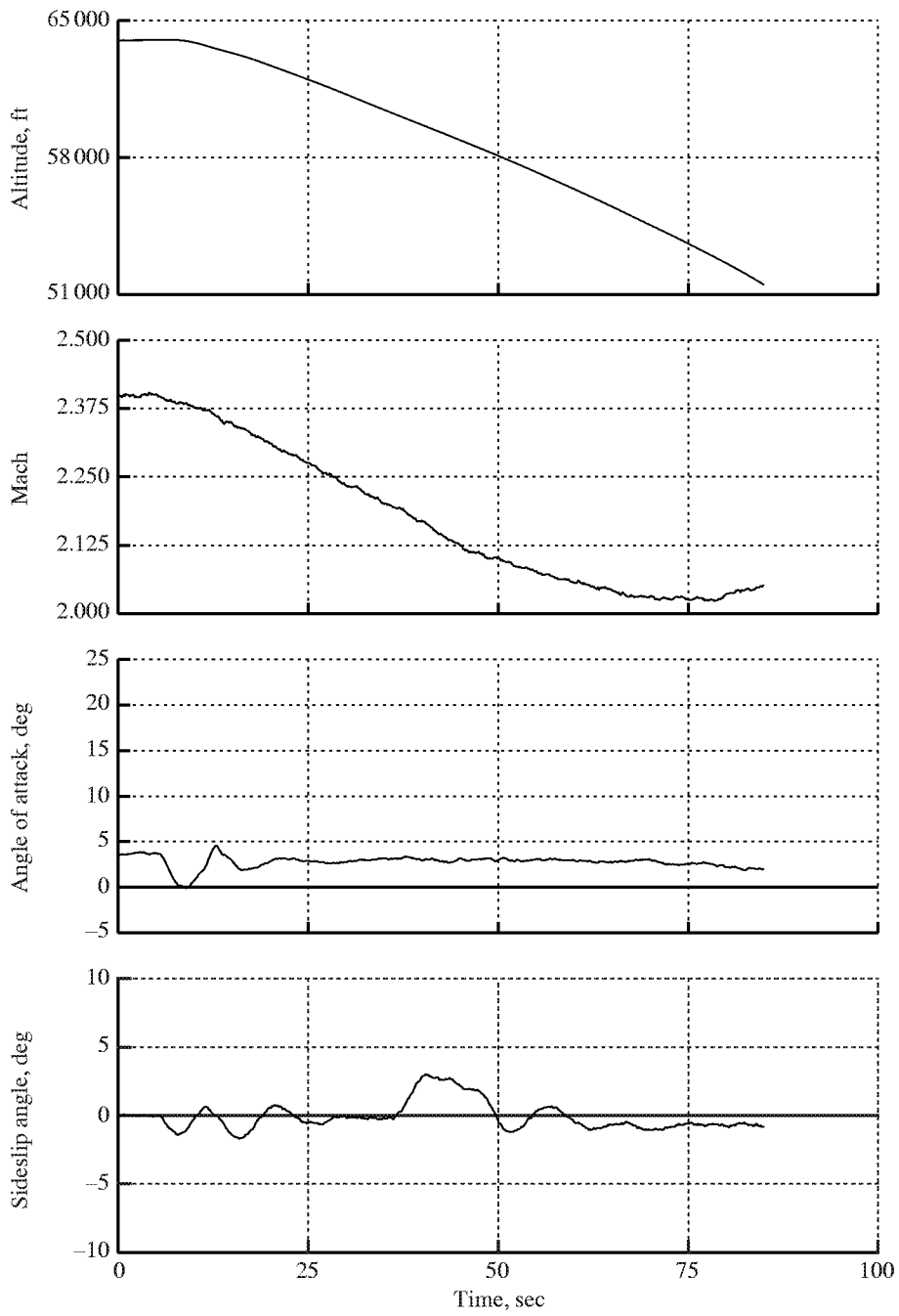

(e) Altitude, Mach, angle of attack, and sideslip angle.

Figure 56. Continued.

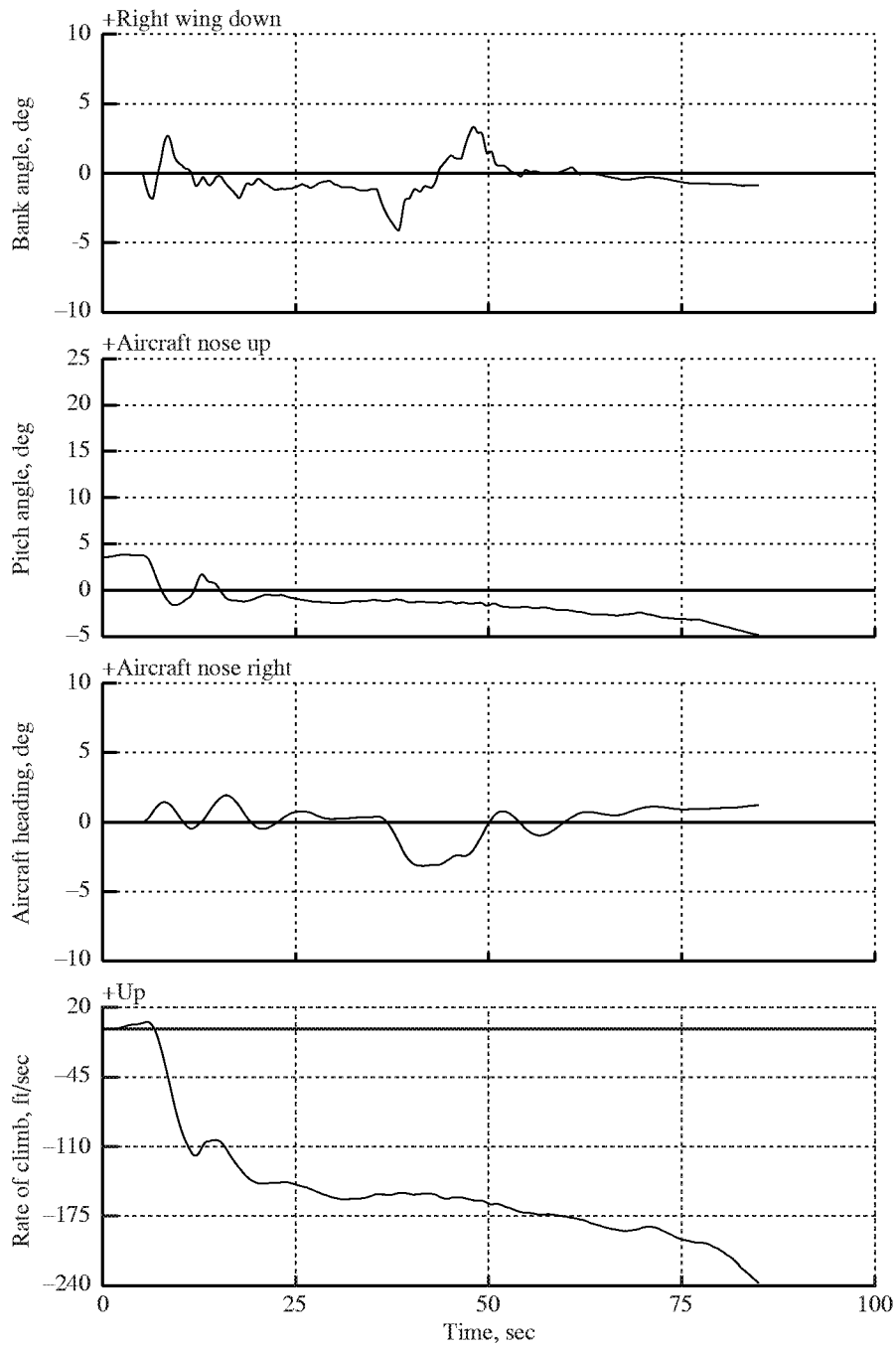

(f) Euler angles and rate of climb.

Figure 56. Continued.

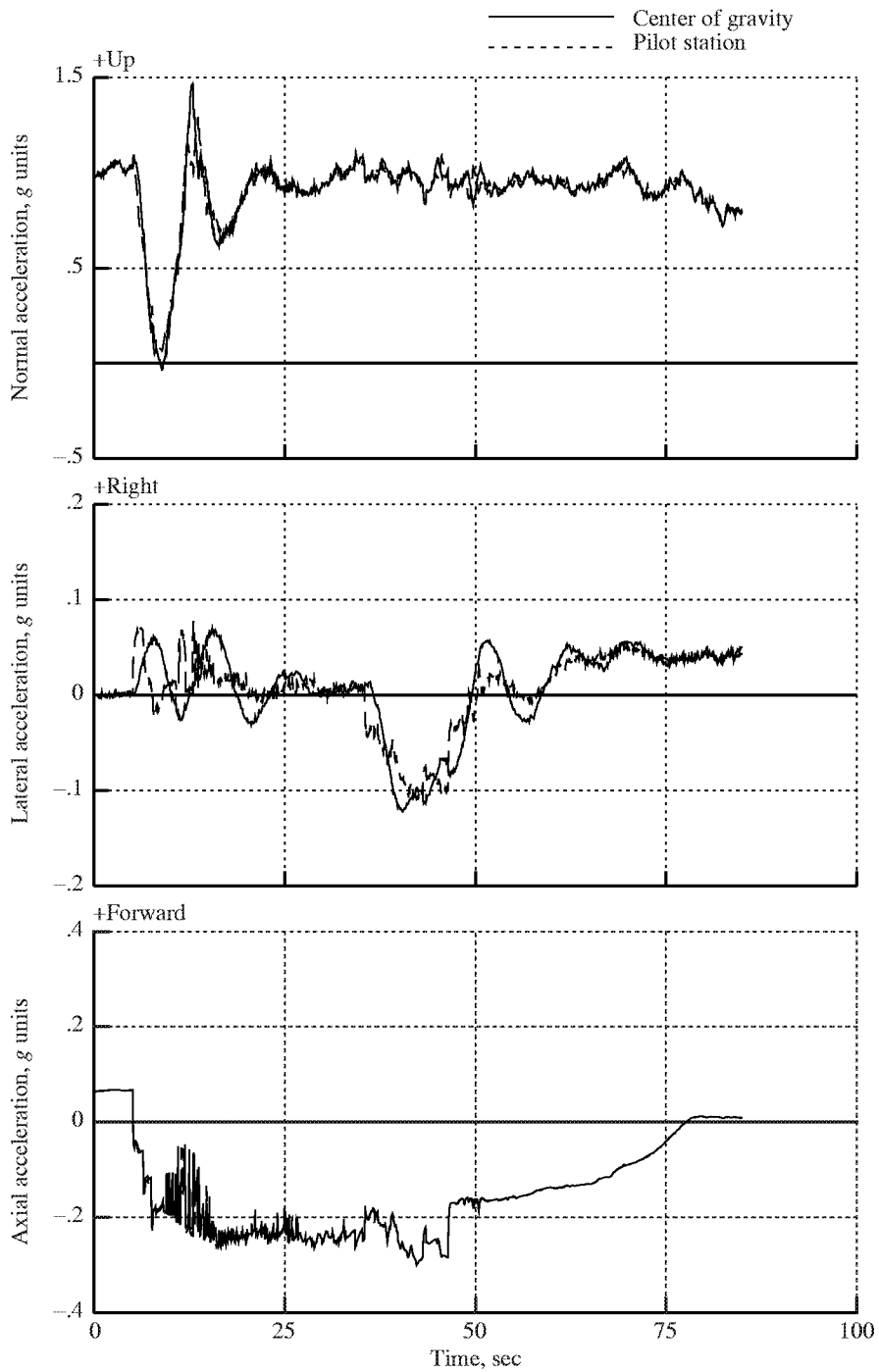

(g) Linear accelerations at center of gravity and pilot station.

Figure 56. Concluded.

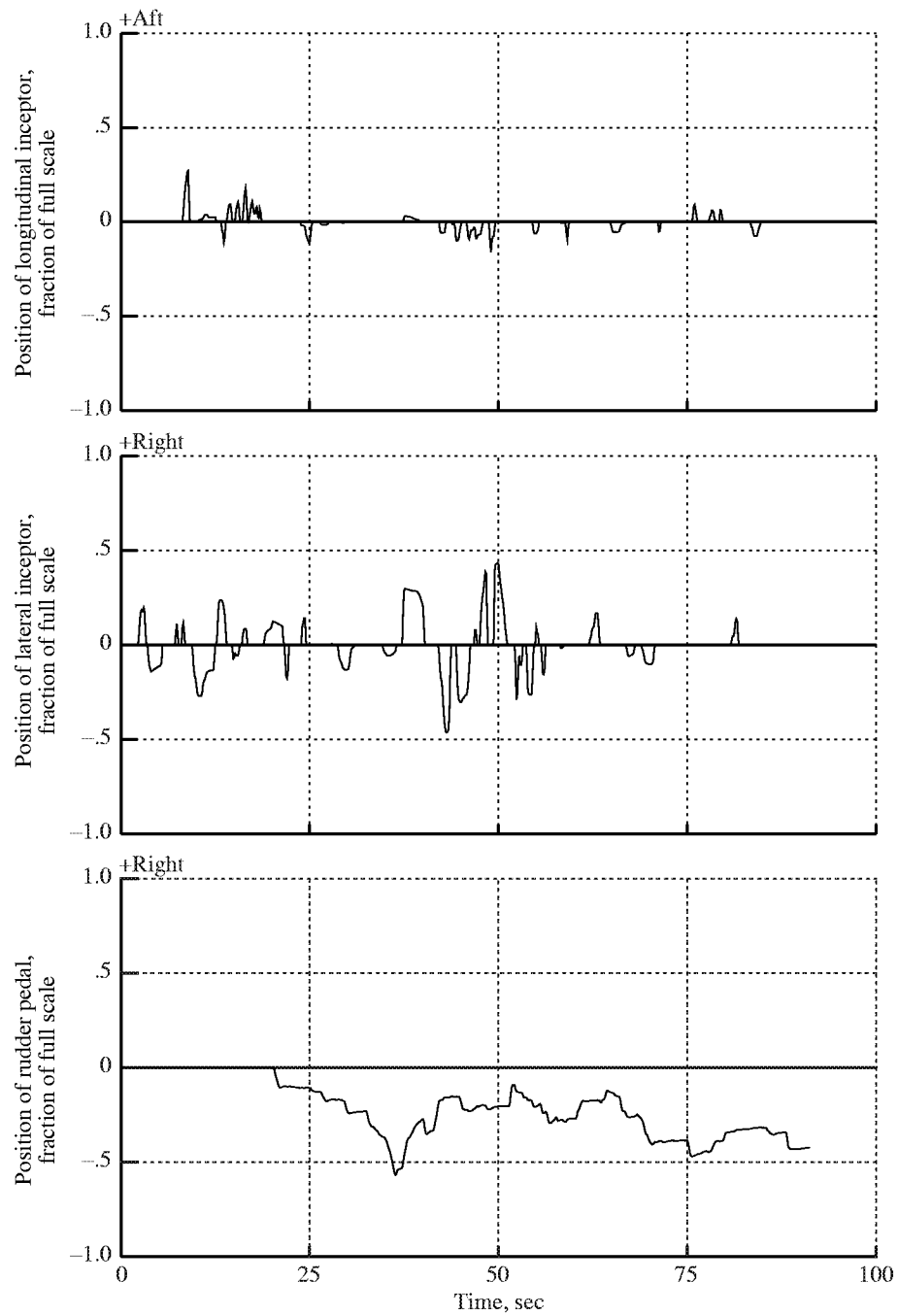

(a) Longitudinal and lateral stick inputs, and rudder pedal inputs.

Figure 57. Typical time histories for ripple unstart (task 7060) for Pilot D.

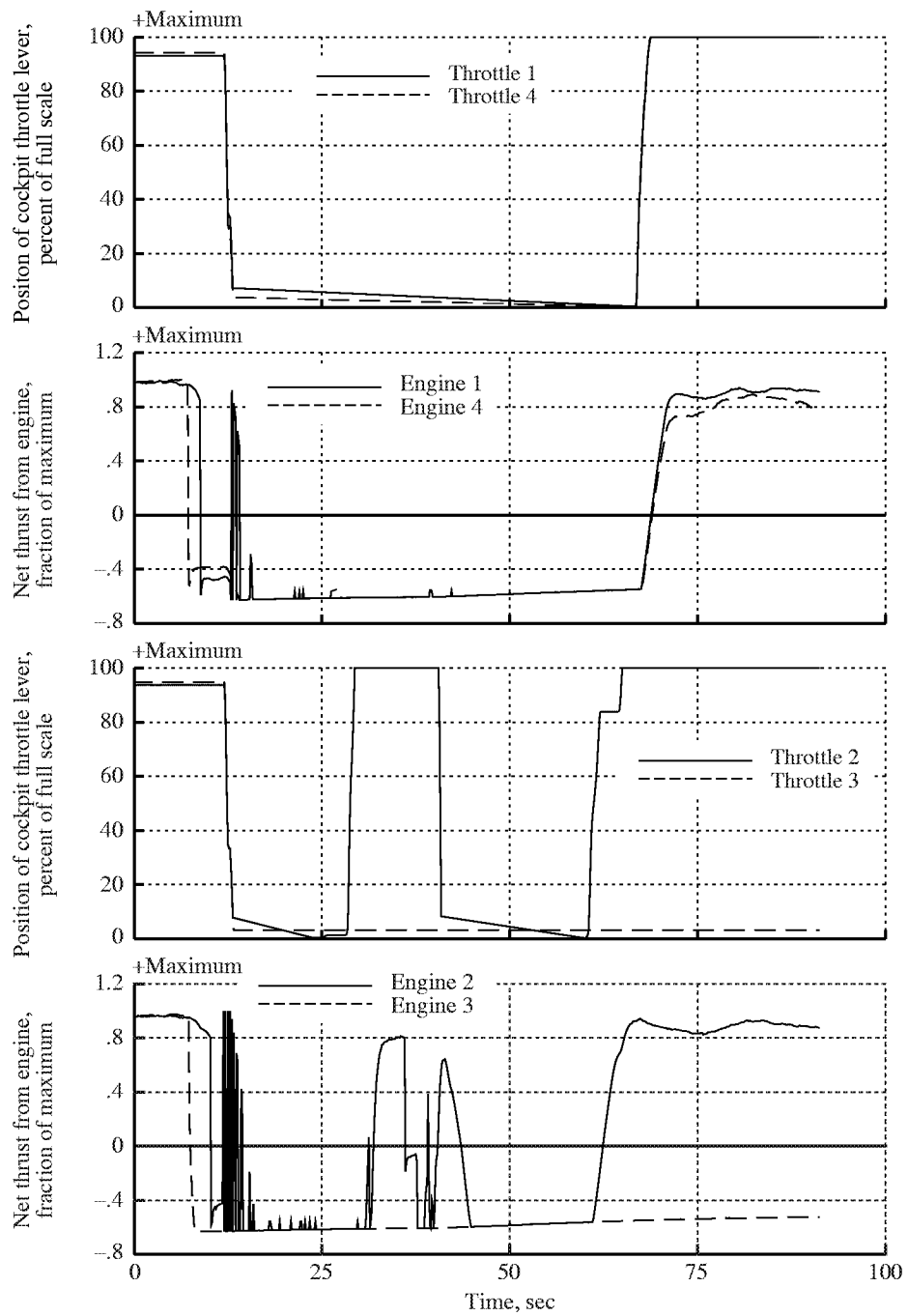

(b) Power lever angle deflection and net thrust for all four engines.

Figure 57. Continued.

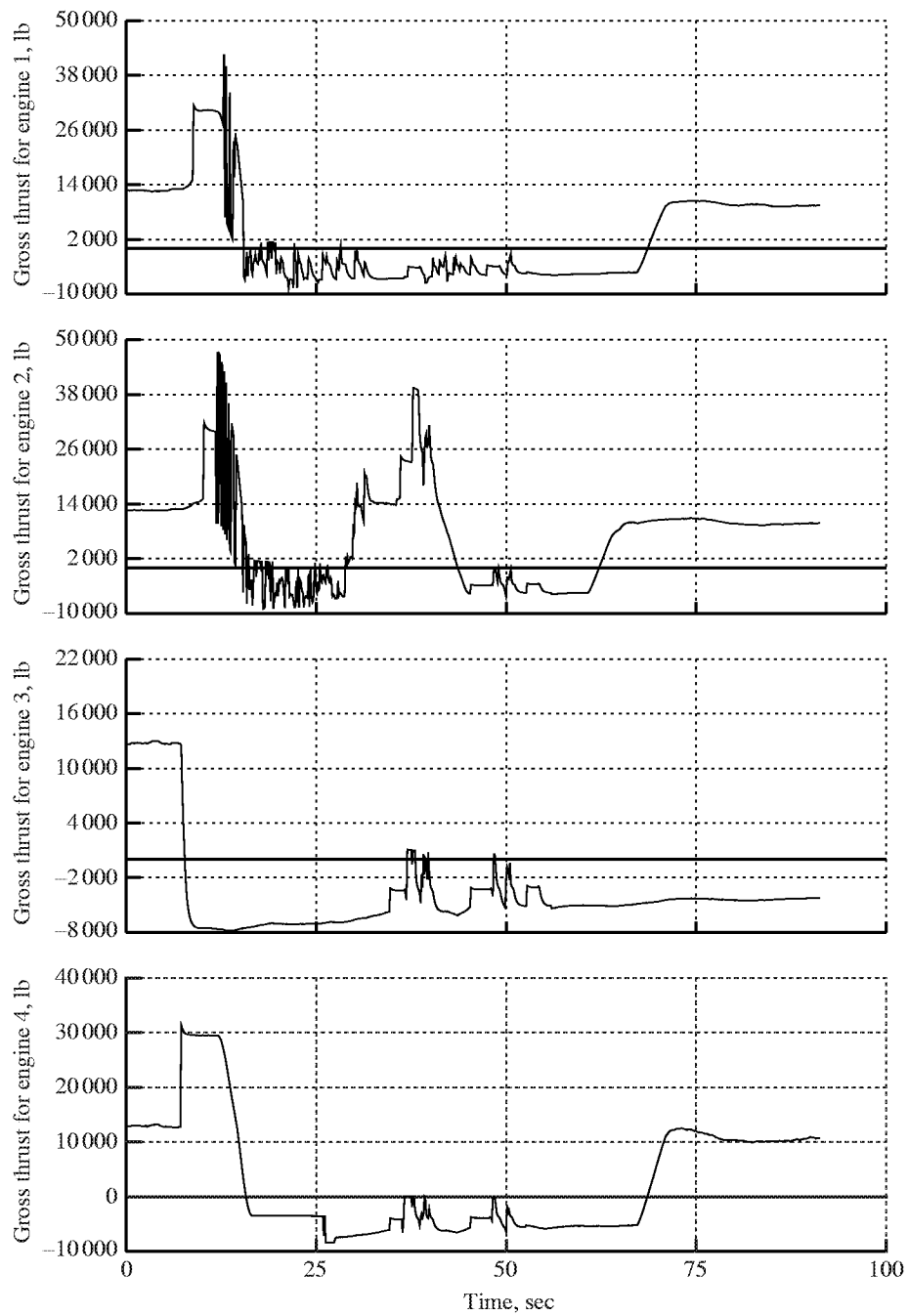

(c) Gross thrust for all four engines.

Figure 57. Continued.

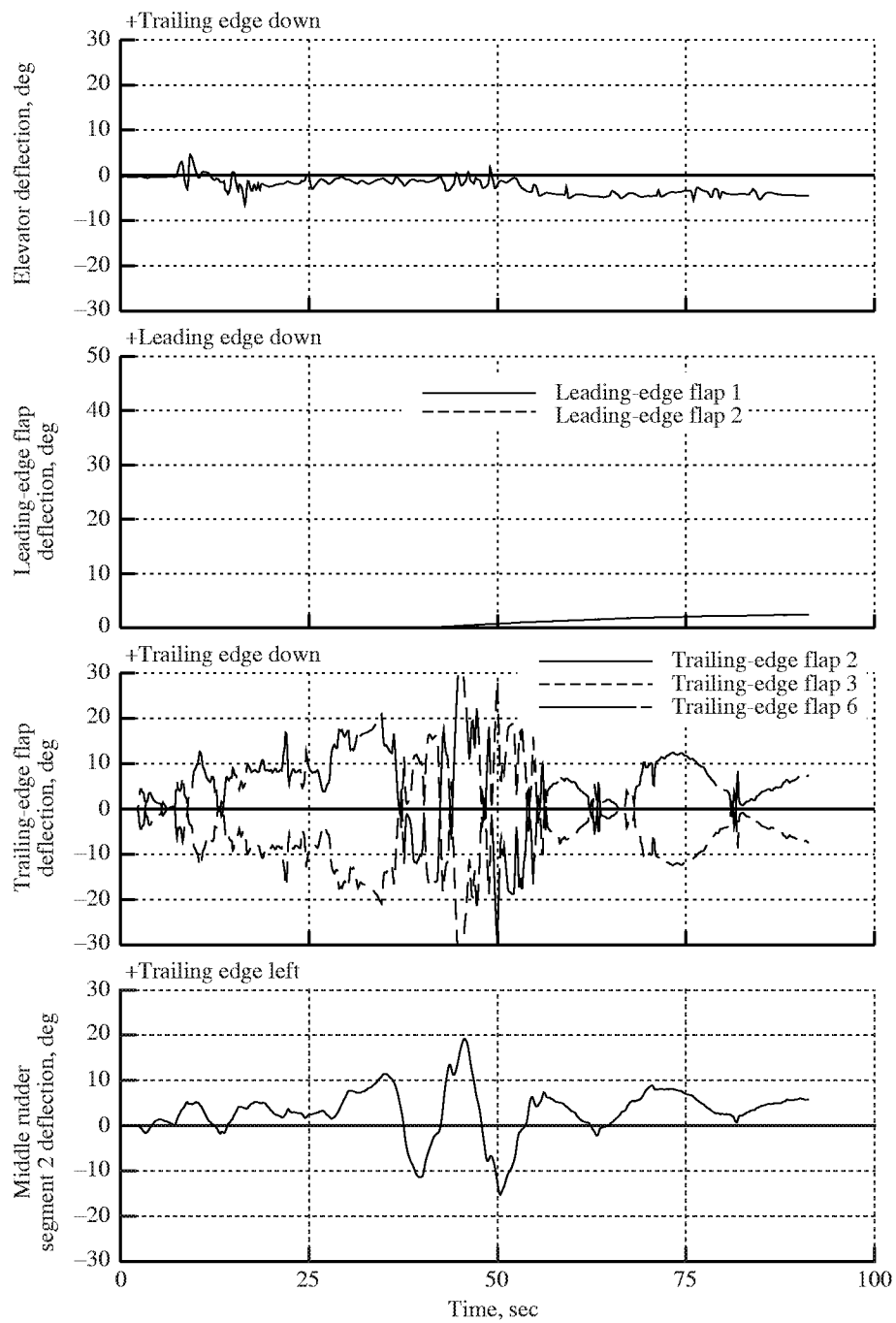

(d) Deflection of elevator; leading-edge flap segments 1 and 2; trailing-edge flap segments 2, 3, and 6; and middle rudder segment 2.

Figure 57. Continued.

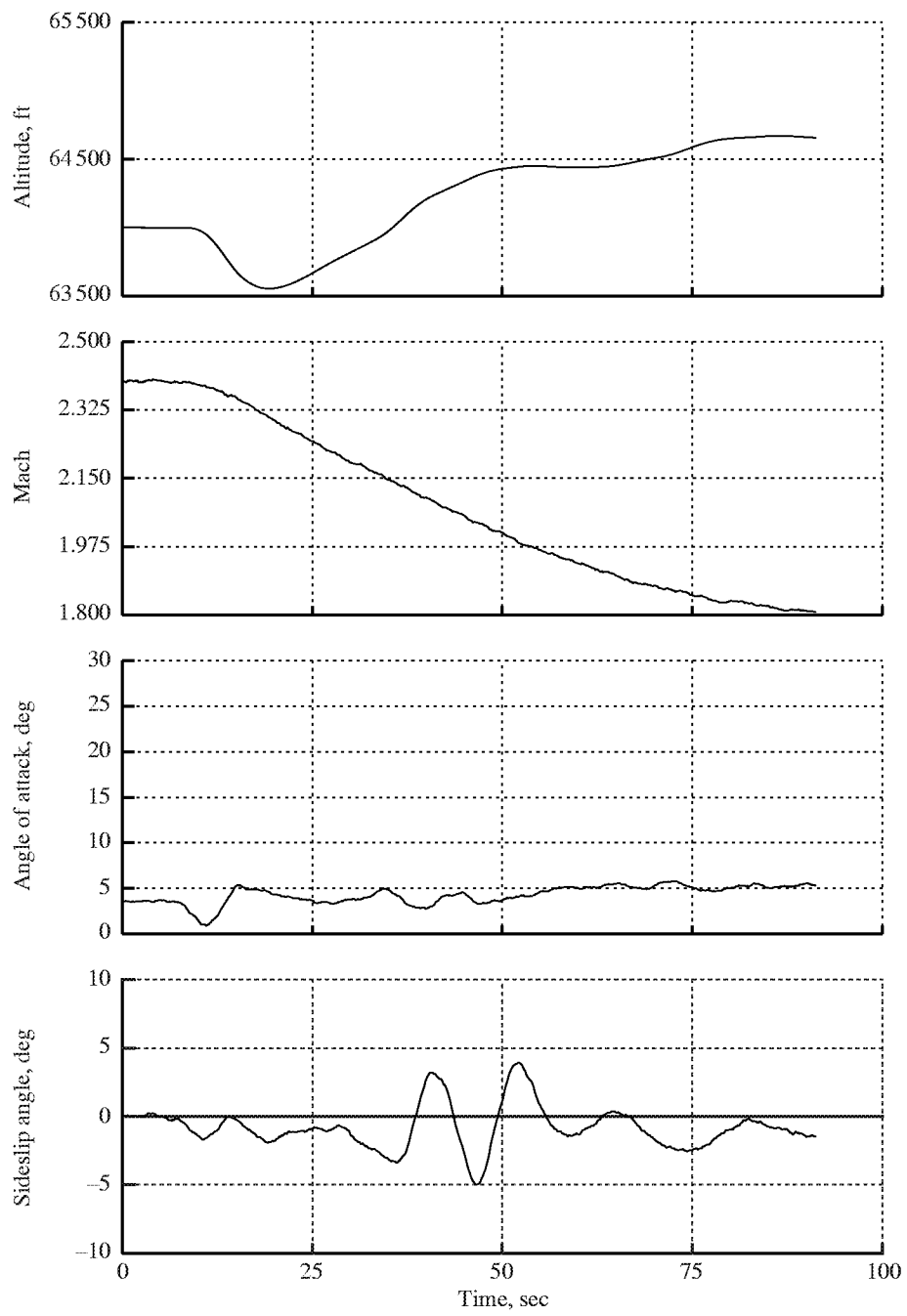

(e) Altitude, Mach, angle of attack, and sideslip angle.

Figure 57. Continued.

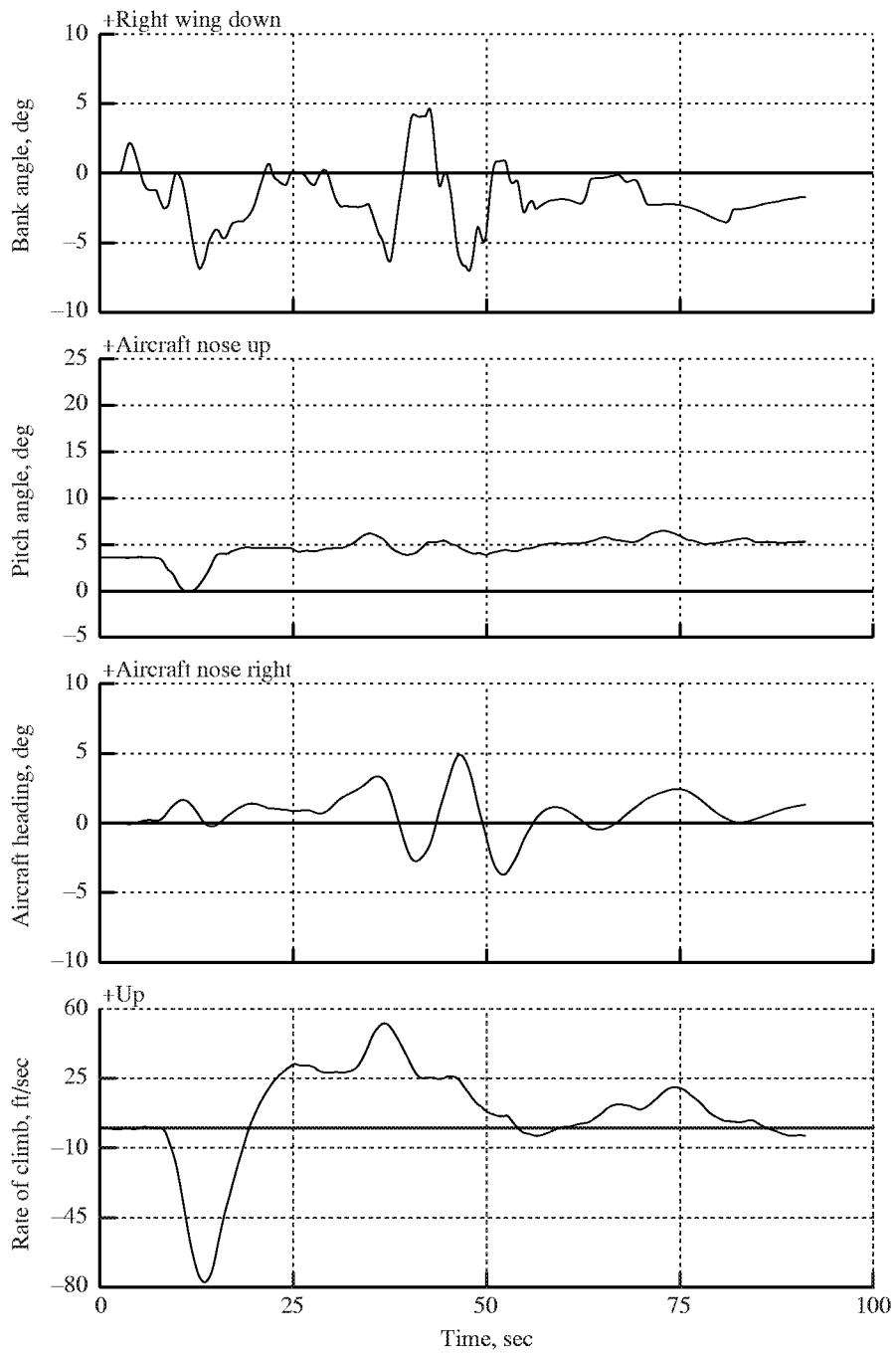

(f) Euler angles and rate of climb.

Figure 57. Continued.

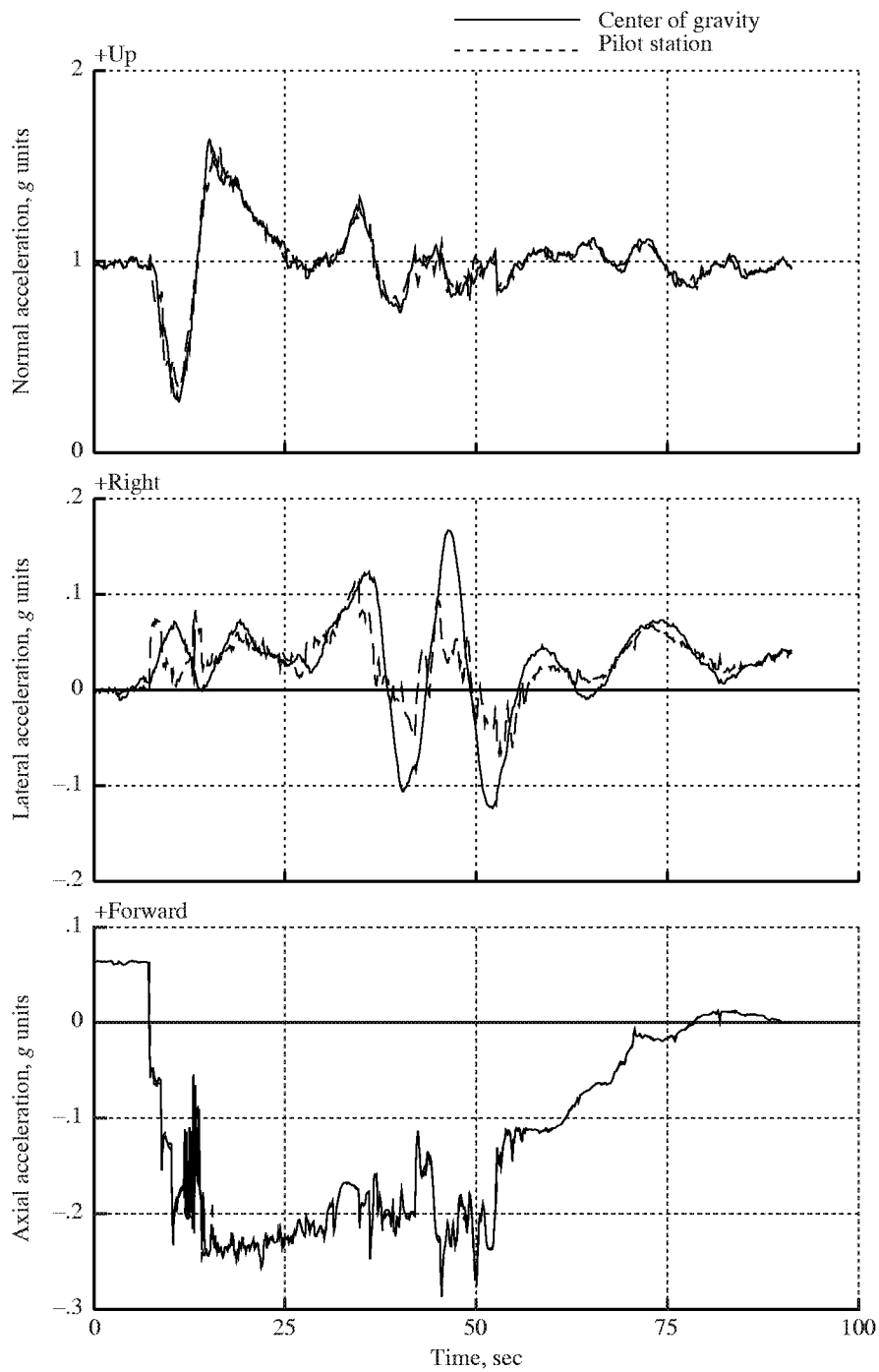

(g) Linear accelerations at center of gravity and pilot station.

Figure 57. Concluded.

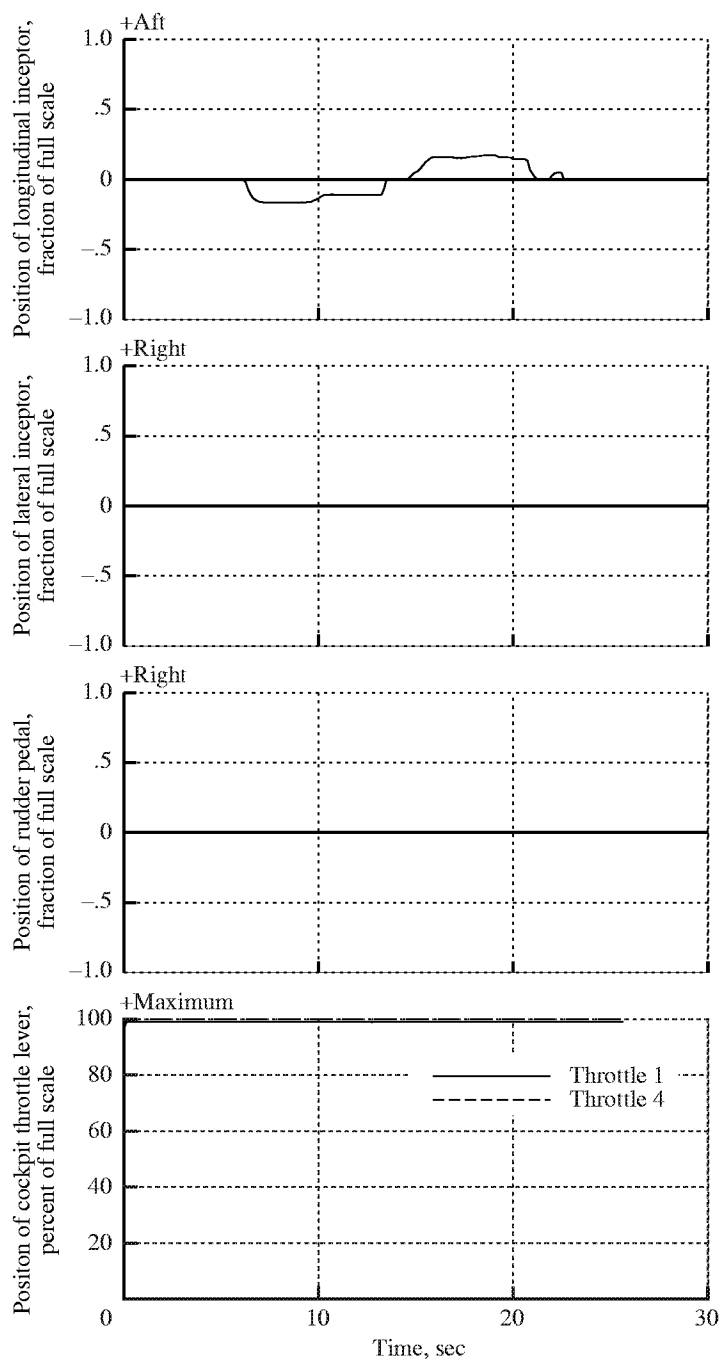

(a) Pilot controls.

Figure 58. Typical time histories for inadvertent speed increase recovery (task 6050).

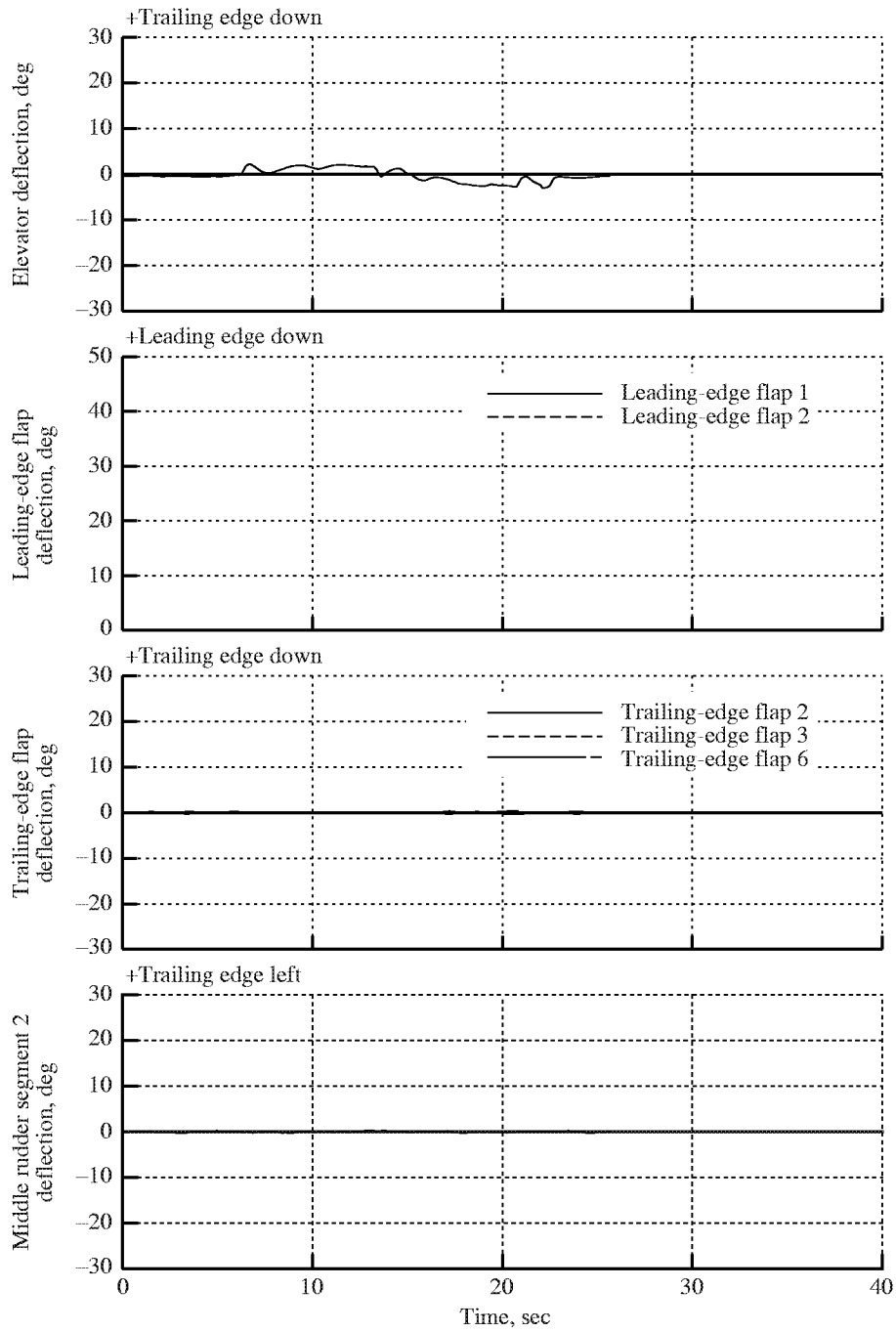

(b) Deflection of elevator; leading-edge flap segments 1 and 2; trailing-edge flap segments 2, 3, and 6; and middle rudder segment 2.

Figure 58. Continued.

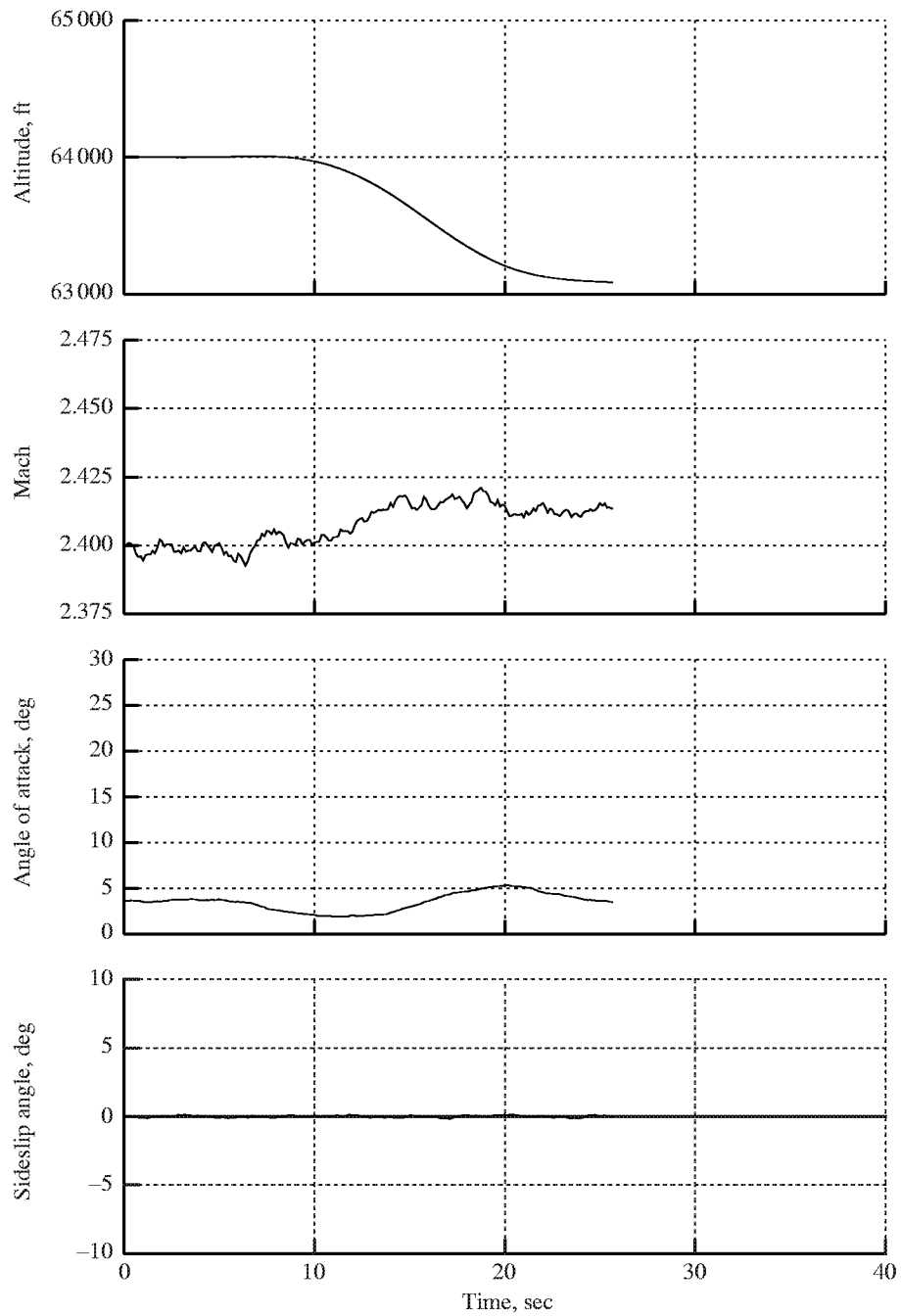

(c) Altitude, Mach, angle of attack, and sideslip angle.

Figure 58. Continued.

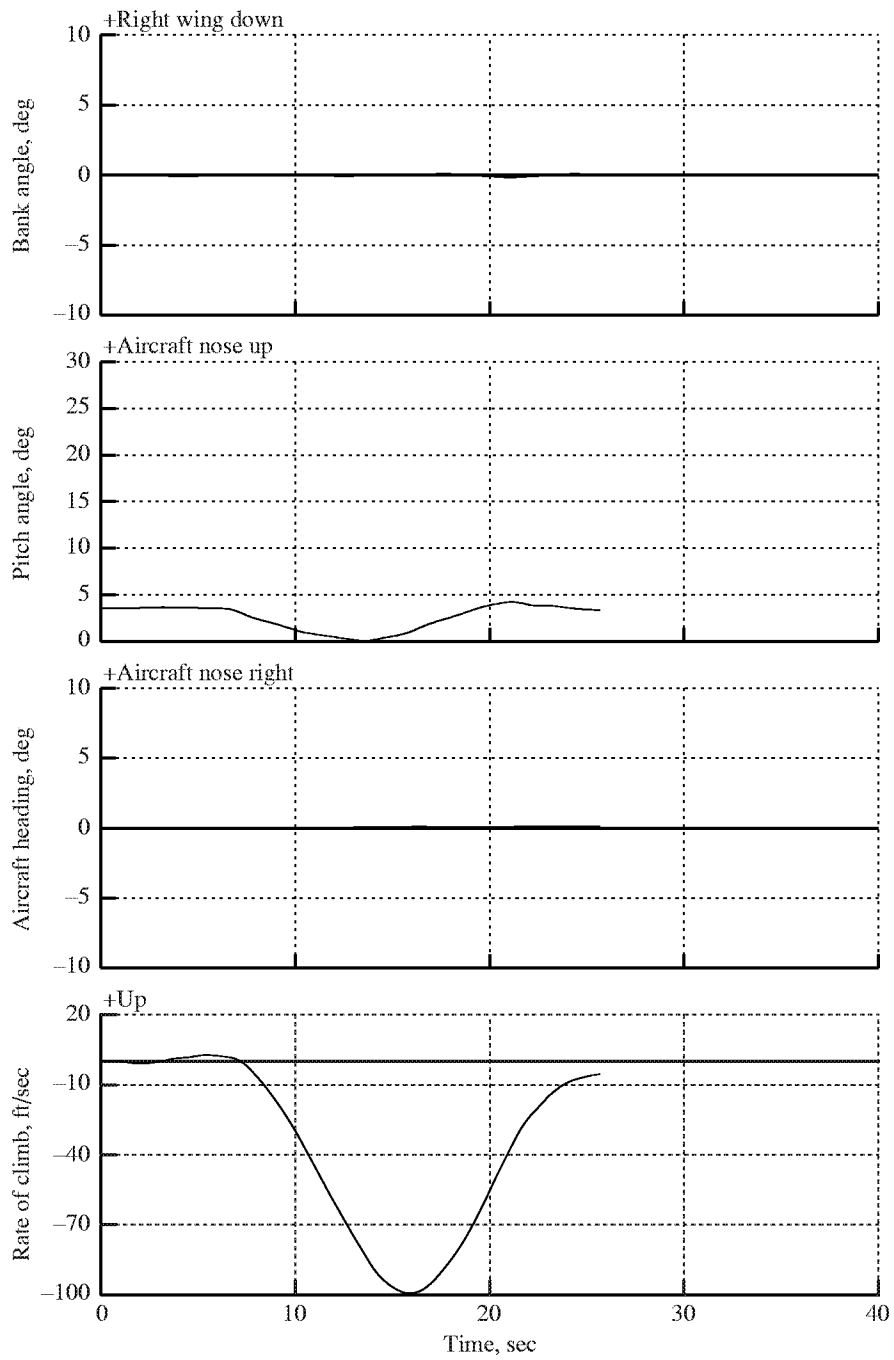

(d) Euler angles and rate of climb.

Figure 58. Continued.

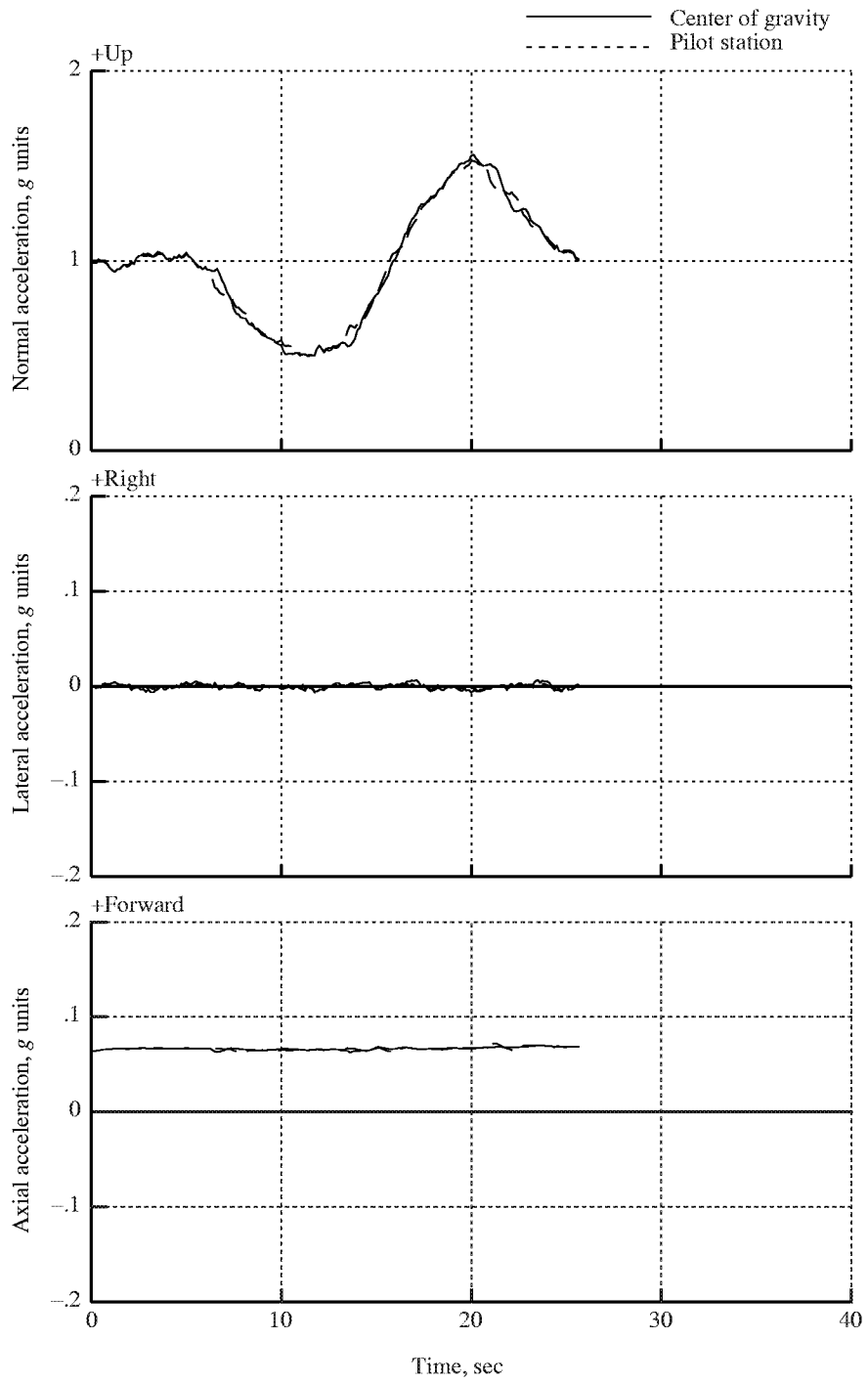

(e) Linear accelerations at center of gravity and pilot station.

Figure 58. Concluded.

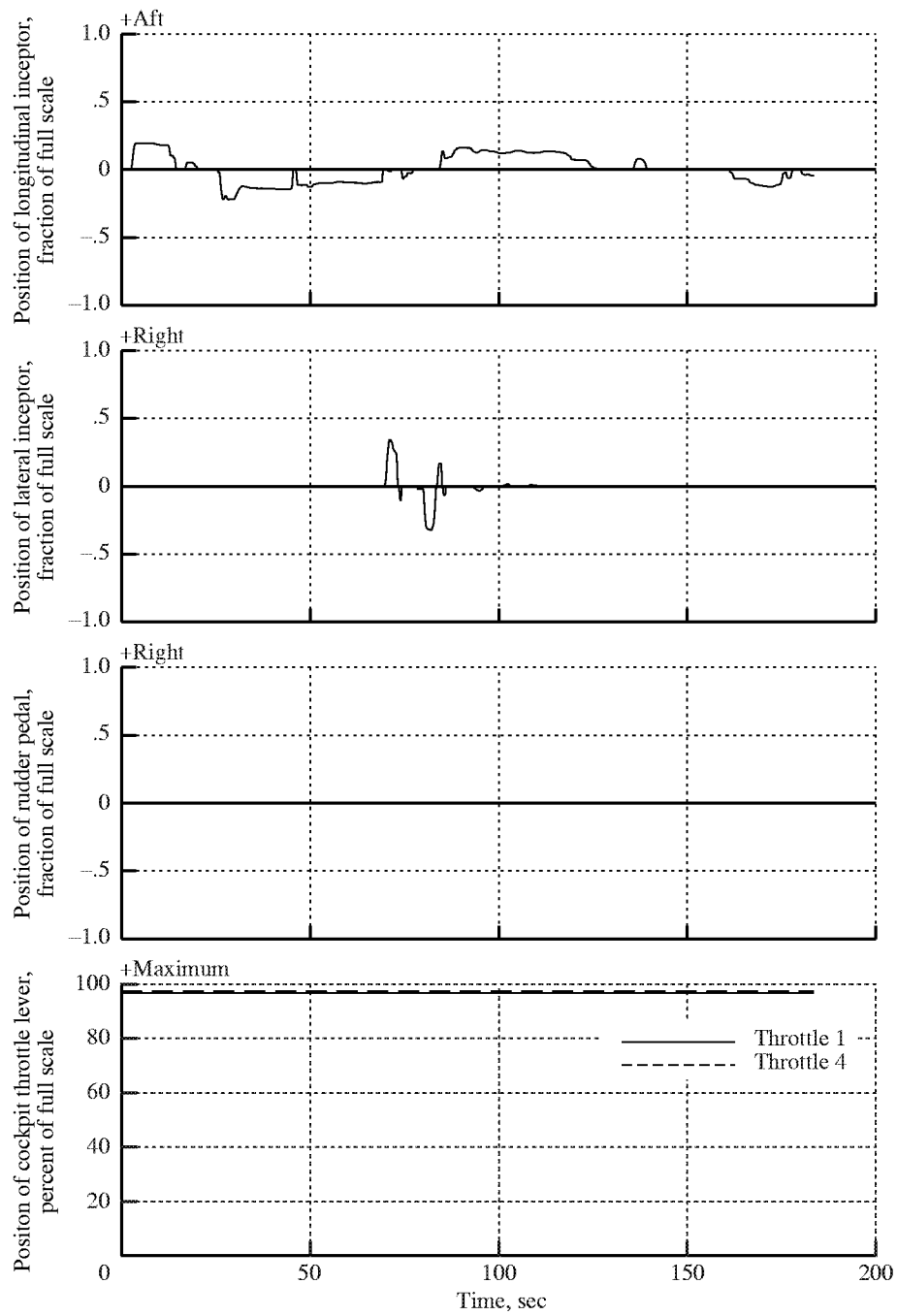

(a) Pilot controls.

Figure 59. Typical time histories for two-axis gust upset recovery (task 6060).

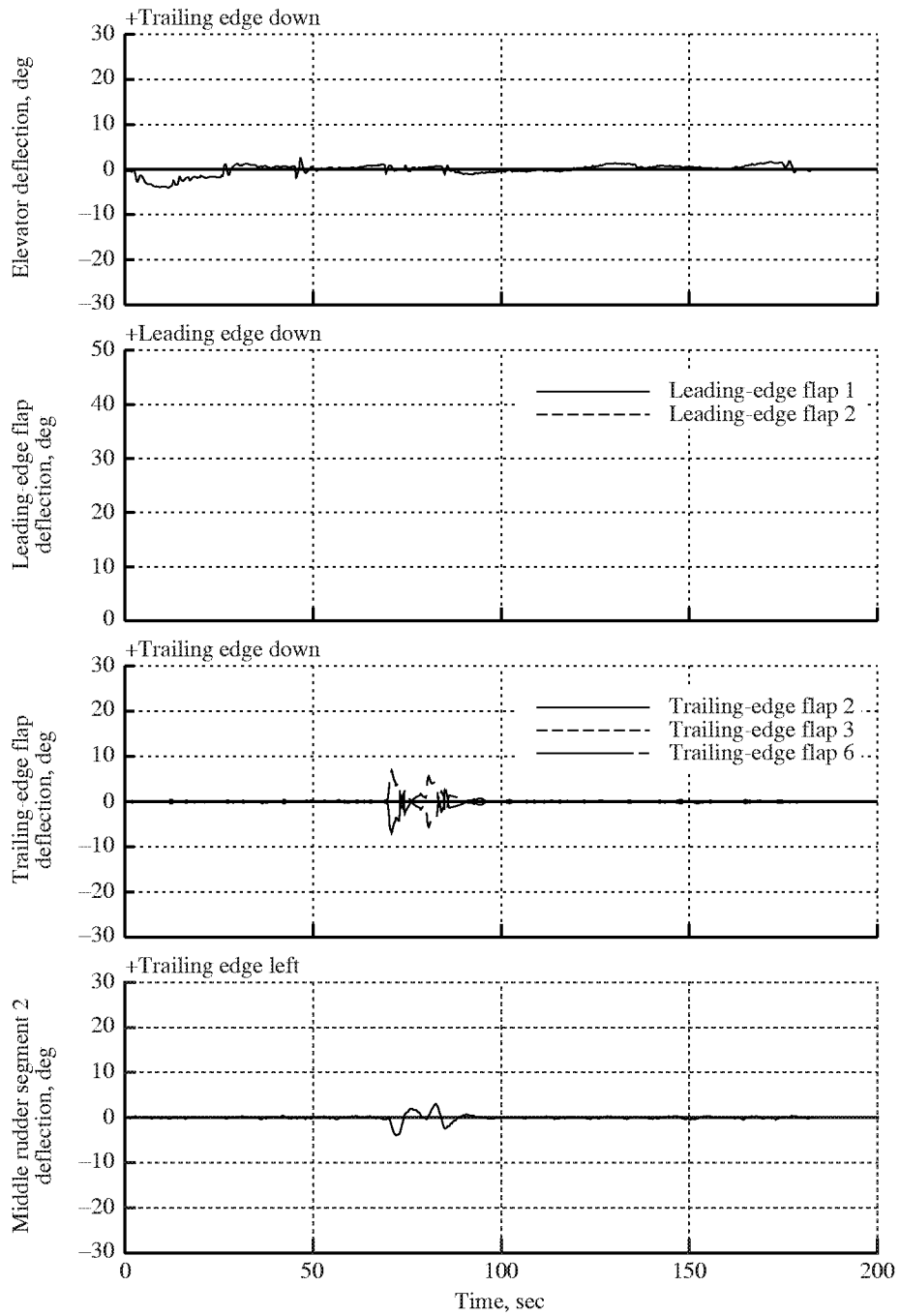

(b) Deflection of elevator; leading-edge flap segments 1 and 2; trailing-edge flap segments 2, 3, and 6; and middle rudder segment 2.

Figure 59. Continued.

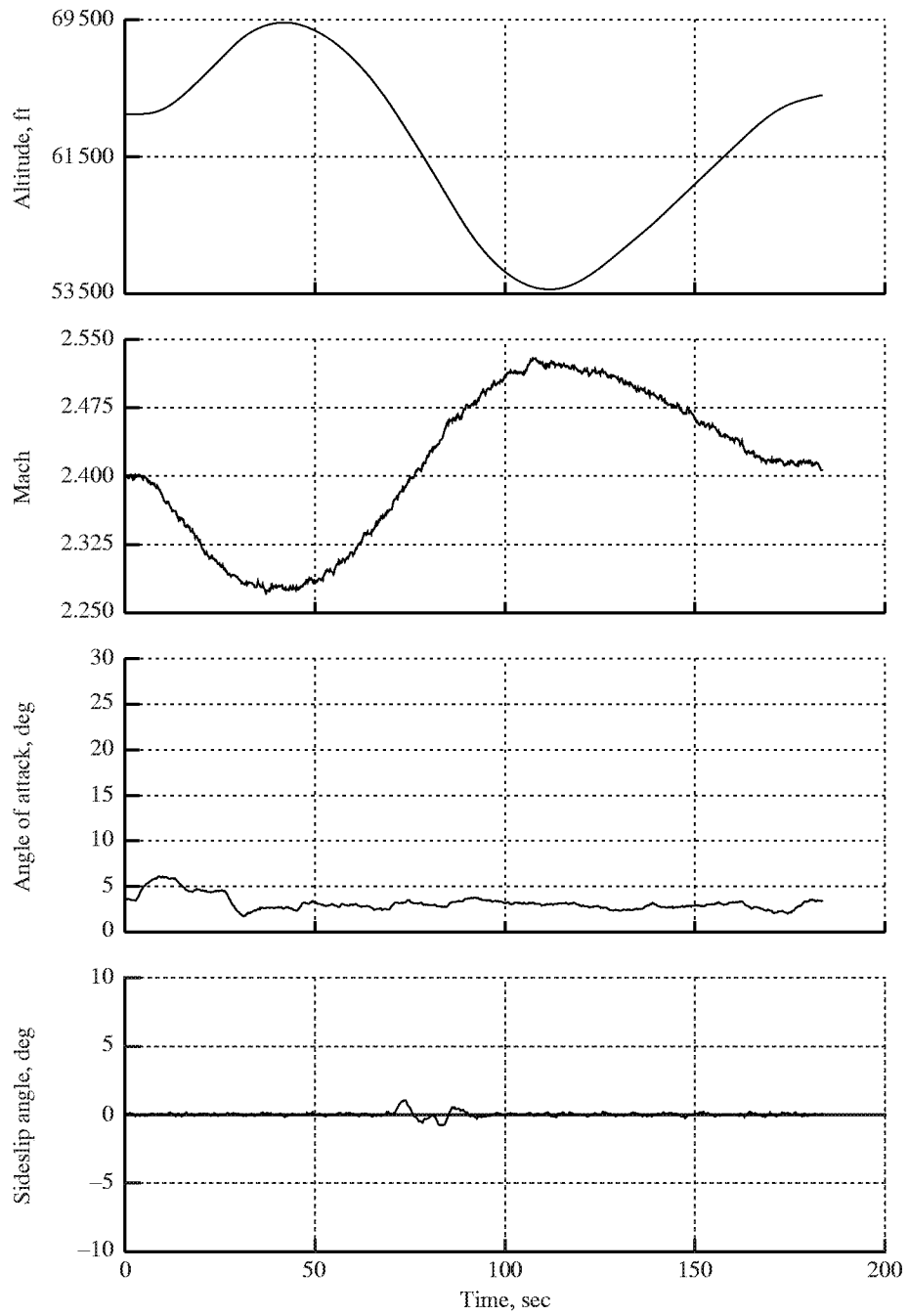

(c) Altitude, Mach, angle of attack, and sideslip angle.

Figure 59. Continued.

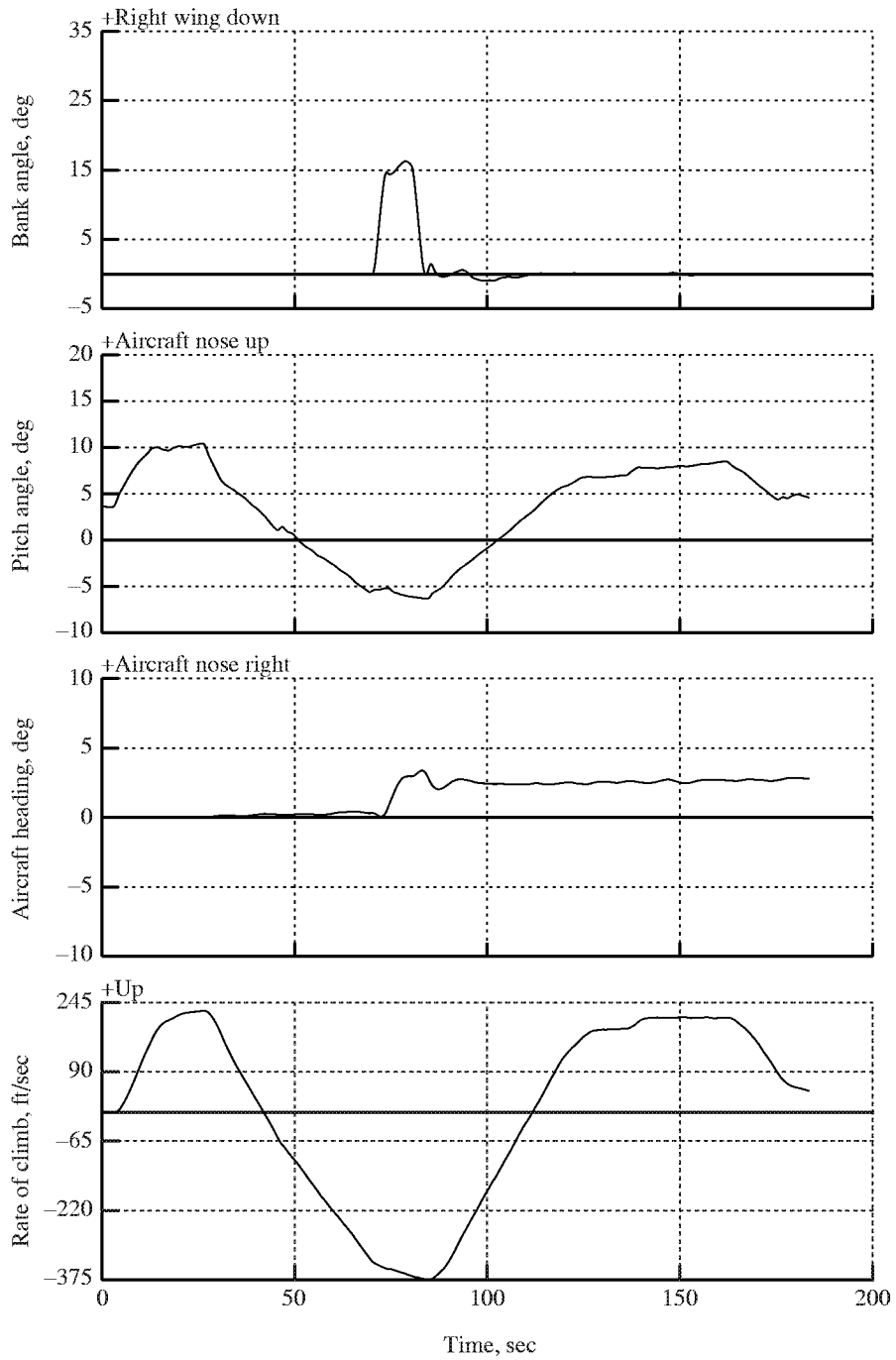

(d) Euler angles and rate of climb.

Figure 59. Continued.

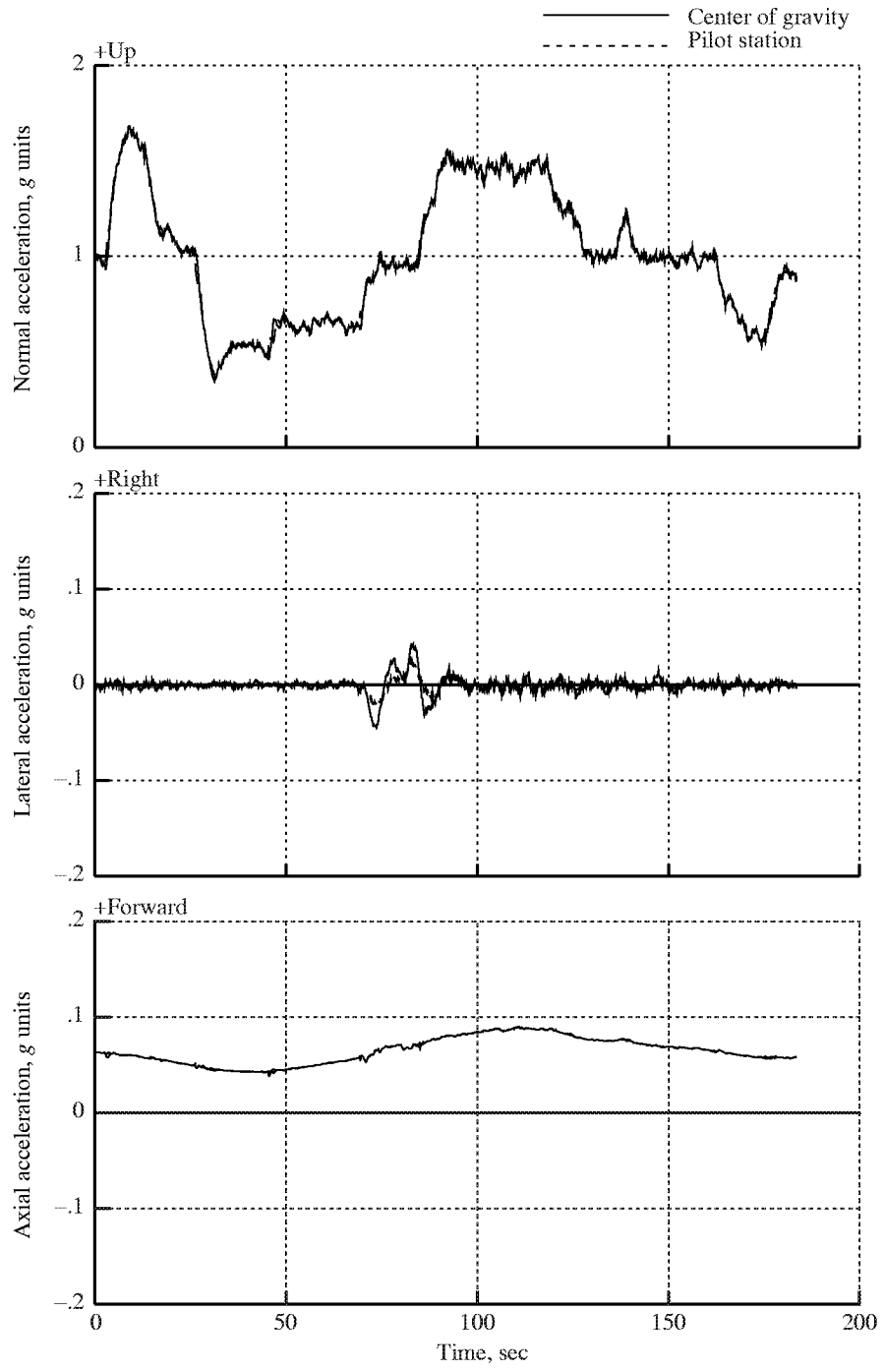

(e) Linear accelerations at center of gravity and pilot station.

Figure 59. Concluded.

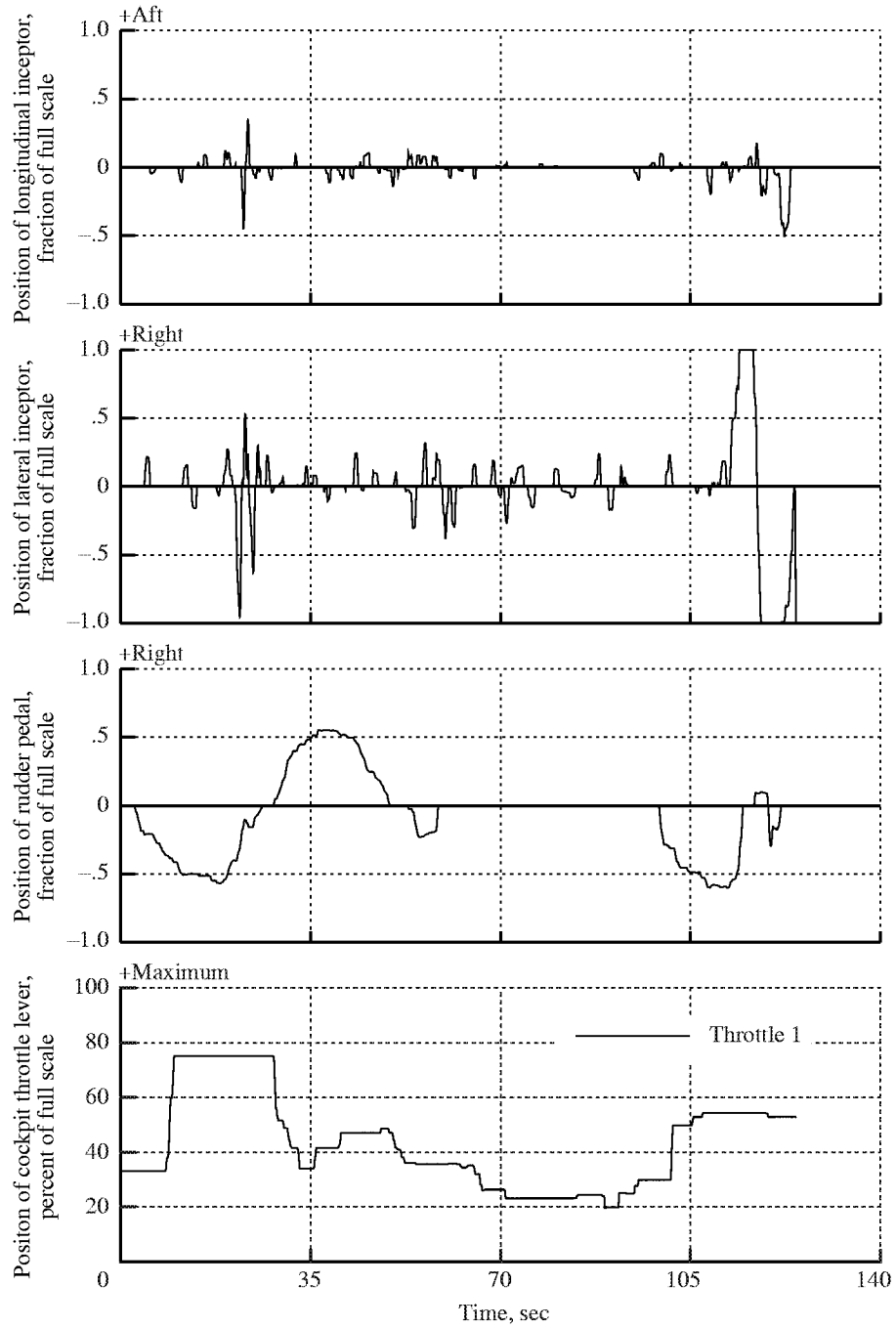

(a) Pilot controls.

Figure 60. Typical time histories for directional control demonstration with OEO (task 7010).

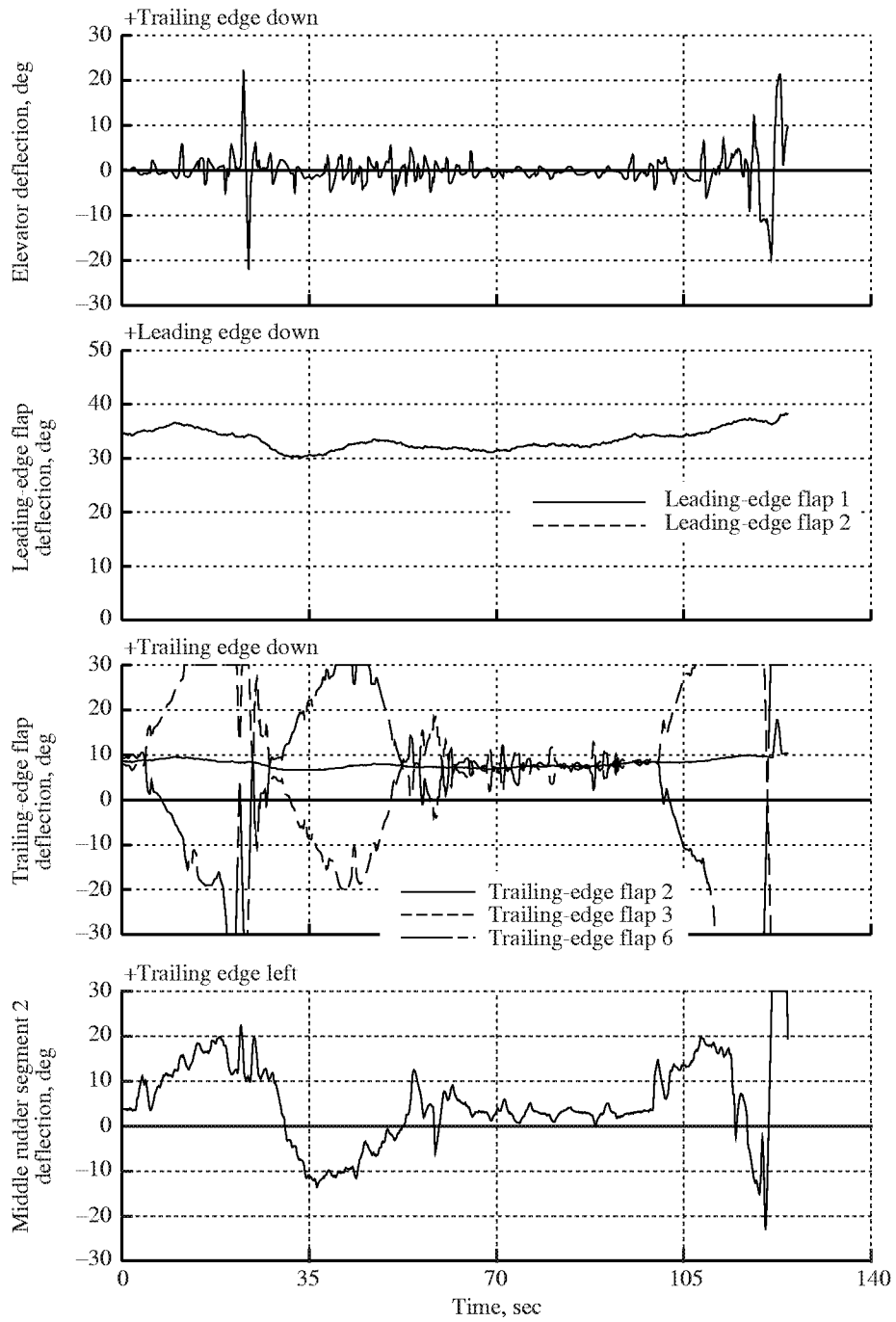

(b) Deflection of elevator; leading-edge flap segments 1 and 2; trailing-edge flap segments 2, 3, and 6; and middle rudder segment 2.

Figure 60. Continued.

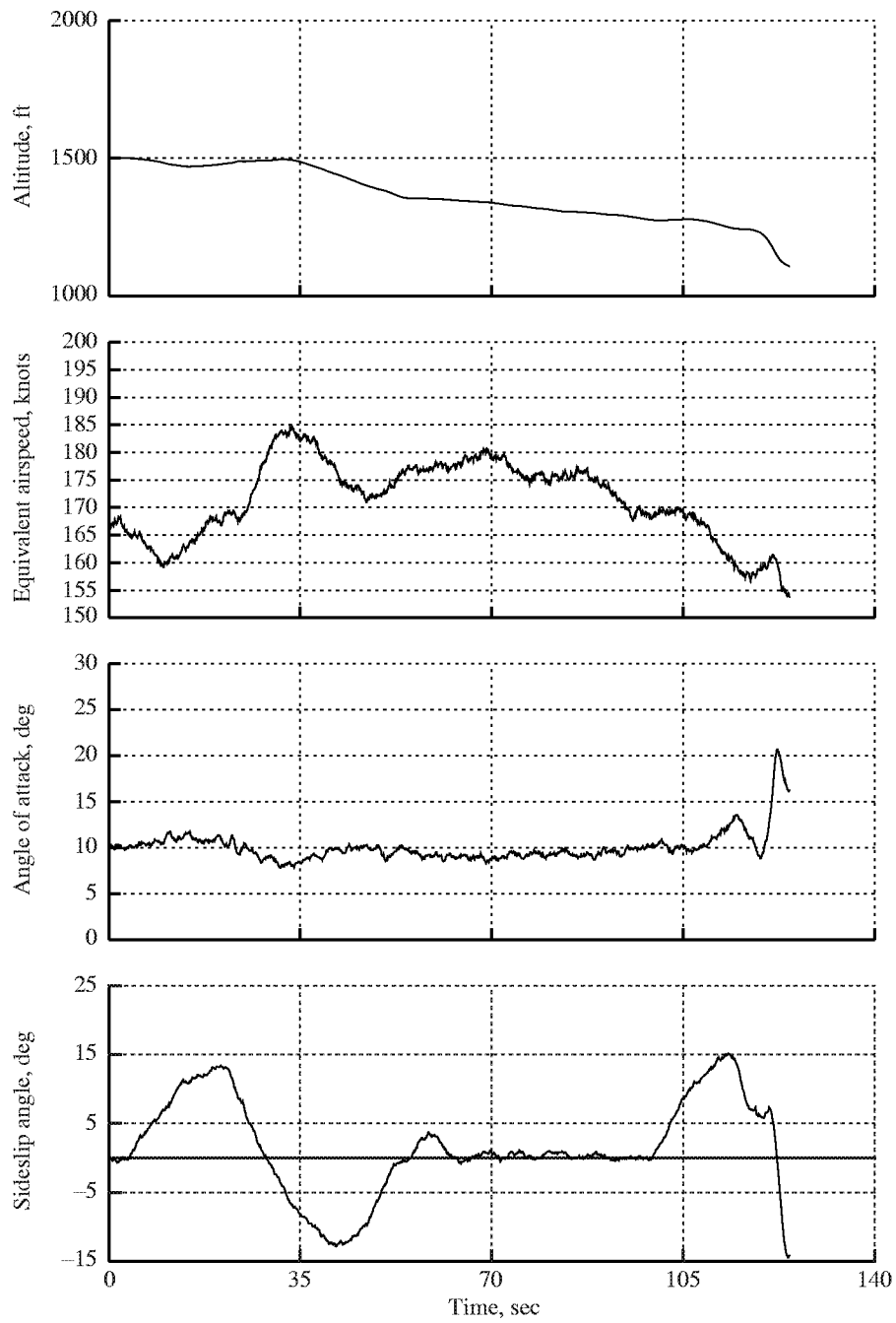

(c) Altitude, equivalent airspeed, angle of attack, and sideslip angle.

Figure 60. Continued.

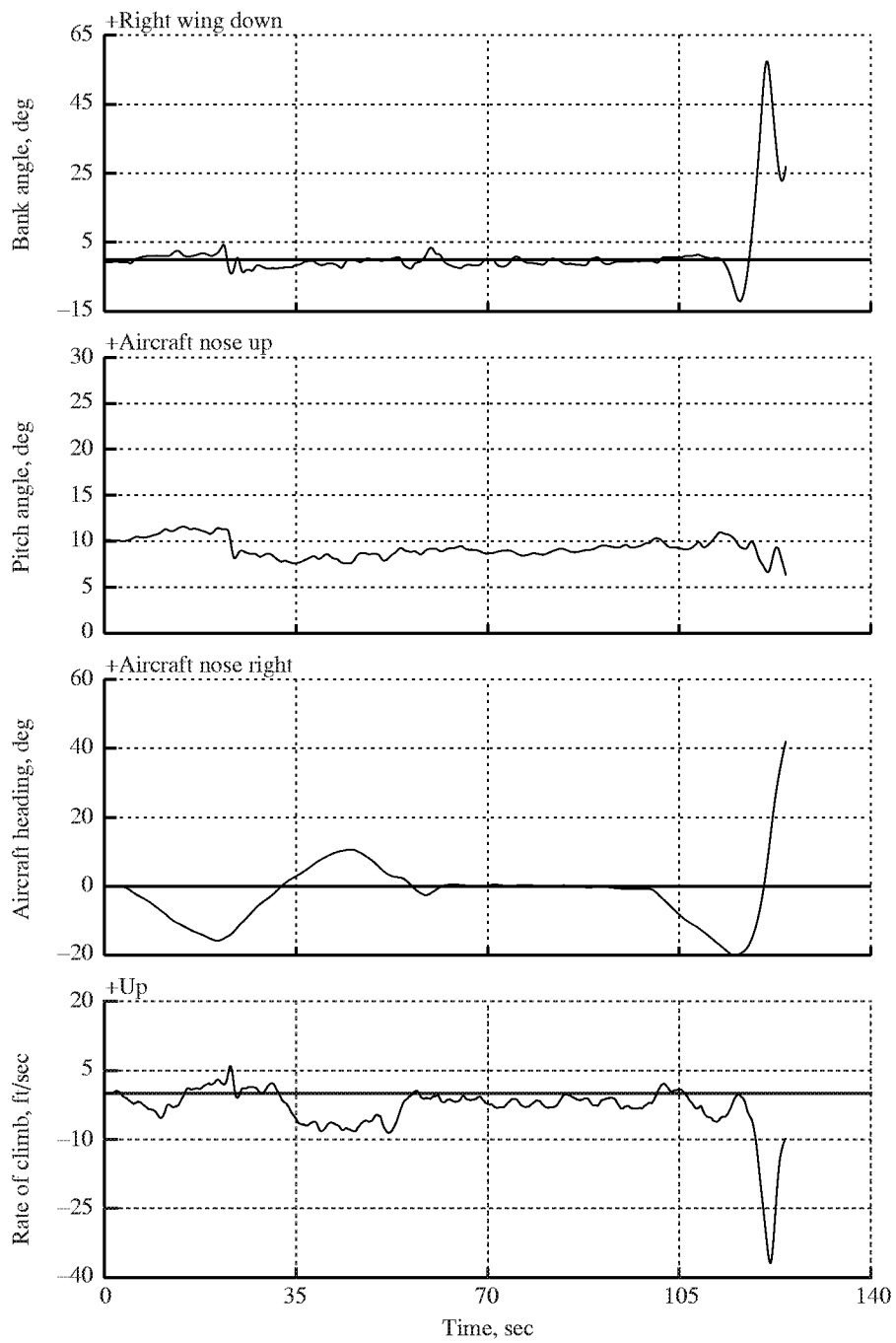

(d) Euler angles and rate of climb.

Figure 60. Continued.

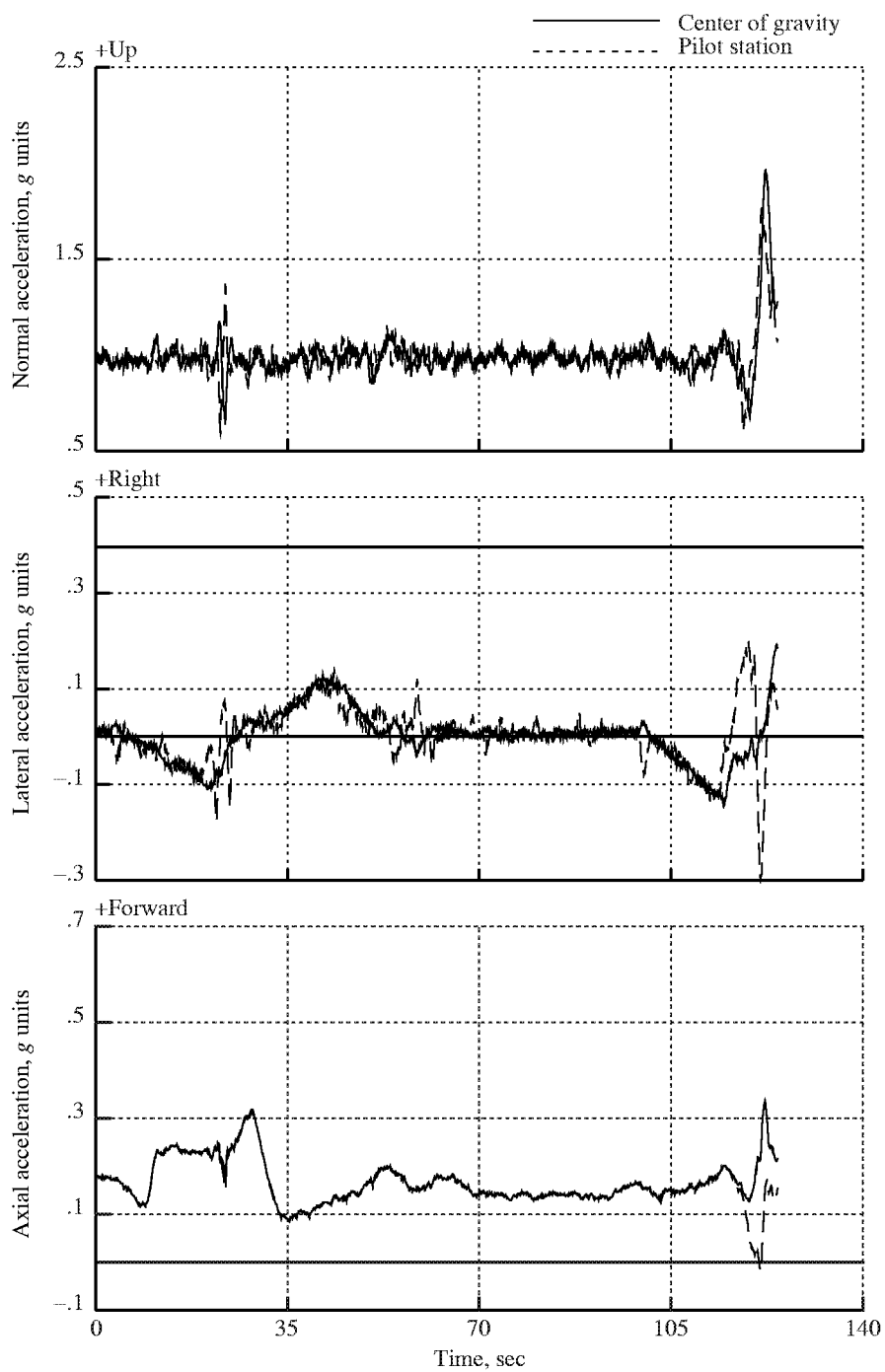

(e) Linear accelerations at center of gravity and pilot station.

Figure 60. Concluded.

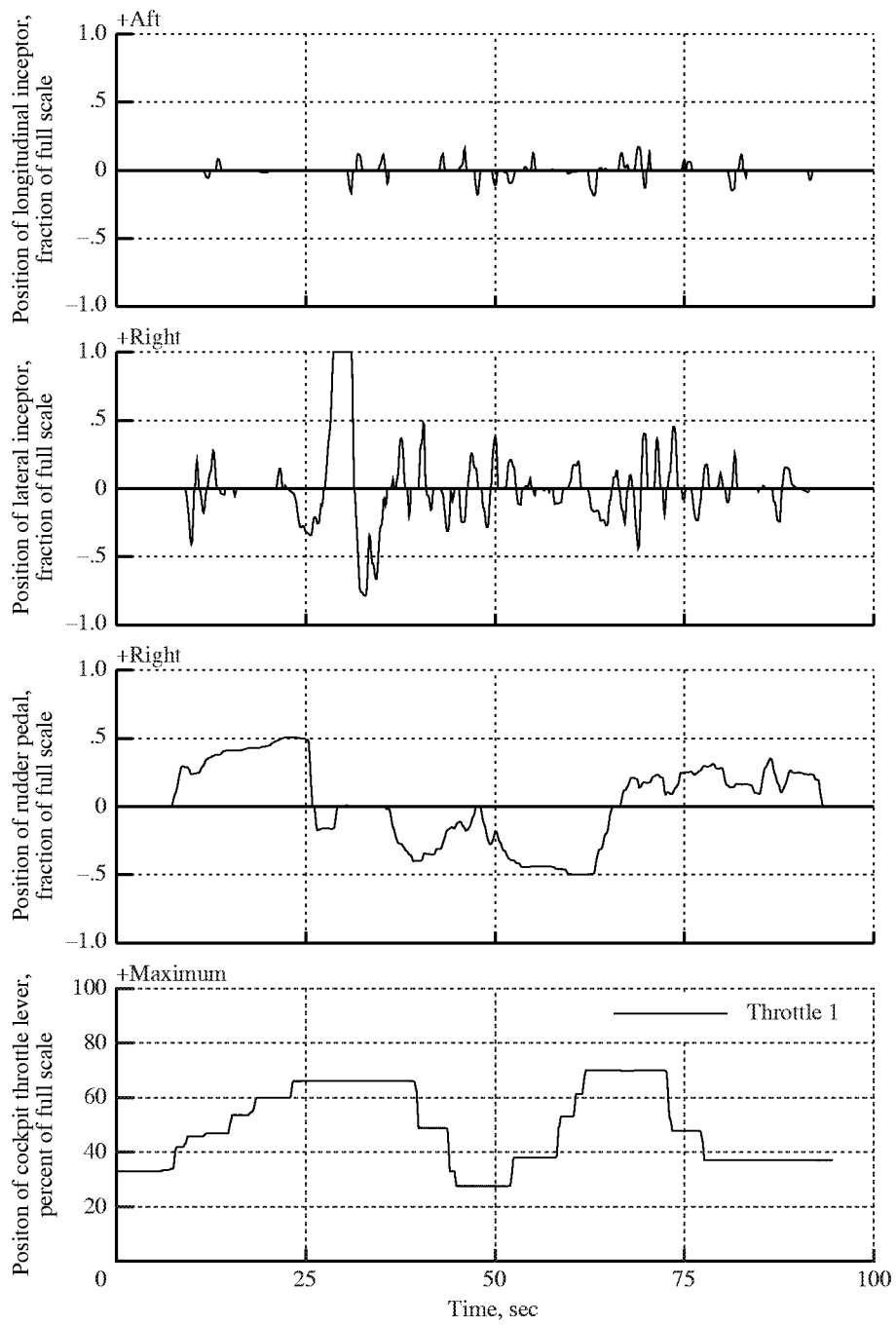

(a) Pilot controls.

Figure 61. Typical time histories for directional control demonstration with OEO (task 7010) without departure.

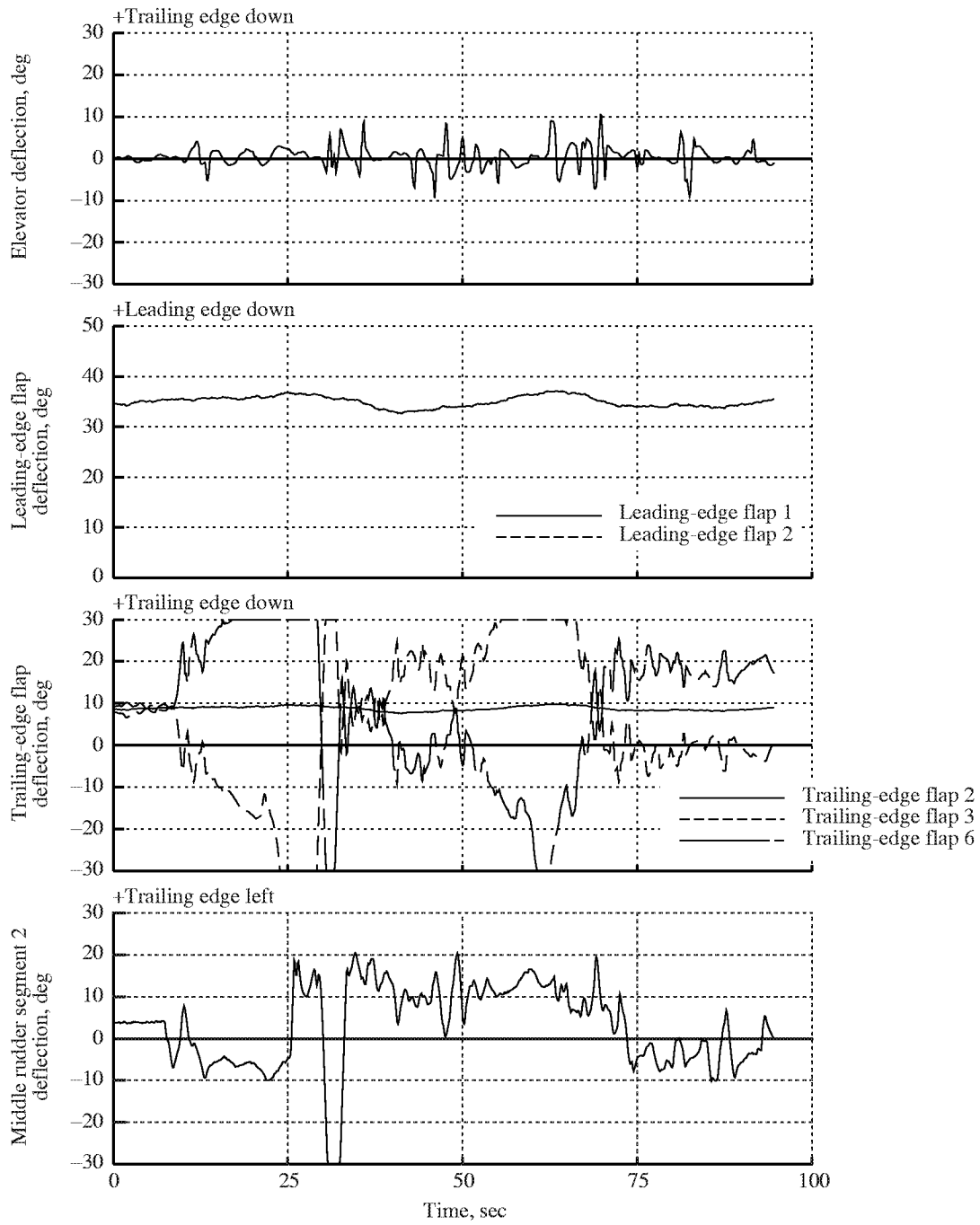

(b) Deflection of elevator; leading-edge flap segments 1 and 2; trailing-edge flap segments 2, 3, and 6; and middle rudder segment 2.

Figure 61. Continued.

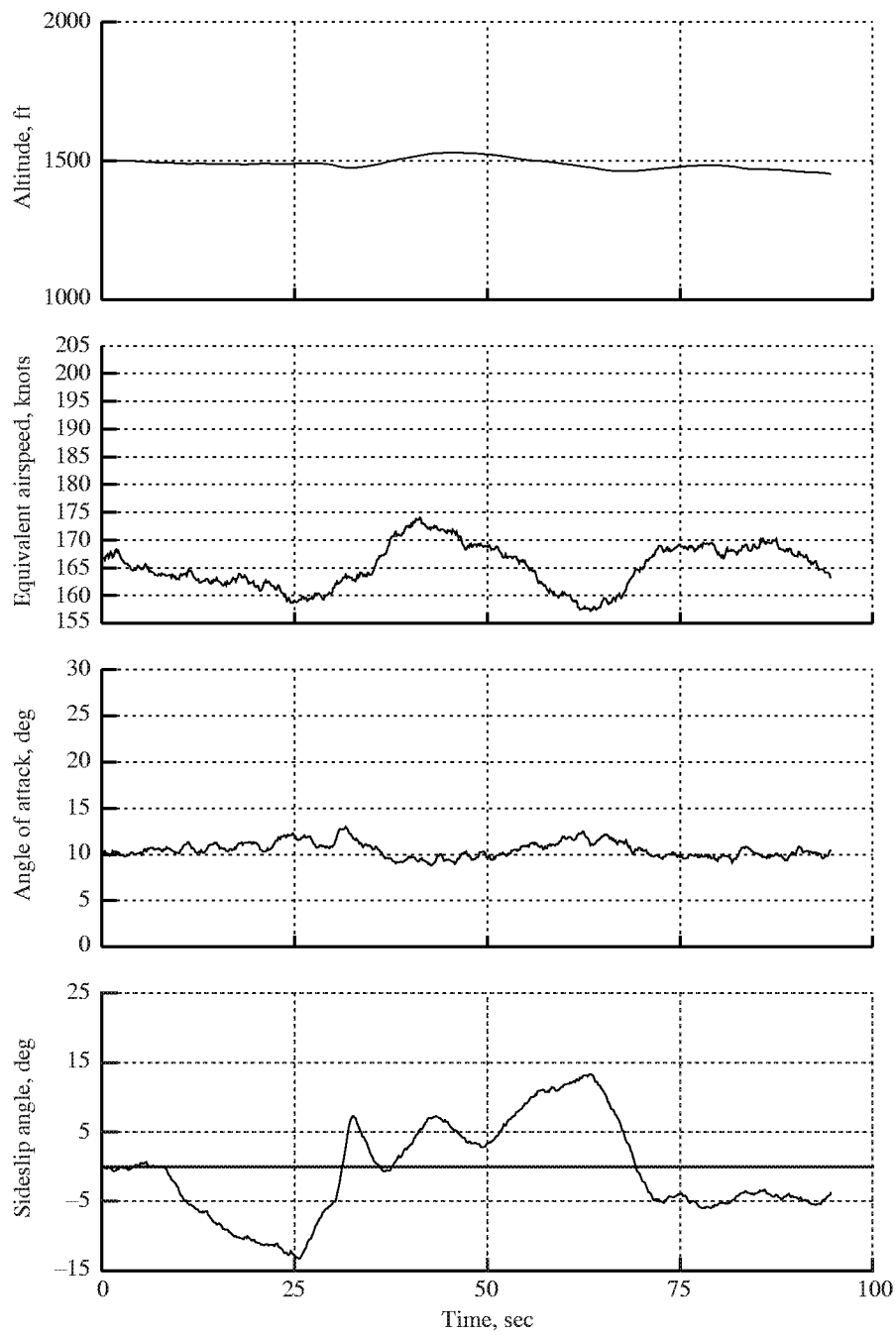

(c) Altitude, equivalent airspeed, angle of attack, and sideslip angle.

Figure 61. Continued.

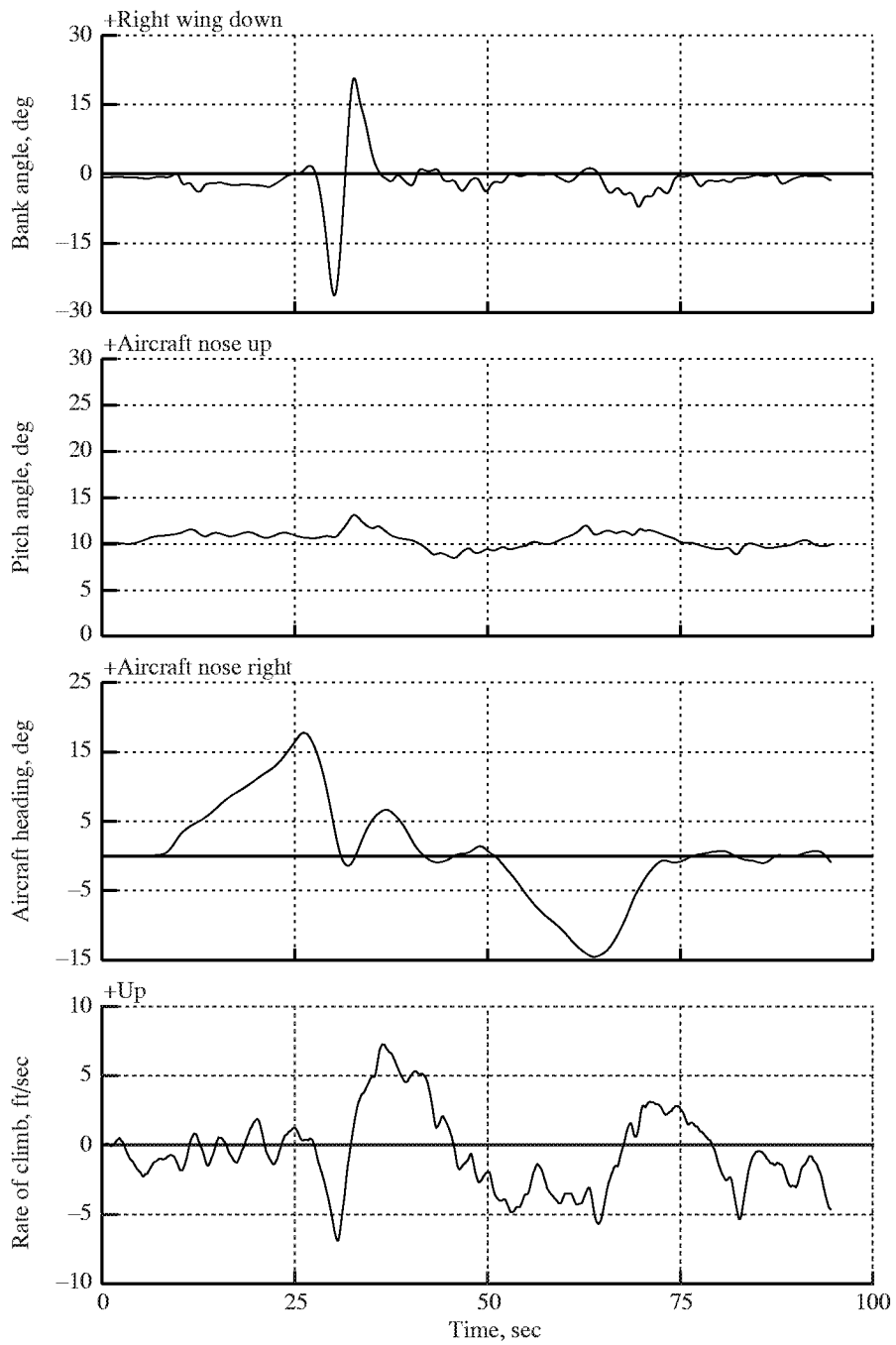

(d) Euler angles and rate of climb.

Figure 61. Continued.

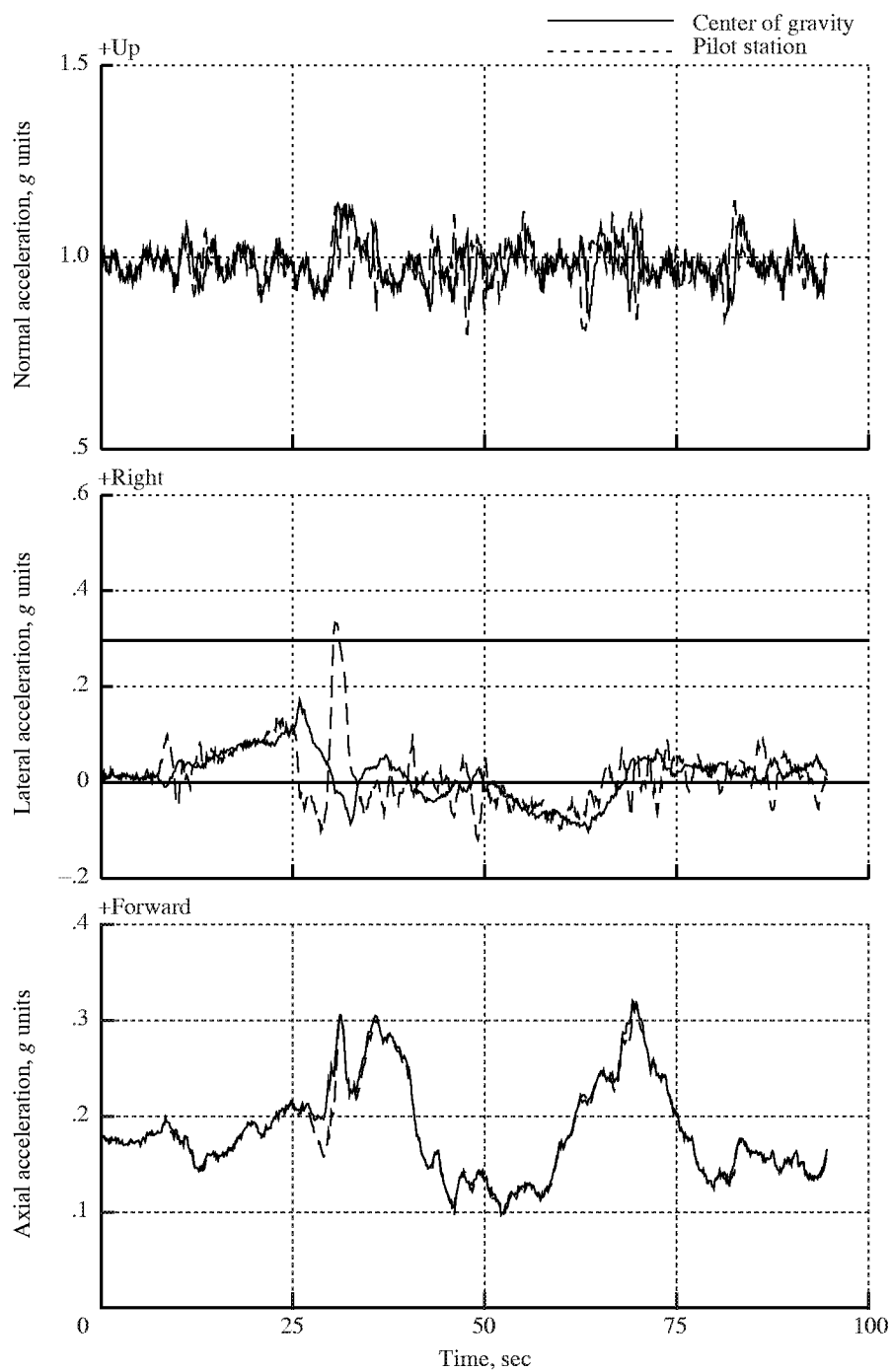

(e) Linear accelerations at center of gravity and pilot station.

Figure 61. Concluded.

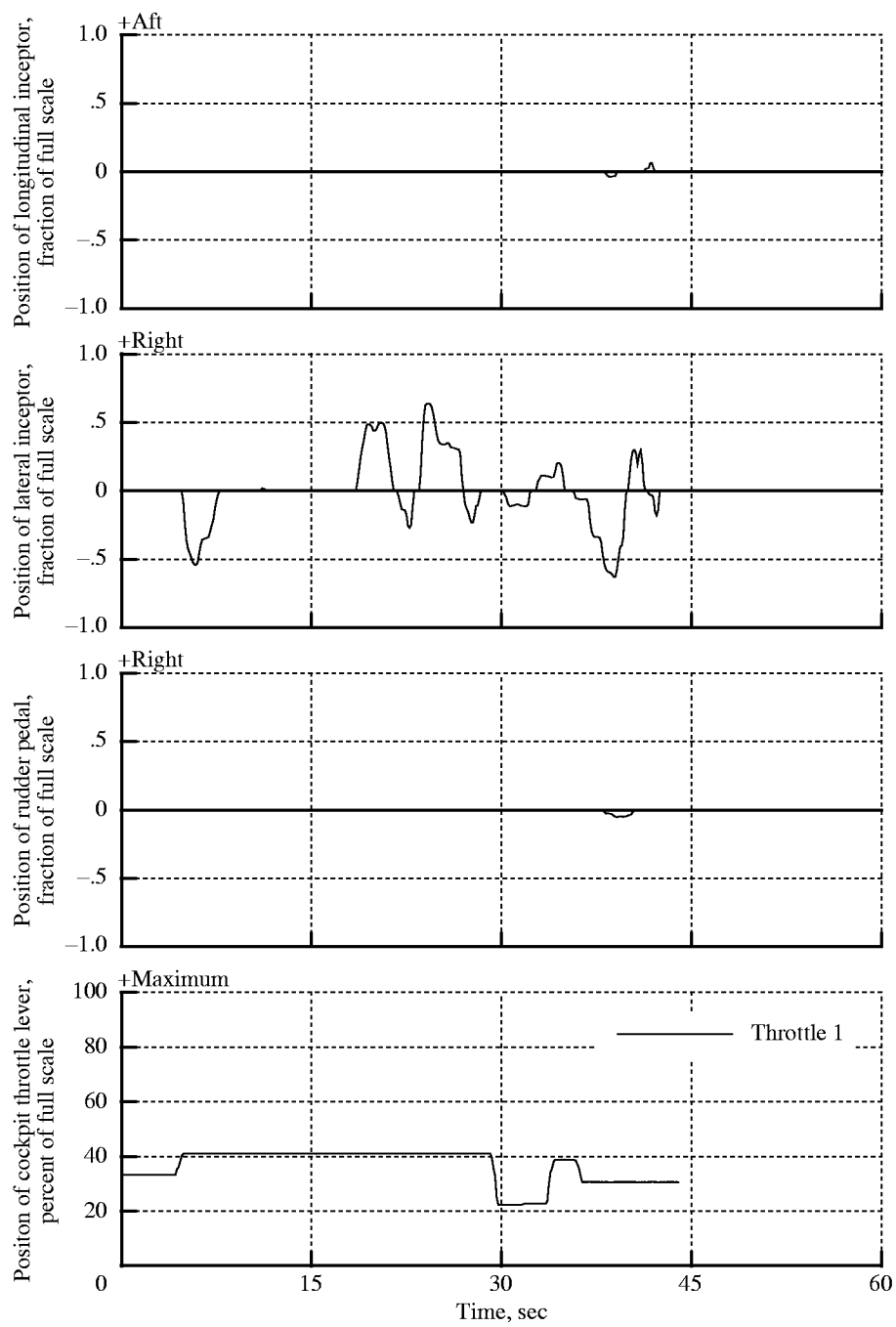

(a) Pilot controls.

Figure 62. Typical time histories for lateral control demonstration with OEO (task 7020).

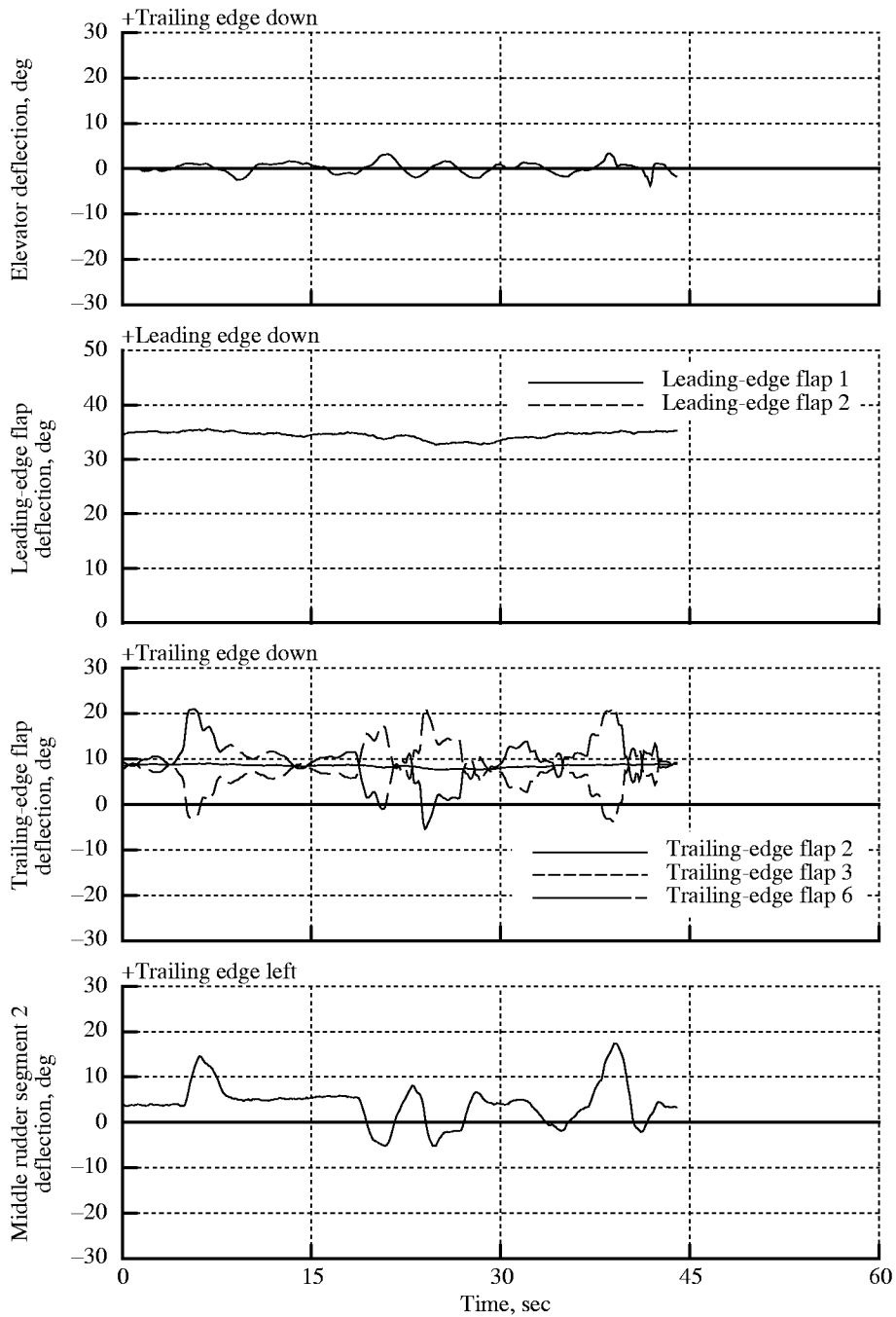

(b) Deflection of elevator; leading-edge flap segments 1 and 2; trailing-edge flap segments 2, 3, and 6; and middle rudder segment 2.

Figure 62. Continued.

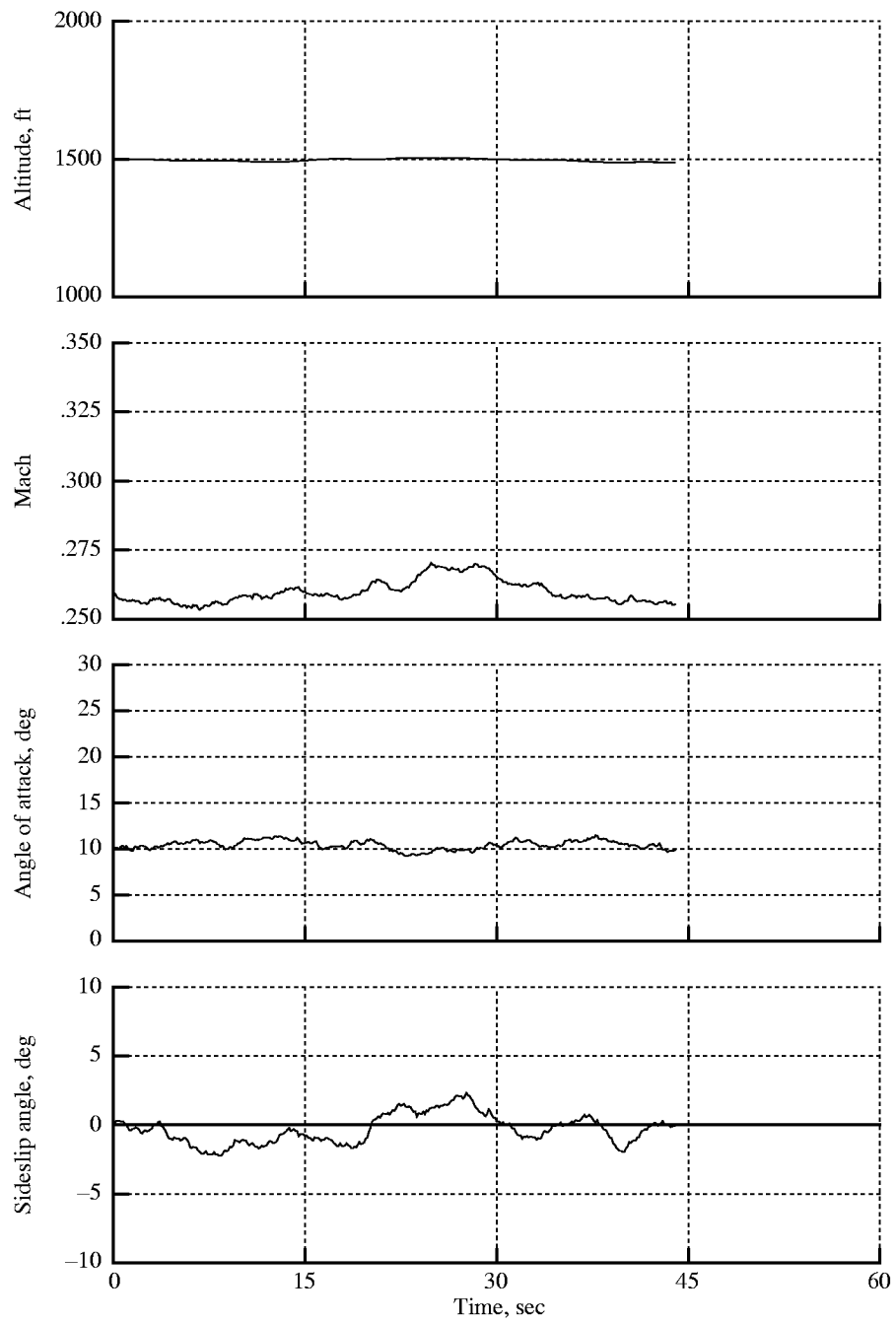

(c) Altitude, Mach, angle of attack, and sideslip angle.

Figure 62. Continued.

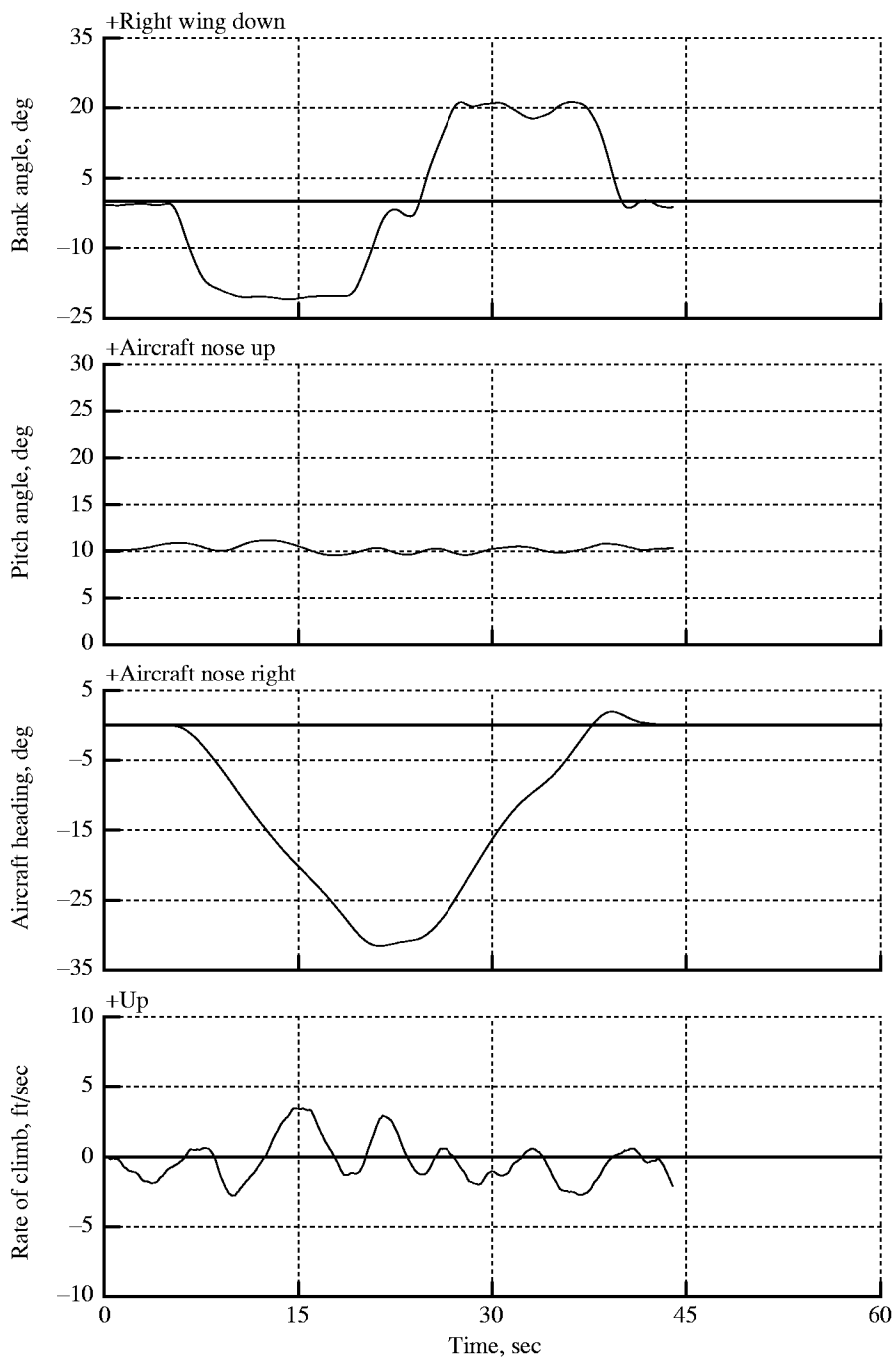

(d) Euler angles and rate of climb.

Figure 62. Continued.

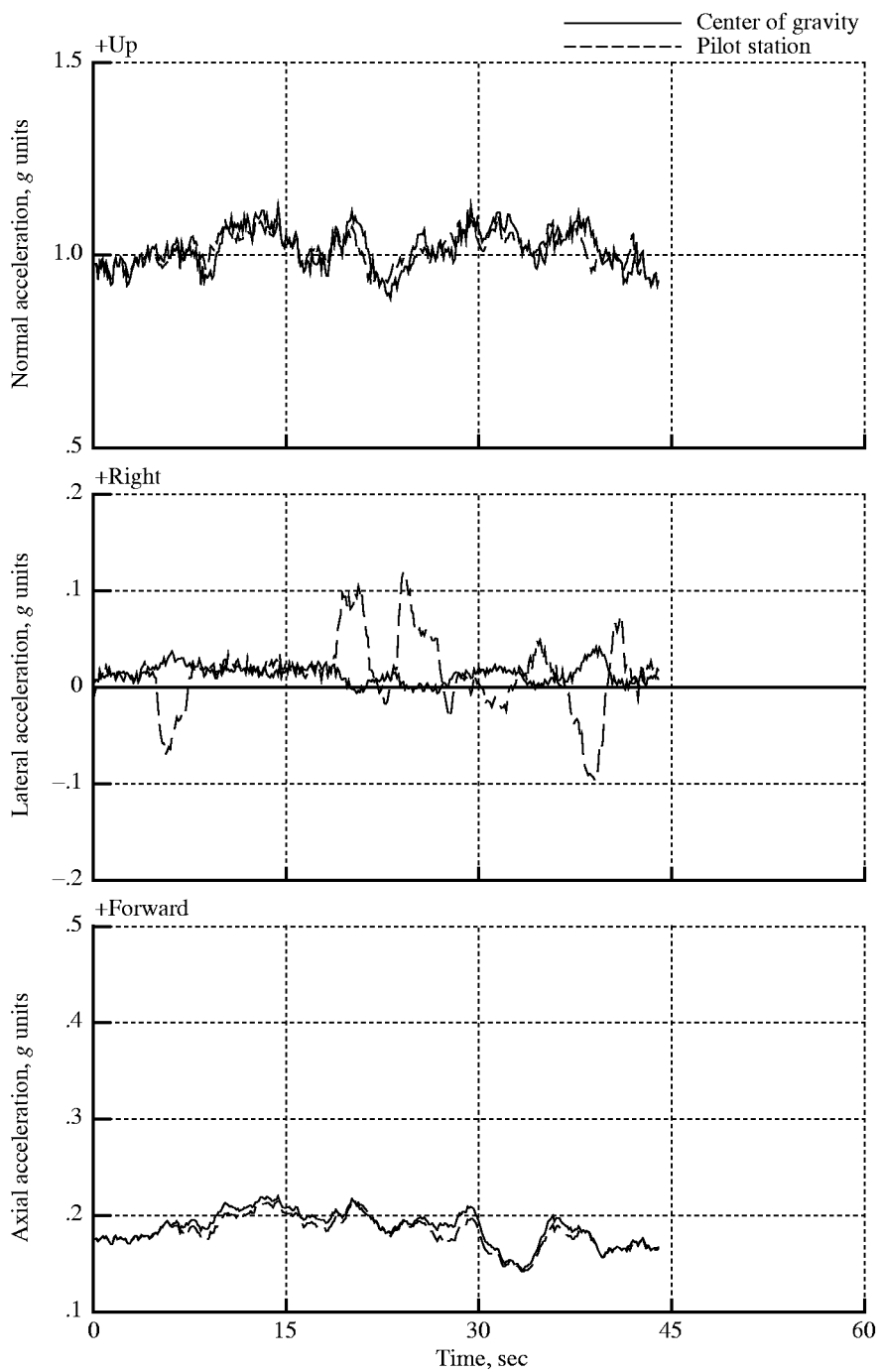

(e) Linear accelerations at center of gravity and pilot station.

Figure 62. Concluded.

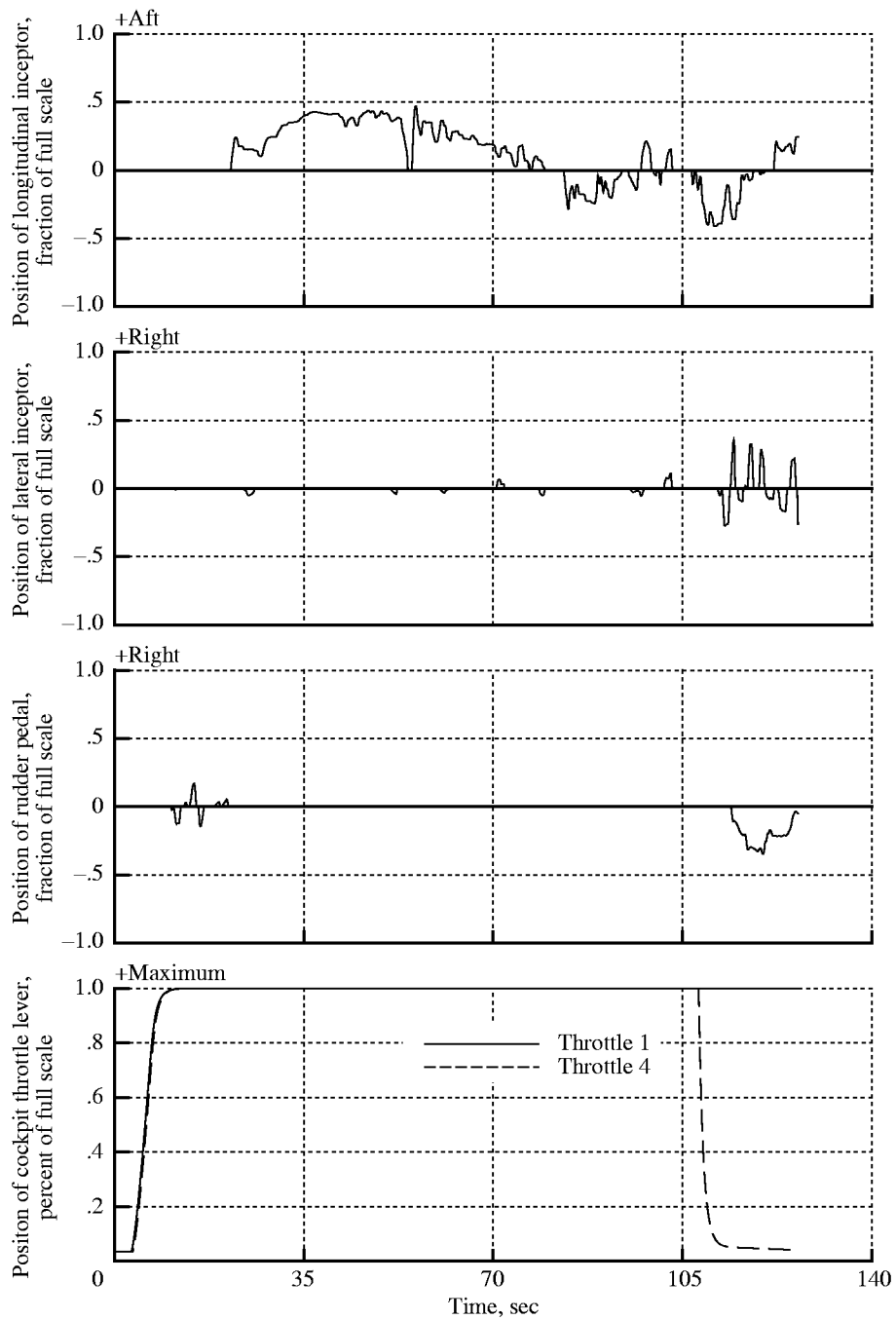

(a) Pilot controls.

Figure 63. Typical time histories for dynamic V_{mca} (task 7040).

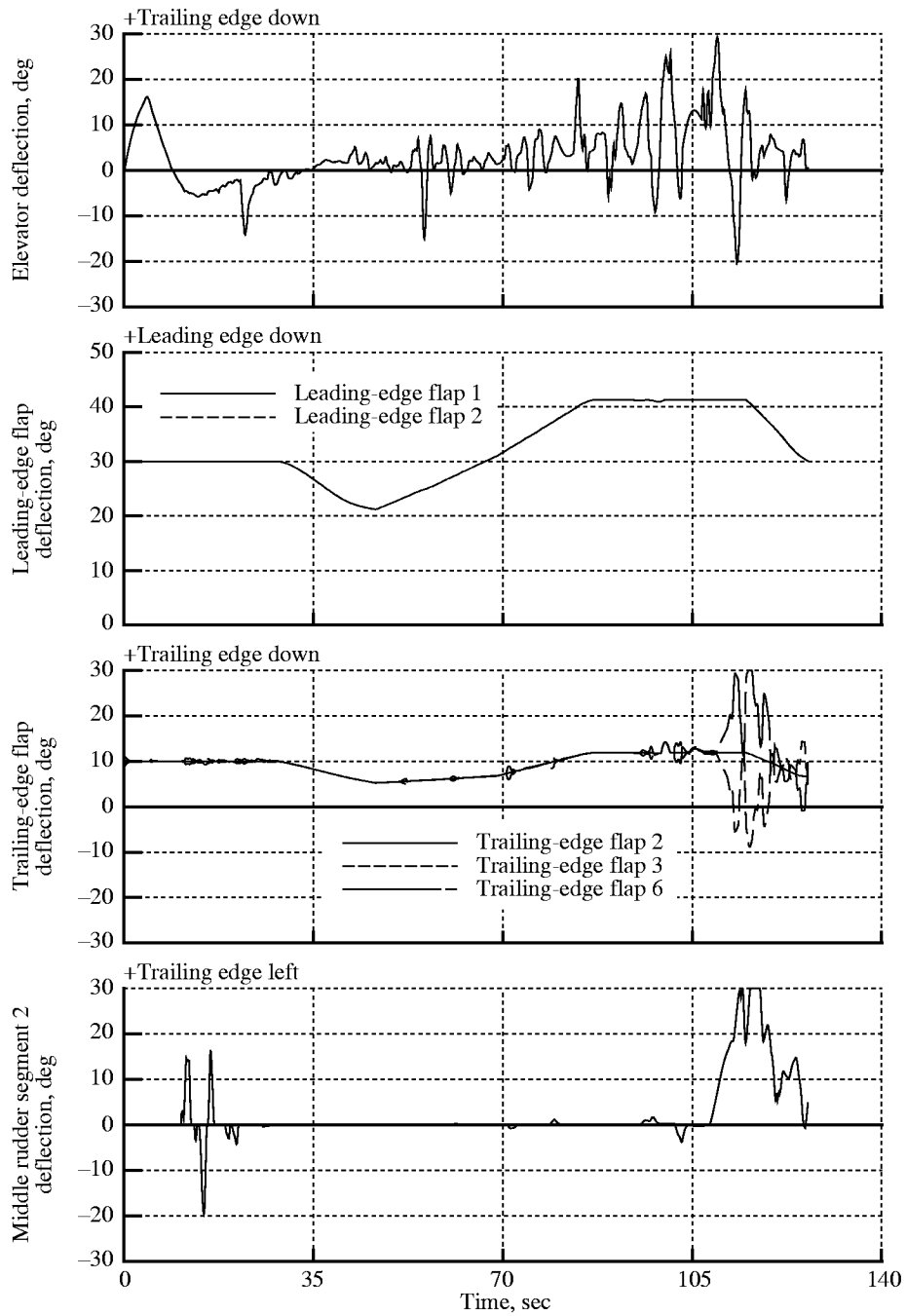

(b) Deflection of elevator; leading-edge flap segments 1 and 2; trailing-edge flap segments 2, 3, and 6; and middle rudder segment 2.

Figure 63. Continued.

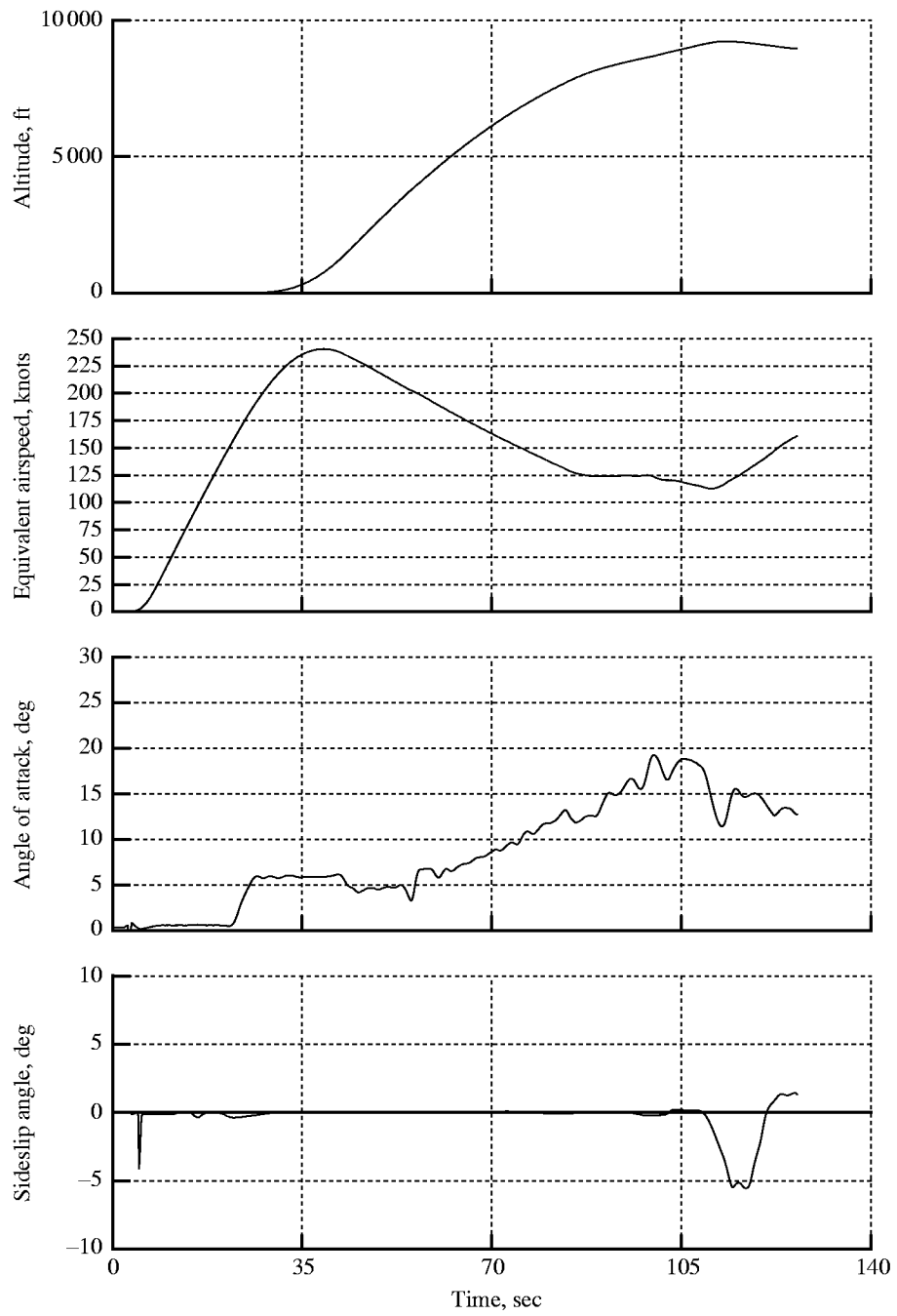

(c) Altitude, equivalent airspeed, angle of attack, and sideslip angle.

Figure 63. Continued.

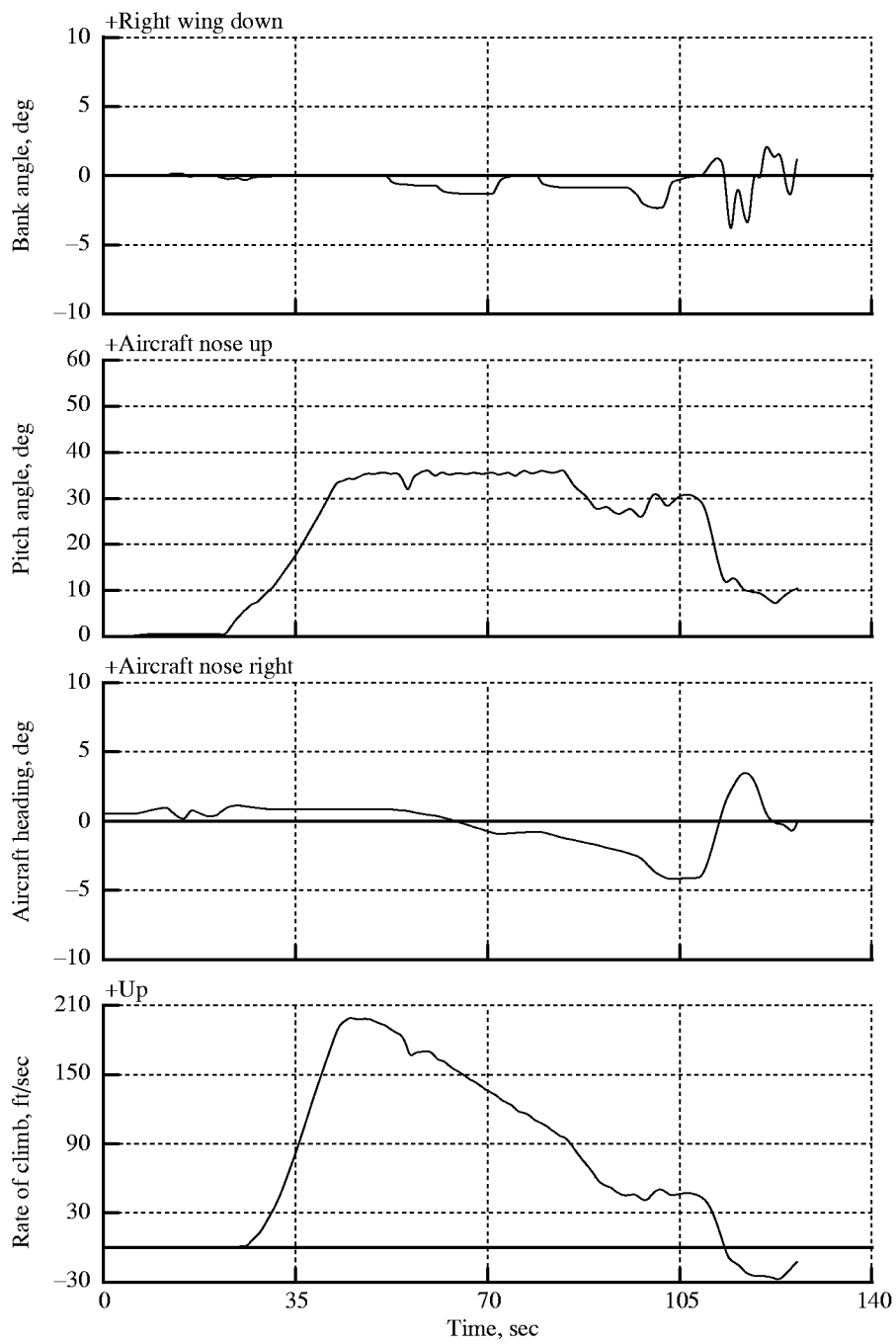

(d) Euler angles and rate of climb.

Figure 63. Continued.

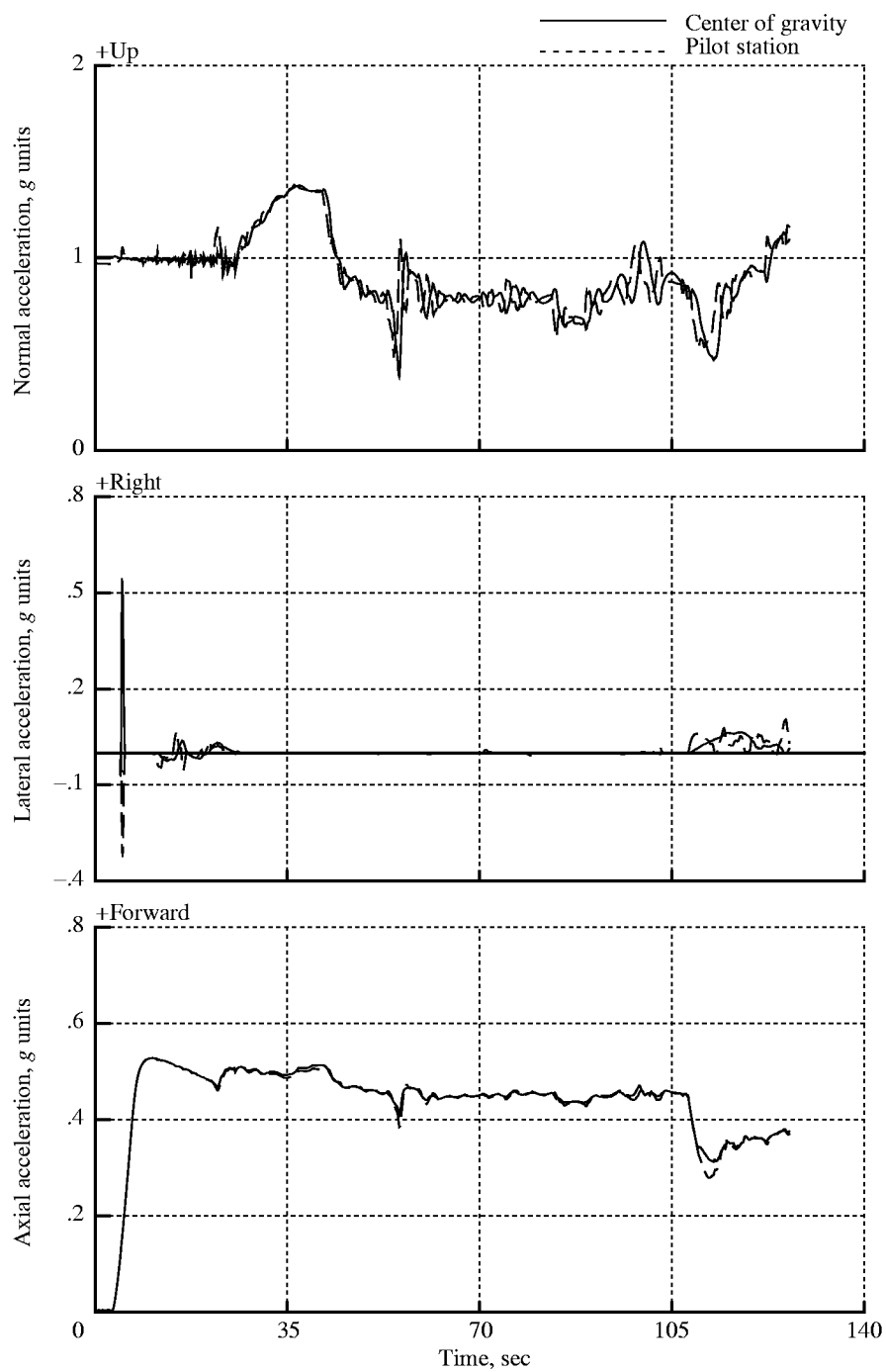

(e) Linear accelerations at center of gravity and pilot station.

Figure 63. Concluded.

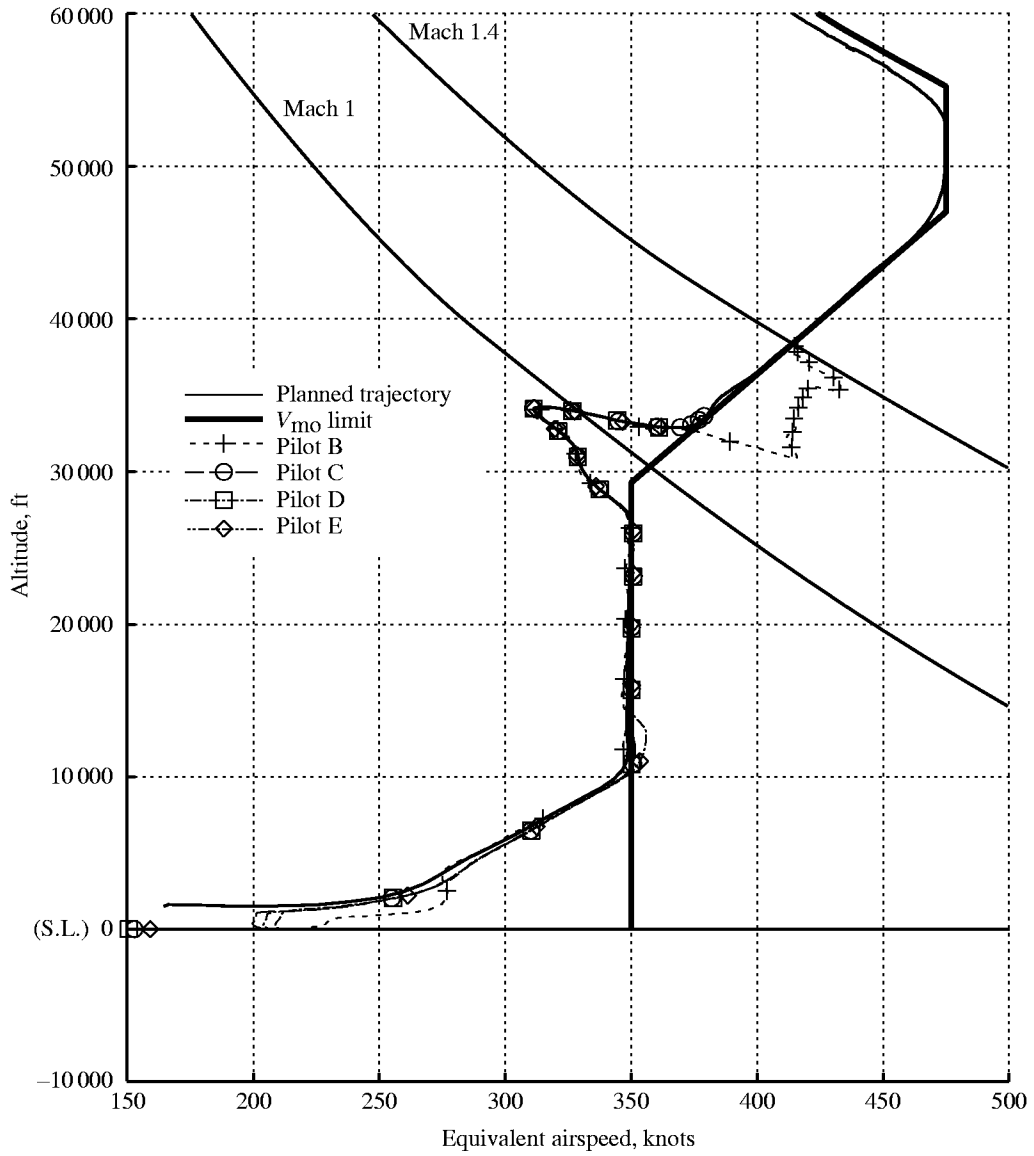

(a) Complete trajectories.

Figure 64. Trajectories of profile climb (task 3030).

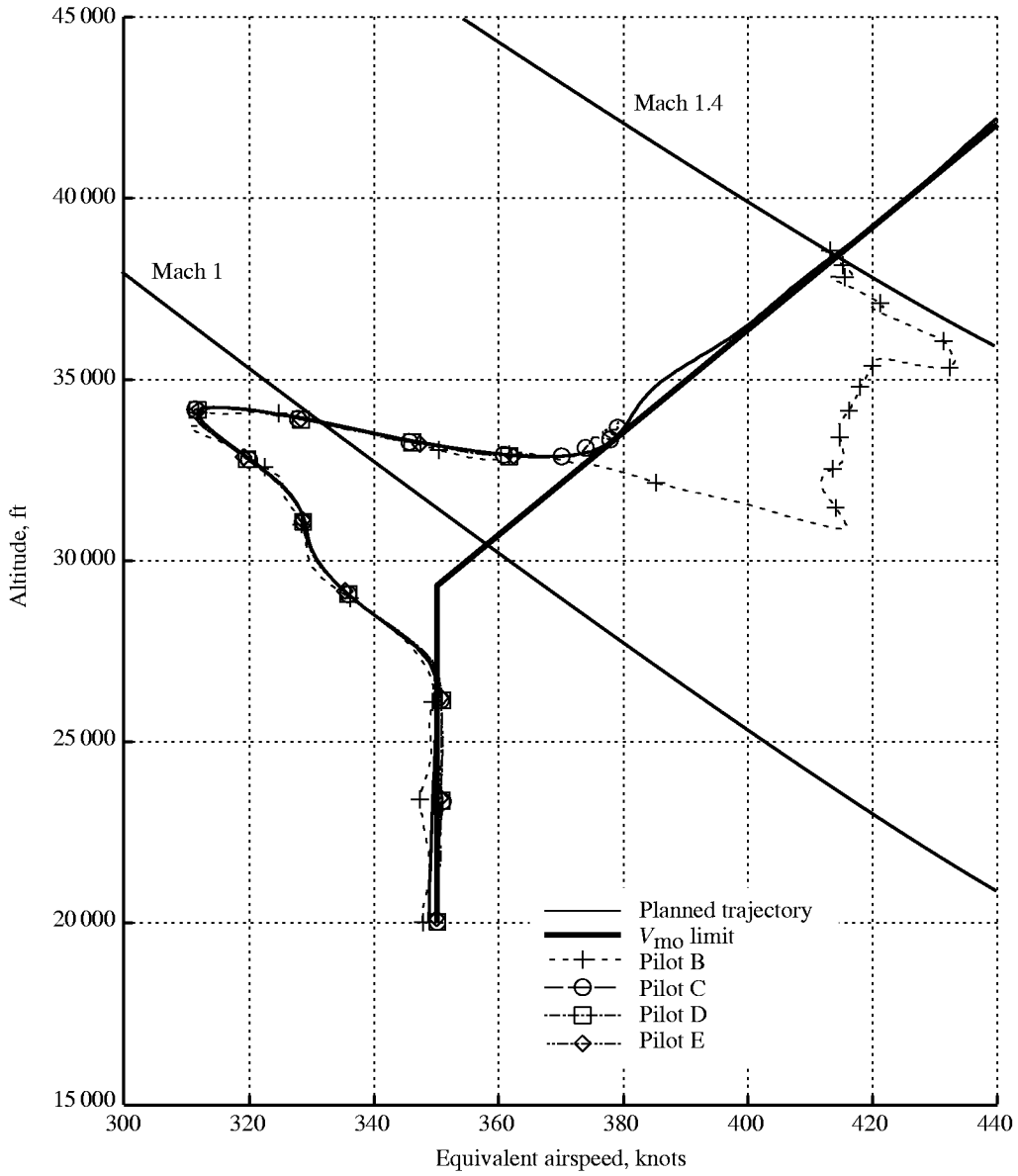

(b) Expanded view around supersonic pushover region.

Figure 64. Concluded.

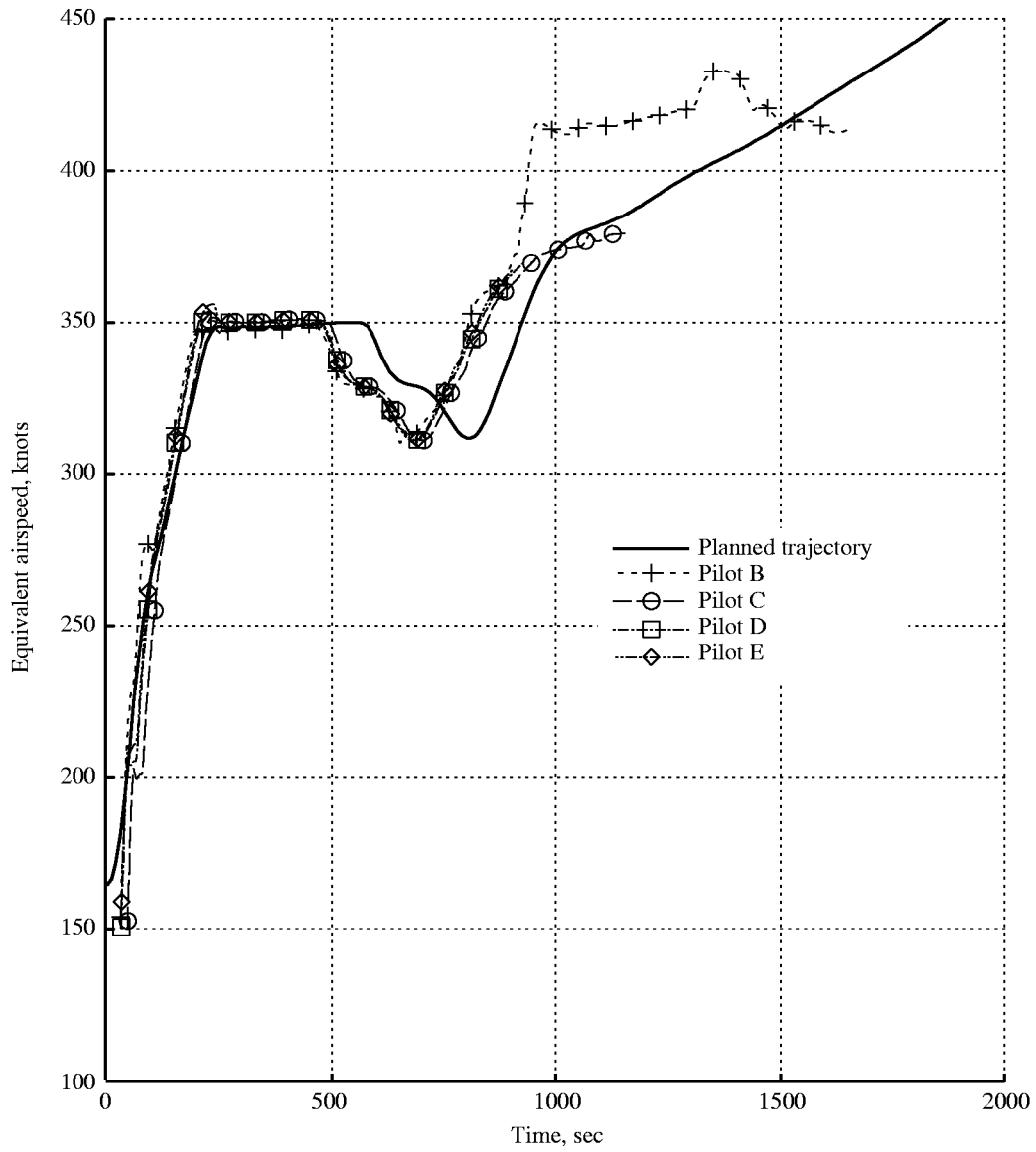

Figure 65. Time histories for equivalent airspeed for profile climb (task 3030).

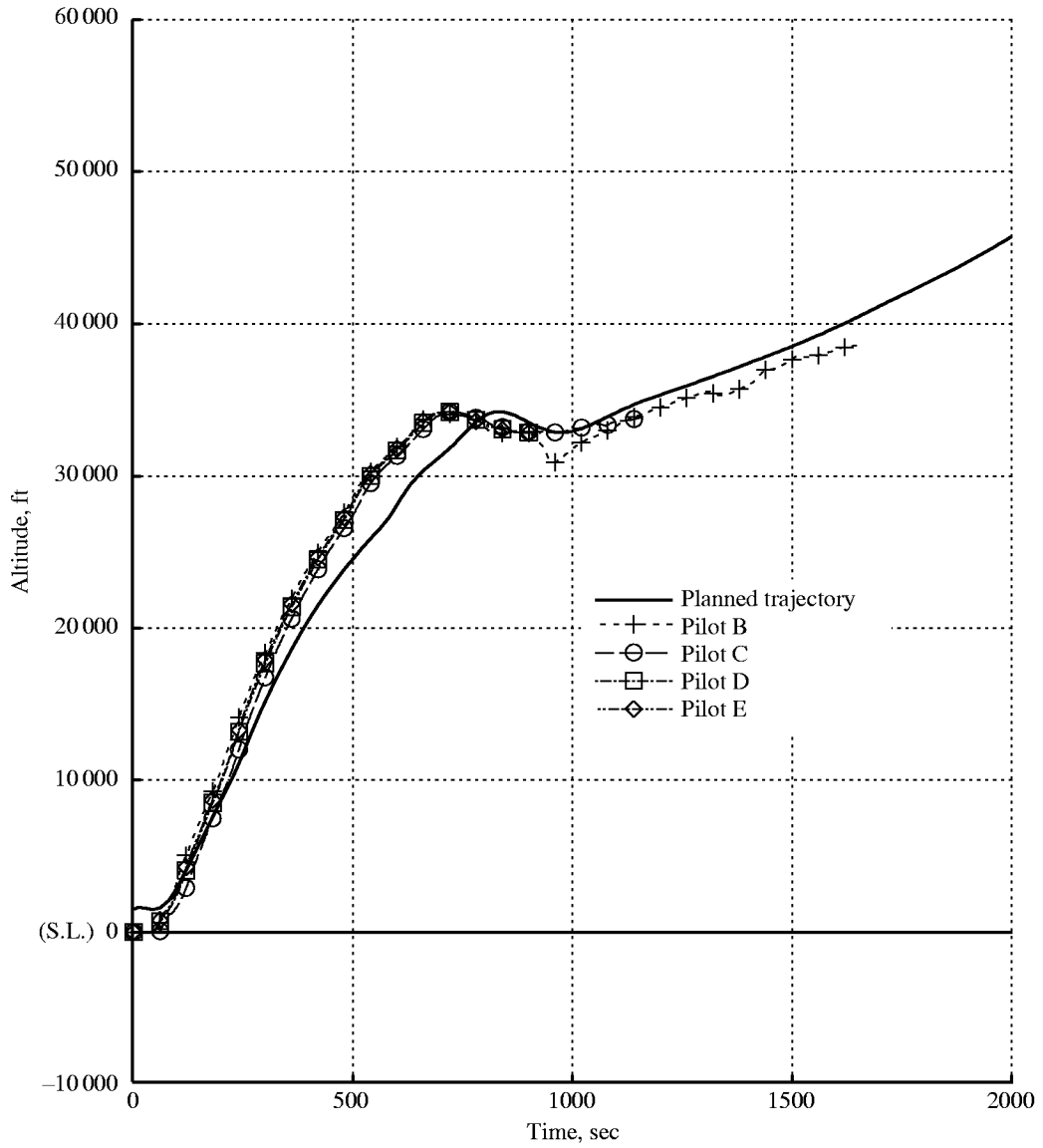

Figure 66. Time histories for altitude for profile climb (task 3030).

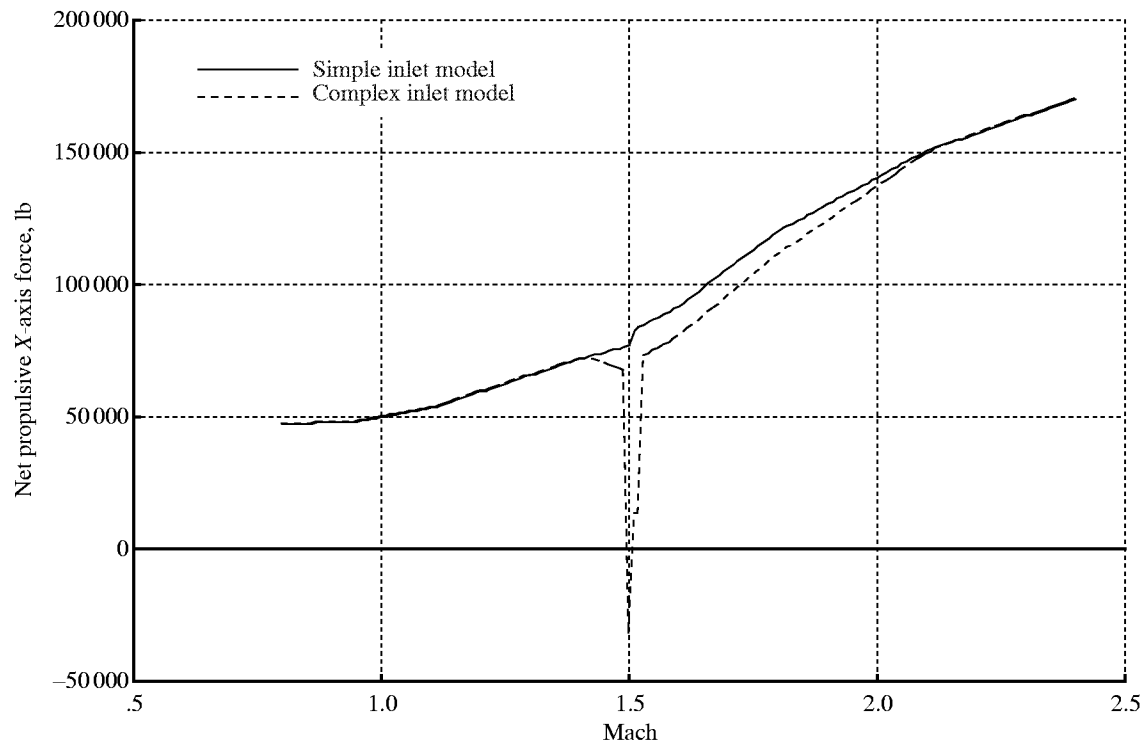
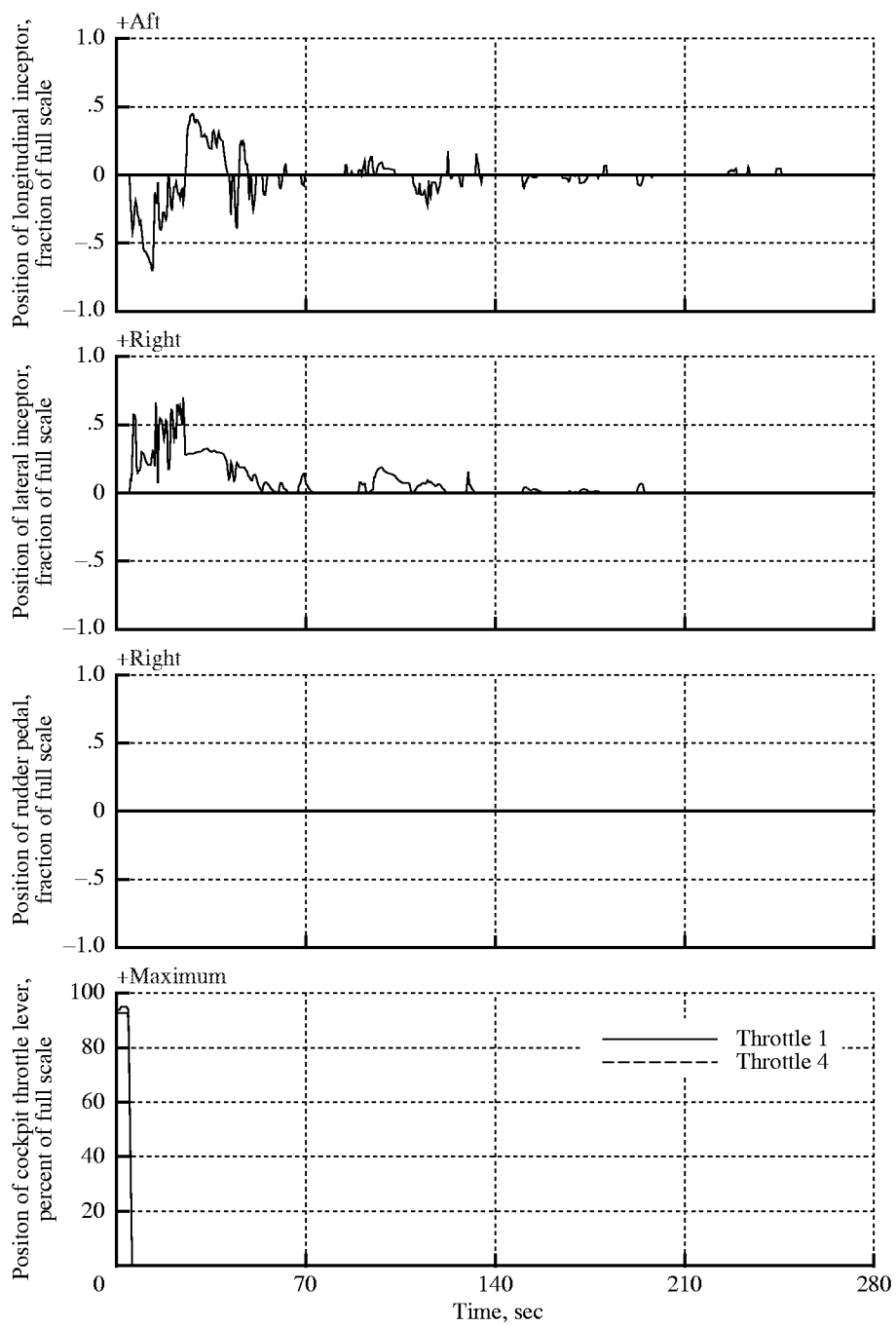
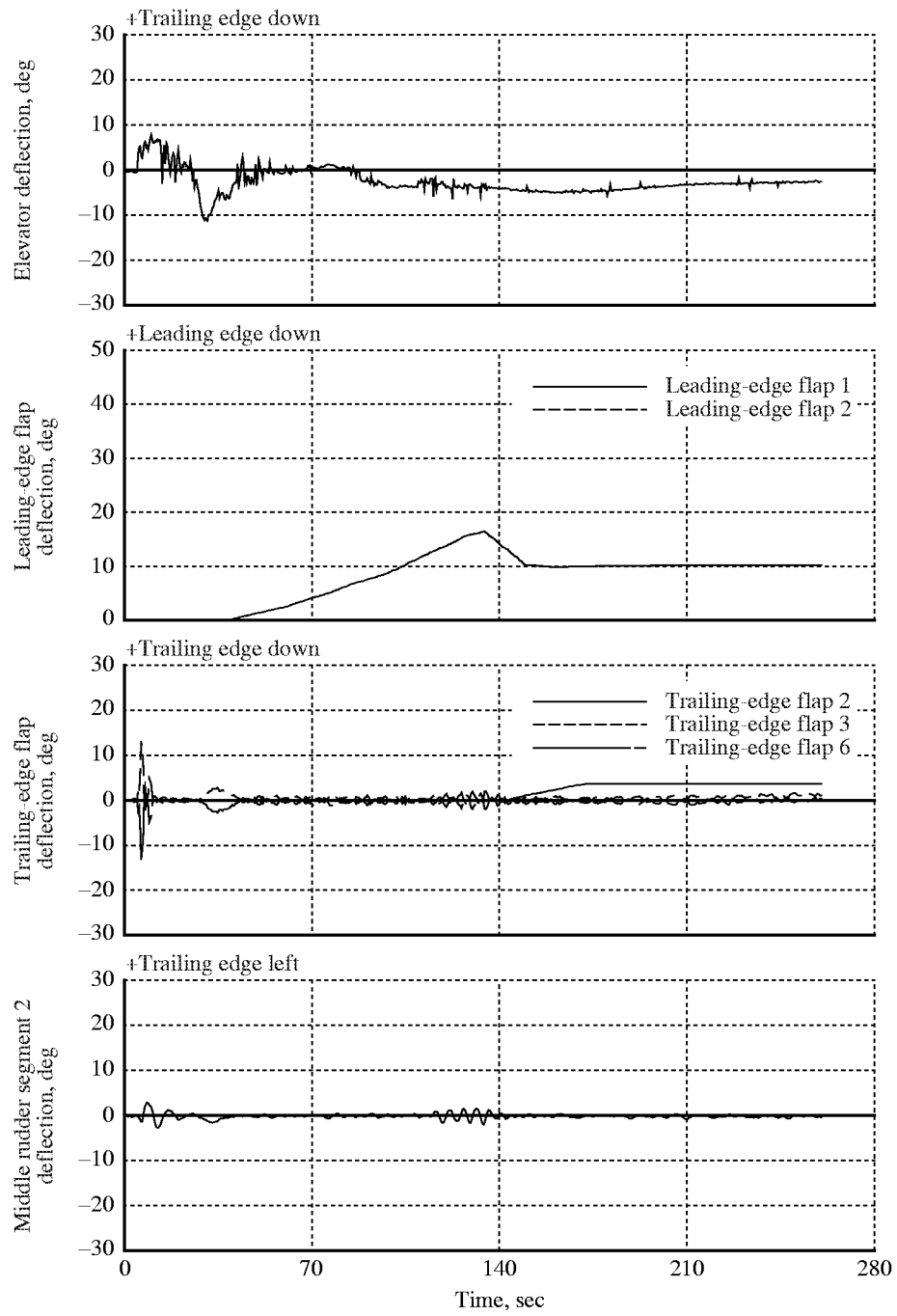

Figure 67. Net propulsive body X-axis force at constant altitude (40371 ft) for $\alpha = 4^\circ$ as function of Mach. Throttles 100 percent.



(a) Pilot controls.

Figure 68. Typical time histories for emergency descent (task 5070).



(b) Deflection of elevator; leading-edge flap segments 1 and 2; trailing-edge flap segments 2, 3, and 6; and middle rudder segment 2.

Figure 68. Continued.

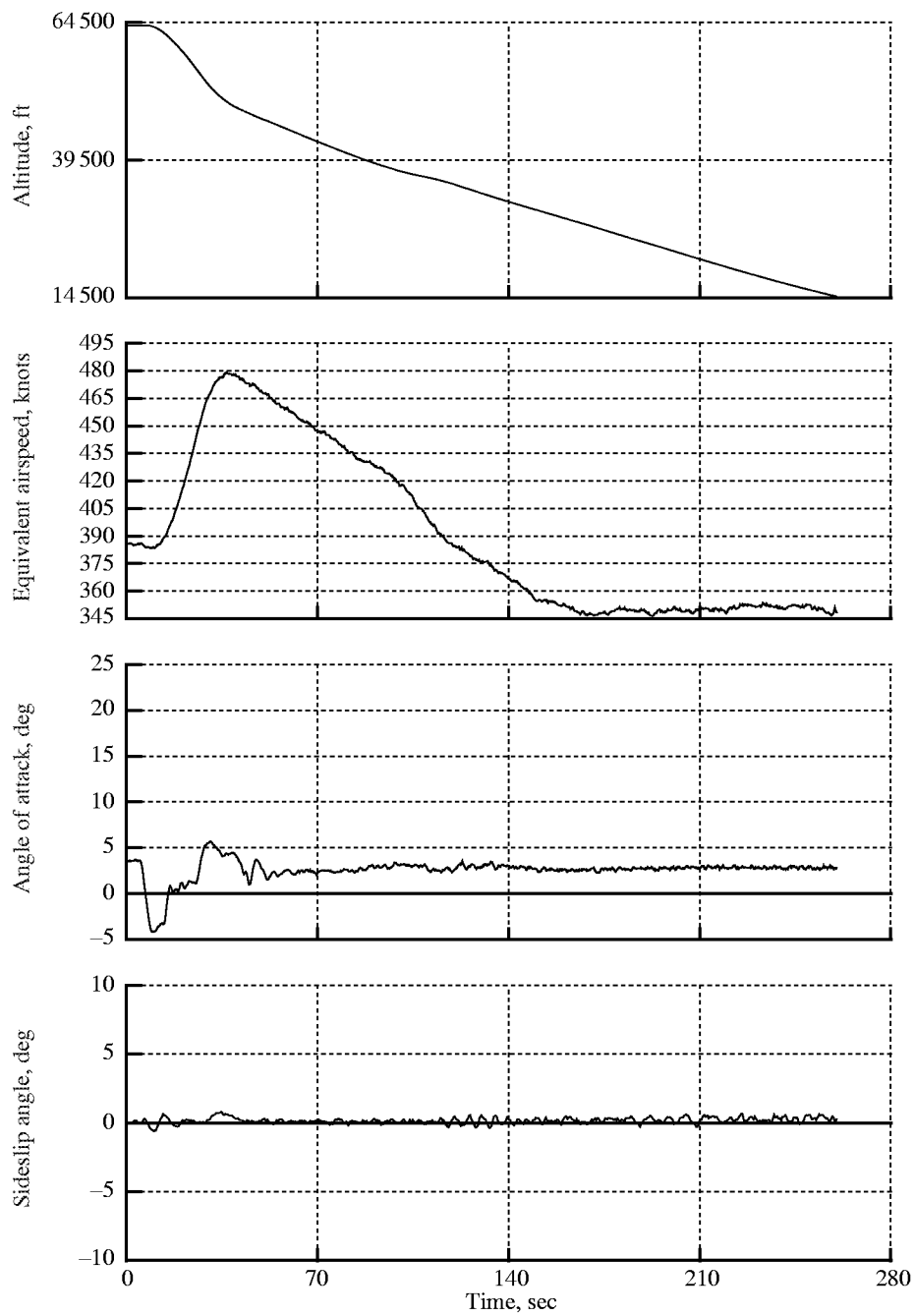

(c) Altitude, equivalent airspeed, angle of attack, and sideslip angle.

Figure 68. Continued.

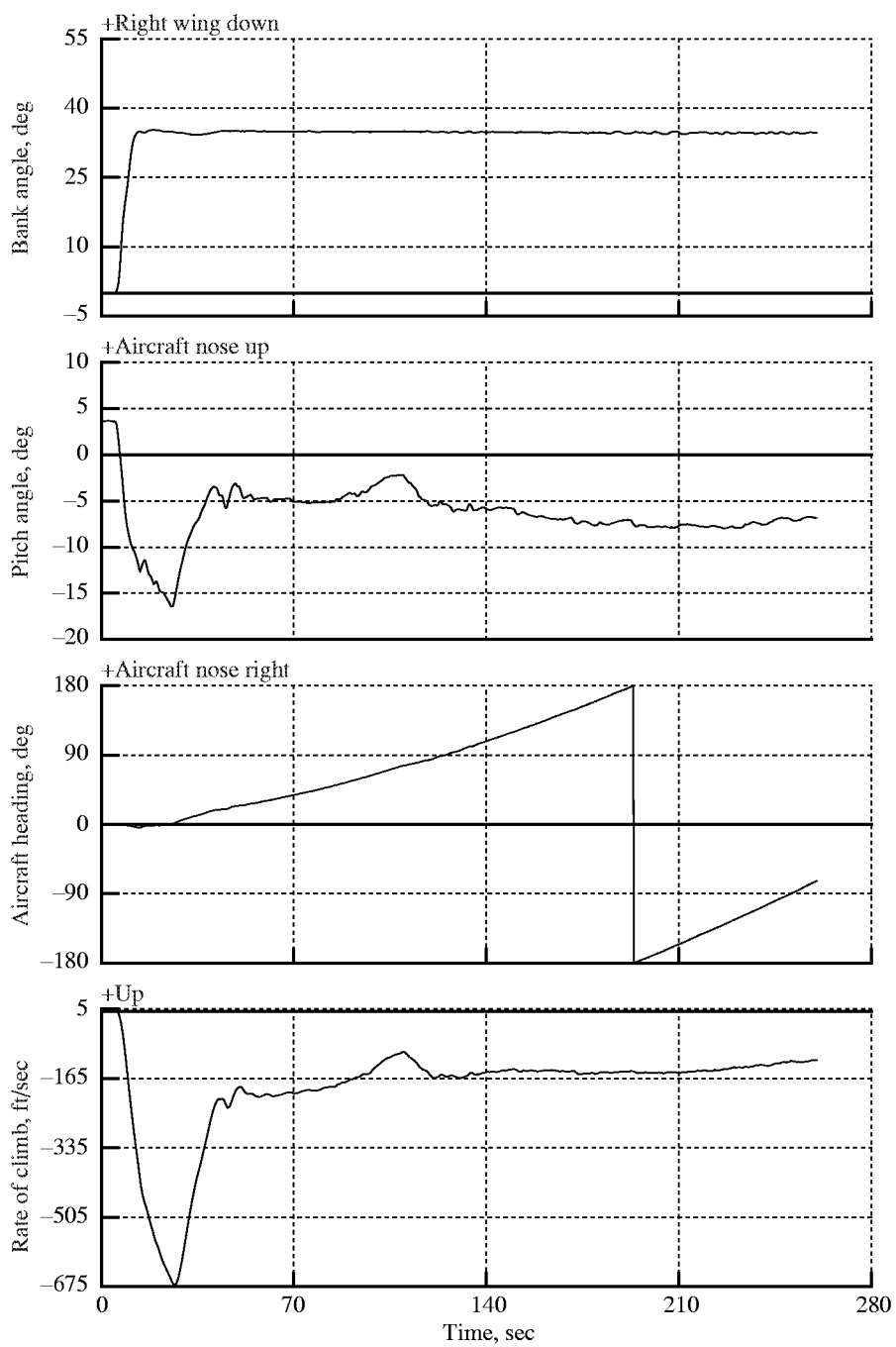

(d) Euler angles and rate of climb.

Figure 68. Continued.

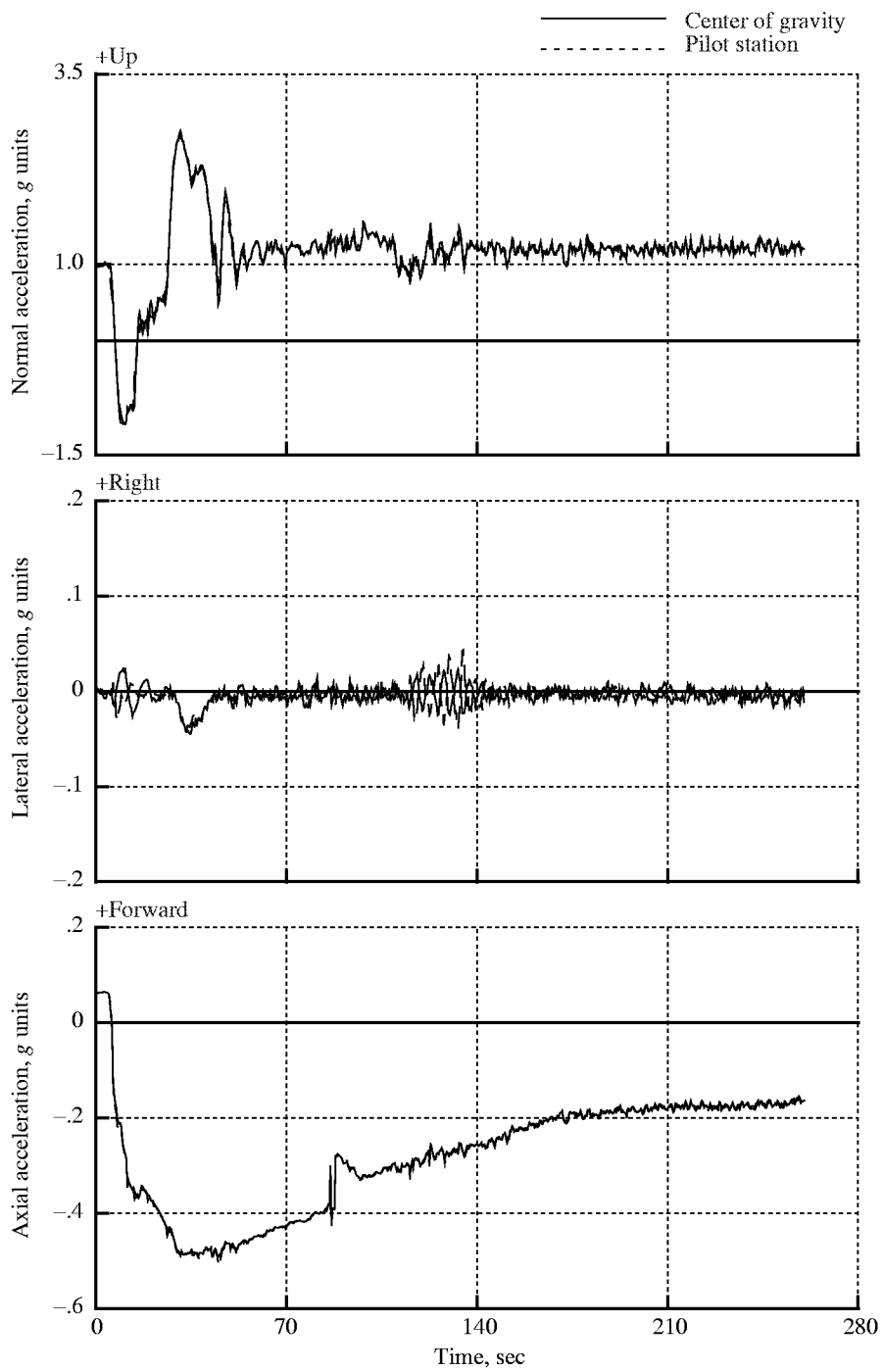

(e) Linear accelerations at center of gravity and pilot station.

Figure 68. Continued.

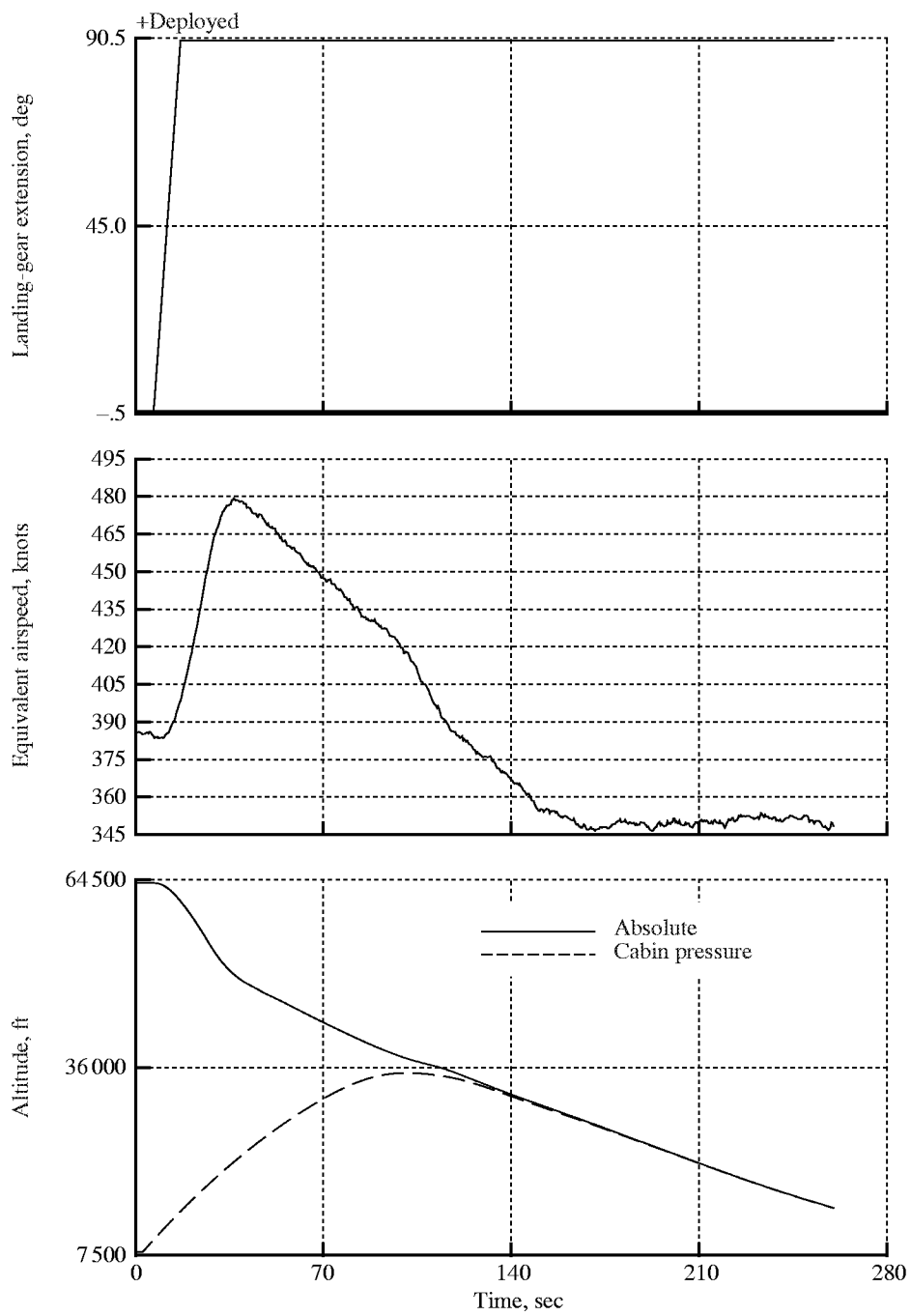

(f) Absolute altitude, cabin altitude, equivalent airspeed, and gear position.

Figure 68. Concluded.

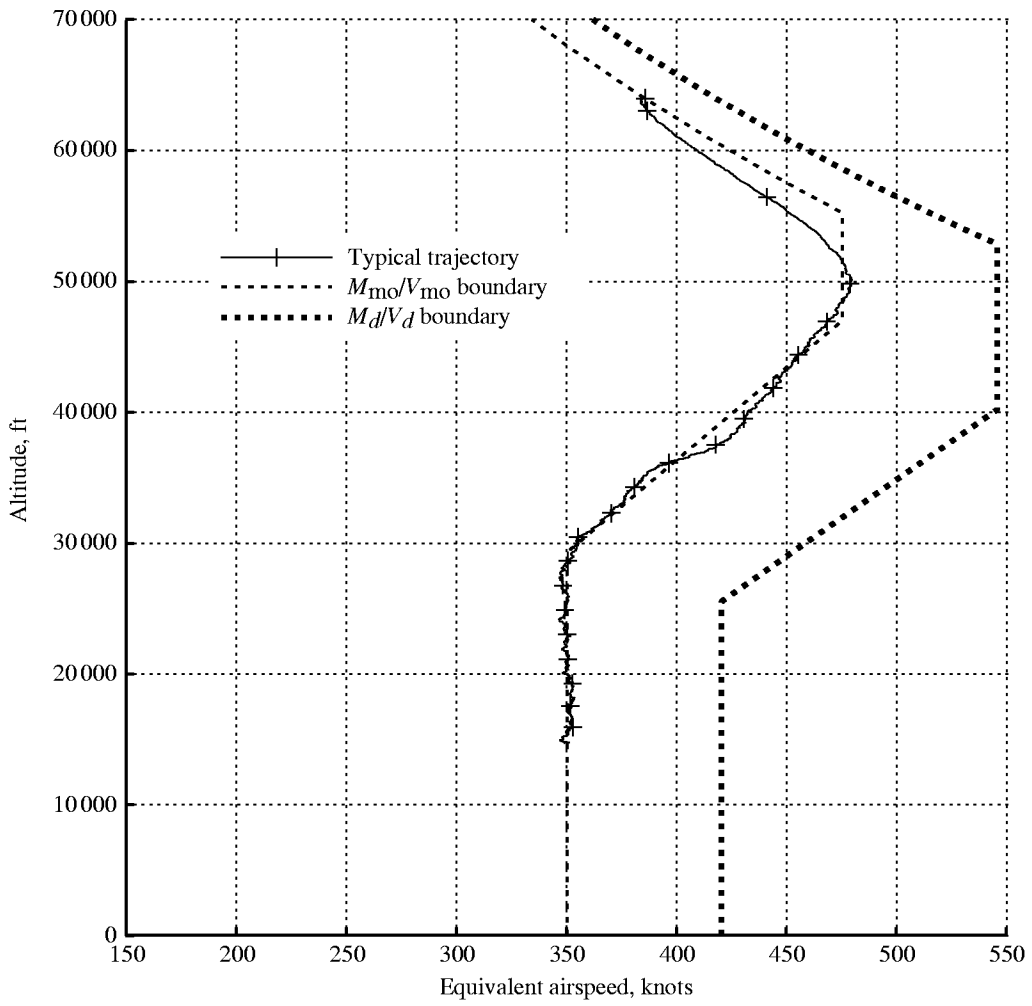
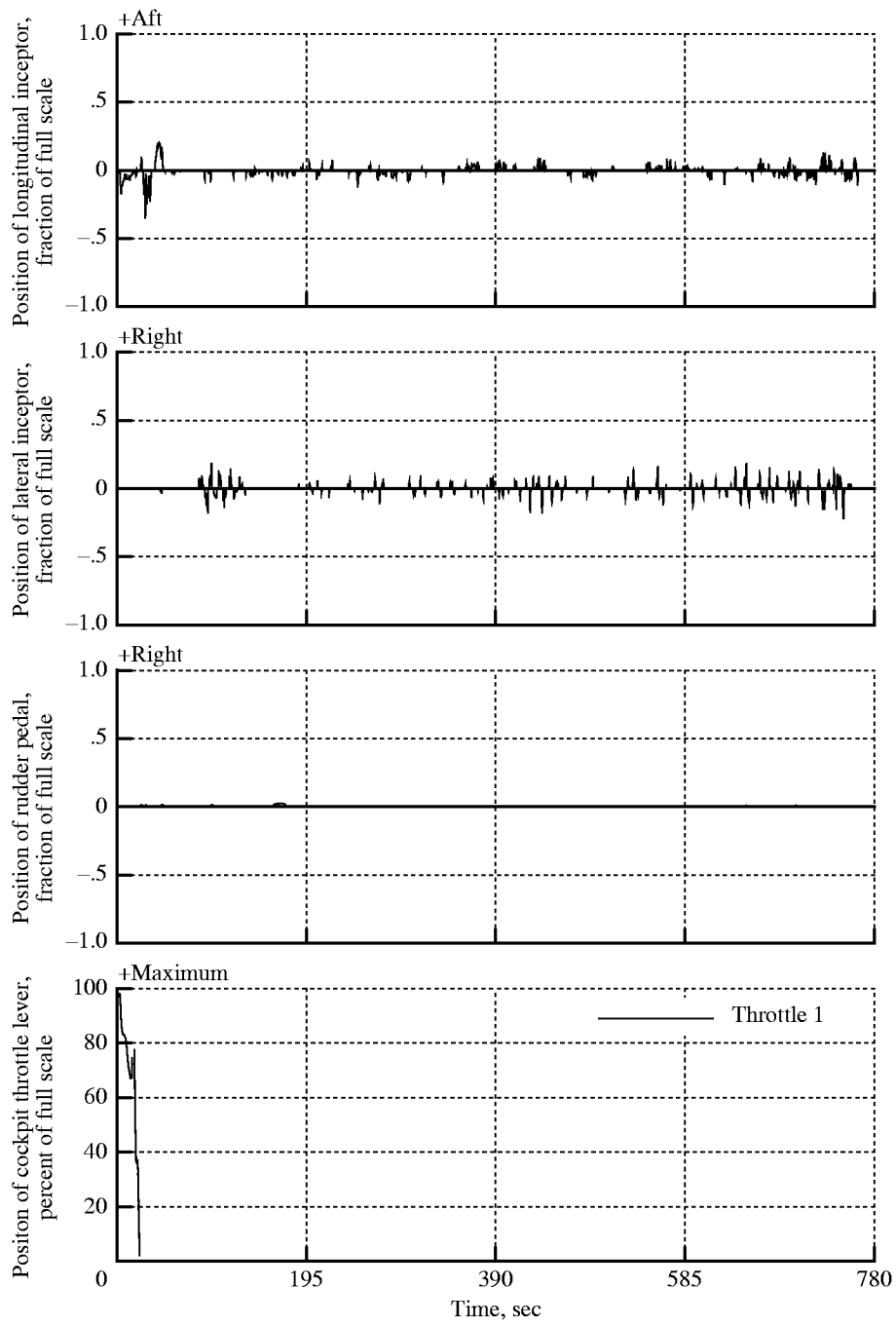
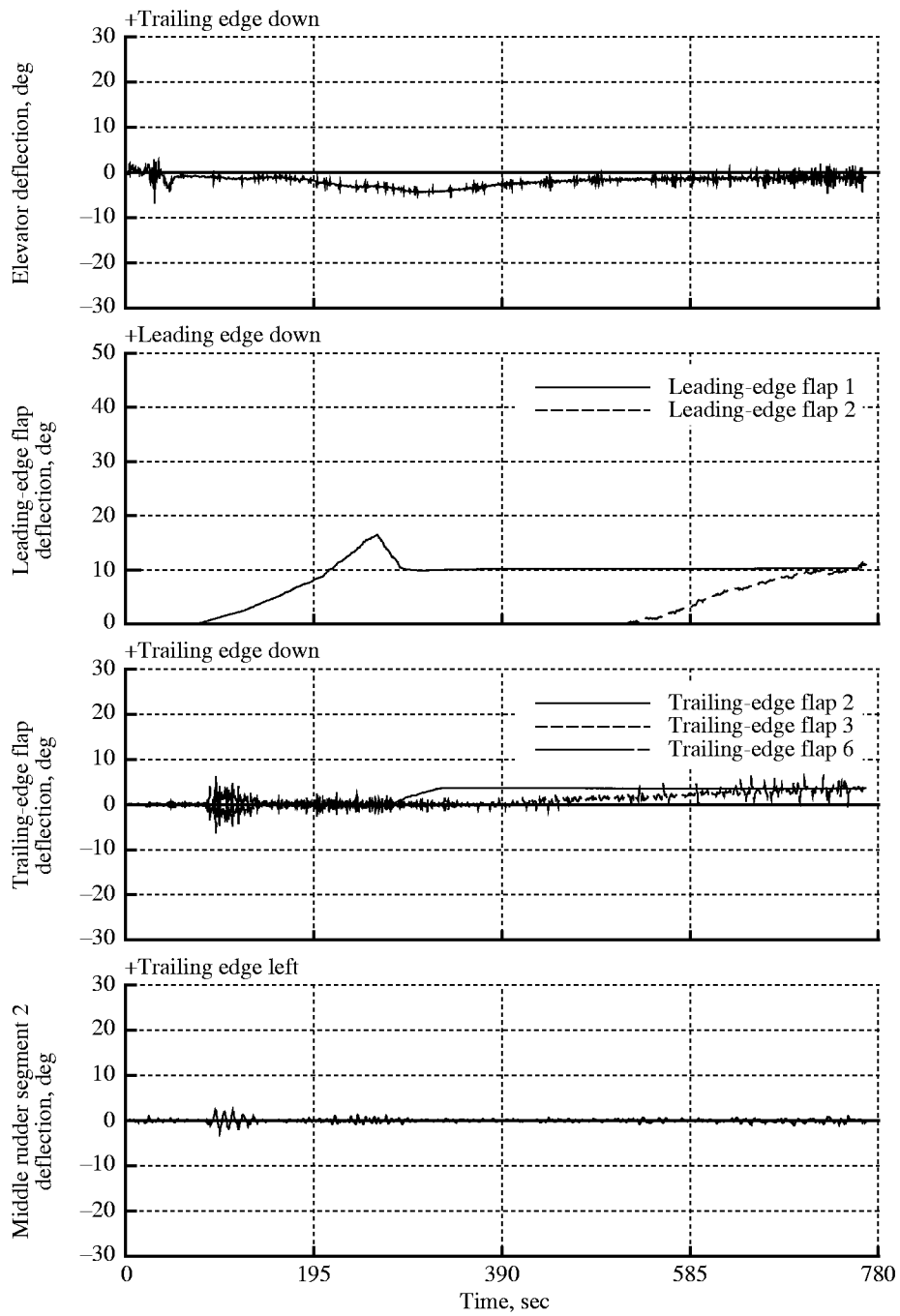

Figure 69. Typical trajectories of emergency descent (task 5070).



(a) Pilot controls.

Figure 70. Typical time histories of profile descent maneuver (task 3050).



(b) Deflection of elevator; leading-edge flap segments 1 and 2; trailing-edge flap segments 2, 3, and 6; and middle rudder segment 2.

Figure 70. Continued.

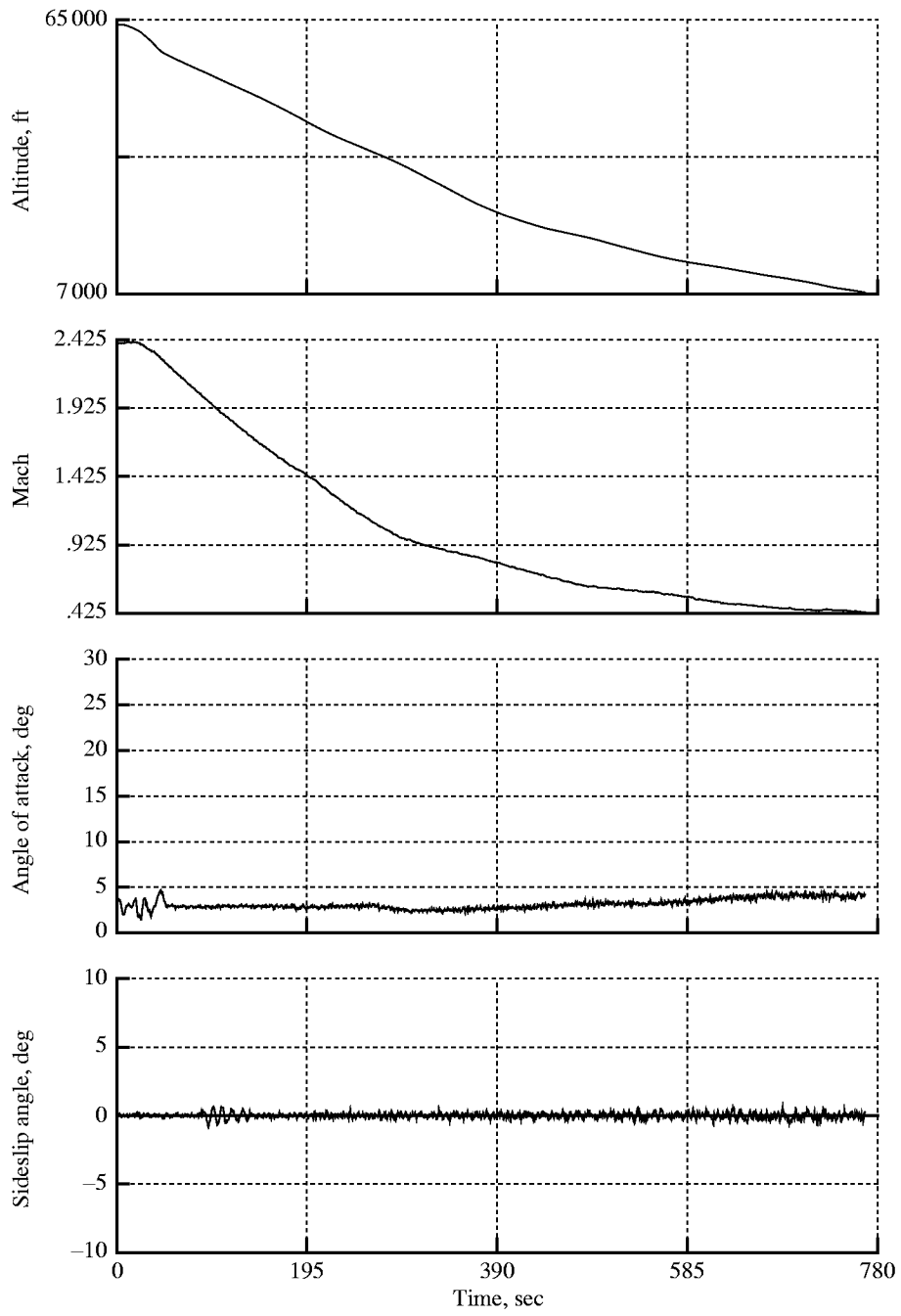

(c) Altitude, Mach, angle of attack, and sideslip angle.

Figure 70. Continued.

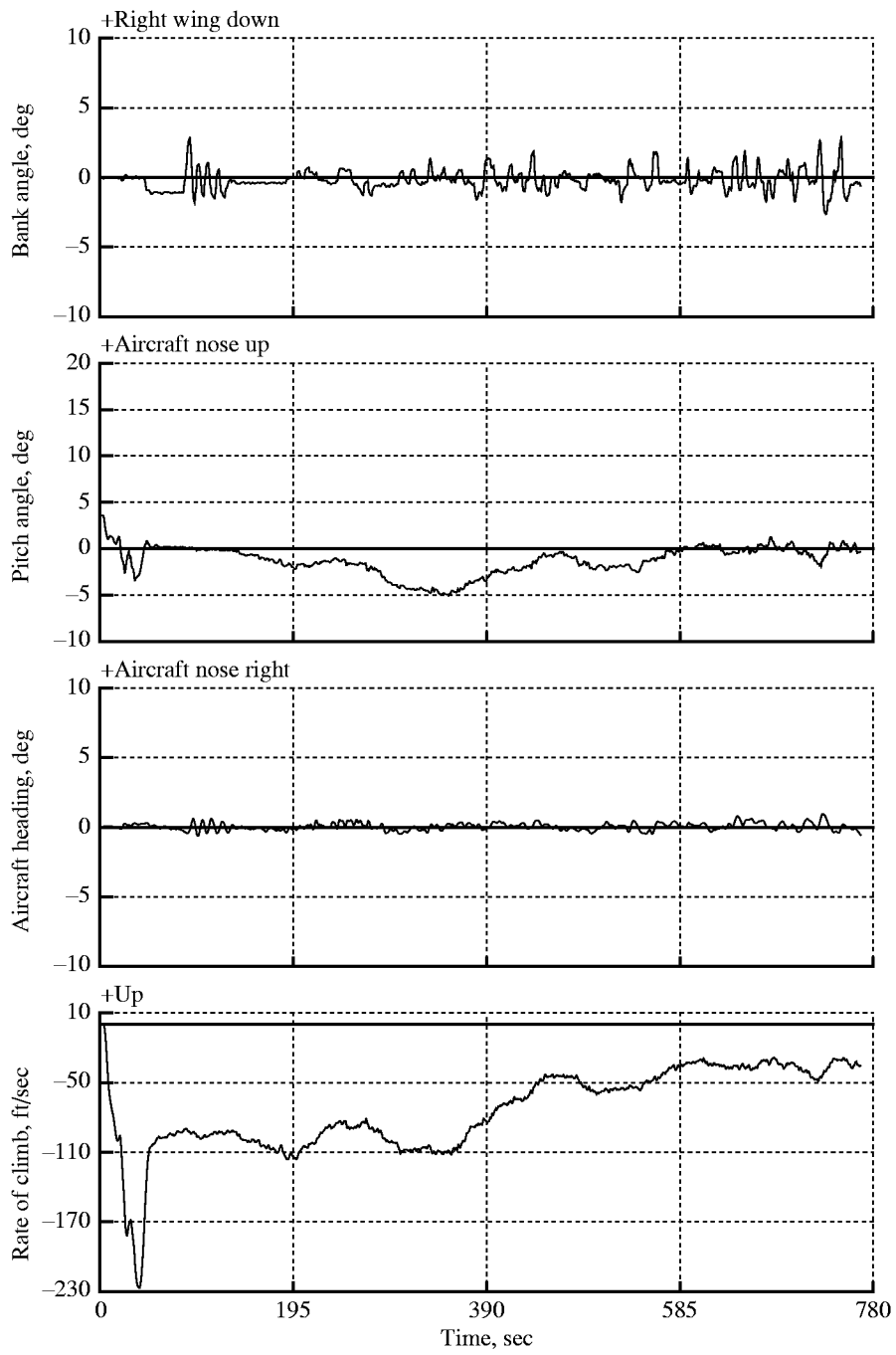

(d) Euler angles and rate of climb.

Figure 70. Continued.

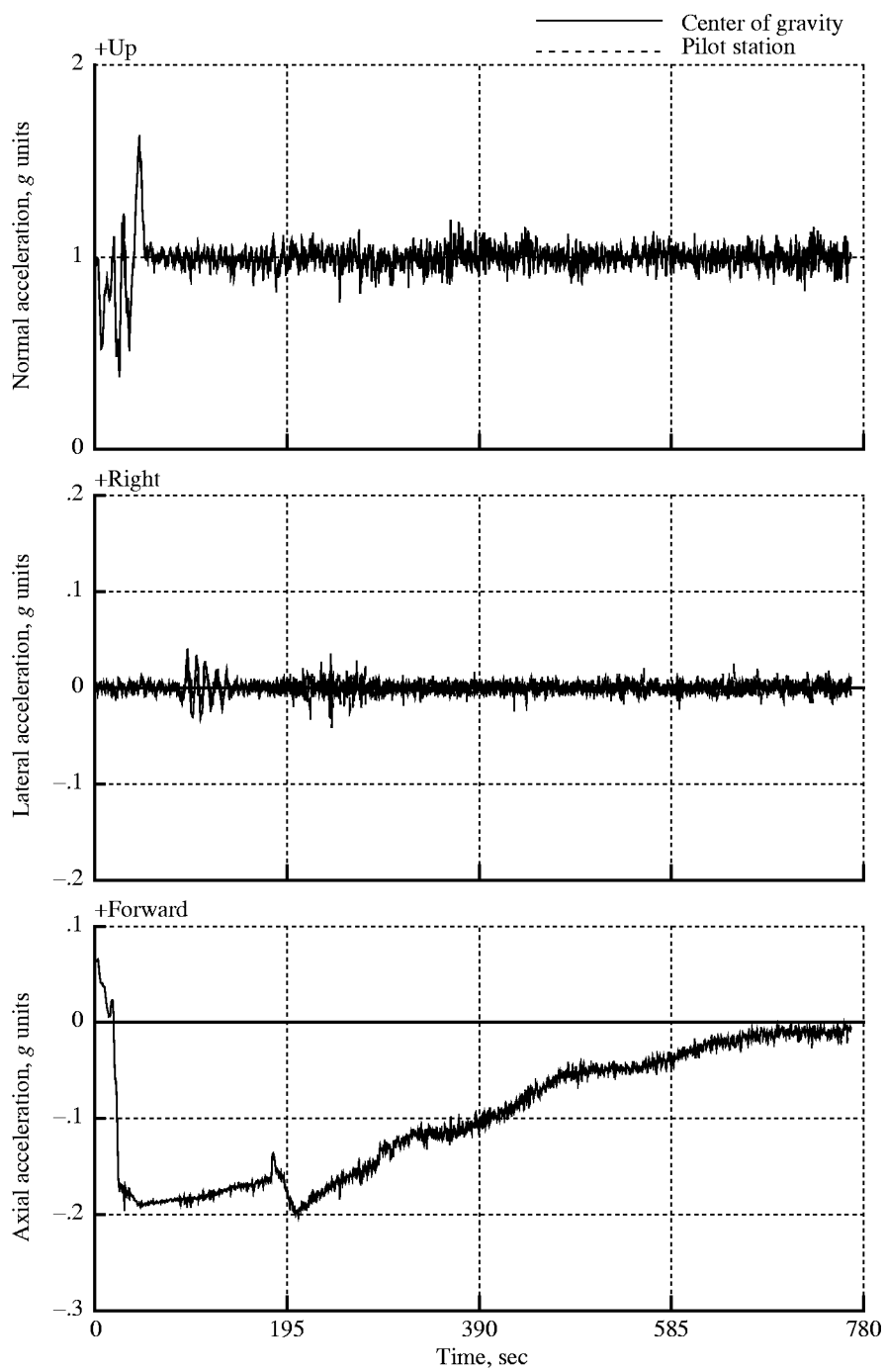

(e) Linear accelerations at center of gravity and pilot station.

Figure 70. Concluded.

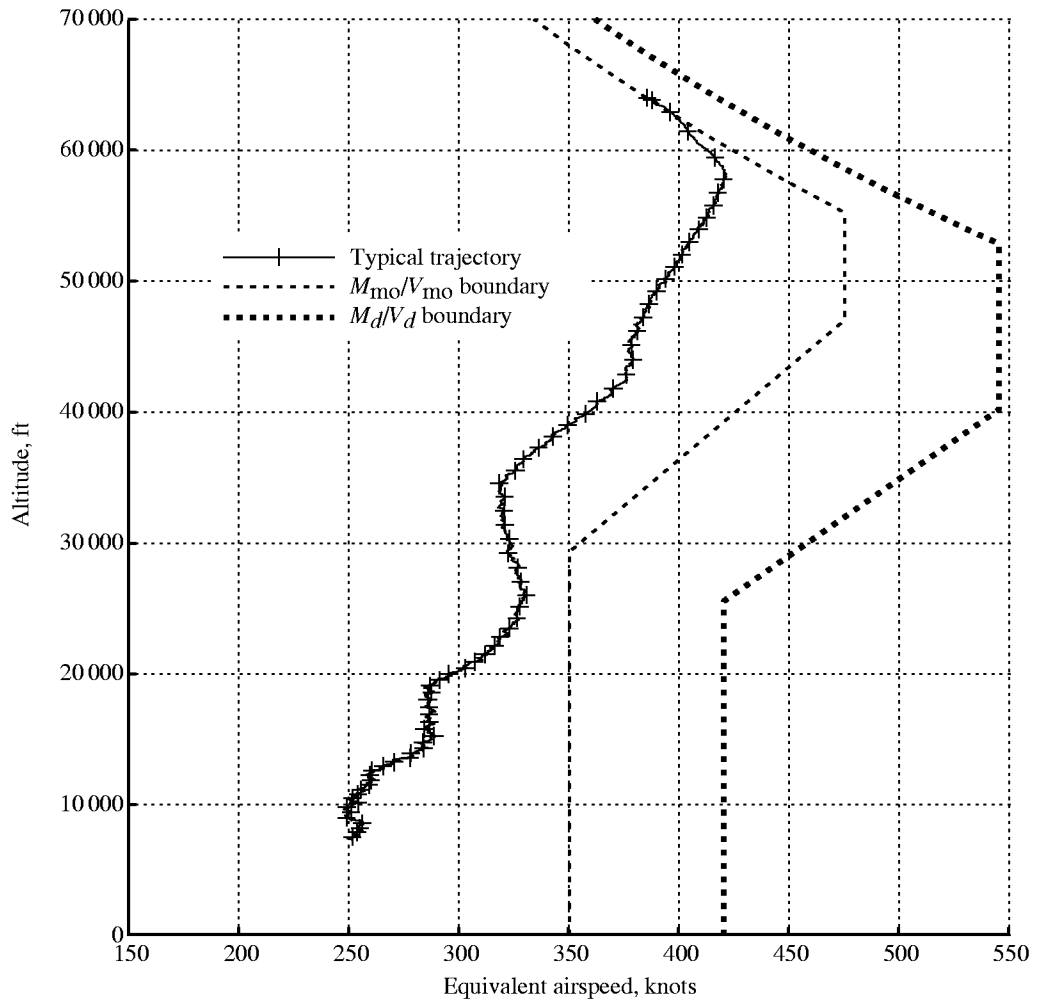
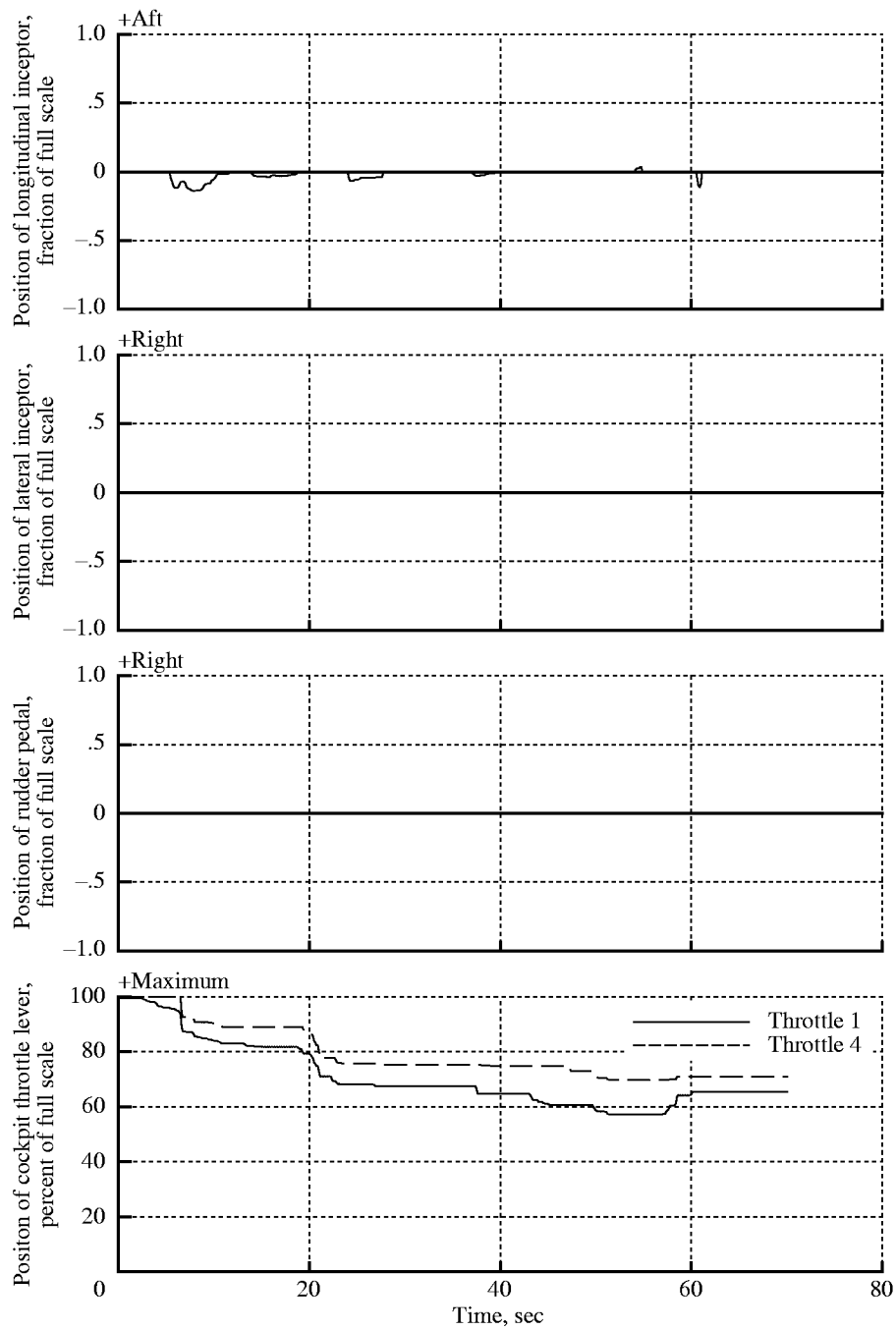
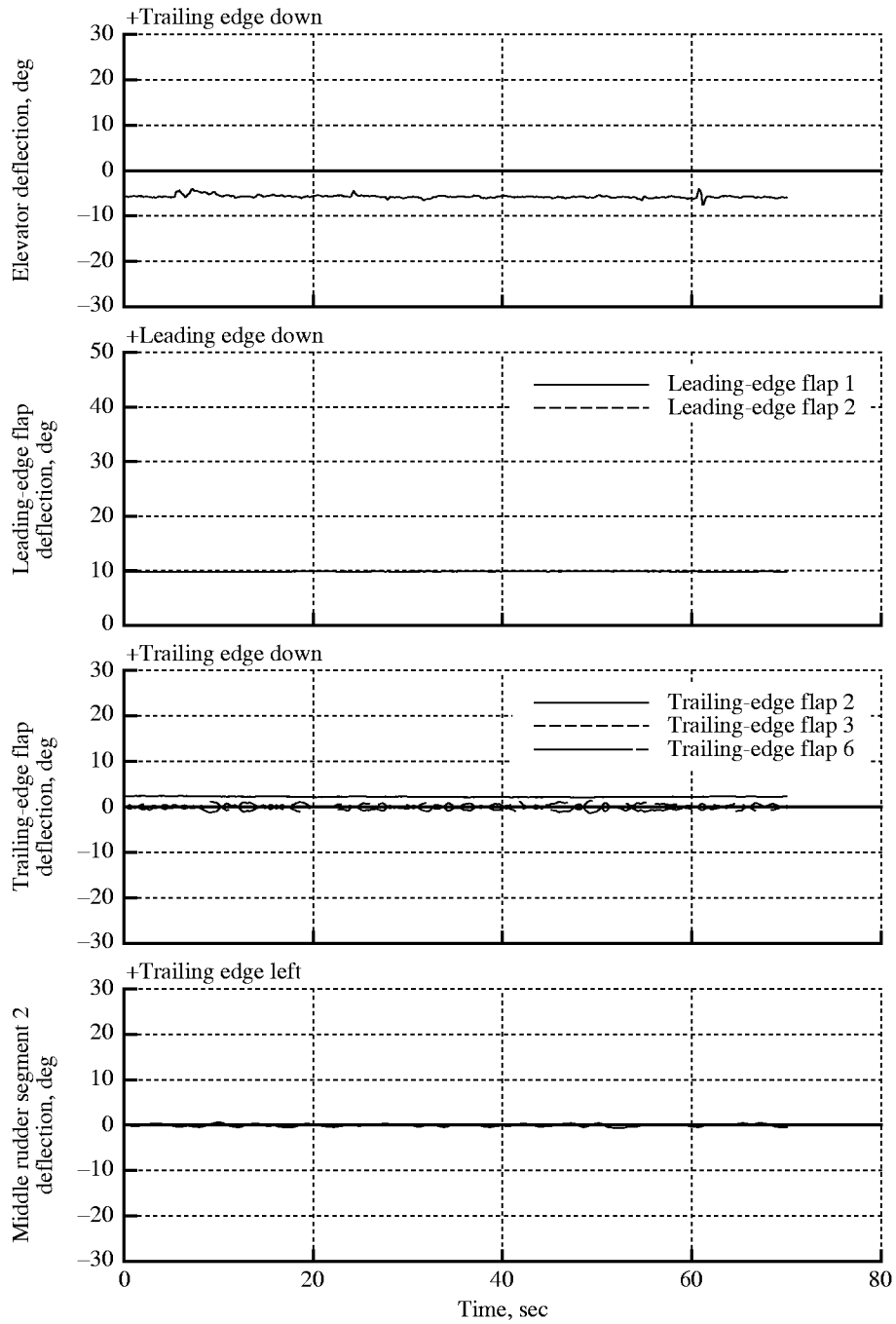

Figure 71. Typical trajectories of profile descent (task 3050).



(a) Pilot controls.

Figure 72. Typical time histories for transition from climb to subsonic cruise maneuver (task 3020).



(b) Deflection of elevator; leading-edge flap segments 1 and 2; trailing-edge flap segments 2, 3, and 6; and middle rudder segment 2.

Figure 72. Continued.

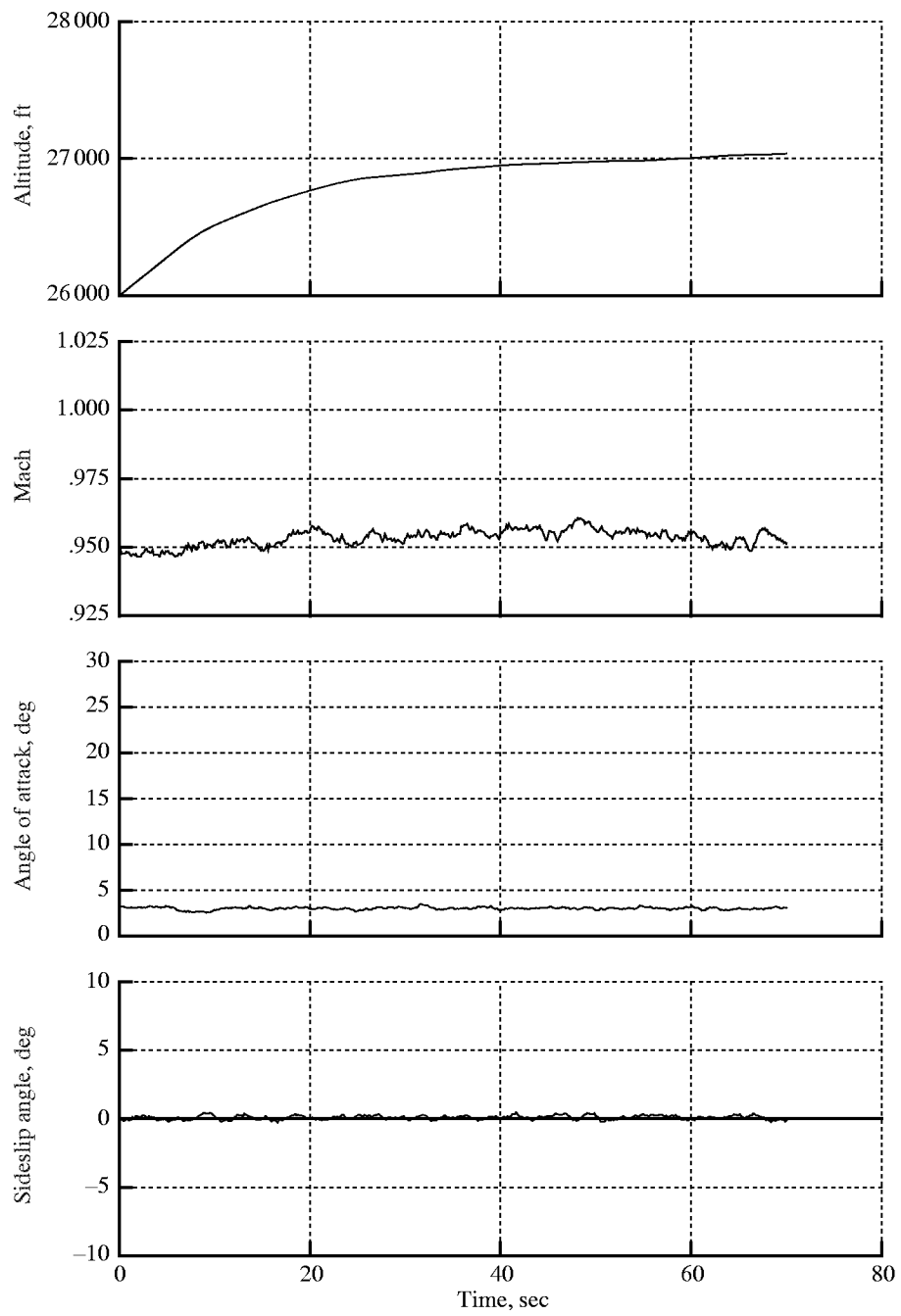

(c) Altitude, Mach, angle of attack, and sideslip angle.

Figure 72. Continued.

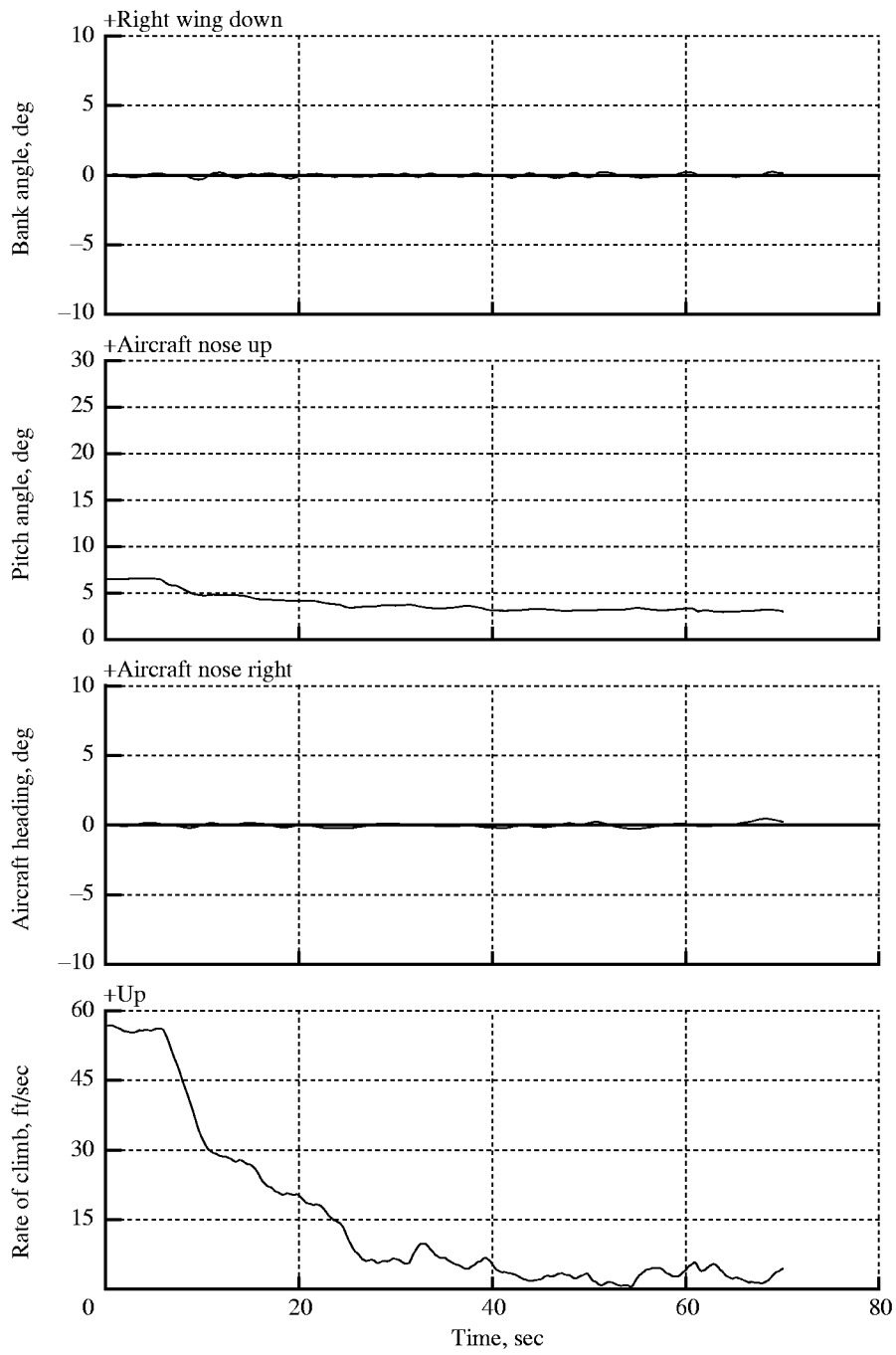

(d) Euler angles and rate of climb.

Figure 72. Continued.

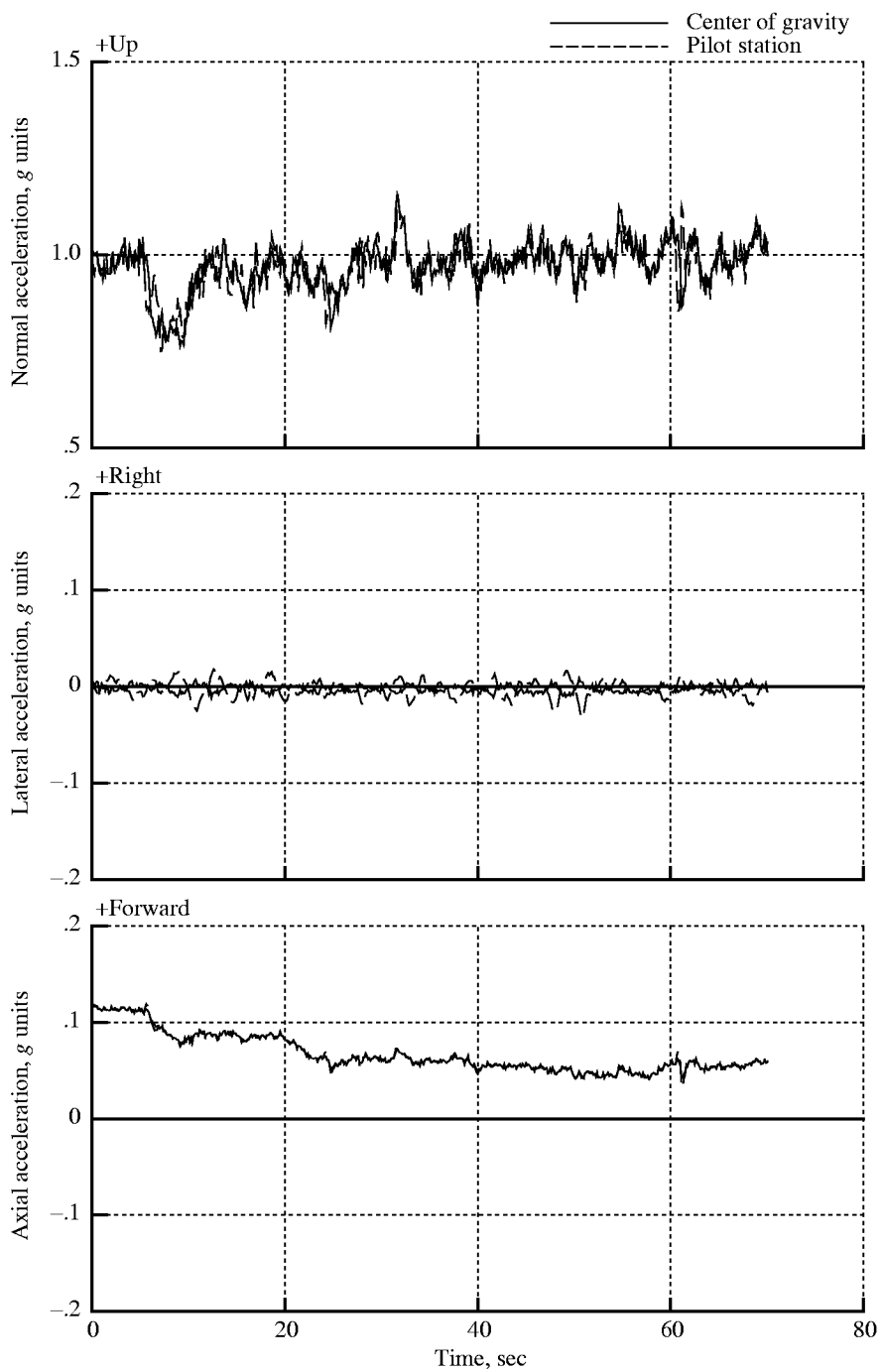

(e) Linear accelerations at center of gravity and pilot station.

Figure 72. Concluded.

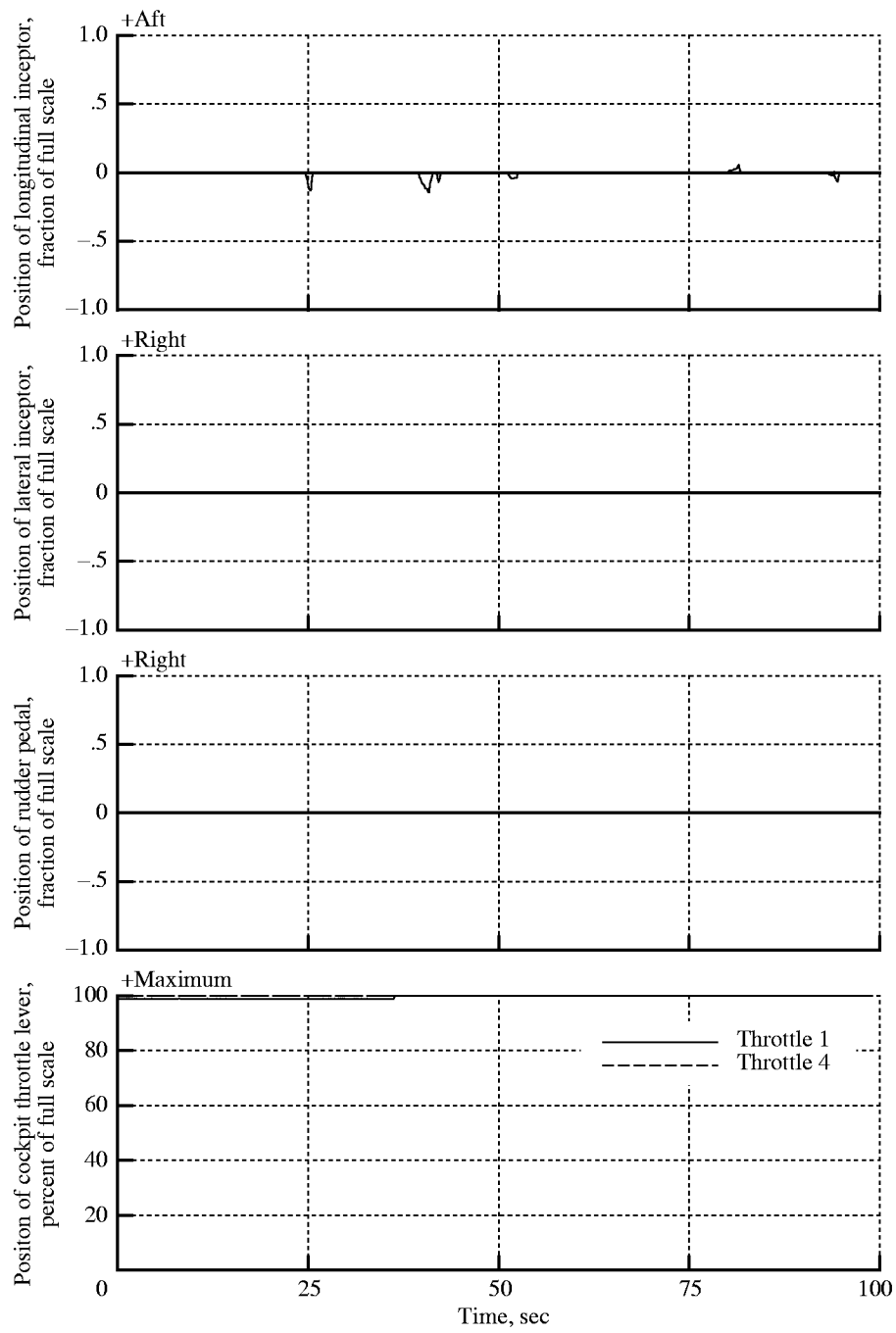

(a) Pilot controls.

Figure 73. Typical time histories for transition from climb to supersonic cruise maneuver (task 3022).

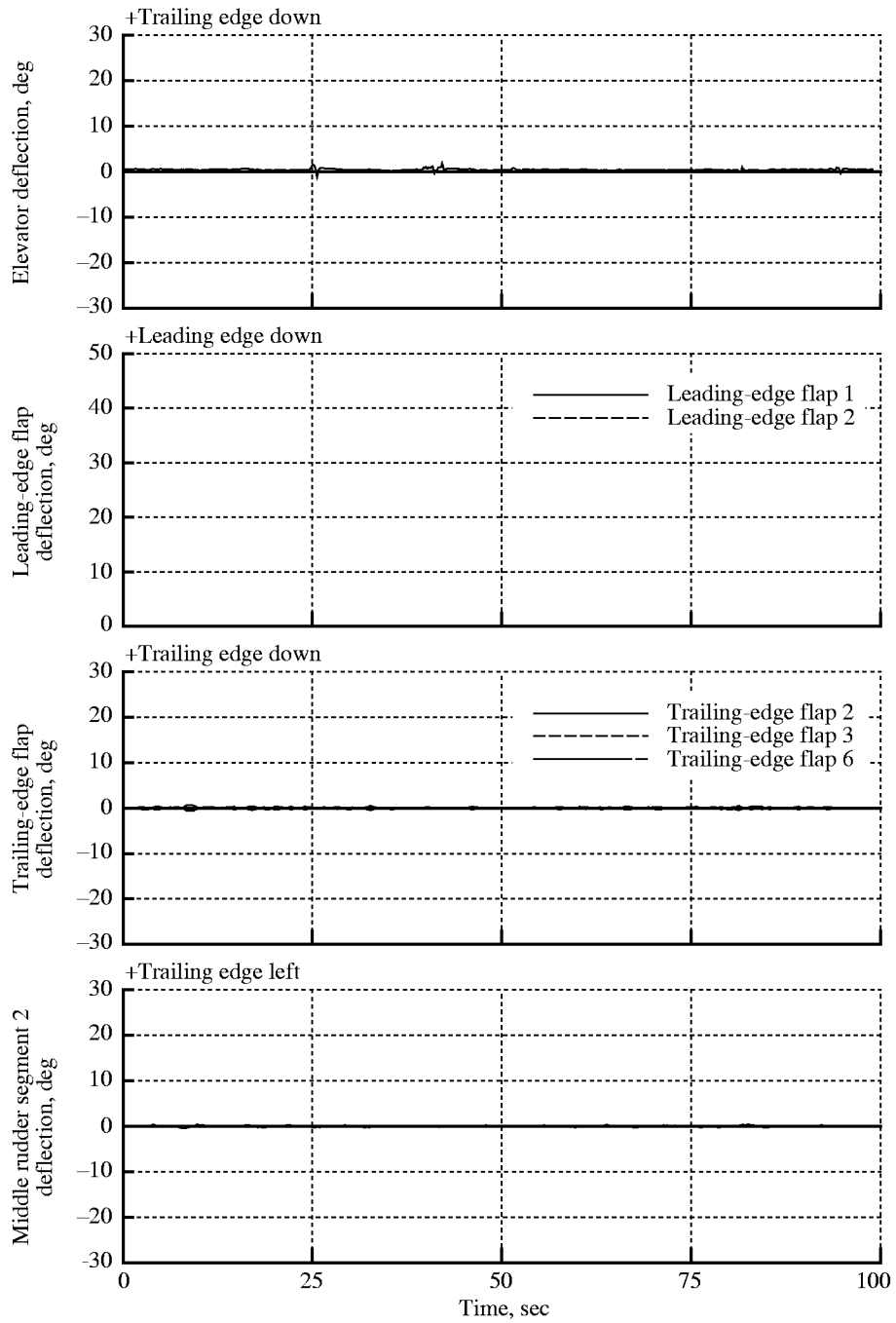

(b) Deflection of elevator; leading-edge flap segments 1 and 2; trailing-edge flap segments 2, 3, and 6; and middle rudder segment 2.

Figure 73. Continued.

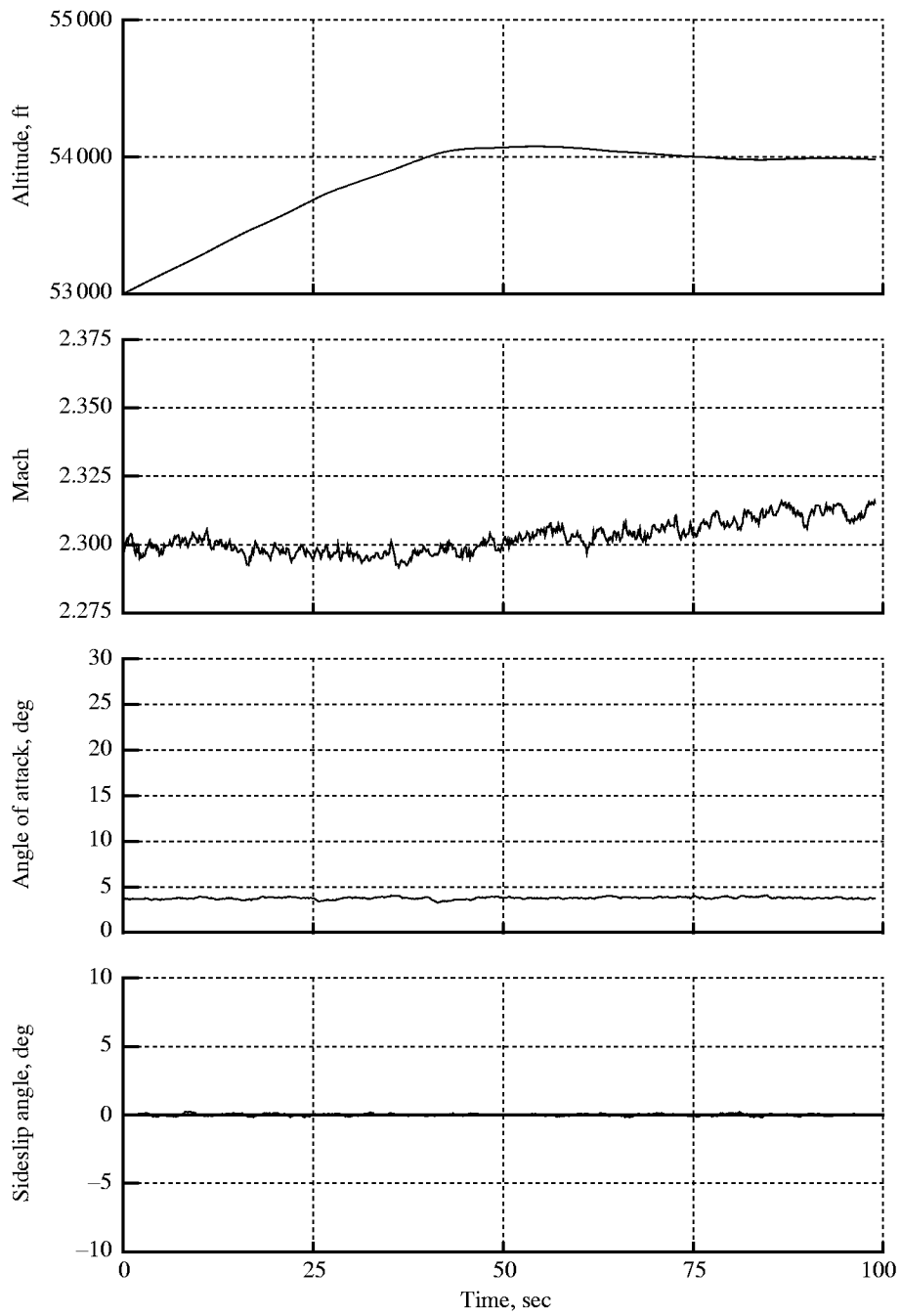

(c) Altitude, Mach, angle of attack, and sideslip angle.

Figure 73. Continued.

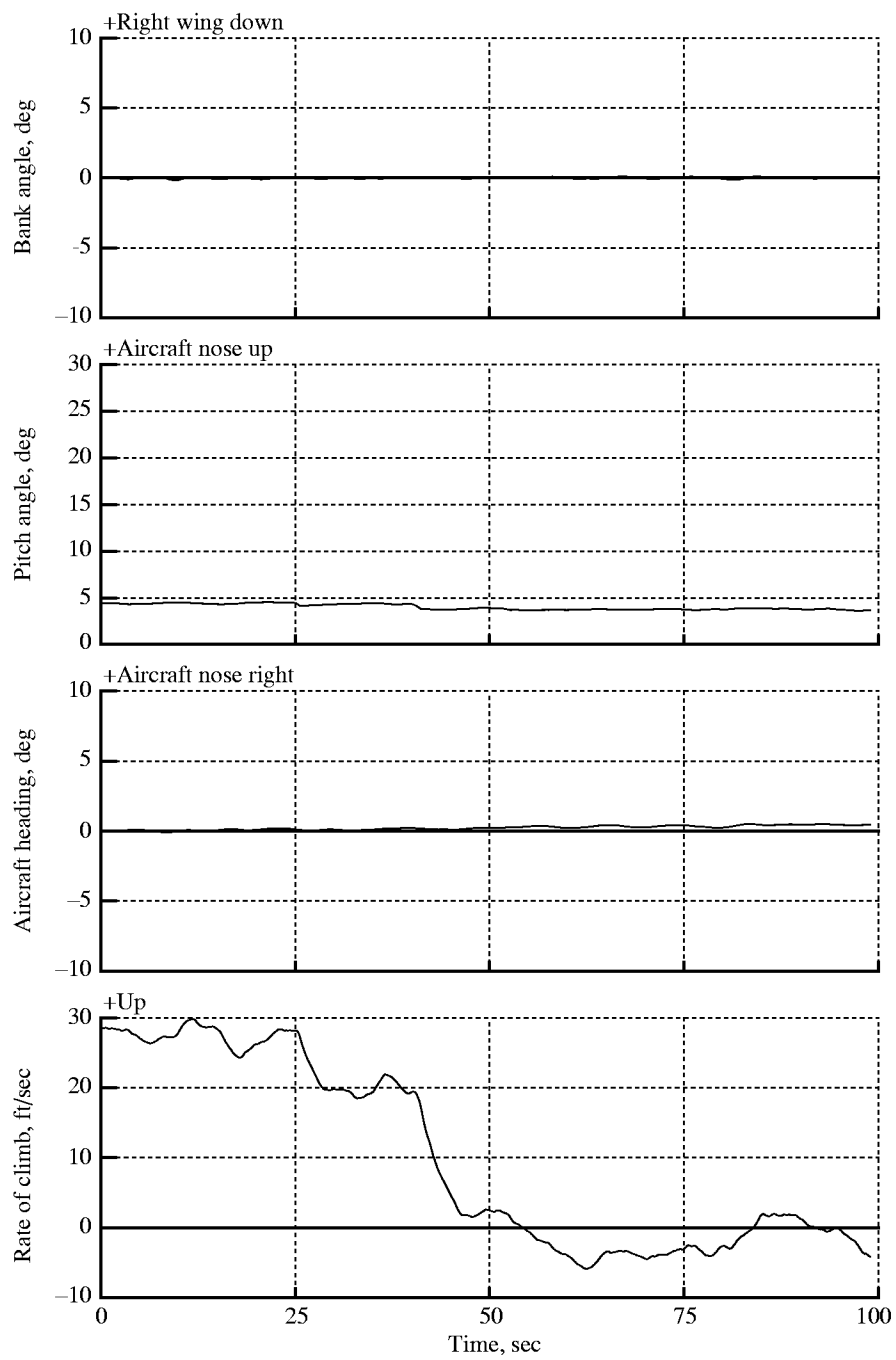

(d) Euler angles and rate of climb.

Figure 73. Continued.

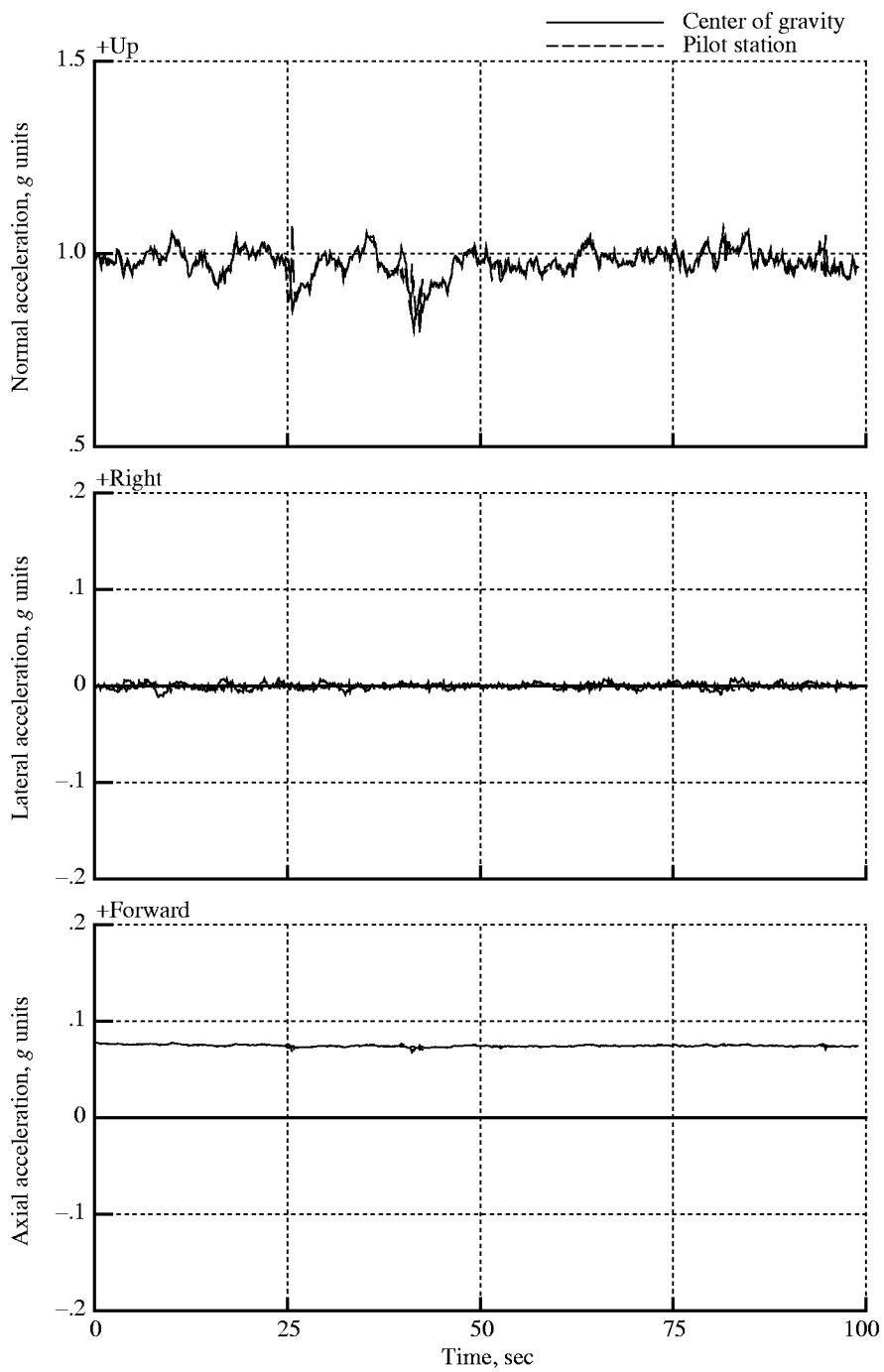

(e) Linear accelerations at center of gravity and pilot station.

Figure 73. Concluded.

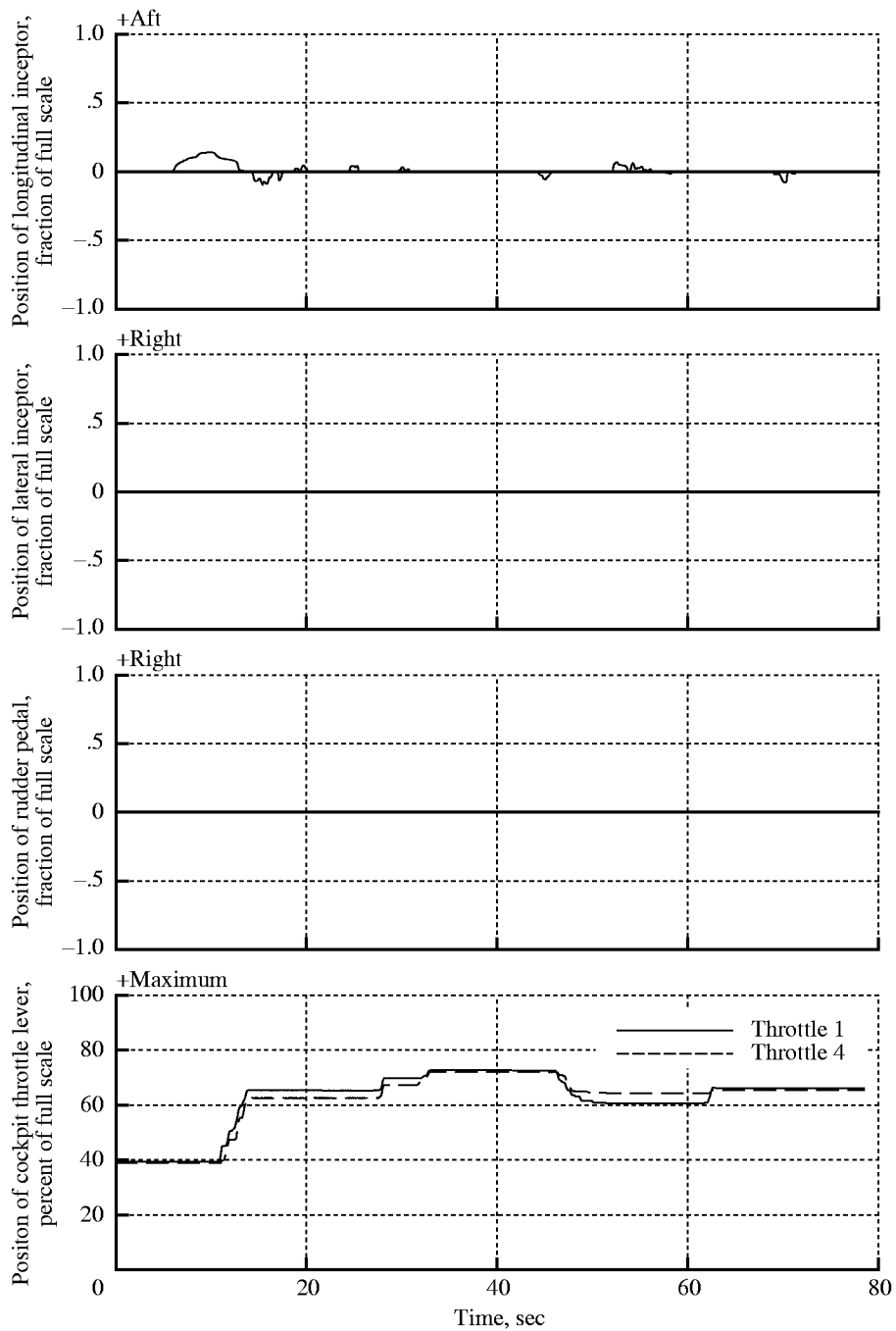

(a) Pilot controls.

Figure 74. Typical time histories for transition from subsonic cruise to climb (task 3040).

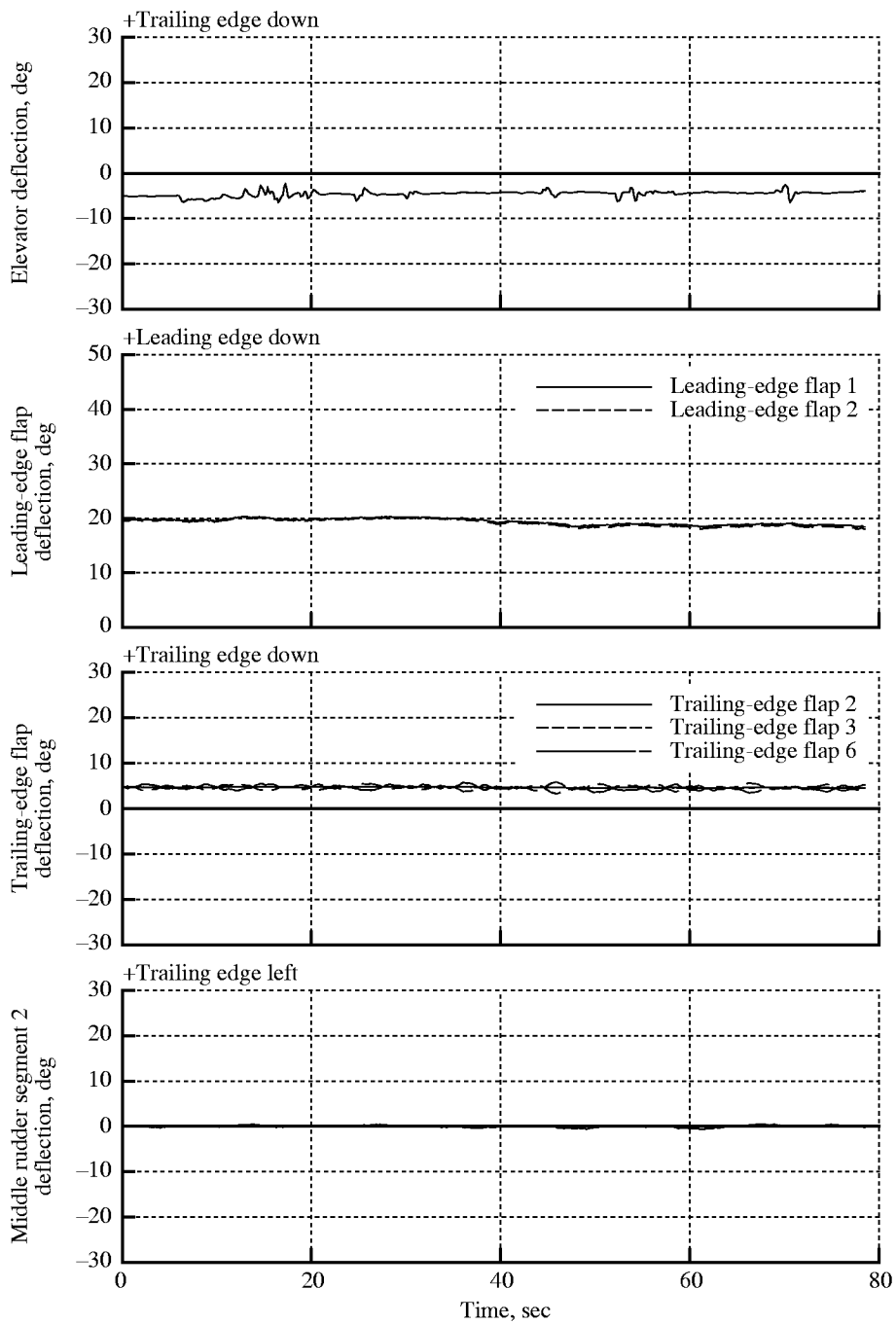

(b) Deflection of elevator; leading-edge flap segments 1 and 2; trailing-edge flap segments 2, 3, and 6; and middle rudder segment 2.

Figure 74. Continued.

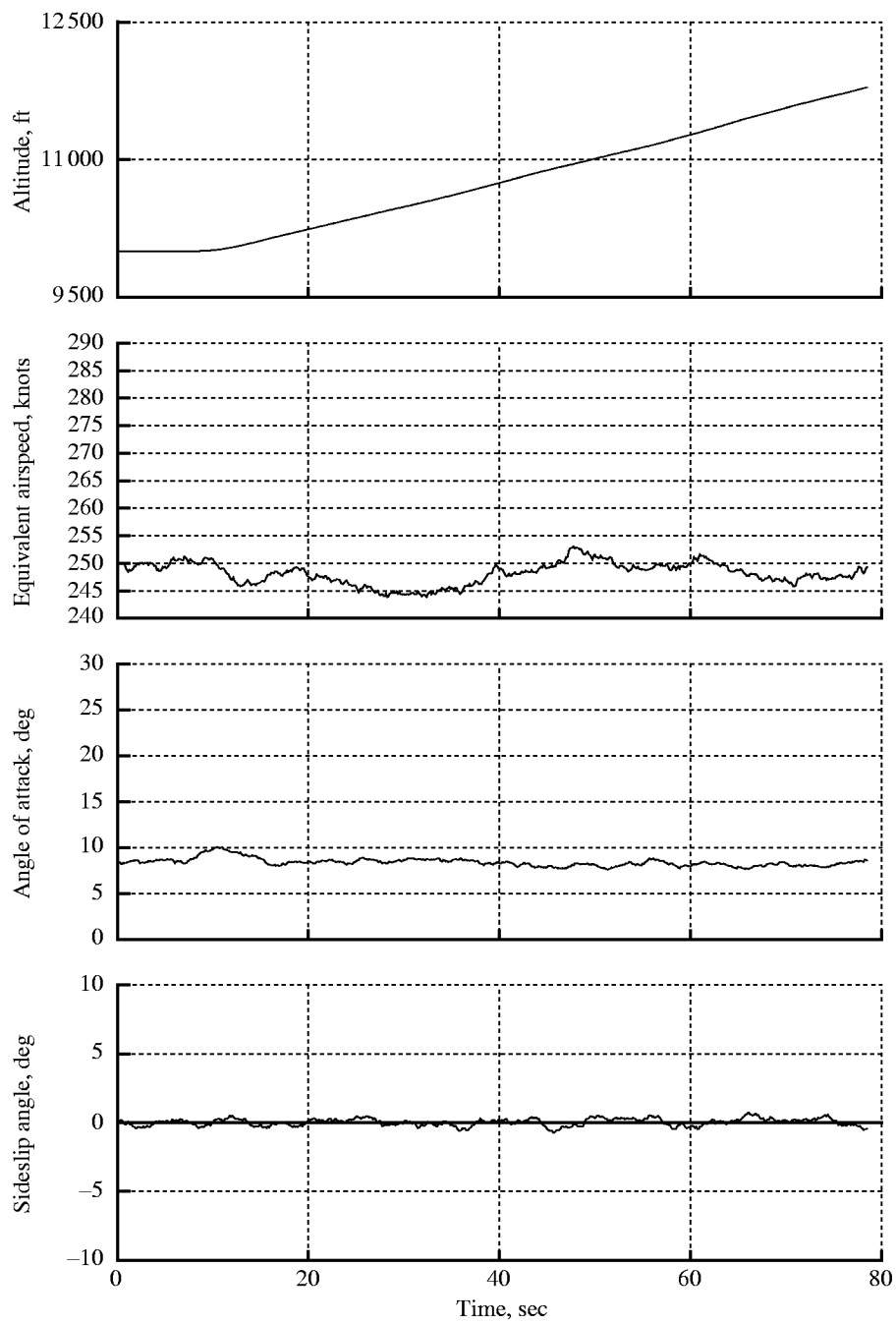

(c) Altitude, equivalent airspeed, angle of attack, and sideslip angle.

Figure 74. Continued.

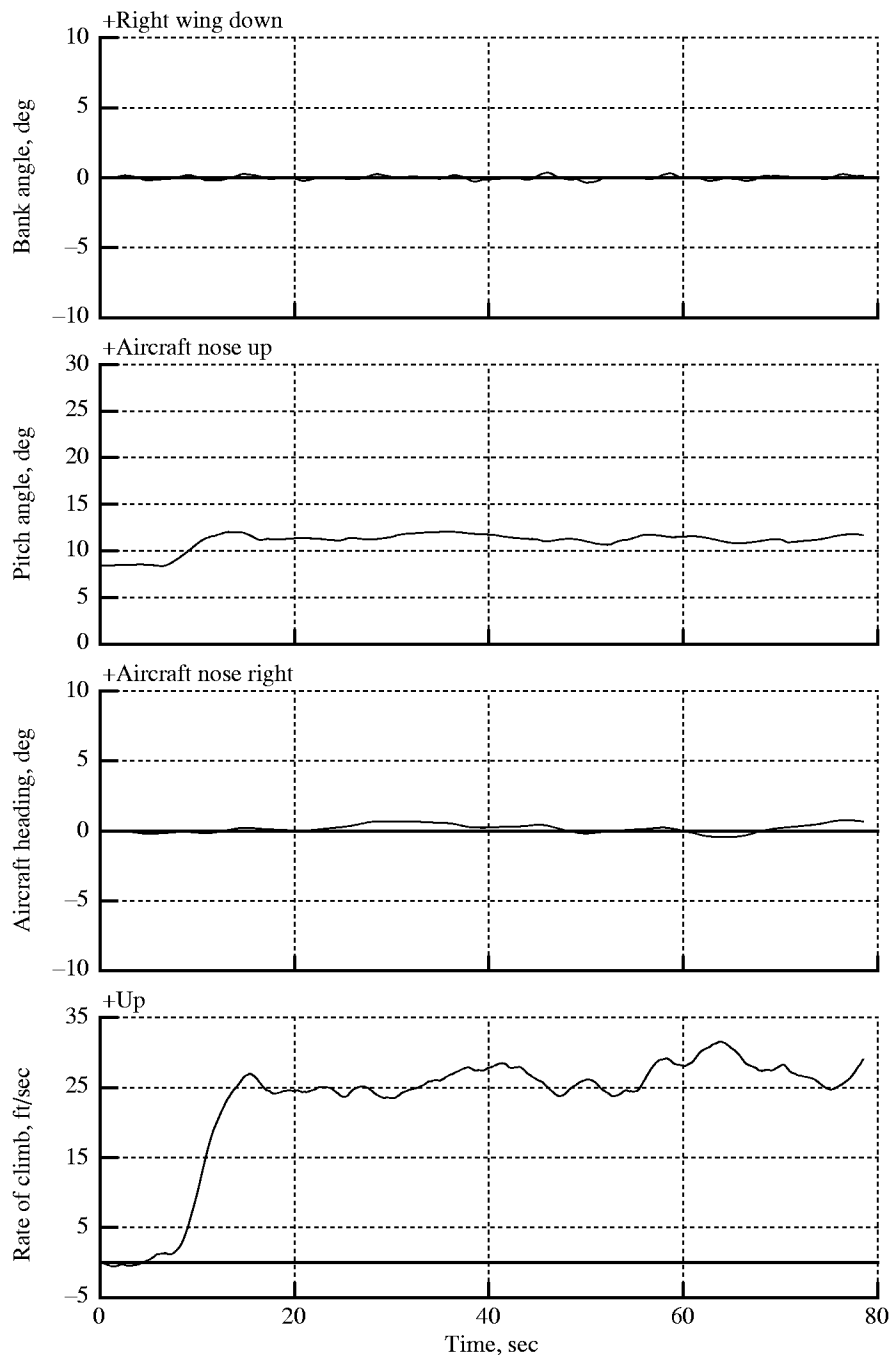

(d) Euler angles and rate of climb.

Figure 74. Continued.

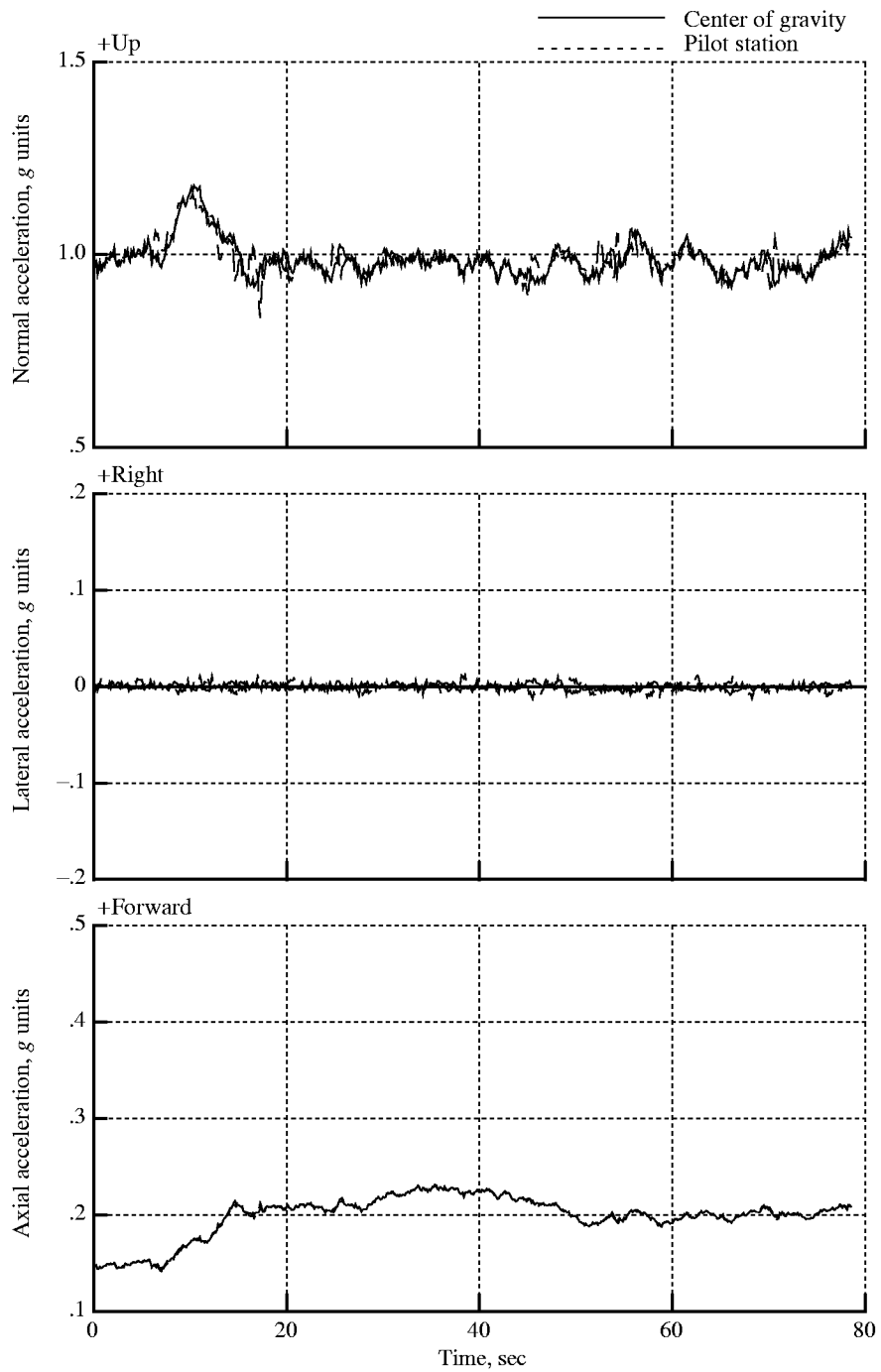

(e) Linear accelerations at center of gravity and pilot station.

Figure 74. Concluded.

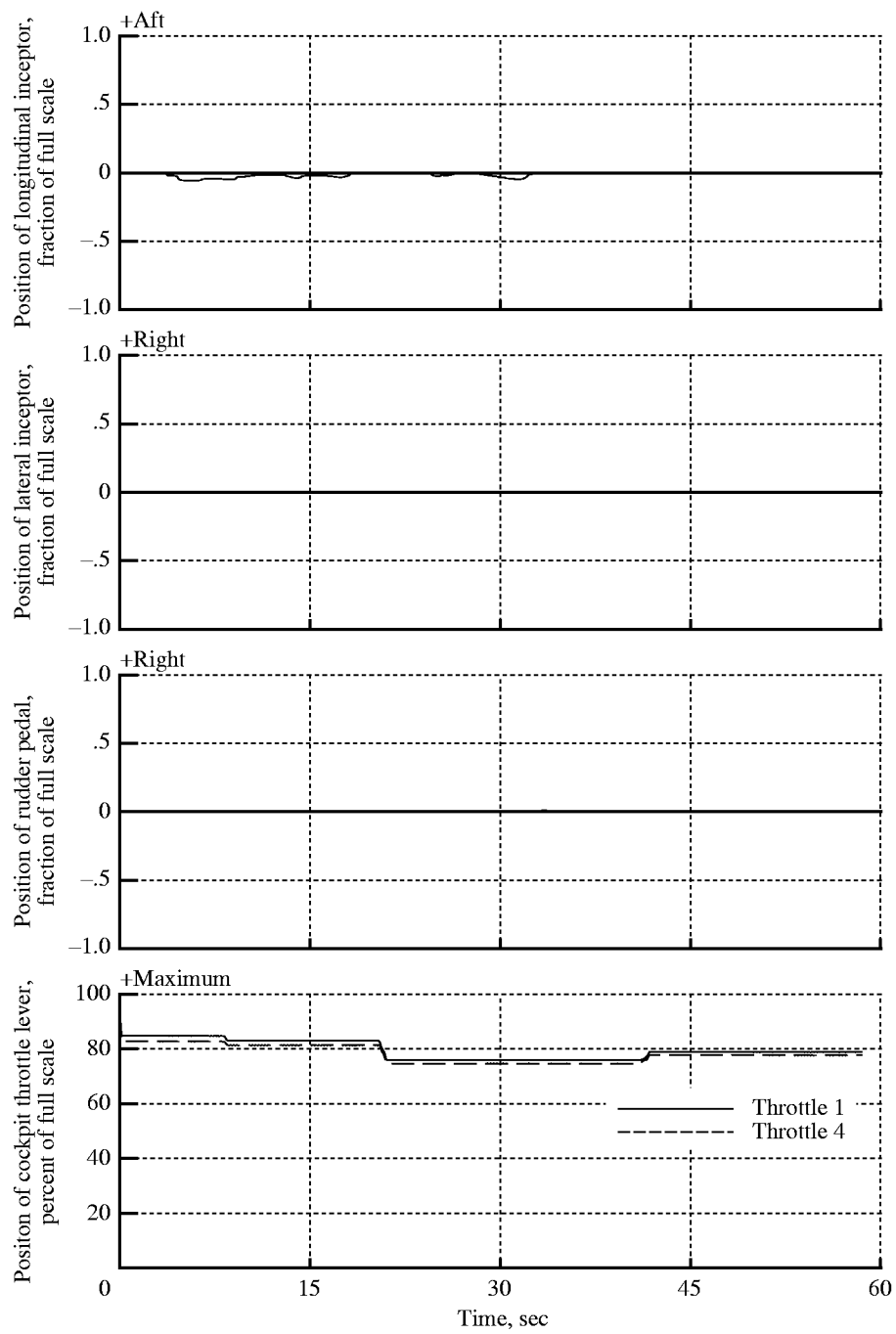

(a) Pilot controls.

Figure 75. Typical time histories for supersonic level flight transition to descent maneuver (task 3060).

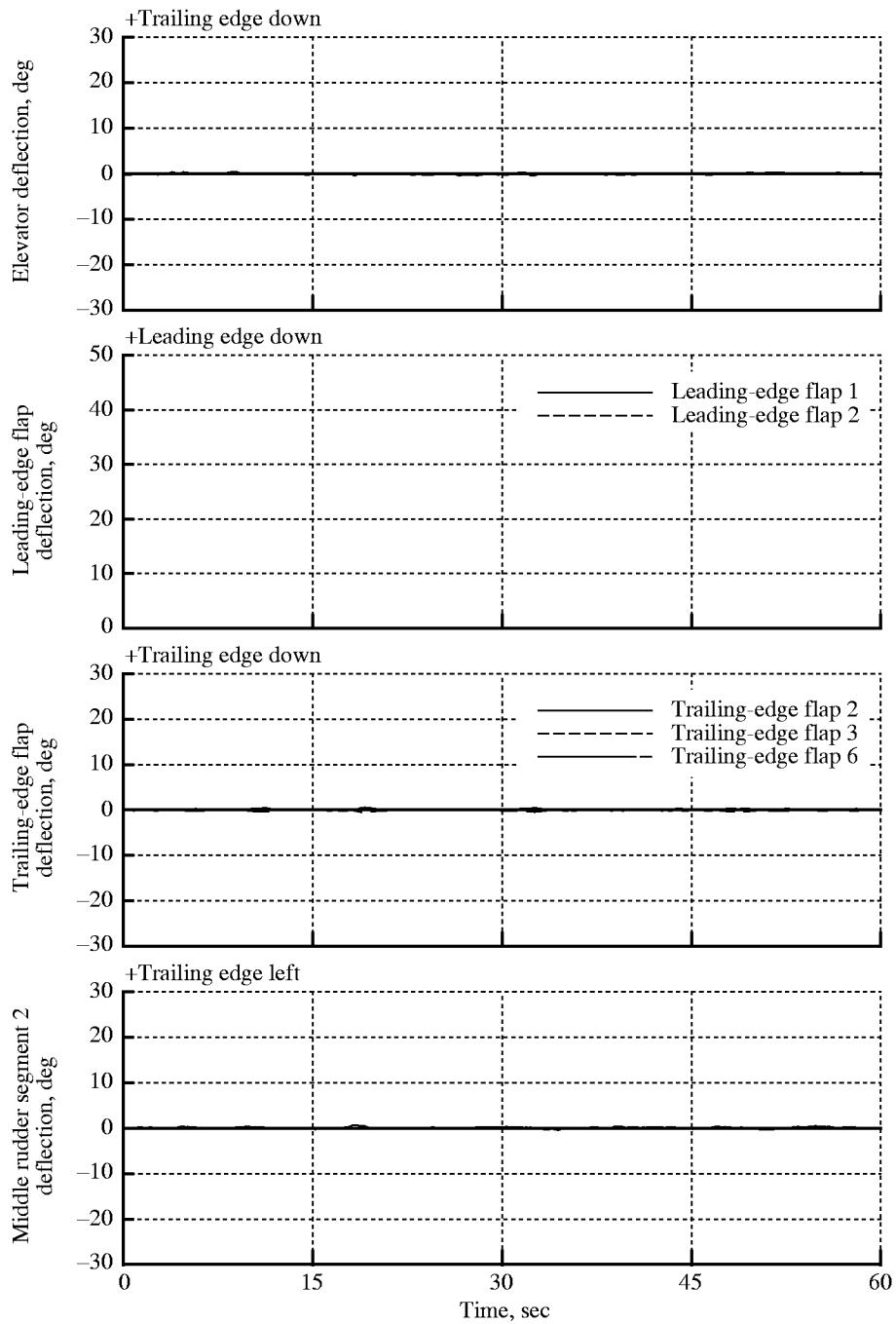

(b) Deflection of elevator; leading-edge flap segments 1 and 2; trailing-edge flap segments 2, 3, and 6; and middle rudder segment 2.

Figure 75. Continued.

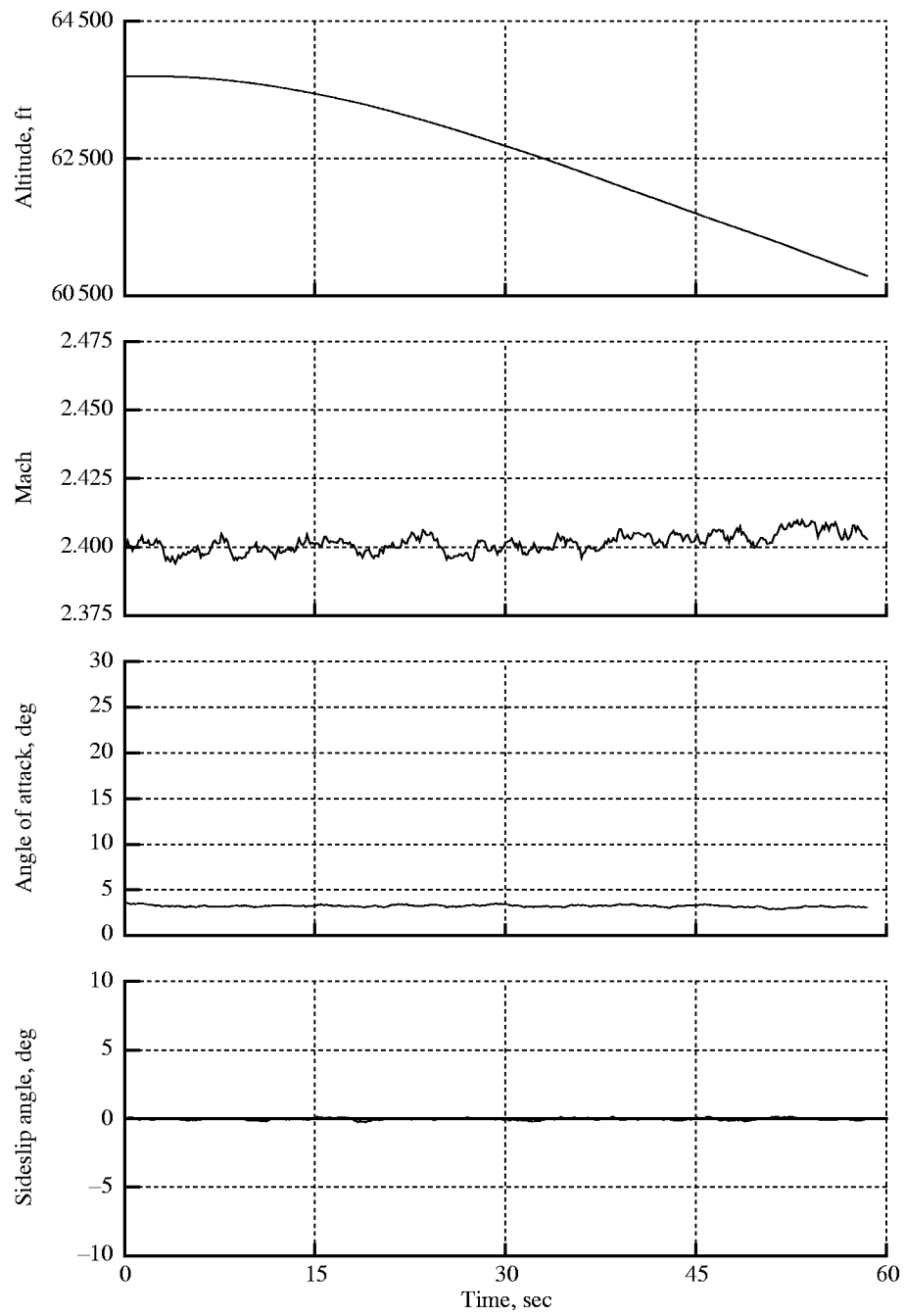

(c) Altitude, Mach, angle of attack, and sideslip angle.

Figure 75. Continued.

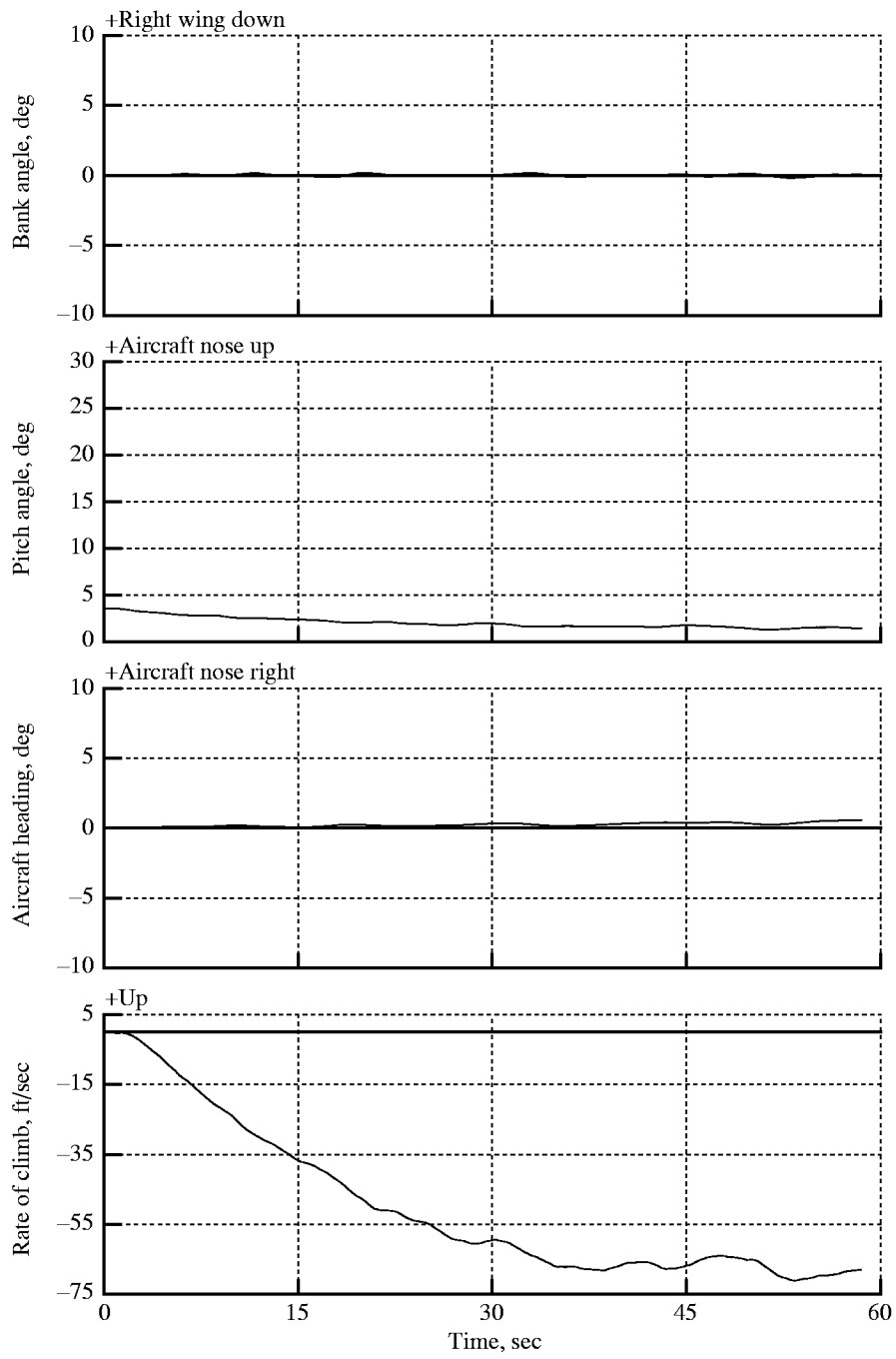

(d) Euler angles and rate of climb.

Figure 75. Continued.

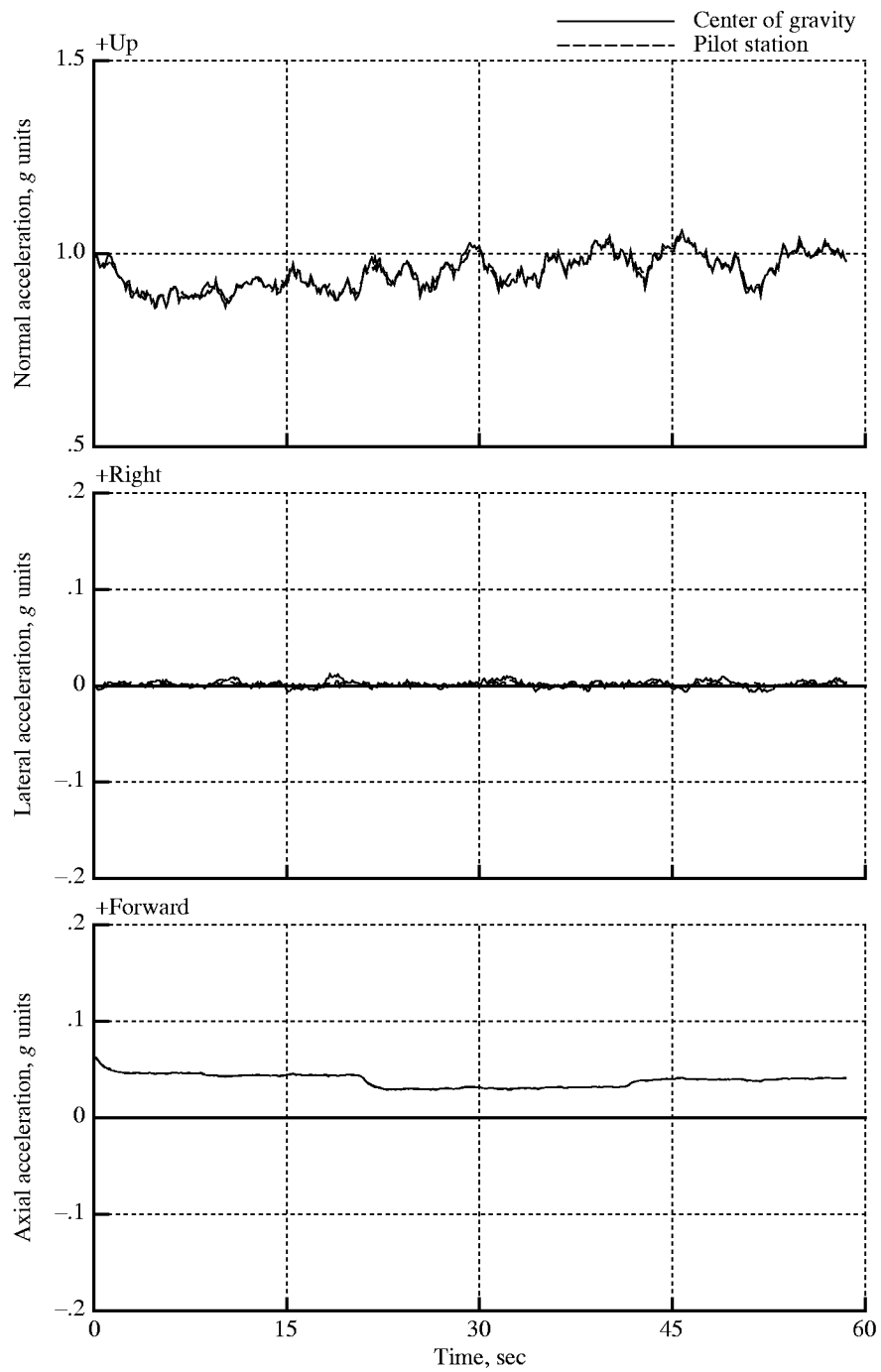

(e) Linear accelerations at center of gravity and pilot station.

Figure 75. Concluded.

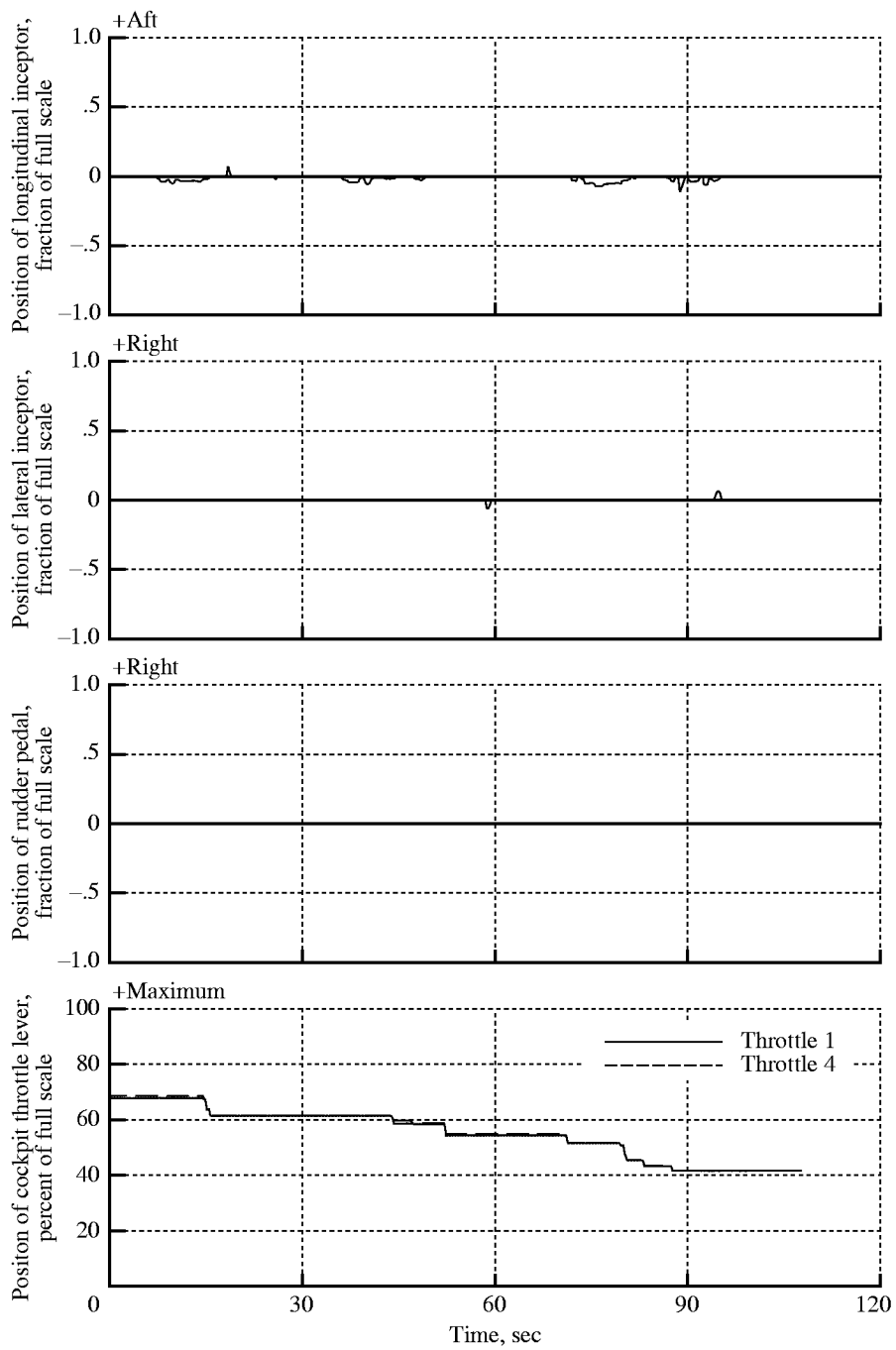

(a) Pilot controls.

Figure 76. Typical time histories for transonic level flight transition to descent (task 3062).

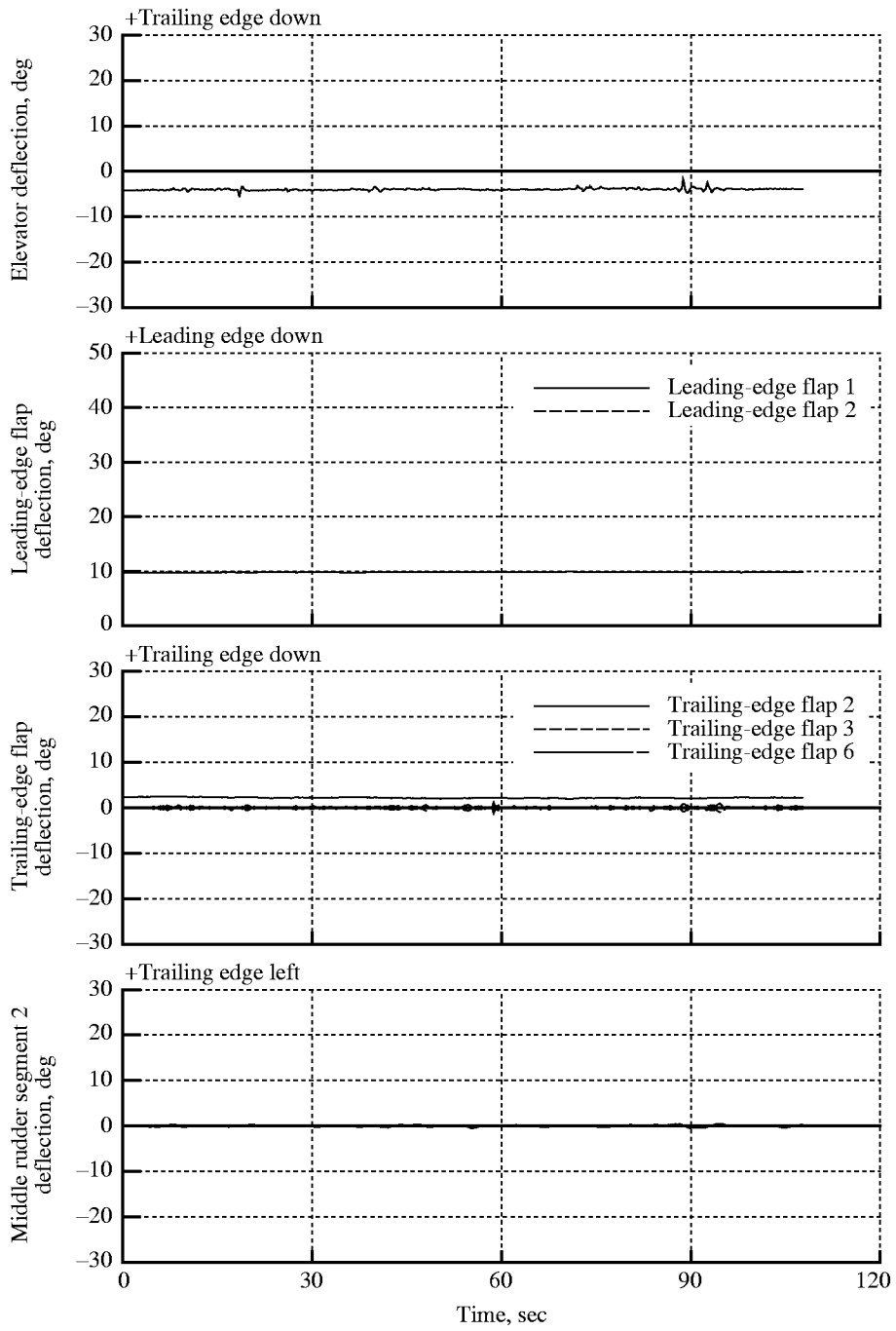

(b) Deflection of elevator; leading-edge flap segments 1 and 2; trailing-edge flap segments 2, 3, and 6; and middle rudder segment 2.

Figure 76. Continued.

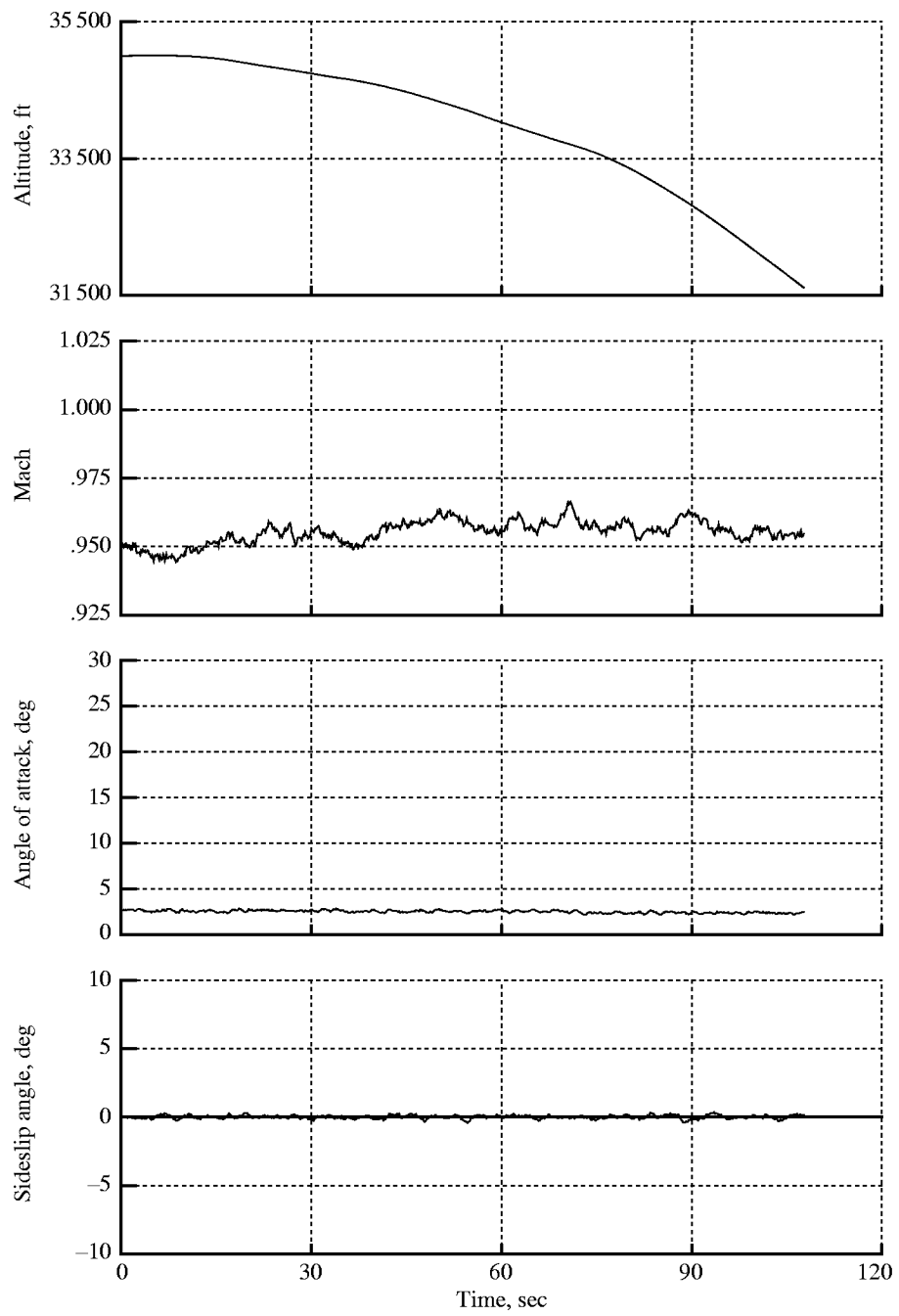

(c) Altitude, Mach, angle of attack, and sideslip angle.

Figure 76. Continued.

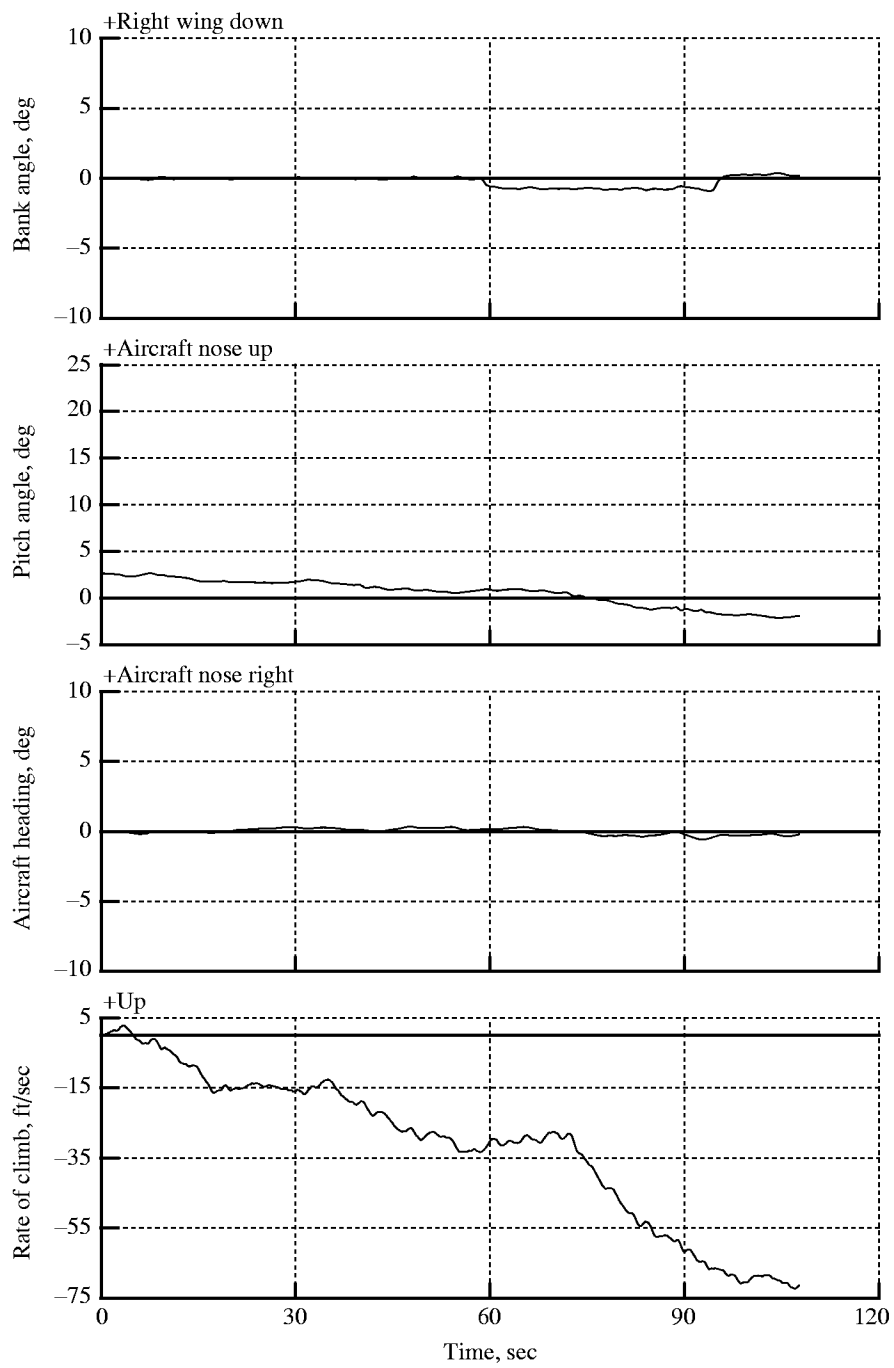

(d) Euler angles and rate of climb.

Figure 76. Continued.

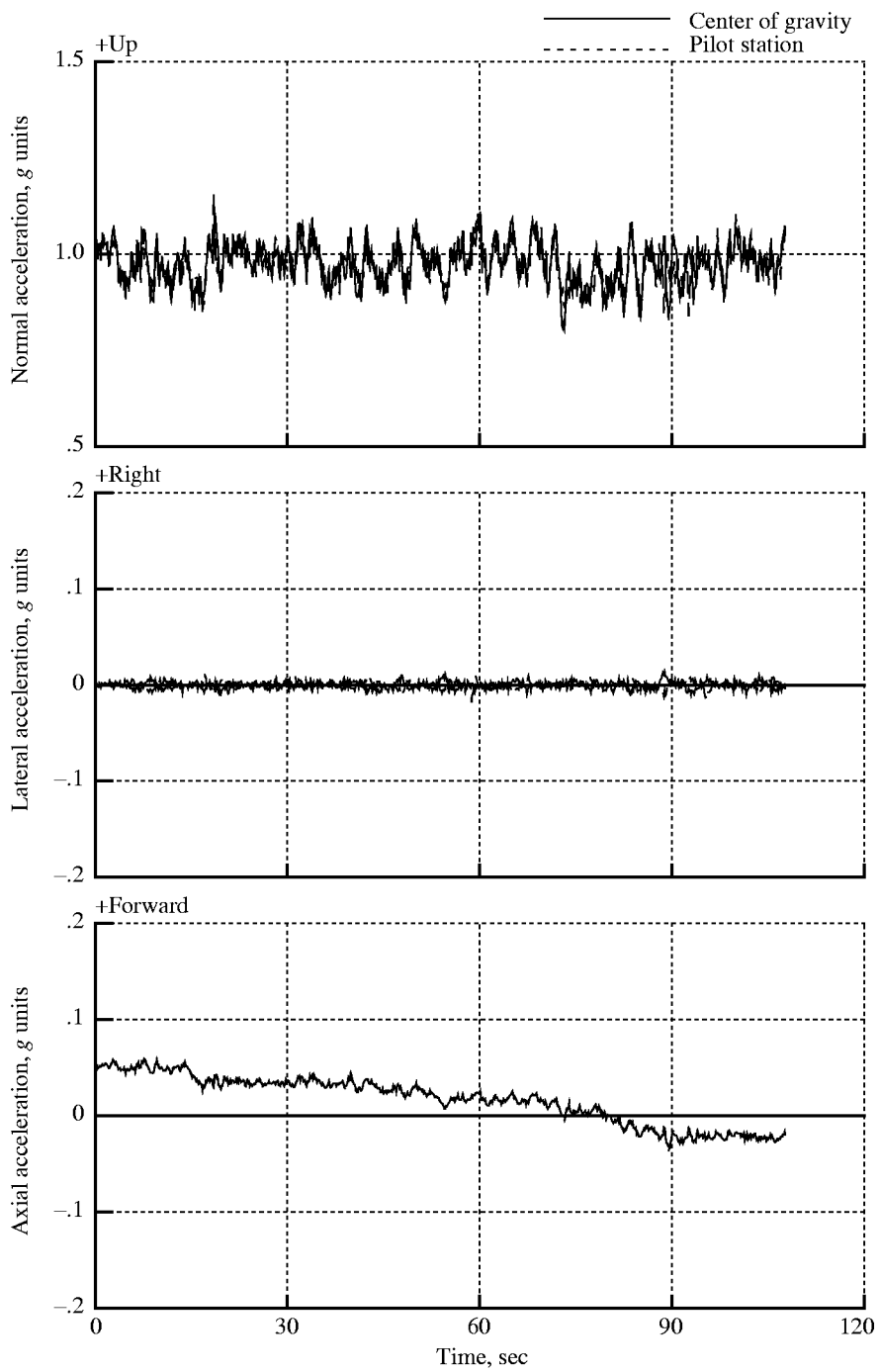

(e) Linear accelerations at center of gravity and pilot station.

Figure 76. Concluded.

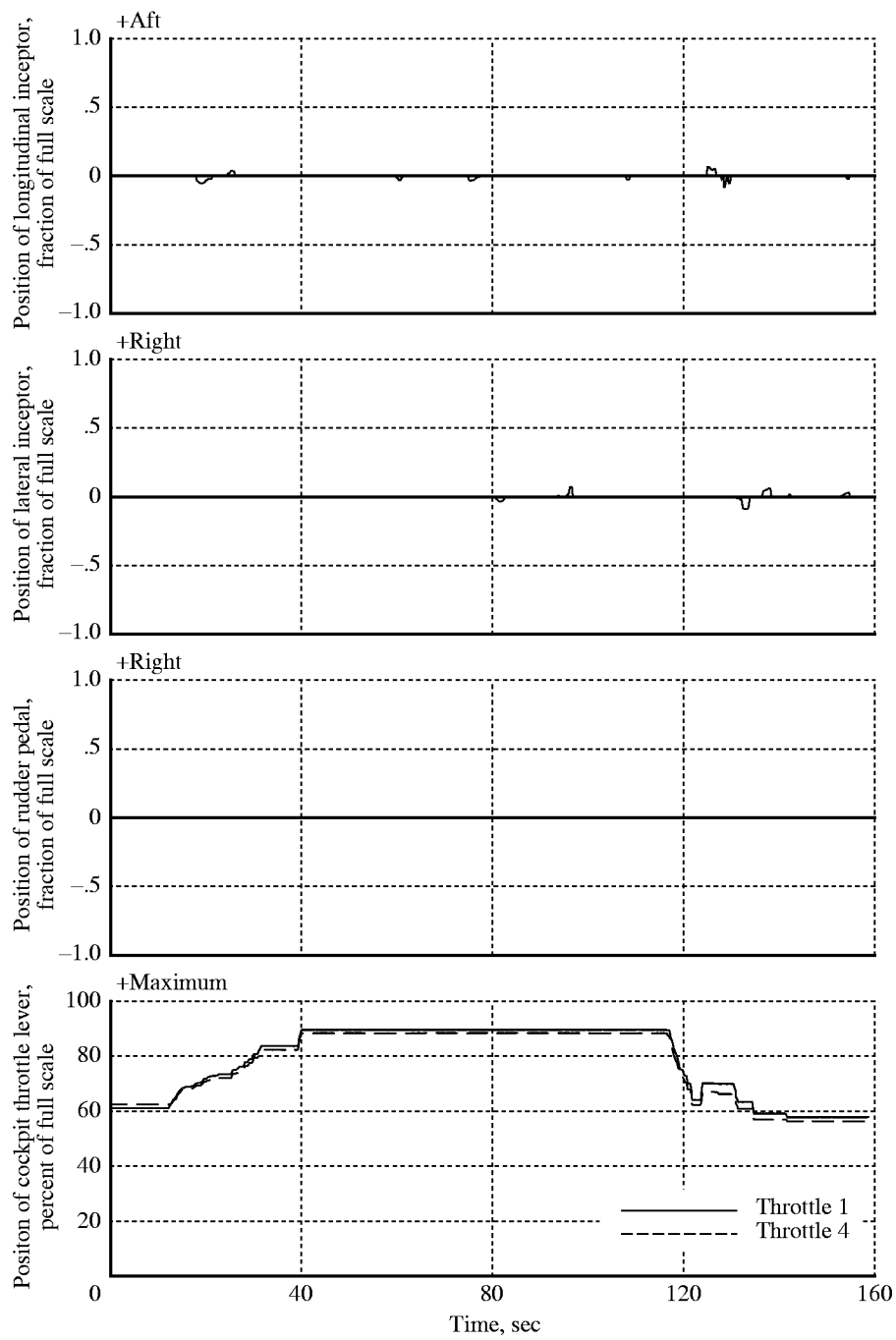

(a) Pilot controls.

Figure 77. Typical time histories for transonic acceleration maneuver (task 3070).

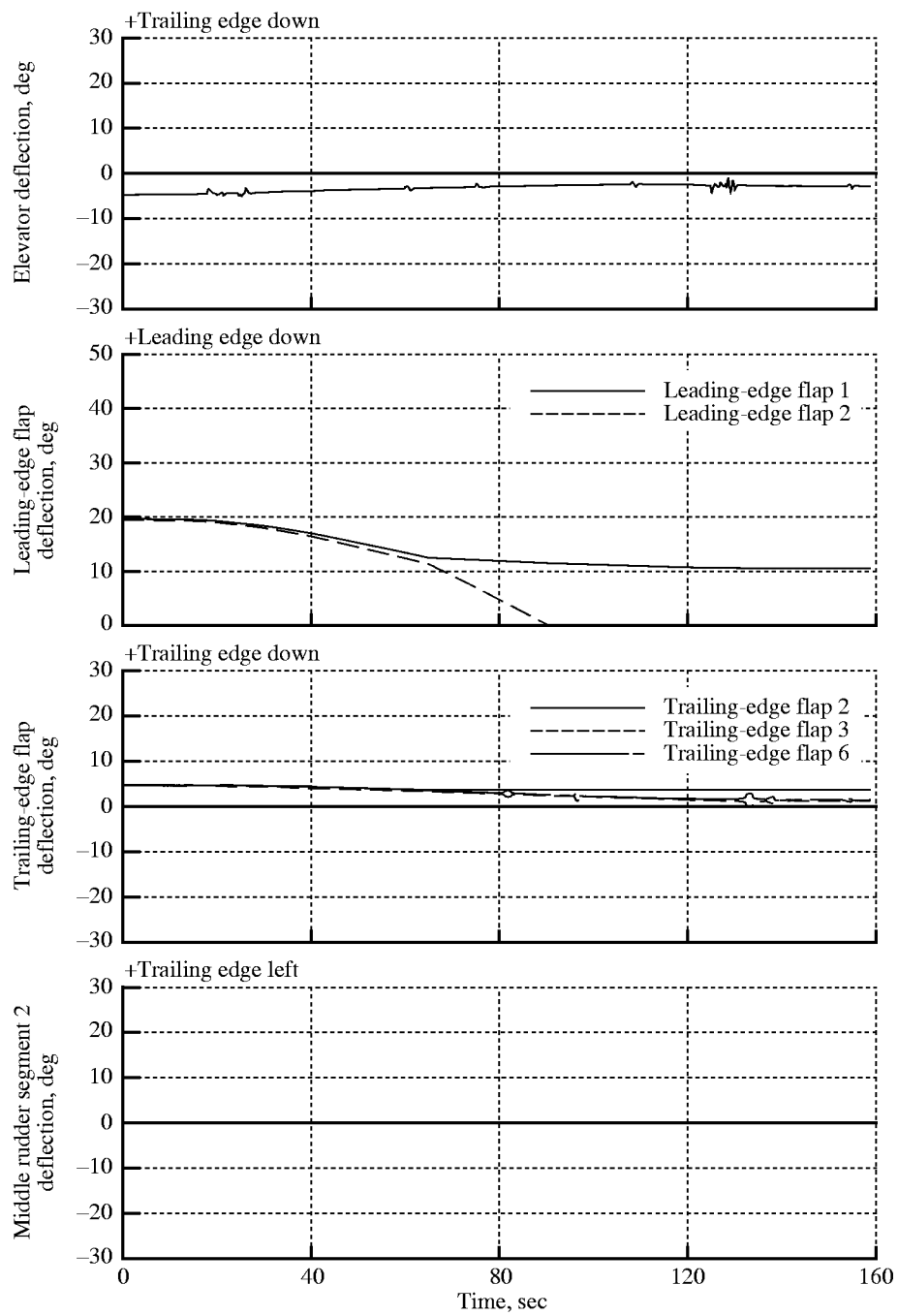

(b) Deflection of elevator; leading-edge flap segments 1 and 2; trailing-edge flap segments 2, 3, and 6; and middle rudder segment 2.

Figure 77. Continued.

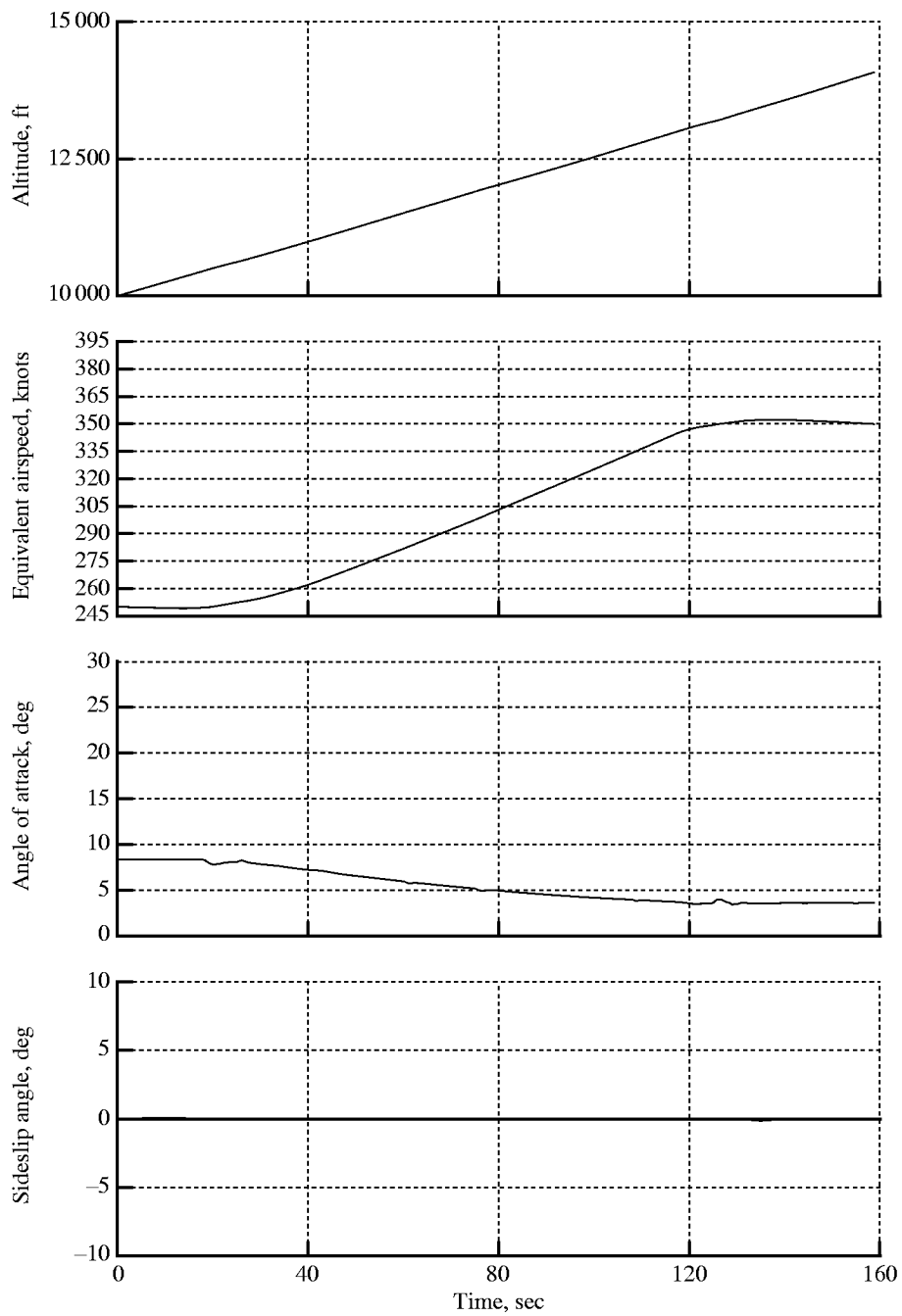

(c) Altitude, equivalent airspeed, angle of attack, and sideslip angle.

Figure 77. Continued.

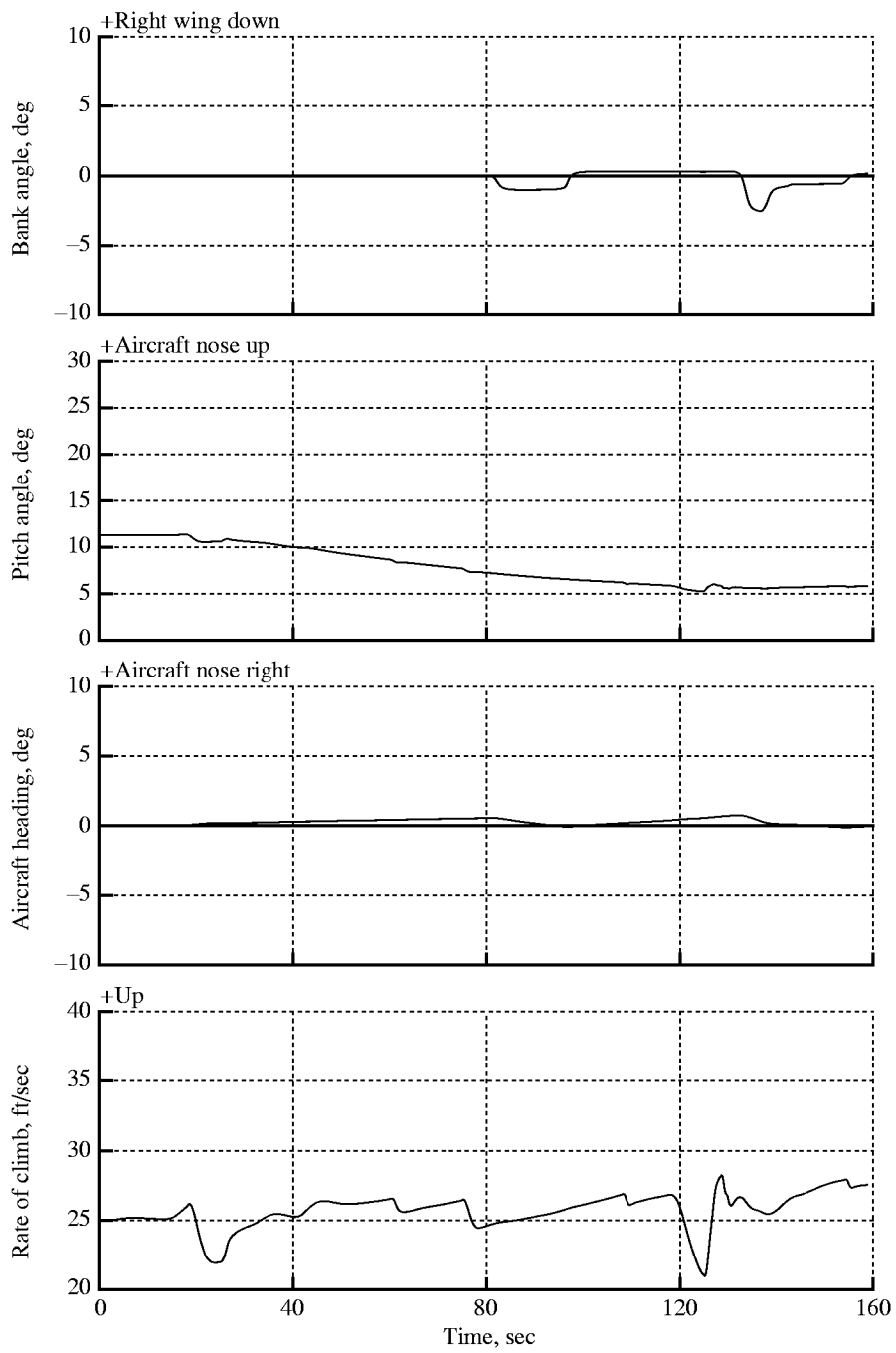

(d) Euler angles and rate of climb.

Figure 77. Continued.

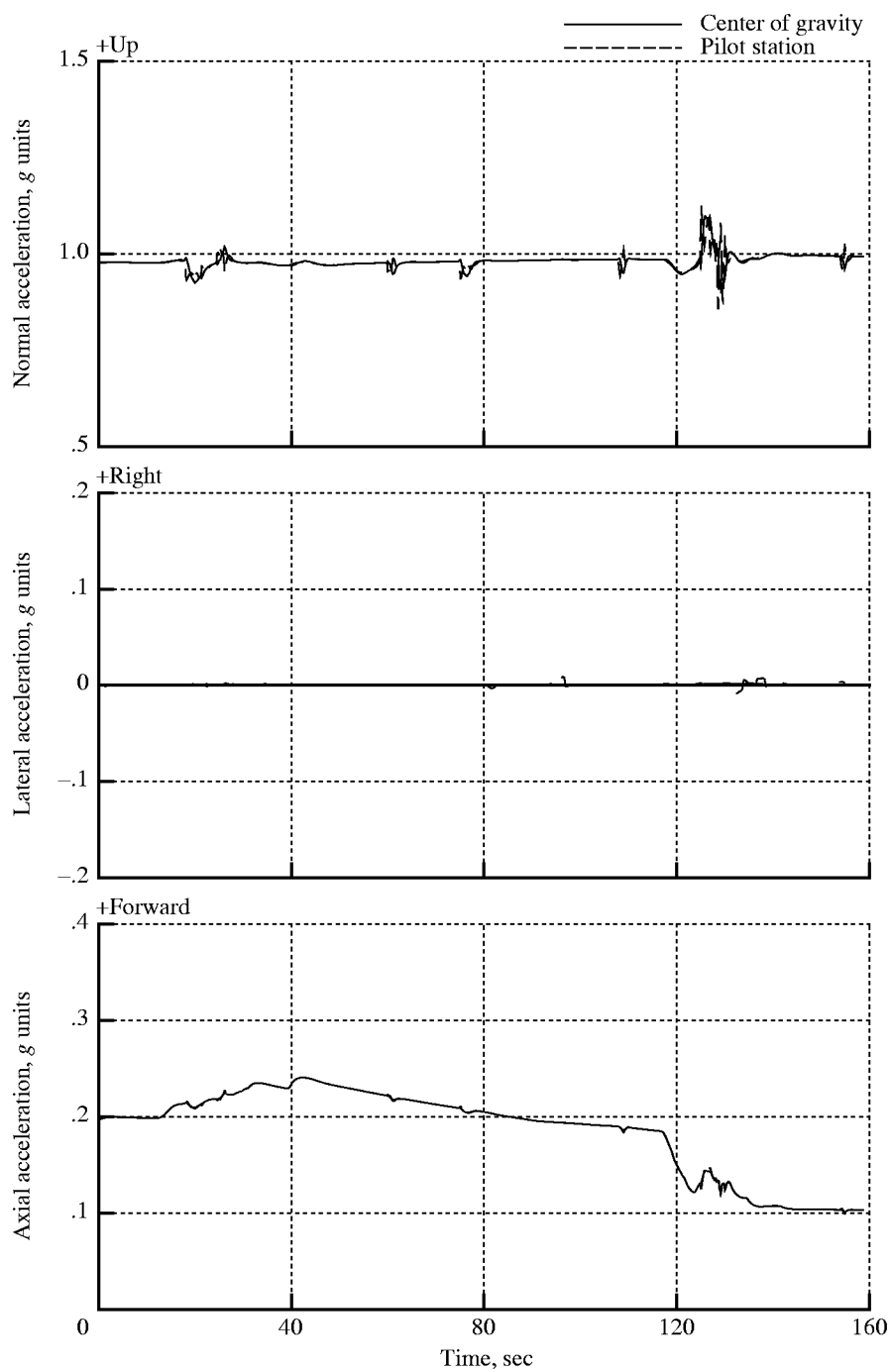

(e) Linear accelerations at center of gravity and pilot station.

Figure 77. Concluded.

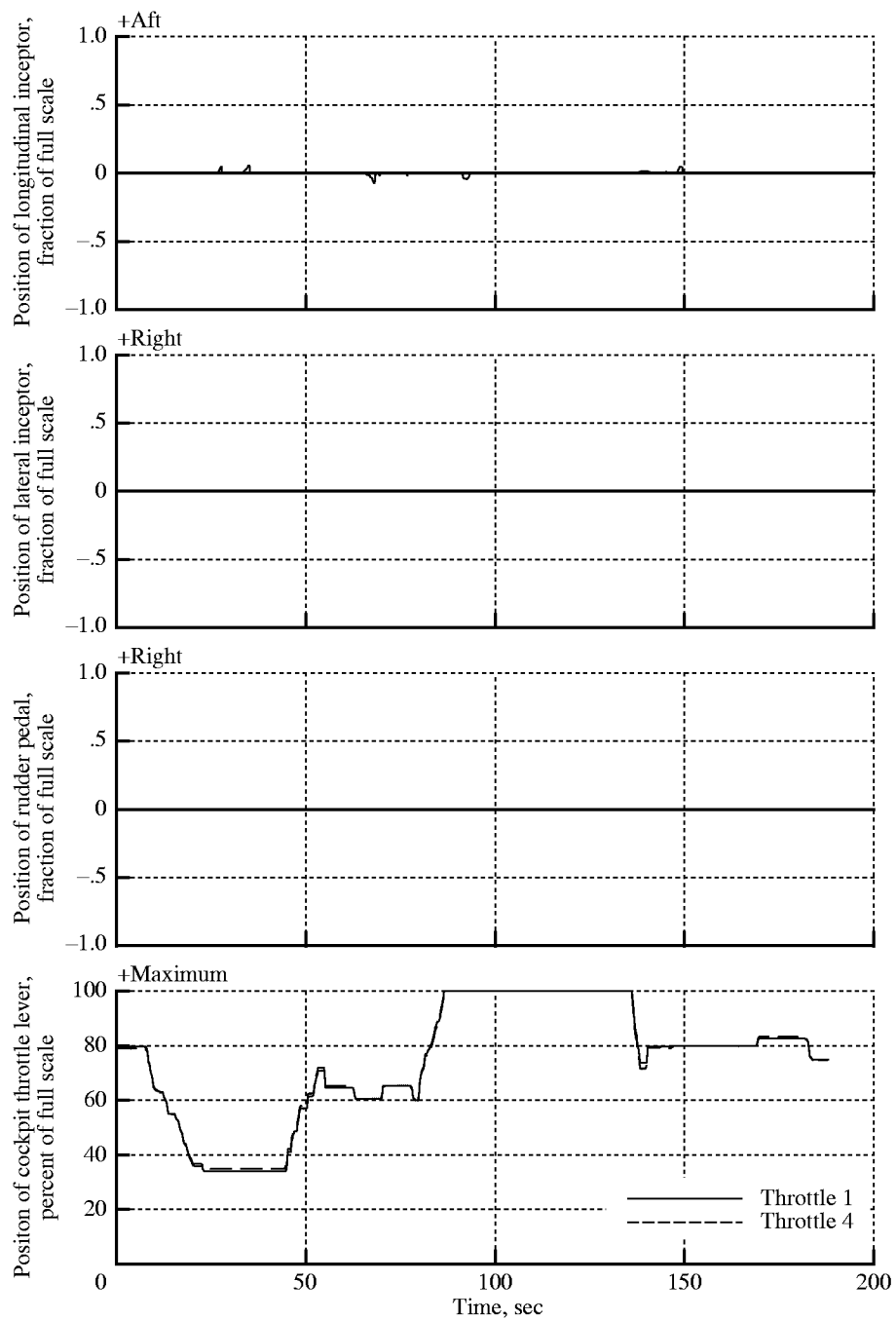

(a) Pilot controls.

Figure 78. Typical time histories of transonic deceleration maneuver (task 3074).

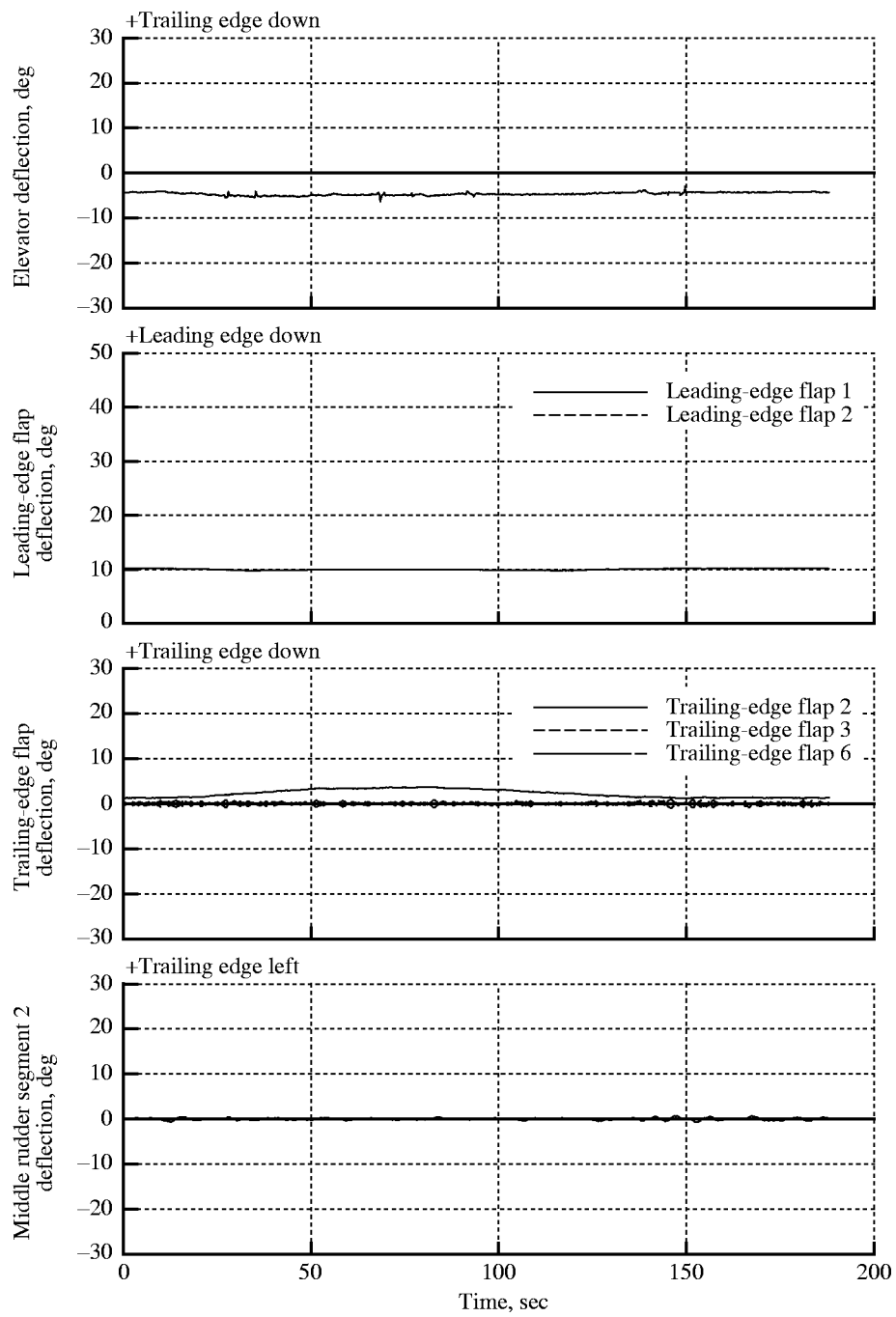

(b) Deflection of elevator; leading-edge flap segments 1 and 2; trailing-edge flap segments 2, 3, and 6; and middle rudder segment 2.

Figure 78. Continued.

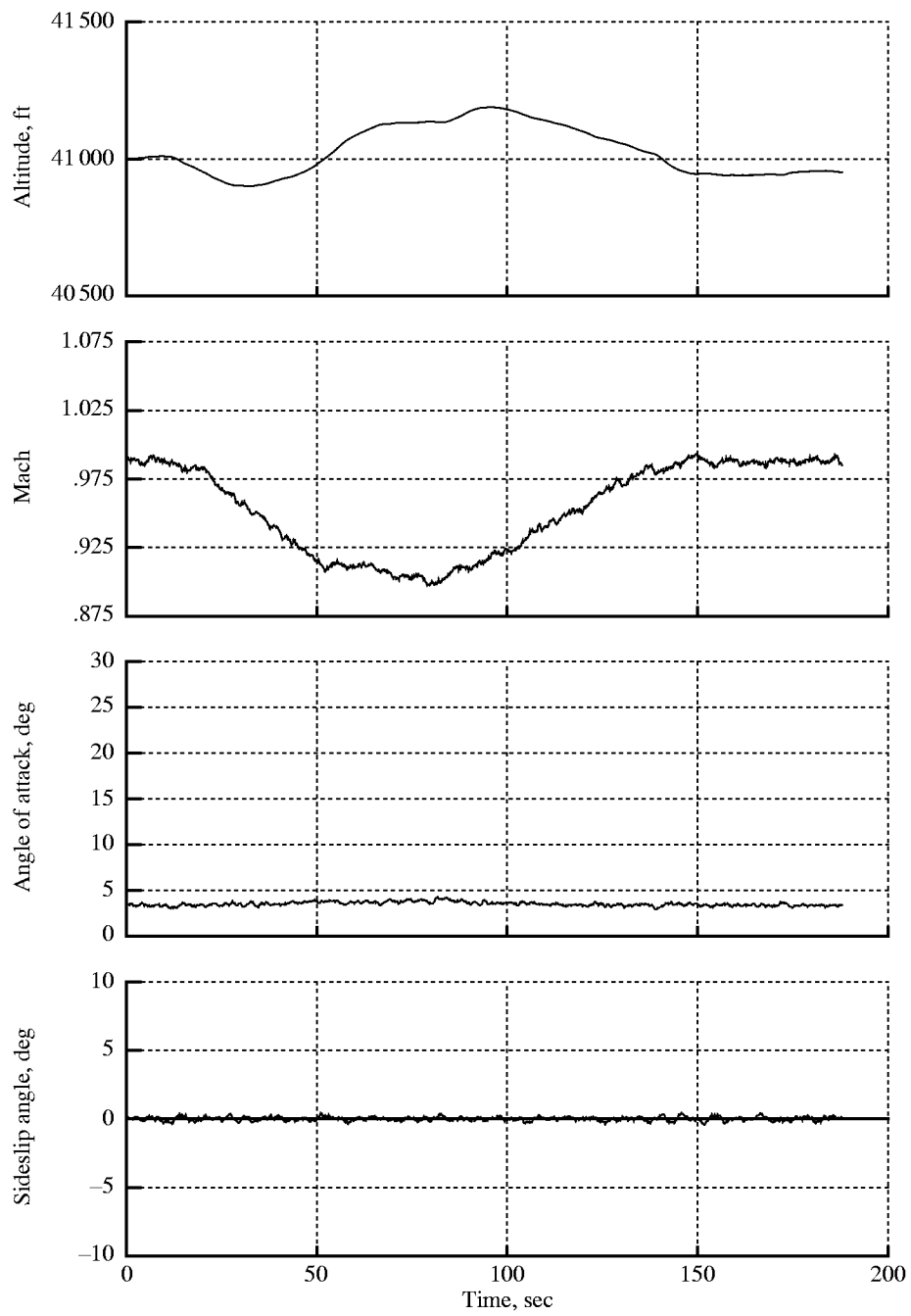

(c) Altitude, Mach, angle of attack, and sideslip angle.

Figure 78. Continued.

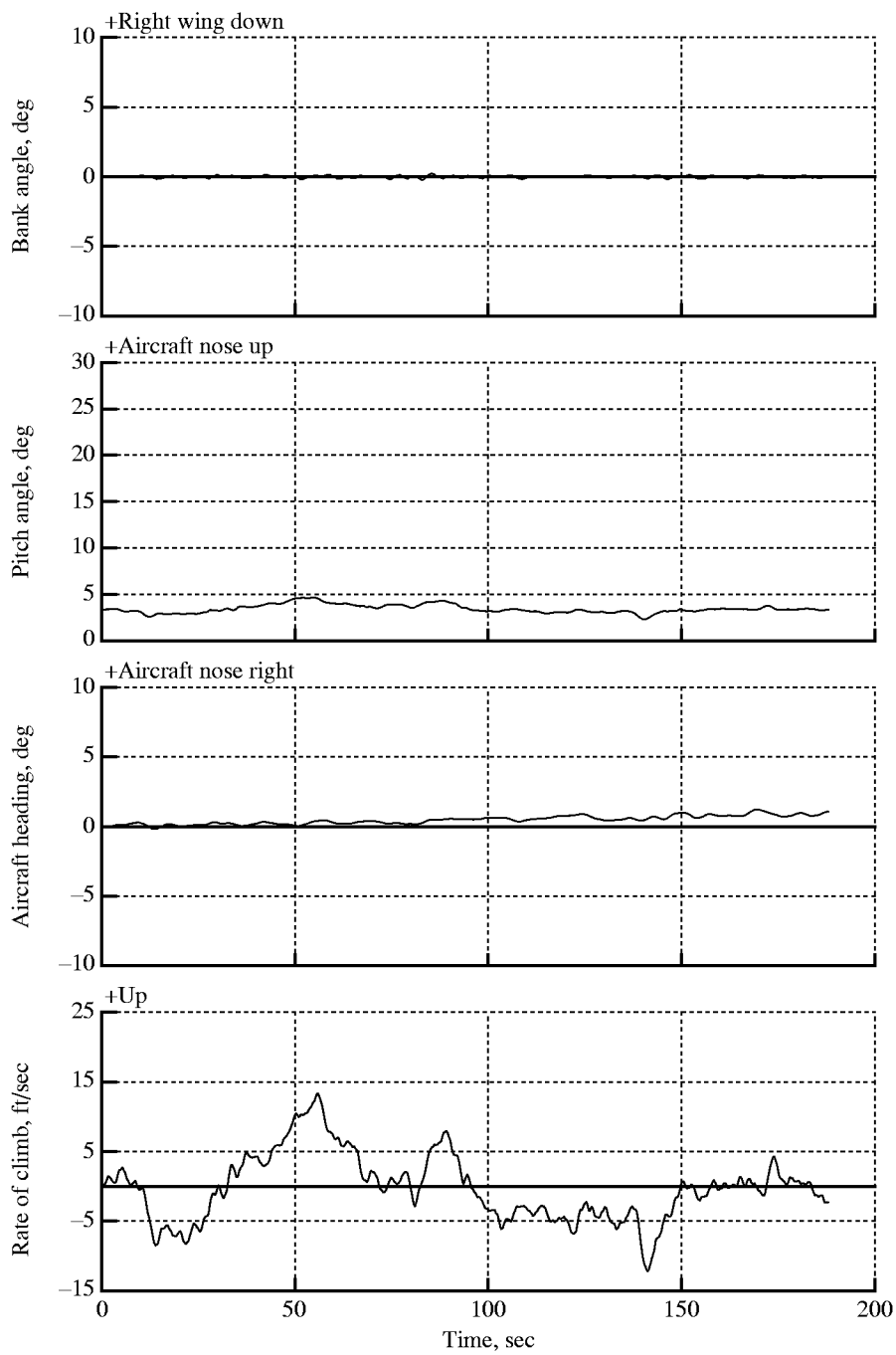

(d) Euler angles and rate of climb.

Figure 78. Continued.

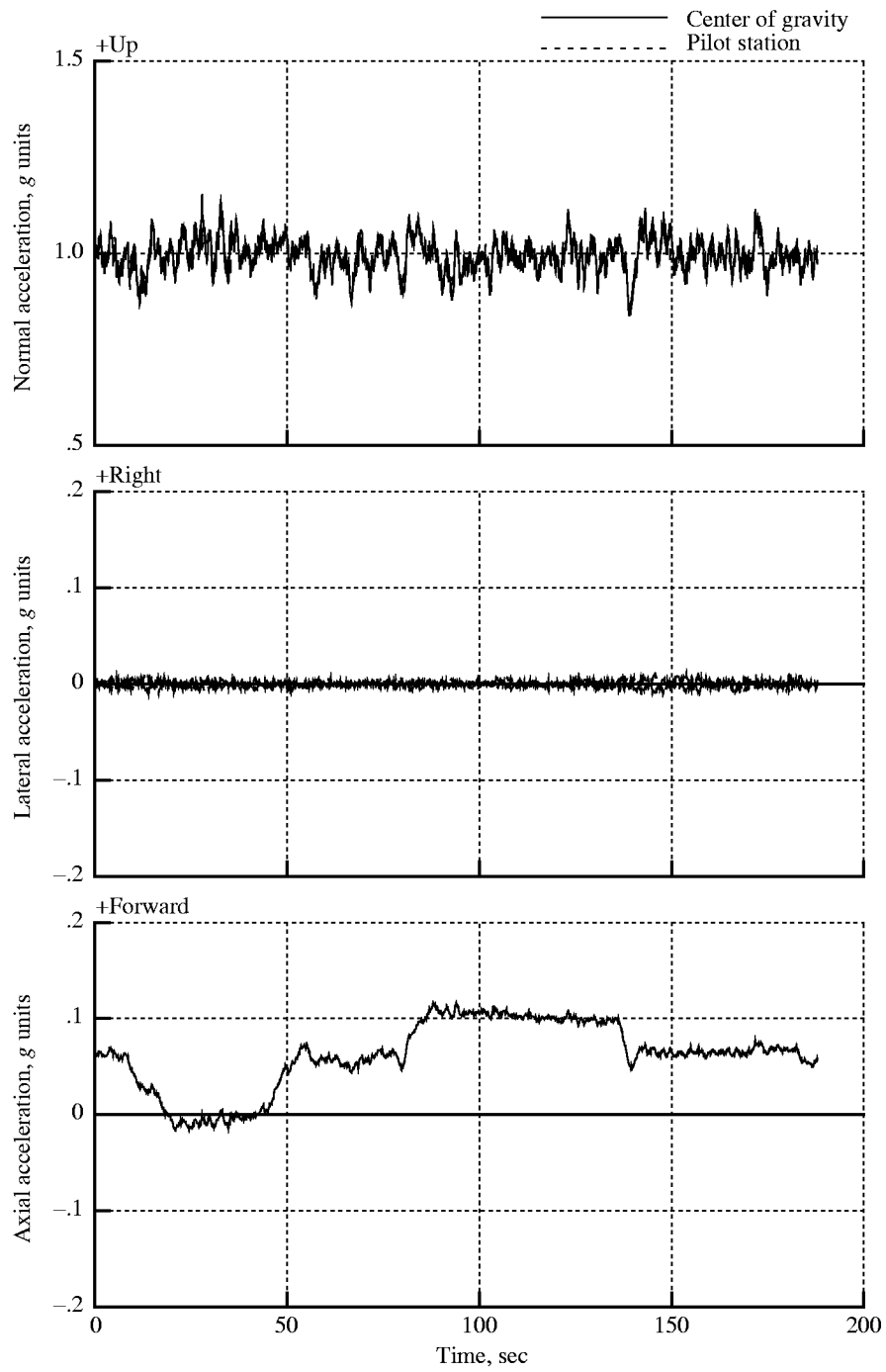

(e) Linear accelerations at center of gravity and pilot station.

Figure 78. Concluded.

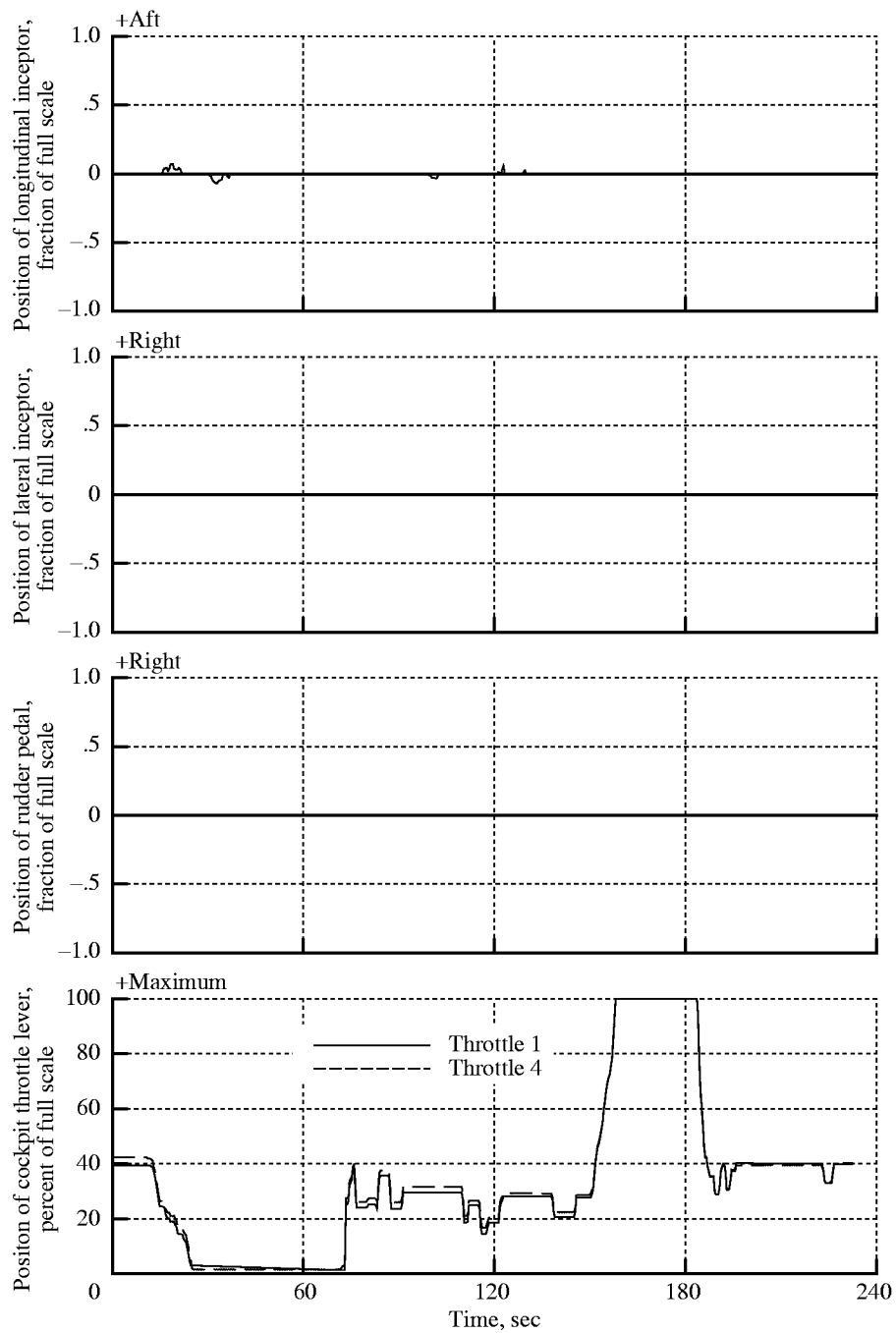

(a) Pilot controls.

Figure 79. Typical time histories for subsonic deceleration maneuver (task 3076).

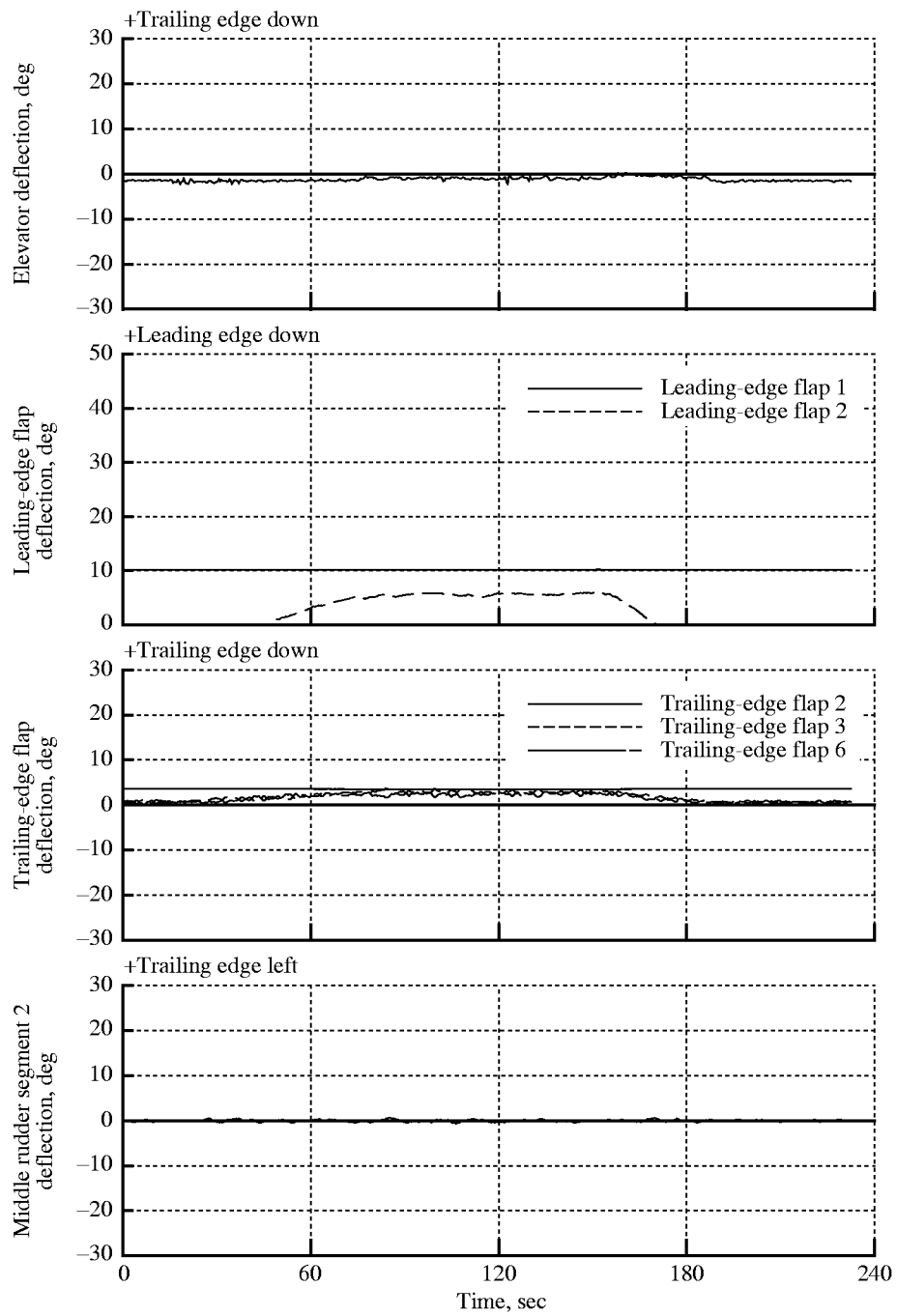

(b) Deflection of elevator; leading-edge flap segments 1 and 2; trailing-edge flap segments 2, 3, and 6; and middle rudder segment 2.

Figure 79. Continued.

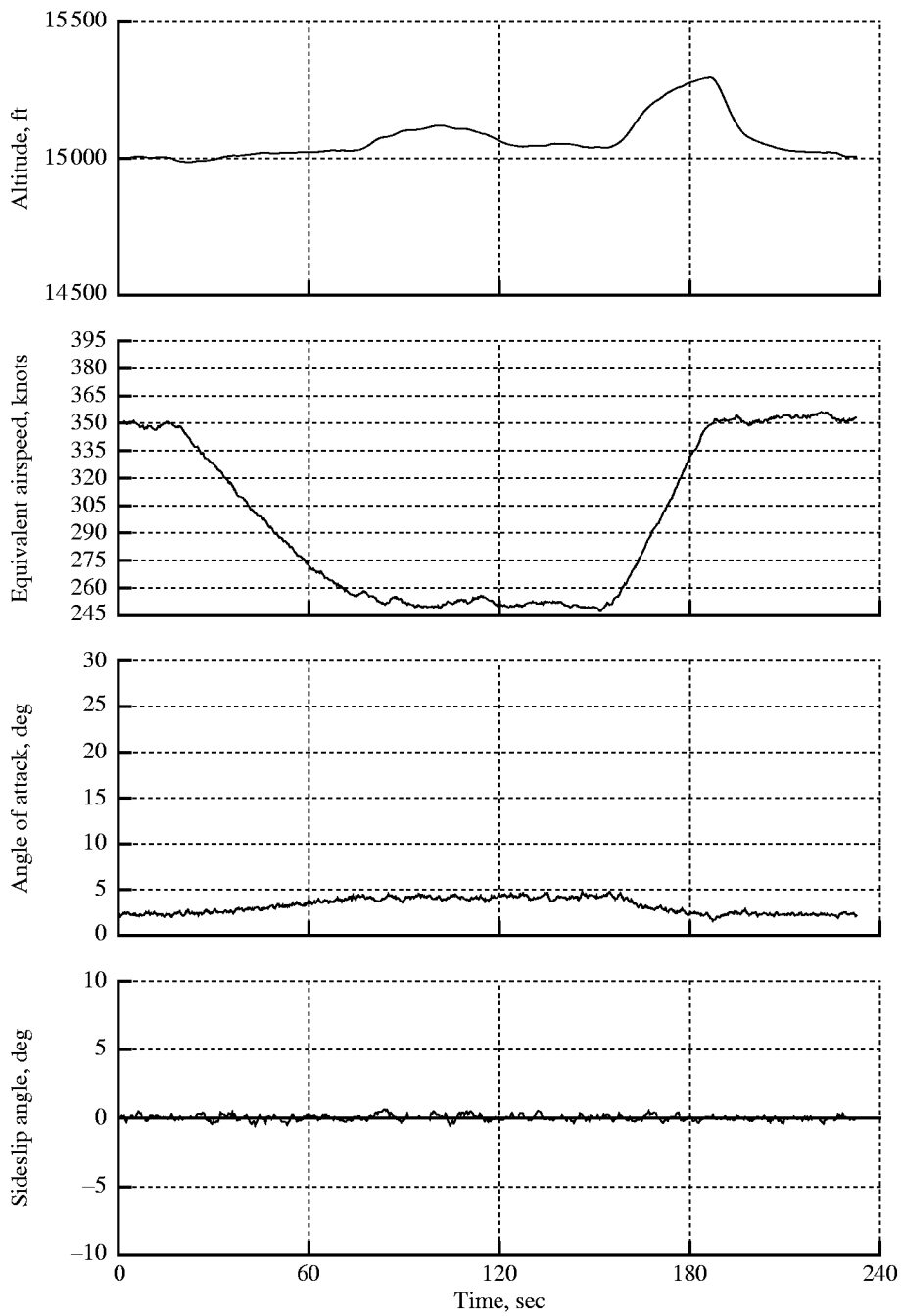

(c) Altitude, equivalent airspeed, angle of attack, and sideslip angle.

Figure 79. Continued.

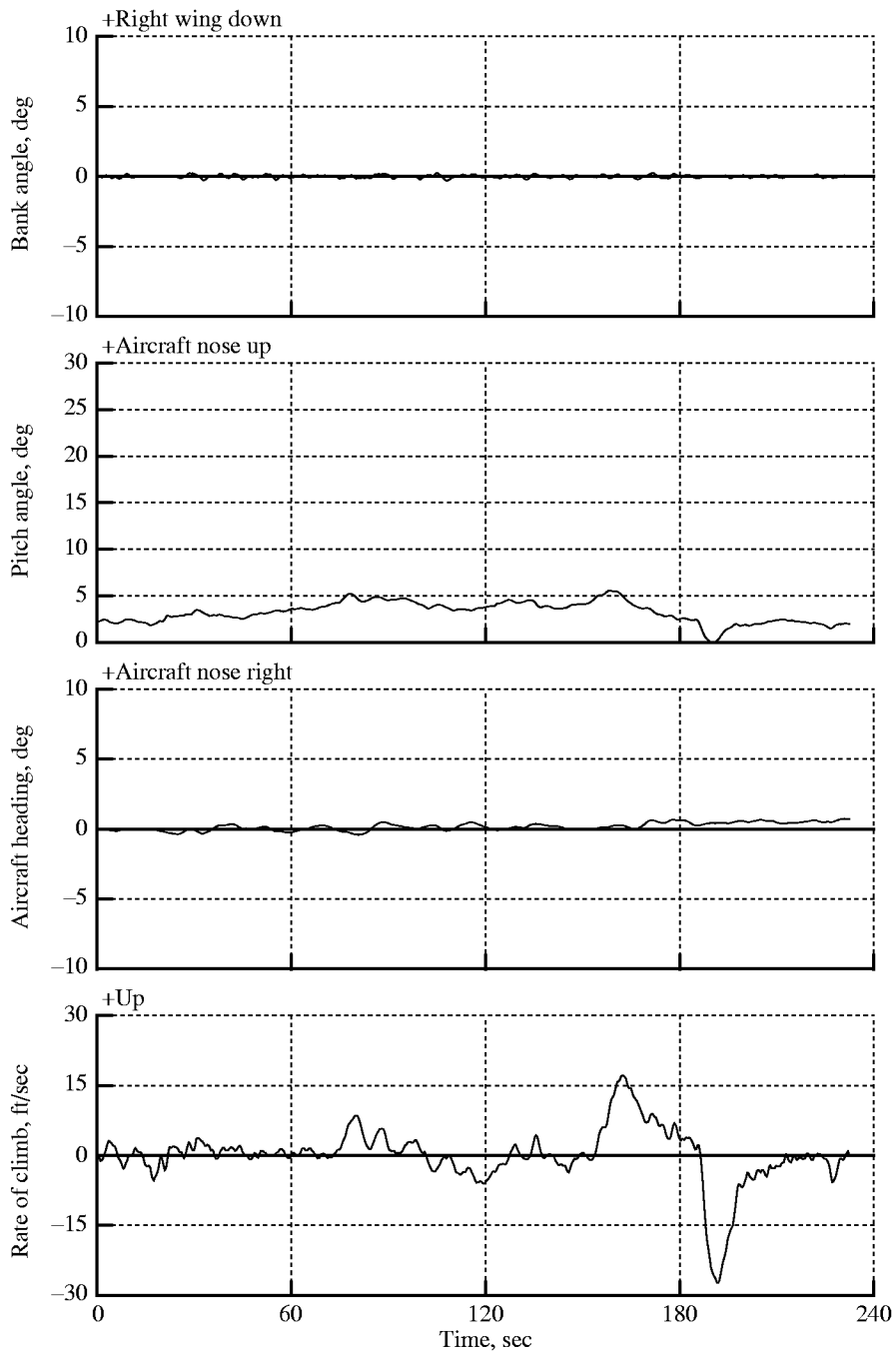

(d) Euler angles and rate of climb.

Figure 79. Continued.

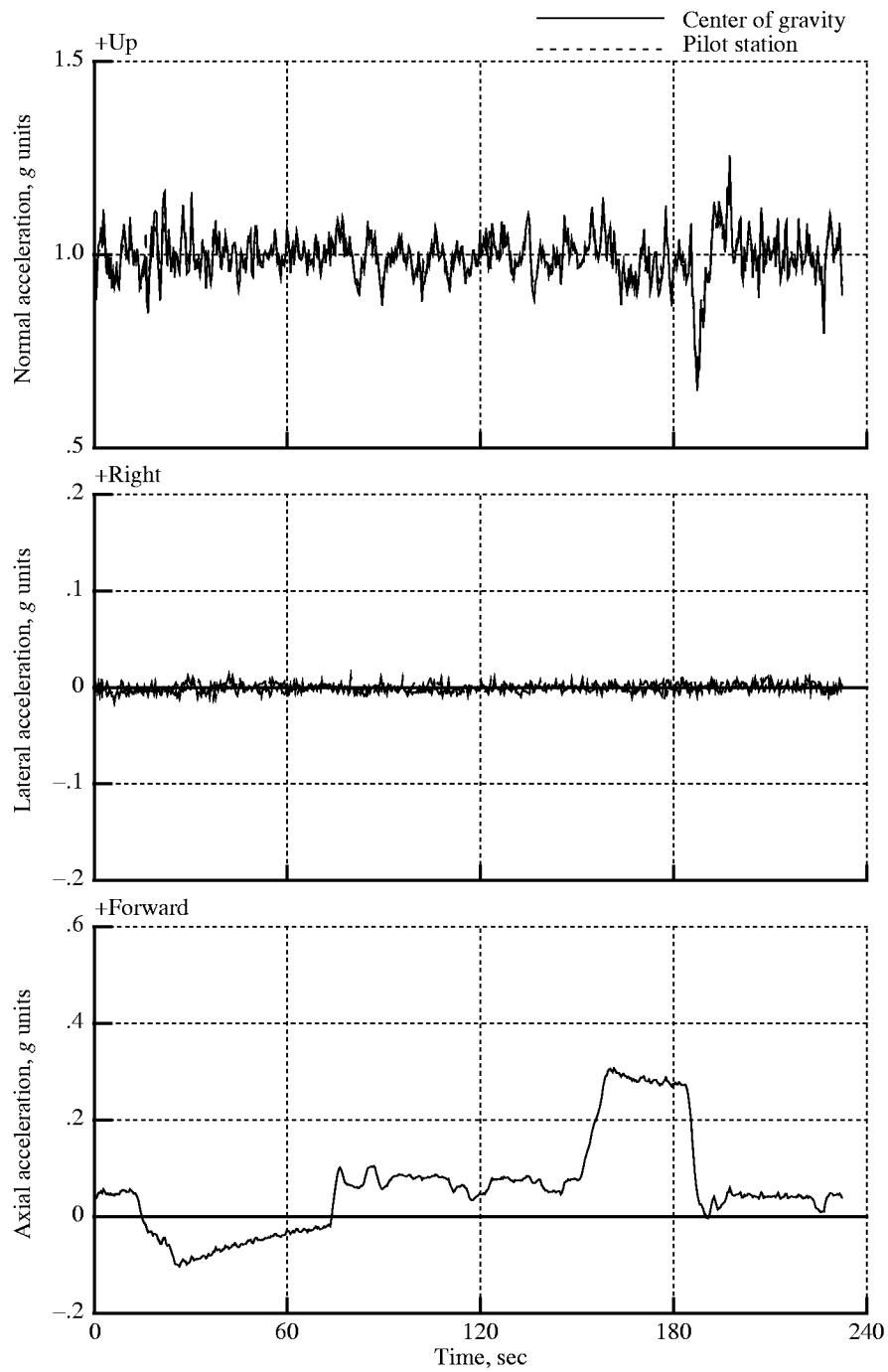

(e) Linear accelerations at center of gravity and pilot station.

Figure 79. Concluded.

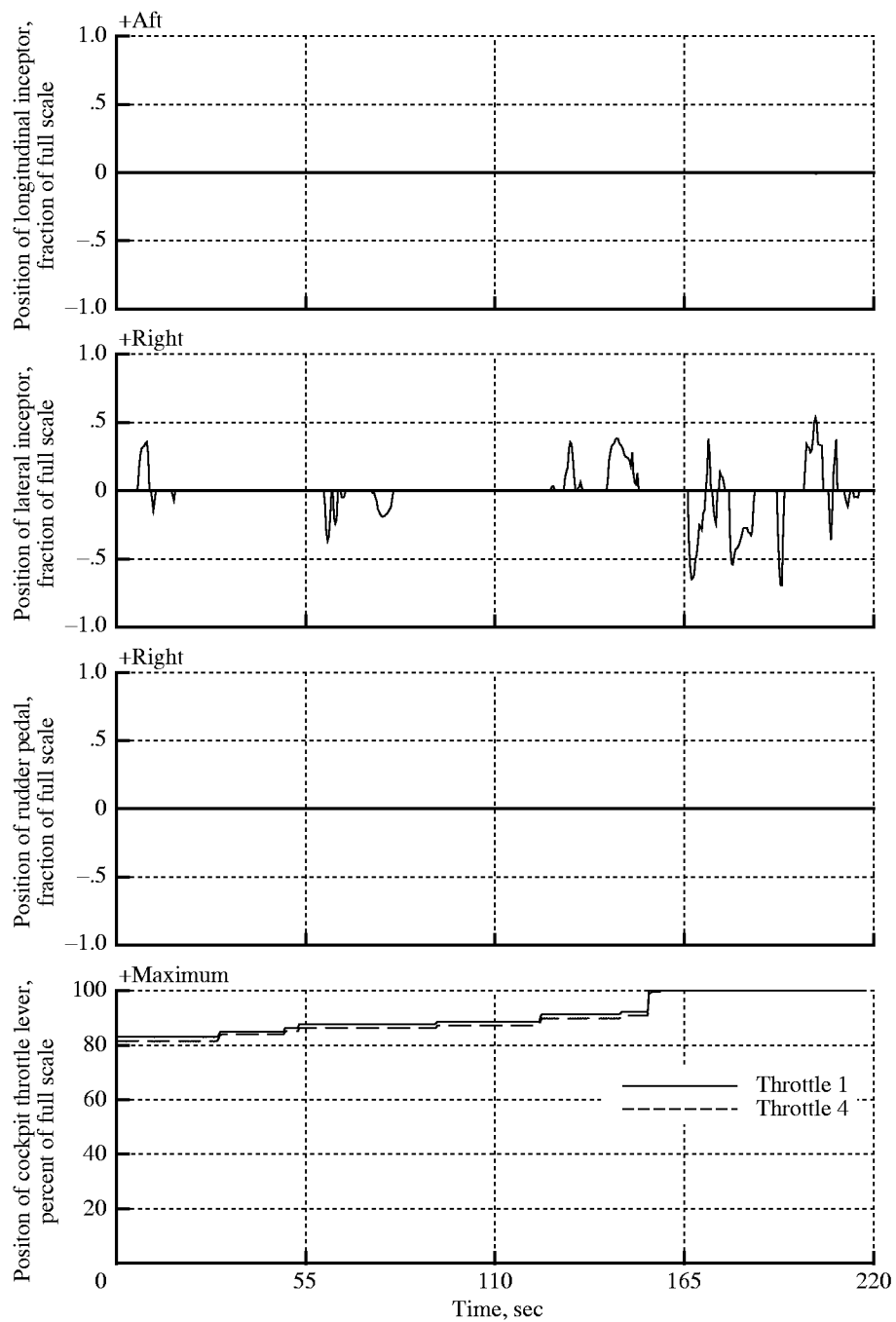

(a) Pilot controls.

Figure 80. Typical time histories for heading change in transonic climb (task 3080).

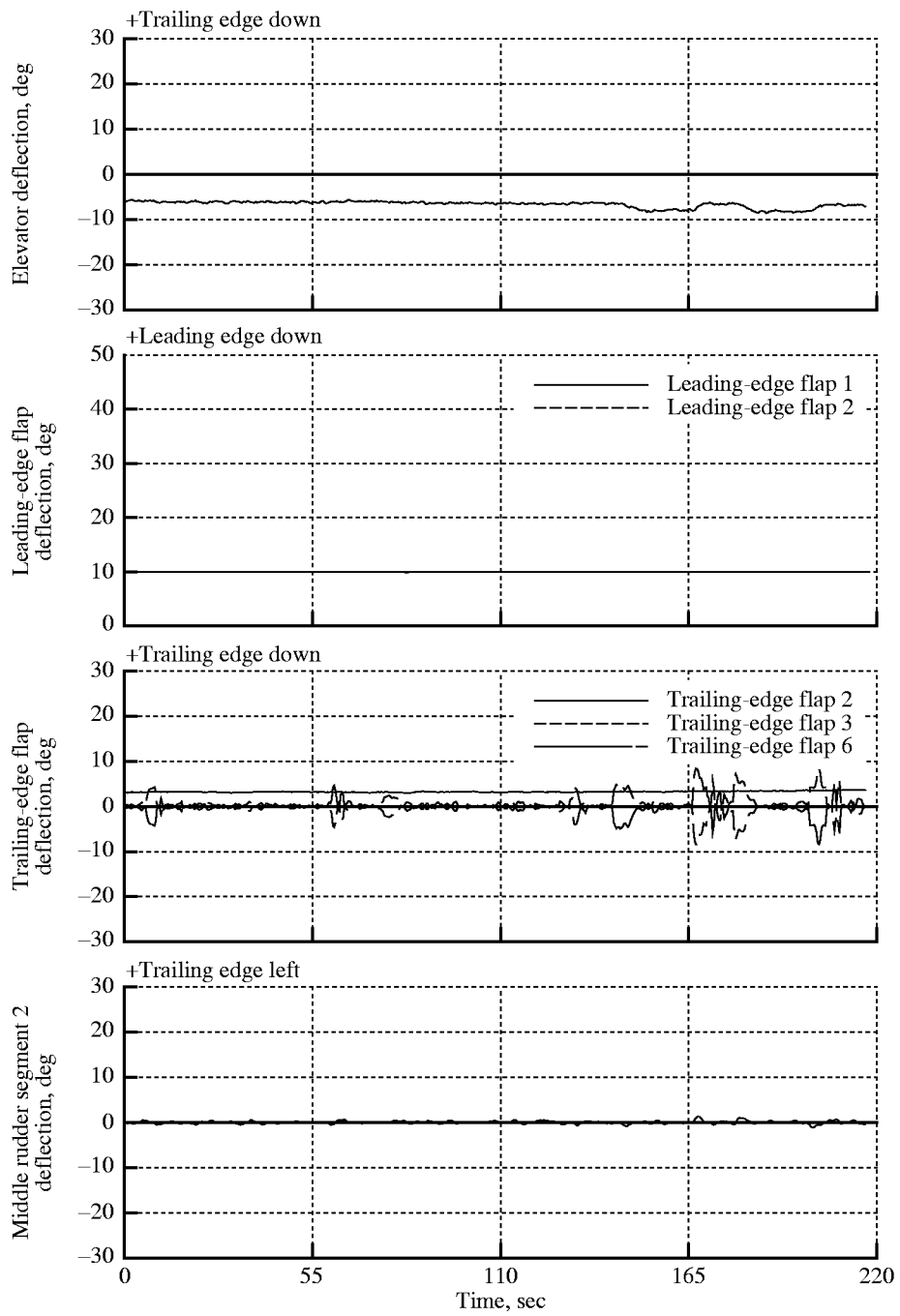

(b) Deflection of elevator; leading-edge flap segments 1 and 2; trailing-edge flap segments 2, 3, and 6; and middle rudder segment 2.

Figure 80. Continued.

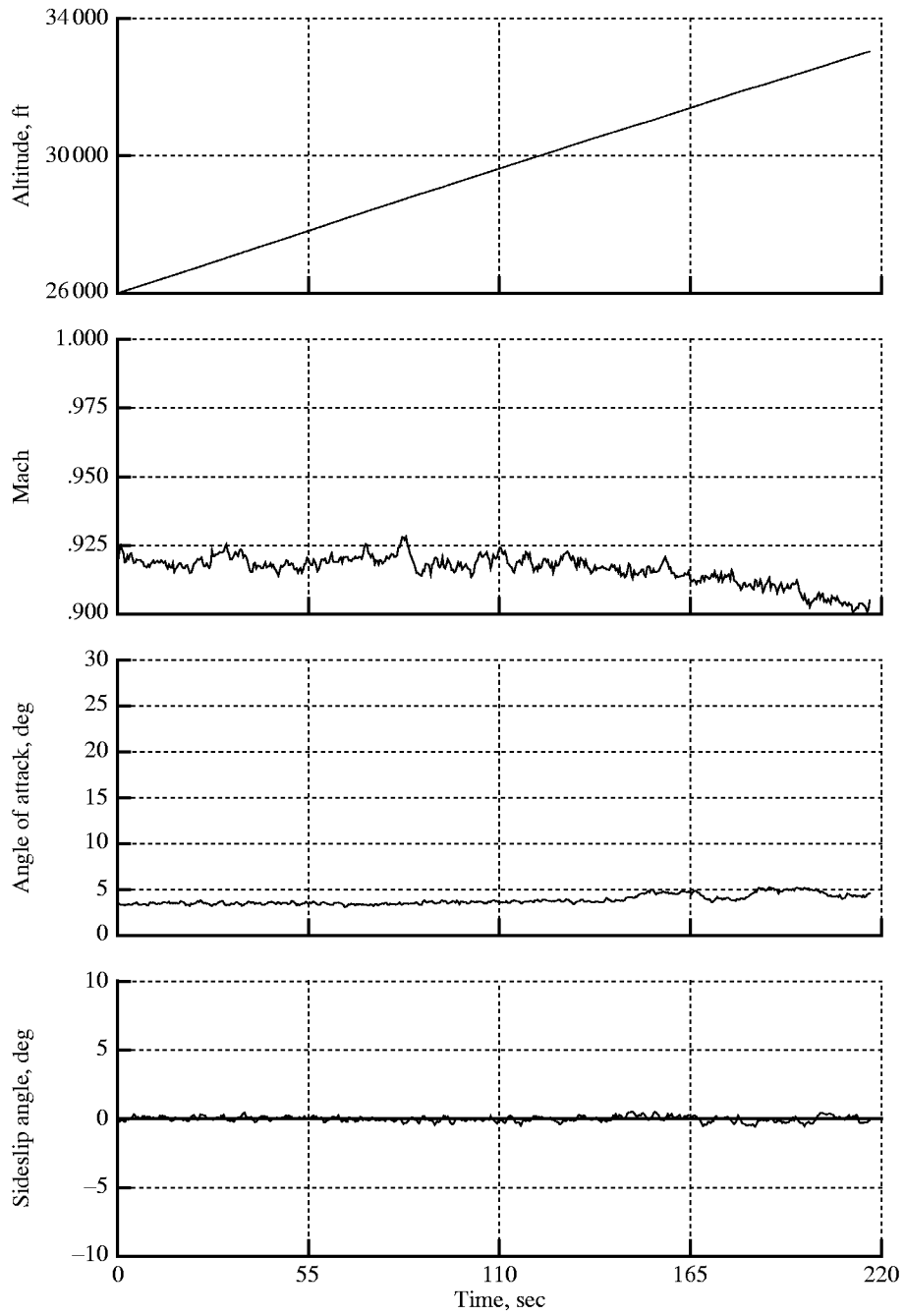

(c) Altitude, Mach, angle of attack, and sideslip angle.

Figure 80. Continued.

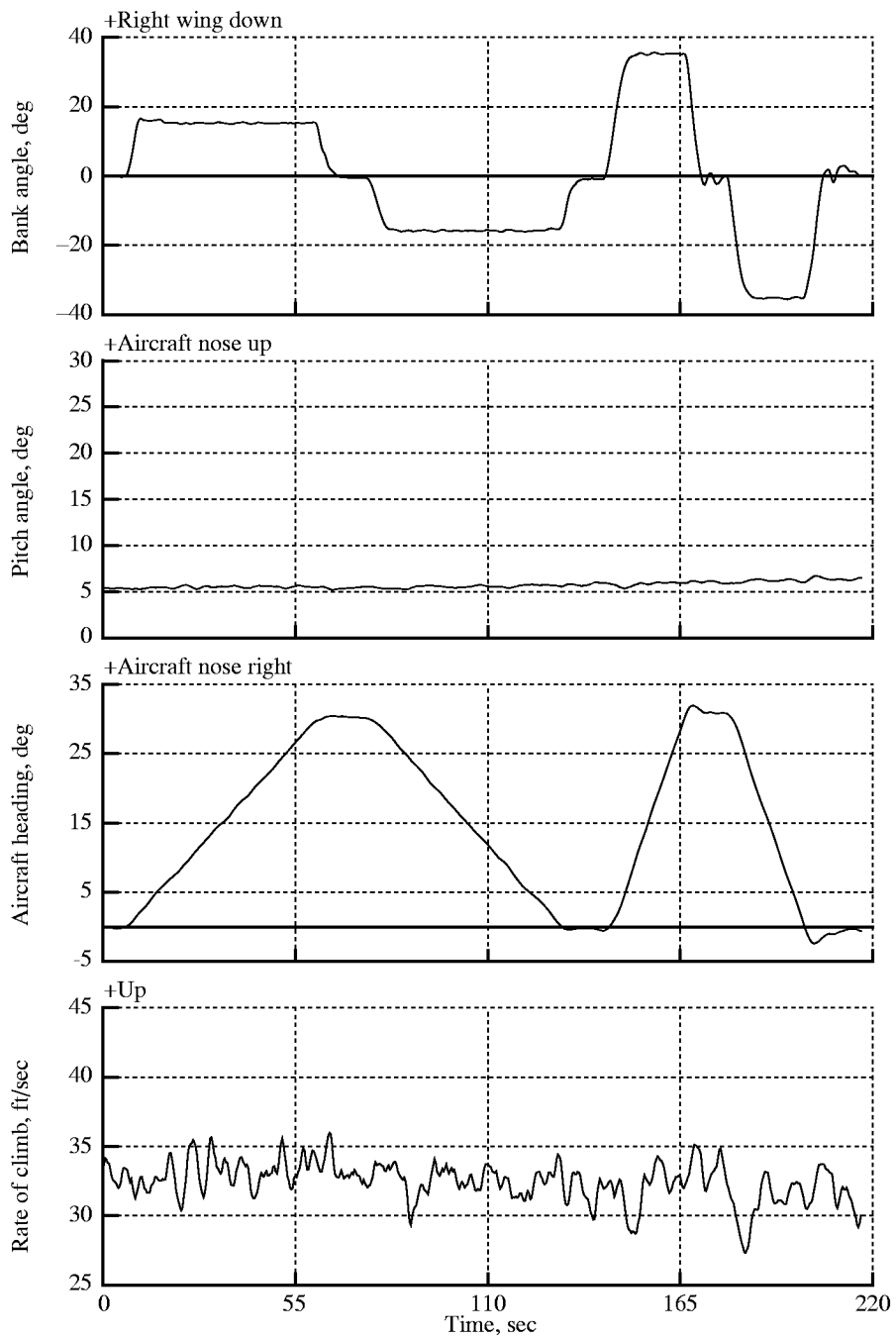

(d) Euler angles and rate of climb.

Figure 80. Continued.

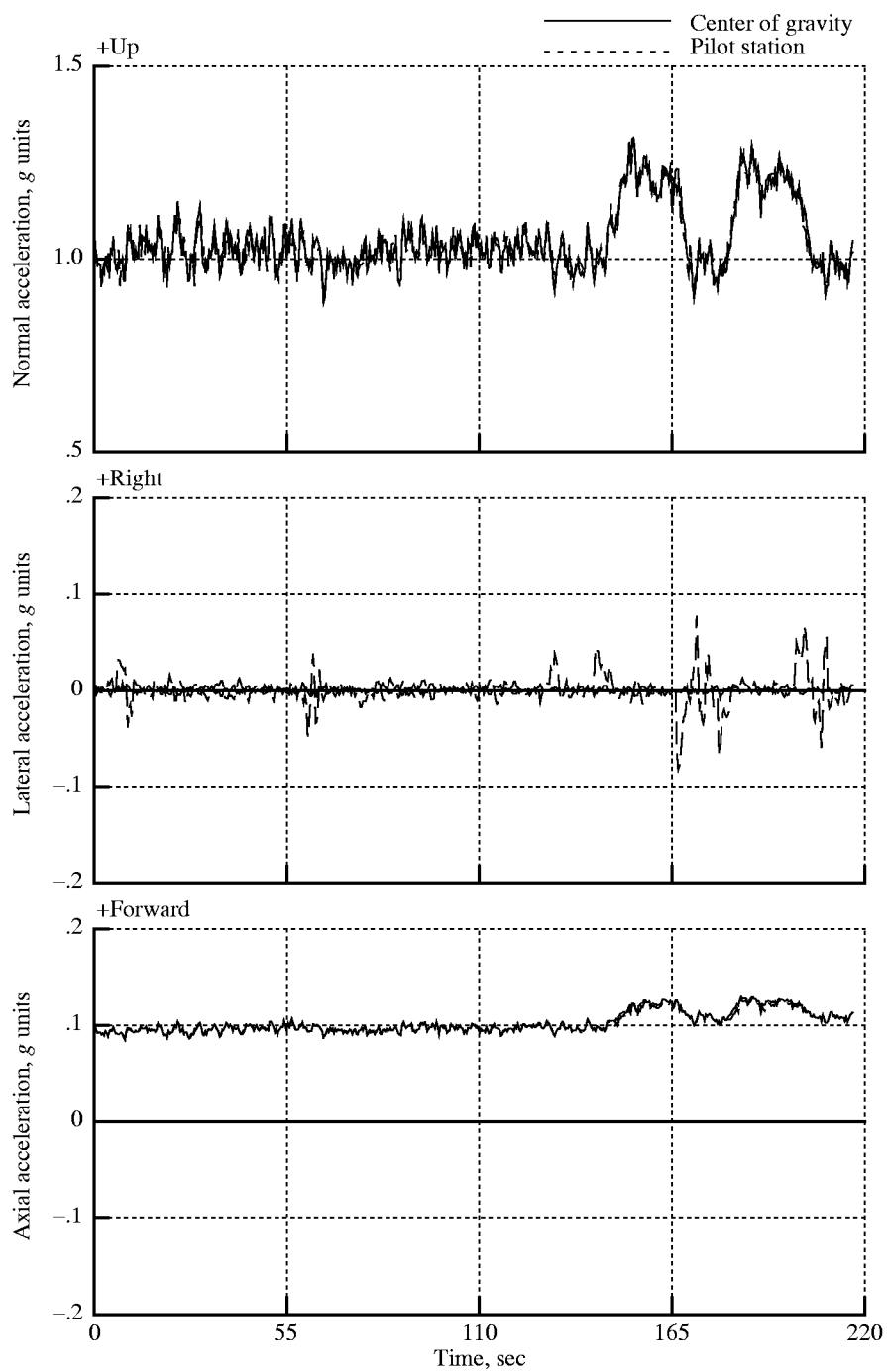

(e) Linear accelerations at center of gravity and pilot station.

Figure 80. Concluded.

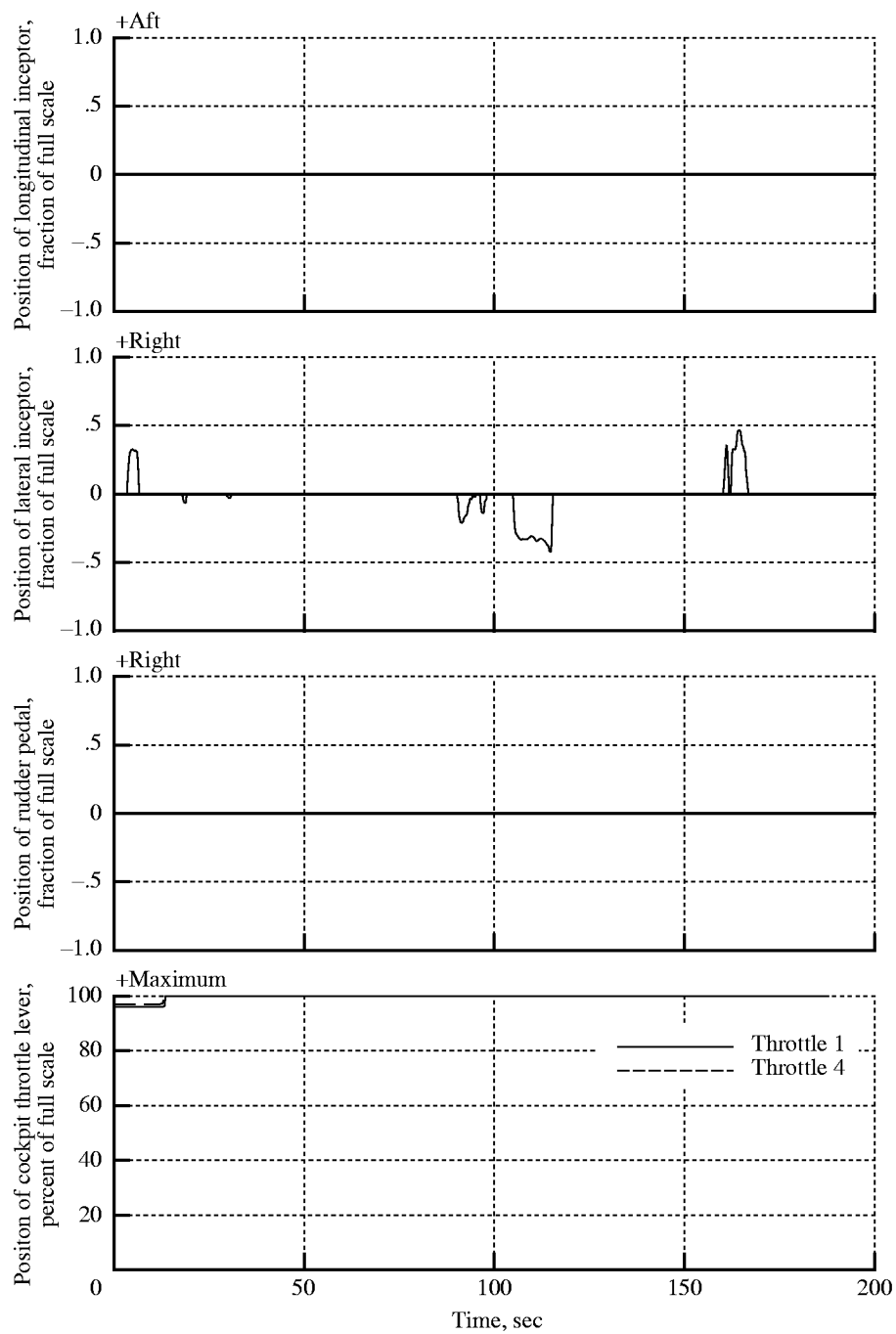

(a) Pilot controls.

Figure 81. Typical time histories for heading change in supersonic cruise (task 3084).

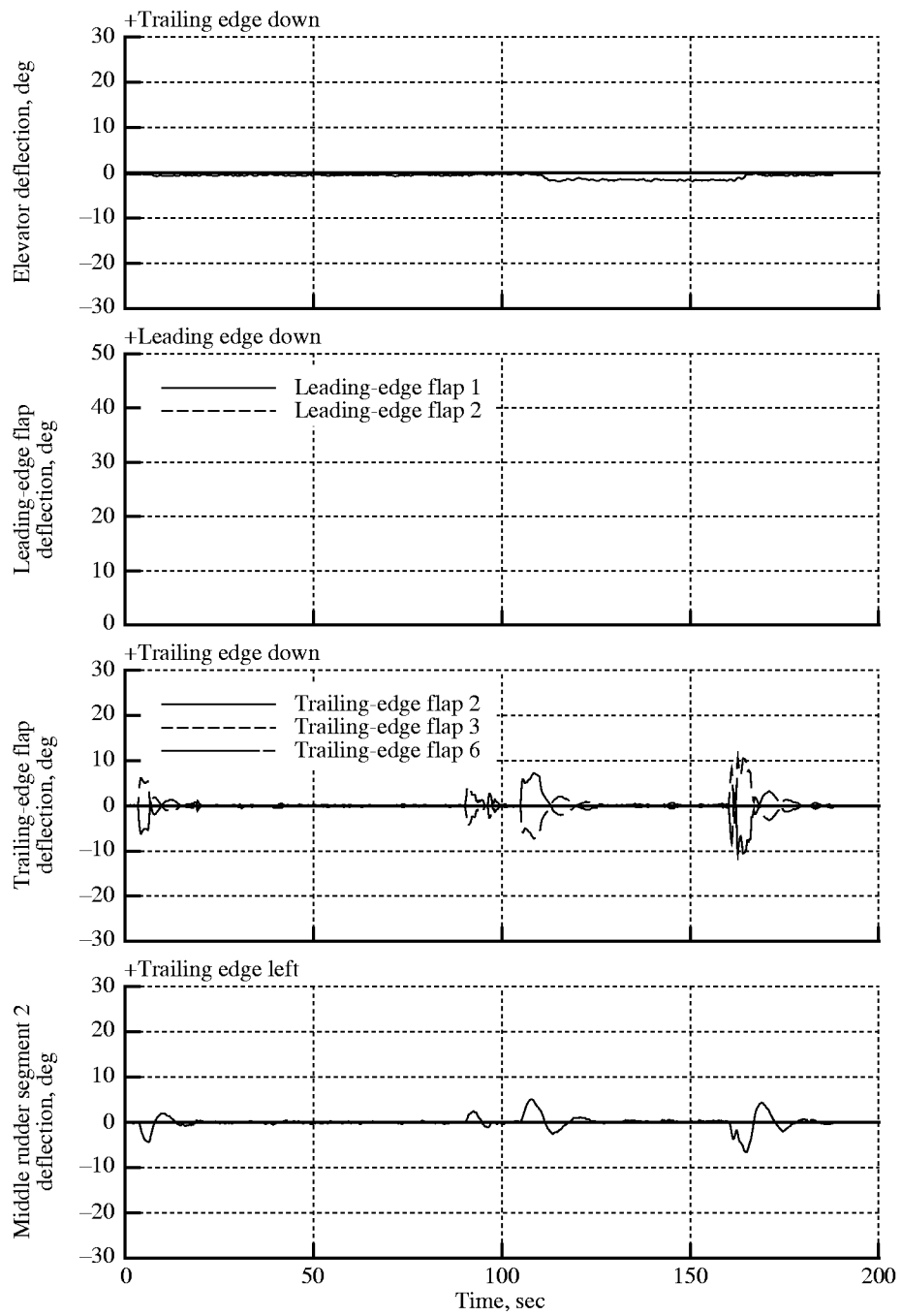

(b) Deflection of elevator; leading-edge flap segments 1 and 2; trailing-edge flap segments 2, 3, and 6; and middle rudder segment 2.

Figure 81. Continued.

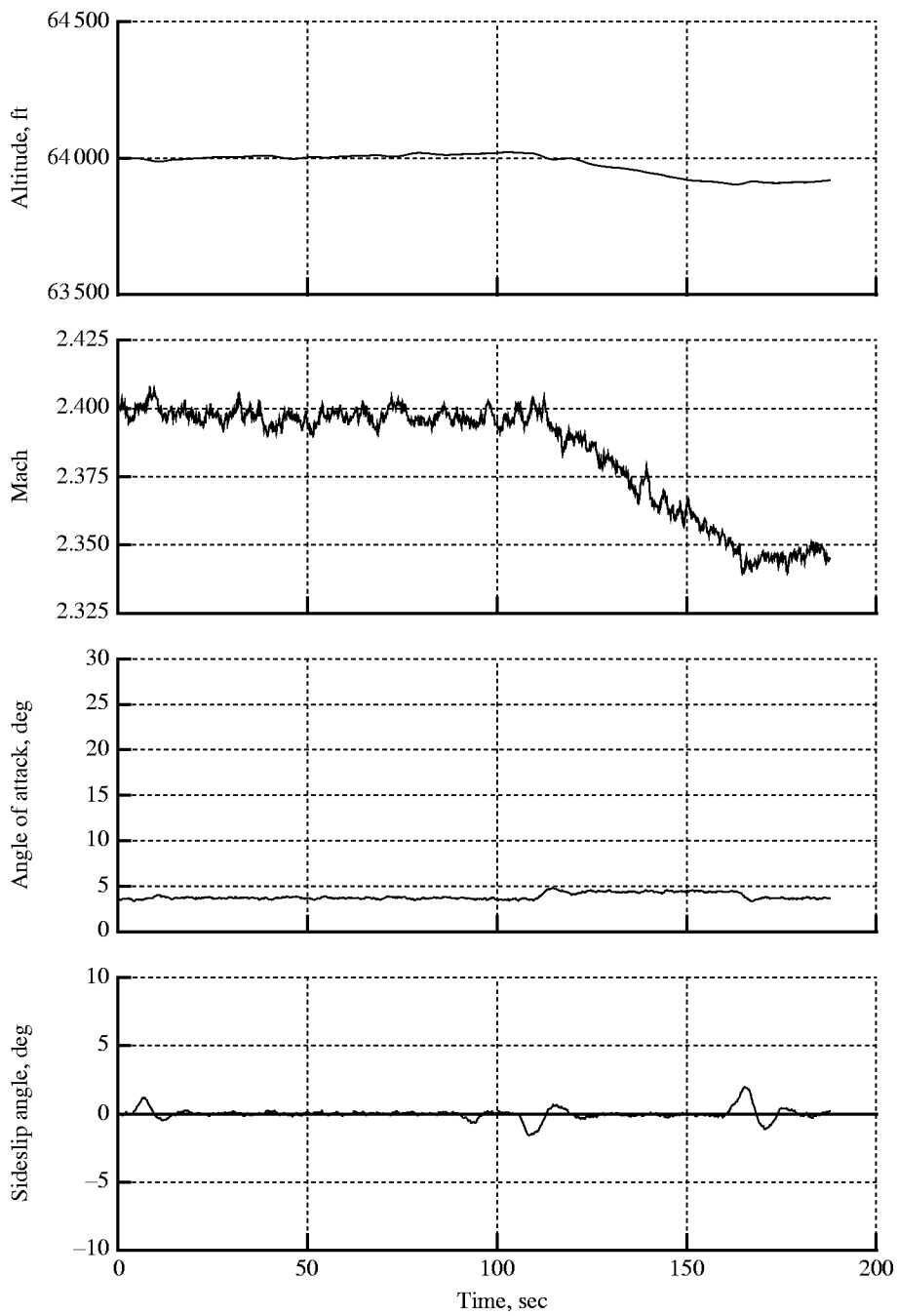

(c) Altitude, Mach, angle of attack, and sideslip angle.

Figure 81. Continued.

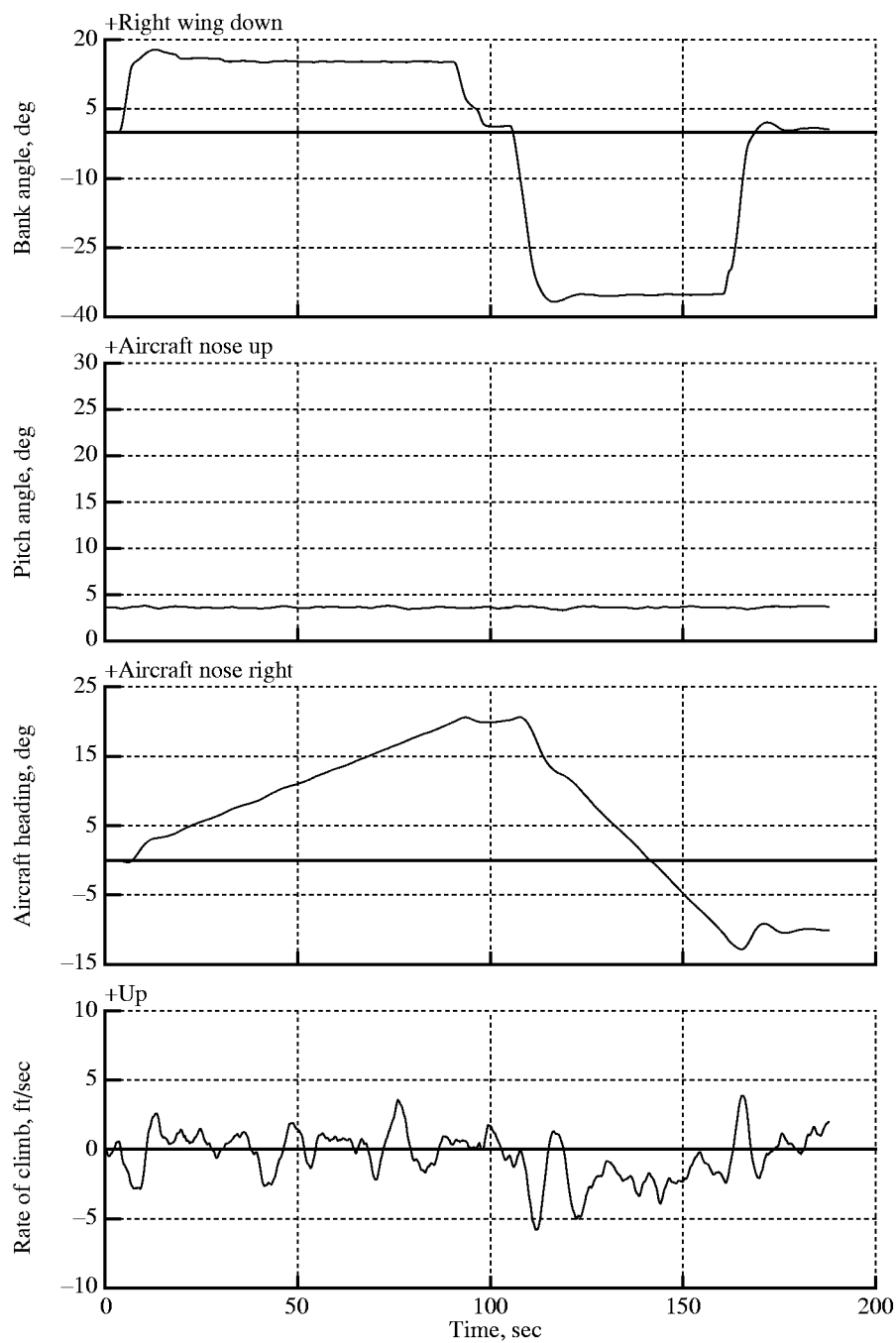

(d) Euler angles and rate of climb.

Figure 81. Continued.

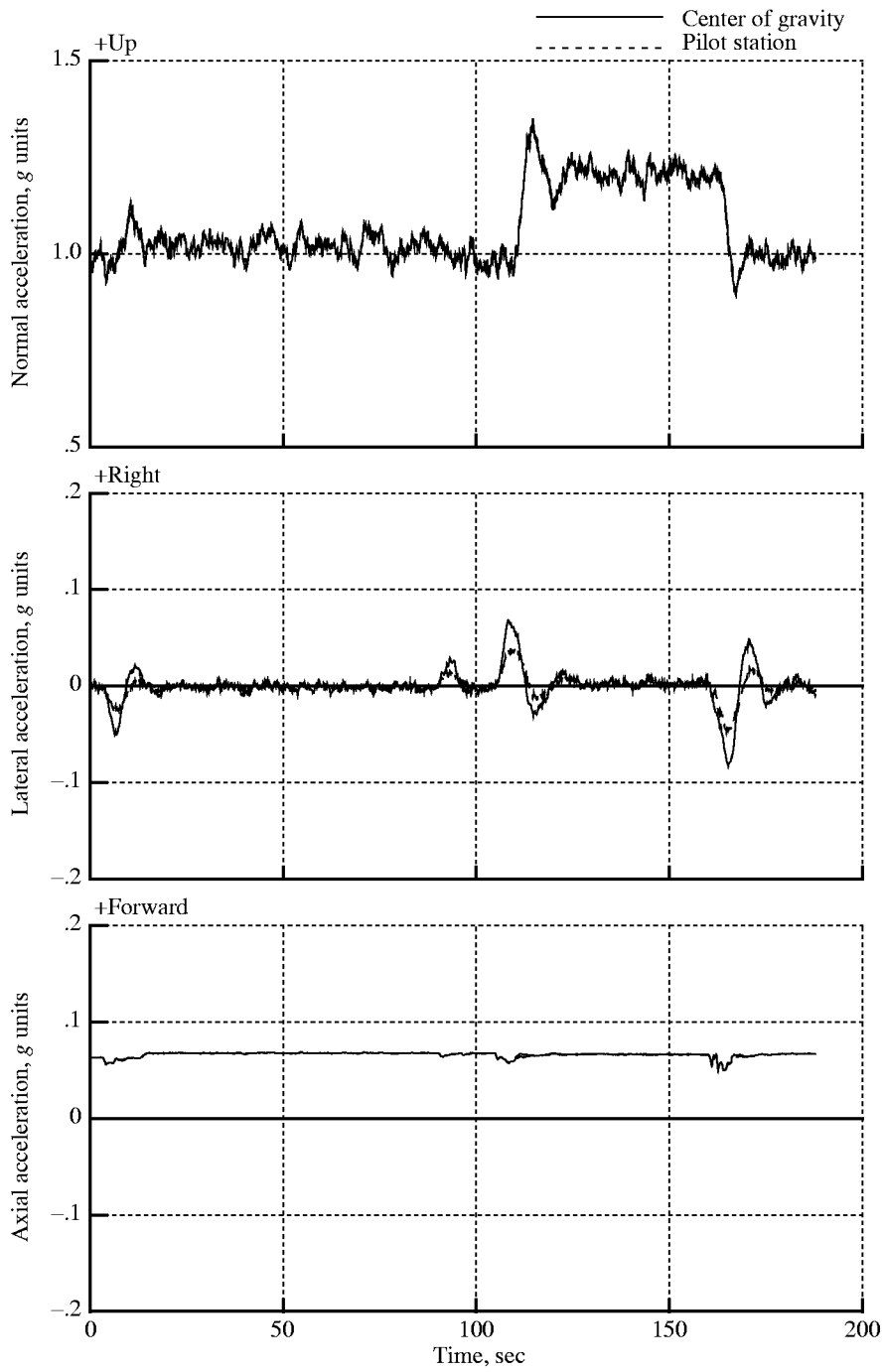

(e) Linear accelerations at center of gravity and pilot station.

Figure 81. Concluded.

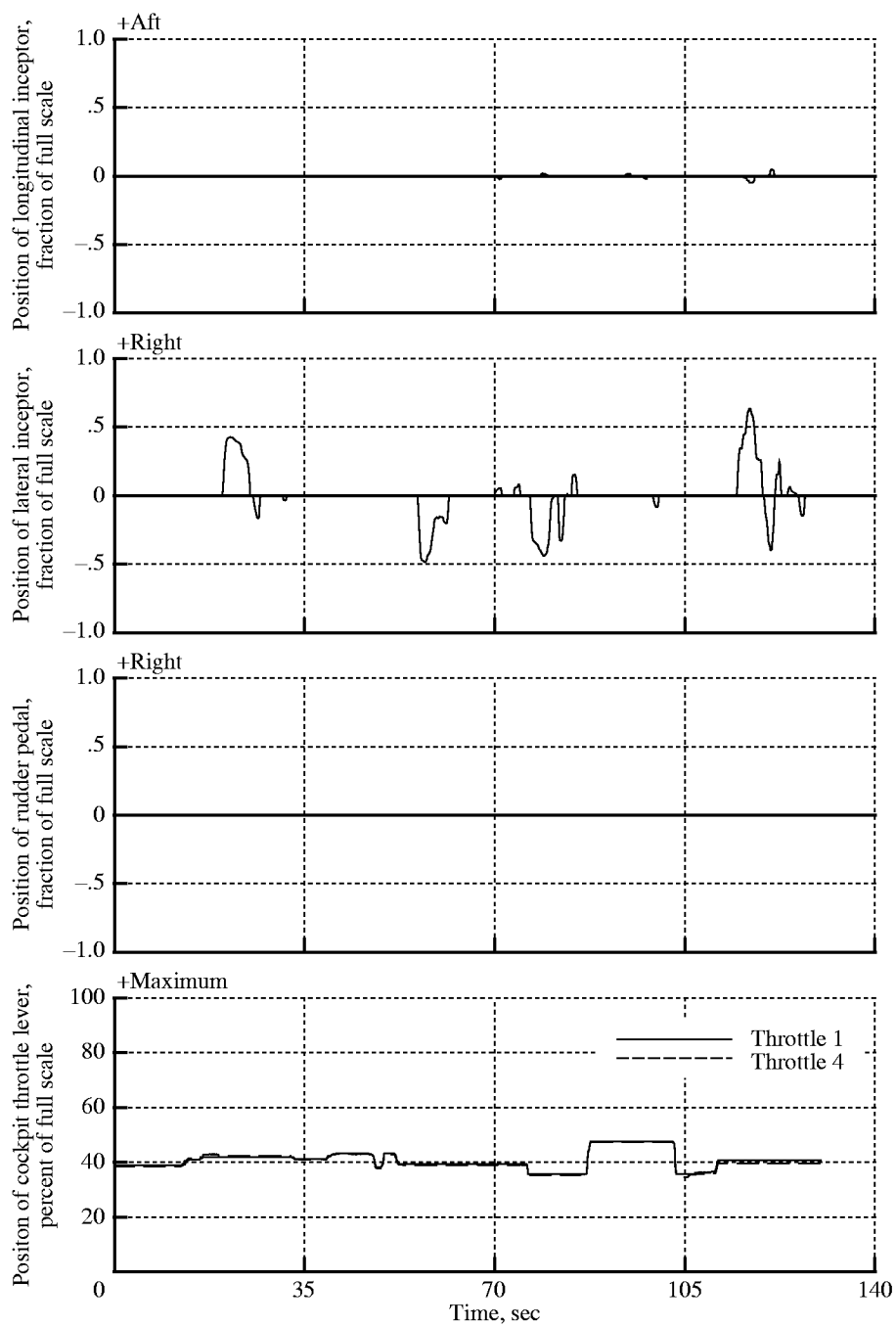

(a) Pilot controls.

Figure 82. Typical time histories for heading change in transonic descent maneuver (task 3086) for Pilot E.

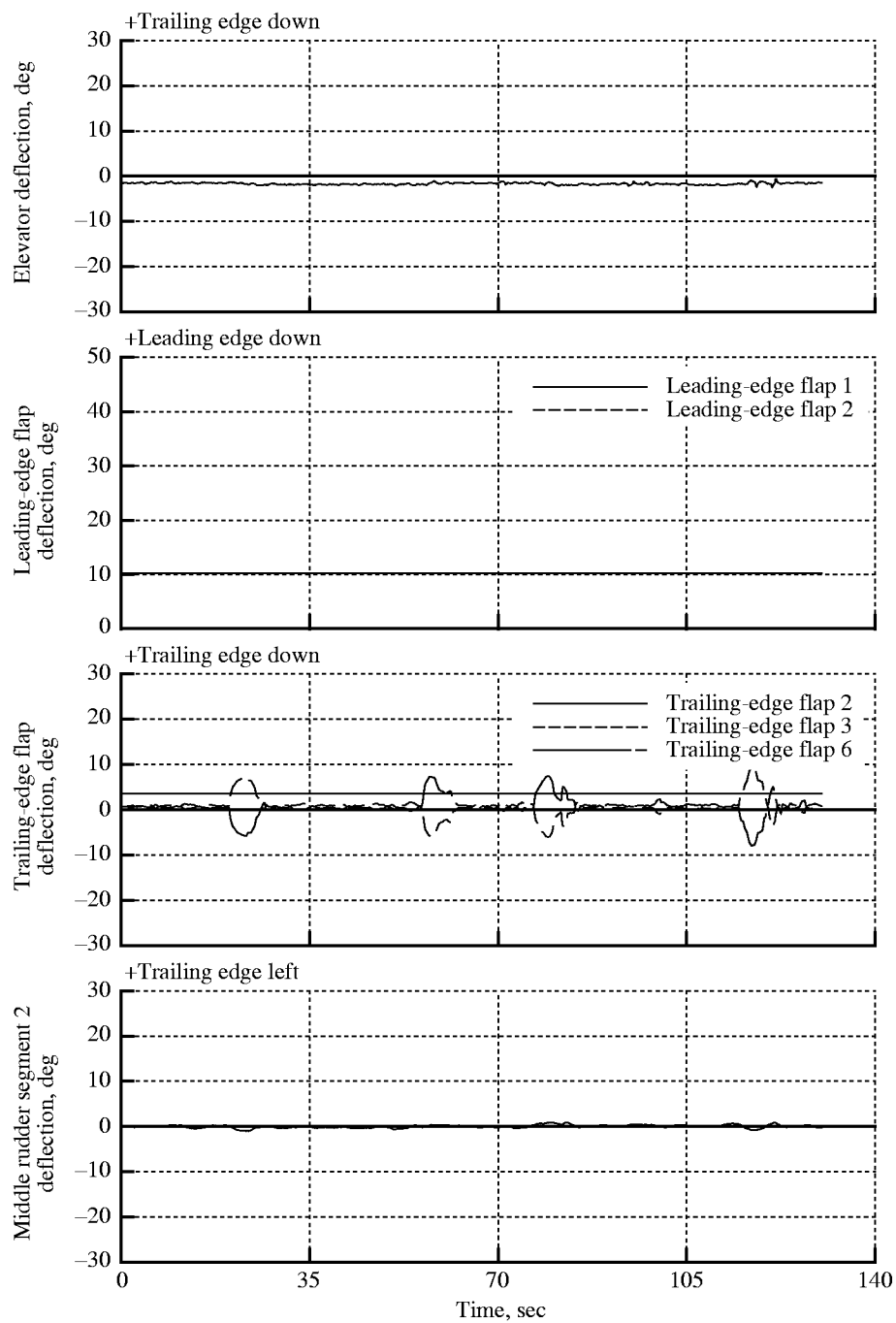

(b) Deflection of elevator; leading-edge flap segments 1 and 2; trailing-edge flap segments 2, 3, and 6; and middle rudder segment 2.

Figure 82. Continued.

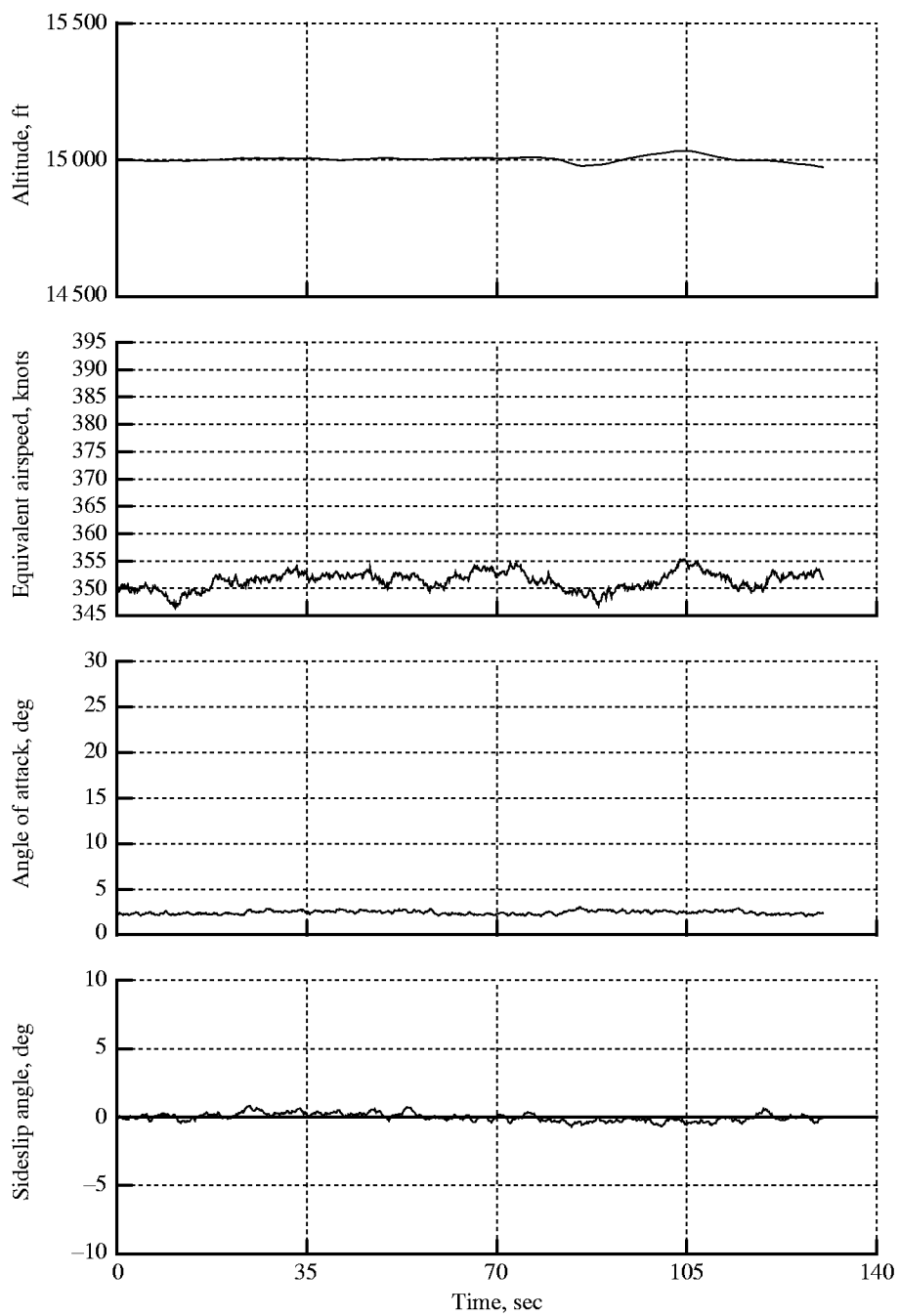

(c) Altitude, equivalent airspeed, angle of attack, and sideslip angle.

Figure 82. Continued.

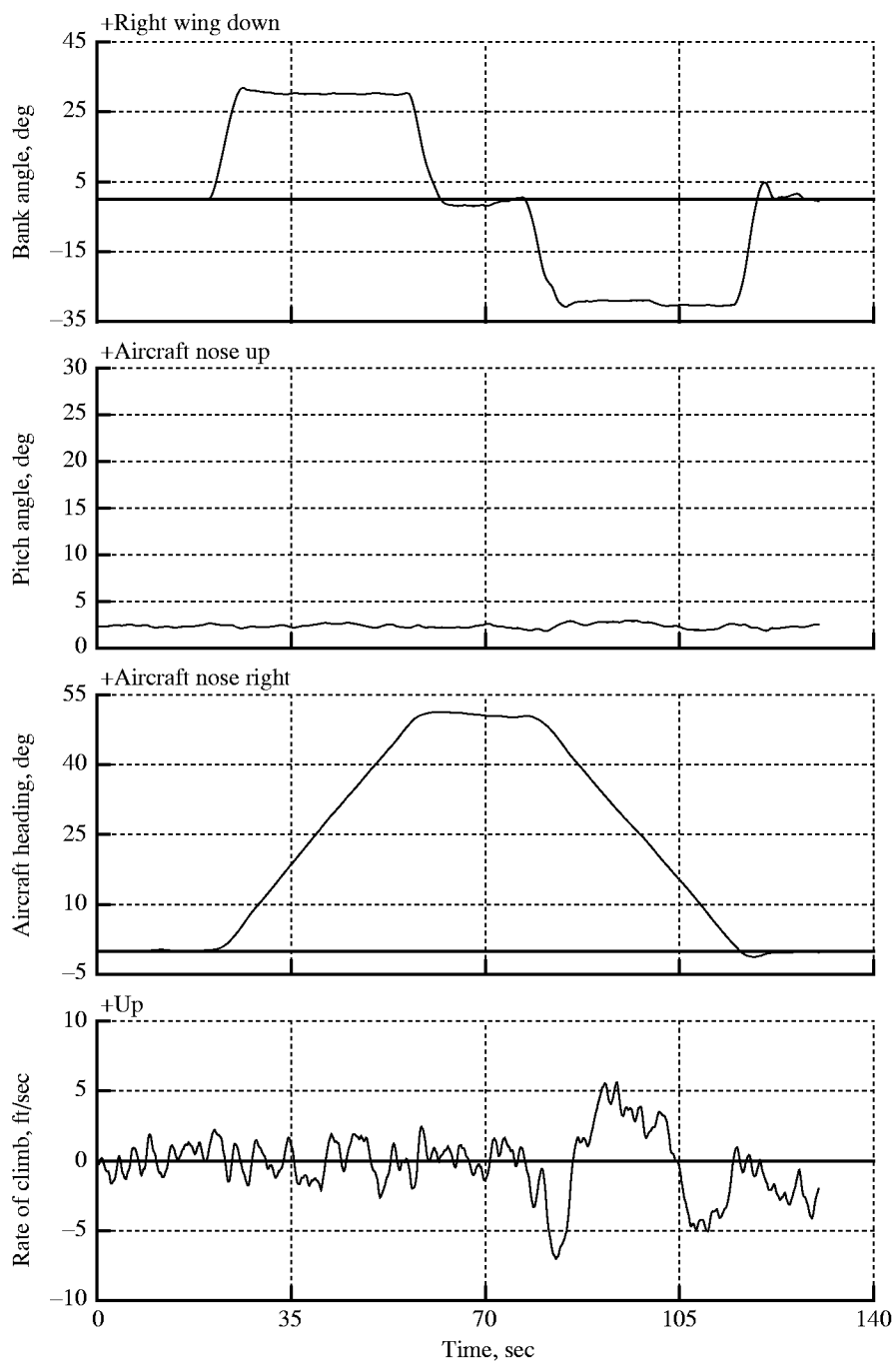

(d) Euler angles and rate of climb.

Figure 82. Continued.

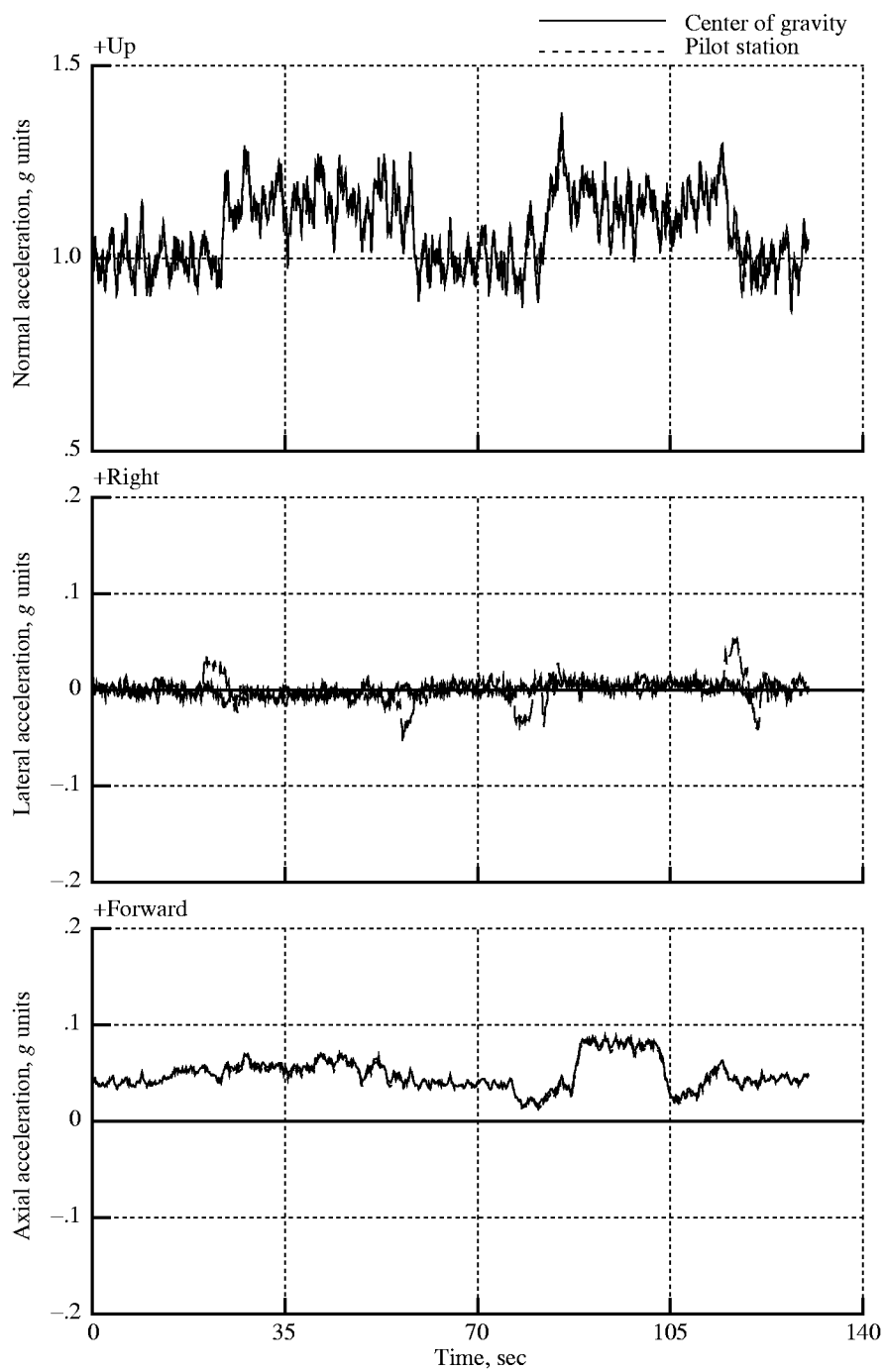

(e) Linear accelerations at center of gravity and pilot station.

Figure 82. Concluded.

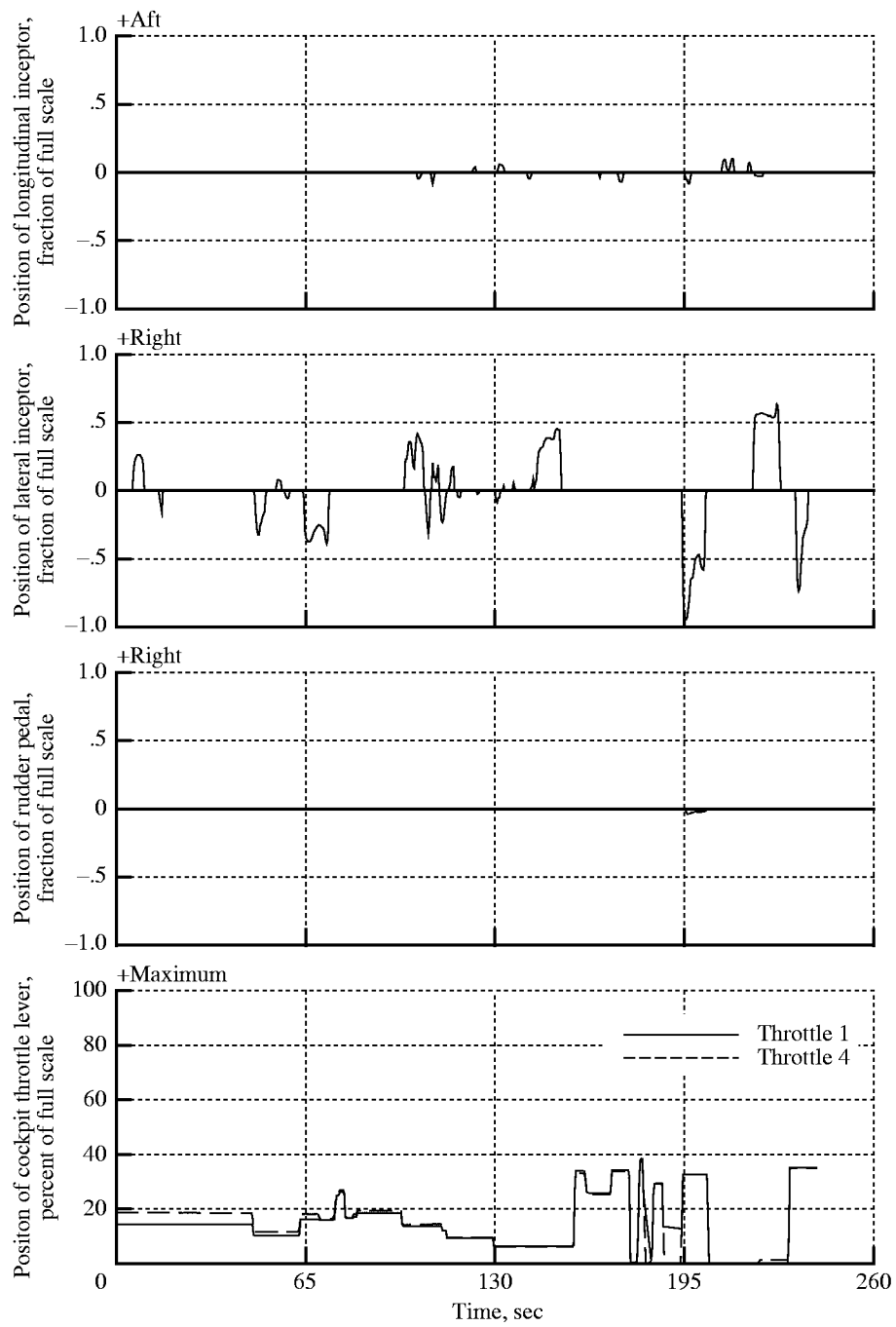

(a) Pilot controls.

Figure 83. Typical time histories for heading change in TCA descent maneuver (task 3088).

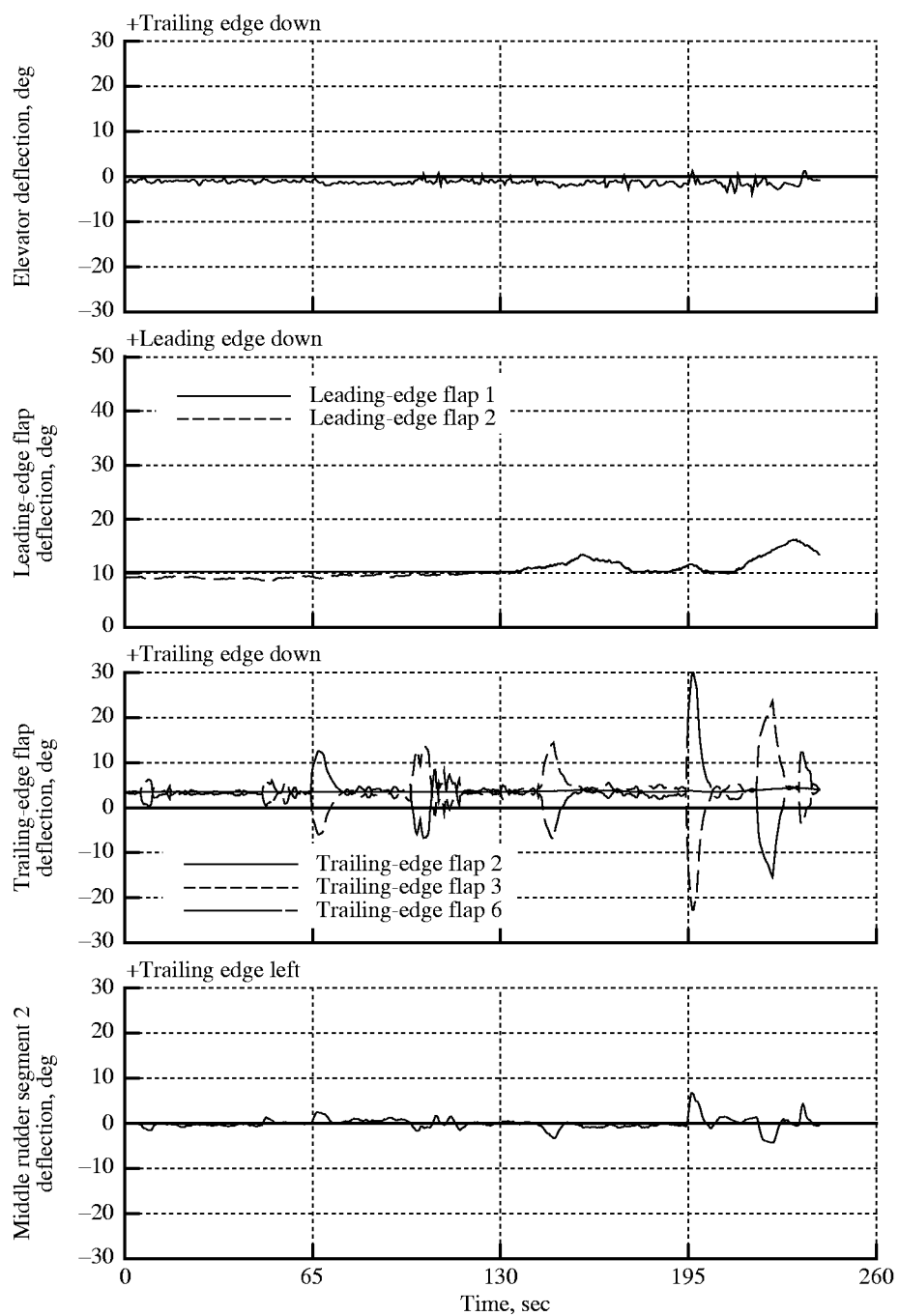

(b) Deflection of elevator; leading-edge flap segments 1 and 2; trailing-edge flap segments 2, 3, and 6; and middle rudder segment 2.

Figure 83. Continued.

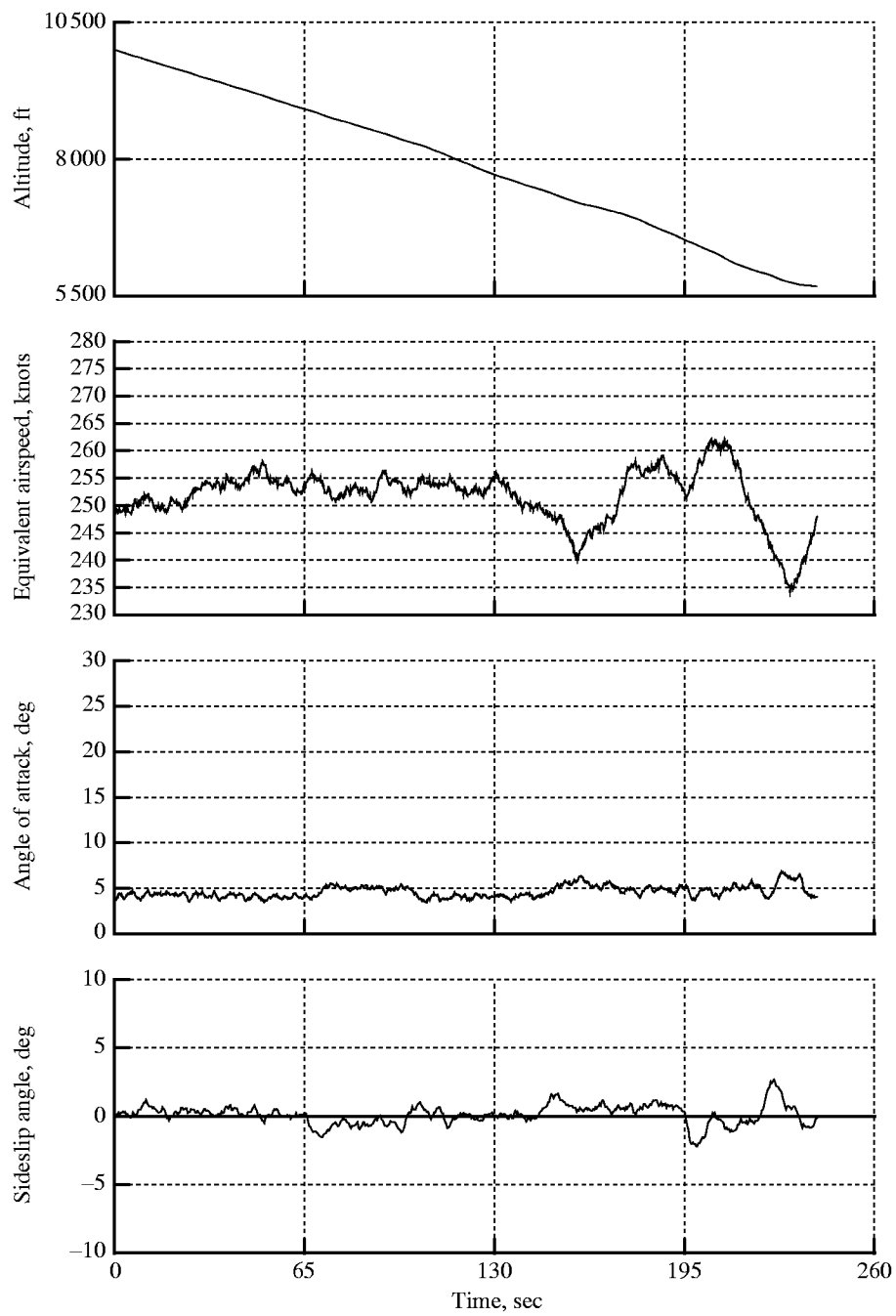

(c) Altitude, equivalent airspeed, angle of attack, and sideslip angle.

Figure 83. Continued.

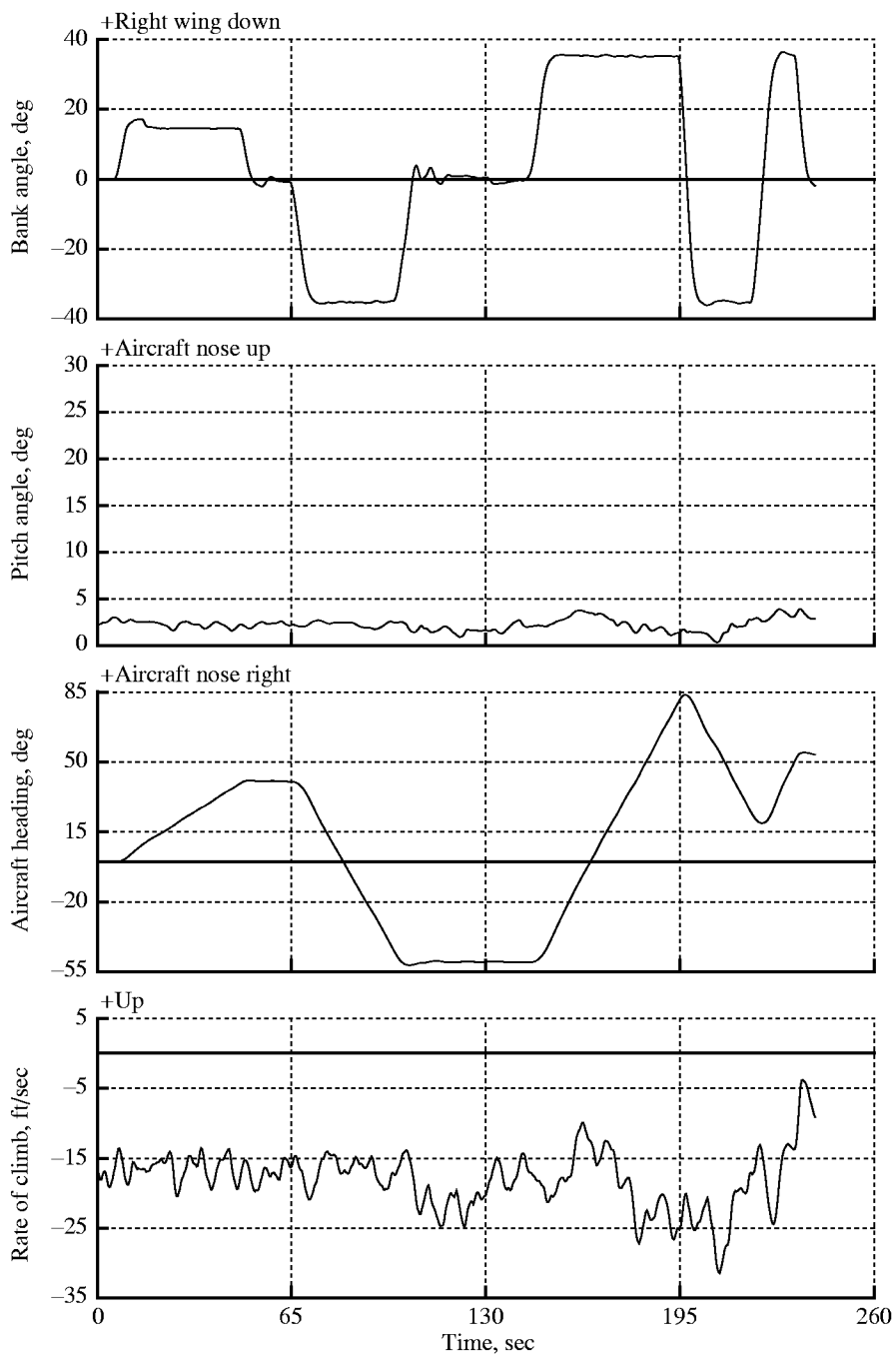

(d) Euler angles and rate of climb.

Figure 83. Continued.

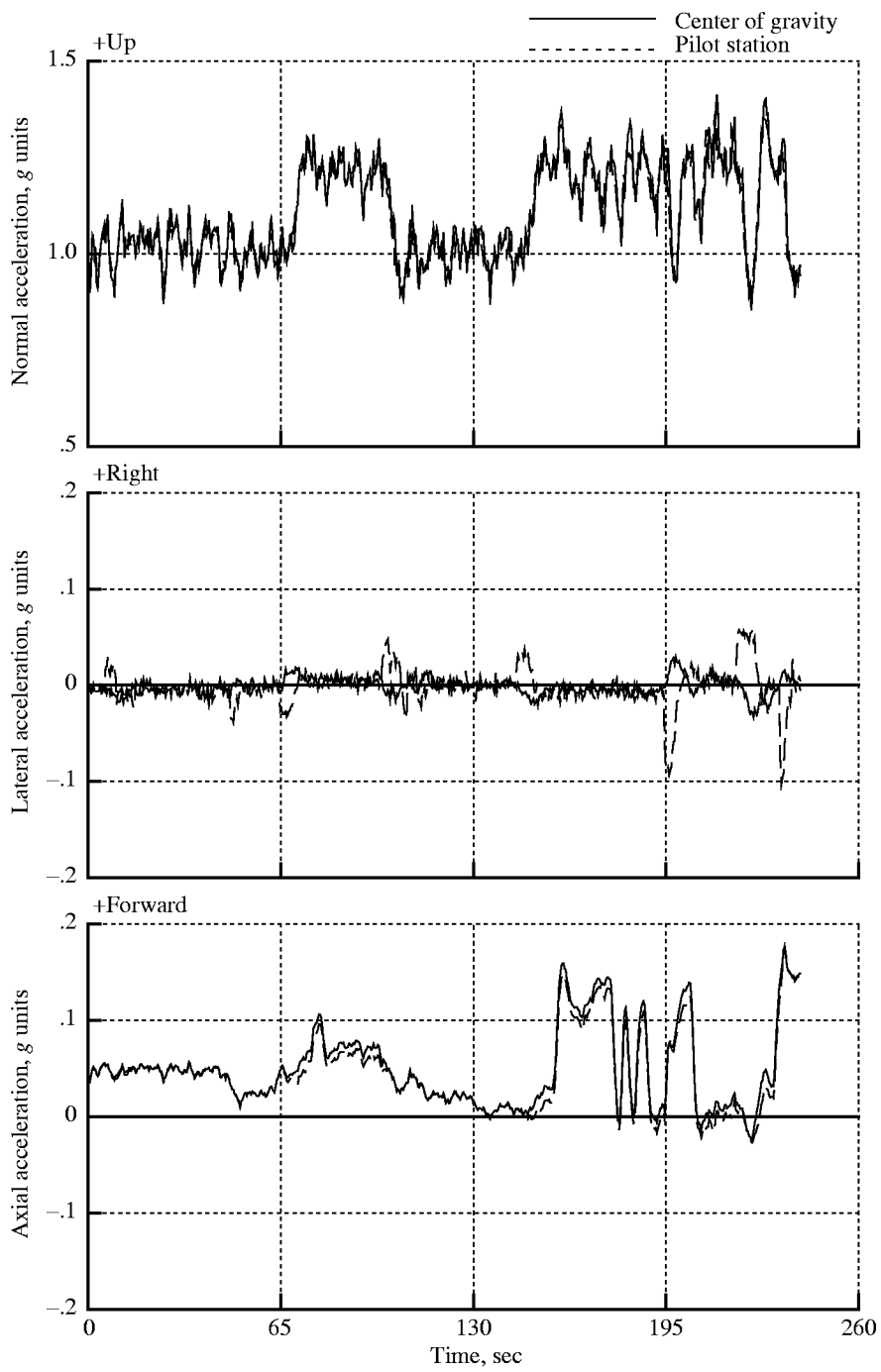

(e) Linear accelerations at center of gravity and pilot station.

Figure 83. Concluded.

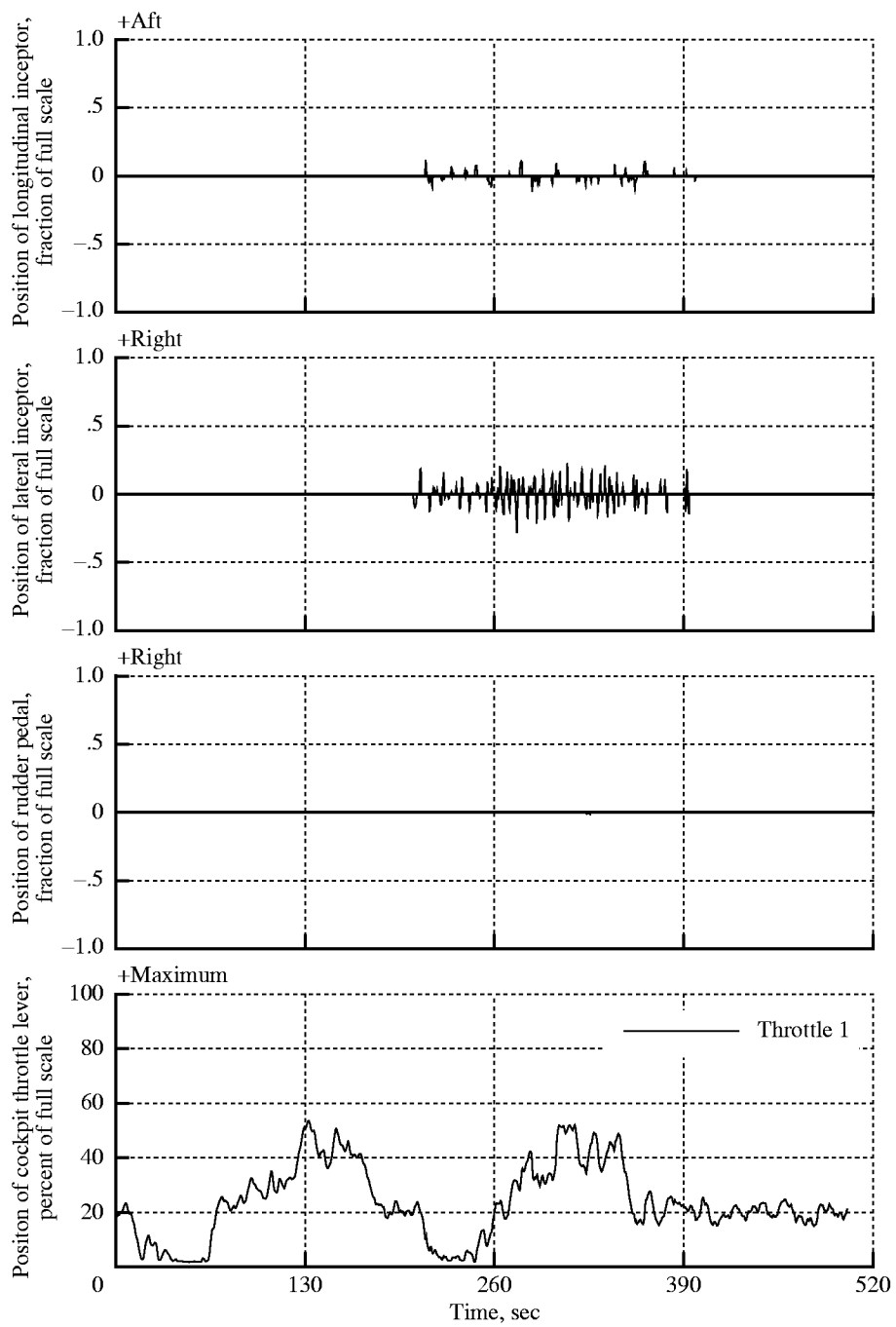

(a) Pilot controls.

Figure 84. Typical time histories for configuration change in moderate turbulence maneuver (task 4012) for Pilot E.

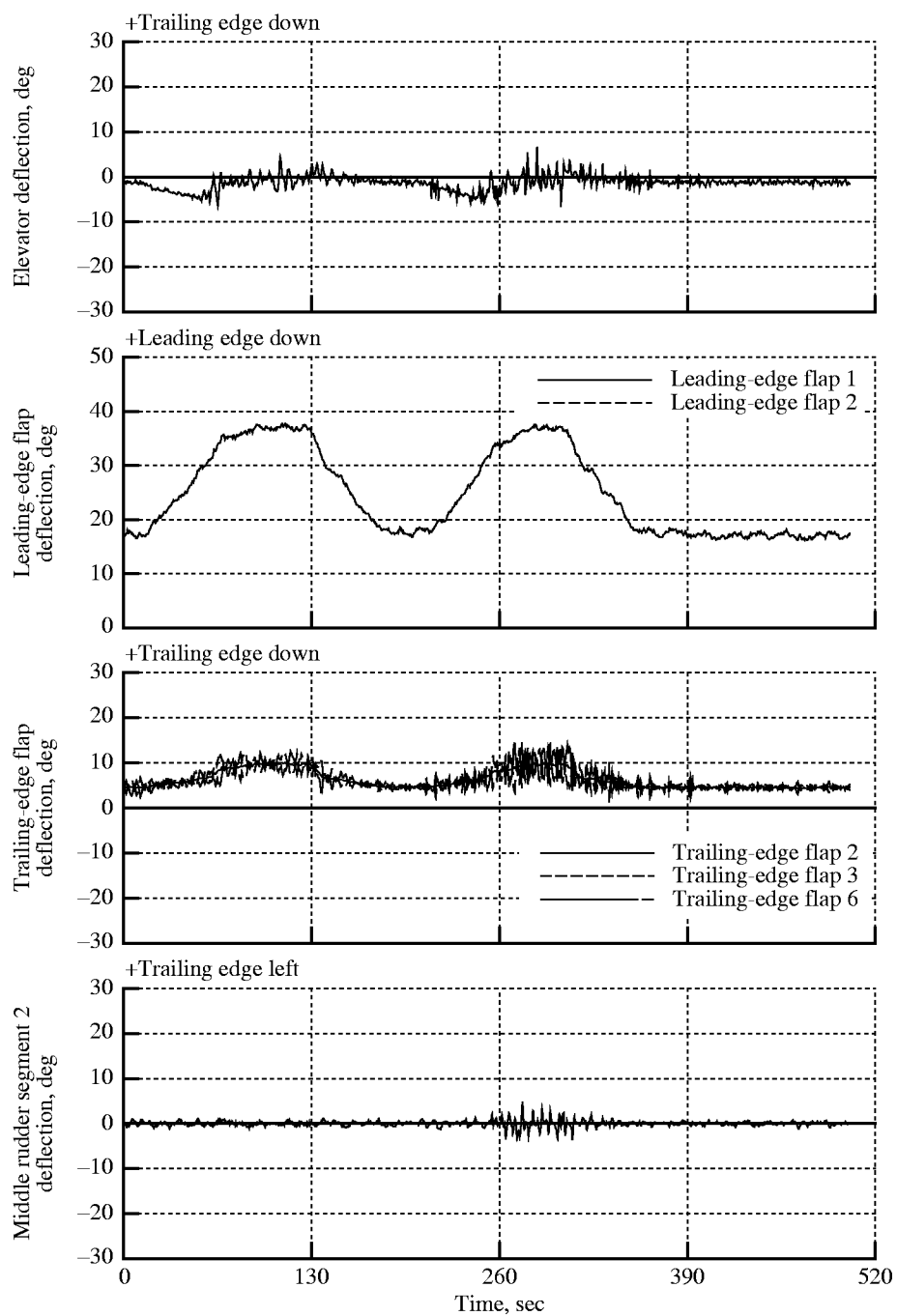

(b) Deflection of elevator; leading-edge flap segments 1 and 2; trailing-edge flap segments 2, 3, and 6; and middle rudder segment 2.

Figure 84. Continued.

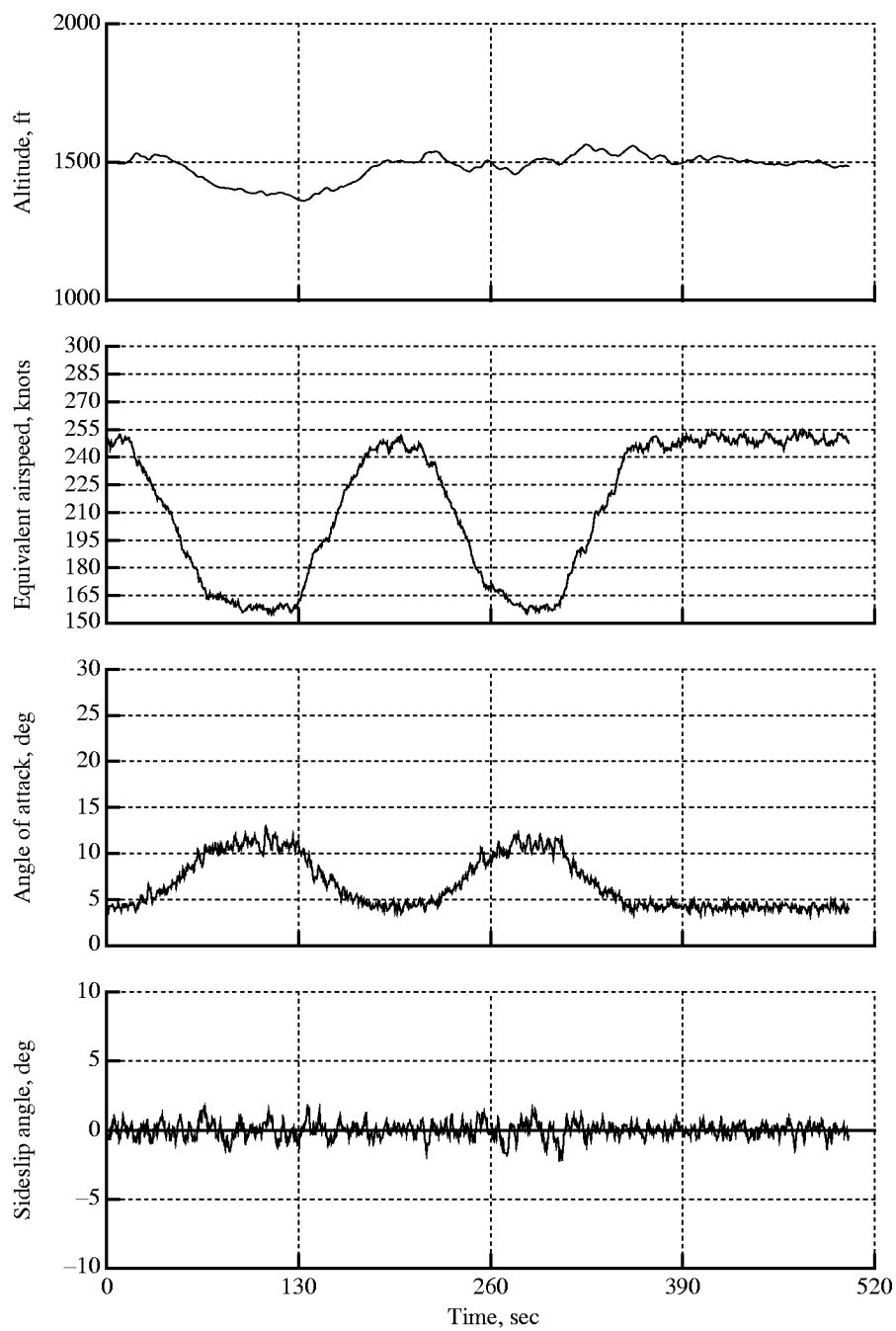

(c) Altitude, equivalent airspeed, angle of attack, and sideslip angle.

Figure 84. Continued.

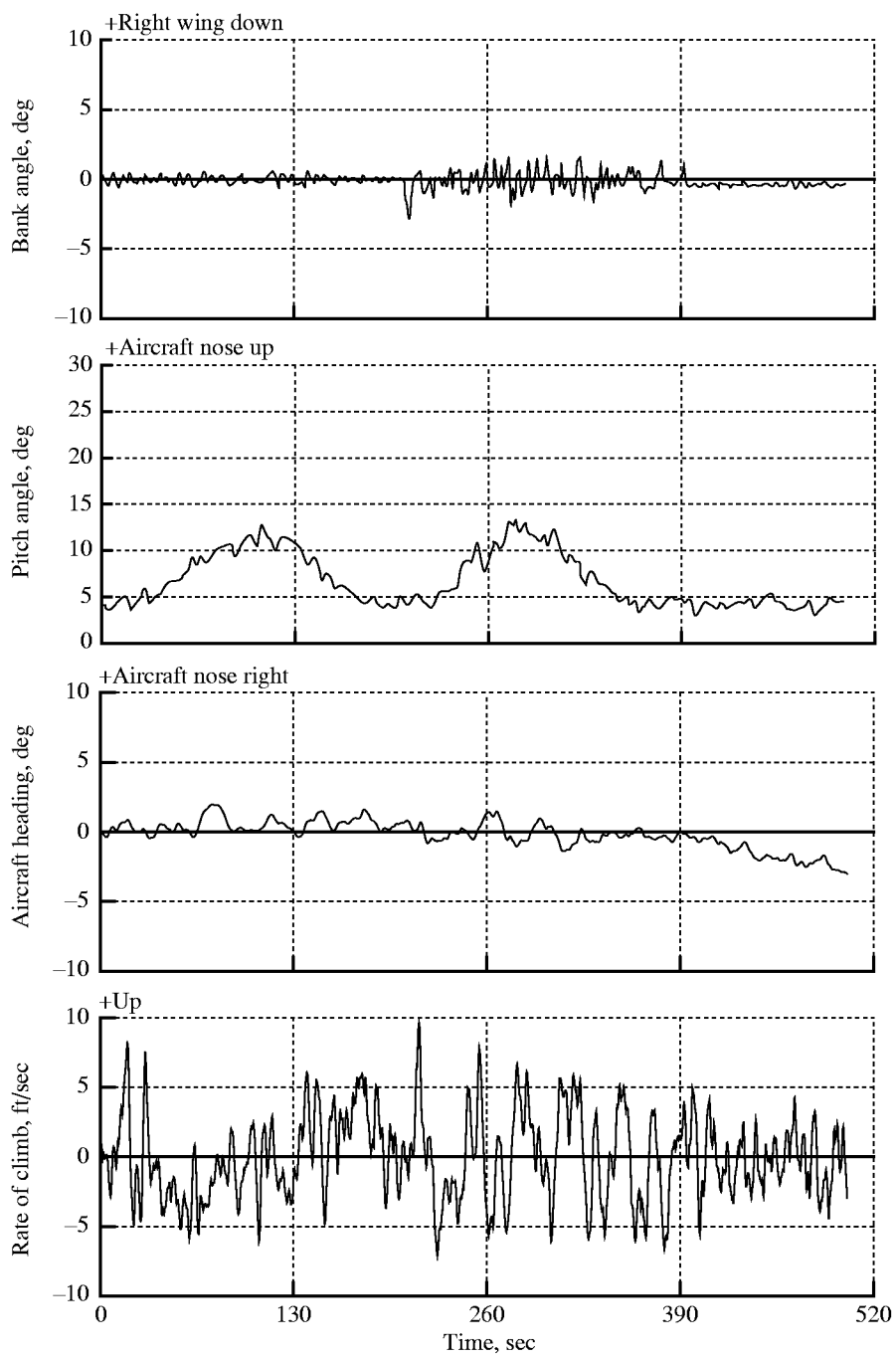

(d) Euler angles and rate of climb.

Figure 84. Continued.

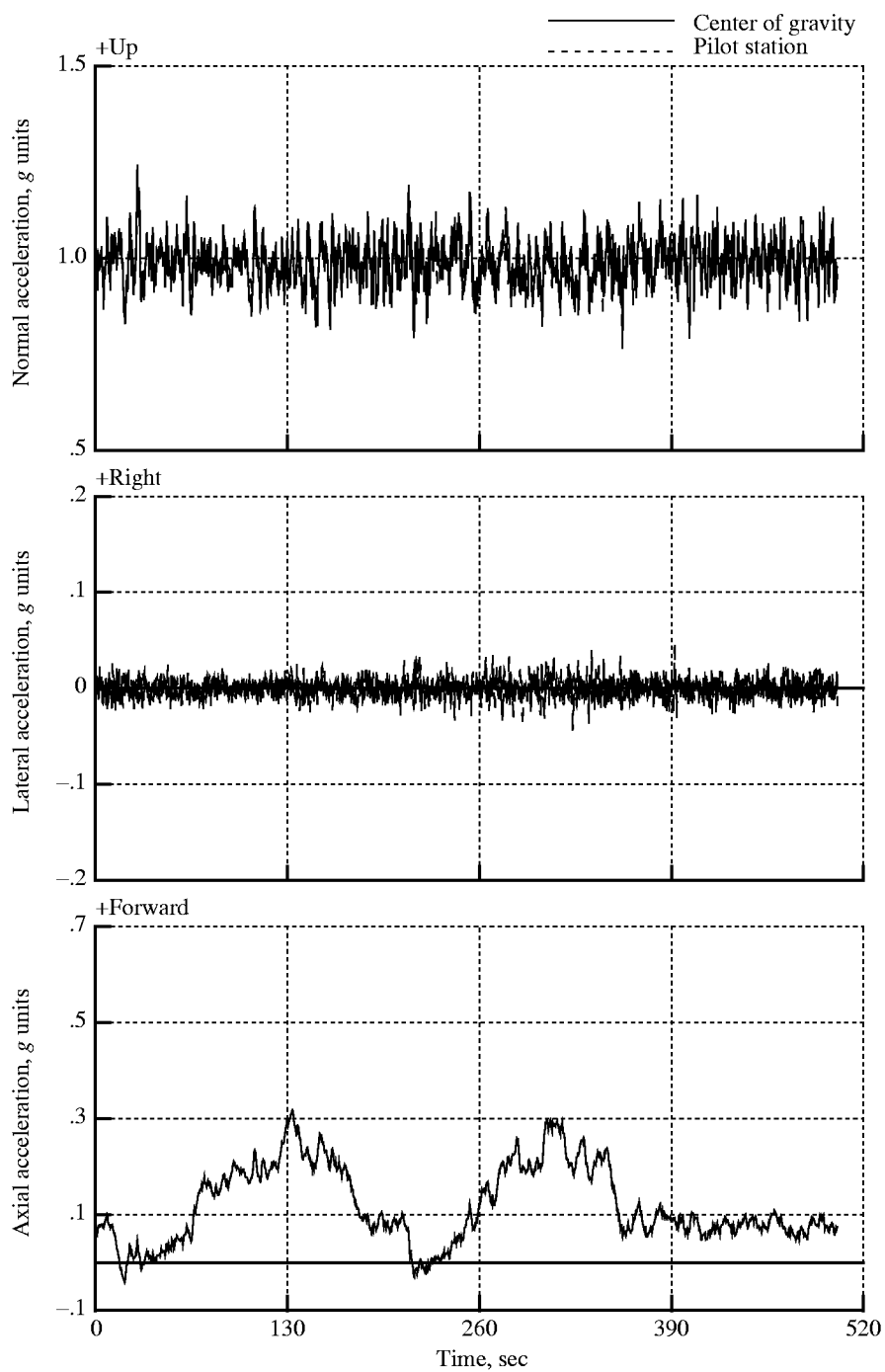

(e) Linear accelerations at center of gravity and pilot station.

Figure 84. Concluded.

Appendix A

Description of Control Laws Used in Piloted Reference-H Assessment

Symbols and Abbreviations

CHR	Cooper-Harper rating
DCPILOT	pitch stick input of pilot
DELTFD	time required for FADER signal to make transition between 1 and 0 or 0 and 1
FADER	signal that varies between 1 and 0 to provide smooth mode transition
HUD	heads up display
h	altitude
ILS	Instrument Landing System
ITGA	integrator used in Boeing $\dot{\gamma}/V$ control law
K_{ccgn}	gain used in flap reconfiguration thrust compensation system
K_{ccvrl}	rate limit employed in flap reconfiguration thrust compensation system
K_{ei}	gain used in Boeing $\dot{\gamma}/V$ control law
K_{pfwd}	gain used in Boeing $\dot{\gamma}/V$ control law
K_s	gain used in Boeing $\dot{\gamma}/V$ control law
K_{sp}	gain used in Boeing $\dot{\gamma}/V$ control law
K_{spd}	gain used in Boeing $\dot{\gamma}/V$ control law
K_{tp}	gain used in Boeing $\dot{\gamma}/V$ control law
K_β	gain used in Douglas p/β control law
$K_{\beta_{fwd}}$	gain used in Douglas p/β control law
$K_{\dot{\beta}}$	gain used in Douglas p/β control law
$K_{\phi Hold}$	gain used in Douglas p/β control law
KEAS	equivalent airspeed in knots
KWIND	gain used in Boeing $\dot{\gamma}/V$ control law

LEF	leading-edge flap
LL	lower level
$(N_Y)_{cg}$	lateral acceleration at center of gravity
p	body-axis roll rate
p/β	lateral-directional control law descriptor
r	body axis yaw rate
rt d	conversion constant, radians to degrees
SWCON	time condition must persist to trigger mode switch
SWL1	switch used to signal vortex fence deployment during landing
SW1	switch used in vortex fence command system to signal aircraft liftoff
SW2	switch used in vortex fence command system to signal aircraft speed greater than V_r
SW3	switch used in vortex fence command system to signal pilot has initiated rotation
s	Laplace parameter
sw_alf	alpha control mode switch used in Boeing $\dot{\gamma}/V$ control law
sw_ongrnd	on-ground mode switch used in Boeing $\dot{\gamma}/V$ control law
sw_pth	path-priority switch
sw_spd	speed-priority switch
s2th	variable used in Boeing $\dot{\gamma}/V$ control law
TEF	trailing-edge flap
TOGA	takeoff/go-around mode
TOSW	time weight was removed from landing gear during takeoffs and applied to landing gear during landings
t	time
UL	upper level
V_r	takeoff rotation speed
$(V_T)_{lim}$	limited true airspeed

VTFCOM	commanded deflection of vortex fence
VTFMCOM	commanded position of vortex fence if SW2 and SW3 are true
vdthat	filtered acceleration signal
α_{comp}	complementary-filtered angle of attack
β_{cf}	complementary-filtered sideslip angle
$\dot{\beta}$	calculated derivative of air-measured sideslip angle
$\dot{\beta}_I$	calculated derivative of inertial sideslip angle
$\delta_{a, \text{cmd}}$	commanded deflection of aileron
$\delta_{f_1}, \dots, \delta_{f_8}$	deflection for trailing-edge devices 1 through 8
$(\delta_{f_i})_{\text{cmd}}$	commanded deflection of inboard flap
$(\delta_{f_o})_{\text{cmd}}$	commanded deflection of outboard flap
$\delta_{r,c}$	commanded deflection of rudder
$\delta_{r,1}, \delta_{r,2}, \delta_{r,3}$	deflection of rudder for segment 1, 2, or 3
θ	pitch angle
$\theta_{\text{rotation target}}$	target liftoff pitch attitude, deg
θ_{vr}	aircraft pitch attitude for airspeed equal to V_r , deg
τ_{kcc}	lag time constant used in flap reconfiguration thrust compensation system
$\tau_{\text{p fwd}}$	lag time constant used in Douglas p/β control law
τ_{vdthat}	lag time constant applied to filtered acceleration signal
τ_{vtf}	lag time constant applied to vortex-fence deployment
τ_{β}	lag time constant used in complementary sideslip filter
ϕ	roll angle

Longitudinal Control Laws

The longitudinal control laws used in this investigation were basically those described in reference A1. Several minor modifications to these control laws were implemented as described in the following paragraphs.

Provisions for Weight-on-Wheels Mode

The modifications made for weight-on-wheels mode are as follows:

1. Modifications to the $ITGA$ path to implement the weight-on-wheels mode are shown in figure A1. The $ITGA$ was set to zero when the simulation was initialized at the beginning of every takeoff run. Logic was incorporated to keep the integrator value at zero during takeoff runs before the aircraft was airborne and also to drive integrator output to zero when the vehicle was operating on the ground after touchdown. The value of $KWIND$ was set at -2.0 . The sw_ongrnd switch was implemented such that when there was weight on any of the landing gear units it was true and remained true if momentary weight was reapplied to any landing gear unit during the takeoff roll. Once the aircraft was airborne (i.e., no weight on any gear units), sw_ongrnd was set to false. For landings, sw_ongrnd remained false until weight was applied to any landing gear unit. In the event that the aircraft became momentarily airborne during the landing rollout, sw_ongrnd remained true.

2. Modifications to the K_{sp} path are shown in figure A2. This FADER modification removed the $vdthat$ feed into the elevator and horizontal tail command when weight was on the wheels.

3. Modifications to the K_{spd} path are shown in figure A3. This FADER modification removed the gamma error feed into the elevator and horizontal tail command when weight was on the wheels.

The FADER control system block element was defined as a linear ramp where the output from this element was 0 when weight was on any of the aircraft landing gear units ($t = TOSW$) and was 1.0 when time greater than the time required to completely fade ($t = TOSW + DELTFD$), as shown in figure A4. The parameter $TOSW$ was defined as the time weight was removed from the landing gear system. When time was between these two points, a linear interpolation was provided between 0 and 1.0. In addition, once the condition for $TOSW$ had been met, the function of the FADER was not affected if weight was momentarily placed back on the landing gear units. When in landing mode, similar logic was used to ramp the output from the FADER block to zero once weight was initially indicated on any of the landing gear units. The value of $DELTFD$ was set at 1.5 sec.

A new sw_ongrnd condition must persist for $SWCON$ seconds before switch transition occurs ($SWCON$ is defined as length of time switch condition must exist for switching to occur). The value of $SWCON$ was set at 0.5 sec.

Low-Pass Filter on $vdthat$ Signal

A filter was added to the $vdthat$ signal path where it feeds into the stabilizer command to reduce the bandwidth of the signal coming from the outer-loop guidance function to the inner-loop stability augmentation. The time constant in this filter, τ_{vdthat} , was scheduled with Mach as indicated in figure A5.

Thrust Compensation During Final Approach Configuration Change

The reconfiguration of leading- and trailing-edge flaps that occurred below 400 ft on the approach resulted in a significant change in trim drag and thus throttle setting. The increase in required power level angle was on the order of 10 percent of full throttle. Speed loss during typical approaches as a result of this reconfiguration was found to be approximately 5 knots. To minimize the speed loss associated with the approach configuration change, a function was added to provide an open-loop thrust compensation. To accomplish this, the vortex fence command was passed through a differentiating washout

filter to generate a low-pass-filtered, vortex-fence-command-rate signal, as illustrated in figure A6. This new signal is limited to ± 5 deg/sec, then scaled by an appropriate gain to generate a signal which was added to the throttle rate command.

Provision for TOGA Mode

A takeoff/go-around (TOGA) button was provided on the throttle quadrant which would change the leading- and trailing-edge devices to the nominal autoflap schedule from the final high-lift landing configuration. Activation of the TOGA button also reset the reference airspeed for the autothrottle and the HUD symbology to 200 KEAS, as well as removing glide-slope and localizer ILS symbology from the HUD.

Intended Vortex Fence Actuation for Takeoff

During takeoff, the vortex fence was deployed to aid in the initiation of the rotation maneuver. Figure A7 shows the signal flow diagram used to control deployment of the vortex fence device. The vortex fence was always operated in automatic mode. As a result, its operation was transparent to the pilot. During takeoff maneuvers, the vortex fence was locked in its fully retracted position until the pilot initiated rotation for liftoff. If the pilot attempted to rotate before V_r , the vortex fence would not deploy until the aircraft speed reached V_r . Once the vortex fence deployed, it was commanded to follow a deflection schedule inversely proportional to the pitch attitude of the vehicle. The deflection schedule commanded 100 percent vortex fence deflection (90°) when the aircraft was in the prerotation pitch attitude and 0 percent (0°) when the aircraft reached the target rotation pitch attitude (10.5°). If the vortex fence was still open once the vehicle left the ground, the vortex fence was commanded to close at its rate limit. The block diagram and logic in figure A7 describe the details of its intended operation for takeoff maneuvers.

Actual Takeoff Vortex Fence Operation

As a result of an incorrect implementation of the vortex fence logic, the takeoff mode operation of the vortex fence was inadvertently and severely affected. Basically, an incorrect mode logic statement produced an error which rendered the vortex fence almost useless during takeoff rotations. The actual operation of the vortex fence was very similar to the intended operation except during the deployment phase of the vortex fence when the aircraft was on the ground during rotation initiation. Instead of deploying at the surface actuator deflection rate of 90 deg/sec, the rate of deflection of the vortex fence was only 5 deg/sec. The result of this error was that the vortex fence could only deflect to approximately 20° before being commanded to start retracting based on the aircraft pitch attitude closure with the target pitch attitude. Once the aircraft became airborne, the higher rate limit was reinstated; this resulted in the vortex fence retracting normally. The fact that the vortex fence was not operating properly went unnoticed because of its relatively small impact on aircraft handling qualities and performance. It is believed that the CHRs would not have been significantly affected if the vortex fence had operated as planned during takeoff.

Vortex Fence Actuation for Landing

To aid in the reduction of the touchdown attitude, the vortex fence was deployed when the vehicle was reconfigured for landing at 390 ft. Figure A8 shows the block diagram used to generate the vortex fence command for landing. During landing maneuvers the vortex fence remained in its fully retracted position until the automatic flap reconfiguration began. It was then commanded to its full deflection (90°) over the same length of time (18 sec) as used for the leading- and trailing-edge flap

reconfiguration. If the pilot selected the TOGA switch, the vortex fence retracted over a period of 20 sec, which was a slightly different time period than used for the automatic flap reconfiguration.

Lateral-Directional Control Laws

The lateral-directional control laws used in this investigation were basically those described in reference A2. Several modifications described in the following paragraphs were made to these control laws based on an unpublished lateral-directional control document entitled, “Candidate Lateral-Directional Control Laws.”

Provisions for Weight-on-Wheels Mode

Weight-on-wheels modifications to the Douglas roll control laws are shown in figure A9. The constant, KWIND, was defined the same way KWIND was defined and used with the Boeing $\dot{\gamma}/V$ control law modification. The value of this constant was -2.0 sec.

Weight-on-wheels modifications to the Douglas directional control laws are shown in figure A10. The modifications to the Douglas directional control law involved implementing the FADER function to remove β_{cf} from the control system and also replace $\dot{\beta}_I$ with body axis yaw rate when changing between airborne and on-ground phases of flight. These modifications also assisted takeoff maneuvers which required β_{cf} and $\dot{\beta}_I$ instead of body axis yaw rate. The operation of the FADER control system block element is the same as that defined earlier in figure A4.

Other Modifications to Douglas Directional Control Laws

The constant τ_β in the sideslip complementary filter in the Douglas lateral-directional control law was set to 3.0 (originally it was set to 0.005). The $\dot{\beta}_I$ for the complementary filter in the Douglas p/β control law was computed by using the following equation:

$$\dot{\beta}_I = 57.3 \frac{g}{(VT)_{lim}} [(N_Y)_{cg} + \cos \theta \sin \phi] - r \cos \alpha_{comp} + p \sin \alpha_{comp} \quad (A1)$$

The $\dot{\beta}$ feedback signal in the Douglas lateral-directional control law was replaced with the $\dot{\beta}_I$ quantity calculated by using equation (A1).

Control Mixer and Control Allocation

This section describes the control allocation strategy used in this study. Elements described are the operations of the horizontal tail, elevator, leading- and trailing-edge flaps, rudder, and vortex fence. The logic used was similar to that previously outlined in references A3 and A4. No provisions were made for spoiler slot deflectors (SSDs) or speed brakes for this version of the Reference-H simulation.

Horizontal Tail

Segments and Actuators. The elevator had two segments (left and right); each segment is assumed to have three actuators. The stabilizer has one segment and is assumed to have four actuators.

Command Signals. Although the horizontal stabilizer and elevators were defined as being actuated independently, the elevators were electronically slaved to the horizontal stabilizer in a 2:1 ratio. The elevator and stabilizer control deflection signals were fed to each unit in the appropriate ratio.

Surface Jam. Although the stabilizer could be designed to “never” jam, a surface jam was simulated during this study. During these simulated flights, the stabilizer was locked in the zero position. Pitch control during these runs was generated by using only elevator deflections.

Leading- and Trailing-Edge Flaps

Segment Definition. Flap segments are defined in the following table:

Flaps	Inboard	Outboard
Leading edge	2 and 3	1 and 4
Trailing edge	3, 4, 5, and 6	1, 2, 7, and 8

Trailing-edge flap segments 1, 3, 6, and 8 were used as flaperons and driven by high-rate actuators. Segments 2, 4, 5, and 7 were only flaps and assumed low-rate actuators.

Flap Schedules. Symmetric deflection schedules for leading- and trailing-edge flaps were defined as functions of Mach, aircraft weight, and angle of attack in figures A11 and A12, respectively. The minimum symmetric automatic flap deflections followed the minimum leading- and trailing-edge flap schedule (table A1) based on angle of attack shown in figure A12. Tabulated data for figures A11 and A12 can be found in table A2 for trailing-edge flaps and in table A3 for leading-edge flaps.

Flap Transitions. Flap transition logic for the takeoff mode was designed such that the transition from the initial flap setting (LEF = 30°/TEF = 10°) to the automatic flap schedule would initiate once the aircraft landing gear height reached 35 ft. Commanded transition would occur over an 18-sec interval. During landing approaches, the transition to the touchdown flap setting (LEF = 0°/TEF = 30°) would initiate at 390 ft. A linear ramp based on time was used to define the flap deflections during transition. The time used for the transition was 18 sec, which permitted the automatic flap system to complete the flap reconfiguration by the time the aircraft descended to approximately 130 ft when following a standard ILS approach. This time also provided the smoothest transition possible given that the flap reconfiguration could not commence until the aircraft was sufficiently past the approach noise measurement microphone location, 6562 ft from the runway threshold, and must be completed before touchdown flare initiation. During landing abort/go around, the transition from touchdown flap deflections to the automatic flap schedule occurred over 18 sec once the TOGA switch was selected by the pilot. The block diagram of the automatic command generation system for leading- and trailing-edge flaps is shown in figure A13.

Flaperon Control Mixers

The Boeing mixer architecture used for the piloted assessment is described in figure A14. It involved a simple summation of aileron and flap commands for trailing-edge flap segments 1, 3, 6, and 8, which acted as flaperons. Segments 2, 4, 5, and 7 functioned as flaps only. The outboard and inboard flap commands ($(\delta_{fo})_{cmd}$ and $(\delta_{fi})_{cmd}$) are from the automatic flap schedules presented in reference A3 and also table A2 and figures A11 and A12. Deflections are positive with trailing edge down.

Control Surface Lockouts

The control surface lockout strategy for trailing-edge segments 1, 2, 7, and 8 is shown in figure A15. The lockout signal toggles between 0 and 1 as illustrated in figure A15. This signal multiplies the aileron command to trailing-edge surfaces 1 and 8. The lockout signal also multiplies the command to the upper rudder segment, $\delta_{r,1}$, as shown in figure A16.

References

- A1. Jackson, Bruce; Glaab, Louis; Raney, Dave; Derry, Stephen; Kraft, Ray; Coleman, Ed; Ray, Jim; Princen, Norm; Preston, Jeff; Yingling, Dave; and Williams, Todd: *Reference H Assessment Summary*. Formal Report, Boeing Co., Mar. 8, 1996.
- A2. Kraft, Raymond; Duffy, Keith S.; Coleman, Edward E.; and Shaw, John L.: *Flight Control System for NASA Simulation*. HSCT-BE49B-L95-013,14 (Contract NAS1-201220), Boeing Co., Aug. 18, 1995.
- A3. Churchill, B. J.: *Definition of Control Surface Allocation*. Doc. AERO-B1B8B-C95-029, Boeing Co., July 11, 1995.
- A4. Bilimoria, Karl D.: *Control Surface Issues: Oct.–Nov. '95 VMS Simulation (Draft III)*.

Table A1. Minimum Trailing-Edge and Leading-Edge Flap Schedule

α , deg	Minimum trailing-edge flap deflection, deg	Minimum leading-edge flap deflection, deg
15.0	0	0
18.0	10.00	
19.0		15.00
21.0	20.00	
22.0		37.00
23.0	30.00	50.00

Table A2. Outboard and Inboard Trailing-Edge Flap Schedule

Mach	Outboard trailing-edge flap deflection, deg	Inboard trailing-edge flap deflection, deg
Gross weight, 400 000 lb		
0.22	1.19	11.90
0.28	6.80	6.80
0.44	3.50	3.50
0.54	3.55	
0.60		1.50
0.80		0
0.90	3.70	
1.00	1.00	
1.05	0	
Gross weight, 700 000 lb		
0.33	8.40	8.40
0.39	6.00	6.00
0.54	3.70	3.70
0.60		2.70
0.80		0
0.90	3.70	
1.00	1.00	
1.05	0	

Table A3. Outboard and Inboard Leading-Edge Flap Schedule

Mach	Outboard leading-edge flap deflection, deg	Inboard leading-edge flap deflection, deg
Gross weight, 400 000 lb		
0.22	41.30	41.30
0.28	31.00	31.00
0.40	15.50	15.50
0.44	10.30	10.20
0.50	10.20	6.00
0.54	10.20	
0.60	10.20	0
0.70	10.20	
0.80	10.20	
0.90	10.00	
0.95	9.80	
1.00	10.30	
1.05	13.30	
1.15	16.50	
1.20	15.50	
1.40	13.70	
1.60	8.70	
1.80	2.50	
2.10	0	
Gross weight, 700 000 lb		
0.33	35.60	35.60
0.40	27.30	27.30
0.50	17.10	
0.54	13.00	13.00
0.60	11.80	0
0.70	10.50	
0.80	10.20	
0.90	10.00	
0.95	9.80	
1.00	10.30	
1.05	13.30	
1.10	16.50	
1.15	15.50	
1.20	13.70	
1.40	8.70	
1.60	5.20	
1.80	2.50	
2.10	0	

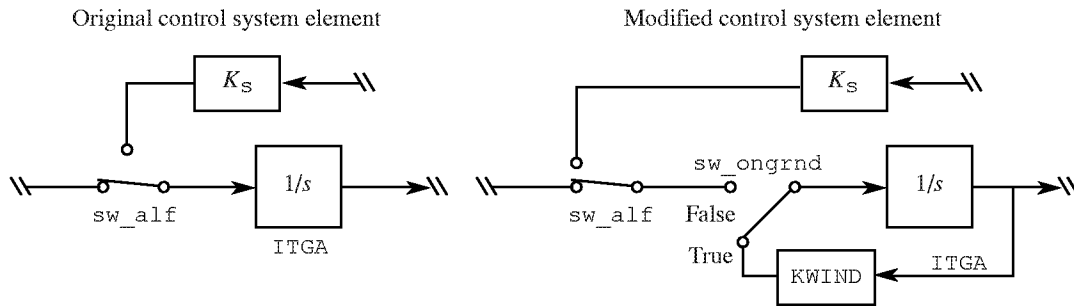

Figure A1. Modification to ITGA path for weight-on-wheels mode.

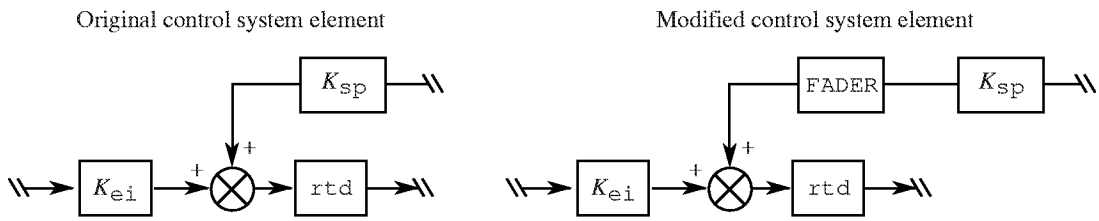

Figure A2. Modification to K_{sp} path for weight-on-wheels mode.

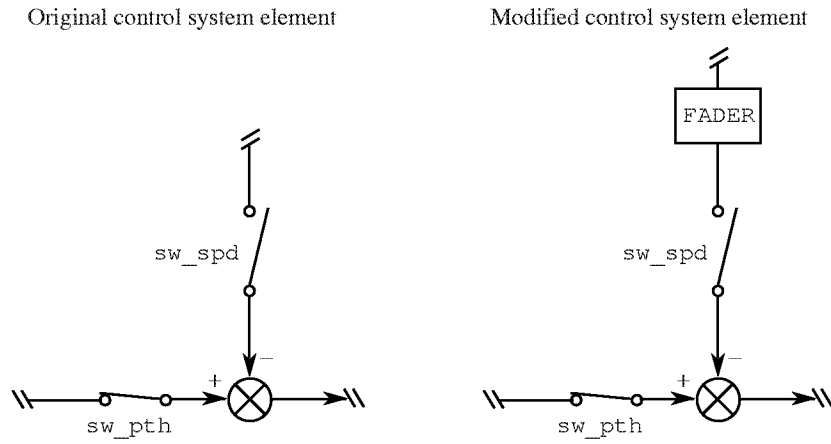

Figure A3. Modification to K_{spd} path for weight-on-wheels mode.

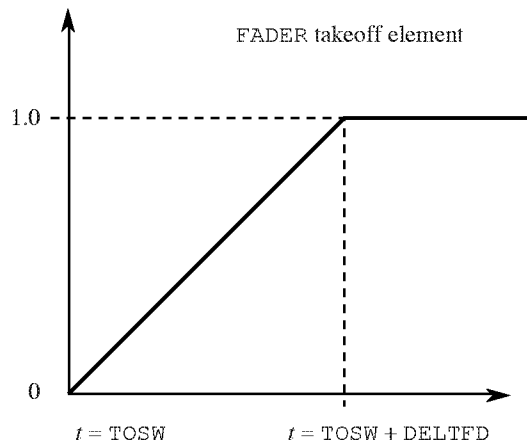

Figure A4. Operation of FADER takeoff element.

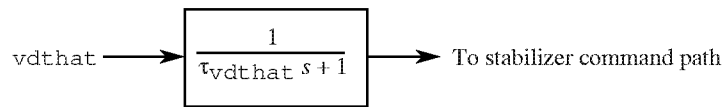

Figure A5. Low-pass filter and time-constant schedule applied to v_{dthat} signal. For $Mach < 0.3$, $\tau_{v_{dthat}} = 10$ sec; for $0.3 < Mach < 0.9$, linear interpolation; for $Mach > 0.9$, $\tau_{v_{dthat}} = 2$ sec.

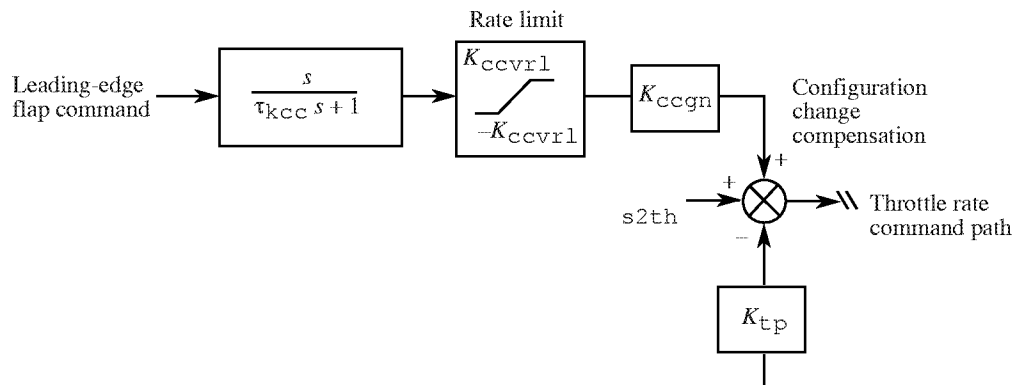

Figure A6. Thrust compensation for automatic flap reconfiguration. $K_{ccgn} = 0.0005$; $\tau_{kcc} = 0.5$ sec; $K_{ccvrl} = 5.0$ deg/sec.

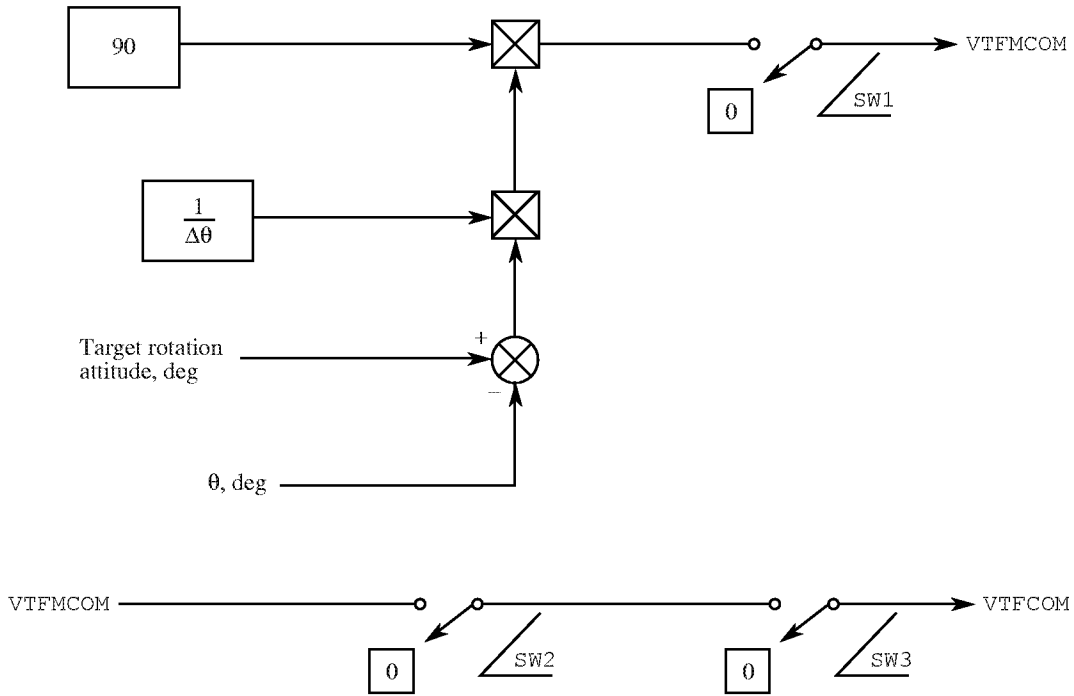

Figure A7. Deployment of vortex fence to aid in takeoff rotation. $\Delta\theta_0 = \theta_{\text{rotation target}} - \theta_{V_r}$; switch 1 initialized to true and set to false when landing gear altitude > 0.50 ft; switch 2 set to true when complementary-filtered airspeed $> V_r$; switch 3 set to true and remained true when DCPILOT > 0 after aircraft had reached V_r .

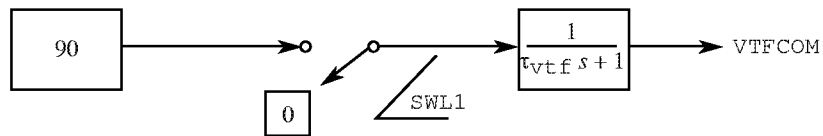

Figure A8. Deployment of vortex fence for landing. $\tau_{vtf} = 10$ sec; switch SWL1 initialized to false and set to true when aircraft landing gear altitude is 400 ft.

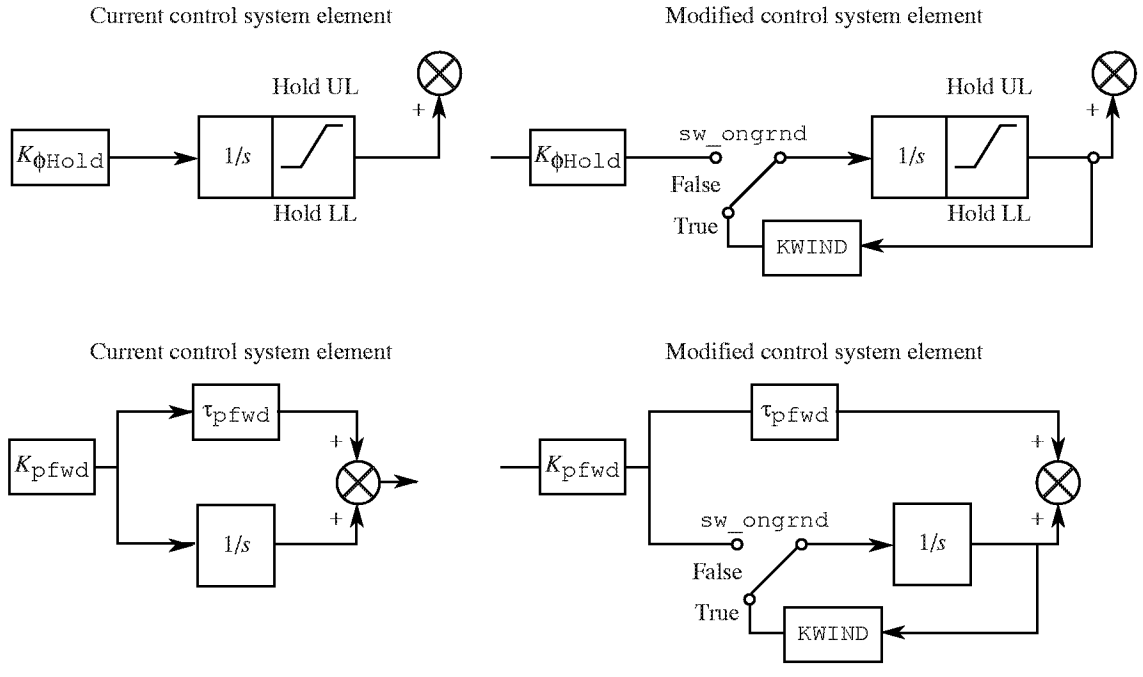

Figure A9. Modifications to Douglas roll control laws for weight-on-wheels mode.

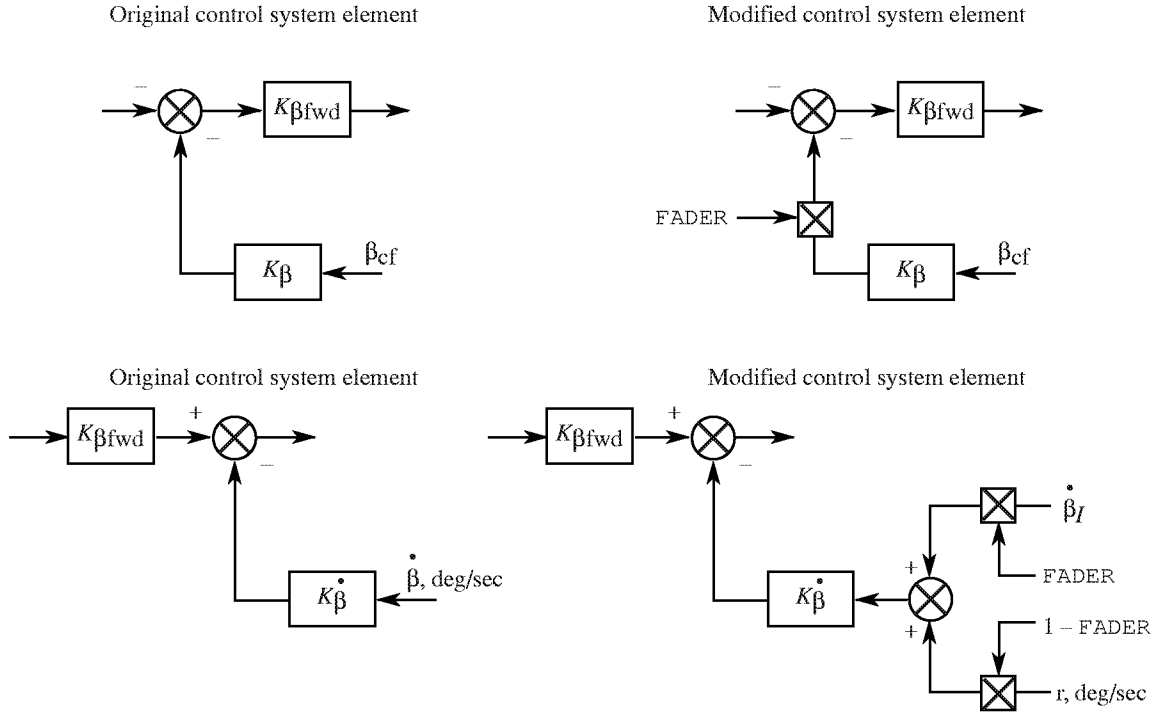
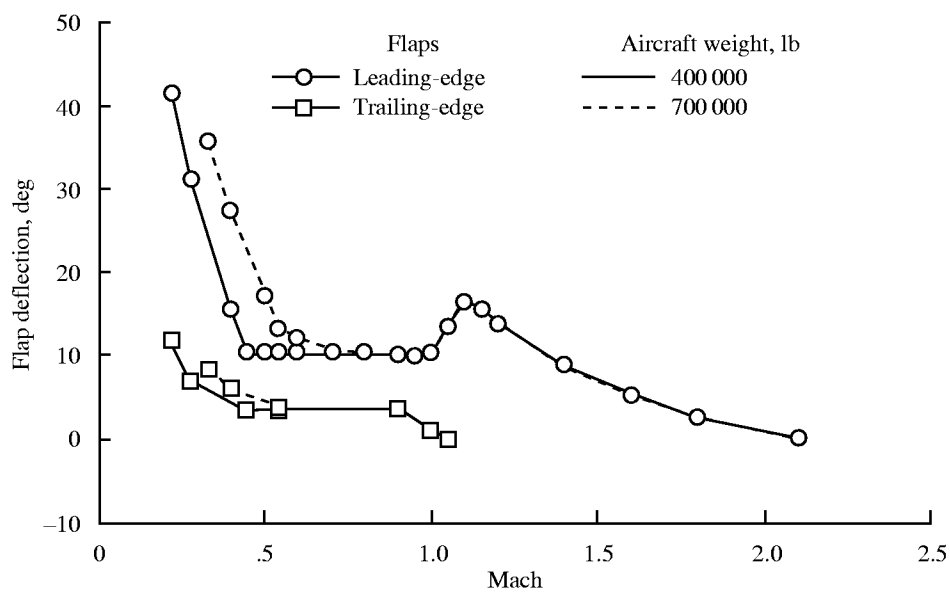
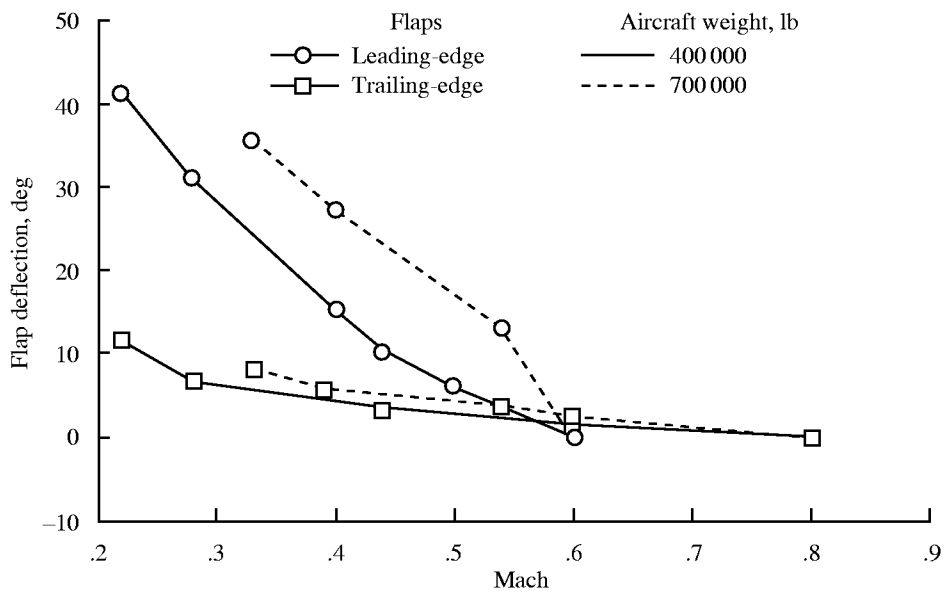

Figure A10. Modifications to Douglas yaw control laws for weight-on-wheels mode.



(a) Outboard flap segments.



(b) Inboard flap segments.

Figure A11. Symmetric leading- and trailing-edge flap deflection as function of Mach number. Data from tables A1 and A2.

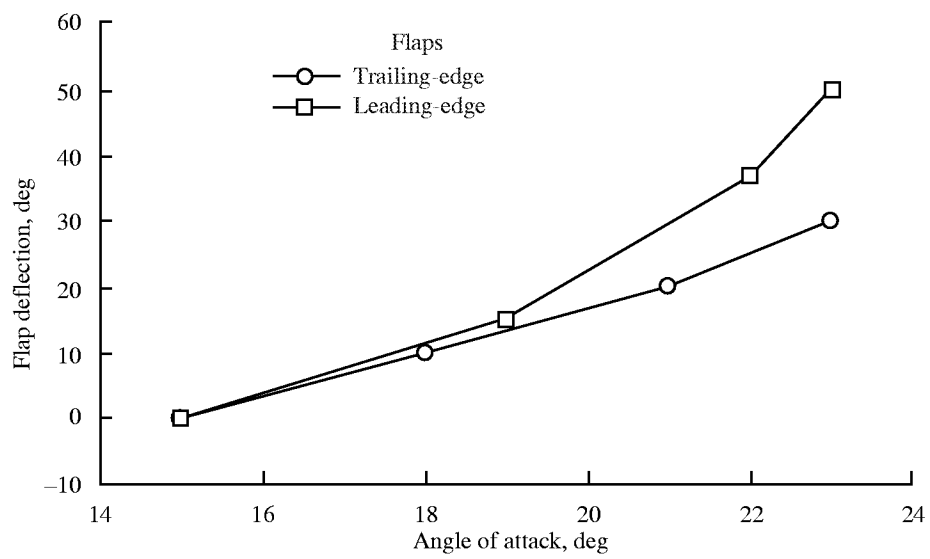
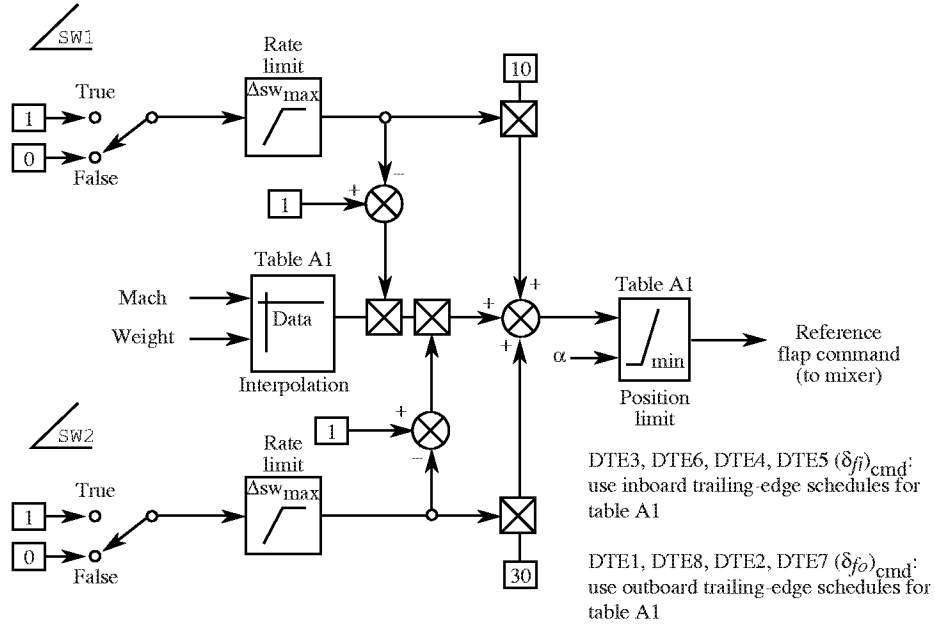

Figure A12. Minimum symmetric leading- and trailing-edge flap deflection as function of angle of attack. Data from table A3.

Trailing-edge devices:



SW1: If $h < 35$ ft and Mode = Takeoff, SW1 = True
SW2: If $h < 394$ ft and Mode = Landing, SW2 = True

Pilot TOGA switch:
 If TOGA switch has been depressed, then Mode = Takeoff;
 else, Mode = Mode_(n-1)
 Nominally, mode is set at task initialization.

Leading-edge devices:

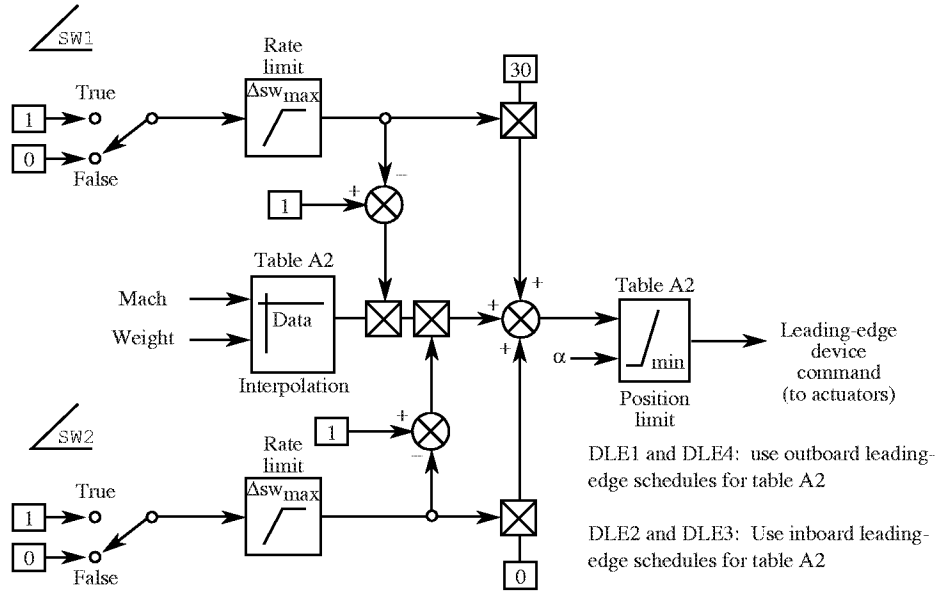

SW1: If $h < 35$ ft and Mode = Takeoff, SW1 = True
SW2: If $h < 394$ ft and Mode = Landing, SW2 = True

(Set $\Delta sw_{max} = 0.3/\text{sec}$)

Figure A13. Automatic command generation system for leading- and trailing-edge devices.

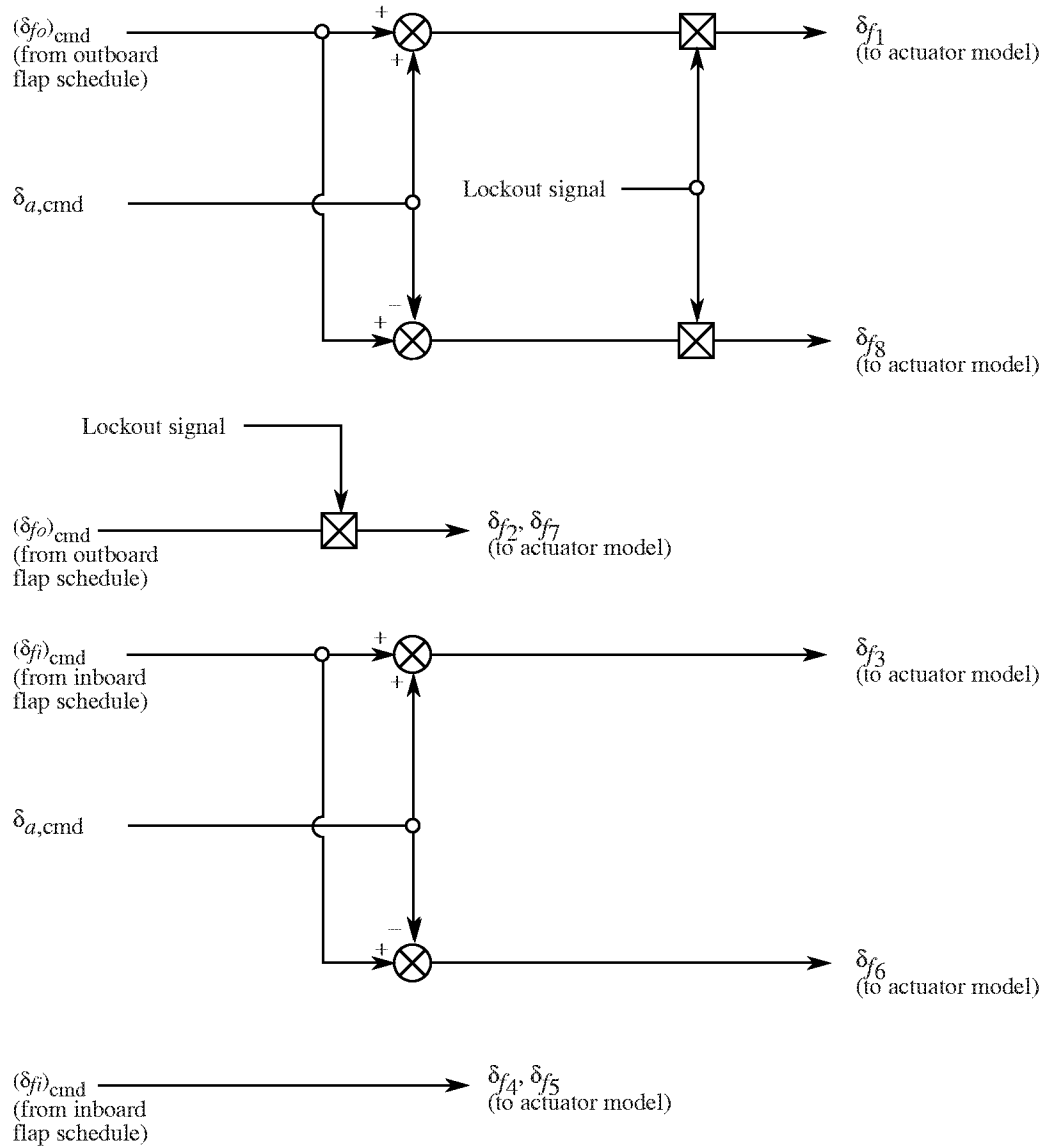

Figure A14. Diagram of Boeing control mixer used in piloted reference-H assessment.

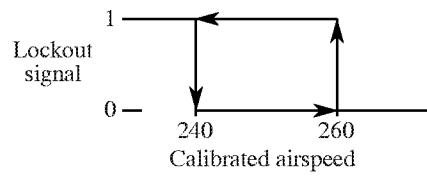

Figure A15. Diagram of lockout schedule for trailing-edge flaps 1 and 8.

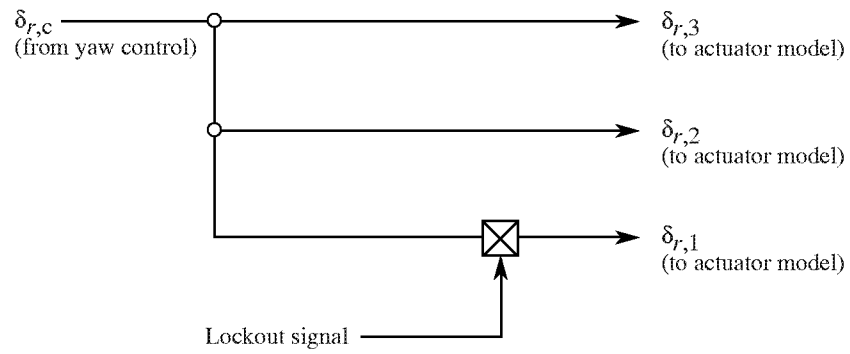

Figure A16. Use of control lockout signal for uppermost rudder segment.

Appendix B

Simulator Facility Description

Cockpit Layout

The Reference-H Assessment described in this report was conducted in the Langley Visual Motion Simulator (VMS). This generic simulator can be configured to support tests for a wide variety of aircraft. The left seat was equipped with a sidestick and was used as a pilot station for this test. In addition to the sidestick, the pilot had conventional rudder pedals with toe brakes, a four-lever throttle quadrant with backdriven autothrottle, a control display unit for entering speed commands (no mode control panel was simulated), and gear and flap levers. The right seat was occupied by the research engineer who performed the duties of the pilot not flying and generally operated the control display unit and gear lever. The flap levers were not used because the flaps were either commanded by the automatic flap control system or remained fixed when operating in manual flap scenarios. A photograph of the VMS pilot cockpit interior is shown in figure B1.

External Scene, HUD, and Cockpit Displays

The VMS was configured with four wide-angle collimated displays for out-the-window views (front and left side windows for the left seat, and front and right side windows for the right seat). The field of view of the forward display from the left seat is 21.8° vertically (8.3° up and 13.5° down) and 39.4° horizontally (19.7° to each side). No aircraft nose structure was imposed on the display because an elegant solution to the nose view obstruction was not part of this study. The out-the-window displays were driven by an Evans and Sutherland ESIG-3000 image generator with a database based on data for the Denver International Airport. A raster head-up display (HUD) image was mixed into the video signal for the forward view.

Six calligraphic monitors, three in front of each pilot station, were used to present a variety of heads-down displays to the pilot and research engineer. These displays were configured on a per-task basis. Both the HUD and the heads-down displays were driven by a Terabit Eagle 1000 Calligraphic/Raster

Display System. Photographs of typical display formats are given as figures B2 through B11.

A trim display (fig. B2) was presented to the pilot prior to beginning each task. It provided trim information to ensure a smooth transition to motion operation. The display confirmed proper selection of positions for autothrottle, landing gear, flap position levers, stick, rudder pedal, steering tiller, brakes, and throttle lever. Inceptors that were in the proper position were shown in green or blue; trim mismatches were shown in red. This display was replaced by one of the operational displays in operate mode.

A primary flight display, shown in figure B3, was presented for most of the tasks performed. It provided information similar to that depicted on the HUD and was centered about the boresight of the aircraft. A horizontal situation display, shown in figure B4, was provided to assist the pilot in monitoring aircraft heading.

A velocity-altitude display, shown in figure B5, was used in profile climb and other tasks to track the position of the vehicle relative to the flight envelope. The inset in the upper left is an expanded view about the present position; the magnification of this inset varied with Mach number. The velocity-altitude display is described more completely in the section "Up-and-Away Tasks" in the body of this report.

An engine-surface display (fig. B6) was presented for all tasks. It showed percent thrust on each of the four engines in a round dial format. The current flap positions for leading- and trailing-edge devices were displayed in color. A green surface indicated the corresponding flap was not operating near a position limit nor was being commanded to travel faster than it could (rate limited actuator). A yellow surface indicated the corresponding actuator was being rate limited. A red surface indicated the corresponding actuator had reached a deflection limit. For devices that had no upwards travel, only the negative (downward) deflection limit was color-coded in this fashion. Elevator, stabilizer, and rudder positions were depicted as numerical values (E, S, and R, respectively) to the left of flap positions.

The HUD consisted of symbology overlaid on the out-the-window computer-generated image. This symbology was developed specifically for this test. A

specification document of the symbology was included in the pilot briefing guide and is included as appendix I. More information about the operation and meaning of various symbologies are contained in other sections of this report.

Figure B7 depicts the HUD in takeoff rotation guidance mode. The waterline marker appears as an enlarged white W when the pilot is controlling pitch attitude. The target waterline marker displays as a dashed magenta W. Flashing symbology was used to provide a compelling pitch target. The brackets on either side of the waterline marker provided rotation guidance with adequate and desired boundaries. Finally, a red and white horizontal barberpole symbol showed a calculated tail-strike attitude as a function of altitude; as the aircraft began to climb away from the runway, the tail-strike bar moved up the screen. Actual flight path is depicted by a white circle with winglets (flight-path marker); in all other HUD modes the white circle with winglets represented the commanded flight path.

Figure B8 depicts the HUD in programmed lapse rate guidance mode. In this mode, the HUD provided a target climb gradient (4 percent). At this altitude the tail-strike bar has disappeared. Visible in this figure are both the commanded flight-path symbol (white circle with winglets and vertical fin) and the actual flight-path marker (red segmented circle with winglets and vertical fin), which demonstrated the display behavior when the difference between actual and commanded flight-path angles was greater than 0.5° (0.25° in landing mode).

Figure B9 depicts the HUD in landing approach guidance mode. In this mode, the HUD displayed traditional, raw instrument landing system guidance at the right side (glide slope) and lower center (localizer) of the display. Note the acceleration diamond on the left winglet of the flight-path symbol, which was used to assist the pilot in speed control for nonautothrottle landings. This diamond rose above the winglet to signify an acceleration along the flight path (increase in airspeed) and descended below the winglet to signify a deceleration (decrease in airspeed).

Figure B10 depicts the HUD in landing flare guidance mode. In this mode, a flare cue (red horizontal lines below the commanded flight-path symbol) fol-

lows a predetermined flight-path angle as a function of radar altitude. A velocity error is announced by the white vertical bar appearing on the left winglet of the commanded flight-path symbol; this bar indicates that the airspeed is higher than desired. The appearance of the actual flight-path marker underneath the commanded flight-path marker signifies a difference greater than 0.25° between the two.

A scorecard display (fig. B11) appeared after the end of each run and was used to help the pilot determine his performance for the run. The display showed the actual value of each performance standard, the desired and adequate boundaries, and a mnemonic classification (DESR for desired, ADEQ for adequate, INAD for inadequate) for each performance standard. Additional score pages were presented for each additional segment of the task.

Control Inceptors and Characteristics

Table B1 gives the measured feel characteristics for the left-hand sidestick inceptor and for the floor-mounted rudder pedals. The inceptor is a McFadden control loader with a 7 5/8 in. stick and generic left hand grip. None of the buttons on the stick grip were used in this study. The electrical breakout was the amount of force that had to be applied to cause a change from zero to the longitudinal inceptor position, lateral inceptor position, and rudder pedal position variables in the simulation model after all signal conditioning and analog-to-digital conversions had been applied. The throttle quadrant was located between the pilot seats and provided four throttle levels of generic design. The measured force characteristics of the throttle quadrant are given in table B2.

Motion Platform

The VMS cockpit is mated to a synergistic six-degree-of-freedom motion base that provides motion cues to the pilot. The motion algorithms use a coordinated adaptive washout scheme for the roll-sway and pitch-surge axes and nonlinear washout filters for the heave and yaw axes. The single-degree-of-freedom performance limits for this system (using a neutral point of 35.6 in. above the settled position) are given in table B3. Reference B1 describes the washout algorithms in greater detail; reference B2 describes the compensation used in the drive algorithm and provides

frequency response data (phase lag and amplitude ratio) for this motion system.

Host Computer

The simulation model was run on a Convex 3840 computer system at 80 Hz for the mathematics model and 40 Hz for the displays and real-time input/output.

References

- B1. Parrish, Russell V.; Dieudonne, James E.; Bowles, Roland L.; and Martin, Dennis J.: Coordinated Adaptive Washout for Motion Simulators. *J. Aircr.*, vol. 12, no. 1, Jan. 1975, pp. 44–50.
- B2. Parrish, Russell V.; Dieudonne, James E.; Martin, Dennis J.; and Copeland, James L.: *Compensation Based on Linearized Analysis for a Six-Degree-of-Freedom Motion Simulator*. NASA TN D-7349, 1973.

Table B1. Measured Characteristics of Cockpit Inceptor

Control inceptor	Travel	Force breakout, lb	Signal breakout, lb	Average gradient	Full deflection force, lb
Longitudinal stick	$\pm 12^\circ$	2.0	6.2 forward, 2.4 aft	1.33 lb/deg	15
Lateral stick	$\pm 12^\circ$	1.8	1.8 left, 2.0 right	0.93 lb/deg	12
Rudder pedals	± 3.75 in.	9.0	9.0	53.3 lb/in.	≈ 200

Table B2. Measured Characteristics of Throttle Quadrant

Throttle lever	Travel, in.	Average friction, lb
1	8.6	4.1
2	8.6	5.1
3	8.6	6.4
4	8.6	4.0

Table B3. VMS Motion Base Characteristics

Axis	Position	Velocity	Acceleration
Surge	49 in. forward, 48 in. aft	± 24 in/sec	$\pm 0.6g$
Sway	± 48 in.	± 24 in/sec	$\pm 0.6g$
Heave	39 in. up, 30 in. down	± 24 in/sec	$\pm 0.8g$
Roll	$\pm 22^\circ$	± 15 deg/sec	± 50 deg/sec ²
Pitch	$+30^\circ / -20^\circ$	± 15 deg/sec	± 50 deg/sec ²
Yaw	$\pm 32^\circ$	± 15 deg/sec	± 50 deg/sec ²



Figure B1. Visual motion simulator cockpit interior.

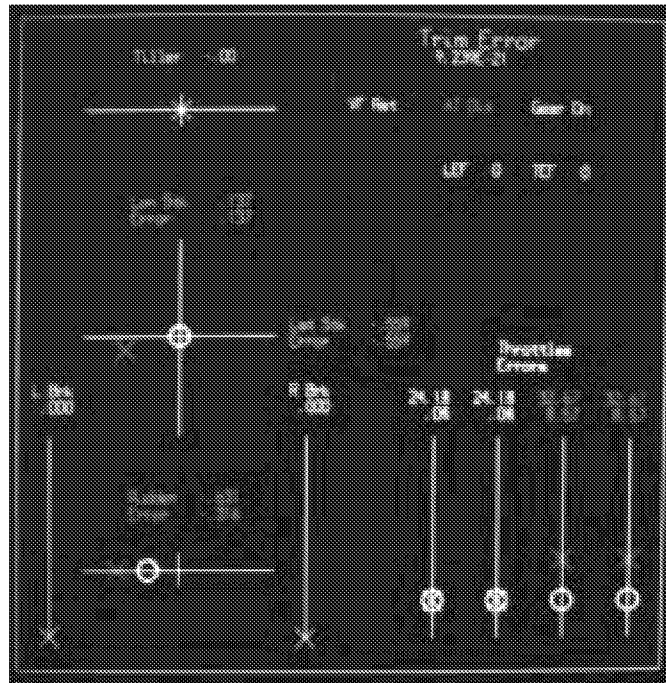

Figure B2. Trim display image.

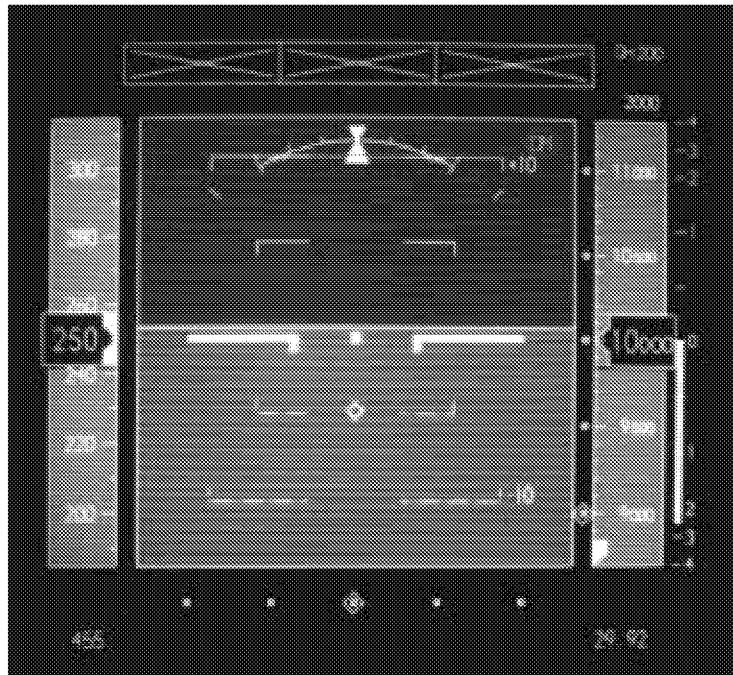

Figure B3. Primary flight display image.



Figure B4. Horizontal situation display image.

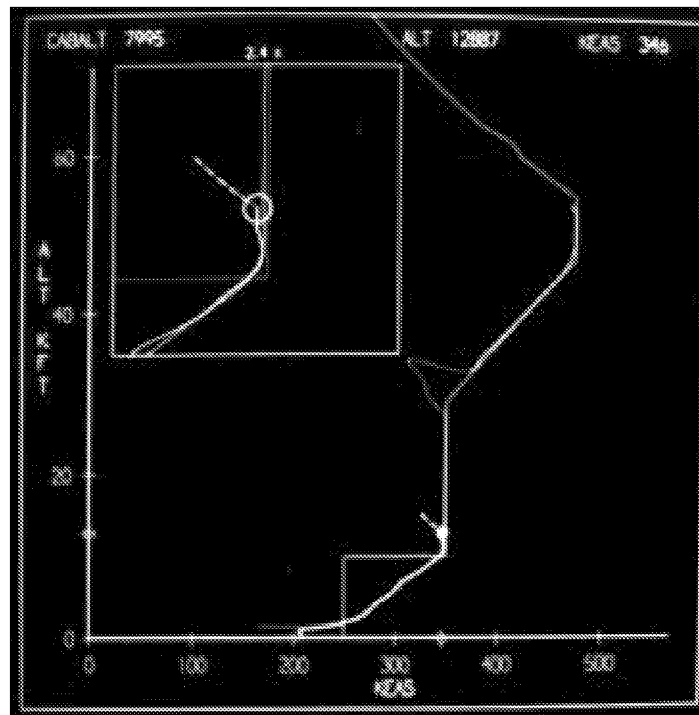

Figure B5. Velocity-altitude display image.

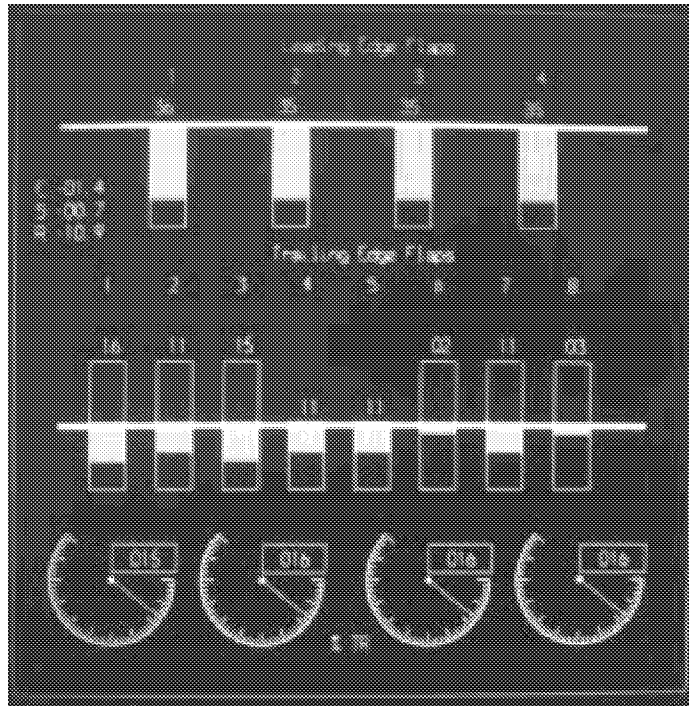

Figure B6. Engine-surface display image.

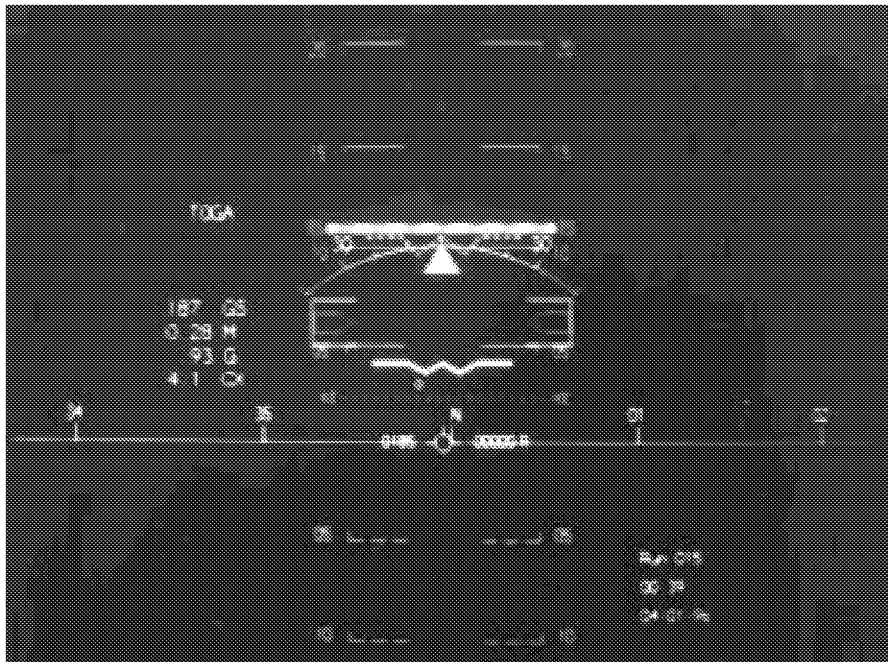

Figure B7. Head-up display symbology showing takeoff rotation guidance.



Figure B8. Head-up display symbology showing programmed lapse rate guidance.

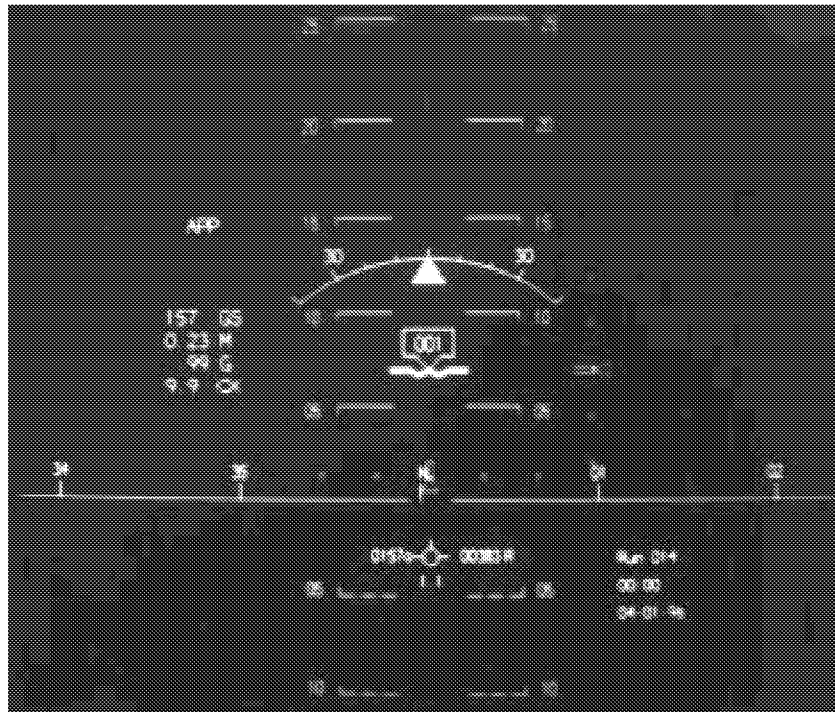

Figure B9. Head-up display symbology showing landing approach guidance.

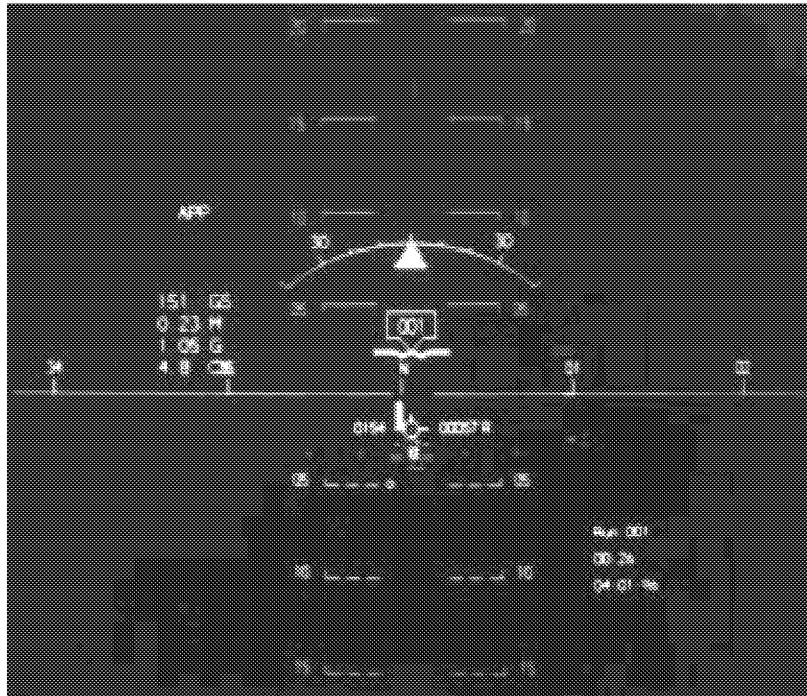

Figure B10. Head-up display symbology showing landing flare guidance.

Task 1050 Precision Landing				
	Have	Target	Delta	
X HG TD	806.9	1750.0	-943.1	IMAD
Y HG TD	-12.7	0.0	-12.7	DESR
Ldg Phi	0.4	0.0	0.4	DESR
Ldg AS	141.2	140.0	1.2	DESR
Ldg Hdot	-7.9			IMAD
Ldg Hdq	0.1	0.0	0.1	DESR

Figure B11. Scorecard display image.

Appendix C

Pilot Biographies and Comments

Nomenclature

The abbreviations and notations used in the pilots' comments are defined as follows:

AGL	above ground level
APC	aircraft-pilot coupling
ATC	Air Traffic Control
Ames	NASA Ames Research Center
accel	acceleration
alpha	angle of attack
alpha-dot	change in angle of attack with respect to time
beta	sideslip angle
CGI	computer-generated image
CHR	Cooper-Harper rating
$C_{M\Delta P}$	pitch acceleration with changes in power
Cat	category
cg	center of gravity
decel	deceleration
delta	change or difference
dir	directional
EAS	equivalent airspeed
FAA	Federal Aviation Administration
FAR	federal aviation regulations
fam	familiarization
GA	general aviation
g	acceleration due to gravity

gamma	flight-path angle
gamma-dot	change in flight-path angle with respect to time
gamma-dot-V	longitudinal control law
HQR	handling qualities rating
HSCT	High-Speed Civil Transport
HUD	head-up display
H-dot	change in altitude of center of gravity with respect to time
IC	initial condition
inop	inoperative
lat	lateral
M_{mo}	maximum operating Mach
max	maximum
min	minimum
OEO	one engine out
PFD	primary flight display
PIO	pilot-induced oscillation
PLR	programmed lapse rate
phi	roll angle
phi-dot	change in roll angle with respect to time
\bar{q}	dynamic pressure
RTO	rejected takeoff
SAS	stability-augmentation system
sat	satisfactory
sec	second
sim	simulator
specs	specifications

TAC	thrust asymmetry control
TBD	to be determined
TCA	terminal control area
TOGA	takeoff go-around
TS	tail strike symbol on head-up display
theta	pitch attitude
VFR	visual flight rules
VHD	velocity-altitude display
VMS	Vision Motion Simulation
V_{mca}	minimum control speed in air with one engine out
V_{mcg}	minimum control speed on ground with one engine out
V_{mcl-2}	minimum control speed in landing configuration with two engines out
V_{mo}	maximum operating speed
V_r	takeoff rotation speed
V_1	takeoff decision speed
V_2	engine-out safety speed
W	waterline symbol on head-up display
X	location of touchdown point along runway length
X-double-dot	longitudinal acceleration
Y	location of touchdown point left or right of runway centerline
()	another voice
[]	editor's addition

Pilot Biographies

Pilot A

Pilot A had a Bachelor of Science degree from the University of Washington where he attended a flight test course. Pilot A served as Engineering Test Pilot for two General Aviation Manufacturers and accumu-

lated time as a test pilot on 30 different general aviation fixed-wing aircraft, before joining an HSR program industry partner as a research project pilot. He is a graduate of a company-run flight test school. Pilot A holds an Airline Transport Pilot Certificate with type ratings in 7 transport aircraft, and has over 16000 hr flight time, of which nearly 10000 hr have been in flight tests. Pilot A is a certified flight

instructor in both GA and transport aircraft, with 3000 hr of instruction given.

Pilot B

Pilot B was trained as a Naval Aviator and graduated from the U.S. Naval Test Pilot School, Patuxent River, Maryland. Pilot B has a Ph.D. in Hypersonic Flight Dynamics from the University of Southern California. He is employed by an HSR program industry partner as the chief pilot for the High Speed Civil Transport and as a project experimental test pilot in a number of aircraft programs. He holds an Airline Transport Pilot Certificate and has first pilot time in over 50 aircraft, including the F-14A and several transport aircraft.

Pilot C

Pilot C is a graduate of the Air Force Test Pilot School and holds a Master of Science degree from the Air Force Institute of Technology. Pilot C was a combat fighter pilot for the U.S. Air Force with 2000 hr combat experience in A-10, F-4, F-5, and F-100 aircraft. He is employed by Calspan Corporation and has extensive experience in variable stability aircraft and in in-flight simulation studies involving a wide variety of simulated aircraft, including fighters, bombers, and transport designs. He has over 1000 hr of flight time giving demonstration to military test pilot students in the Variable Stability Learjet owned and operated by Calspan.

Pilot D

Pilot D served with the U.S. Marine Corps from 1953 to 1962 as a single-engine fighter-bomber pilot. He has been a research pilot with NASA since 1962 and has accumulated more than 10000 hr in a wide variety of aircraft, including helicopter, VTOL, STOL, and light and heavy fixed-wing aircraft. He has an Airline Transport Pilot Certificate with type ratings in the Convair 990 and the Douglas DC-8.

Pilot E

Pilot E was trained as a Naval Aviator and flew F-8's in both active and reserve duty. Pilot E flew with a major airline for 4 years in Boeing 727 aircraft before joining NASA as an Instructor Pilot in the Shuttle Training Aircraft before becoming a Research Pilot at a NASA Research Center. As a NASA pilot,

Pilot E has flown a number of research aircraft in addition to research simulations of other vehicles. Pilot E holds a Bachelor of Science degree from the University of North Carolina at Chapel Hill and a Master in Aerospace Engineering degree from the University of Virginia. Pilot E has accumulated over 10000 flying hours in over 45 different aircraft, including F-8, F-18, F-16, F-15, F-5, A-4, Boeing 727, Boeing 737, Gulfstream II/STA, T-38, OV-10, and LR-28 aircraft and a number of general aviation aircraft.

Pilot Comments

Task 1050, Rejected Takeoff—0-Knot Crosswind

Pilot A. That's based on what you do. You cannot control what they do. So those jumps are just a calculation on how you're doing versus how you should of done and how you want to go in midcourse corrections.

The yaw at engine failure was quite minimal—less than I expected. We are at fairly high speed and there's no problem staying on centerline and stopping. I guess the major item of interest is the amount of yaw that you get from an engine cut at V_1 . This is fairly minor. Almost didn't think we had an engine failure when he called it. These throttles, the quadrant is quite wide, a little wider than I'm use to, so I didn't get number 4 back like I should've. Fortunately, that's the one that failed, so it didn't make any difference.

Normally, I would continue to take off if an engine failure occurred after V_1 . We called V_1 and then an engine fail. I had to fight my reaction to continue. Usually take my hand off the throttles at V_1 . Okay, I think that's all the comments I had. I rate the ability to stay on centerline as a 1. Really couldn't be much better.

Pilot B. This is run number 38 RTO with a number 4 engine failure, and evaluation was ease of tracking runway centerline, ± 10 ft desired and 27 ft adequate, with rudder pedals and brakes and the aircraft accels and decels. The acceleration is obviously easier than the deceleration because the deceleration has dissimilar thrust initially. The technique change between the fam run and this run was that I stopped trying to put on maximum brakes while I was messing with throttles and just cut the throttles back first and then applied maximum brakes. You've got enough runway—you

can do that. And that was the technique. Numbers reflect a maximum of 6-ft deviation—well within the desired box. I thought the deceleration workload was at the moment of deceleration—you're working to keep this thing under control. So the compensation was relatively frequent, coordinated rudder and brake inputs to track the centerline. It's controllable. Adequate performance is attainable. It is satisfactory without improvement. I called the characteristics fair, with mildly unpleasant deficiencies and relatively high workload and compensation. However the compensation can be characterized as close. If it was any worse than this, it would be a 4. It's a borderline 3. It's a 3 but it's a low 3. That's it.

Pilot C. Runs 8 and 9, and the pilot is C, the task is 1050. The runway control—try to abort. [Rejected takeoff] is about the same as I experienced yesterday. You get up to about 120 and it's a little sensitive above that. At the point that the engine fails, if you wait just a little bit to react, you get a significant excursion, and it takes quite a bit of pretty rapid rudder activity to get it back onto the centerline pretty expeditiously. A little more work there than I would like. If you are able to jump on it as soon as the engine fails before you retard the throttles, before the asymmetry, then you can stop pretty easily right on the centerline. So, is it controllable? Yes. Is adequate performance obtainable with a tolerable pilot workload? Yes. Is it satisfactory without improvement? I'd say, yes. There are some mildly unpleasant deficiencies, minimum pilot compensation required to obtain desired performance. It's a 3. And it looked like the odds of bringing it back after it got started was no problem with it.

Pilot D. Okay, Pilot D on December 5th. Back from lunch and we just completed the rejected takeoff on task 1050, run 16. Just some comments. It's pretty easy. There's really not any large directional transient at the failure. We're failing number 4, so it started me off to the right just a little bit. It seems also like the right brake might be a little stronger. So I had a tendency to hang to the right side. Other than that, it's very easy. There's no large transient at the engine failure. The pilot rating: obviously controllable. Adequate performance attainable? Yes. Satisfactory without improvement? There's a little bit of a tendency to kind of S-turn or PIO in heading. It's controllable but it's there. So let's make it a Level II. Let's make it a 4. Minor but annoying, disturbing deficiencies. Let's make it a 4.

Pilot E. Okay, this is task 1050, rejected takeoff, no crosswinds. Basically it's pretty much close to a V_1 , you get an engine failure. Have to maintain directional control, and a technique I finally decided was the best technique was to quickly get directional drift under control, then apply max brakes. If I went directly to max brakes at the same time as trying to control the directional drift and I deviate a little bit outside the 10-ft desired boundary, what seemed to work real well was to quickly maintain your directional control and then symmetrically, you know, with max braking, and also I was able to stop sooner with that technique. At any rate: is aircraft controllable? Yes. Adequate performance? Yes. Satisfactory without improvement? Yes. And it's definitely coming up 3. There's a lot of pilot compensation required, but I was able to keep it within 5 ft of the centerline, which I thought was pretty good for an engine-failure type scenario.

Task 1051, Rejected Takeoff—15-Knot Crosswind

Pilot A. Run 27, that was the last run or the next run. We had engine cut at just before V_1 , and I closed the throttles and applied the brakes and we started drifting to the right. I had to start metering in left rudder along with using maximum braking. The geometry of these rudder pedals with the seat, it's riding a little on the high side relative to the rudder pedals. It makes it just a little bit of an awkward angle. Feels like you're standing up in stirrups trying to stop the airplane, rather than sitting down. And so it took me just a few seconds to get modulated back into getting rudder. I think it was using brakes for directional for a little bit. But the rudder control certainly is effective, and if you get on the rudder properly, there's plenty of rudder control to get it back there in a reasonable fashion; the mechanics are getting maximum braking applied and still modulating the rudder pedals to center. There again, if TAC might help a little bit, but of course when you bring the thrust back to idle, TAC goes out the picture. Thrust asymmetry control: I give it a 3 because of the geometry of your brakes. [Changed to a 1 following task 1052, run 28.]

Pilot B. Ok, run 39. Same task as the last time, to evaluate tracking and ease of controlling runway centerline with rudder pedals and brakes during a number 4 engine failure at V_1 .

This time with a 15-knot crosswind, the workload was about evenly matched between the accel and the decel, and in both cases I'm working fairly hard to maintain the runway centerline, although the numbers look better too, and that's probably because I'm having to work harder anyway. I'm seeing the drift before the error gets significant and correcting back for it, whereas with a lower drift rate, I'm probably allowing a little more error. The overall effect from a pilot standpoint is that the workload is a bit higher with this 15-knot crosswind. As far as HQR: it is controllable, adequate performance is attainable. Rather than calling it satisfactory or unsatisfactory, going over to the right, now I guess the issue is whether it's moderate compensation or minimal compensation. The issue here too is [that] I don't think the deficiency requires improvement. I think you could live with it the way it is. It's just a relatively high workload. I'm going to give it the benefit of the doubt and give it an HQR of 3 again. But the compensation is probably more than minimal. But I'm not sure that you couldn't live with it the way it is without requiring improvement. That concludes remarks.

Pilot C. Run 10, which is 15-knot crosswind rejected takeoff. Single comment is for the no-wind case. With the exception that at this time you get to see that the beta indicator is showing that there is a significant crosswind or significant beta. About the same comments and Cooper-Harper of 3.

Pilot D. Pilot D on the 5th of December. This is task 1051, run 18. The crosswind really wasn't much of a factor—just a minor factor, if anything. It did excite a little bit the first time I tried it, I had a little bit of a PIO in heading there, which is a tendency of the control system. Also, we used a down elevator in one, which is not the thing to do, but on the last run, things worked out real good. And crosswind is really just a minor factor. I'm going to give it the same pilot rating, a 4.

Pilot E. Task 1051. Rejected takeoff with 15-knot crosswinds. Maintain about 3.3 ft within centerline. The crosswind: obviously the aircraft aerodynamically does have plenty of control to maintain a steady track down the runway. Stopping distance was a little bit longer mainly because when I came back with the thrust, I wanted to quickly null out the directional problems, and the crosswinds kind of exacerbated the

side directional problem from the asymmetric thrust briefly before bringing all four engines back. It probably took me just a split second longer to get that one controlled. However, the directional control, I thought, was excellent, considering the crosswind engine failure. I probably could have been a little more aggressive on the braking and maybe have a little slightly wider deviation in the centerline. At any rate: I thought it was a pretty well-behaved maneuver. And it's controllable, adequate performance was obtainable, and it's coming in again as a 3 because there is quite a bit of pilot compensation required to maintain your directional track. I would certainly have no problem getting desired criteria. I would say no problem. With a lot of work, you can get desired criteria.

Task 1052, Rejected Takeoff—35-Knot Crosswind

Pilot A. Run 28. Let's look at my learning curve here. 8 ft is desired; I got 7.9. It reminds me of my college days. Completely adequate. I rate that one a 1. Yea, I think I was coming up on a learning curve, a quick learning curve. Yea, why don't you just rate them both a 1.

Pilot B. Run 40, kind of interesting, very similar workload to the 15-knot crosswind here at 35 knots. The performance is a little bit worse. I was at 7.4 ft max with 10 ft desired, but as far as the workload is concerned, a very similar task, keeping in mind there's probably a learning curve here too. So Cooper-Harper for lateral tracking: it is controllable, adequate performance is attainable, and for the same reasons as before I'm going to say it's satisfactory without improvement. With the caveat that it's probably more than minimum compensation required for desired performance. There's some compensation and workload in making lateral inputs. They're relatively frequent—on order of 2 per sec or so—and I can't tell you exactly how much, but there's coordinated breaks in rudder input required. What's really helping out quite a bit, and I commented to Lou on this during the run, is that the velocity vector has enabled me to steer down the runway and compensate automatically for the skid that's required. So the velocity vector is very useful in this task. I have not noticed that before. That concludes the comments.

Pilot C. Run 11 and item number 1052, the 35-knot crosswind, rejected takeoff. And again this time the

task was relatively easy to accomplish with not too much workload. I do have some caveats to it though. We are jumping right on this as soon as the engine fails, and there is very little disturbance before I jump on the rudder pedals, and over the time I have learned to be much more aggressive on the rudder pedals, and whether that would be okay in the real airplane as far as side forces are concerned might be a different case. And anyway, in this sort of given simulation, as long as you jump on it early you can virtually track the centerline without too much difficulty. So again I would give it the same rating as for the other two rejected takeoffs, Cooper-Harper of 3. And basically the same comments.

Pilot D. Pilot D, rejected takeoff, task 1052, run 19. This is for the 35-knot crosswind. The crosswind was definitely noticeable, but it's still really not a major factor. Lots of rudder control and there's no big transient at the engine failure to go along with the crosswind. It really doesn't increase the workload significantly. I'm going to still give a 4. Maybe a 4 point something, but let's just leave it at a 4.

Pilot E. Okay, task 1052, 35 knots of crosswinds. A quick comment for 1051: my stopping distance here is about 3000 ft, remaining as in the previous 0 crosswind. I think what happened is I may have had some brake on the takeoff roll inadvertently, just the way the brake pedals are, kind of. I can't imagine that arrangement; I think I may have had some, a little bit, and they're very sensitive, a little bit of brake pressure, which made my takeoff roll longer and therefore the stopping distance longer down the runway. For 1052, I held it within 5 ft of centerline. Desired is 10 ft, so it certainly was desired criteria. Airplane had good directional control. I put a little bit of aileron into the wind because it seemed like it was trying to lift the wing up a little bit. Certainly there was plenty of control power, and the rudders are directional, to maintain the centerline tracking. And on the roll out, again no problem for 35 knots. Although I did see a significant delta between the waterline and the velocity vector, so we're kind of, according to the simulator, going down the runway in a little bit of a skid. With 35 knots of crosswinds, I guess you need to look at the overall dynamics of that to see how risky that is. To make a long story short, it certainly had plenty of aerodynamic control power to maintain centerline and desired performance. So I will rate: is it controllable,

adequate performance obtainable, satisfactory without improvement? Yes. It would be a Cooper-Harper of 3.

Task 2010, Acoustic Profile Takeoff

Pilot A. There's no flap changes on this one. Vortex fence, is that changing?

The Cooper-Harper longitudinal for the climb: I give it a 1. Laterally: a 2 because of the heading information—you're looking head up, strictly, heading information is kind of missing because you're digitally on the W, flying W. But I would prefer to have a track law that maintains track wings level, unless you command it to do something different.

What do you want—the Cooper-Harpers? Run 25: it's controllable. Is adequate performance attainable, tolerable? You're looking at the takeoff roll? Right; on roll: I give it a 1. There again I didn't pay much attention to the tail strike value. With that pitch rate guidance, it seems like it's a piece of cake. Although it seems as though there's more symbology up there than perhaps needs to be. That certainly gives you a good cue as to the rate, it might even be helpful in some of our existing airplanes. The rotation to liftoff and climb out, establishing a pitch attitude: I give it a 1. Laterally: I have no change in my grading there. What did I give it before, a 2? Yeah. Okay.

I think that typically, at Boeing anyway, settled on a continuous single rotation for all of our airplanes. Unless there's some really special circumstance for this airplane—maybe there are some benefits doing a two-step rotation—I would prefer just a continuous rotation to the target attitude, climb attitude, and just vary the rate according to what the thrust to weight ratio is or whatever, so you have adequate unintelligible; that's what I would prefer. So this—stop the rotate, and then stop, and then accelerate, and rotate again and stop—is unnecessarily a complex procedure, I think. We were rotating at about 180, I think, in the Ames exercise. We had 4-ft tail clearance at 180 knots with a normal 3 deg/sec rotation. Move the V_T to a higher value or rotate slower. At 3 deg/sec sounds like a reasonable rate, so you probably need to rotate later. That was no problem: I'll give it a 1.

Pilot B. Run 34, tracking centerline was relatively easy. Relative infrequent inputs, although the

turbulence was causing very minor deviations, so ... a desired ± 10 ft, I thought, was relatively easy to achieve and the numbers reflect that. Lateral-directional Cooper-Harper: it was controllable, adequate performance was attainable, it is satisfactory and I'm going to give it an HQR of 2. Pilot compensation not a factor, negligible deficiencies, very minor workload in tracking. Okay, so the takeoff rotation: the problem here is in anticipating the requirement of initiation of the rotation, and what I've seen us do in the flare is have an anticipation cue that rises up from the bottom of the display and kind of gives you a feel for what is about to happen. Something like that would be useful. I think that the problem is that you get a little bit behind in anticipation of that in the beginning. Near the end of it, it's the same problem in reverse. I don't think I have quite picked up the flashing cue to the extent that I can use it like it should be used. So there is a learning curve there, I'm sure. The control system is relatively nice. That doesn't appear to be in the way. It appears to be a display phenomenology that is causing any problems I'm having. I'm finding the controls reasonably predictable. It's just integrating the display and the controls that I'm having problems with right now. Let's see ... that kind of covers the problems with rotation. That's why I want a task where I know where I'm going and what I'm doing just to isolate any control problems from display problems, and eventually I'll do that. I'm not capturing airspeed at all. I'm capturing pitch attitude. That's relatively easy again, as far as the control system is concerned. I think the problems are primarily with the display, but there is no rating on that. For lateral directional, I find it's relatively pleasant, it is predictable. It's appropriately sluggish for this class of airplane and I don't have a problem with fine control—lateral—at all. Again it's real easy in the performance. That's it. Continuing on. Commenting on the Cooper-Harper for longitudinal: it is controllable, adequate performance is attainable. Since I really didn't get desired on this, the best I can do is an HQR of 5 and that's what I'm going to do. Adequate performance requires ... that's not true. I need somewhere between 4 and 5 because it does not require considerable pilot compensation for adequate performance. I believe at least part of the time I was within desired performance longitudinal, so I'm going to give it an HQR of 4. Lateral directional: it's controllable, adequate performance, it is satisfactory. I don't think pilot compensation was a factor. An HQR of 2. There is

always workload here but it's not a factor, so I'll give a 2, pretty good. The next segment is the climb phase, then reconfiguration. I didn't notice any objectionable transits in response during the thrust changes. It is relatively... it announces it is going to cut back, and now I am on a steep part of the learning curve, when I'm bringing the nose down appropriately. I didn't think that caused any tremendous problems. It does cause error during that phase but I didn't think it was outside the desired box. Did the numbers reflect that? (Yes.) Again, no problems longitudinally, and as far as lateral directional, I find it consistent with that during rotation—relatively predictable and crisp. Again, keeping in mind that all of these are small deviations, small maneuvers ... I haven't really stressed it yet. Okay, for longitudinal Cooper-Harper for the climb-transition phase: it is controllable, adequate performance attainable, it is satisfactory. For longitudinal: I'm going to say an HQR of 3 and that's for the display-control combination there. It's still... I'm working to keep the magenta dot centered. So its compensation is required; I'm going to give an HQR of 3 for longitudinal. Lateral directional: comments are consistent with before, it's controllable, adequate performance attainable. It is satisfactory and pilot compensation is not a factor, but there is some workload involved, so an HQR of 2 on that. That completes run 34.

Pilot C. Run 6, task 2010; C is the pilot. So the first part is the takeoff roll part. Well let me give the comments first and then I'll give the rating. The first part of the takeoff roll is quite easy to track, whatever line you'd like. It doesn't feel too sensitive up until about 110 or 120 knots or so, and at that point it begins to transition to be, in my mind, just a little sensitive and easy to overcontrol your aircraft heading rolling down the runway. Nevertheless you can still do a pretty adequate job, but you can envision something nicer than that. And you were going to tell me what you thought was in the desired range. Yeah, you bet. Sure. Okay, is it controllable? Yes. Is adequate performance obtainable with tolerable pilot workload? Yes. Is it satisfactory without improvement? I would say no and I would put minor but annoying deficiencies. Desired improvement requires moderate pilot compensation. I think a number 4. I think that is about all I can think about at this point, as far as the takeoff roll is concerned.

I have some comments now about the rotation and the HUD display and things like that. I'd actually need more rotations to give you real good comments about a depth, but I can give you some of my frustrations as I tried to do it. As you approach V_r , there's no indication yet. You don't have the rotation acceleration cues on. Then they all of a sudden show up, and if you happen to be looking at something else, you're already behind [on] them, so there's no transition. They're either there or not there and it's easy to get behind to begin with before you have a clue, and then you try to follow those and it's relatively difficult from following the cues at the end of the waterline. To then pick up the desired pitch attitude waterline wasn't easy and natural for me to transition into that, which apparently causes my overrotations from the max pitch angle things. Just about the time you're figuring out where that pitch attitude is, then bingo, it goes away because now it's liftoff, and you have to change your whole concentration from one kind of picture to a new kind of picture, changing to the last vector on the magenta circle. All of which doesn't seem as natural to me as I tend to think it might be.

Yep, understand. Yeah. Well from that point my pilot frustrations are, in trying to do this task as well as possible, that I first have trouble knowing when I'm going to do this rotation and follow the bars, and then I have trouble transitioning from them to the waterline, and then just about the time that that's getting all settled, then it's time to transition to some other cue. Other than that, the rotation feels quite nice, no particular difficulty with it. I'll try to do a Cooper-Harper for it now. It's controllable, it's adequate performance obtainable with tolerable pilot workload, yes. I'd give it satisfactory without improvement. Again, I'm going to give it a 4, minor but annoying deficiencies; desired performance requires moderate pilot compensation and just my frustration in trying to do the task. Yes and we need to address the lateral directional, I guess.

I don't have any memory of having difficulties with the roll axis during the rotation part. I do have some comments about the roll axis in the next sequence. The major aspect of this was the pitch balance. Again, the rotation doesn't seem bad at all from the pilot standpoint—it's just somewhat difficult to meet the parameters which we've specified for ourselves to do here on the individual display. Therein underlies my minor but annoying deficiencies in

trying to do these tasks with those displays. If you separated, you have a separate block for lateral? So I'd say it's satisfactory without improvement for the rotation part, yes. And I would think that there are some mildly unpleasant deficiencies and minimal pilot compensation required for desired performance and negligible deficiencies. They had some feelings of disharmony between the pitch and the roll axis on the size of the breakouts and things that made it less than real smooth and good for me to do the roll task. Right. My inclination again is that basically the flying of the airplane feels quite good with the possible exception, it seems quite easy to cause an abrupt pitch input and/or roll input that perhaps passengers wouldn't like, from the way these things are set up right now. The following of the task direction on the magenta circle—earlier I expressed my concerns with that a bit. In order to put the magenta circle inside the velocity vector requires quite a bit of my concentration—more concentration than I think I should devote to that task. If I relax that parameter a bit so that I can look around and absorb the rest of the things I should be doing as a pilot, then my tracking performance of that magenta circles falls off. Nevertheless, my piloting intuition says that I'm doing a perfectly good, desired job of flying this airplane the way I should, except that I should keep that little magenta circle inside the velocity vector isn't the right kind of tolerance that we should be doing. So I became more aware of this phase of the departure, more aware of the disharmonies between pitch and roll, and the idea that it's quite easy to bump the passengers around a bit, or more than I think I should, but it's too easy to bump them around a bit. So now let's turn to the Cooper-Harper rating: So the pitch axis, is it controllable? Yes. Is adequate performance obtainable with tolerable workload? Yes. Is it satisfactory without improvement? For the pitch axis task as presented to me, I would say that some minor but annoying deficiencies, again a 4. And my problem is, I'm having to put more concentration to keep that little circle where I'm told it's supposed to be than I would like to have to, although I feel if that requirement were relaxed, then I would easily give it a better rating than that, but put it in there a 4. Lateral directional: Again, it's satisfactory without improvement. I guess at this point I'd still say yes, though there are some mildly unpleasant deficiencies, minimal pilot compensation required for desired performance, a 3, and that's for what I've already discussed. Too easy to give the passengers a rough ride in roll.

Pilot D. Pilot D, acoustic takeoff, task 2010, it's run 10, and the task is fairly easy. The airplane handles very nice. It's mostly learning how to adapt to the display issues. There are several display issues. There are several elements you have to transition between. During the rotation you have the pitch rate cues, then you have the desired pitch attitude, tail strike you've got to monitor. Then you have to pick up the gamma command fairly rapidly, then you have to monitor radar altitude for gear retraction. It is precognitive to learn where to look at what particular time. Other than that, the airplane is pretty easy to fly. The flight director does have a little bit of a tendency to cause you to overcontrol. Other than that, the task is pretty good. Okay, takeoff rotation: lateral is not a factor in any of these. Okay, Pilot D again. Pilot ratings for task 2010, run 10. We are going to rate the centerline tracking first. We'll just give that a single rating. It is controllable. Adequate performance attainable? Yes. Is it satisfactory without improvement? Yes, I think it is—improvement not required. There is a little bit of a tendency to S-turn in heading, just a little bit, so I would say, fair to lightly unpleasant characteristics, some compensation required. Let's give a pilot rating of 3. Okay let's move on to the rotation and we'll give that two ratings—latitudinal and longitudinal. The task is a little more difficult here—mostly a display element issue. I had the same problem with the display at Ames. As I said, it is a tough task. But it is controllable. It is adequate. Is it satisfactory without improvement? No. I would say that it does require improvement, but it is a display issue, not an aircraft performance issue, and I should rate it that way, but we can make it into a comment. Is it okay to rate display issues that way? (Yes) It's got some issues that require improvement—not bad—minor but annoying, and so there is some pilot compensation required in here. And there are two things ... and it's mostly the display. The actual physical rotation of the airplane seems quite reasonable. There are two display issues. There are a lot of display elements that need to be brought into the scan, and the thing that I think would really help here the most, at this time, is to improve the contrast of the display—the readability of the display. So let's give a 4 for longitudinal. For lateral we really get up to: it's satisfactory without improvement. There's very little task laterally, and there's no deficiencies to cause any problems. Let's give it a 2. Okay now, moving on to the climb: It is controllable. It is adequate. Is it satisfactory without improvement?

Give it a 4. Again, I would say it requires some improvement. Again more of a display issue than anything. Let's make it a 4, and the display issue there, other than, I think, of course, the contrast issue [which] bothers me a little bit, is that the flight director command is bouncing around a little bit. Seems like that could be smoothed down to decrease the workload. Let's make it a 4. And laterally, it's almost a nontask again. Let's make it a 2.

Pilot E. Okay this is Pilot E on the 1st of December, first run, the acoustic profile takeoff—we did two runs. I am ready to rate it. I'll give the rating first and then comments. On the runway centerline tracking, let's get a Cooper-Harper here: It was controllable. Adequate performance was obtainable. Satisfactory without improvement. I would say yes and give it a 3, though I think it's borderline Level I and Level II, because at about 150 knots or so it becomes really sensitive in directional control. I was really having to work hard, and very slight rudder-caused deflections resulted in that posterior aggressive note; so what I think we can do is, obviously, maybe change the gains on the rudder pedals ... you know ... with speed or speed quotient or something like that. It wouldn't be quite so sensitive. It appears the sensitivity rudder pedal stays the same almost when you get higher \bar{q} , and you get a lot more sensitive rudder control. It was really kind of squirrely, I thought. So it's kind of, to me, a borderline 3 and 4 because of the rudder pedal sensitivity, but I think that is easy to fix. The next rating item was the takeoff rotation. After kind of learning the technique on the first one, I thought I did a pretty good job on the second one within a tenth of a degree of target. So that was not too bad and again I would rate that: controllable? Yes. Adequate? Yes. Satisfactory? Yes. I am going to rate that a 3 because it does take a certain amount of pilot compensation. You're pretty tightly in the loop to accomplish that. But obviously with effort you can make it desired criteria. Let's see, climb with configuration changes. For this one, the score card I think tended to bias itself by the fact that in the main part right after rotation, when you established this takeoff attitude, you don't want to exceed takeoff rotation maneuver; very quickly the guidance command calls for a fairly aggressive pitch-up maneuver and it diverges from your actual gamma, which you set the takeoff attitude you break ground, but your gamma is very, very shallow and immediately the guidance command—the fairly

steep—gamma sort of cuts during the cutback, so you're going to get the divergence and you're not going to immediately be able to track that. I chose not to be terribly aggressive on that; so I think probably the guidance command is a bit aggressive. I think my divergence from the guidance command and what I actually did is what showed on the score card as less than 90 percent of the desired range. But I thought that the climb, the configuration, changes. I thought my performance met desired criteria—if you throw out that part initially where I had to converge on command. So with that in mind, it was controllable. [Adequate results] were obtainable. Satisfactory without improvement? Yes, I will rate that a 3. Also, my own comment is that the guidance command was a little bit jumpy. It kind of jumps around a little bit, which made for a little bit of an annoying task when you are trying to kind of try to converge on this guidance command. It probably needs to be filtered somewhat so it's not quite so jumping around. Yeah. It just kind of bounces around. Yeah. Right. So that is something I think I would want. Obviously, if this is the design, I would want to have that better. And also I think I would have a more or less aggressive initial command for your attitude. The other thing is, on the cutback, the push-over I think is too aggressive from passenger point of view. It's just strictly a minor comment. Obviously, aerodynamically you can accomplish the maneuver, but it is a bit aggressive in the pitch over.

Task 2030, Acoustic Programmed Lapse Rate Takeoff

Pilot A. For this PLR takeoff program lapse rate run number 11. It's very easy to track the centerline; however, I notice in the initial conditions we start out left of the centerline. I don't know if this is from the pilot's eye. Do you have a different view than I do? Same view: centerline. Looks like we're slightly left of centerline so you have to correct over to it. I don't know how far that is. But in any event, rotation is normal. As soon as you reach the target rotation rate, very shortly after that you're 5 ft positive rate, gear up, and then it becomes a very simple task of letting the flight-path vector come up to about 4° and capture that, and it's just an extremely easy, simple, and straightforward maneuver. If that gives a low noise level, that'd be great.

I don't see any problem; I've been noticing that the airspeed and altitude digits next to the flight-path

vector symbol are difficult to read. They need some kind of background contrast, or make the digits bigger or something—the same size as the digits up there in the upper left corner for ground speed, Mach, and g .

I would say, one for unintelligible. What is it I'm looking at here on pitch control? My impression was that it was perfectly satisfactory. I don't see how it could get much better. I'd give pitch a 1, 1 for lateral, good lateral guidance. I'm not sure what I'm looking at here either. Ninety-six percent, I'd say that. I'd give it a 1, no problem. No problem at all. That looks like a real viable procedure to me. You go from one rotation to a stable attitude and everything is stable—no large pitch attitudes. Looks great.

Pilot B. Run number 36. Easy tracking runway once we got the turbulence down. It was very much like before—very minor corrections required. Relatively desirable, no major problems, ± 4 ft with desired being 10, so nothing reflected. As far as Cooper-Harper: it was controllable. Adequate performance without improvements and pilot compensation not a factor. Negligible deficiencies. HQR of 1.5 this time. Real easy. I think there is a steep learning curve here, obviously. For takeoff rotation, as far as problems with rotation, no problems. Very minor control inputs, I'm certainly not stressing the control authority at least from the standpoint of stick deflection. The pitch attitude was easy to establish; major problem was capturing pitch attitude. I wasn't capturing the climb airspeed, and tail strike did not occur. No major problems again. I think there is a learning curve involved here. When I got the pitch, I hesitated [at] the $10\ 1/2^\circ$ point, so it's becoming easier to see what's going on as far as the display. And lateral directional: once again as always, not a major problem, very minor inputs to correct. Okay, for longitudinal Cooper-Harper: it's controllable, adequate performance attainable. Satisfactory without improvement? Yeah, there is no doubt in my mind at this point. I now see what's going on at about 11° . That hesitation is fair enough. I'm going to say I got desired performance. I'm going to give an HQR of 3. Minimum pilot compensation required for desired performance. For lateral directional: it's controllable, adequate performance attainable, Sat without improvement, HQR of 2. Pilot compensation not a factor, negligible deficiencies, and the deficiencies, if you can call them that, are just very, very slight pitch pointing problems. Nothing

significant. Okay for climb and configuration changes: no objectionable transients in the aircraft response. If anything, it's easier than the previous task because the thrust changes are considerably smoother than they were before. So I'm not noticing the tendency to have to chase the magenta velocity vector or magenta diamond. So it's real easy to control, I thought easier than before. Longitudinal: it's controllable, adequate and satisfactory without improvement, give it a 2.5 on longitudinal. Very, very minor compensation required, somewhere between none and minimal. Relatively pleasant. Major problems again are these small inputs. Lateral directional: controllable, adequate and satisfactory, and pilot compensation again not a factor. An HQR of 2. Lateral directional axis: (We need integer ratings if possible.) Okay, round all those 0.5's up.

Pilot C. Run 9, task 2030, C is the pilot. The first task is the runway centerline tracking and my comments are that this is a very nice-feeling acceleration. The passengers would certainly like the feel of this during the acceleration. It gives the pilot lots of confidence in its ability to keep it right on the centerline until we get again to about a hundred knots. And then it's quite easy to have a low-frequency oscillation from side to side, which is not as nice as it could be in the steering there as far as the centerline. Go through the Cooper-Harper rating: is it controllable? Yes. Is adequate performance obtainable with tolerable pilot workload? I'd say, yes. Is it satisfactory without improvement? I'd still find that I'd answer no to that—minor but annoying deficiencies, and that's the low frequency oscillation I get down the runway above 120 knots. Desired performance requires moderate pilot compensation and a little bit of apprehension feeling while that is going on. It's a Cooper-Harper 4 in my mind.

Yeah, at least the thing that's driving this annoying thing is the different thing on the runway than in the rotation. Okay, go into rotation now? It says inadequate, but I just don't agree with that thought. From what you asked me to do and the way the airplane behaves when I do that, and pulling up to that cue, it certainly looks like desired performance from my viewpoint. Sure. Okay, either I'm getting [it], my learning curve is improving. I think it's still significant through these first six runs I've done. So it's the rotation coming up to the rack, and the pitch attitude is getting more comfortable. However, I still have the quandary—the large change in pitch reference from

doing pitch job and trying to track that particular thing down to the flight-path marker seems a little strange. So the rotation part is okay.

The lateral directional axis: I don't notice anything really much to comment on there. It's about the same as it was before, during the rotation. If anything, the rotation feels more comfortable in this mode than it does in the previous mode. Yeah, and when the transition to 4° seemed more normal than the transition to the little magenta circle from before. So anyway, it seemed a little nicer in the rotation, I think, in the pitch axis than before, and the roll axis is about the same. So, Cooper-Harper rating scale: it's adequate. Performance obtainable with tolerable pilot workload? Yes. Is it satisfactory without improvement? I'm going to say yes. There's some mildly unpleasant deficiencies. I'd give it a Cooper-Harper of 3, which reflects my slightly improved feeling of confidence and that there's less concern during the rotation. Yeah, it'll be the same thing for lateral directional, Cooper-Harper 3.

(So this is the climb portion, and it looked like you tracked that right on.)

As far as I'm concerned, it was desired, with the exception when I tried to do the task as you state and keep the little circle under the line, I began to have the problem with the lateral direction—the tendency to chase around it. And I would call that tendency to chase back and forth desired. In the climb-up phase, I thought the airplane felt better from a handling qualities standpoint than from a ride quality standpoint and the passengers ... Also, the one noticeable point there is the pushover: there's not near as much high-up control and activity required to push over as its throttles are reduced, and I'm sure that the passengers would appreciate the ride much better. The only difficulty I have is shortly after liftoff, it seems as if the clearance from the ground happens less positively, and you have a sinking feeling for a while, but it's hard for me at this point to describe it. Better than that, there's a slight sinking feeling, and then that shortly goes away and I feel confident in the airplane at that point. So then I'll try to give it a Cooper-Harper rating. I'm going to say, is adequate performance obtainable with tolerable pilot workload? Yes. Is it satisfactory without improvement? For the pitch axis I'm going to say, yes [but] there's some mildly unpleasant deficiencies,

Cooper-Harper of 3. Basically, it's improved over the previous one because of just a better ride quality and less pilot workload in dealing with pitch axis. And for the lateral directional, it's still satisfactory. I'm going to say it's not satisfactory without improvement because this time the pitch axis wasn't near as much of a problem, and I began to see characteristics in the roll axis that I would describe as minor but annoying deficiencies. Desired performance required moderate pilot compensation and it's a Cooper-Harper of 4, and that's the wandering back and forth trying to chase the little magenta circle. My normal pilot tendencies, in processes like PIO and anomalies, I have to compensate for in order to kill it.

Pilot D. Pilot D, task 2030, run 13. It's just a minor variation on the task we had previously, which was the acoustic takeoff. Learning curve was pretty ... was actually an easier task because the climb rotation is not nearly as severe. There's no ... essentially, once you set the climb gradient, it remains the same throughout the task so it really is a pretty easy task. Much easier than the acoustic takeoff. Going off the air here for a second.

Okay. This is the pilot ratings for run 13, which was task 2030, the PLR takeoff. The centerline tracking is identical to the previous task, 2010. We'll give it the same pilot rating of 3. The rotation ... we're a couple tenths of a degree off and essentially the same task as the previous task. Let's go ahead and make that a 4 and a 2. The thing that's really different is the climb profile. Continuing with the climb rating: it's definitely an easier task than the ... the climb task is easier for 2030 than for 2010 just because the profile is so much less aggressive. Is it controllable? Is it adequate? Is it satisfactory without improvement? Yeah, there's a little bit of a ... yeah, it's pretty darn good. Let's make it, improvement not required; let's make it a fair, some mildly unpleasant deficiencies, again I think mostly just display readability issues. The airplane is really quite easy to control. Let's make that a 3 and a 2 for the [longitudinal]. Lateral of course is the same. Let's make lateral a 3 here. I was noticing that I was working laterally this time because there was so little to do longitudinally. There is a little bit of S-turning back and forth on lateral. Yes, again, the airplane is really pretty good for the straight-ahead task like that. Not giving lateral a universal rating yet, but at least for this task the lateral is quite adequate.

Pilot E. Okay, this is task 2030, the acoustic PLR takeoff. A lot of my comments will be [the same and] I will not repeat from the prior cutback takeoff. The single-line tracking basically is the same as the previous task. Rather than spend the time going through it, I am going to rate that the same as the Cooper-Harper of 3, again, with the comment that it gets to be a little sensitive to the higher speeds just prior to rotation. Takeoff rotation, the climb gradient capture: again, I don't see any difference between this task and the prior task, and the rating remains the same—most generally it's a 3. Lateral directional: I think I am going to stick with my 4 because nothing really changed as far as my opinion that right prior to rotation [it] is a little bit sensitive, and I feel like I am on a knife edge almost. The climb with configuration changes longitudinally: again, the same, it's much more benign task because the gamma changes are very, very mild compared to the prior ones. However, I am afraid that, Cooper-Harper-wise, it still takes pilot compensation, so it's difficult to ... pilot compensation does remain a factor, so that is going to be a 3. Lateral directional will also be a 3 for the same reason. My overall impression though, is this is a much easier task than the prior task even though the ratings are identical. There is still pilot compensation required, but it's a much lower level than the previous maneuver, and the more shallow gamma you have to obtain [makes] a much lower workload than the 15 percent or whatever you have to get on a prior maneuver. So overall ratings between this one and the first takeoff are the same, but this is an easier maneuver to accomplish, and within the individual ratings I would say this would have a higher ... like the first takeoff was borderline 3/4 for lateral-directional control for centerline tracking. And this is in that case probably also similar, for this one certainly tends to be more towards the 2. Cooper-Harper 2 for the climb with configuration changes, rather than a 3, although compensation was required.

Task 3020, Transition to Level Flight

Pilot A. Okay, this is run number 32, task 3020, transition to level flight, A the pilot. Cooper-Harper longitudinal rating: is it controllable? Yes. Is adequate performance attainable with tolerable pilot workload? Yes. Satisfactory without improvement? Gee, depending on what your standards are, I'm going to say no. The deficiencies require ... it's Level II ... the deficiencies require improvement. I'm going to call it, well,

it's between a 4 and a 5. Are you guys doing intermediate (ratings)? I'll call it a 4. The reason for the improvement is, it's awfully easy to inadvertently get g levels that are unacceptable for airline operation. If you got somebody up and walking around in the cabin, you don't want to inadvertently go to $0g$ on a push-over. There's no deterrents here in the forces in the stick displacement to that sort of maneuver. The forces are quite light, and so it might be okay for a fighter, but it's not—I don't think—appropriate for a transport airplane. You have to be very careful of that. It looks like it takes about 500 ft of lead time. You need just a little over 10 percent—probably 15 percent—of your rate of climb in terms of lead on level off, and that is the main concern for improvement, is the forces in terms of changing flight path. There needs to be some kind of g sensing and feedback into the pilot's control; stick force for g needs to be considered. Okay, so lateral directional: I give it a 0, is it controllable? Yes. Adequate performance? Yes. Satisfactory without improvement? Yes. I'm going to rate it a 2 because I think the workload could be even lower with a track hold feature for level flight. This is basically a level flight operation. Also I think that you could improve the speed hold capability with manual throttles if there were a flight-director-like device that would tell you where you need to put the accel/decel caret to get a nice transition back to level or back to the speed you want, and that flight director cue guiding you for the accel/decel should take into account the effect on pitch, so there's no rapid ... so you don't inadvertently, rapidly jerk the throttles back. So if you were flying a program decel to capture a speed, that your movements are not creating problems with flight controls.

Pilot B. It is 11:30, the pilot is B, this is run 31, task 3020, transition to level flight. The task being to transition to level flight from a climb to flight level 270 is what I chose at $0.95 \text{ Mach} \pm 0.001 \text{ Mach}$. Five knots is really not applicable here ... 2° heading, 2° bank angle, and one 100-ft maximum overshoot. Desired performance easily obtainable, both longitude and lateral directional. The only comment being the forces are a little bit light for this class of airplane. I think I have made that comment before, but other than that it is entirely doable. Longitudinal HQR: it's controllable, adequate, and sat, minimal pilot compensation required. Let's say, pilot compensation not a factor on this one. This is pretty easy. HQR is 2. Lateral directional: controllable, adequate, sat. And once again,

pilot compensation not largely a factor, HQR of 2. End of comments.

Pilot C. Okay, [tape] B, December 1, 1995, Ref-H assessment test, C is the pilot. Okay, this is run number 64, task 3020. It's a transition to level flight, and we are to evaluate the ability to maintain airspeed during change in climb rate. Evaluate coupling between airspeed and flight path. Well, what I found was, if you try to do it rather quickly, you can start with about a 200 ft/min or a 200-ft lead, then you have to move pretty promptly and bring the throttles back pretty abruptly, and at that point you see an unusual pitch-down, followed by a pitch-up as a throttle transient is [coming in]. You can actually get quite good performance out of it, although I think the ride quality through that would be objectionable. However, a more typical kind of lead point of, oh, 500 to 700 ft makes the program a little more manageable from passenger standpoint and also probably a little easier, although it takes perhaps a little more workload to do it in a more gradual sense. But you can keep what I consider to be desired airspeed and desired level-off altitude, then do it pretty well, so here comes the Cooper-Harper rating: controllable? Yes. Adequate performance? Yes. Is it satisfactory without improvement? I'll say no and give it minor but annoying deficiencies. Desired performance requires moderate pilot compensation; that is, you have to avoid the abrupt power reductions because of the interaction with the pitch axis. And so that's kind of minor, but it typically can be avoided, so it's a minor but annoying problem. Cooper-Harper 4. And that's (lateral?) No. Did you want a rating there? If you want a rating, it's going to be satisfactory without improvement, Cooper-Harper 3, I would say.

Pilot D. Pilot D on December 13 again, task 3020, run 19. It's a pretty easy task. At this Mach number you don't have to be too concerned about the gamma dot rate, but there's a couple of display problems here I'm going to down rate it on longitudinally. Number one, X-double-dot has too much lag, the X-double-dot chevron makes it hard for it to set, and then the other problem is, there's no analog [in] either altitude or altitude error. Some sort of follow-me symbol with your reference altitude set on would be very helpful here. And I had seen that used on the Ames VMS. So longitudinally: I'm going to give it a 5, moderately objectionable deficiencies, even though we did get desired performance. Lateral: it's kind of a nontask,

and I'm not even sure we had any criteria. Yeah, and we had some desired. So let's give the lateral for this task a 2.

Pilot E. [Pilot E did not rate this task.]

Task 3022, Transition to Supersonic Cruise

Pilot A. Okay, this is a level off at 51000 ft condition in supersonic cruise, 3020 is the condition, and the run number is 33. I'm sorry, 3022 is the condition. And longitudinal Cooper-Harper: is it controllable? Yes. Adequate performance with tolerable pilot workload? Yes. Is it satisfactory without improvement? This task didn't require very large attitude changes and so I would say yes in this case. I think that we will give it a 3, because of primarily the displays that are available. The head-down seems to be as good perhaps as the head-up in this case or in ... rate information is a little more obvious, rate of climb, altitude deviations, perhaps displayed a little better. The force to get a substantial change in vertical speed is quite small, and it would take some tuning required to get the kind of fine tuning that you would like to have on altitude hold. Maybe even altitude capture type of a mode might be appropriate here. The thrust requirements were very small, and essentially, full thrust is required at this altitude so that the level-off test—the actual scenario—is not necessarily completely realistic because of the lack of thrust on the engines. The lateral-directional Cooper-Harper: is it controllable? Yes. Is adequate performance attainable with a tolerable pilot workload? Satisfactory without improvement? I found it ... I would say it could ... I'm going to say, no. I think it's a 4, and there's some minor deficiencies, mostly the requirement to maintain bank angle is, if there's any; it takes a long time to change heading at a small bank angle, and the maneuvering at this altitude has to be kept very shallow. I think that once again a track hold would be quite helpful when you get the wings level so that [you can control] minor divergences of heading.

Pilot B. Task 3022, transition to supersonic cruise. Basically the same thing we just did, only in a supersonic climate, 2.3 Mach instead 0.95 Mach. The task is to keep the overshoot within 200 ft deviation of the Mach, within a hundredth for desired in all of these, by the way. Deviation heading of 2°, deviation of bank angle within 2°. All of this was doable. Very minor

problems in setting the longitudinal axis. A little bit more than 0.95. Again, nothing major. Okay, longitudinal HQR: it's controllable, adequate, sat, and minimum pilot compensation required for desired performance, HQR of 3. Lateral directional: you can essentially ignore, it's controllable, adequate, and sat. Pilot compensation not a factor; HQR of 2. End of comments.

Pilot C. This is run 65 on 1 December, C is the pilot and 3022 is the task number. Adequate performance is obtainable and it's satisfactory without improvement. It's fair and some mildly unpleasant deficiencies. Minimal pilot compensation required for desired performance. Cooper-Harper 3. That's kind of a milestone. That's the first pitch task. There may have been another snuck in there, but not very many, and lateral again is no factor. I will give it a Cooper-Harper of 3.

Pilot D. Pilot D on December 13, task 3022, this is supposed to be a Mach 2.3. Actually, not a Mach 2.3, actually a 475-knot level out at 51000 ft. The engines just don't seem to have enough thrust reserve to really make it a reasonable task. Well, we end up playing energy—more of an energy management task than a level-out task. You can level out any time you want very easily. And there's a little bit of a display problem. It seems like the X-double-dot is not referenced to the EAS as the task required. In any case—longitudinal: I'm not sure what to give it; we got there ... let's give it a 5. And the lateral is a nontask; let's give it a 2; there's no bad characteristics associated with the lateral. Let's give it a 5 and a 2.

Pilot E. Okay, 3020, transition to level flight, run number 36. Not a difficult task. I tried to wait till about less than 200 ft prior to the altitude to start the recovery. I made what I considered to be a fairly aggressive recovery, considering this to be a passenger-carrying airplane. I was able to meet all of the desired criteria using the acceleration diamond. I was able to adjust the power properly and kept everything right where it should be. I didn't see anything unusual, no coupling, no tendency to overshoot or PIO; so for longitudinal task: controllable? Yes. Adequate? Yes. Satisfactory? Yes, a 3 because definitely it takes some compensation to know when to make the attempt to put in a proper control input to smoothly capture the level flight gamma. Lateral directional: I didn't notice anything untoward; the heading and bank stayed right

together. Controllable? Yes. Adequate? Yes. Satisfactory? Yes, 2. I don't recall having done anything to have made the lateral axis work better.

Task 3030, Profile Climb

Pilot A. Okay. The takeoff was normal. I could maintain the heading. On the takeoff roll, the symbology sort of obscures the end of the runway a little bit. You try to point the airplane down the runway, but the final endpoint that you are aiming at is a little bit obscured by the symbology; that is a little distracting to me. The rotation forces seemed normal, feedback was good and that was not a problem. When the pitch attitude is extremely high initially after takeoff, it's a little difficult to scan down and pick up the heading. If you have vector—a flight director that kept you on track—that would be helpful. The comments I think I gave as I went along, I initially tried to track the magenta circle, but it looks like it was taking me in the wrong direction, so I reverted to this altitude and airspeed profile and the trend vector that it has and tried to capture the speed profile. The trend vector on that particular display becomes less valuable as you climb. And it would be good to have on the flight velocity vector a speed deviation from the desired speed, and you would need to see what the desired speed is being indexed to [and] some way of showing what speed that is trying to take you to.

Cooper-Harper: is it controllable? Yes. Is adequate performance attainable with tolerable pilot workload? Yes. Is it satisfactory without improvement? Well, I would say ... depends on whether you want to work some minor difficulties ... I would say yes. Mildly unpleasant deficiencies, improvement not required—well actually, I think I would say that it probably needs some improvement in terms of the displays and information given to the pilot. There's no problem physically. Flying profile—everything's happening so slow, that you just need to provide some information to the pilot so that that's easily done. Most likely this will be done on an autopilot, all automated. Give it a [CHR] 4; minor annoying deficiencies are primarily in the displays and cues for the pilot in terms of holding airspeed. Some of these displays are helpful, but I think they need to be improved.

Lat dir: I would give it a 4, because of the constant need to have to adjust the wings level and track heading. I would just as soon have a constant track or con-

stant heading when the wings are level for a period of time.

Centerline tracking seemed to be adequate and conventional and nothing abnormal about that at all. I did notice when you hold the brakes and apply power, the pitch attitude didn't seem to change any, which it normally would by pressing the nose strut a $1/2^\circ$ or 1° , or something like that, and there wasn't much rebound when you release the brakes. Usually the nose will spring up when you release the brakes. Holding centerline was no problem. Rotating, I would prefer a fixed bug on here. I don't know if you have bugs on your head-down display for V_1 , V_r , V_2 , or not. It seems like they should have those bugs on there. Frankly, I can read the airspeed tape head-down a hell of a lot better than head-up. The airspeed readings, runway background, sky background, their speeds flashing by quickly are sort of difficult to read digitally. It's easier to see if something's happening down here on this vertical tape, or on analog round dial airspeed and so just having marks. I think on a [Boeing 777] we have a V_1 oral call out, which is automated call out. The other pilot calls V_r . That works pretty good.

Establishing the initial pitch attitude with the magenta-boresight that flashes, that was up so briefly that it just seemed like you were pitching up, you ought to be able to see where it is you're going, where it is that box is taking you, and I don't recall seeing the tail strike. Right now that tail strike is up about 15° . Is that correct? It sure looks like a 15 at first glance, I see it's a TS. I think I got it enough to where I can read it. The guidance cue for flight-path vector seems to be a little jumpy. But, some kind of analog—the rolling digits for the cueing for the 800 ft—is a little bit lacking on a standard digital altimeter. You'd have a bug probably set for your cutback altitude. You'd have an analog—clear and distinct indication of when you were coming up on cutback—because that's fairly important. That's a little bit missing in the head-up display. I guess that's all, unless you have some specific questions that I didn't answer.

Runway centerline tracking is a 1. I don't think you can improve on that. I didn't see any problem with that, and the rotation, I'd give it a 1. Actually, why don't you make that a 2, because of the means that you are using for initiation of rotation. Of course you're

calling it out, but it's a little hard to read those numbers, but the physical rotation itself is not a problem.

When you pitch up to the 10° or beyond the 10° pitch-up, you lose the heading scale completely, so you have no idea what your heading is. Did I give you a Cooper-Harper for the lateral directional? Make it a 2, because you lose your analog horizon: of course you've got the heading information heads down.

Pilot B. Okay comments for run 79, task 3030, profile climb. The task was to fly the profile. Bank angle control and deviation heading were what was being looked at. Now, there were some deviations in heading during the run, but I am not going to penalize the system for that because when I wanted to maintain heading I could, and bank angle control similarly—when I wanted to maintain it I could. So really, no flying quality problems longitudinally or laterally. I would suggest that maybe this task ought to have another task to maintain the climb profile within a half-circle diameter to task the longitudinal axis a little bit more, because right now there's no task associated with the longitudinal axis. And also there's a problem in performance in that we could not get above about 39000 ft at about 1.4 Mach. Okay, longitudinal HQR: it is controllable, adequate, and satisfactory, and pilot compensation largely not a factor for desired performance, HQR of 2. Lateral directional: controllable, adequate, and satisfactory, and again, pilot compensation not largely a factor for desired performance, HQR 2. That concludes the comments.

Pilot C. C is the pilot, morning session, side A. Good morning. This is run number 5, and it's task number 3030, and it's 1 December, and C is the pilot. The climb profile task is quite easy from the capture of the meatball after takeoff. So the overall pitch task is quite easy to do with just following the meatball, and that keeps you very well on the profile. Trying to use the little predictor on the profile display is significantly more difficult and takes your attention away from outside other tasks, so it's really not an acceptable way to go, I think. The finesse in the handling qualities in the pitch axis we talked about before. When the meatball moves out a little bit, there's a tendency for you to want to move the nose either up and down in the proper direction and that causes you to ride in the breakout. You feel like you are pushing, pushing, pushing, just gently, a pound or so, and then you try to

move just a little bit more, and then the command marker just jumps down. I programmed them out. Not a real smooth and precise way to fly the airplane. It makes it so that the passengers—I don't think—would like the ride as you do that, because it moves in steps. You can't get a nice fluid motion with it. For the first part of the climb from takeoff, I hardly touched the stick and roll at all, because the breakout and control law just keeps a heading locked on, which is not very realistic, I assume. When you try to fly, it is pretty easy to select about a quarter of a degree of bank angle to bring the heading back very slowly, so I think that the heading control is quite nice. Yeah. When you try to do a fluid kind of maneuver, where you do a pitch and a roll maneuver to bring the heading and pitch back to where you want to go, that occurs in little, jerky steps. The motion base gives you kind of a jerky ride. Which, if that is real, I don't think the passengers would like very much. Okay, is it controllable? Yes. Is adequate performance obtainable with a tolerable pilot workload? Yes. Is it satisfactory without improvement? I am going to say no, because I am thinking about the part of this task of the smoothness and the preciseness with which I can maneuver the airplane and give the passengers a good ride. And for that, I do not think that it's desired performance yet. I think it's just adequate performance—requires considerable pilot compensation to try and make that ride as smooth as possible for the passengers. But the mechanics of the task and doing it actually are not as bad as what I feel about that ride quality part of this thing. In other words, we can get desired on the heading and bank angle tasks quite easily. Yeah, not for what this airplane is supposed to do, I think. So that's why I feel like that part of it is not adequate at this point or it's not desired, it's adequate. It requires me considerable work to do that job and be as smooth as I can, so that gives it a 5. (Longitudinal or lateral directional?) Both—because I find that same kind of characteristic in both axes, and that is when I was trying to show you that fluid motion there and feeling the jerks in the airplane is where I go from there. That's about all I have to say.

Pilot D. Pilot D, December 7, we just did the profile climb, just did one, 3030, it was run 55. And after the takeoff, once you get on the profile, it's just a very easy task longitudinally. Laterally, it's a little confusing. It just kind of goes wherever it wants to. Let's rate it longitudinally after we get established on the profile not the climb, because we already rated climb and, you

know, it's a fairly complex maneuver. This is a very simple and easy maneuver. Let's give it a 3. Some mildly unpleasant deficiencies. A little hard to make real small inputs on the stick. It's just some room for improvement. Really pretty good—3. Laterally: I'm not sure how to rate that with the flight director. But if you take the task as maintaining heading, then there's definitely down to a "needs fixing." Let's give it a 5. So a 3 and a 5.

Pilot E. Run number 18, 3030, the profile climb. A fairly easy task, all in all. I mean, you got to constantly pay attention because the flight director is ever so slightly varying many times, so you can't just totally ignore the task. Even though Bruce had warned me many times not to be following the flight director in the lateral axis, a couple of times I did. For some reason, even though I think I had some input on where the heading digital readout was displayed, I seem to continually miss it. And once I recognized it was there, then it was easy to maintain heading within, easily, a degree. If I had been really tightly in the loop, it would have been no deviation. So basically the task is certainly doable. It is with this control law, it is not difficult at all. I guess there's no real comments. Obviously, we know the profile climb has some errors in it, but as far as following the profile, it's not difficult at all, given the guidance. Following the guidance circle, you don't even need the display. The display is kind of interesting because it can let you fine-tune the guidance, so the display actually is a little bit more of a vernier type of tool than the actual guidance circle. The guidance circle is very easy to follow. So, see evaluation basis, I'm supposed to check the handling qualities of profile climb. Okay, lateral directional is really not an issue. Basically, if you don't get sucked into following the guidance circle, it's not an issue at all. In longitudinal it's also very, very easy. So, controllable for longitudinal: controllable? Yes. Adequate? Yes. Satisfactory? Yes. And this is going to be a 3, because pilot compensation is continually required, though it's not a difficult task, which forces it to be a 3, in my opinion. For lateral directional: controllable? Yes. Adequate performance? Yes. Satisfactory? Yes. Also, a 3. It does take minimum compensation to maintain the wings level. There is for either ... whatever reasons ... there is a certain coupling or a certain tendency to occasionally ... you set up a slight bank angle and it's probably more of a control law, control side stick, controller harmony issue, not necessarily, although it could be aerodynamic. It could

be that we have a slight, maybe ever so slight, speed or spiral divergence problem or whatever, which so far we have not had a task that would bring out. So that's it, a 3 and 3.

Task 3040, Level Flight Transition to Climb

Pilot A. These are the comments on 3040, level flight transition to climb, last run number is 35. Longitudinal ... wait a minute, we don't even give Cooper-Harpers on this one, do we? Is that right? Okay, longitudinal Cooper-Harper: is it controllable? Yes. Is adequate performance attainable? Yes. Satisfactory without improvement? Yes. And improvement not required. This particular, I think I would give it a 1 on this one, pitchwise. It's very, very easy. The only difference that I would make is ... the comment I would make ... is that for a flight-path response airplane, the flight-path angles would be perhaps more appropriate than actual rates of climb. And so, therefore, some kind of target on the target rate vertical path, that you can go to for the pitch attitude or the flight-path marker, would be helpful. It would make it even easier. And so let's see, let's go to Cooper-Harper, lateral: is it controllable? Yes. Adequate performance? Yes. Satisfactory without improvement? Yes. Actually it's quite easy. Let's give it a 1 on this one because it's really not a problem at all.

Pilot B. Okay, comments, run 46, task 3040, level flight transition to climb. Started at 10000 ft, 1500 ft/min, ± 50 ft is what it says. I am going to assume that is a short-term goal. I don't think in the long term you really need to control it that closely. Bank angle, 2° max for desired deviation heading, to 2° max desired, deviation airspeed 10° max desired. Airspeed control wasn't largely a problem. I am working on the pitch rate to couple pitch rate and thrust in the climb, and in the long term, ± 200 to ± 300 ft/min is doable. Anything closer to that and you're probably going to exceed it at some point. Let's see, from the longitudinal axis control standpoint though: I feel that it is controllable, adequate, and I am going to say that desired performance requires moderate pilot compensation on this one. You are really working longitudinally, HQR of 4. Lateral directional: not a problem, it's controllable, adequate, and sat, and pilot compensation is largely not a factor here in this level of task—straight and level task—HQR of 2. So the HQRs are 4

longitudinally and 2 lateral directional. That ends the comments.

Pilot C. Task 3040, Pilot C on the first of December. And it's adequate. Performance obtainable? Yes. Is satisfactory without improvement? I would say, just taking into consideration all of the cruise time I've had at high altitude, I think it was perfectly acceptable, fair, and some mildly unpleasant deficiencies. Minimal pilot compensation required for desired performance. Cooper-Harper 3 in both axes.

Pilot D. [Pilot D did not evaluate this task.]

Pilot E. Okay, task 3040, run number 40, level flight transition climb. Not a big issue. What we did, first run we did, we just set up some gauges to figure out about what gamma it would take, and even on that I pretty much was very quickly able to stabilize at 1500 ft plus or minus about a hundred, maybe a maximum of 200. But with the indications on the ... I was using the tape because the vertical speed sitting height I have, it's difficult for me to see the 1 to 2000 ft/min range masked by the actual frontage piece of the instrument. So I can't see where the needle is ... so I had to use the PFD and that is almost a logarithmic scale, and so you have to kind of estimate where 1500 ft/min is, and your estimates are only good ± 100 ft. Nevertheless, and as we note, the acceleration diamond is not calibrated properly. But even with all those incredible obstacles, the task was simple enough where I was able to stabilize roughly 1500 ft. Airspeed: I was given ± 10 knots, and I don't think I ever got plus or minus more than about 3 knots. Well within desired there. Bank was not a problem, and heading stayed right on pretty much, I thought. So longitudinal: is it controllable? Yes. Adequate? Yes. Satisfactory? Yes. I'll give it a 3. Lateral directional: controllable? Yes. Adequate? Yes. Satisfactory? Yes, a 3 also. The biggest problems here are the limitations on the display to complete the task. Very smooth handling qualities, no tendency for overshoots or PIO, and the airspeed control was a little bit easier than I thought it was going to be with the diamond, once you calibrated it to give you the proper information.

Task 3050, Profile Descent

Pilot A. This is profile descent, 3050 is the condition, run number 37 is the last run number. Longitudinal

Cooper-Harper rating: is it controllable? Yes. Adequate performance attainable with tolerable pilot workload? Yes. Satisfactory without improvement? Yes, and I think I would give it a 2 with some ... well, let me think about it. Following the speed profile is ... actually it's somewhere between a 2 or 3 because of the ... I'll give it a 2 because we did have guidance. It's fairly, reasonably good guidance to maintain the Mach and airspeed schedule on the descent ... trend vector information as far as airspeed and altitude were concerned once you were stabilized on it. My initial throttle closing and pitch changing was concentrating on primarily just getting a target attitude established and getting throttles closed without exceeding a g force. And so when that was accomplished, then I had not taken into account ... during the phase of the descent ... I did not take into account the speed profile. Rather I was going towards a target attitude, or target gamma, getting the throttles closed in a manner that did not create a g upset. So if I included the airspeed schedule, I could change my rates so that, as I reached the target gamma, and as I brought the throttles to idle, I would still be on the V_{mo} curve. It was a little bit below that, but I think that incorporating that information into your scan, having a barber pole on the airplane, so that you knew when you exceeded the limit, exactly how far you were from the limit. Actually, you do have a barber pole here, don't you? You have one right here. Oh. So it doesn't reflect the true limits. That would be helpful, if you had an analog indication of airspeed, and indication of the limit, and indication of when you were over it and how much margin you have to it. And at any given time ... like what's most conventional transports have ... this particular condition could benefit from optimizing displays, and I had a couple of shots at it, but I still think we have a ways to go to find the best display. Okay, lateral directional once again: is it controllable? Yes. Adequate performance? Yes. Is it satisfactory without improvement? Yes, but I think I would give it a 2. Once again I think it's concentrating on pitch attitude—attention somewhat drawn away from the heading—heading loop. So it would be helpful to have a track hold in that situation, and so it requires conscious pilot effort to change heading.

Pilot B. Task 3050, profile descent. The task I chose was to visually just (draw) a straight line on the trajectory display from 2.4 at 60 at 4000 ft, roughly down to 250 at 10000 ft, and then constantly 250 thereafter. I am not going to talk about deviation in schedule

airspeed because I really didn't have a firm schedule down there. It was kind of visual [guess] on the display; however, the task in setting the pitch attitude where I wanted to and controlling airspeed in the descent to the point that I wanted to ... it was actually a pitch attitude control and then just looking at the airspeed. That was fairly easy. A little bit of working in the longitudinal axis, but the pitch attitude tended to stay pretty constant. It was between about 4 and 7 or 8°, to the best to my recollection, in the entire descent. I didn't notice any major problems in either axis. Longitudinal: it's controllable, adequate, and satisfactory, and minimal pilot compensation required for desired, HQR of 3. Lateral directional: controllable, adequate, sat, and essentially no compensation required, HQR of 2. That ends the comments.

Pilot C. Task 3050, profile descent, it's first of December and C is the pilot. Evaluate the handling qualities of the airplane on descent; check gust sensitivity in descent. Well, let me give it a Cooper-Harper rating here first, and then we will talk about it: is it controllable? Yes. Is adequate performance obtainable with a tolerable workload? Yes. Is it satisfactory without improvement? I will say no. Cooper-Harper 4. Minor but annoying deficiencies—desired performance requires moderate pilot compensation. I like the profile display here for controlling the airspeed and altitude on the descent. It all worked very nice. I guess my biggest—my minor but annoying deficiencies—still is the difficulty in setting the new flight path in a nice, smooth, and easy way, without disturbing the pilots. The actual, all other aspects of the descent were perfectly acceptable, including heading control and pitch attitude for descent and airspeed and throttles and so on. So pitch axis: I will give both longitudinal and lateral-directional Cooper-Harper of 4 [with] minor but annoying deficiencies.

Pilot D. Pilot D, December 13th, we just did the profile descent from cruise altitude of 64000 ft and level-out at 10000, 250 knots, task 3050. It really works out pretty good. You got 10 min or so there to do it, so it's not a high workload, although some things could obviously be improved. The VHD display really gives you quite a bit of lead in what to do. I think we flew a fairly quasi-energy efficient profile, yet with fairly low gamma-dot to keep the passengers happy. I guess my big desire would be to see a lot more information integrated into the HUD, at least partially somehow, to

give you some sort of pitch guidance and lead some airspeed warnings on the HUD, some analog altitudes you know, errors on the HUD, etc. So I'm going to give it a 4 just for those deficiencies. The workload wasn't really that high. Laterally: it's a 2.

Pilot E. Okay, 3050, profile descent, run 41. Because of the predictor noodle and the airspeed profile, altitude-airspeed profile, the task is quite fun and enjoyable and not too terribly difficult. You'll notice that I slip below 10000 ft. I misunderstood what Bruce wanted me to do, and I was just trying to lay the noodle on top of the deceleration line and not really watching my altitude, but I would have been able to level off at [10000] very easily had I been paying attention. So I won't penalize the airplane or the task for that. Bank angle ... let's see ... heading just right at 2° ... I wasn't really paying attention. I was pretty much heads down a lot. I probably should have been a little more heads up, but then I got off about 2° and corrected back without any problem, and I only used about 2° angle of bank to do that. And deviation of scheduled airspeed—well I don't know. Do you think I was within ± 5 knots? Alrighty, so the task: is it controllable? Yes. Is it adequate? Yes. Is it satisfactory? I might give it a 4, because I think it just takes moderate pilot compensation, not minimal. You really have to be kind of constantly flying it, and so it's a high workload task, and I think therefore, I really need to give it a 4—not based on the fact that you can't do it, but based on the fact that it takes a lot of effort as you go through a very changing condition in airspeed and altitude. Just kind of a complicated high workload task. Lateral directional: adequate, controllable? Yes. Adequate? Yes. Satisfactory? Yes, a 3. For some reason it tended to drift off in heading about a degree or two and slight bank angle. I don't know why. I think as a suggestion for the control law—a control law comment—certain things track hold, submodes, and the like, or heading holds, submodes, would obviously be nice. The technology has been around for 20 years, so we could certainly just make it work hold ... either hold a bank angle or hold a track.

Task 3060, Transition to Supersonic Descent

Pilot A. Okay, condition 3050, profile descent, run 5 is the last run. Oh that is not it. Okay, it's 3060, it's transition to supersonic descent, run 5 is the last run. Longitudinal Cooper-Harper: is it controllable? Yes.

Is there adequate performance attainable? Yes. Satisfactory without improvement? In this case, longitudinally, I had no problems that absolutely [were not] minor annoyances deficiencies [with] moderate pilot, I wouldn't call it moderate pilot compensation, so I'm going to give it a ... well, I don't know whether it would be a 2 or a 3. The forces are quite light, so you have to be very cautious about changing pitch attitude. They're so light that there's a hazard of excessive g , inadvertent excessive g is a real possibility. I think I'll give it a 3 for that reason. And the accel/decel cue is helpful in holding Mach number. Okay, so I'll give it a 3. Lateral directional was quite good: is it controllable? Adequate performance. Is it satisfactory without improvement? Yes, and I'll give it a 2. There's really no activities required there.

Pilot B. Task 3060, transition to supersonic descent at 1000, 2000, and 4000 ft a minute. It says, max overshoot ± 10 percent. I am going to assume that's relatively short term, ± 10 percent in the turbulence. Deviation in the Mach, 0.01 desired. Deviation [in] heading, 2° and bank angle, 2° . All of that doable with some workload, and working on longitudinal axis, not really the lateral directional. So longitudinal: it's controllable, adequate, and I think it is satisfactory with minimal pilot compensation required, HQR of 3. And lateral directional: is controllable, adequate, and sat. Pilot compensation is essentially not a factor in this straight and level task or straight task with descents, so HQR of 2 for longitudinally, 2 lateral directionally. That concludes the comments.

Pilot C. This is run 72, task number 3060, Pilot C, 1 December. And my comments for that are Cooper-Harper rating of 3 for both pitch and roll. It's very easy to use the controller to move the command flight-path marker down the desired amount once you get your body calibrated. It's easy to remember. You just move it down a particular amount, adjust the throttles approximately the right place, and look at the diamond and move the throttles to set the diamond. That's all quite easily done.

Pilot D. [Pilot D did not evaluate this task.]

Pilot E. Run number please, 45, 3060, transition supersonic descent. I think I'll go on record saying performance standards are a little bit unrealistic based on the amount of information we have to use. Also, the

gamma command control law establishing the sink rate ... I guess this is probably as good a control law as any, but it's very, very, very sensitive. Just the slightest little breath of air on the stick will change the sink rate by a few speeds, by a couple hundred feet a minute. So to meet these performance criteria [it's] very, very, very difficult. The airspeed control, I thought, was not too difficult to maintain within a hundredth of a Mach all the time and did not seem to have to worry so much about that. I did make some very, very, kind of low-frequency power inputs and very small inputs. They seem to hold it just fine. The acceleration diamond, of course, is very helpful in this task. I'm going to use my pilot's discretion and say that I think the performance standards were a little bit rigid for this. And basically, obviously, since you're doing 10 percent, then the task at 4000 ft a minute is quite a bit easier than the task at 1000 ft a minute, since I'm allowed for adequate over 400 ft, plus or minus. I can still make it so I think [there's] a little bit of a problem with the performance standards. At any rate, it is definitely a ... if you want to hold it right at plus or minus zero at a certain foot-per-minute sink rate—it does take a lot of effort—pilot-in-the-loop. So is it controllable longitudinally? Yes. Is adequate performance attainable? Yes. Is it satisfactory? No. I'm going to rate it a—trying to split the difference between your performance standards and my opinions—I'll rate it a 5. Basically that adequate performance—if you want to try and hold exactly a certain foot-per-minute sink rate—does require at these speeds, with this control law, a lot of pilot effort. Lateral directionally: no problem whatsoever. Controllable? Yes. Adequate? Yes. Satisfactory? Yes, a 2.

Task 3062, Transition to Transonic Descent

Pilot A. Okay, on condition 3062, transition to transonic descent, run number 08 was the last one. Cooper-Harper longitudinal was a 2, and the pitch attitude changes were larger, and so the sensitivity involved in setting vertical speed is slightly less at the lower speeds, and Cooper-Harper for lateral directional I'd call a 2.

Pilot B. Task 3062, transition to transonic descent. Pretty much like before, except 0.95 Mach at 1000, 2000, and 4000 ft/min. Okay, maximum overshoot, 10 percent, I felt that was doable. Deviation, 0.01 Mach, that was doable. Heading and bank angle,

2°, that was doable. The only difference this time is lateral direction axis working a little bit at these lower altitudes and speeds. The gusts are a little bit more effective, and I am having to control banking a little bit more thoroughly. Longitudinal task felt very similar. Okay, longitudinal Cooper-Harper: controllable, adequate, and satisfactory with minimal pilot compensation required for desired performance, HQR 3. Lateral directional: controllable, adequate, and sat. This time I worked a little bit in the lateral axis, so I am going to give it an HQR of 3 as well. Minimal pilot compensation required, 3 and 3. End of comments.

Pilot C. Task 3062, Pilot C, 1 December. This is very nearly the same task as the previous one—same Cooper-Harper rating of 3. It's a little harder now because you have to move the flight-path command marker farther, so you can't be quite so precise in eyeballing where it needs to go with the throttle movement, and the diamond helps you adjust the power. Works real nice and makes the job quite easy.

Pilot D. [Pilot D did not evaluate this task.]

Pilot E. Run number 49, 3062, transition to transonic descent. A lot of "trans" in that title. Okay, first thing I discovered that is interesting is that there is a big coupling between throttle movement, that is, power command and flight path. The commanded gamma stays where it should, the theta moves almost linearly with the throttle position, and your actual gamma, of course, diverges by up to a degree and a half with what I consider relatively small power changes. So you can actually sit there and move the power back and forth, keep a commanded gamma constant with your hands off the stick, and watch the theta and actual gamma just kind of dance around, go up and about the commanded gamma. So it certainly ... that's to me a deficiency in the airframe control law system and it makes the task, obviously harder. However, if you're very smooth with the power and just gradually, continually, smoothly pull it off until you get to around the proper setting. And the technique that seemed to work pretty well to me was I would push over and I would use the throttle to keep the diamond on the wingtip. So if I moved my throttle at a rate that kept the diamond on the wingtip, I would keep my speed right where I wanted to; I would not have this obnoxious power coupling effects in the pitch axis, and I could pretty much tangential intercept the 4000 or 2000 ft/min rate

of descent. Again, the performance standards are quite tight, and if you don't do your power just right ... obviously for the 5000 ft/min, you don't need to make much of a power reduction, but for the 2 and 4 you do. You got to be very careful how you pull your power off to not excite overshoots that are beyond your control. Obviously my commanded gamma is where it should be and I pull some power in. My actual gamma then diverges pretty quickly from that. There is not much a pilot can do to keep from overshooting his commanded or his desired sink rate. So with all that in mind: is it controllable? Pitch comments, Bruce? Okay, longitudinally: controllable? Yes. Adequate? Yes. Satisfactory? I will say no and give it a 5 again. Although I think this task has been easier than the supersonic, simply because the slower speeds means that it takes more of a gamma change to equate or to give you a ... small gamma changes don't affect you as much as small gamma changes, that is, small stick commands, do at the higher speeds. So I'm going to say this is kind of borderline 4 to 5, but since I didn't meet desired criteria, I will give it a 5. But it's a better 5 than the previous one, easier task. Lateral directional: no problem. Controllable? Yes. Adequate? Yes. Satisfactory? Yes, 2.

Task 3070, Airspeed Change in Subsonic Climb

Pilot A. This is the pilot comments for 3070, run number 9. Longitudinal Cooper-Harper: is it controllable? Yes. Is adequate performance attainable without intolerable pilot workload? Yes. Satisfactory without improvement? Inherently, holding speed with the gamma hold law is a higher workload. I would say that we would have mildly unpleasant deficiencies. I give it Cooper-Harper of 3. It's just, flight-path hold law tends to require constant attention when—in this type of maneuver—changing speed, or changing speed while you're holding a vertical path or vertical speed, 'cause the gamma is changing as the speed changes. So I would give it a 3. Cooper-Harper lateral would be a 2.

Pilot B. Task 3070; airspeed change and subsonic climb, 1500 ft/min; acceleration from 250 to 350; bank angle, ± 2 ; deviation rate of climb, ± 50 ft. Well, on the short term, that is doable. In heading, ± 2 and overshoot of target airspeed less than a knot, huh, okay. Yeah, the numbers seem a bit artificial. I guess what I am trying to do is—actually I didn't overshoot

it; it was stabilized at 350, but I would say ± 2 knots desired and ± 5 knots is adequate on that one. Without turbulence, yeah, in the short term you can call 50 ft/min desired. That's probably the limit to what I can see. In bank angle, 10 and 10 is fine. Okay, longitudinal Cooper-Harper: I am working to get the airspeed but it's nothing inordinate. I feel I can get the desired performance. It's controllable, adequate, and sat with minimal pilot compensation required, HQR of 3. Lateral directional: I am working here a little bit, as well run back and forth. I can't tell you why. It may be because my longitudinal inputs inadvertently introduce lateral ones, but it's controllable, adequate, and sat with minimal pilot compensation, HQR of 3. So it's a 3 and a 3 here. End of comments.

Pilot C. Task 3070, airspeed changes and subsonic climb. The ability to adjust the airspeed is quite easy. I used a strategy of just pushing the power all the way up to accelerate to 350 if possible and take advantage of the gamma control, holding the attitude near the climb rate that I wanted. I didn't try to adjust it too much as it varied around a bit, basically because it's not normally necessary to have that that accurate. The lead to stop at 350 knots—350 knots seem to be a little bit abrupt and I didn't get quite as much lead information as I would have liked to have, but other than that, everything was just fine. I will give it a Cooper-Harper of 3, which is just mildly unpleasant deficiencies, which are the small difficulty I had in getting the airspeed set properly. Cooper-Harper of 3 also for the lateral directional. No part of the task here.

Pilot D. [Pilot D did not evaluate this task.]

Pilot E. Okay, comments on run number 50. Is that right? Card 3070, airspeed change and subsonic climb. Again, the card has a published performance criterion that is pretty tight, and we have loosened it up to ± 200 for desired, 300 for adequate. And again for the speed, it's hard for me to see because of the way that it's situated on the instrument panel. I can't really see the 1000- to 2000-ft range very well. I can't tell actually, if I'm at 1500 or not. I was using that instead of the tape on the PFD, which also is relatively difficult because of the logarithmic scale to tell where exactly 1500 ft is. Then also I noticed twice where I had an acceleration diamond that was incorrectly telling me what was going on. At one point when I went to capture the 250 after the decel 350, I was showing a decelerating diamond, and I had stabilized, so I

thought I was doing okay, but yet the speed stabilized at about 253 and then started to increase even though the diamond showed I had a pretty hefty decel going on. Subsequently to that I showed an acceleration of the diamond and in fact decelerated 2 knots and then quickly came back. So a little bit of inconsistency there between the diamond and the actual performance. As far as pitch rate with speed, there are definitely correlations we know between actual gamma and throttle position. We notice a delta between commanded and actual of about a degree and a half when I pulled the power back to idle, even though I tried to do it fairly smoothly. So again—we mentioned those earlier—those are some problems to remember. So as far as the task, I am going to assume, for the most part of the time I was hovering around the desired range. Certainly, bank angle was desired range, heading was desired range, and airspeed does not really show a desired range on airspeed that I can see. It is ... so it's impossible to do so. At any rate, I'm going to pretty much ignore that performance standard there. But I will say, when I was kind of playing around with the acceleration diamond, and experimenting a little bit, and seeing why it was giving me some rough spots and erroneous information. But the 350 I captured fairly closely, and the 250 was within certainly less than 5 knots, and had I been playing with the acceleration diamond, probably could have done it within 2 knots. So I think that is probably what I could have done fairly easily, which I think is pretty darn good for an airplane this size and everything else going on. Is it controllable? This is for longitudinal rating: Yes. Is it adequate? Yes. Is it satisfactory without improvement? This evaluation basis check for undesirable airspeed coupling—what are they referring to there, Bruce? I noticed that. The only coupling is throttle to throttle position to pitch coupling but no airspeed coupling that I noticed. So I would say, longitudinally: I will rate this a 4. It's a very difficult rating to give because I think the correct standards are not really right for this maneuver and so I don't ... it's just a little bit difficult to hold the gamma to maintain your constant climb rate. For lateral directional: it's a nonissue. Controllable? Yes. Adequate? Yes. Satisfactory? Yes, a 2.

Task 3074, Transonic Deceleration

Pilot A. Okay this was a transonic deceleration, 3074, run number 11, and once again Cooper-Harper longitudinal: is it controllable? Yes. Adequate

performance? Yes. Satisfactory without improvement? I would say no. I think I'll give it a 4 because of the need to compensate for thrust changes, accels, and decels. The actual gamma does not ... the commanded gamma does not really maintain as you change thrust settings, and so you have to compensate for this fact by actually attempting to deviate from level flight in anticipation of the errors caused by thrust changes. So that's really kind of minor but annoying deficiency, more in the displays. Well, actually it's in the control law itself. And the lateral directional: I would give it a 2. No real problem with lateral directional this phase.

Pilot B. Task 3074, transonic deceleration from 0.99 to 0.90 Mach, level [flight]. The gamma control law ... apparently when you introduce power in middle flight of these conditions, you get a little bit of heave that causes about a 50- to 60-ft descent, so you have to correct for that. Other than that, the task is essentially a no-brainer, so the longitudinal Cooper-Harper: is controllable, adequate, satisfactory, minimal pilot compensation, HQR of 3. Lateral directional: essentially not a problem. Controllable, adequate, and sat, pilot compensation not a factor, HQR of 2. End of comments.

Pilot C. Task 3074. Decel from 0.99 to 0.90 Mach and reaccelerate again. That task was really quite easy to do because of the gamma flight-path command. Just leave that pretty much where you want. The altitude varied a little more than I thought, even though it wasn't moving. I guess that's because we were cruising right along at a pretty good speed. Small errors mean a lot. Anyway, the whole process was pretty easy with the diamond and the rest of the displays, so it's a Cooper-Harper of 3 again. Mildly unpleasant deficiencies. (Cooper-Harper of 3?) Correct.

Pilot D. [Pilot D did not evaluate this task.]

Pilot E. Okay, 3074, transonic deceleration. Comment here is, the main thing is that I tried, have a gamma control law ... I'm on the horizon, with zero gamma commanded, pulled the power back and the commanded gamma stays on the horizon, but my actual gamma falls. It's more of a coupling with the thrust pulling the throttles back and on adding the throttles. I didn't do anything until I got about a 100-ft error; then

I put in a slight correction. I had the command at this point. Actually what happened was, without touching anything, the actual gamma fell off and then the commanded gamma actually seemed to drop a little bit below it and I had not touched it, so I made a correction above the horizon, and then I had to recorrect it. Obviously we are getting some effects from the power changes that should be taken care of by the control law. As far as intercepting the Mach, I was looking at the digital readout on the HUD, and as Bruce points out, that gets truncated, so I was looking down; I was within about a thousandth of a Mach and trying to wait for it to get to the proper Mach. So not too difficult a task, especially with the airspeed acceleration symbol. So longitudinally, again no airspeed coupling, but I'm not sure exactly what they mean by that. Longitudinal task ... it certainly ... there is no real ... well I guess if you stay real tight in the loop it will do that ... you shouldn't have to ... the control law accounts for it. It should maintain the thing at zero gamma, but it doesn't. Is it controllable? Yes. Is adequate performance attainable? Yes. Is it satisfactory without improvement? No. And I'm going to rate it a 4 because the minor but annoying deficiencies clue error in that rating block. The minor but annoying deficiencies are it will not hold gamma during power reductions. For lateral directional: it is a nonissue. Controllable? Yes. Adequate? Yes. Satisfactory? No, 2. (Two).

Task 3076, Airspeed Change in Low Altitude Cruise

Pilot A. This is an evaluation of 3076, run 12, the airspeed change at low-altitude cruise, and it's a decel from 350 to 250, back to 350. Is it controllable? Yes. Adequate performance attainable? Yes. Satisfactory without improvement? No. I think I would give this one a 5 because of the thrust changes requiring compensating anticipatory target gammas that are trying to compensate for the fact that the airplane cannot, in fact, hold gamma as you move the thrust up and 1° to 2° as you add thrust and accelerate, and that pitch changes bleed off to about half degree during the final stages of the acceleration and similarly on the decels; so when the throttles are moved rapidly, it's very difficult to moderate when you're capturing a speed. It's quite difficult to make those compensations and determine exactly how much compensation is required. For

that reason I'll give it a 5, I think. And lateral directional is still a 2.

Pilot B. Task 3076, airspeed change in longitude cruise to 250 from 350 knots. A little bit of work in maintaining altitude in longitudinal axis [and] in maintaining bank angle in lateral directional axis. Not anything untoward. Longitudinal Cooper-Harper: controllable, adequate, satisfactory, minimal pilot compensation, HQR of 3. Lateral directional: controllable, adequate, and satisfactory, again, minimal compensation, HQR of 3—3 and 3. That ends the comments.

Pilot C. Task 3076. I will give you a little different rating on this one in the pitch axis. The roll will be the same—Cooper-Harper 3—but the pitch axis, I'll make it a 4. Minor but annoying deficiencies and that's because the acceleration is so rapid that the altitude changes a little more than you would like, and then when you try to chase after it, it's a little more difficult than a Cooper-Harper of 3. It's a Cooper-Harper of 4 in my mind. And at one time the display actually made me move the stick in the wrong direction, trying to fix it, and I actually made the errors bigger than smaller.

Pilot D. [Pilot D did not rate this task.]

Pilot E. Task 3076, airspeed in change, low-altitude cruise. Run number 52. Okay, very similar comments as far as the $C_{M\Delta P}$ problems. Interestingly enough, this time I left my hands off for the acceleration 250 back to 350. I was pretty much around 15000 \pm 27 ft, didn't touch the stick at all, and at full power I climbed about 250 ft. After I got to approaching the thing, I made an aggressive power reduction. Pulled it back to the trim setting or close to it. With only about a 6-knot lead, it quickly lost 250 ft. I don't see how we lost it that fast because we gradually ... it took a while to gain the 250 but we went right back to 15030 ft. I was busy watching the airspeed, and I didn't notice how quickly we came down, but we came almost back down to the original altitude. At any rate, similar comments and I see no real difference in this speed regime and the previous one and this altitude and the previous one. Comments the same. Longitudinal: controllable? Yes. Adequate? Yes. Satisfactory? No. I will rate it a 4 for the minor but annoying deficiencies, that is, the lack of

gamma control during power changes. Lateral directional: same. Controllable, adequate, satisfactory, 2.

Task 3080, Heading Change in Transonic Climb

Pilot A. Okay, heading, this is task 3080, heading change and transonic climb, last run, number 40. Longitudinal Cooper-Harper: is it controllable? Yes. Adequate performance attainable? Yes. Satisfactory workload, satisfactory without improvement? Yes. I don't see any problem there. And I think I would give it a 2 on longitudinal. It's just a simple scan, flight-path vector, vertical speed. Lateral-directional Cooper-Harper: is it controllable? Yes. Satisfactory performance attainable? Yes. Acceptable without improvement? I, as far as accomplishing the task, think it would probably fall into the ... let me just give it a 3. Some deficiencies that would be ... I don't know whether the deficiencies ... the cab motion seems to be a little unusual. I don't know whether that is just unrealistic or what. Okay, so in that case, really there's no problem in getting, rolling in and rolling out on the headings, and performing the task at all. It's just as you go along, the motions that you see tend to be a little disturbing. Let me give this one a 2 in lateral-directional Cooper-Harper because there's no real problem with this task. The forces seem a little on the high side for maximum effort, maximum roll rate. Roll rates are fairly slow, but they seem to be adequate.

Pilot B. Pilot B, task 3080, heading change and transonic climb. The task is the 2000-ft min climb, 0.92 Mach, right third degree turn at 15° angle of bank, and left third degree turn, then repeat at 35° angle of bank. Tolerance bank angle \pm 2° is doable for desired deviation climb \pm 50. Yeah, when I am trying ... those are awfully tight tolerances for the long term, however. Deviation in airspeed \pm 5 knots. That is doable but the caveat is, at 35° angle of bank, the power is all the way floored and we are still decelerating slightly, so it depends on how fast you do it. And deviation of target heading \pm 2°. Yep. Desired. Yep, you can do that. Okay, longitudinal: it's controllable, adequate, and satisfactory, minimal pilot compensation, HQR of 3. Lateral directional: it's controllable, adequate, and sat, and once again minimal compensation, HQR of 3. It's borderline. If it was any tougher laterally, I would give it a 4, but I think I am satisfied with a 3 for this task. End of comments.

Pilot C. Task number 3080, heading change in transonic climb. These tasks are a little more difficult because now you have to do some real flying of the airplane. The bank angle is relatively easy to set, and pitch attitude also; when you have to make some changes in them, they're a little abrupt, and you can feel an abruptness in the motion also. So, less smooth than I would like to see for this kind of airplane. Is adequate performance obtainable with a tolerable pilot workload? Yes. Is it satisfactory without improvement? I would say minor but annoying deficiencies Cooper-Harper 4. Desired performance requires moderate pilot compensation, and that is I have to work to be smooth. I have to use a little more force to get out of the breakout than I would like. And once I do get out, the airplane tends to jump and be a little jerky. And that's Cooper-Harper of 3 for both lateral directional and pitch and roll. That's Cooper-Harper of 4 on both, not 3. (4 and a 4.)

Pilot D. Pilot D, December 13th, just finished task 3080, ended on run 25, a subsonic heading change. With the head-up display and the control system, it combines to make a pretty easy task, although there are some deficiencies. A positive comment: gamma hold does a good job of holding gamma. It's a little hard to maintain exactly 2000 ft/min. I think it would be neat to redefine the task in terms of gamma, so you wouldn't have to use two displays. Roll system has a little bit of coast in it after you release the stick. You have to provide just a little bit of lead to hit your heading. I like to see it snub down just a little bit faster after, when you take your input out. The HUD heading and the bank displays are nice. X-double-dot has its same old lag, but for this particular task only small throttle inputs are required and it wasn't a real factor. Let's give it a pilot rating of 4, and the deficiencies are primarily in the display. There's no H-dot on the HUD and the lag in the X-double-dot. Laterally: let's give it a 3. The only real deficiency I saw was I would like to see it snub down in roll a little faster.

Pilot E. Run 53, task 3080, heading change in transonic climb. Only comment here was that at full power at 35° angle of bank, it is not enough to maintain airspeed, and you do decelerate. All told, it was not a bad maneuver. I basically left the gamma where it was, and since the speed's constant and the gamma's constant, then my rate of climb stayed constant. So not a very difficult task. I didn't have too much trouble cap-

turing the bank angle, especially on the 35° ... you just put the stick all the way over, and it does captures for you. So that is kind of a nonissue there. At 15°, you had to take a little bit of lateral effort to maintain it, and it tended not to hold it. I was finding myself constantly having to kind of sweeten the pot to keep it right there at 15°. As far as the 15°, the heading capture was pretty much a nonproblem. At 35° it was a little bit harder simply because your turn rate is faster and I tried to be aggressive; it wasn't a smooth capture. It says right here, "aggressively maneuver," so I took that to heart, and I tried to wait until the last moment and aggressively roll out rather than trying [to] tangentially [to] intercept the heading. So on the last one I overshot about 1 1/2°—1° to 2°—and then it went right back to 1°, and any rate, that is within desired criteria. So, desired all the way around. So longitudinally—I'm going to ignore that zero overshoot, because you could undershoot then and ease into it, and that takes out the spirit of aggressiveness. Okay, so for longitudinal, it is a pretty simple task there: controllable? Yes. Adequate? Yes. Satisfactory? Yes. I really didn't do anything longitudinally, so I am going to rate that a 2. Lateral directional: controllable? Yes. Adequate? Yes. Satisfactory? No. A 4, and the reason being that the 15° ... I kind of had to work to keep the thing on bank. At 15°, I kept having to put little inputs in there, and this is really borderline 3 to 4. I'm kind of being a little bit pessimistic here. It could go either way as far as I am concerned. I'll give a 4 here, but it is real borderline Level I/Level II. Mainly because it doesn't have real good bank angle hold performance in the control law.

Task 3084, Heading Change in Supersonic Cruise

Pilot A. This is condition 3084, run 41, and heading change and supersonic cruise. Looking at longitudinal Cooper-Harper: is it controllable? Yes. Adequate performance? Yes. Satisfactory without improvement? Yes. And in this case I think it did quite well. I guess I would have to give it a 2. It's no real problem. And lateral-directional Cooper-Harper: is it controllable? Yes. Adequate performance attainable with tolerable pilot workload? Yes. Satisfactory without improvement? I would give it a 3 but I think the heading information seems to be ... so I just realized that it ... as far as using the digital heading information and the bore-sight for rollout ... that because of the way it's presented, it tends to give you an early rollout by 2° or so

from a 30°, 35° bank. Track is a better indicator of rollout; however, if you had any wind, then you could not really correlate those two. So at your bank angle ... has to be taken into account what a really steep turn would do ... might be even more of a factor. So I guess I would have to rate the lateral directional as a 3; I think I said for that maneuver.

Pilot B. Task 3084, heading change and supersonic cruise, task at 2.3 Mach, 63000 ft, to maneuver in and out of a 20° turn to the right with 15° bank and then to the left and then repeating with 35° angle bank. Task was $\pm 2^\circ$ desired in bank angle; that was doable. Plus or minus 50 ft in rate of climb; that's not appropriate. I would substitute a deviation in altitude with that redo. I would say, 50 ft desired and 100 ft adequate on that. 'Cause rate of climb is not one of the things you're interested in at this point. Yeah, and I feel like desired was doable here. Deviation airspeed, ± 5 knots desired, 10 knots adequate. When we had sufficient thrust to maintain airspeed, that was doable. At 35° bank angle, you don't, so you are decelerating the entire time. Deviation from heading, $\pm 2^\circ$, that's doable. Okay, Cooper-Harper: it's longitudinal. It's controllable, adequate, and sat with minimal compensation required, HQR of 3. Lateral directional: it's controllable, adequate, and sat, again minimal compensation required, HQR of 3. And the compensation just consists of watching the bank angle and controlling a little bit of inertia on the airplane, and longitudinally, just keeping the velocity vector on the horizon and making inputs do so. That concludes the comments.

Pilot C. Task 3084, Pilot C evaluating. I think that was relatively easy to do in level flight there and not too hard to maintain the altitude. Is it satisfactory without improvement? I would say, yes. Unpleasant deficiencies, minimal pilot compensation required for desired performance, Cooper-Harper 3. A little bit jerky, but I think I felt like it was in the mildly unpleasant arena. Yeah 3, 3—both lat dir and pitch.

Pilot D. Pilot D, December 13, supersonic heading change, task 3084 and it's pretty much ditto task 3080 except it's a little bit easier. You don't have to ... there's no throttle task ... you just leave the throttles at full. And descend the whole Mach number so the eases that X-double-dot lag a little bit—problem, a little bit. I'm not sure why. And since the turn rate is

very slow it's, if anything, a little bit easier to roll out on heading. Let's give it a pilot rating of 3 and 3.

Pilot E. Run 54, 3084, heading change in supersonic cruise. Okay, that was pretty much hands off in the pitch axis. I let it stay on level flight and didn't worry about it. Obviously, longitudinal was not a factor there. Lateral directional: the only thing I didn't particularly care for is, in the rapid aggressive rollout from 35° and 15°, got a little bit of beta. I left my feet flat on the floor, let the control law take care of it. A little bit of beta, sustained beta, that took a while to take care of. Obviously, if we wanted to improve this control law, we'd have some more cross connection between the directional and lateral axes and try to take care of that. But basically not a tough task. Airspeed of course, I was full power and could not hold airspeed, especially at 35°; I decelerated to 2.34 Mach from 2.4. So, longitudinal: controllable? Yes. Adequate? Yes. Satisfactory? Yes. I'm going to rate it a 2, almost a 1, but we did lose a little bit of altitude there, so we didn't quite hold it, but obviously pilot compensation was not a factor. For lateral directional: controllable? Yes. Adequate? Yes. Satisfactory? No. I'm going to rate it a 4, and again this also borderline 3 to 4. I could probably come in with a 3, but I don't like the fact that you have to constantly work to hold your 15° angle of bank. Thirty degrees you just ... the stick is full over ... it reaches the stop. At 15 it should go over there, and with neutral stability it should just stay there and not have to play with it. I had to get back on in the lateral axis because I started to go to 17° angle of bank. I was watching it and it was just increasing the roll without any command from me. So I think it is just a control law tweak right there or just some kind of aerodynamic thing; it's just ... no control law is going to work. At any rate, as far as I can tell we have a good set and that and the fact that beta is obviously very apparent during the rollout are two things that keep it from being a Level I.

Task 3086, Heading Change in Low-Altitude Cruise

Pilot A. Okay, this is condition 3086, run number was 42, and the longitudinal Cooper-Harper: is it controllable? Yes. Adequate performance? Yes. Satisfactory without improvement? Yes, and I would give it a 2. And the lateral directional: is controllable. Adequate performance? Yes. Satisfactory without improvement? I think I will give that a 2 also. The only thing ... it

could be in ... it could be a 1 if you had the ability to lock in an attitude hold type of option somehow. The bank angle: the only comment on the lateral directional might be that the rollout from the left and the right were somewhat asymmetrical. It's a little easier to roll out from a left bank than it is to roll out from a right bank because of the forces involved on the stick. But it's quite pleasant actually at this high speed.

Pilot B. Task 3086, heading change and low-altitude cruise, 350 knots, 60° turn to the right and to the left using a 30° angle of bank turn. Let's see, tolerance was bank angle, ±2° desired. That is doable. Deviation rate of climb: again I would like to substitute ±50-ft altitude change desired and 100 ft required. Deviation in airspeed, 5 knots: that's easily doable. And target heading, ±2°: that's doable. You are working a little bit, but all of these are doable. Longitudinal CHR: it's controllable, adequate, and sat, minimal pilot compensation, HQR of 3. Lateral directional: once again, controllable, adequate, and sat, minimal pilot compensation, HQR of 3. That concludes the comments.

Pilot C. Task 3086, Pilot C, heading change and low-altitude cruise, 30° of bank to 60° of turn. Going through the turn there's a little bit of activity on the stick, and it's mostly kind of little jabs to keep things going; that makes the airplane a little bit jerky. So it's going to head me toward the Cooper-Harper of 4 here. Satisfactory without improvement? Minor but annoying deficiencies. That's that little roughness in the ride and not being able to fly with pressure but flying with little jabs, and then it causes, at least in one case, kind of a nice little abrupt jerk in the airplane which the passengers will not appreciate. So both axes, Cooper-Harper of 4.

Pilot D. Pilot D on December 13. We had a heading change at 15000 ft, 350 knots, task 3086—pretty much ditto 3080, the other subsonic one we had. I am going to change the pilot rating on one just a little bit, but longitudinally: it's the same. Pilot rating of 4 for the same reasons—display problems mostly. Laterally: I am going to increase it to a 4 this time from the 3 I gave it on 3080 ... primarily because I did get into ... because of that roll coast. I got into just a little bit of a PIO. Almost a PIO tendency there. I kind of set it on 30° on the first rollin. Let's give it a 4.

Pilot E. Run number 55, card number 3086, heading change in low-altitude cruise. The main comment here

is, I'm trying to be as aggressive as I can because [of] the term "aggressively maneuver." And the motion cues are not right on that. You shouldn't feel such huge side forces. We are not seeing really a whole lot of beta on that and that's just not realistic. Probably some washout is required in that motion response we are getting. At any rate, longitudinally, I had to make a couple of corrections that time to keep us on altitude, so it didn't quite hold as well as it has on previous ones. The airspeed control is very good. There was some question as to whether the diamond was going to be tuned properly on the wingtip for the acceleration cues, and I played around with that a little bit, allowing myself to deviate a couple of knots on airspeed, but it appears the diamond was working properly. Airspeed? I certainly stayed within 5 knots. Heading? I stayed within 2° and bank angle I stayed within less than 2°, so I met all of the desired criteria. Okay, for the rating—longitudinally: controllable? Yes. Adequate? Yes. Satisfactory? Yes. A 3 this time, because it did take some minimum compensation to keep the climb rate zeroed. Lateral directional: controllable? Yes. Adequate? Yes. Satisfactory? No. Again a 4, and the main reason being, it's just not holding the bank angle. You have to correct it to hold the 30°, and also I am going to say this could go 3 to 4 like the two I have previously rated. So I have chosen to be a little more critical this time depending on the mood I'm in.

Task 3088, Heading Change in TCA Descent

Pilot A. Heading change in TCA descent, 3088, run 14 was last run. Cooper-Harper longitudinal: is it controllable? Yes. Adequate performance? It's questionable. Probably, yes, let's see ... desired deviation from bank angle, adequate 5, well ... and 75 on the vertical speed, well, yeah ... 10 knots, yeah, it's somewhat difficult to ... I would tend to rate that a 6 because of the combination of thrust, thrust changes, stiff throttles, and the ... this is the 15° bank and 30, both of them? Well, let's give it a 5. Yeah, longitudinally and a lateral directionally, you need to have the ... to hold the ... let's see, it will hold 35° all by itself, so it's not a big problem. I didn't see some strange motions in the motion, motion cues, rolling into and out of the banks, but it was rolling in and out. It's no big problem. I guess I would have to give it a 2.

Pilot B. Task 3088, heading change in TCA descent, 250 knots, 15° and 35° bank angles, 60° turns right and left. Deviation target bank angle, 2° desired. That was doable. We changed the deviation rate of

climb—desired is 200 ft/min. That is doable. Adequate, 500 ft/min in the gusts. That is doable. Deviation airspeed, 5 knots; that was doable when I was trying to control it. Deviation from target heading and the end of turn, $\pm 2^\circ$ desired, 5° required. I would say the 2° desired was pretty tough. It took a lot of work to get the 2° and there is kind of a pendulum effect for the velocity vector at this airspeed that makes it a little more difficult than before. At least, I didn't notice this kind of difficulty before [on] lateral directional axis. The longitudinal axis was about like before. So longitudinal: it's controllable, adequate, and sat, with minimal pilot compensation. I would say that lateral directional is controllable and adequate but the desired performance requires moderate pilot compensation. I am going to give that an HQR of 4. So longitudinal is 3, lateral directional is 4. That ends the comments.

Pilot C. Task 3088, heading change in TCA descent, and it's Pilot C. The 15° of bank on that turn: the workload was easy enough. It could be a 3 but there, coming back on the 35, I had to work hard enough so I think it is more appropriate to be a Cooper-Harper of 4 [with] minor but annoying deficiencies and moderate pilot compensation for desired performance.

Pilot D. [Pilot D did not evaluate this task.]

Pilot E. Okay, 3088 card, run 56, heading change in TCA descent. Comments: there was obviously motion fidelity, something odd about it. Bruce brought a comment: previous complaints in previous studies about the motion in these things in aggressive turns, in that it may be actually the cockpit is so far ahead of the center of gravity that the motion may be all that wrong, I guess. So that is something we need to study at another time. It may be something interesting to look at. That time, it took a little bit more occasional input longitudinally to keep the thing at the proper climb rate. As I made power corrections to hold airspeed during the turn reversals, I got deltas between commanded and actual gammas, which also made the longitudinal task a little bit more difficult. It seemed like it was more power corrections required on this particular task at low altitude and the higher banks, especially at 35° , and in order to maintain speed, and that every time you make power corrections you do get some longitudinal coupling, which is kind of a nuisance. So, for this one, longitudinal: is it controllable? Yes. Adequate performance attainable? Yes. Satisfactory with-

out improvement? No. Give it a 4. The main reason being there were more power adjustments required for speed control, and each one of those seemed to cause longitudinal coupling, which is kind of a nuisance. Lateral directional: controllable? Yes. Adequate? Yes. Satisfactory? No. Again I'm being overly picky on lateral directional, but I just think that an airplane should be able to hold a commanded angle of bank without wandering, so I think it is a minor but annoying deficiency.

Task 4012, Configuration Change in Straight Flight—Moderate Turbulence

Pilot A. Okay, this is 4012 condition, and the run lot was 15. Longitudinal Cooper-Harper: is it controllable? Yes. Adequate performance? Yes. Satisfactory without improvement? Yes. I think we'll call it a 3 with mild, minimal pilot compensation required. The gamma as you change thrusts, even with the autothrottle, tends to let the altitude wander around quite a bit. The gamma—actual gamma—splits out from the target gamma a substantial amount of the time. Longitudinal or the lateral-directional Cooper-Harper: I would call a 2.

Pilot B. Task 4012, configuration changes, straight flight, moderate turbulence. This is with the autothrottle on straight and level at 250 knots, gear down, slowing to 157, and then gear up and speeding up back to 250. Since we got a gamma control on and since the autothrottles are on, there's absolutely no pilot input required whatsoever in either axis, so the HQRs are going to be real easy. It's controllable, adequate, and sat longitudinally, and pilot compensation is not a factor, HQR of 1. Lateral directional: same thing—controllable, adequate, and sat, and no pilot compensation required at all, HQR of 1. That concludes the comments.

Pilot C. And it's 4012, configuration change in steady flight, moderate turbulence. This exercise is all okay except for one thing. In my mind, it's a little annoying, and that's when you make a reasonably abrupt power change of significant size, then the pitch attitude changes a lot, which I think might bother ... might have a bad effect on ride qualities some place in the airplane, either way in the back or up front. [Do] I think it is satisfactory without improvement? No, minor but annoying deficiencies, Cooper-Harper 4.

You will have to use moderate pilot compensation to avoid that problem. (Lat dir?) You can call that a 3 if you need a number to put in there. (That's a 4 and 3.)

Pilot D. [Pilot D did not evaluate this task.]

Pilot E. Run 57, 4012, configuration change in straight flight. The last card of the Ref-H assessment. Okay, the first time we did it, I was completely hands off. [Tape ran out; pilot gave longitudinal 4, lat dir 3.]

Task 4020, Nominal Approach and Landing

Pilot A. Task 4020, and the last run was 14. Longitudinal: I could trace through all of these decision points but actually, improvement not required. I think I would give it a 2. I think with a little guidance information you could improve on it. There are some negligible deficiencies, but pilot compensation is not a factor. If you had more flight director type information ... actually one of the factors was that you had a split between commanded and actual that tended to get you off the glide path and then back on ... that's minor, but noticeable. So lateral-directional Cooper-Harper for glide slope and tracking: give it a 2. I think you can improve it in the law with a track hold in the detent there. The other one is on the landing, Cooper-Harper for longitudinal during flare: I would give it a ... how many of those landings were adequate in terms of sink rate versus desired? (In terms of sink rate we didn't have any desired landings; they were both adequate.) Okay. It seemed to me, in the flare ... I would give it a 3 because of the tendency for it to settle in a little faster than you really wanted. You are commanding a flare that was starting low, so you had to initially overflare the airplane and it was hard to predict the ... and you got into rate limiting on the elevator. It seemed strange for just a normal approach and landing and flare. Something is wrong there, I think, getting rate limiting on a normal landing, and those were rather benign maneuvers we were using there. So from the pilot's standpoint, the landing just appeared to be harder than you'd like. Lateral directional: that was fine; give it a 2. But it seemed to me that I have ... my seat was a little higher than what you would have (normally). I was a little hesitant to overflare, to carry it beyond the box. I think you need to have your commands a little tighter in the flare. This display could be tuned up quite a bit to improve performance by making the symbology a little crisper and

clearer. It initially, on a whole, seemed a little bit fuzzy on some visuals.

Pilot B. These are comments for run 29, task 4020, approach and landing task with the 30° offset. First task to rapidly maneuver on the final approach path at low altitudes. From the standpoint of longitudinal, I tried both fine corrections and fairly large scale corrections, no tendency for PIO or coupling with the aircraft. No tendency to get out of phase, no tendency for inordinate workloads or anything like that. The lateral-directional precision in terms of back angle capture, and heading rate, and heading capture if degraded was only degraded by the motion feel on the cockpit. There tends to be a fairly large sideways motion associated with lateral inputs, probably due to the model geometry and the distance we were away from the axis of rotation. I felt, in terms of performance, like I was able to get desired performance whenever I chose. The workload was a little bit higher in close, as it got a little bit more sensitive to inputs, as you would expect. But, again, I felt like I was able to get desired performance when I tried.

The longitudinal Cooper-Harper: it's controllable, adequate performance is obtainable. I think it's satisfactory without improvement. For this part of the phase of flight I'm going to give an HQR of 2, pilot compensation not really a factor; it does pretty much what you want it to do without thinking too much about the compensation [and] negligible deficiencies.

For the lateral-directional Cooper-Harper: it's controllable, adequate performance is obtainable. The issue here is whether it's minimal pilot compensation or moderate. I'm going to call it minimal and give it an HQR of 3. And again the only thing that degrades performance a little bit is the motion cues, plus a little bit of adverse yaw and the rolls; although you'd expect me to have problems with heading prediction on intercepting and tracking headings, and I didn't have those kind of problems. I was able to get to the heading pretty well. For what it's worth in these no-wind conditions, when I'm saying "heading," I really mean "course." What I haven't tried is referencing the waterline symbol for heading. That's probably because it's so far away on this airplane; I've got a problem with putting heading up there because the first thing I'm going to reference is the velocity vector since that's what flying too. And when you tell me to

roll out on the heading, probably the first thing I'm going to do is roll out on course instead of heading, and if there's a big wind there I may take some corrections. So just for reference, I think we've got a problem programwide with how to quickly get to a heading in an airplane where your pitch attitude is so far away from the velocity vector.

For the landing phase, handling qualities of the airplane landing: no tendency for APCs. I didn't notice any PIO tendency or any major bobbling tendency. There's a slight tendency to overcorrect and re-correct in the postflare phase, after the flare was complete, [and] when searching for an attitude to hit just prior to touchdown, there's a little tendency to wonder and hunt. No tendency to float, which was somewhat of a surprise. No tendency to bounce after touchdown. The tendency here, for me anyway, is to land hard unless I really try. I've really got to concentrate on getting the gamma up, and what I ended up doing was deliberately putting gamma above the horizon in the flare in order to get the sink rate down at touchdown. Something I've never had to do on any other HSCT simulation—it's always been below the horizon, and this one it's above. That may be due to the location of the lower calculating the gamma.

As far as performance standards ... the landing zone ... I'm working at that. I never really got above adequate on that did I? I didn't really get in desired; although, your tolerance for desired is fairly tight on this one. What is the box for adequate? And what is desired? Yeah, I think in other simulations I've been, we've doubled those, so desired would be where your adequate is, and adequate is something well beyond that. And the reason we've done that is because a pilot isn't really in an airplane where your gear is 640 ft behind your aim point. We didn't feel like the location of the box was a good target to control to. The pilot isn't really trying to land in that box, the pilot is trying to do a consistent flare, and what you'll do is pick up cues that allow you to cheat. Like I'm deliberately putting the velocity vector above the horizon because I know that if I don't I'll land short and hard. You'll pick your aim point based on your previous landings, not based on what you're currently doing. So it's kind of tough to call ... kind of tough to give an HQR criteria as a runway box. We all do it but it's not really traditionally a real HQR criteria in an airplane this size cause you're not controlling to it. So for what that's

worth, I guess what I'm saying is that when you arrive in the flare, you've already done basically everything you're going to do to get in the box. You're not going to deliberately float in order to land in that box. You're going to try to gauge your flare so that you arrive in position to touchdown in the box, but once you arrive, you're not going to correct. You're just going to take whatever comes.

That's a separate problem, but yeah, the box is also bigger than what I've seen. At any rate, I'll base it on what you've got here and say I'm able to get adequate performance in terms of the box. There is some pitch control difficulties in the flare. Maybe that's a contributing factor.

In any case, longitudinal HQR in the aggregate: it's controllable; I am able to get adequate performance. I'm going to call it moderate compensation for pitch control in the flare and give it an HQR of 4. I'm kind of giving it the benefit of the doubt here. Between desired and adequate, I should probably give it an HQR of 5, but I don't believe that these are moderately objectionable deficiencies, so this is an area like we see sometimes where the fourth column is in conflict with the third column, but I'm going to give it an HQR of 4 because I consider them minor but annoying deficiencies.

For lateral directional: it's controllable, adequate performance is obtainable. It is satisfactory without improvement. I'm just not noticing any problem with lineup without any crosswind or major turbulence to speak of. I think you'd call any deficiencies that exist mildly unpleasant and it's primarily associated with the lateral motions in low corrections. I'd give it an HQR of 3. That concludes the comments.

Pilot C. For the record here, it's run 57, 4020, C is the pilot, and it's a normal approach and landing. So first we'll look at the glide-slope and localizer intercept part. When you are flying this part, it is most successful if you kind of fly it as if it is an autopilot with control stick steering. Once you're established on the pitch attitude you need to hold altitude, you virtually don't have to touch the stick again in pitch as you do the intercept; you can just use roll forces, get your 20° of bank, and then the pitch attitude stays just where you need it to maintain level flight, approximately. The roll control seemed not too bad, as you try to roll

out on the desired heading to stabilize the localizer; however, it's not really, well, predictable as far as how to roll out and get the exact heading that you want. In each case I either overshoot or undershoot, and then I have to make several more corrections to try and to get it at the desired place. And any time you have to couple with the stick and start to maneuver the airplane in a closed-loop way, then the workload goes up significantly, and the jerking around that you give the passengers is more significant. Okay, let's give a Cooper-Harper rating: adequate performance obtainable with a tolerable pilot workload? Yes. Is it satisfactory without improvement? I will give it minor but annoying deficiencies. Desired performance requires moderate pilot compensation, so it's not satisfactory without improvement. It's Cooper-Harper of 4, and my annoyance with it is the difficulty in rolling out on the proper heading that I would like and difficulty in getting the heading exactly where I want it. Once I tried to do that and ... kind of a jerky nature of flying of the airplane when it ... when you're trying to make small adjustments. Well, 4 I call that, in both axes. It will be 4 for both axes and because when I try and fly it in pitch, also then it has that same annoyance in trying to aim the airplane in exactly where you want it in pitch. It does a reasonably good job of control stick steering but it's not like flying an airplane. Is the next part the landing segment? Oh, that was the localizer intercept part of it. This part is positional landing part from 400 ft on down. The feeling of the airplane going through its flap transitions I think are just okay, you know to expect those changes and they seem quite normal to me and not disturbing. As you're approaching, the tendency is to fly the airplane with little blips of input in pitch and roll, as opposed to pressures. By putting in the little blip you can move the flight-path marker command, command marker, some small amount and so when you are far out on—400 ft out—final approach, that technique still works. But as you get closer and closer to the ground, if you start and try and actually fly the airplane to maneuver for the landing as opposed to trying and make an autopilot arrival, then the handling quality deteriorates significantly because it's more difficult to, nice and precisely, control the airplane with the stick. Is adequate performance obtainable with a tolerable pilot workload? I am going to say yes. And is it satisfactory without improvement? No. Then I'll give it moderately objectionable deficiencies. Adequate performance requires considerable pilot compensation, and the compensation that I

require there is to stay out of the loop and do a more open-loop kind of landing and accept what I get as opposed to mixing with the airplane and trying to land it and flare it. And that applies to both pitch and roll. My difficulty is flying the airplane in the closed-loop manner. The Cooper-Harper rating was 5 for both pitch and roll, and the moderately objectionable deficiencies is the difficulty in flying the airplane smoothly and precisely when you try and actively fly a flight path to a landing. If you're just trying to do control stick steering in a more open-loop fashion, you perhaps have better results than you do if you try to fly the airplane.

Pilot D. Pilot D, December 5th. We're up to block 2 starting. We just completed a nominal approach and landing, task 4020, and we ended with run 50. Let me just make some general comments first, and then we'll get into pilot ratings. Let me give the control comments first. It feels like the longitudinal-lateral harmony is off a little bit. That is, that I feel the lateral stick forces are a little bit high, in particularly compared to the pitch, and I think I would decrease the roll stick forces versus increasing the longitudinal. I think they're plenty high already. The roll rate command attitude hold has a tendency to coast; that is, when you release the stick, it continues to coast for 4° or 5° if you have any kind of appreciable rate built up. I think this is causing me a slight tendency to PIO in roll, perhaps that plus the high stick force laterally. Longitudinally, glide-slope tracking, it's just great. Just a little tendency to bobble on flight path in the flare. I feel like it's hard to make a small input. I think that was all. Okay, let's go up and talk about the display. Display works pretty nice for VFR, where you can see the runway outside to help you tell what you should do at that flight-path symbol. I'd like a depressed pitch line to help me. The flare cue is quite dim, but once you learn to look for it, it's okay. I think that, in general, the display contrast is pretty low here. And apparently we're displaying the cg flight path and until I was aware of that, it was giving me a problem. I was unconsciously trying to put the flight path on where I perceived the flight path to be. And of course that caused the vehicle to essentially flare. I think once I realized what we had and just used it mechanically, it worked out okay. I definitely feel that's not good human factors, but we could discuss that off line. Pilot ratings: okay, let's look at the approach. Longitudinal first. It's really pretty darn good and even the performance is showing

that. For the VFR landing task here: improvement not required, I don't think; let's give it a 3. For the approach lateral: I would like just a little bit lighter stick forces, let's give it a 4 [with] minor but annoying deficiencies. For landing longitudinal, and that includes the throttles: there's something definite that needs to be done with these throttles ... should have an autothrottle disconnect on the throttle levers, and the forces in the throttles need to be adjusted quite a bit. It's just too much physical force. Actually, you're sitting here almost leaning into them, getting them to come back, which is affecting the longitudinal and lateral control of the stick on the other side. That's one thing that really needs fixing. Had a little bit of a tendency to bobble on the pitch and on the flare cue, not too, too bad. Although, we weren't making desired performance. That puts us into a 5 on performance. And I think probably that goes along pretty good with the throttles. It's moderately objectionable deficiencies. It's maybe at least a 5. So let's give it a 5. And lateral didn't seem to have any big problem. Once we get the thing lined up, it kind of holds itself. It'd be interesting to see what we get in a crosswind. Let's give it a 3.

Pilot E. Okay, 12/7, second session with Pilot E. Okay, this is nominal approach and landing, card 4020, and rating the glide-slope and localizer intercept. The longitudinal Cooper-Harper first: is it controllable? Yes. Is adequate performance obtainable? Yes. Is it satisfactory without improvement? Yes. I'll rate it a Cooper-Harper of 3. The mildly unpleasant deficiencies that I noticed ... basically, it seems to be, that ... for some reason it didn't seem to be ... I didn't feel as tightly in control of the longitudinal axis as I would like and I kind of have a hard time putting my finger on it. I think the ... are we having any kind of turbulence on this one? Light turbulence. What's happening is, I'm seeing the, and feeling, the turbulence in the cab, and I'm seeing the waterline or the aircraft beta vary, with the gamma being constant, and it ... I don't know for some reason it's ... I can't put my finger on it but I just don't feel like I was real tightly in control of the gamma, even though it moved where I placed it. It something just didn't feel quite right. I'll have to think about it some more. The lateral-directional Cooper-Harper: controllable? Yes. Adequate? Yes. Satisfactory without improvement? Yes. Also a 3. One thing I noticed when I was rolling into the turn to intercept the localizer: I felt a side force in

the cab, and whether or not that's an artifact to the fact that we're so far in front of the center of gravity, I'm not sure, but that somehow seemed odd to me. And the responsiveness in roll axis seemed a little bit less than what I would like, but nevertheless it's still Level I. Okay, for the precision landing: I did three of these and I didn't quite ever hit exactly in the touchdown box, but I think I will in the next couple of landings. I'm figuring out ... again I haven't flown this in several weeks and so my technique ... I'm having to relearn here, but for longitudinal Cooper-Harper: controllable? Yes. Adequate? Yes. Satisfactory without improvement? No. I'm going to rate that a 4 and I'm going to say basically I think overall, as far as aim point, as far as deviation from landing, sink rate, I think it's really borderline adequate/desired. So I'm going to give it the benefit of the doubt and go with a 4. The thing I did not like is the autoflaps coming in for 400 ft for 18 sec. It really does make the ... you get a nice stable glide slope and then what happens ... which is exactly wrong from what the FAA wants you to fly on approach ... you have a stabilized approach going, and then all of a sudden your approach becomes very unstable in the longitudinal axis when the autoflaps come in. I really think that's a bad idea to do that. I know we have noise constraints and all that require that, but that really is ... it makes an unpredictable flight-path change, and I would see very, very rapid deviations above glide slope, trying to compensate. What happens is, I am putting in a lot of forward stick trying to get the gamma back down. And then when the autoflaps quit sequencing, now all of a sudden you're in a position where you have to recorrect that, right as you approach the flare; so instead of initiating the flare from a stabilized position I am having to initiate the flare from an unstable position. So that's a 4, kind of borderline 4 to 5. But the lateral-directional Cooper-Harper, however: controllable? Yes. Adequate? Yes. Satisfactory? Yes, a 3. Basically I think my wide dispersions were almost directly on centerline. And localizer control enclosed was not a factor. Comment again on longitudinal: one of the reasons I gave it a 4 was, I also factored in the nose derotation, which is not really one of the graded standards but it is part of the task. Since the nosewheel touchdown is the end of the evaluation and that really is nice enough for that kind of overall, helps pull up the ratings.

Task 4025, Approach and Landing With Flight Director

Pilot A. Longitudinal glide-slope tracking, pilot's decision, is it controllable? Yes. Adequate performance attainable? Yes. Satisfactory without improvement? Yes, I would say it was a 1 (one) for glide-slope tracking. For lateral-directional Cooper-Harper, glide-slope tracking and localizer tracking: is it controllable? Yes. Adequate performance? Yes. Satisfactory without improvement? Yes, but I would have to give it a 3 because the flight director seemed to induce a PIO for me, when I tried to hold it precisely. The net result was a very small order bank angle PIO, probably 5° or so. I went back and forth, trying to track that flight director. The landing itself—Cooper-Harper: I would give it basically the same rating as the previous one. What did I give it on that? (A 3 on that.) A 3 for the inability to precisely get control of the sink rate. For lateral directional for the landing itself: I would give a 2. It was controllable—well let's give it a 2. The main distinguishing feature of the flight director, it seemed to me, was that it was a little overly sensitive in roll axis. I mean, the displacements were such that it was difficult to keep it pegged. It is possible the breakout forces being so heavy might cause you to overshoot slightly. It is just easier to hold the glide slope because you can look at the flight director cue, which is right close to the gamma that you are using to move around with the stick, and so you could concentrate on the pitch without having to go back up to the glide-slope raw data, which is quite, so often, a ways away from the gamma symbol. So it was just a lot easier to track.

Pilot B. Run 33, task 4025, approach and landing with flight director. The first part of it is the ability to rapidly maneuver in the final approach path at low altitudes and attain current flight before the middle marker, which actually doesn't make much sense in this control law because there's no trim from a pilot's standpoint. At any rate, I found the longitudinal axis in the approach pretty easy. Very similar workload to that without a flight director; I think any increase in precision was offset by a slight tendency to make very small overcorrections with flight director movements. In terms of workload I thought it was, overall, relatively similar to what I saw before.

Lateral directional: there is a mild tendency to go back and forth in the turbulence and with the flight director motions. I don't think I noticed it before because there was no tendency for small frequent corrections like there is now with the turbulence and the flight director. Again, I think the workload is similar but the precision isn't a whole lot greater.

From a longitudinal standpoint: it's controllable and adequate, and I believe it's satisfactory without improvement at minimal pilot compensation required for desired performance in the longitudinal axis with mildly unpleasant deficiencies that I talked about. I'd give that an HQR of 3.

Lateral directional: it's controllable, adequate, and satisfactory, and again, minimal pilot compensation which I talked about, and give it an HQR of 3.

For precision landing: the interesting thing here from the longitudinal standpoint was difficulty and precise positioning of the nose just prior to touchdown. I always felt like I was hunting around for the correct attitude, and part of the problem is, there's nothing really on the display that tells me where to put the nose in that last few seconds prior to touchdown. The commanded gamma doesn't tell me; the actual gamma hasn't deviated enough to tell me, although it lags a little bit. I just feel like I'm hunting for a position just prior to touchdown. Also contributing to this is the fact that I find the radio altitude cluttered a bit, hard to find quickly, and I'm listening primarily to the voice for altitude cues so I kind of feel like I'm clueless in the last second or two just prior to touchdown.

From the lateral-directional standpoint: I again noticed a mild tendency to wander left and right with very small corrections. These are very fine degrees of wandering—on the order of 1/2 a degree or less, left and right, but they're there. There's a tendency to float when I followed the guidance, and that's because the guidance will take you high during the flap transition for reasons we don't understand yet. When I didn't follow the guidance ... when I followed the raw data and kept the glide slope under control ... there wasn't really a tendency to float at that point. So that's where the tendency to float is coming from, I believe.

Longitudinal HQR: controllable, adequate, and I'm going to say it's not satisfactory based on moderate pilot compensation of the longitudinal axis. I've talked about what those corrections are and given an HQR of 4. I think, however, that this is largely a display issue and with the right display we could probably correct that.

Lateral directional axes: it's controllable, adequate, and this time I believe satisfactory, with mildly unpleasant deficiencies, with a little bit of wandering in roll, but nothing that requires pushing us to level 2. So, it's minimal pilot compensation, mildly unpleasant deficiencies with an HQR of 3. That concludes the comments.

Pilot C. Okay, this is run 61, item 4025, normal approach with landing, flight director. First some comments for their glide-slope intercept part of the exercise. That all goes reasonably easy, and you can handle that in either of two ways. You can be very active on the stick and control with minute inputs. It takes quite a bit of activity on the stick and considerable workload, but you get very, very precise glide-slope intercepts that way. But take a different approach and just try to do an open loop with tweaking, it ends up with significantly worse performance but still well in the desired category, I believe. Let's get the Cooper-Harper rating: is adequate performance obtainable with a tolerable workload? The answer is yes. Is it satisfactory without improvement? I am going to say no. Minor but annoying deficiencies—desired performance requires moderate pilot compensation. And in this case it is the minor but annoying deficiency in that you have to work too hard to try and get the precise heading changes that you would like to get and the attitude control, so that's both for pitch and roll. If you ... so it's Cooper-Harper of 4 in both cases, in my mind. Excuse me. Back to the precision landing phase from 400 ft on in. Again, the flap maneuver is not very difficult to deal with. It's as if it's ballooning and it tends to make you go high on the flight path, but it's not a bad feeling from watching this happen through a visual. It does cause some extra effort to try and make sure you get down a little bit to get back on the glide slope so that you don't go long. Again, the technique here for being most precise on the landing requires, at least for me, to have a very high bandwidth input to the stick. If I do that, then I can control the flight-path command marker much

more precisely than I could before. However, every so often it causes me to ... my rapid inputs cause a rather large excursion over which I have to re-correct back. Once in a while it can cause a jerk on the passengers but it eliminates the side to side poor lineup that you get if you try and do it in a more open-loop fashion. It's a high workload, but you can put the vector where you want, and once more you can feel like you are controlling the airplane to flight path to where you would really like to have it. The rotation is a little difficult to do on the visual, but using that technique I can get desired performance. However the compensation level is quite high. So, is adequate performance obtainable with tolerable pilot workload? Yes. Is it satisfactory without improvement? I have to give it a 5. Moderately objectionable deficiencies, adequate performance requires considerable pilot compensation. I cannot make the desired performance with moderate pilot compensation. It takes me more than that, so I fall under the category of 5. And that's for both pitch and roll ... my comments are appropriate.

Pilot D. Pilot D, December 5th. Just finished the approach and landing with the flight director. Task 4025 ended with run 53. Task is pretty much the same as without the flight director. Looks like the flight director actually has a couple little problems. One is, it allows the path to balloon as much as a dot and a half as the flaps extend. And the other is that it's not a very aggressive flight director. I intentionally had a half-dot offset at 4, 5600 ft. It never did get us back within about 20 ft of the centerline with fairly accurate tracking. But no problems with the airplane, other than comments applied to the previous task. Pilot ratings here: the approach, longitudinal, and—shoot—what do you give it here with that flight director that definitely needs fixing? We're definitely still getting desired performance, and yeah, let's make it a 4. And laterally: I wasn't doing a whole lot this time because it was a straight end task, so I didn't notice the high stick forces and everything it had with the localizer intercept. Let's ... I still notice the dog-gone tendency to S-turn or PIO on roll ... I'm not sure what it is. Let's stick with a 4 on that. That definitely does need fixing or could use some work on anyway. It may not be fixable. I think though there's a couple things that could be done. The landing for the longitudinal: we definitely are into a 5 with the touchdown performance and with the autothrottles, etc., etc. So the question is: adequate, moderately objectionable

deficiencies, adequate performance requires considerable pilot compensation. Yep, I think a 5 still applies there. It's really not a different task from the previous one, because mostly the flight path and the flare cue are about the same at that point anyway. Now I'm ... about that ballooning that we're getting ... that I was putting into the approach, but it does happen below 400 ft, so technically that ballooning ought to be on the landing, which seems a little funny. Okay, laterally: not a big problem in the flare and the landing. And I don't even notice the S-turn during the flare. Let's give it a 3. Same as last time. Now, hold on, hold on. We had that problem with the flight director. Yeah, definitely needs fixing. Again, it's not an airplane-related problem, but let's give it a 4 just because that needs fixing. If you can definitely get yourself out of desired performance ... well it's very easy with that flight director. But as long as you track it from 1500 ft on down, no problem. But it's definitely something that needs fixing. Give it a pilot rating of 4.

Pilot E. Task 4025, nominal approach and landing of the flight director. All of my comments remain the same pretty much, as far as on the approach autoflaps and the like and the other comments. The ... this is a higher workload task in that to fly the flight director, my ... actually what I call a higher gain task ... it forced me to be more precise. It's making me get in the loop more often. On the raw data, I would not detect the deviations as quick as the flight director detects them. And therefore I would make lower frequency and longer term, smoother corrective inputs. So this was causing me to be a little more tightly in the loop with a little higher gain in tasking. However, the performance tends to be a lot better. For longitudinal Cooper-Harper on the glide-slope intercept down to 400 ft: controllable? Yes. Adequate? Yes. Satisfactory? Yes. And I'd give this a Cooper-Harper of 3. Certainly pilot compensation is required, which gives it a 3 not a 2, even though the criteria were quite good on that—a little bit higher workload task. For lateral-directional Cooper-Harper: not so noticeable in the lateral axis as far as the workload increase. It's also controllable, adequate, and satisfactory, for a 3. The precision landing ... we will say up front that we believe there's some error in what the score card is showing us on H-dot and what we think H-dot is, but based on Dave's expert interpretation of the firmness of the touchdown, he's thinking, both of them were both

around 2 to 3 ft/sec, which is the desired. And both of the distances were in the desired. The first landing, I followed the flight director all the way to touchdown, and I thought we hit about 4 or 5 ft/sec, but it gives a 0.9. The second one, I kind of followed it and kind of sweetened the pot a little bit to try and soften the touchdown. That's why I think I landed just a little more towards the long end of the box. But, at any rate, longitudinal: controllable? Yes. Adequate? Yes. Satisfactory? Yes, for a 3. And lateral directional: similarly, controllable? Yes. Adequate. Satisfactory. And I may go ahead and give this a 2, because I really was not working the lateral axis at all that I can recall in that task once I got stabilized on the glide slope. With no wind, it pretty much held the track fairly well.

Task 4050, Precision Landing

Pilot A. Is it controllable? Yes. Adequate performance attainable? Yes. Satisfactory without improvement? Say yes. The landing flare part of it, a 2 or 3. Following the flare guidance, carefully, it is probably a 2. Most of my landings were without precisely following flare guidance and I usually ended up landing hard, so I guess I will have to give it, with all the information available there, a 2. But I'm a little bit concerned about the split-outs we are getting between actual versus commanded. That's common for low airspeeds. Lateral directional: I'd give it a 2. It's controllable, adequate performance is attained, satisfactory without improvement; it seemed to be adequate. The only thing ... I would like to see a track hold feature or a ... forces are a little on the high side laterally.

Pilot B. Run 16, task 4050, which is the precision landing task. There is no separate card here. Evaluation basis is evaluate handling qualities landing and high gain tasks, no tendency for APCs or to bobble in pitch or roll. No tendency to flutter bounds. In general, I didn't notice any pronounced tendency for APCs, maybe a little bit of tendency to overcorrect, but the APCs maybe consisted of half a cycle or just one overcorrection in coming back, so no pronounced tendency for that.

No bobbling in pitch or roll for high gain tasks. Definitely no tendency to float; there is a tendency for a firm touchdown and a little bit of control difficulties in the longitudinal axis. Lateral directional: very minor difficulties but nothing pronounced.

I was able to get desired performance in everything but landing H-dot. Landing H-dot still tended to be firm. I'm sure I could improve on, given time, but I don't think that's the issue here. I think there is a tendency to land firmly.

Okay, longitudinal: it's controllable, adequate performance is obtainable, and it's not so much that it's unsatisfactory, it's just that desired performance requires moderate pilot compensations. I'm going to give it an HQR of 4, Level II, and say that deficiencies require improvement.

In the lateral directional axes: it's controllable; adequate performance is obtainable. It is satisfactory without improvement, and I'd call it minimal pilot compensation ... a little bit of tendency for overcorrection in the lateral axis, and that's basically in correcting the drift rate from side to side. Occasionally it got a little bit of an overcorrection and overshoot. I give that an HQR of 3. That ends the comments.

Pilot C. Run 64, item 4050, precision landing. Okay, comments for this are very similar to the precision landing comments. The previous ones with the meatball ... not very different with or without the meatball in this final segment because you have the runway references and you can just put the flight-path marker where you want, and you don't need the meatball to tell you that very much, so it's not a significant difference in my mind. My same comments about having to be a high bandwidth on the stick in order to have good control of the airplane and keep it going where you want it to go. That has taken its toll. I begin to tire from that now and I wish I didn't have to work quite that hard to do it. However, using that technique, I feel relatively confident. It's just a relatively high workload and the Cooper-Harper rating essentially is the same as before. It's not satisfactory without improvement—moderately objectionable deficiencies—adequate performance requires considerable pilot compensation. Cooper-Harper of 5. [Unintelligible], pitch and roll.

Pilot D. Pilot D, December 5th. We just completed task 4050, which is the landing from a short final. We ended with run 56. My comments for task 4020 for the landing phase all apply here, with the exception that I noticed a lot more roll activity during this phase than I did when I was all established on the final approach. I think it just kind of points up that there is a tendency for me to PIO in roll or roll heading coupling there.

And again I think the factors of the roll coasting, the high stick forces, are contributing to this. I notice the controller is awfully heavily damped also. I'd like to see it just a little more lightly damped. Longitudinally: just about the same—same comments. Pilot ratings: I'm stuck with the same there. Let's give it a 5. And lateral: I'm going to give it a 4 because of the PIO or the roll activity that I seem to self-induce.

Pilot E. Okay, 4050, precision landing. Then again, the previous comments apply. The problems with the autoflaps, of course, you hit right off the bat. It's almost ... to me it's somewhat unpredictable. I've tried to make an anticipatory nose down, almost like a prophylactic input of forward stick trying to negate the ballooning, and I never can seem to hit it just right. What happens is, when I get to the flare point, I am not consistently on the same glide-slope position. What that means is, I'm not getting a consistent flare maneuver. In trying to set a nice, clear attitude to get a nice, soft landing, I'm tending to float just a little bit, getting a little bit on the longer side of the box. We've discussed ... not for the benefit of the tape ... but we are getting some bounces and recording all the parameters on the second bounce, and therefore I'm not sure exactly what our primary impact data are. At any rate, longitudinal Cooper-Harper: controllable? Yes. Adequate? Yes. Satisfactory? Yes, Cooper-Harper of 3. Although, I think I may change that. And make that satisfactory without improvement? No, and give that a 4. The reason being, for whatever reason, I'm just getting into the loop, in this particular task, down to 400 ft. Initially, I am having to compensate for the autoflaps. Before, on the longer approach, I'm kind of, pretty much have gotten some time flying the airplane, imminently familiar with the response characteristics; I'm not overcontrolling the balloon so much. Also, I think now I'm tending to more aggressively counteract that balloon. Whereas before, having not had much experience, I was more or less along for the ride. So I think the fact that I know more of what I'm doing now, as far as this landing task, I'm trying to more actively fight the balloon. I think I maybe kind of hit the gate here, which says, requiring moderate pilot compensation. I think I'm definitely across the line now from minimal to moderate. So I'm going to do a 4. Lateral directional: controllable? Yes. Adequate? Yes. Satisfactory? No. I'm also going to give that a 4. And the reason being, when I'm making this attempt to control this balloon more aggressively, I'm finding

myself coupling into the lateral axis and getting some angle of bank. Therefore, kind of having to work much harder to maintain runway centerline. So it's some interesting phenomena have resulted from this closer-in task.

Task 4062, Landing From Lateral Offset—Moderate Turbulence

Pilot A. Okay, we'll start from the bottom left longitudinal. Let's see ... glide-slope tracking, pilot decisions: is it controllable? Yes. Adequate performance attainable? Yes. Satisfactory without improvement? Yes. Improvement required—I would say that it's a 1 for the glide-slope tracking. Okay, lateral directional, Cooper-Harper, glide-slope track and localizer tracking—is it controllable? Yes. Adequate performance? Yes. Satisfactory without improvement? Yes, but I would have to give it a 3 because the flight director seemed to induce a PIO for me if I'm trying to hold it precisely. The net result was very small order bank angle PIO—probably 5° or so. Five degree bank back and forth trying to track that flight director. The landing itself, longitudinal Cooper-Harper: I would give it the same, basically, rating as the previous. What did I do on the previous one, on the longitudinal for the landing, a 3 because of the inability to precisely have control of the sink rate. And the lateral directional, for the landing itself, I would give that a 2. It's controllable; yeah, I'll just give it a 2. And let's see ... I think I gave you comments as we went along ... the main distinguishing feature of the flight director, it seemed to me, it was a little overly sensitive in roll axis or something; timing in the displacements were such that it was difficult to keep it pegged in the middle. It's possible too, breakout forces being so heavy, that caused you to overshoot slightly. A little fine ... this coolie hat on the stick here, I think ... a little bit for, you know, for half degree, some small track change. That might be helpful to have fine-tuned. Fine-tune the track and the glide slope, you know, within a tenth of a degree or some, some value.

Pilot B. Run 22, task 4062, landing from lateral offset in moderate turbulence. Our task was to evaluate the handling qualities in a high gain task, the high gain task being an offset from centerline with a correction at 225 ft AGL. The evaluation criteria were, no tendency for APCs or bobble in pitch or roll and tendency to float or bounce after touchdown.

As far as performance ... we'll talk about the PIO here in a second ... as far as performance in the absence of PIO, I felt like the longitudinal touchdown point was fairly difficult to get desired performance and not so difficult to get adequate performance. Maximum bank angle below 50 was tough; that was a technique-oriented task. In order to do that, you had to either accept a float or you had to make a very early aggressive correction to get there. Deviation for landing airspeed didn't seem to be a problem, although I'm not controlling that. Touchdown sink rate: there's a tendency to land firm, although this time I didn't seem to exhibit that as much as before. Runway heading was not as much a problem.

The longitudinal axis: the problem here is that you've got a very heavily loaded lateral-directional task, so you don't have as much time to concentrate on the longitudinal axis, whereas previously you got everything suitcased laterally so you have a lot more time to concentrate. In the longitudinal axis, the problem wasn't so much that the longitudinal was bad, it's just you didn't have time to work on it. It is controllable longitudinally; adequate performance is obtainable. However, I'd say that adequate performance requires moderate to considerable ... let's see, you guys still won't let me give 0.5's. I'm not ready to say it's considerable; call it moderate still, an HQR of 4, and just note that if I could I'd give that one a 4.5.

On the lateral directional axis: we actually never let it go to the point where I lost control. I'd say we'd have done some damage on the landing. I think I would have been able to set it down without destroying the airplane, but I think we would have done some major damage here. So I'd say ... no I can't do that. Let's give it an HQR of 10. At some point I lost control; we didn't keep it long enough to see if I could have regained it, so I'm going to assume that control was lost. So we'll give that an HQR of 10. The issue here [is] when you lose control like that was the task that you are asking the airplane to do reasonable. Could you expect that some pilot during some phase of that mission would do that? And I'd have to say yes. In trying to get that correction back, you're going to get pilots who are going to make aggressive corrections to get it back to centerline, and repeatedly in this task I was able to excite rate limiting and PIO in the lateral directional—primarily the lateral axis. I'm told the rudder was oscillating stop to stop. But the effect

from the pilot's standpoint—since you've got lateral-directional coupling in the flight control system—the effect is the lateral pilot-induced oscillation. That concludes the comments.

Pilot C. Okay, for the tape, it's run 66, and they tell me 4062, landing from lateral offset with moderate turbulence. Position lateral offset landing is what we're evaluating here. The motion cues as I do my correction to the runway seem rather extreme compared to what I see out through the visual. I don't know which impression is right. But they're rather uncomfortable doing that, and if the first class passengers are feeling anything like I do, it would not really be a nice ride to go through. However, it doesn't seem to me that it's right for the visual at this point. The task is accomplished with a moderate level of compensation and the performance is normally in the desired or adequate range. I feel quite confident in doing the maneuvers. By the time I'm ready to touch down I'm still having a little bit of transients from things being rushed a little in the flare and not as confident in the touchdown H-dot as I would like to be. The precision of the landing otherwise was reasonable. I still have to use the same kind of techniques that I was using earlier that gives me the feeling of positive control—in other words, that high bandwidth inputs to the system even while I'm doing the maneuver. So again, is it satisfactory without improvement? No. And I still retain the same objectionable deficiencies, Cooper-Harper of 5. And it's considerable pilot compensation required to do that high bandwidth kind of inputs to get the precision I like. And those ratings and comments apply to both pitch and roll.

Pilot D. Pilot D on December 5th. We just completed my first attempt at landing with offsets. Task 4062. We ended up with run 64 with moderate turbulence. The moderate turbulence doesn't seem to be a real big factor. The thing that's really biting me and giving me the hardest time is the lateral-directional characteristics, the turn coordination. Just can't seem to quite get it sorted out. In fact, we even attempted to make it without using the rudder. I got into a limit cycle—Dutch roll—and had to let go of the control to let it damp out. So that's really my biggest problem. That's lateral directionally. Longitudinally I tend to get a little bit lost of where the glide slope is during the correction. I think the depressed pitch line of 3° would really help there, in there, because you can kind of put

it down on the runway and keep it on the runway where you want it while you're making the correction. I think that was part of the problem I was having hitting the touchdown point. I think the biggest problem, of course, was the lateral-directional problems were just overworking me. Pilot rating: longitudinally, well, we're definitely into a 5, just from our performance. In fact, we haven't always been adequate but we did have some inadequate longitudinals. We touched [down] quite short one time, didn't we? Yes. Short. Way short. So performancewise, it forces me into a 7. I don't think it's that bad longitudinally. So I think the two reasons I gave: one the high workload on the lateral directional and the fact that I don't have the time to be scanning that glide-slope deviation, the depressed pitch line. I tend to get ... don't have the depressed pitch line. It's causing me to get a little bit lost where I should be in respect to glide slope. Let's give it a 7 based on performance. Okay, lateral directional: we never did get an adequate lateral directionally, I think. We were always adequate weren't we. I think that's correct. But I think just from the aircraft characteristics and the workload, that I'm going to give it Level III, major deficiencies ... that turn coordination really needs to be helped, to help me anyway. Okay, so that will be a 7.

Pilot E. Okay, this is 4062, landing from the lateral offset, moderate turbulence. This is a very demanding task and you're forced—in order to satisfy your Cooper-Harper of no more than 5° phi below 50 ft—you are forced to make a very aggressive initial correction. And that initial correction then results in two problems. One, glide-slope control and the other airspeed control. What I thought was my best approach of the whole day, somehow in the aggressive correction, I must have lost some airspeed. And ... 'cause I thought I did my normal technique of pulling the power back and starting ramping it out gradually at 100 ft, I ended up landing at 129. Excuse me. Inadequate for that one, but I thought that was the best overall approach. I'm having to make some pretty aggressive longitudinal corrections in the lateral correction, to try and keep that glide slope from going high. If you go high, then it's very difficult to land in the box. So it's ... a lot of very aggressive maneuvers are required on this. Pretty much, on the definitive final approach, I met all of the desired criteria, but the workload is going to keep it away from Level I. So, controllable? Yes. Adequate? Yes. Satisfactory? Yes.

This is for longitudinal. No. I'm going to give it a Cooper-Harper of 4, mainly because of moderate pilot compensation. It's a very high workload task and you're having to aggressively fly the glide slope, which, in your corrective turn, it's probably a little bit, not exactly true, because you are flying a longer distance to the runway; plus it's set for a lateral offset. So you're almost having to visually and try to fly your proper approach path. The lateral direction: controllable? Yes. Adequate? Yes. Satisfactory? No. Also a 4. There's a lot of annoying side forces you feel in the cockpit, which to me make the task harder because it's giving me cues that I'm not normally use to. Again, I spent a long time on that because that's the way [we simulate forces] of gravity or what. It does tend to cause a little confusion when I'm trying to make the lateral corrective response.

***Task 4066, Landing From Lateral Offset—
Category I, Moderate Turbulence***

Pilot A. And the last run was run 35, longitudinal, Cooper-Harper rating: is it controllable? Yes. Adequate performance? I guess I would have to say yes in this case. Is it satisfactory without improvement? I would say that result was satisfactory, so I guess I would have to say yes and give it a 3, because although there were some splits in the pitch and phantom versus actual, they generally seemed to get the task accomplished within reasonable bounds. The very heavy friction on the throttles affected this particular task because disengaging autothrottles at a hundred feet would basically make you hit the performance landing touchdown point; with the speed proper, you had to add just a slight amount of thrust after you disengage the autothrottles and then pull it back to idle for the landing. So any time you move the throttles at all, especially adding them, pushing them up, bringing them back, it's very heavy forces and distracts from your task with the stick—just a side comment. So, lateral-directional Cooper-Harper: I would say it's controllable. Adequate performance attainable? Yes. Is it satisfactory without improvement? I would say no. As you roll, I'll give it a number 4. There seems to be some lateral accelerations that seem to come in with sharp aileron input when you start your roll to the left. There is a sharp g force, a lateral g that comes in. It took coordination; in this, lateral law seems to be not optimum. I'm not sure, at least the forces in the cockpit don't seem normal. But is there any type of turn coordination information for this at all?

Pilot B. Run 26, task 4066, landing from lateral offset, with Cat I weather conditions and moderate turbulence. The task was much the same as before and the results were similar, and the longitudinal axis: as far as an HQR rating, it was controllable, adequate performance was obtainable. However it's not satisfactory without some improvement. Desired performance requires moderate pilot compensation. Keeping in mind that this is a linked display and flight control system task, I'm seeing some anomalies in the display the more I look at this. There was a run where I recorded a constant flight director position of slightly above the horizon while the sink rate continued in the negative direction, as evidenced by the radio altitude call. So there's some anomalies between the display and what we're seeing in the real world display versus the cockpit display that needs to be addressed, but the Cooper-Harper reflects both.

The lateral directional axes: I'm seeing two different sets of characteristics: that which I'm seeing in the absence of any position or rate limiting and that which I'm seeing in the presence of position and rate limiting. In the absence, the lateral directional is tough, but it's doable. And I'd call it extensive compensation in the absence of rate limiting and give it an HQR of 6. I think that's primarily associated with the task. The task is an inordinate task; you would not expect to see anything above Level II flight qualities in a task like that, because the pilot is going to go around in that situation if it really occurs. Now in the presence of rate limiting and almost as soon as it happens, there is a pronounced tendency for aircraft-pilot coupling and oscillations. The oscillations don't appear to be diverging, they appear to be relatively constant. I haven't experienced them long enough to find out what would happen if I just relaxed the control in preparation for a go-around to see if those oscillations would stop. But, it's almost like you throw an oscillation switch; there's very little a pilot can do about it once that starts. Once you get into the rate position limiting and the oscillations start. And obviously when that occurs there's an HQR of 10. This ends the comments.

Pilot C. Item 4066. Landing from lateral offset, Cat I, moderate turbulence, and C is the pilot. This task is very similar to the offset landing task that we do. A little more difficult because of less visual acuity to the runway when you're getting ready to make the

correction to final approach. Felt a little more apprehensive in general because of the low visibility. Performance wasn't quite as good as it was before. Nevertheless, Cooper-Harper rating results about the same, with the same kind of comments about the control as for the previous landing. Is it satisfactory without improvement? No [with] moderately objectionable deficiencies. Adequate performance requires considerable pilot compensation of 5. Both are—lateral directional and pitch.

Pilot D. Okay, Pilot D, on December 6. We just finished landing with an offset in Cat I weather. That's task 4066, so we had 10 runs. We finished up with run 10. Very, very similar to the previous task, where we had the offset but with good weather. The visibility is a little bit of a factor but not a major factor, I don't feel. And the comments are pretty much ditto that 4062 task. I didn't get the limit cycle this time, because at least I was using the rudders. I only got that limit cycle on the Dutch roll when I tried to do it without the rudders, but the lateral directional is still saturating me. It's a very high workload trying to manhandle that thing around the corner. Early on, when we were practicing, I had been practicing with the Dutch roll, and in addition to not having any turn coordination, the Dutch roll frequency is very, very low. I think both of these things are just really contributing to a very high workload for that offset maneuver. Longitudinally, tracking the glide slope, ditto my comment yesterday on 4062. It is that I am really a little bit lost on what to do—on where to put the flight path, etc.—to try and hit that touchdown zone. It's fine when you're coming in straight and you're on glide slope, and then you transition from the glide slope to the flare cue, but when you make that offset I feel just a little bit lost. I think there's a couple of things could be done with the display to help out there. Pilot ratings: longitudinally, I am going to have to give it a 7 because I was landing short sometimes. I don't think the longitudinal is quite that bad from a handling qualities standpoint, but from performance I'm definitely 7, and I'm going to give it a 7 on the lateral directional. Major deficiencies. I think the lateral directional handling qualities really do need significant improvement.

Pilot E. Okay, 4066, landing from lateral offset, Cat I, moderate turbulence. This proved to be a very high workload task for me than what it should have been

because I get to correct a little sooner. But I think the lack of visual cues due to the reduced visibility is ... and the lack of peripheral cues because of reduced visibility has made it much harder for me. What I'm finding is, I'm making the correction and I'm not consistent on my glide slope coming out of the turn, and therefore I don't have a consistent flare point. Without the sharp, clear, visual cues, I'm not able to react quickly enough to that offset glide slope that's resulted from my lateral offset, so I'm kind of pretty much really working hard. My main effort is on the touchdown box, and that's why I've had a couple of firmer touchdowns. The ... also, even though I've gotten my lateral lineup problems solved early, it seems like late in the flare I also seem to be coupling with lateral axis and whether or not the pitch roll harmony of the stick could be tweaked a little better. Somehow it seems to be exciting the lateral axis when I make aggressive pitch inputs. And that is something we could do down the road, tweak the lateral pitch breakout and damping, but at any rate, that's a different story. Okay, this one is hard. We did a number of them and I didn't particularly like any of them. The sum total of things I guess, for longitudinal Cooper-Harper: controllable? Yes. Adequate performance? Certainly obtainable. Satisfactory without improvement? No. It's kind of difficult for me to get desired on all the parameters. I could either get a desired touchdown sink rate or a desired X-position, but I have a hard time getting both of them. But I think the sum total is probably a Cooper-Harper [of] 4. Borderline desired/adequate, and I'm going to kind of guess—give it the benefit of the doubt—so it will be a 4. For lateral: controllable? Yes. Adequate? Yes. Satisfactory? No, and I'm also going to rate that a 4; the reason being, for some reason I am exciting the lateral axis in the final flare. On the actual correction, it's not too bad. It certainly is not a fighter airplane, and it's a lot of workload, but there's something going on. Either I'm not quite getting my line-up set just right. I'm having to work all the way down, and it's not responding quite as well as I would like, but it will come out to be a 4 also.

Task 4072, Landing From Vertical Offset—Moderate Turbulence

Pilot A. This is the landing from a vertical offset, moderate turbulence, 4072 is the condition, and last run number was 39. Longitudinal Cooper-Harper: is it

controllable? Yes. Adequate performance attainable with a tolerable pilot workload? Yes. Is it satisfactory without improvement? I'd say probably no. I'd give it a 4 because of the difficulty with the side stick controller, which is so heavy it is difficult to fine-tune the pitch adjustments. The heavy detent, combined with the very heavy throttle forces, makes it really awkward. Actually it's not the throttle forces but the large distance between the pilot and the throttles. It's a little farther than you would like. You would like the pilots a little closer together, I think. Cooper-Harper lateral directional: gee, I had no problem with that at all; give it a 2. Controllable, adequate performance attained with a tolerable pilot workload? Yes. And satisfactory without improvement? Yes, good, negligible deficiencies. Rate it—give it a 2.

Pilot B. Run 30, task 4072, landing with a vertical offset in moderate turbulence. Same evaluation basis as before except with a vertical offset. As far as the longitudinal axis, just by way of editorial comment, the vertical offset isn't tremendous. A 500-ft offset down the runway is a fairly small deviation in terms of longitudinal correction required at 225 ft. We can work out the math but apparently it's fairly small. The longitudinal axis is controllable; adequate performance is obtainable and is satisfactory without improvement. And once again, moderate compensation requirements, and this is the same task as before at this point, because a vertical offset is not causing me a whole lot of difficulty. It's the flare and touchdown task that creates the compensation requirements. So, much the same comments as before, with an HQR of 4 and moderate compensation—hunting for the correct pitch attitude just prior to touchdown.

Lateral directional is not much of a problem: It's controllable; adequate performance is obtainable; it's satisfactory without improvement. In the moderate turbulence, minimal compensation requirements. Occasionally I saw myself with 1 or 2 overshoots, so give it an HQR of 3.

As far as the qualitative comments, it's much the same as what I saw before. The primary difficulty is in finding the correct pitch attitude at touchdown and overshoots and corrections for that. This ends the comments.

Pilot C. Item 4072, landing from vertical offset with moderate turbulence. Pretty much the same comments

as before with these modifications. I thought the task was easier to do than the lateral offset in both cases, with and without the poor visibility. This to me was easier to do than the duck down, when you didn't have to add the complication of trying to put in the roll controls to get over there. I felt quite confident in the round out and, although both these patterns were a little short, nevertheless, my confidence factor was good and was just a matter of some more practice to get desired performance. The workload is still what I would say more than moderate to do a good job in the touchdown zone. Is it satisfactory without improvement? I still believe that it's moderately objectionable deficiencies, and adequate performance requires considerable pilot compensation but I do believe that this is now getting close with the amount of learning curve I have. It's getting close to minor but annoying deficiencies. I still have to call it a Cooper-Harper of 5, for both the pitch and roll axis.

Pilot D. Okay, Pilot D, on the 6th of December again, task 4072, vertical offset, good weather. No problems laterally this time. We're right on centerline and no perturbations. Longitudinal: having a hard time. It's the same sort of scenario as the offset actually. I'm not perfectly on the glide slope coming into the flare, I have a very hard time trying to find out what to do with the vehicle to get it to where I want it to go. And so I am, consequently—and in this case I'm landing long instead of short—but the same general problem, I feel. Because of the performance, we have got to give it a pilot rating of 7, longitudinally. Laterally: let's give it a 3.

Pilot E. Okay, that was task number 4072, landing from a vertical offset in moderate turbulence. Longitudinally: the task was not difficult; it's not that high an offset. I used the velocity vector to put it on the landing point. Just dropped it down and made a fairly smooth correction. Initially I was having trouble getting soft sink rates, but I was just spot landing, and I was flying the commanded velocity vector without trying to compensate so much for the actual vector and in an attempt to put it in the box. And all of them were in the box, but they didn't get quite the softness I would like. The maneuver: basically, I thought I was back into a nominal landing, pretty closely, so I don't really know if the vertical offset caused any problems in close, so it's not really a difficult maneuver to correct from. Okay, it says, evaluate the ability to recover

from the off-nominal glide slope; evaluate the effects of the approach aids. What does that really refer to? I mean, the approach aids are telling me I'm actually low when I'm trying to correct from off nominal. Okay. Basically it's all visual when you correct your spot landing onto the box. I met the desired criteria I think overall, in both lateral and longitudinal. So, controllable? Yes. Adequate? Yes. Satisfactory without improvement? Yes. I would rate it a 3, because basically, you're lined up when we had the lateral problem solved, as opposed to the lateral offset. The vertical problem becomes much easier. There's a whether or not it's an actual coupling or not between pitch and roll, when I have to make a strong lateral move, I do have a harder time controlling the pitch axis. So since we're lined up straight-ahead, there's no real coupling with lateral axis on a pure pitch input. And so the lateral problem wasn't there, and the pitch problem is actually a little bit lessened, even though you're off in pitch and have to make the big lateral correction. For the lateral directional: controllable? Yes. Adequate? Yes. Satisfactory? Yes. Also a 3. Basically, you're just having to keep the thing on centerline, so it is taking some effort there, so—minimal compensation.

***Task 4076, Landing From Vertical Offset—
Category I, Moderate Turbulence***

Pilot A. Task 4076, landing from vertical offset, Cat I vis with moderate turbulence. Okay, run 42 was the last run. Longitudinal Cooper-Harper rating: was it controllable? Yes. Was adequate performance attainable with tolerable pilot workload? Yes. Satisfactory without improvement? I would tend to rate it a 4 because of the high forces coming in and out of detent and the ability to fine-tune the gamma in the later stages of the flare, the heavy forces in the throttles. Lateral-directional Cooper-Harper: is it controllable? Yes. Is adequate performance attainable? Yes. Is it satisfactory without improvement? For this task, I would say yes. I give it a 2, with no visible deficiencies. Not a factor in desired performance.

Pilot B. Run 33, task 4076, landing with a vertical offset in Cat I weather. Pretty much the same task as before—this time I did notice that, with the weather conditions, I felt the need to make a vertical correction more than I did before. I think it's because of the lack of visual cues at the far end of the runway. Classically, you do tend to think that you're high in weather condi-

tions that may reflect it. I'm also trying to correct a little bit for the airspeed error at touchdown—to try to bring that down to a lower number—and the way I'm doing that is delaying the power reduction a little bit and the flare. I'm going to give the benefit of the doubt to longitudinal performance. There are times when I got adequate and times when I got inadequate; very seldom did I get desired, although that happened occasionally as well.

The longitudinal axis is controllable; adequate performance is—I'm going to say—is obtainable. However, the longitudinal axis, I still feel like I'm working with the display. I don't feel like I have a problem putting the nose where I want to; I feel I have a problem in sensing where to put the nose—it's a display issue, is what that tells me. However, in terms of a joint handling qualities, desired performance requires moderate pilot compensation in hunting for that attitude. I'll give it an HQR of 4.

Lateral directional: I did notice in the weather here, with the lack of cues, a couple of times where I was getting 1 or 2 overshoots of the lateral axis, and I was deliberately reducing my gains in order to calm it down—so a very minor tendency for wandering in the directional axis. I'm not going to degrade that to Level II because I don't think it's serious, but it's there. It's controllable; adequate performance is obtainable and is satisfactory without improvements with those comments. Mildly unpleasant deficiencies and minimal pilot compensation—HQR of 3. That concludes the comments.

Pilot C. Landing from vertical offset with moderate turbulence, Cat I, item 4076. Pilot is C. Virtually the same comments as before. The visibility doesn't affect this task that very much, so I think my comments are essentially identical to before, and Cooper-Harper is the same at 5.

Pilot D. Pilot D on the 6th of December again. We just did another vertical offset, but this time with Cat I fog, and I can't tell any difference, and the case ... the weather doesn't seem to be a factor at all here. I did luck out on a couple of the runs and got reasonable performance, but then I blew it on one. So I think it's just inconsistent. I'm having a hard time sorting out the display, as far as getting the aircraft on the ground at the desired location, if I'm not perfectly set up on

the glide slope coming into flare. Let's give it the same pilot ratings of 7 and 3.

Pilot E. Okay, that was landing from vertical offset in moderate turbulence, Category I, 4076. Comments very similar to the previous run without the Category I. However, the reduced visibility is ... it's very obvious to me in making the lateral task harder. I don't have a very compelling lateral cue, as far as the runway centerline, that's extremely visible, and so I am having to search a little bit for my line-up. When I work for the line-up it makes the pitch task a little bit harder. The lateral, as I said previously, the lateral when I'm not set up laterally I find my pitch task a little bit harder. Also, with reduced visibility the clarity of your peripheral cues is diminished, and so the whole task becomes a little bit harder. I initially spotted a little bit too low but was able to recover and get a desired touchdown placement and sink rate. However, it certainly is a different task when you don't have the good, strong visual cues. I elected to not keep doing those. I think probably I would get some more erratic performance based on the fact that the visual cues are lacking there, but I think pretty much, I was going to come in to be a, say, borderline Level I/Level II task. For longitudinal rating: controllable? Yes. Adequate? Yes. Satisfactory? Yes. I would rate that a 3. Lateral directional: controllable? Yes. Adequate? Yes. Satisfactory? No. I would rate it a 4 because again, without the compelling lateral cues, I end up getting in the lateral axis a little more than I would like, and I'm kind of ... the wings are kind of just wobbling back and forth as I go down. And that's strictly an artifact of not having a strong lateral cue on the head-up type of approach. I cannot really ... the roll axis on the top of the HUD is not really coming into my field of vision, and so I'm not really ... it's more or less looking at the ... at line-up deviations that are making me respond.

Task 4080, Go-Around

Pilot A. We're calling this condition 4080, go-around. This last run number is 45. Longitudinal Cooper-Harper: is it controllable? Yes. Is adequate performance attainable with desired pilot workload? Yes. Satisfactory without improvement? I would say no; give it a 4, minor annoying deficiencies require pilot compensation. There's ... I guess, the split outs in the commanded versus actual is a continuous problem all

through the approach there. It seems split out quite a bit, and the go-around itself is not a problem. Pitching up and stopping at 17 is not a problem. Seventeen—the attitude—however, as soon as you let go of the stick, then the attitude drops because you are accelerating, and the angle of attack is decreasing and it's holding a constant climb angle. A better procedure might be to, instead of holding it constant attitude of 17 1/2, would be to climb to some fixed angle like 8 or 6°, 8°, or 10° of gamma. Just hold that gamma and let the autothrottle hold the speed. That would be a logical, a more logical procedure. The lateral-directional Cooper-Harper: is it controllable? Yes. Adequate performance? Yes. Satisfactory without improvement? Yes. It looks like a Level I. Good to negligible deficiencies for this task? Not a factor for desired performance, and I would prefer that we drop into a track hold when the wings are level and there's no roll input on the stick. That would be helpful. I would probably give it a 1. And on the go-around, using the throttles to get the speed held is a bit of a problem, because while you're climbing, you have to maintain stabilized initial actual acceleration and then hold a constant indicated airspeed. So the final stabilized accel cue has to be above the symbol just opposite the top of the vertical fin on the flight-path vector symbol.

Pilot B. Run 41, task 4080, which is a go-around task at 100 ft, and the evaluation basis is the ability to smoothly go-around, establish climb attitude and speed with minimum airspeed loss or attitude overshoot, without tendency for APCs or to bobble in pitch or roll.

In summary, the task is doable; I'm satisfied with the performance. In terms of desired performance, I'm not noticing any pronounced airspeed loss, no tendency to overshoot the climb attitude; if anything there's a tendency to undershoot a little bit. With fine control there's a very small tendency for bobble and pitch. Nothing untoward noticed on the directional axis. As far as Cooper-Harper, for longitudinal: it's controllable; adequate performance is obtainable, and it is satisfactory without improvement. I'd say minimal pilot compensation required for desired performance and give it an HQR of 3, just a very small tendency for bobbling in pitch.

For lateral directional: it's controllable; adequate performance is obtainable; satisfactory without

improvement and pilot compensation is not a factor in this task. I'd give it an HQR of 2. End of comments.

Pilot C. Item 4080, a go-around, C is the pilot. After getting through the learning curve here, the maneuver was relatively easy to do and quite confident, with good control of most of the parameters. It's difficult to reach the little TOGA switch and had some difficulty with that first, but I think I've resolved that now that I can get that done, and the throttles coming up weren't too much difficulty. Is adequate performance attainable with a tolerable workload? Yes. Is it satisfactory without improvement? I'd say yes. Some mildly unpleasant deficiencies, minimal pilot compensation required for desired performance. Cooper-Harper of 3. Good for both lateral directional and longitudinal: Cooper-Harper 3.

Pilot D. Pilot D on the 6th of December. We just did some go-arounds. We ended up with run 24, task 4080. As in most go-around maneuvers, it's fairly mechanical. Had a couple or three problems though. The ergonomics on the throttles is pretty bad. It's kind of hard to be pushing the throttle forward, and at the same time you're hitting the TOGA button. I think at Ames we had the TOGA button on the forward end of the throttle, so it makes it just a little easier to do. I had to have help with getting the autothrottle off. Okay, the other problem I had was that the gamma V control system was just a little bit inappropriate for the TOGA pitch task, and I got into a fairly good PIO and pitch on one of those. If you recognize it and take it easy and approach your final pitch attitude slowly, it's no problem, but it is a workload holding the 17 1/2°. It almost seems like the TOGA button ought to transition to some kind of rate command attitude hold for the pitch task there. Other problem that I was having was setting the throttles to maintain the 200 knots. After you have done a few, you kind of pretty cognitantly figure out where to put the throttle. But the little acceleration cue has got so much lag in it—because it's the engine lag I presume—that it is a little bit useless in setting the throttles. Whereas we could put some throttle lead into the acceleration cue; it would really help there. Pilot rating ... it definitely ... let's see: Is adequate performance obtainable with tolerable workload? The workload is not all really that bad, it's such a mechanical task, but I did get into a PIO there once. So I am inclined longitudinally to give it a 7, because of the incompatibility of the control system in the task

and the tendency to PIO there, and I did get into a PIO on one of those. It ... you know, you could argue that, hey, with a little experience you wouldn't do that, but let's make it a 7. Laterally: no big problems. I don't really have any tasks. Let's give it a 3.

Pilot E. Okay, that was a go-around, maneuver card 4080. A couple of things on that one is [that] the task involves coming out of autothrottles, which is that moving a lever, then finding a TOGA button which is kind of awkwardly placed behind the throttle, and then advancing the throttle. So on the first run I was kind of thumbing my way through it. The second two are more definitive, but on the second one, for instance, I ended up being more deliberate on trying to find things, and so I was reluctant to pull the nose aggressively until I got the power up. And there was a slight delay between the time that Dave said, "go around," and I was able to get the autothrottles disconnected, find the TOGA switch, fly the airplane, press the TOGA switch, and then advance the throttles to full throttles, and then rotate. Therefore, we got down to about 30 ft. I think if I could skip the TOGA ... trying to find that TOGA button ... I could be quicker to do the go-around. The go-around itself, I see no problems with it. There is a tendency, when you're trying to set the waterline, to have to continually put in forward stick once you get to the 17 1/2°. And I believe—are we getting autoflap trimming out as we accelerate and that type of stuff? Yeah. Yeah, it's an 18 sec thing. Okay. Okay. At any rate, once I get stabilized to 17 1/2°, I'm waiting for the acceleration, there's a lot of forward stick input to hold the attitude there, and all I can assume is that the angle of attack is changing. And since I'm in the gamma command control law, that's probably not too unusual. Although it is, when you're trying to control theta, more of a higher workload task. The second one I did, I nailed the airspeed right on 200 knots and it didn't budge. This time I was being a little bit smoother and tended to overshoot a little bit but got back on 200 and stabilized there. This says "airspeed loss." I guess I don't know what that means. Can you comment on that, Dave, for the performance standard? Does that mean you don't want to get down below 152 knots? I have no idea whether I did or not. I basically ... I didn't pull the nose up until I went to full throttle, so I doubt I would have lost any speed, but I paid no attention to that. So it's kind of a ... for note here ... that's kind of, maybe, a less than specific performance standard right there that

we need to think about. But at any rate, I didn't see any PIO tendencies. It seemed to respond pretty quickly, once I got through this Rube Goldberg of having to get all these switches over here. It worked pretty well. So longitudinally: it was controllable. Adequate performance was obtainable. Satisfactory without improvement? I would say no and rate it a 4, mainly because holding a $17\ 1/2^\circ$ attitude, which is a requirement, takes a lot of work, and it's not necessarily completely predictable. However, I'm trying to fly theta in a gamma command control law which still has gamma command. It's ... this task makes it a little more difficult. Lateral directional: controllable? Yes. Adequate? Yes. Satisfactory? Yes—a 3. No real coupling between the pitch and the lateral axis when a pitch input is made, and very nice overall. In fact, I may change that lat dir to a 2, since there's really no pilot compensation required in that, without crosswinds or anything else.

Task 4085, Go-Around With Minimum Altitude Loss

Pilot A. 4085 is the condition, and the last run number was 49. Longitudinal Cooper-Harper: is it controllable? Yes. Adequate performance attainable? Yes. Satisfactory without improvement? Yes. Improvement was not required. Level I. In that case where there was minor ... I would give it a—in some cases, quite satisfactory. Maybe I'm coming up on the learning curve; I'll give it a 2. Lateral-directional Cooper-Harper: is it controllable? Yes. Adequate performance? Yes. Satisfactory without improvement? Yes. I'll give it a 2. In capturing the airspeed, it requires being cognizant of how that accel cue works. It is not entirely obvious. You have to take into account the sense of true airspeed changes—calibrated airspeed changes. In that respect, a head-down tape, airspeed with trend vectors would probably be easier to use.

Pilot B. Run 47, task 4085, go-around with minimum altitude loss. This one was a go-around at 30 ft, with the task being not to touch the ground, and with a minimum overshoot and a climb attitude. In terms of longitudinal characteristics, what I'm saying is that if you get very aggressive with it, you can get ... just touch the rate limit and a production system. I'd probably want to size the tail and the actuator bandwidth such that I would not ever get in the rate limiting and extremes maneuvering, but I'm not all that unhappy with what I'm seeing. If you drive it hard enough—hard enough being 1.8 to 1.9g—you just touch the rate

limit, you can feel that as a propensity for PIO which immediately goes away as soon as you relax the gains a bit. So it's there but it's not real pronounced. In terms of setting pitch attitude, there's a very small tendency for bobbling—a little bit of lack of precision in pitch and a tendency to undershoot. I'm finding routinely when I raise the nose to such $17\ 1/2^\circ$, I'm typically stopping around 15 or 16, then making a final correction to get back up to 17.5. It's not real bad. It's a minor deficiency.

Okay, longitudinal HQR: it's controllable, adequate performance is obtainable, and I'd say moderate compensation for desired performance. Although you can get it, you're working to get it, so give it an HQR of 4.

Lateral directional is not really a factor here: it's controllable; adequate performance is obtainable, satisfactory without improvement. Pilot compensation not a factor—HQR of 2, lateral directional. That ends the comments.

Pilot C. Item 4085, go-around with minimum altitude loss. It doesn't seem like the task is that much different to me than before. We didn't achieve any touchdown on either one of those. The rotation task and throttles up and switches were about the same as before. So it's a Cooper-Harper rating of satisfactory without improvement, mildly unpleasant deficiencies, minimal pilot compensation required for desired performance. Cooper-Harper of 3. Both pitch and yaw.

Pilot D. Pilot D on the 6th of December. Just did task 4085, go-around at 30 ft, and it looks like at least the gear were not banging the ground. We're not quite sure on the tail. The comments are, you know—it's essentially the same maneuver as for the 4080 task except the switchology on the throttles is a little bit ... to the fact that we already have the autothrottle off, but that's not a big factor. I'm going to give it the same ratings. I didn't really get into a serious PIO but there is that tendency to bobble, and I think the potential is there for a PIO. Let's give it a 7 and a 3. I would seriously consider using gamma as a reference for the go-around.

Pilot E. Okay, this was 4085, go-around with minimum altitude lost. We're going to kind of press on this one rather than split hairs here. I commented on the fact the TOGA switch is a little bit awkward to get to, and it somehow is preventing me from getting my

throttles up to max power as quickly as I would like. And that's causing me ... I'm reluctant to put in a lot of pitch rate until I get the power coming up. So that was causing probably ... I think if I could ... if I didn't have to press that TOGA button, I think ... I'm guessing that I could probably do this with less than 10 ft of altitude loss, 'cause it does seem to respond very quickly to pitch rate when I ... to pitch input. When I put in the stick, it does rotate very quickly, so pitch response, I think, is very good. I did meet the target of less than 20-ft loss, which is desired, and the overshoot of climb attitude, I think I kept my attitude of within $\pm 1/2^\circ$. Probably, for the most part, better than that. Occasionally I went about a half of a degree or more, but not much more, so certainly I met the 2° requirement there. Was the aggressiveness I used in getting the nose up, is that what you wanted to see? Okay. Okay then, for the longitudinal Cooper-Harper ratings: controllable? Yes. Adequate? Yes. Satisfactory? I'm going to say no, rate it a 4. The reason being that it takes a lot of work to hold that $17\ 1/2^\circ$. Obviously I met desired criteria. But it was a little bit—the high workload—to hold it there, and again, that's because I'm trying to I guess an attitude task in a flight-path commanded system. The other thing is, when I initially make my rotation, it appears to be a little bit unpredictable when I switch my scan from the velocity vector to the waterline indicator, the attitude indicator, and it appears as I'm putting in my input I get a little bit of an unpredictable or jerky response at first. I think that's part of the transition from going from gamma guidance to theta, kind of gamma input from my feedback, my visual feedback to a theta input, but it is a little bit of a squirrely rotation right at the rotation stop the sink rate. So a combination of that gives it a 4. Cooper-Harper for lateral direction: controllable? Yes. Adequate? Yes. Satisfactory? Yes. Last time I rated it 2. I'm going to rate it a 3 this time. It's borderline 2 to 3 I think, somewhere between compensation not being a factor and minimal compensation. It seemed to me I was having to concentrate a little more that time but it could just be some peculiarity for those particular runs. But basically, I think the lateral direction is borderline 2 to 3 on both the last two.

**Task 4090, Crosswind Approach and Landing,
[15 Knots]**

Pilot A. Okay, this was condition 4090, run number 52 was the last run. Longitudinal Cooper-Harper, crosswind tracking, glide-slope intercept: is it control-

lable? Yes. Adequate performance? Yes. Is it satisfactory without improvement? Yes, and I would give a 3 because of the fair amounts of splits in the commanded versus actual gamma symbol. Lateral-direction Cooper-Harper: is it controllable? Yes. Adequate? Yes. Satisfactory without improvement? Yes. It required ... I guess I would say I didn't see any big problems as long as your corrections are smooth and you start getting better with the stick over here. Once again the same comments apply to the heavy friction on the throttles. Give it a 2 in lateral directional. The final segment, precision landing from 400 ft down, I would give it ... longitudinally, I would say it's controllable. Seemed to get adequate performance. Satisfactory without improvement. Getting into the desired box. Personally, I would give it 3. The reason it would get a 3 is the ability to fine-tune the pitch. The forces and the high detent, high breakout, hurt that a little bit. Okay, lateral directional for the flare from 400 ft on down: is it controllable? Yes. Adequate performance attainable? Yes. Is it satisfactory without improvement? I guess I didn't see anything that was so objectionable that it had to be changed. I thought the rudder was reasonable. I give it a 2.

Pilot B. Run 52, task 4090, crosswind approach and landing at 15 knots. In glide-slope intercept it wasn't much of a problem. Deviation in terms of speed is not applicable with the autothrottle on; in terms of glide slope and localizer, as much as we've seen before, not really a problem at that point. I'll go ahead and rate it. Longitudinal HQR: is controllable, adequate performance is obtainable and satisfactory without improvement. I'd say an HQR of 2, pilot compensation not really a factor for desired performance. It goes where you point it.

Lateral directional: it's controllable, adequate performance obtainable and satisfactory, improvement not required, and again compensation not a factor, HQR of 2.

For longitudinal, there's a shears; it says "recover from shears on shorter approach and landing—short final and landing." Sensitivity of airplane [for] the gusts and shears, it is somewhat sensitive; you're correcting for it. The crosswind capability is there, but it's not particularly comfortable. I didn't notice a major tendency for APCs—slight tendency to bobble in pitch and roll. No pronounced tendency to float or bounce,

the problem is that it's tough to concentrate on that drift rate and the sink rate at the same time. I'm finding myself concentrating more on drift rate than sink rate, and so my sink rates have suffered as a result. In terms of performance, [for] bank angle, I'm able to get within the desired area fairly routinely; the landing zone desired, fairly routine, and deviation from landing airspeed is routinely in the desired rate; sink rate is routinely in the adequate category and essentially never in the desired. Deviation from runway heading is in the desired routinely. So longitudinal HQR: it's controllable, adequate; however, there's a problem in sink rate control associated with the workload in the task and predictability in the longitudinal axis. I want to say considerable pilot compensation for adequate performance and give it an HQR of 5, not real pleasant but doable.

Lateral directional: it's controllable, adequate, and sat. No; hang on a second. It's controllable and adequate, but the level of compensation for that lateral directional axis ... I'm going to assume that lateral means ... yeah, it does say lateral directional. You'd be hard pressed to call that any better than moderate compensation so I'm going to give it an HQR of 4 for the lat dir axis. That concludes the comments.

Pilot C. Okay, this is run number 23 and task number 4090, and are we rating both parts—the glide slope and stuff? Okay, and the glide-slope intercept and tracking down to 400 ft first. That part is relatively easier than the part of 400 ft on down. If you want to be very precise, it takes some considerable activity on the stick to null out the attitude where you want it. Is adequate performance obtainable with a tolerable workload? Yes. Is it satisfactory without improvement? No [with] minor but annoying deficiencies. Desired performance requires moderate pilot compensation, and that is ... the compensation that is required here is a considerable amount of stick activity to try and keep the flight-path command marker where you want it. Otherwise, if you just try to use small forces and fly the airplane, it tends to wander around your target a lot. If you're more aggressive and jab it, then you can keep things exactly where you want them. And that's ... I would say that is the same rating and comments for both pitch or roll. Inside of 400 ft the Cooper-Harper of 4 with minor but annoying deficiencies, desired performance requires moderate pilot compensation, that is, for the glide-slope intercept

down to 400 ft. And then for the 400 ft for the flare and landing, adequate performance obtainable with a tolerable pilot workload. Given no limitations of the displays and so on, I would say it is satisfactory, yes. And is it satisfactory without improvement? I would say no, very objectionable but tolerable deficiencies. Adequate performance requires extensive pilot compensation. I would say a 6, and that is some part due to the crosswind causing extra distraction, which makes it more difficult now to do the flare and round out consistently. The extra workload of decrabbing and keeping the centerline in a reasonable place is just enough to change it from typically a 5 yesterday now to a 6 for today.

Pilot D. Pilot D on the 6th of December. We just did a 15-knot crosswind landing, task number 4090. No shear, apparently, on that crosswind, which is maybe a little bit unrealistic. That would certainly make it more difficult if you had some shear in it. And with this wind the crosswind is really not too big of a factor. The flight-path display really makes it nice for this task except for the decrab, it's ... you don't even notice it. And the decrab with the heavy damping in yaw is fairly easy to do. The display is not too bad for the decrab. It does require you to split your scan between the waterline symbol and the flight-path symbol, which tends to increase the workload a little bit. And apparently just enough. It's making my longitudinal touchdown performance marginal. I think we got one inadequate. Pilot ratings for approach: let's make it 4. We need to fix the balloon flap extension, as before. Lateral: let's make it a 4. The stick forces are just a little bit high. Landing, longitudinal: I have got to give it a 7 because of performance. Otherwise it's up around a fourish. And laterally: it's a 4. And primarily because I've got to split my scan between the waterline symbol and the flight-path symbol.

Pilot E. Okay, this is 4090, the crosswind approach and landing. A lot of things to talk about on this one. The up and away, it's a hands-off task. The $\dot{\gamma}/V$ control law just holds it right on track throughout the deceleration when you change airspeed. It's essentially more or less in a track hold type mode ... I would call ... without any inputs. It's pretty much going to compensate for the crab angle and just hold you right on localizer, so it's up and away, it's noneffort. Pushing over for the glide slope, not difficult tracking the glide slope in the moderate turbulence. A little more work than without turbulence, but not too difficult

when we get down to 400 ft. At any rate, up and away, I don't see any problems at all, and the ratings are going to reflect that. For longitudinal Cooper-Harper, up and away, this is for the glide-slope intercept down to 400 ft: controllable? Yes. Adequate? Yes. Satisfactory without improvement, and let's see ... approach airspeed ... we got that. Glide slope and localizer, I did very well on, so there's no problem there. So I'm going to rate that as Cooper-Harper of—for longitudinal: Cooper-Harper of 3. Similarly for lateral: controllable? Yes. Adequate? Yes. Satisfactory? Yes, also a 3. It's not really a ... pilot compensation is required, and so it gives it a 3. Now, from 400 ft on down, the autoflaps are, I think, right now my biggest complaint about the whole configuration and the problems I'm having are ... it's a big balloon effect, but depending on the interaction with the turbulence and how you correct for it, it gives you a nonpredictable response down at around about 50 to 100 ft. So I'm getting right down to the most critical portion of the landing, which is setting the flare attitude. I'm unable to get a consistent height crossing the ramp or threshold crossing height. Therefore, I'm having to actively work the pitch axis to try and make a spot landing, and that results in less than optimal H-dots. Especially if there's anything else that is distracting my attention. If I have to do anything else like correct for a crosswind decrab, lateral offset—anything that takes me out of the pitch axis—that doesn't allow me to give all of my attention to solving the inconsistent threshold crossing height problem, and it does reflect in either X dispersion or H-dot dispersion. So the autoflaps in themselves are almost equivalent to a lateral offset or a large vertical offset in that it's a big distraction and it requires you to be very tightly in the loop. I've tried to anticipate the autoflap onset by intentionally flying slightly below glide slope. That has not worked. There seems to be two definite points where you get big inputs. You get a big input between ... around 300 ft where it really tends to want to climb, and I can, I have been able to successfully solve that. I anticipate that and I'm very aggressive and have been able to keep myself, when I've tried hard, pretty close on glide slope. Then I get down to ... and one of the things you notice when you look at your tapes, or whatever ... you'll see the difference between commanded gamma and actual gamma, and there's a pretty good delta in there, as I am actively forcing the nose down and trying to keep this thing on glide slope. But the thing that really gets you the most ... right at about 100 ft when

you're coming off of autothrottle so you have a little bit of a cognizant shift there where you have to find that little autothrottle handle and pop it off—at that exact moment you tend to get a—what is the word I'm looking for—you tend to ride, to climb on the glide slope, you get a little bobble there and it ... it really tends to climb you. And depending on what you're doing at the time, being able to anticipate and correct for that final autoflap transition ... there's a difference between being maybe 15 or 20 ft higher on glide slope than you want to be. Now, when I have to solve that at the same time as decrab or something else, then my longitudinal control seems to become degraded. So anything that takes me away from tightly working that longitudinal control ... and I earlier have spoken of a coupling between the lateral task and the pitch task, and I think what's happening is when I'm not able to fully concentrate on where my velocity vector is longitudinally, by having to make some kind of line-up correction from an offset whatever, I then tend to lose control of my glide slope, and there's really no telling from run to run where I'm going to end up being. So with all of those comments there, I will now go ahead and attempt to rate the precision landing. Longitudinally: controllable? Yes. Adequate? Yes. Satisfactory? No. I think in the sum total of things, I probably ended up with an adequate performance on this. And based either on exposition and/or H-dot, I would probably rate this a Cooper-Harper of, let's see ... adequate for H-dot is 6. I'm going to rate this a 6 and the problem being is that so much is happening right there between 50 and 100 ft that makes or breaks your H-dot and your flare attitude. Also, with the delta between the commanded gamma and the actual gamma and I have yet to really solve that one ... it doesn't seem to be consistent to me, in that where I command the gamma and where my actual gamma ends up and I think it depends on what kind of large correction I have to make at about 50 ft or maybe 40 ft, to correct for the high I get from the autoflaps or whatever. I'm usually in the midst of having made a very aggressive correction for that point in the glide slope, and now I'm having to compensate for that, and it's difficult. I don't want to float and I don't want to overcontrol it, so I'm tending to be a little bit less aggressive with my final flare attitude. And therefore, I'm allowing ... even though I'm on the horizon with commanded gamma, my actual gamma is typically about a degree or so behind, and that's why I'm getting the higher H-dots. So at any rate, that will come in 6 on longitudinal. For

lateral directional, this is with the crosswind and the desired here. Let's see: I want to be less than 5° angle of bank. I want to be ... my deviations, let's see ... runway headings less than 2, and ... okay, at any rate there is a comment here I need to make. There's three things you're trying to control here. You're trying to control your Y position, you're trying to control your landing phi and your landing heading. I mentioned to Dave earlier now on this tape, those three to me seem difficult to accomplish simultaneously. If I try to maintain myself right on centerline I have to, if I fly centerline approach, put in some angle of bank into the wind as I decrab. And I don't want to exceed 5° because there is the danger I guess above 7° of a wing scrap. So I'm very cognizant of that. However, I am ... if I try to get my crab out completely to get my landing heading less than 2°, I am going to have to put in excessive angle of bank above 5°. Now the option is to let yourself drift downwind and either fly it slightly upwind and land at a drift but with your heading aligned down the runway and your phi less than five, but I don't think that's a real good way to do it either. So there are lateral problems here that you can't do everything at once. A comment before I rate it laterally, there's a lot going on between 100 ft and touchdown, and there's really too much going on I think, for I think we need to work on making the airplane a little bit less of a workload from 100 ft on down. And I think the autoflap thing would really make it a lot easier if you could consistently have a consistent threshold crossing height, and that is the coupling and everything else, because when you end up having to decrab and trying to set up that position, then my longitudinal performance goes down. But at any rate, lateral direction, I think I'm going to rate that: controllable? Yes. Adequate? Yes. I pretty much met the desired criteria for Y position and heading and phi, generally. However, I think I'm going to rate it as a, say it's not satisfactory without improvement. I'm going to rate it as a 4. And to me the limitations are just very, very low bank angle restriction in the crosswinds, I think, is going to result in lateral accelerations and landing gear if you can't slip the airplane. Now, if we build the gear such that we can have this land in a crab, that is a course that we probably need to go. At any rate, a lot of comments, but I think that approach right there really shows up a lot of subtleties about this configuration.

Task 4095, Crosswind Approach and Landing, 35 Knots

Pilot A. This is task 4095, 35-knot crosswind approach and landing, A is the pilot. Okay, this is run 58. Is it controllable? No. Let's see ... let's take a look at the ... let's look at the ... break it down first. Longitudinal, Cooper-Harper on the glide-slope intercept: is it controllable? Yes. Adequate performance? Yes. Satisfactory without improvement? I'd say yes, but I'll give it a 3 because of the ... primarily because of the pitch of the scan required to the far left-hand corner, far upper right-hand corner of the display to capture glide slope. Once you're on the glide slope, it's reasonably easy to maintain it. The lateral-directional Cooper-Harper, I would have to ... down to 400 ft, I would give it a 2. There's no real problem controlling, staying on the glide, the localizer. In the precision landing, 400 ft on down, the nosewheel touchdown: is it controllable? No. I'll give it a 10. And lateral directional: is it controllable? I'll give it a 10.

Pilot B. Run 55, task 4095, crosswind approach and landing at 35 knots. In summary, I think you've gone beyond a reasonable capability of the airplane at 35 knots. The workload is tremendous and it does feel true to all three axes. If I try to do the task as written—that is to decrab completely prior to touchdown—I am rate limiting routinely; I am routinely exceeding the bank angle limits on the airplane. So we're starting to damage parts of the airplane if we were doing this for real. As far as the approach segment, it's pretty much like a normal approach segment. The only difference is the requirement to scan across the majority of the width of the display to find the glide-slope raw data, and I think you could compensate for that with just some simple error indications or a pathway around the velocity vector. So for the glide-slope intercept, let's see ... the task is to rapidly maneuver on final approach and a change in trim flight path before the middle marker and I think we did that, with no more than half a dot deviation in glide slope or localizer. So, longitudinal: it's controllable, adequate, and sat. And pilot compensations, let's see—in the turbulence again I wish I had .5's here—I'm going to give it a 3, minimal compensation required for longitudinal.

For lateral directional: controllable, adequate, and satisfactory, and compensation not really a factor; give

it a 2. Longitudinally I'm just hunting around a little bit for the right attitude still, but no major problems there. Okay, for the precision landing segment, 400 ft down, the task is to recover from shears on short final and landing, evaluate sensitivity of the airplane and crosswind capability, no tendency for APCs or bobble in pitch or roll. Let's see ... as far as performance standards, maximum bank angle below 50 ft, desired is 5°, adequate is 7. I'm routinely up into the adequate range and occasionally over the adequate range. Landing airspeed is okay—within 5 knots of desired. Touchdown sink rate, again you're so concerned with the drift that you're not controlling the sink rate appreciably, so I'm routinely outside of the adequate range there, and deviation from runway heading. I tried two techniques. The first technique is to do the task as written and completely decrab prior to touchdown. When you do that, intense control is required, or intense compensation is required, to maintain control. If you cheat, that is if you don't take out all the crab and accept a little bit of drift rate at touchdown—keeping in mind that the drift rate is not measured in anything that we're recording on the scorecard so there really is no penalty from that from a pilot's standpoint—there might be from the airplane standpoint—but if you do that, the task becomes controllable, but adequate performance is just not there; you're not able to get adequate performance despite maximum workload and compensation attempts.

Okay, so longitudinal: let me give you a segmented rating here because the rating will vary depending on my assumptions about what I can tolerate on drift rate. The first one will be if I do the task as written—that is, I'm trying to control the heading at touchdown and minimize the drift rate buildup, so I'm trying to decrab as late as I can and as much as I can. When I do that, it's controllable, adequate performance is not obtainable, and I'd say intense pilot compensation is required to retain control, and I'd give it an HQR of 9. I was fairly routinely getting into the rate and position limits on all three axes on that. When I modified the task to accept a heading deviation at touchdown, so I'll accept an adequate performance there in order to prevent inadequate performance as far as wingtip clearance is concerned, I was able to get the wingtip clearance that I wanted at the expense of the heading deviation that was inadequate. So again, I'd say adequate; it's controllable but adequate performance is not obtainable, and I'd give it an HQR of 7. Adequate performance not obtainable at maximum

tolerable pilot compensation, but controllability is not in question, and that's for longitudinal and lateral directional. And the longitudinal was for sink rate, although in all fairness, I'm not largely controlling sink rate at that point because I'm so concerned with drift. And the lateral directional is for heading control. That ends the comments.

I'm going to modify a comment for 55 and that is the longitudinal HQR for the precision landing phase, and that's with the task clear, in I'd tried to control the heading at touchdown all the way. In this case, adequate performance for the longitudinal task was not obtainable. I had problems with H-dot, and with the landing box for that matter, but controllability was not in question for the longitudinal axis so I'm going to give that an HQR of 7, longitudinal. I'd give it a 9, lateral directional. So 7, longitudinal. Adequate performance was not obtainable, but controllability was not in question in the longitudinal axis. That ends the modified comments.

Pilot C. Okay, run 28, 11-30-95, C is the pilot, task 4095, crosswind approaching landing at 35 knots. Is it controllable? Yes. Is adequate performance obtainable with a tolerable workload? Kind of. By the definition of our adequate performance there, I would have to say no. Major deficiencies: adequate performance not obtainable with maximum tolerable pilot compensation. Controllability is not in question. I would give it a Cooper-Harper of 7, no matter what I did on all the approaches, always some parameter escaped being adequate. Sometimes it's H-dot, sometimes it's long or short, or whatever, no matter what I did, for as many runs as I could do. I did feel some better when we had motion base on than with motion base off. The cues seemed better and made much more positive control, and it did feel significantly better in the flare with those. So these comments were for the 400 ft down to touchdown and rollout. The comments for the inbound glide-slope interceptor are essentially the same as before. I would say, minor but annoying deficiencies. Desired performance requires moderate pilot compensation for no big change, whether it was 35 knots or 15 knots or whatever.

Pilot D. Pilot D on December [6], and run 36. I ended up, task 4095. I have a feeling that this is for the 35-knot crosswind, which I have a feeling is near the limit. We got control limiting laterally one time. The rudder forces are very high. Also, we have a display

problem which is not too bad, but as far as the display goes, with the high crab angle there's a large scan problem between the waterline symbol and the flight-path symbol. To reduce that I was bringing in some sideslip at a fairly high altitude just to get everything on the same part of the display. I was actually starting a partial decrab at 1000 ft, with the remaining decrab hopefully full and 100 ft, which I didn't make a couple of times. One time I felt it was because of the roll control limiting I got into, and I backed off on the control, and I probably let the heading go. The last one, run 36, I was a little surprised to see we had on the order of 5° of heading off. Still, it was a pretty acceptable landing. And again, the lateral-directional task is just increasing the workload enough that I'm having a hard time concentrating on the longitudinal task, and I got a couple short landings. Actually, longitudinal is not too bad, but it's going to get downrated because of the performance. Okay, pilot ratings, longitudinal approach: we can make that a 4, and really the display is nice here. If it weren't for the fact that [there's a] huge crab angle, you hardly even notice you had a crosswind. Laterally, in the approach, I'm going to give it a ... well laterally it's ... well shoot. I think I need to make both of these 5, because it's a display problem. Let's make both of these 5. The control part is not problem, but it's the large scan pattern between the flight path and the waterline symbol, and so I would say that is definitely moderately objectionable deficiency. I'm not sure what to do about it. But it did increase the workload, but does it make it a 5? Let's make it a 4, both of them a 4 still. Talk about oscillations here: put it a 4—no a 4 redo. Okay. And on the landing, it looks like I have to give it a 7 longitudinally, because I think I landed too short one time. Our sink rates are all reasonable. I think, you know, longitudinal from a handling qualities standpoint, it's more like a 4. Okay, laterally, we're getting just up near the limits on this, and with the control limiting that I got there once, I would say that it's almost a 7, but is it a 7 though? Well, I guess I got some inadequate performances, which are going to make me give it a 7 anyway. So let's give it a 7 for performance. Actually the display and the handling and everything isn't that bad except for that control limiting. Let's just leave that at a 7 for both performance and the limiting of the control system there.

Pilot E. Okay, crosswind approach and landing, task [4095], 35-knot crosswind. A lot of my comments still remain that I gave in the 15-knot crosswind case. The

problem here is, I think this task would take a little bit of technique refinement and then you would probably need to have this as a taught task in a simulator before the pilots went out on the line, if you were going to try and fly this thing at this high of crosswind. The main thing is, there's so much going on, as I elaborated before, it's difficult to do everything down there between 100 ft and the ground. It's just an awful lot of workload at that point. It looks like, generally, I met desired criteria for X position. That was ... that was probably okay. The Y position was kind of a give-me. I thought that was worse than that, and it was hard to get that Y position. And overall H-dot was adequate, and I think probably that's about the best I could do on that. So for the glide-slope intercept segment though, however, above 400 ft, again, it's almost a no-brainer. The control law is very good in that particular part of the task. So—controllable? Yes. Adequate? Yes. Satisfactory? Yes. This is for the longitudinal Cooper-Harper. I would rate that a 3. Again, it's control law, the setup is very nice, and the crosswinds really don't affect the longitudinal task above 400 ft. Similarly for lateral directional, they were always desired; also controllable? Yes. Adequate? Yes. Satisfactory? Yes, for a 3 also. Below 400 ft, it gets a little bit harder. Longitudinally, again, just to kind of just add a little bit more emphasis to all the comments I made on the previous task. Controllable? Yes. Adequate? Yes. Satisfactory without improvement? No. I think I would also rate this one probably a 6. I'll tell you what, I'm going to rate this a 5. I think I may have rated it 6 before, but it's kind of borderline 5 to 6, and actually there's such an overall demanding lateral task. It kind of masks the effort in the longitudinal task. Lateral directionally: controllable? Yes. Adequate? Yes. Satisfactory? No. Even though on this one I met all the desired criteria, on this last one, the workload is so high and it's such a difficult task, I really can't rate it in the desired criteria, so I'm going to rate this, not satisfactory without improvement and I'm going to rate this, well, I'm going to rate this a 6. It's kind of borderline 5 to 6 in my opinion. And the problem again is the ... well, it's just a hard task. There's just a lot going on, and there's that I had difficult ability getting a good slip established. Again, I think with practice I could do a much better job, but obviously if we practiced a lot then we really wouldn't be giving good ratings on the stuff, so I think this is a task that would need to be developed and explored and a technique developed to properly do this.

Task 4100, Category IIIa Minimums Landing

Pilot A. Okay December 12th, this is task 4100, Cat IIIa minimums landing, the pilot is A. Okay, on that last one, run number is 13. The Cooper-Harper rating, longitudinally, glide slope, 1500 ft down to 400 ft, including the glide-slope intercept and localizer tracking: is it controllable? Yes. Adequate performance attainable? Yes. Satisfactory without improvement? Yes. Improvement not required. That's Level I. I would ... I guess if I'm rating the control law and the displays altogether, I would have to give it like a 2 because of the large scan required going from the flight-path vector, down to ... up to the glide slope. Lack of a 3° line on the reference, lack of the runway icon to work with, and guidance ... that's a lot could be improved in terms of the guidance, to improve your performance more along the lines of flight directing type information, situation awareness, tunnel of the sky, and so forth would help. Lateral-directional Cooper-Harper: this is basically a straight-in approach and very minimal, just only small corrections were required. I would give: is it controllable? Yes. Adequate performance? Yes. Satisfactory without improvement? Yes. I'll give it a 2, and I wouldn't give it a 1 because ... I could give it a 1 if it had better, just for instance, localizer or track hold features, perhaps, and better displays, so it's situation awareness of where you're going and there's a large scan pattern; from your flight-path vector way up to the localizer, the glide ... I mean the bank angle ... down to the localizer is quite a large scan area there, compared to just a head-down display. So I'll give it a 2. Down in the 400 ft down, the nosewheel touchdown, the longitudinal Cooper-Harper rating: is it controllable? Yes. Adequate performance? Yes. Well, yes. Satisfactory without improvement? Yes. I would give it a ... well let's see ... let me just backtrack a little bit ... the ... I think, in terms of the glide-slope tracking, the glide slope right down to touchdown is quite difficult because it seems to go high. Typically you start out high with the configuration change and then for some reason, late in, and then still some configuration changes still happening, but somewhere around 100 to 200 ft you start going high on the glide slope, and you have yet to push the flight-path vector down to 4° to stay on the glide slope, so you end up going high. For that reason I guess I would give it a 4, because it really ought to have some, I think, guidance and improvements there or have configuration changes made with-

out any perceptible changing gamma. So I'll give it a 4. Cooper-Harper in lateral directional: this is very ... just a straight-in, with small corrections. There were no major problems. Is it controllable? Yes. Adequate performance? Yes, well actually not, occasionally no. So I would say adequate performance: no. And major deficiencies: well I ended off the runway. We would have to say, well, it's going to be between a 6 and a 7. I guess with extensive pilot compensation I'd probably stay ... get on the runway. I'll give it a 6, lateral directionally, and the reason I did is because of the guidance down close to the runway. There's no expanded localizer. The localizer is hidden behind a bunch ... the localizer deviation is not expanded and it's very difficult to see, and if you concentrate very hard, you can pick it out of the clutter but it detracts from the rest of your performance, so it mostly displays things [that have] nothing to do with the controls itself, typically the displays that are available to the pilot.

Pilot B. Run 58, task 4100, Cat IIIa minimums landing. For the glide-slope intercept portion, it's much the same that I've seen before. Deviation and light turbulence, plus or minus a half a dot, is relatively easy ... very small tendency to hunt for pitch, but nothing unusual. It's controllable, adequate, and sat, and longitudinal ... again I wish I had 2.5 available ... I'll give it a 2, pilot compensation not really a factor for desired performance. And lateral directional: it's controllable, adequate, and sat, and again, pilot compensation not a factor for desired performance. I'd give it an HQR of 2 also.

For the precision landing phase, the basis is handling qualities of landing, no tendency for PIO or bobble in pitch or roll, no tendency to float or bounce, and that's for 400 ft on down. As far as performance, bank angle below 50, I was able to get desired deviation from landing airspeed, desired ... sink rate between desired and adequate, typically, and deviation from heading, desired, typically.

Longitudinal is controllable, adequate, and sat, and just in the absence of cues, I'm working a little bit more than in VFR. Just say minimal pilot compensation required for desired performance, and give it an HQR of 3.

For lateral directional, again I'm hunting for the line-up and part of this is display problem that we talked about. Doing this task without a flight director is probably not representative, and trying to scan the

localizer error while you're controlling the sink rate, leads to a little bit loss of scan. That's where the compensation is. It's controllable, adequate, and sat, but I'm going to say minimal pilot compensation required for desired performance and give it an HQR of 3. That concludes the comments.

Pilot C. Task 4100, Cat IIIa minimums, and C is the pilot, and just going to the Cooper-Harper rating here. Is it controllable? Yes. Is adequate performance obtainable with a tolerable pilot workload? Yes. Is satisfactory without improvement? No. I would say, I think that the airplane is about a 5 for this task. Moderately objectionable deficiencies: adequate performance requires considerable pilot compensation. Just try the next one here. Very objectionable but tolerable deficiencies, adequate performance requires extensive pilot compensation. That's probably more like a 6, I think ... very objectionable but tolerable deficiencies. That's just ... once the runway becomes in view, it's too difficult to get a good touchdown at the desired place. Just too much workload and quite a bit of anxiety. I can reduce the anxiety a bit by letting it float longer, but if I try to put it on the spot, then it makes me rather nervous and my performance decreases and we end up with banks after and liftoffs after we have initially touched down. If I relax it a little bit and let myself go along, then I feel a lot more confident, so I think 6 is really the right place for it. And that's in both; longitudinal: it seems like I talked about longitudinal most, but bank is a little bit of a difficulty because you can't make very much bank when you're close to the ground, and if you're not perfectly lined up, you want to make enough bank to fall into the adequate performance area or perhaps even beyond. So I think it's fair to call them both a 6 at this point. Those previous comments are for the touchdown and the final segment there. The earlier segment on the localizing glide slope—that's a much different story. Is adequate performance obtainable with tolerable pilot workload? Yes. Is it satisfactory without improvement? I would say yes. There are some mildly unpleasant deficiencies. Minimal pilot compensation required for desired performance. I would say a 3 in both axes.

I want to add to my last comments, there on run 61, the difficulty I had on the final segment about being able to control my heading real well. The bank

index is so far away from the center of concentration thing, that you can't do very well at that, so there is a tendency when you get close to the runway to start wanting to wander back and forth and chase the heading. The heading line is now high enough above the flight-path command marker that you can't have a good reference there, and then it turns out that it is just unfortunate. The localizer bar is sitting right over the heading indicators on that heading line. It makes it very difficult to discern what's happening, to sort out what you are looking at.

Pilot D. Pilot D, December [6], task 4100, ended up on run 38, Cat IIIa, with no flight director and with the size of the vehicle, essentially no vision until you start to derotate. You can see barely just a little bit but nothing that really helps, so I think the task needs to be redefined. In real life you have to have at least a flight director to get down to 100 ft, much less down to, essentially, 0 ft here. So we're essentially landing on raw data, which of course becomes very, very active down close to the runway. The only thing, the flare cue does help in the flare of course. Laterally, I'm just ... during the flare I'm just strictly open-loop ... just hope the thing goes in the right direction. And it looks like on the last run we'd been okay, but it was just pure luck, because I'm concentrating on the flare cue so much. We can certainly rate the approach part of it. I'll just give it 4; 4's for longitudinal, lateral there as before. Really the display is pretty good. The depressed pitch line would help at 3°, and of course a flight director would help. But not too bad. Landing: I'm not sure how to rate it. Let me get the scale out here and do something. I have a feeling that, you know, my longitudinal ... if I made 100 of these, my longitudinal touchdown dispersions wouldn't be too good. I think I just lucked out on the one. I think it's major deficiencies 7; 7. You know, we need a display for the task here.

Pilot D again on December [6]. I would like to reconsider my ratings on this task 4100. I should have gone through this left-hand side of the scale a little more. I tend to jump into it. Pilot decisions. Is it controllable? Yes it is controllable, but improvement is mandatory on the system ... major deficiencies because of the display, not actually of the control. Let's give it a 10 both longitudinally and laterally for the landing task.

Pilot D, December 6, Cat IIIa with the flight director this time, 4100, we ended up on run 67. The last two runs, I was following the flight director very closely. I was flying [unintelligible], so the performance on those last two runs was quite repeatable and I think representative of what we could do. This is a much more reasonable task, although you know, again, you got ... we essentially got a single thread system here taking us down to runway, which you wouldn't, you would have to have some kind of backup, which Cat IIIa gives you, of course, the scene to confirm that you are landing on the runway. I'm really not getting that here. Essentially I'm landing blind. Okay, the only really problems I solved on the flight director is that I have a tendency to S-turn, on the flight director, all the way down and right through into the landing. I think a little bit of bank compensation or feedback could help me there. And in the only other place I'm having a little bit of a problem is H-dot resolutions in the final touchdown. I have to guess a little bit, although it seems to be working out good, but I could use a little bit of help, either on the director or something there, to make sure that I really got the right final sink rate coming into the touchdown there. Pilot ratings. Let me find my scale here. Longitudinal, we were getting pretty close to ... I guess we got to give it adequate performance because my sink rates still aren't right on, but again I think that goes along a little bit with my comments. So I'm going to give it a 5 for performance, but for handling qualities I think it's definitely a 4. So let's make it 5, performance; 4, handling qualities. I don't know if you guys like this or not, but you're getting it anyway. Laterally ... come back here ... doing great on performance, but I'm having the biggest problem there, from a handling qualities point and that's that S-turn, but it's really not too, too serious. Moderately objectionable, minor ... I'm going to give it a 5. Kind of a 4 and a half really, but you guys don't like halves, huh? Is that right? Okay, that's [unintelligible]. That's on the, I'm getting my numbers mixed up here ... let's see ... approach, yeah, okay. Yeah, I'm getting mixed up here ... that's on the approach, and let's see ... what did I do on the approach? Longitudinally, why did I give it a 5 for performance? Okay. That should be a 4. That was my landing rating. Okay, so it's a 4 for approach longitudinal, and it's a 5 for approach lateral. Okay, now let's go to landing and give it a 5 on performance and a 4 on handling qualities, and give it a 5 on lateral landing because of the S-turn again. Okay, signing off.

Pilot E. Okay, this is the rating for task 4100, the Category IIIa minimums landing. It's an interesting task. Obviously there's vertical guidance or longitudinal axis, but there's clear cues and the like. The glide-slope indicator does provide ... since you do have the velocity vector showing your actual gamma ... does provide very, very adequate guidance to glide path. Lateral guidance is lacking in that the instrumentation that we have on the HUD will show you a deviation from localizer, but it won't really show you how you are corrected. So the problem is ... and this is true on the up and away as well as in close ... to correct for lateral deviations you have to look at the heading. You can't do little mental exercises to how much of a correction you need to put in to correct the deviation. There's no ... the velocity vector does not give you a compelling enough indication of how you are correcting. And I wasn't able to use the actual heading tape because it's graduating in 10° increments. It wasn't enough of a cue, so the lateral task is hard. When you get in close and you start having to overcome for the autoflap burble there at the end, and you're working the longitudinal axis very, very demandingly, the lateral axis is easy to let get out of hand, as evidenced my second approach. If you can pick up the runway and make the correct judgments to where you are on the runway, then it becomes a little easier on the lateral task and you can stay closed-loop on it. On the second task, I picked up the runway, but I picked up the edge and thought I was on one part and corrected incorrectly and actually landed off the runway. So obviously there are some interesting things about this task. As far as glide-slope intercept, I met desired criteria down to 400 ft, both laterally and longitudinally. The longitudinal rating: controllable? Yes. Adequate? Yes. Satisfactory without improvement? I would say yes and rate it a 3. For lateral-directional Cooper-Harper: it is controllable, adequate. Performance attainable with tolerable workload? Yes. Satisfactory without improvement? No. Even though I met the desired criteria I would say it was really borderline desired, adequate for the workload required. I'm going to rate it a 4, with the comment that tracking the localizer in light turbulence is a high workload task because of the lack of good enough guidance cues. From 400 ft on down it becomes a little bit different task. The longitudinal: we will rate that first. It's interesting: the flare cue does provide you with enough information to make decent landings I think. The two ... the one, the second approach, as I was off the runway, I kind of started

looking at the runway and pretty much quit working as hard at that point since I was off in the weeds and did not really pay attention to my flare. So I'll throw at that 6 ft/sec H-dot there and look more at the two approaches a little, a little more gradeable. In that case you do get pretty good cues from making a good flare. I think it was controllable. Adequate performance was attainable. Satisfactory without improvement? No. Several things, again the autoflap situation really makes you mess up your glide slope in close. And again, in an instrument approach, the last thing you want to do is have a very unstabilized glide slope that close to the ground. And it's just, I have yet to figure out how to anticipate or how to totally counteract this autoflap implementation. It does not seem to me to be consistent from time to time depending on a variety of factors. So my glide slope definitely gets a little bit less than optimized from 400 ft on down. At any rate, controllable? Yes. Adequate? Yes. Satisfactory? No. I will rate it a 4. I will rate it a 4 because of my performance; certainly there's a lot of pitfalls in there that could really mess you up and be either too long or harder or firmer landings. For laterally directional: controllable? Yes. Adequate? Again, I guess the question here is, we're trying to look past the task as far as the proper guidance and look more towards the airframe type of response. Okay, so I'll say adequate performance attainable? Yes. Is it satisfactory without improvement? No. This is difficult. It's difficult to separate the task at this point from the tools you have to complete the task. And this is going to be a very difficult rating to give. The lack of cues for your lateral guidance is enough to make this a very, very difficult task, but yet the airplane responds in the lateral axis well enough with the proper tools to do a nice job, so I'm going to ... torn here between trying not to let the actual displays drive my ratings as opposed to the performance of the vehicle. I think I'm going to stop recording for a second. Okay, I took time out to discuss with Dave about how to rate this. The rating is going to reflect the overall system, in his opinion, and that would include the displays, so I'm going to rate it a 6. And I would say that there's a good possibility that this could end up being a much lower rating, the saving grace is you do pick up some runway cues at about 50 ft and it allows you to correct your heading so you don't drift off the runway. So that is about the only thing that saves you, so I will rate this a 6 and make a comment that the task has some problems with it.

Task 4110, Approach and Landing With Jammed Control

Pilot A. This is task 4110, approach and landing with jammed control. Okay, the last run number was 15. Longitudinal Cooper-Harper from 1500 ft down to 400 ft: Controllable? Well, yes. Adequate performance? Yes. Adequate without improvement? Yes. Improvement not required. Oh gee, I would have to give it a 1. Okay, the lateral directional: is it controllable? Yes. Adequate performance? Yes. Satisfactory without improvement? Yes. I'll give it probably a 2, based on previous comments, tracking and down to the last 400 ft down to touchdown. Nosewheel touchdown: was it controllable? Yes. Adequate performance? Yes. Satisfactory without improvement? Yes. Improvement not needed, actually I did better with this one than I did with any of the other ones. I'll give it a 1. No problem. As a matter of fact, as far as tuning to pilot response, it seemed to be improved. Of course, I wasn't making large inputs but where you might get into trouble, but it seemed to be the card for the task. Lateral-directional Cooper-Harper: no problem there, I give it a 1.

Pilot B. Run 60, task 4110, approach and landing with jammed control. Glide-slope intercept phase was very much as before; I didn't notice any difference due to the control authority. The inputs felt consistent, much what I've seen. Deviation within half a dot, fairly easy to get. Longitudinal: controllable, adequate, and sat, negligible deficiencies. Pilot compensation largely not a factor. I'd give it an HQR of 2.

Lateral directional: it's controllable, adequate, and sat, and again pilot compensation not really a factor for desired performance; HQR of 2.

For the precision landing phase, 400 ft and below, I was able to get adequate to desired performance in all the parameters, bank angle deviation from landing airspeed, max touchdown sink rate, and deviation from runway heading without too much of a problem. Longitudinal was a bit more difficult than lateral directional, and I was able to concentrate on longitudinal but was hunting a little bit for the correct pitch attitude. The flare cue, now that I'm using it a bit more, is useful and helps out a bit. It's just phasing the power reduction in with the pitch attitude increase; that's the compensation required. So longitudinal is controllable, adequate, and sat, this time with mildly

unpleasant deficiencies caused by minimal pilot compensation. Call it an HQR of 3. For lateral directional: it's controllable, adequate, and sat, the pilot compensation largely not a factor for desired performance; HQR 2. That concludes the comments.

Pilot C. This is run 71, task number 4110, C is the pilot. Is it controllable? Yes. This is talking about the first segment. Adequate performance is obtainable. Satisfactory without improvement. Cooper-Harper of 3. Mildly unpleasant deficiencies when you're outbound on the way in, and mostly that's related to the familiar complaints I've had about how the stick feels. There's a large breakout first, and then you have to push through that, and then the command marker moves ... the bank moves more than you intended, perhaps. You tend to chase around it, so it leads to bang-bang controlling. But the overall control of the parameters is very good. So Cooper-Harper of 3 for both longitudinal and lateral directional. For the approach and landing phase below 100 ft: is it controllable? Yes. Is adequate performance obtainable with tolerable pilot workload? Yes. Is it satisfactory without improvement? Let's see ... were we long that time? I didn't realize we were quite that long? Nice touchdown. It was actually the nicest landing that I've made I think, from a pilot satisfaction standpoint. I can give it a Cooper-Harper of 5 [with] moderately objectionable deficiencies ... adequate performance requires considerable pilot compensation: in general, the workload and the difficulty of getting the touchdown H-dot right and in the box. Quite a bit of workload in stick activity to get that job done.

Pilot D. Pilot D, December 12. Just finished 4110, which is the landing with the jammed stabilizer. We ended up on run 40. Looks like we picked a condition where the stabilizer is right, almost centered for the approach condition. And it's really no big problem. We didn't get in any trouble anywhere. You can notice that the longitudinal control is not as tight, and this is most noticeable at the flap deploy. There seems to be larger excursions on the actual flight path. And in particular ... well both my landings I made, one of them I had gotten a little bit slow and long, and you could definitely see the flight path deviating, and apparently we had a saturated elevator. The other one, the elevator didn't saturate and I wasn't quite so slow, but I could still see a deviation in the actual flight path just before touchdown. Pilot ratings. Let's give the approach the good ol' 4—4. What do we do on this

thing here? Let's see, longitudinal: you could probably work around these deficiencies for emergency conditions, it's really pretty good. Let me go up this thing so I don't get in trouble again. Is it adequate, controllable? Is adequate performance obtainable with a tolerable workload? Yes. Is it satisfactory without improvement? And no, for normal operations; I think it's acceptable for emergency operations, which makes it Level II. And we were just on the limit. Let's make it a 5 [with] moderately objectionable deficiencies. And lateral: no problem. What the heck have I been giving it? Stand by for a second. Yeah, I think my good ol' 4 and nothing different on the lateral there. Okay.

Pilot E. Okay doke, this was 4110, approach and landing with jammed control. Basically the only things I noticed were subtle, up and away. Obviously it was hands-off all the way to glide-slope intercept, with the gamma-V control law taking care of holding the altitude on the track. Glide-slope intercept: nothing I noticed. It was a typical type intercept. Fairly mild pushover and tracking the glide slope very tightly was not that difficult and the autoland, autoflap rather—as it came in, I did notice a slight tendency for a little pitch PIO. Before I just noticed the kind of the ballooning effect, but today I noticed in trying to counteract that I did get a little bit of a slight pitch PIO, and the other difference I noticed was on touchdown, when I went to derotate, I did not have ... the nose was coming down, and normally I fly the nose down. In this case the nose was coming down, I was trying to keep it from keeping down at ... keep it coming down at a moderate rate, so I did notice the lack of pitch authority on derotation more than anyplace else. All the criteria—I think even the touchdown—I noticed I did when I PIO'd a little bit in the final stages of autoflaps, I got myself a little bit high, and so I was working off that very slight high in the attempt to make the box. I had to let the nose just settle a little bit and that's what caused the 3.4 H-dot, but I didn't really notice anything much different in the controllability of the aircraft. Okay, so for up and away, longitudinal Cooper-Harper: controllable? Yes. Adequate? Yes. Satisfactory without improvement? Yes. I would say Cooper-Harper of 3. Lateral directional: similar, controllable? Yes. Adequate? Yes. Satisfactory without improvement? Yes—a 3 also. Obviously no lateral problems there since none were implemented. From 400 ft on down, longitudinal: controllable? Yes. Adequate? Yes. Satisfactory without improvement? No.

The slight PIO, I think, would be something that could be considered cause for concern. And the lack of nose authority on derotation ... I thought it was a little bit; it definitely needs to be fixed. I would rate it a 4 based on my perception that you can't pretty much make borderline desired adequate performance. For lateral direction, again, very similar to previous ones. Nothing different there. Controllable? Yes. Adequate? Yes. Satisfactory without improvement? Yes, a 3.

Task 5010, Stall—Idle Power

Pilot A. This is run 20, the power-off stall. We decreased our speed at 3 knots/sec, and once again, as you get very close to the stall, you drive off; it's kind of like approaching a cliff, and you push the accelerator to the floorboard as you're approaching the cliff instead of slowing down. With this gamma law, there's a natural built-in tendency to take you over the edge very quickly, especially as the angle of attack gets higher, and so as you're approaching 23° , you have to be very alert to push the nose down quickly at that point. Matter of fact, when you get up around 18° to 20° , you have to start decreasing the pitch attitude to keep the acceleration within the 3 knots/sec. You're having to anticipate quite a bit, but there's no large roll-off ... no departure ... and seems to be adequate nose-down authority at that point.

Pilot B. It's predictable in pitch and it's doing what it should; it's holding gamma, and so you don't have to hold the pitch forces to hold the constant theta, and maybe holding constant theta isn't a representative task for this maneuver. Yea, predictable and relatively easy to control. I think it may be that when I commented that I found my gamma was trying to increase on me, it was the ghost or the pseudogamma—the flashing gamma. Yea, once it's flashing, all bets are off.

Pilot C. This is run 20, item 5010. We did two of those runs. The maneuver is possible without exceptional pilot skill or strength. The recovery point ... there's positive pitch control. It's relatively easy to establish a nice rate of pitch down. Things are happening a little slower it seems, so it's a little easier at max power at this weight point. A lot of altitude was lost because of difficulty of decreasing alpha and to allow airspeed to build and recover. I didn't see how much altitude was lost, but obviously even with throttles

back it takes a long time to get the job done. Cooper-Harper ratingwise: was adequate performance attainable with a tolerable pilot workload? Yes. Is it satisfactory without improvement? My tendency is to say it's a Cooper-Harper of 3, some mildly unpleasant deficiencies, minimum pilot compensation required for desired performance. And oh, by the way, also the same thing, Cooper-Harper 3, for both the pitch and roll axes. Lateral directional appears to be no particular problem. I don't have to deal with the stick and roll at all, and beta doesn't get very large.

Pilot D. Okay, comments on task 5010, the idle stall straight-ahead. We ended with run 31. Pilot D on December 5th. Once you learn the technique, it's not too bad. A little more difficult than the max power one. The first one I did, I didn't realize that the gamma control system was going to drive it into a very high decel rate, and we ended up with a high alpha and lost the vehicle on lateral control. If you watch the decel rate, then [you don't] get that large alpha overshoot, and the vehicle seems very controllable in the regime. Lots of both pitch and lateral control power for recovery, no problem laterally. Again, with the ... must keep that max alpha within the boundaries. Pilot ratings. Longitudinal: the task is a little bit harder. You first have to plus and minus and then you have to pitch back down again. And again, I'm not sure how much value a pilot rating has, but I would say deficiencies require improvement. It's really maybe a little bit dangerous. There maybe needs to be some protection built into the control system for that kind of maneuver. I think it's somewhere in the Level II. What you call it ... let's give it a 5 for moderately objectionable deficiency—that tendency to drive into a real high decel rate. Laterally, as long as we keep the alpha within the boundaries there, it's no problem. I had adequate roll control power. No problem controlling roll to zero. Let's give it a 3.

Pilot E. Okay, 5010, stall, idle power. I took a little bit of effort in trying to establish a 3 knots/sec acceleration. The reason being, there's not a linear deceleration with either gamma or theta, and I would start getting a pretty good deceleration, and then I would hold everything, and then it would start slowing down, I think, more to like 170 to 160 knots, and then to start speeding up I had to push forward at that point. At about 130 knots I had to really push a lot of forward column because it would start decelerating very rapidly so that my gamma was almost down to 0 by the

time we hit 110. Recovery, I aggressively pushed nose down. My gamma went below scale ... off the bottom of the picture in front of me, off the bottom of the video screen. My theta was probably about minus ... my lowest pitch was about probably -4 to -5 and it stabilized down about -2 or -3 , and because of that, I got a little bit of a secondary stall as it tried to reacquire the gamma, so I kind of had to hold a little bit of forward stick to hold that theta. I probably could have been a little more aggressive and gotten the nose down a little bit more. But at any rate, there was no lateral or directional problems and it did recover consistently. There was never any doubt in my mind I was going to recover. The secondary stall was very brief and I hardly had time to notice it before it was over. Otherwise it didn't look too bad. I had zero phi. My little score card says $.9^\circ$. I'll write that down. I didn't even notice that. So for longitudinal characteristics the ... I would say the airplane felt controllable. The secondary stall happened so quickly I didn't really even notice it, so I never felt that. I probably wouldn't even comment, except to mention that it happened. So I would say it was controllable. Adequate performance was obtainable. Satisfactory without improvement. I would say yes, again with a caveat that we note the limitations of a gamma command control law at high alpha. But it seemed very honest. It didn't seem ... knowing that ... knowing that I had to hold some forward stick, which is not entirely uncommon in other aircraft that are not gamma command. Aircraft even with these stable phis and alphas, still I have found in the deeper stall area that you have to kind of control it. It will not on it's own just pitch over, but I didn't find it annoying. So I am going to rate longitudinally: Cooper-Harper of 3. Lateral directional: I had no problem whatsoever. It still took some compensation to hold it wings level but I really almost didn't even remember doing that, so it was certainly controllable. Adequate? Yes. Satisfactory. Yes. Since I don't really recall ever much doing anything, I am going to rate it a Cooper-Harper of 2. And either I just happened to just luck into doing it just right, or I just didn't seem to have any desire to fall off laterally.

Task 5020, Stall—Maximum Takeoff Power

Pilot A. With this control law there is a natural tendency for the alpha to take you right over the edge on the alpha without any envelope protection, and just automatically sends you rocketing off the edge of the cliff. In an accelerated fashion, once you set up an

unachievable flight-path vector, then it starts to increase the alpha and the more it increases, the more it increases, and it just takes off, and so there's a big difference between one recovering at 156 knots and 23° because you're starting to go over the edge there. Unless you anticipate it by a couple of degrees, I find myself what I really wanted to do is hold a constant alpha and let the speed decrease. I couldn't do that because the control law was telling it to hold a constant gamma, and it would just wrap the attitude up, the slower I got.

My major comment is that this control law—longitudinal control law—is certainly not the worst possible but certainly not the best control law for operation right near the stall because it just sends you off into a high-alpha situation the minute you command some unachievable gamma, and so you need to change laws when you get down this low. You need to have a different scenario for control at these low airspeeds.

I didn't put any big inputs in. I just told him level flight is no problem, but I don't know what would happen if you started exercising rolling back and forth or putting in rudder at these high alphas. I really can't say what happened there. I think that should be looked at systematically to see what the establishing envelope as far as tolerance for roll and yaw inputs versus angle of attack in the departure—boundaries of the departure envelope as related to rudder and aileron inputs versus angle of attack. In this case, the recovery was not a problem, especially at 156 knots. It had no roll off, and you had plenty of authority to pitch the nose down. In that respect, I'd have to give it a high rating in terms of the ability to pitch the nose down. What exactly is it you want to rate?

My major comment would be that this control law, where you're holding fixed flight-path angle, is the worst possible control law to have in this kind of a stall. You need to have an alpha limiting, definitely need to have envelope limiting, I think, for the low-speed end.

Pilot B. We settled on a task maintaining pitch attitude in the entry and recovery. In the entry I'm going to increase pitch attitude 5° to enter the stall, and that's giving me a pretty consistent ... about 3 knots/sec. At the recovery point, pushing the nose over to 15° nose up, from net change of 10° . So we're going to 15°

nose up in the pitch, and that's giving me an acceptable altitude loss of about 220 ft and a reasonable acceleration rate back to trim airspeed. Notable characteristics are, at the entry pitch attitude at 25°, I'm having to push forward with a fair amount of force to keep the nose from coming up at that point. I find that to be somewhat troublesome. I would not find that certifiable in a production airplane, in that the pitch stability is negative going into the stall. I'm not still quite certain what we're controlling to, because both theta and gamma are trying to increase on me and I'm having to hold them both down. However, that notwithstanding, the ability to maintain pitch attitude is not too compromised; it is relatively easy with minimal pilot compensation required. So it's controllable, adequate performance attainable, it's satisfactory without improvement from the standpoint of control forces and compensation. We'll call it minimal pilot compensation required for desired performance, with an HQR of 3. The caveat here is that I would bet that we do not meet the FAR in terms of stability going into the stall. From a lateral-directional standpoint, it's relatively easy to control. I did have a problem with bank angle control—we can say $\pm 5^\circ$ desired—I think that's what it says, isn't it? Okay, and we're able to maintain that fairly easily with very minimal compensation. It's controllable; adequate performance is attainable, that is, satisfactory with negligible deficiencies, and pilot compensation largely not a factor, with an HQR of 2 on the lateral directional. That concludes the comments.

Pilot C. This is run 18, 11/29/95, C is the pilot. The item number is 5020. The maneuver is moderate enough a workload to perform and not a lot of good cues to tell you how good you are doing. Not too difficult to establish the lapse rate for up to about 25° of pitch attitude and then gradually, as you slow down, you have to nudge forward on the stick to keep the attitude from increasing, and then wait for the call to recover. And at recovery the nose-down response is good for the airplane. No doubt that we got positive recovery even up to 21°. The amount of altitude loss if you hold 15° appears to be about 500 ft. Let me give you a Cooper-Harper rating now: adequate performance attainable with a tolerable pilot workload? I'd say yes. Is it satisfactory without improvement? I'd say ... I'm going to give it a 5 because ... I'm going to say moderately objectionable deficiencies—adequate performance requires considerable pilot compensa-

tion. And that's because I don't have very good cues to help me do the recovery part of the maneuver. I feel a little bit uneasy whether I'm doing it successfully or not. So it's difficult for me to give it a better rating than that. I felt like that's what's going on.

Pilot D. Pilot D on December 5th. This is a max power stall, task 5020, the last run was run 27. It seems to be a very easy task. Almost mechanical. You just pitch-up at a rate to approximate some reasonable airspeed bleed off at the max angle. Correction: at the min airspeed call, you just start pitching-down fairly rapidly, not full authority. This doesn't require full authority, I don't believe. And no lateral problems at all. Pilot rating, longitudinal: stand by. Is adequate performance attainable with pilot tolerable workload? Yes. Is it satisfactory without improvement? I'd say improvement not required. It would be nice to have the stall alpha on the head-up display somehow, in an analog form versus just the digital form. Let's make it a ... you know, you could always use a little more control power ... let's make it a 3. It's really pretty darn good. That's longitudinally. Laterally, there's just no task at all. I didn't abuse the thing ... put in small bank angles to see if that excited any problem. Okay, so with that caveat, as long as I held it to 0, it's definitely very good, and let's make it a 2.

Pilot E. Okay this is Pilot E, second session for December 1, run 5020, stall takeoff power. I didn't see anything too bad. You have to obviously hold a little bit of forward column or forward side-arm controller to keep the theta down, but I didn't think that was too terribly bad. As long as you got this good HUD display you can surely see where your theta is, very easily. As far as having to stall at 21 alpha, which was about 151 knots, I just made an aggressive nose-forward column command, and it responded very well. A little bit kind of knife-edge in lateral axis ... just a little bit unstable laterally, but it was easily controllable and it had a maximum deviation of 3 1/2°. So that was in the desired criteria. So for my evaluation, using Cooper-Harper for longitudinal, there's no really performance standard. So this ... kind of a strange Cooper-Harper rating here, but basically for gut feeling, it was controllable; adequate performance was obtainable. Satisfactory without improvement? I don't see anything wrong with it. I'll give it a 3 and obviously we all know the pitch falls with gamma command at high alpha, but to me it is pretty honest and

pretty straightforward, and there's no tendency to pitch-up uncontrollably with the gamma command. Obviously, I know that that holds a little bit of forward input to keep the nose from tracking up, so I have no problem with that myself. Lateral-directional Cooper-Harper: that was well within the desired criteria there. So, controllable? Yes. Adequate? Yes. Satisfactory without improvement? In order to make it within ± 5 , I would say ... I might say no and give it a Level II, a Cooper-Harper of 4. Simply because I just have the feeling that I could kind of exceed it at any time. I just didn't feel like I was completely in command. I was, but it just seemed a little bit too squirrely, so lateral I will give it a 4.

Task 5040, Turning Stall—Idle Power

Pilot A. We repeated the turning stall, power off, run 22. Initiated recovery at 21° alpha, and there's a positive ability to pitch the nose down and roll, wings level. There's a slight bobble in controlling the pitch attitude, but I think it was due primarily to the fact that this is a gamma control law, and there's a slight tendency to PIO as you pitch the nose down to reduce angle of attack. I think when we get to abnormal high angles of attack, you probably ought to be using an alpha control law.

I didn't take this one to as high an angle of attack, but considering the point at which we started the recovery at 21° versus 22° to 23° , it seemed to be totally consistent with the straight-ahead. So, I saw essentially no real difference in the ability to recover from a stall, considering how deep we went into each one as far as turning versus straight. It seemed to be plenty of nose-down authority at that point. I think that alpha-dot has a lot to do with the ability to recover in terms of at point and at what alpha you need to recover at. You have a very high, increasing alpha going; in order to turn that around, you need to start your recovery obviously a little earlier, maybe 1° or 2° . There again, this control law tends to accelerate you into the high-alpha mode of fixed power.

Pilot B. Run 38, task 5040, turning stall. This is a repeat of an earlier test. The difference here is the card indicates decelerating to 180 knots. We are going down to about 110 ... down to about 21° alpha, recovering about 120, and seeing about 110 minimum. Recovery without any throttle adjustments. Angle bank is fairly easy to set, the pitch attitude initially is fairly

easy to set, up to the decel. As you get down to 150 knots though, pitch response appears to become more sensitive to inputs now. Keeping in mind this is a gamma system, I have to apply forward control to keep the nose from continuing to come up as you get slower, which I have a problem with. I would probably say that is not certifiable like that, and you must provide some kind of speed protection in the control system. But nonetheless, what we are flying has no speed protection, and I am finding that, as you get closer and closer to that 21° alpha, you got to put more and more stick in, and number one and number two gets a little bit more sensitive to the input, so that by the time you reach 21° alpha, there is a little bit of a tendency to bobble and pitch. At that point I tried two different techniques for recovery. One, I tried to control the beta as I pushed the nose down and rolled, in that order, and the other technique was to leave the rudder inputs alone as I rolled the airplane back to wings level. I felt like when I controlled the beta ... like it was very critical ... like I could see myself kind of on the ragged edge of control. That is why I want to try it without rudder pedal inputs. However, I ... when I tried it without rudder pedal inputs, I did not lose control. I was not even close to it, so I did not have the problem I thought I was going to have, and it should be kept in mind that I was trying to very smoothly roll. I was not in a hurry to get the wings to level so it might be interesting at some point to see it with larger inputs, but at any rate, with the technique used I did not have any problem with control. However, I was working in the lateral axis in the recovery as well. Okay, having said all of that, Cooper-Harper: it is adequate ... excuse me, it is controllable, adequate, and I would say desired performance requires moderate pilot compensation, particularly there near the end. Give it an HQR of 4, and also, it might be interesting to see a tighter control task. I really didn't have a longitudinal control task near the end of the stall in the recovery, so I guess my tolerance for what desired pilot compensation or desired performance is for is rather large. I am looking for pitch attitudes in the order of 2° to 3° around what it is I am trying to set, and I am able to do that. If you try to tighten that up any, the HQR would of course move down. So at any rate, that is an HQR of 4 longitudinally. And lateral directionally: again, I did not really have a task in the area that I am concerned about, but my task is to try to maintain bank angle within about 5° of what I was trying to set and try to maintain beta, when I was trying to control beta within a half of

pyramid's width. Given all of that, it is controllable and adequate. However, there is a lot of workload associated with those two axes. And I would say desired performance requires moderate pilot compensation, HQR of 4. That concludes the comments.

Pilot C. This is run 24 and item number 5040, turning stall, idle power. The major difficulty with this is once you start the recovery, if the recovery is aggressive at all, as you try to roll out and, with the rudder pedals, to take care of the beta, the airplane is prone to departure. Recovery can be made without saturating the controls by being very deliberate on the roll, and then the beta stays in control and no rudder pedal is required. And recovery can be successfully initiated. I do, however, feel that that is quite a bit of concentration on the part of the pilot. So, is it controllable; is adequate performance attainable with a tolerable pilot workload? I would say no. I'd say it's Cooper-Harper 8. Considerable pilot compensation is required for control. Then the problem is you have to ... on the compensation ... is not moving as fast as you would like to on the recovery ... otherwise you'll saturate the controls. The 8 is driven by the lateral-directional primary; it's a little difficult to rate pitch in this respect, but it seems to me that the pitch was probably all right. So, adequate performance attainable with a tolerable pilot workload: is it satisfactory without improvement? I would give it a Cooper-Harper of 5. Moderately objectionable deficiencies: adequate performance requires considerable pilot compensation. Part of that is because of the unknown associated with the onset ... starts to saturate and depart ... it's hard to tell whether you have adequate pitch control during that departure or not.

Morning session, Pilot C, task 5040, rating recovery from 30° bank stalls with the throttles in idle. The pitch attitude starts out about 12° when we are beginning the recovery, and the recovery consists of a combined reducing the roll and reducing the pitch, and if you do that with what seems to be a reasonable recovery rate, then you have a good likelihood of getting into roll PIO—a low-frequency roll PIO that is caused by saturation of the ailerons. You just keep chasing after it, and there is so much delay in roll response that it causes the PIO. And even with the nose buried a lot and the airspeed increasing rapidly, that roll PIO continues until you get about 180 knots and then it begins to ... then the roll PIO goes away and everything feels pretty normal again. Let me get the Cooper-Harper

diagram here: is it controllable? Yes. Is adequate performance obtainable with a tolerable pilot workload? And I say no. Deficiencies require improvement. I give that an 8; considerable pilot compensation is required for control. In this case the pilot compensation is having to be very cognizant of what the recovery procedures should be and backing off from what he would otherwise naturally do from the visual that is presented to us. So it takes some considerable pilot compensation to make sure that we don't depart the airplane. Yeah, longitudinally there's no particular problem that I can see. The big thing you feel is the roll, the tendency to get into a roll PIO and possibly depart, if you aggravate that too much. If we think about pitch, we could say adequate performance obtainable with a tolerable workload, yes. Is it satisfactory without improvement? I really really feel that the answer to this is buried in what you see in the roll axes so I will say it is satisfactory without improvement, Cooper-Harper of 3, but that could easily change once the roll part is fixed or better.

Pilot D. Pilot D on December 5th, turning idle stalls, task 5040. We ended with run 34. The first run I did, I was very slow in getting my roll back to level in, and it was really no problem. It was very similar to the longitudinal one. I essentially got the alpha under control before I attempted to get the bank in, erroneously, because one of the first things you want to do in a stall is of course get the wings level and minimize altitude loss. On the subsequent runs, it takes almost or all of the lateral control to get a reasonable lower rate. If this is put in simultaneously with the longitudinal stick, it's driving it into a limit cycle—Dutch roll—that continues until the alpha decreases to reasonable values. And I was using almost max longitudinal controls to get the nose down at a reasonable rate. I'll give it some pilot ratings here. Longitudinal: let's give it a 4. I'd like just a little bit more control power longitudinally. But it's marginal, it's like a 3 1/2, but I'll give it a 4 since you guys don't like 3 1/2. Now lateral: I don't know what really to say. It's definitely Level II at the best. I guess you could say it's almost like a 6, isn't it? It's tolerable, but not very desirable. That's a pretty damn objectionable ... yeah, and that's from the aircraft characteristics column. The workload is not there, all I did is let go of a stick and let it take care of itself. So let's give it a 6. So what I ended up with—a 4 and 6? What ... I gave it a 4 on the longitudinal? Okay.

Pilot E. Okay, we just completed 5040, turning stall, idle power. As you all have seen before and as Lou was explaining to me, the thing is very sensitive laterally. The controls ... the kind of technique that I've always been taught and followed for a turning stall is to recover longitudinal first and hold your ... put no lateral inputs. And this goes back to A-4's and F-8's and certainly could depart if you made any lateral input in the stall condition, so I am always being very careful in the lateral axis just to recover longitudinally, and then once you get a few knots going up, to go ahead and recover laterally. The first time I was a little more aggressive laterally and got into a little bit of, about maybe two or three cycle, lateral PIO. But it cost about 10° to 15° angle bank, and maybe I was a little bit out of phase of rudder, but it wasn't anything too dramatic. On the second one I was intentionally more careful laterally. And basically had no ... had just a very slow recovery. I got the nose down and very slowly recovered to 0° phi and didn't have a problem. I had a ... on the longitudinal recovery, I probably released a little bit of forward stick and just got a brief secondary stall, where the nose popped again. And even though I was still in an angle of bank, I didn't do anything with the lateral axis. I did have a little bit of sideslip, very slowly took out, again, just being very gentle in the lateral axis showed a very benign stall characteristic. So I think that would be the key, and that is probably how you would train your pilots to fly this thing. At any rate, I am looking for ... we possibly got ... doable without exceptional piloting strength or skill. Well, I don't think I have exceptional strength. Strength not skill. Right. No control the [unintelligible]. The performance standard says 30 just holding your angle of bank, which ... Right ... Sure ... I didn't; I wasn't really trying that hard to hold 30 phi. I could have very easily. I was mostly hands-off on that, except for the delta. At any rate, as far as the recovery, I thought longitudinally the recovery was not bad at all. So I felt that longitudinally the aircraft was controllable. Adequate performance was obtainable. Satisfactory without improvement? I would say so and give it a 3. From this maneuver, exactly as it was done, precisely as it was done, I saw nothing that showed me anything other than that. If I had been more aggressive, maybe I would have more problems, but the secondary stall thing is something you have to watch out for. I think although we can solve the problem by keeping some forward stick in there so you don't release some of the elevator, so you don't get that little

pitch-up. Yeah. The lateral had a little bit of PIO on the first one but not on the second one. So on the second one, I thought that also worked out pretty well. Controllable? Yes. Adequate? Yes. Satisfactory without improvement? No. I probably would rate that a 4, and the only reason being that you seem to have a little bit of sideslip that to me was not completely intuitive as I was putting in rudder. But it didn't seem to just kind of take it out as I thought it should. So anyway, there's a possibility of a PIO and I'm thinking the second one indicated. I think overall I probably would rate that a 4.

Task 5050, Turning Stall—Thrust for Level Flight

Pilot A. That was a recovery from a turning stall level flight, power to level flight, run 25. The push was started very close to ... well, first of all, getting the last part of the entry rate correct by 3° is very difficult because you're having to push nose down to counter a natural tendency of the control law to take you into the stall, and so you're almost full nose down on the stick before you even start the recovery in order to achieve that 3 knots/sec entry rate. It's difficult to keep that alpha from exceeding 23°. Although I think I recall seeing it went up to about 23.8 or something like that, the nose was coming down, and I pushed the nose down quite a bit farther—I think 15° or 20° down. I can't remember how far it went initially, but that got us into a situation where we had the alpha changing quite rapidly from 10 to 18, and I didn't quite understand why it was changing so rapidly. We finally recovered, but during the recovery, at about 10° to 15° alpha, we had a PIO in roll going in there for 3 or 4 cycles and then stabilized out and recovered.

Pilot B. The task was 5050, turning stall, thrust for level flight, except this time we had a rate command attitude for hold system in the longitudinal axis; everything else, pretty much the same. A big difference on longitudinal Cooper-Harper and interestingly enough, lateral directional. So some of my lateral-directional problems may be influenced by the workload of the longitudinal axis. I felt like the pitch attitude was very easy to control. The deceleration was very smooth. The recovery was very benign essentially and uneventful. A lot less problem in controlling pitch attitude right up through the stall, so longitudinal, talk

about $\pm 2^\circ$ of pitch attitude control for desired. It's controllable, adequate, and this time I feel it's satisfactory, with minimal pilot compensation required, HQR of 3. Longitudinal axis, and surprisingly, lateral directional, has also changed. It's controllable, adequate, and sat, and again, minimal pilot compensation, HQR of 3. It concludes the comments.

Pilot C. This is run number 15 and the task number is 5050 and it's about half and half, 11/30/95, and the pilot is C. And again, we're rating the recovery part of this only. We're starting now at about 15° to 17° pitch attitude when recovery starts with about 21° alpha. If you are not too aggressive on the controls, but what I would say at least moderately aggressive, you have to be in order to get the nose to start to come down. The nose coming down feels a little lethargic, making you worry that maybe it's on the limit on what you can recover from, and then when the nose gets low and you try to settle the pitch attitude down, the nose has a pretty large oscillation, which is probably due to the way the flight control system is set up. It's not a nice feeling watching that happen outside the cockpit, but it's not dangerous from an out-of-control standpoint. The pushover and the lack of pitch authority at the very beginning is a little bit of concern. On the first couple of recoveries I only had a minor amount of difficulty with the roll axis, and the last recovery I did, I used a little more roll stick to begin the recovery more so than before. About the same amount of down stick I think, but perhaps a little less, but a little more roll stick to begin the recovery, and that put us immediately into a characteristic roll PIO we see with saturation, and that roll PIO then continues all the way down until it accelerates to about 180 knots again. And then it promptly goes away. So, Cooper-Harper ratings coming up: Is it controllable? I will say yes. Is adequate performance obtainable with a tolerable pilot workload? No. In this case it is—we will try to separate it into pitch and roll again here. If we think about pitch, adequate performance not obtainable with maximum tolerable pilot compensation—controllability not in question. It doesn't really fit because I don't feel comfortable with the idea of saying controllability is not in question. Yeah, when I try to push it so I think it doesn't really fit in the 7 in the pitch axis. Although, it's close to being the case where it's not in question, but it's ... in this case it's more than that, so we have to go with considerable pilot compensation is required for control, and it's Cooper-Harper of 8. And in the roll axis I think it is a solid 8, bearing in mind that I

have to be operationally cognizant of ... that I can't make the recovery without disregard to roll inputs. I have to compensate by making sure my roll inputs are smaller and less aggressive in order to keep a 7 to 8. Is an 8 also, and you know my comments give the caveat that the roll is a solid one ... a solid 8 and the pitch is a little less important at this point. It is still an 8.

Pilot D. Pilot D on December 5, 1995. This is a 5050, turning stall with power for level flight. It's basically just ditto of the turning idle stall, 5040. I really can't add anything to it. I would like to go back and modify my pilot rating ... longitudinal pilot rating ... on 5040. I gave it a 4, but I forgot to take into account the fact that it does have that tendency to self pitch-up into a potentially dangerous mode. Let's make it a 5 on 5040 longitudinal. 5040 will be a 5 and a 6, and I'll make it the same for 5050.

Pilot E. Okay, that was 5050, turning stall thrust for a level flight. Longitudinally you saw the previous one, which was idle power. In that, I didn't notice anything too bad, except for the fact I did get a secondary stall, as Lou likes to call it, where the theta stopped going down. It started to ... kind of started to come back up. The alpha kind of quit unwinding and well I was just trying to be real gentle in the recovery in both axes, and I probably could have been a little more aggressive holding the nose forward, but once I got a pretty good rate going I probably relaxed a little bit with the forward stick, and that caused it to kind of stop it's forward rate. So obviously, with this control law, you do need to be aware of what the airplane is doing and how you should respond, so that was kind of my fault there. However, with that in mind, I do not think ... I didn't notice any ... there's no PIO, obviously, and you know if you just know what to expect it's very straightforward, I think. So, controllable? Yes. Adequate? Yes. Satisfactory without improvement? I'll say no and give it a 4, and the only reason is because there is a slight tendency for the nose to rise back up, which is probably classically a good characteristic of an airplane but again, it's explainable and I understand it. It's just, I got to do a better job of flying the airplane as it should be flown. For lateral directional, again I saw ... as long as I was gentle with it, I mean ... from the two I did I saw nothing that tended to make me think anything was other than it was a beautiful airplane. But then again I was spring-loaded to being gentle, which was kind of how I would have done it

anyway had I not been ... had we not talked about it. But at any rate: controllable? Yes. Adequate? Yes. Satisfactory without improvement? Yes. I would rate that as 3. And actually the sideslip almost took care of itself. I very slowly rolled out. It had a little bit of sideslip. I just barely put some rudder pressure on it and just very smoothly recovered the sideslip. So the sideslip never got to be an issue, and it was almost just a hint of rudder pedal at the recovery.

Task 5060, Diving Pullout

Pilot A. That's the diving pullout I believe, 5060, run 53, pushing over to $7\ 1/2^\circ$ angle of attack. And be very careful pushing over because of the very light stick force for g , the gradient. We need some g feedback into a force loop on the stick, I think, and displacement so there's some deterrent against distressing the airplane and throwing people onto the ceiling, so to speak. And at the 2.5 g point we start a pullup. If you snap the throttles back quickly you get a very, very sharp transient in low g and in excessive g 's. It appears as though you're closing the throttles—probably ought to be done through an autothrottle or some—it ought to be some coordinated effort in terms of pitch, pitch control, and throttle so that they complement each other and the process is a smooth one. Closing the throttles very slowly seems to help considerably. Seems to meet the target goals by closing the throttles over about a 10-sec time period. I think that was about what it was, wasn't it—about 10 sec to close. So that probably is for throttle movement. It probably would be as fast as you would want to move the throttles up here ... at least closing them ... and I would rate the longitudinal Cooper-Harper as follows: Is it controllable? Yes. Is adequate performance attainable with tolerable pilot workload? Well, I guess I would have to say yes. Satisfactory without? Assuming you close the throttles smoothly without improvement. Well, I guess there's two answers here. If you close them very quickly, you have deficiencies that require an improvement. If you close them slowly, you probably don't need improvement. But I think on the whole you would probably have to say it's a 4 [with] minor, annoying deficiencies and requires moderate pilot compensation. That's on longitudinal. And on lateral directional, no particular problems in lateral directional, and I give it a 2.

Pilot B. Run 38, task 5060, diving pullout. I did several of them to get the technique down. And part of the

reason why technique is so critical in this is the stick force/ g is quite low in both directions. I don't have a gauge, and I haven't calibrated myself on this inceptor, but it's something on the order of 10 lb/ g . Maybe less than that. But it's of the order of 10 lb/ g . That, plus the fact that there's no motion cues and the g readout is a digital readout contributes to the difficulty in the task. The task, by the way, was a straight and level push down to $7\ 1/2^\circ$, depressed the flight-path angle to 2.5 Mach and then execute a 1.5 g pullout, retarding the throttles to idle. The task was also made more difficult by the pitch moment changes with idle. There is a big tendency to pitch-up when the throttles are reduced. I found myself having to ignore the velocity vector because that is moving around, a result of the vertical component of thrust, quite a bit. So I am concentrating primarily on the pitch attitude indicator and trying to keep that down to between $1/3^\circ$ to $1/2^\circ$ /sec. So g is wandering quite a bit. But I was finally able to ... after practicing a few times ... to keep the max g under 1.7. In fact, the last time it was down around 1.6. So I'm oscillating between about 1.2 and 1.3 and up to about 1.6 in trying to keep 1.5. So it's a fairly difficult task. Lateral directional is not much of a problem at all. Okay, Cooper-Harper ratings: longitudinal, it's controllable, adequate performance is attainable; however I'd have to say that desired performance requires moderate pilot compensation. It's between a 4 and a 5 because adequate requires considerable. Desired probably requires considerable as well. I'm going to give it a 4, since I can't give it halves, but I would normally give it that about a 4.5. Okay, lateral directional: it's controllable, adequate, it's sat, pilot compensation not a factor. You can ignore the lateral directional axis and it kind of takes care of itself. That's an HQR of 2. That concludes comments.

Pilot C. Okay, this is run 19, 1 December, Pilot C, and it's task 5060. Give it a Cooper-Harper first here. Is it controllable? Tough question this time, because of the g limit stuff. Yes. Is it adequate performance obtainable with a tolerable pilot workload? No. Adequate performance not obtainable with maximum tolerable pilot compensation ... controllability not in question. Well, considering the g limit problem there, which we worked on and worked on and worked on and couldn't really get it to be adequate, I would have to say considerable pilot compensation or intense pilot compensation is required to retain control or I'll be Santa Claus. Considerable pilot compensation is required for

control, [CHR] 8. And the difficulties there that I encountered is it's very difficult, given the concentrating on the flight-path marker, to recover in a reasonable way. You pull up on the nose. First it doesn't want to come, so then you pull back locked and you get the large increase and the positive increase in the flight-path command marker, and then that gives you way too much g . Your thrust finally decays. And if you try to do it with using attitude, that problem is even worse because you try to hold the attitude in a given place as the engine thrust decays, and that causes the flight-path marker to integrate way up the pitch ladder, and then you end up with far too much g when the thrust decays. So lateral is not a factor in this, and it would be somewhere in the order of satisfactory without improvement. Cooper-Harper of 3. Minimal pilot compensation for the lateral directional. (So that's an 8 and 3?) Right.

Pilot D. Pilot D on the 7th of December, 5060, the diving pullout, you pitch over to minus $7\frac{1}{2}$ and let the Mach build up to $2\frac{1}{2}$ and then recover. Recovery is defined as $1\frac{1}{2}g$ pullup, retarding the throttles to idle. Okay, everything is very easy until you pull the throttles to idle, and the large pitching moments induced the engine thrust coming off as too much for the control system, and you get some control system g 's there, both taking the throttle off and putting it back on again. So it's ... in the simulator here at least, without the true motion cues ... I wasn't able to come in; I wasn't able to get adequate. Give it a longitudinal pilot rating of 7. Lateral, no task, 2.

Pilot E. Run 25 to 30 for card 5060, diving pullout. Interesting. We did about four of these with pulling the throttles back to idle. In the last one, at Lou's suggestion, with leaving the throttles at full power or trim power. On the recovery with power ... with the power ... the throttle pulled back to idle, there is a point where you ... what I was doing was pulling the power back. The first time, I did it very abruptly, and it ... I really got a pitch-up, a strong pitch-up. As I was also starting my pullup, when I yanked the throttles back, I got a very good g spike. So the next time I tried pulling the throttles back very smoothly, and I was also into my pull as they were coming back. At some time point after reaching idle you do tend to get a little g spike. It tends to pitch-up and that would tend to give me my little g exceedance. The last one, with the throttles coming to idle, I tried to consciously be

aware of that and I tended to stagnate. It seemed like it kind of held it about a little over $1g$ and I had a hard time getting it to increase. And then all of a sudden, it ... as I was putting in more back stick to get it to ... get above about $1.1g$'s, it kind of jumped off and went to about 1.75, 1.8. Very, very sensitive in pitch with the throttles coming back. Possibly due to some pitching moment with power effects. If you leave the throttles where they are, it's a very smooth maneuver. You can command about $1.5g$'s within plus or minus about $5/100$ of a g and do the maneuver very easily. So obviously the power coming back does make the task more difficult. Since the test card calls for the power coming back I'm going to go ahead and rate it based on that. So, longitudinal: is it controllable? Yes. Is adequate performance attainable? Yes. Is it satisfactory without improvement? No. Since the criterion is $\pm 2/10$ of a g , I will rate that as a 5. I'm not really thinking I was able to consistently get desired performance. For lateral directional: it's not an issue here. Controllable? Yes. Adequate? Yes. Satisfactory? Yes, a 3. There is ... I noticed no real coupling. I had slight pitch or roll deviations, and I was actively trying to hold it to zero, so I'll just give it kind of a perfunctory 3. It could probably be a 2 also, since it's not really coming into the task.

Task 5070, Emergency Descent

Pilot A. Okay, this is comments on the emergency descent, the last run number was 50 and the card is 5070, and the gear was extended, and the thrust popped idle fairly quickly; the g 's go to about a -0.2 or so. Be careful. So thrust has to be brought back slowly. That sounds as though that's something that could be done while you're assessing the problem. Slowly bring the thrust back to idle and start down the ... left turn was done and the ... while the gear was extended, as we went down the Mach line roughly 2.4, we ... actually it was less than that ... maybe 2.2 ... then we tried to check our airspeed ... indicated airspeed increase, so to have a constant ... an airspeed of 275 or less. When we did that we started pulling some g 's—like two— $1\frac{1}{2}$ to $2\frac{1}{2}g$'s on the airplane. We got a large beta sideslip angle on the airplane, and it took some heavy forces to correct the beta. When you release the g forces at that point, then the sideslip tends to disappear, to dissipate. And if you're very aggressive and rough with the controls, you come close to losing control of the airplane at that point. If you're smooth and get on the corrections, you can get

through that phase. And other than that, after that settles down it's sort of a normal descent of just regulating pitch attitude, and to follow a prescribed airspeed descent profile, and there's nothing particularly abnormal about that. Cooper-Harper-wise, longitudinal controls: is it controllable? Well, I guess you could say yes; however, when you bring the thrust back quickly there's negative g 's on the airplane that come in that's quite ... it would seem that the control system should allow ... should provide for that. Adequate performance attainable with tolerable pilot workload? Gee, it's questionable. I would tend to think probably it's marginal; marginally yes, I would say. Satisfactory without improvement? No. Very objectionable but tolerable deficiencies. I'm going to say yeah ... I'm going to give this a Level III—major deficiencies—and call it a 7. Adequate performance not attainable with maximum tolerable pilot compensation. Well, controllability not in question. I have to give it a 7, longitudinally. Lateral directionally, it's pilot's decision. Is it controllable? It depends. Sometimes it isn't, but most of those were cases where the g 's got excessive. We're using left turns with the gear down, high speed. Is adequate performance attainable with tolerable workload? I would say probably not, and deficiencies require improvement ... major deficiencies. Considerable pilot compensation required for control. I'll give it an 8 because you're—oh, okay, okay, okay—so I would give it an 8, and primarily because of that excursion in yaw, when you pull g 's trying to coming down the Mach line and trying to slow down to a constant airspeed.

Pilot B. Task 5070, emergency descent. The task was flown in accordance with the trajectory display in place of the PFD from string level 2.4 Mach at 64000 ft. Task was to evaluate handling qualities smoothly with no tendency to oscillate, hunt for pitch attitude or speed. We tried it without an unstart and with unstarts on all four engines. Basically the only major problem is in controlling normal acceleration with the lack of cues and you're concentrating so much on placing the nose, you really need something to tell you where the g 's are. In the airplane you'd have seat-of-the-pants to help you with that; in the sim you really don't, so you need ... a bar would help, as I mentioned to Bruce. Let's see. In terms of the schedule, I am trying to maintain schedule within about half a circle's length. We easily made the max cabin altitude the second run and made it on the first run. And in no case were we able to get it below 3 min in terms

of cabin altitude, but that is not really an HQR criterion; that is more of a performance criterion, so I am not going to penalize it for that. Okay—longitudinal HQR: It's controllable, adequate performance is obtainable, and I would call it moderate pilot compensation. Give it an HQR of 4. Lateral directional is controllable, adequate, and satisfactory with minimal compensation. Give it an HQR of 3.

Pilot C. Starting off here, it's task number 5070, and it's run 008, and the pilot is C, on one twelve-one December, that is. Starting off with a Cooper-Harper rating: Is it controllable? Yes. Is it adequate performance obtainable with a tolerable pilot workload? Yes. Is it satisfactory without improvement? Let me read that again ... I want to read this. What was the evaluation basis? Evaluate the handling qualities during rapid, maximum-speed descent from cruise; perform maneuvering smoothly, with no tendency to oscillate or hunt for pitch attitude or speed through the maneuver. Well, I can't say that I didn't hunt for the pitch attitude that I needed to do. There's a tendency to chase displays that are provided, so I would say minor but annoying deficiencies. It's not satisfactory without improvement. Cooper-Harper 4. Desired performance requires moderate pilot compensation. And in this case, I don't complain about the ability to make small, precise maneuvers with the controller like I did before, because if it's an emergency procedure I don't consider that we need to have that supergood ride quality. But I wasn't able to really pick a good attitude and hold it and do a good job of maintaining the airspeed and altitude with the display that I had.

Pilot D. Pilot D, December 7, just redid the emergency descent. We did a few before the break, 5070, run 54. The [VHD] is pretty interesting. It's fairly easy to use once you get on the profile. It looks like we need to learn ... the crew should be ... should learn and or be briefed on ... the initial pitch-down attitude is to get you started correctly. I am wasting a little bit of time there, but once you get on the profile, it's fairly easy to use. I'm not really cognizant of how many g 's I'm pulling, but in real life you would learn that also and of course you would have the motion cues. Overall, not too bad. Pilot rating, longitudinally, and we've gotten up to, is it satisfactory without improvement? I'd say no. You've got room for improvement on the display. I would like to see this [VHD] integrated into something head-up. A director or some kind of guidance up, head-up and use the head-down as a monitor,

and in particular the head-down needs some work on the predictor. It's a little bit noisy. Let's give it a 5 [with] moderately objectionable deficiencies. Laterally, there's not much to the task; you just hold the stick over till it limits and leave it there. That's about a 2.

Pilot E. Okay that was 5070, the emergency descent. We only had time to do it once. Basically you're given a speed limit display which allows you to pretty much fly right down the limit Mach number and then limit the airspeed by varying your gamma. I chose to roll into an angle of bank. I kept it at the maximum angle of bank for most of the time. Interestingly, I kept feeling like I had to hold lateral stick, but in fact I did not realize I had a 35° phi limit, so for a good portion of the time I was trying to break the stick ... trying to get more phi ... but probably 35° phi, with the limitations on the airplane, is probably not too bad. I'm sure, if you got too much higher angle of bank, you could certainly run into risk, with the high speeds, of overstressing the airplane or overspeeding it because you would not be able to get the nose up while you were trying to roll out. On my rollout, interestingly enough, I went ahead to rollout first and then applied the g. I should have kept the g in because it did accelerate a couple or three knots above 350, so I think my technique would be changed. Next time I would go ahead and increase the g in the angle of bank, and then once I was sure that I was staying below 350, I would then rollout, because the tendency when I rollout was to relax the g. Normal acceleration speed limits weren't exceeded in my opinion. We said 0.6—a negative 0.6g—but I don't think I had much control over that. We think that occurred during the throttle chop. And except for the fact that the noodle is very, very active, and so it's difficult to try and really lay it on the limit line, and that's why if you look at the trace you'll see kind of a jagged trace running right along the limit line. Though with that noodle bouncing around so actively, it's kind of difficult to really see where the trend of the noodle is, so you end up having to watch the digital airspeed and having to kind of play that along with the noodle. The noodle can be slowed down so it's more ... you can lay it ... like a predictor noodle for a horizontal task—say a track noodle predictor. It will be a lot easier to do a smoother airspeed control task. Okay, so for the descents for the targets, we think—keeping it below 25000 ft for 120 sec or above 25000 ft for less than 120 sec—it appears to be quite difficult. Certainly I

met the desired adequate borderline on that, so as far as rates ... ratings for longitudinal: is it controllable? Yes. Is adequate performance attainable? Yes. Is it satisfactory without improvement? Well, I'm going to say it's borderline desired adequate and give it a 4, and the overall task is a fairly high workload. It is and it isn't. It's fairly easy grossly to do the task to make a very, very smooth velocity trace. With the noodle being so active, it's more difficult. I'm going to rate it a 4. For lateral directional, it's really ... lateral directional ... it's not much of an issue here, once I figured out and Bruce told me that I could pull the stick as far as I wanted but I was never going to get more than 35° angle of bank. So pretty much, it's just full stick over and hold it there, so the lateral is not really an issue here. The recovery was more of a longitudinal error on my part, where I got that 2- or 3-knot overspeed. So is lateral directional, controllable? Yes. Is it adequate? Yes. Is it satisfactory? Yes. Well ..., it would be borderline 2 to 3 since in my opinion it does take some coordinated lateral directional and longitudinal input to get the initial profile established. I would say there is compensation there, so I would rate it a 3 simply because of the task, but it's kind of borderline 2 to 3 on that.

Task 6040, Center-of-Gravity Shift—High Speed

Pilot A. [Pilot A did not rate this task.]

Pilot B. Run 40, task 6040—cg shift at high speed. There is no Cooper-Harper's here. I wasn't controlling the aircraft a large part of the time. In the aft cg shift ... now the first indication is a mild oscillation plus or minus a half a degree or so at about 2/10 of a Hertz, about 5-sec period. That oscillation grew until just prior to divergence at about 80 percent aft cg, when the pitch attitude abruptly increased in the nose-up direction. No warning. It was real abrupt. Early on in the oscillations, they could be controlled with stick inputs. Later, and prior to divergence, the oscillations could not be controlled. In the nose-down direction, there didn't appear to be any oscillations initially, just a kind of jerky, slow increase in pitch-up attitude, as you would expect, as the cg went forward, until ultimately it ran out of authority and then started pitching down. Of course, the commanded stayed where it was and the actual started diverging down. However, it was a smooth divergence; it wasn't an oscillatory one. If you match up the commanded and the actual

gamma, you then have authority again and you can pitch the nose down and up again. But ultimately, the pitch rate just continued to increase in the nose-down direction. We finally knocked it off at about 1 percent cg and something on the order of 0 to $-0.5g$'s heading down. That concludes comments.

Pilot C. [Pilot C did not rate this task.]

Pilot D. [Pilot D did not rate this task.]

Pilot E. [Pilot E did not rate this task.]

Task 6050, Inadvertent Speed Increase

Pilot A. In terms of g 's, I think an analog g meter, or a physical tape, or some kind of communication like that—you would get better rate information on g 's—would be helpful. There again, I don't have a seat-of-the-pants feel ... which you can just about estimate a half g , by the seat of your pants. Instead of the flashing digits, it would be helpful to have an analog g meter.

The forces for producing a g ... stick force per g needs to be adjusted so you don't inadvertently exceed a g . I think this is just a little bit light on stick force per g considering the consequences of an engine unstart. For that reason I would tend to favor a little higher stick force per g . I don't know what you have here, but it seems a little light. I'd increase it by 50 percent at least. I brought my g 's into my scan and slowed down my pitch rate quite a bit and was able to hit the g 's fairly close. That was without the rudder required—rudder anomalies. Now if I had unstarted an engine and had a rudder input required, then I probably would be jockeying the rudder pedals and unstarting other engines, so you're on a fine line here. I think there's going to have to be a balance between the ability to deter the pilot from inadvertently using inputs that cause unstarts, and also the engines are going to have to be maybe made a little bit more tolerant to maneuvering. It's going to have to be a match between the two types of compatibility. You have to make the pilot inputs compatible with the engines.

It's controllable, and is adequate performance attainable for tolerable pilot workload? Yes. Is it satisfactory without improvement. I would say no. I think the stick force per g could be tailored a little better, and I think the g display needs to be ... I think you

need a good g display that's analog with rolling digits and preferably a needle or vertical tape indication, and I think the same could be said probably for perhaps alpha and Mach number. Those are fairly basic parameters. Especially Mach number and g at this altitude, and even perhaps sideslip—you do have analog on sideslip. So, for Cooper-Harper reading, I would say a 4.

Lat dir didn't really enter into the picture on this one, since we didn't have an unstart, and I saw no problems with that. For this particular task, I would give it a 2.

Pilot B. Okay. Comments for run 66, test 6050, inadvertent speed increase. Essentially a fairly simple task. Conceptually, the problem with it is the display doesn't give you an adequate reading of g , but since I don't have a g tolerance, there's not much really to rate here. The maneuver is possible. There is no exceptional pilot strength or skill, and I did not exceed [unintelligible] [g]. I give you a longitudinal and lateral-directional HQR, but they don't mean very much since there's no criteria tolerance or task associated with them. The longitudinal axis: controllable, adequate performance obtainable, and is satisfactory. HQR of 1; pilot compensation is not a factor. Lateral directional: it is the first one I've given since I have been here. Lateral directional is controllable, adequate performance obtainable, satisfactory without improvement, and give it a 2. I ended up with some residual banking a couple of times. Pilot compensation not largely a factor. End of comments.

Pilot C. We did the $0.5g$ pushover and pullup to 1.5 without g in the seat-of-your-pants. It's difficult with a digital meter to set the g 's, but there's nothing inherently difficult about doing the task. The airplane pushes over at a nice rate. Then when you change to a pullup, that's very ... as predictable as I can expect using a digital g meter. Stopping it back at level flight again is no particular problem, nor is lateral directional to this maneuver. So, give it a Cooper-Harper rating here. We can certainly go right to is adequate performance attainable with tolerable pilot workload? Yes. Is it satisfactory without improvement? With the way the task is right now, that is certainly a yes. I'd say "good" with negligible deficiencies of pilot compensation is not a factor for desirable performance, give it a 2. Lateral is

essentially the same thing; neither one of those tasks are difficult.

Pilot D. Okay, Pilot D, December 7. We just did an inadvertent speed increase, 6050, and run 13. The task definition doesn't seem to make a whole lot of sense. We pushed over on the second one, I was almost at 0.5g and held it for the specified 5 sec, but we only got to 2.41 Mach. Not much of an overspeed. On the recovery, I pulled a little bit more than 1 1/2 g's, but to me it looks like, operationally, with the real light motion cues, it's not going to be a difficult thing to do. Particularly if we're looking at such small Mach overspeeds. And of course if you're looking at higher Mach overspeeds, we need to model what happens at those speeds.

Pilot E. Okay, this was the inadvertent speed increase, test card 6050. First comment is—run number 7. First comment—I guess—the one before was run number 6. Five. Okay, the first thing is that this is kind of a difficult Cooper-Harper standard to come up with. Basically the only performance standard is that you stay less than your maximum Mach number. So in that regard you make the pushover. I was able to kind of tangentially intercept the half a g pushover and sustain it there for several seconds before the 5 sec. The recovery to g and a half, I just about got to a g and a half about the time we were getting to the horizon, so I did a tangential intercept of the 1.5g limit also. It says, "evaluation basis: maneuver is possible without exceptional piloting strength or skill, without exceeding the guide Mach." And it certainly is, so I would say this maneuver: it is controllable. Satisfactory: adequate performance is attainable. Is it satisfactory without improvement? I would say yes and rate it a 3 longitudinally and a 3 lateral directionally. There really, essentially, is no lateral-directional effort here except maintaining wings level, and I did have a slight phi of 2/10 of a degree, so apparently I did not make a perfect wings level, and that will keep it from being a 2.

Task 6060, Two-Axis Upset

Pilot A. If you're using maneuvering out near the edges of the envelope in terms of engine restart and so forth, you ought to be requiring displacements and forces that are quite heavy. For instance, normal maneuvering should be very normal force, like in

pitch, if you're trying to keep the pitch within couple tenths of a g, very normal forces should be required for that, but if you're going out to zero or 1g delta, you should require some pretty heavy forces and some higher displacement on the stick. This is just my first reaction; I'm not sure I held that 3 sec to beyond 2.4, but the speed wasn't increasing all that fast. I initially overshot my 15° bank; it's quite a bit of scan involved between looking down at the 6° and up at the roll scale. That could be something to get used to.

It would seem that if you're concentrating on a gamma-controlled airplane, then perhaps some display concepts ... you might look at some display concepts around gamma; in other words, like a 10 sec or sometime time, a TBD time circle around the gamma, commanded gamma, that would be that rate of gamma change would give you some g 1 to 0 or some g. When you start moving gamma around, it gives you trend vector that would allow you to hold a constant g or something. Maybe it's a percentage of a multiple of a gamma circle, maybe 2/10 of a some size circle that has a vector inside it that would allow you to look at the gamma circle and see how fast you're changing it and how fast that relates to g ... if something like that appeared when you're pulling more than 2/10 of a g or something like that, so you can refer to it without having to scan some other place. That would be helpful in this maneuver. Also I find it difficult to look up at the ... maybe I'll get used to it ... looking at sideslip; it is quite a bit displaced from the gamma signal. So if I'm having to use zero sideslip, it scans quite a ways away. The maneuver is you quickly calibrate yourself on how fast you can move that pitch attitude, and you have to go quite slow on it, and I think the forces need to be little (heavier); you have to horse the airplane around to an extent that you're going to start throwing drinks and food all over the back end of the airplane. You ought to be using pretty heavy force, I would think, at that point in time.

Go through the rating on Cooper-Harper: I would say it's controllable. Is adequate performance attainable with tolerable pilot workload? I'd say yes. And is it satisfactory without improvement? Well, I guess I would say that the improvement would be ... I would say no, and so I would say it's on a Level II type of area. I would give it a 4 [with] minor but annoying deficiencies and most of those deficiencies are related to stick force per g, and having a very simple display

that allows you to regulate stick force per g when you're trying to make large pitch changes, and keeping the g 's within tolerance. I realize you can't simulate g 's in this simulator, and so you have no seat-of-the-pants feel except to a minor degree. Visually, I think g 's would be helpful or some graphical display of g 's.

Lateral directional: I think I would read it as a 5 in that there seems to be ... the forces were kind of heavy, and if there's no unstart, it's not a problem. If you do have any kind of unstart or asymmetry, then there's quite a large rudder force involved in coordinating the airplane, and also, actually, the rolling and turn coordination at high speed seems to need some improvement because of the large rudder force required to keep the side loads down ... keep it coordinated in a rolling turn at high speeds.

Just for very slow, gentle turns left and right, it appeared as though full rudder was required in this here. The way the controls are set up, it takes ... to get on the stop ... it's right around 70 to 80 lb, I think—might be 100—it's about 80 lb of force and just very shallow, slow, and gentle turns of 10° to 15° bank left and right, roll rate of maybe 1° or $2^\circ/\text{sec}$. It takes full rudder initially, and then that's too much and it overre-bounds. Once the bank angle is established it's too much rudder so it has a little bit of a funny characteristic. Maneuvering, you'd have to be reasonably coordinated; you want to be very, very slow and gentle in the roll in and out. It looked like about half of punching a full rudder gives you about half of scale in the side-slip—side-force indicator—in terms of g 's. I guess that's all the comments I have.

Pilot B. Comment for run 68, task 6060, two-axis upset. Task is from straight and level flight to pullup to about 12° pitch attitude, but it decelerated about 2.3 Mach and then recovered down to 6° below the horizon and 15° bank angle at 3 sec past Mach 2.4. Recovery using no more than $1.5g$ to level flight and straight flight. So really, what I'm looking at is the ability to track bank angle during the pushover and to track g during the recovery, keeping in mind there is no real good g gauge. It is strictly a digital gauge, so it's kind of hard to separate the flying qualities in terms of the airplane from the display. Okay, in summary, not much of a problem from an aircraft standpoint. A bit of a problem in prediction from a g standpoint, and

let's see I'm allowed $\pm 0.2g$, and the scorecard says it is adequate, meaning it was a little bit over 0.2 but less than 0.5. And the bank angle was 15.3° , yeah, so one side of the error anyway was 0.3° . I didn't feel I had a problem with that. Okay—longitudinal: it is controllable, adequate performance is obtainable, and I am going to give it the benefit of the doubt here because I don't think it is as bad as a 5. I wouldn't say it is moderately objectionable. I would say that it's minor but annoying and give an HQR of 4; desired performance requires moderate pilot compensation. As far as bank angle control: not really a problem. It's controllable, adequate performance obtainable, to satisfactory, and I would say pilot compensation largely not a factor, give an HQR of 2. End of comments.

Pilot C. A banking, a pullup first, followed by push-over in a 15° bank. Once you pass 2.4, then recovered to 2.4 again. The task is relatively easy to execute with the exception of just having a digital g meter instead of an analog kind of meter and with those feel in the seat-of-your-pants—it's a little difficult to get the exact g 's. But I can extrapolate relatively easy with a g meter or with g 's in the seat-of-your-pants. The task is no particular problem either, in roll or in pitch. Is adequate performance attainable with a tolerable pilot workload? Yes. Is it satisfactory without improvement? I'm going to give it a minor but annoying deficiency; desired performance requires moderate pilot compensation ... 4 ... and it takes a little bit of concentration from the pilot to make sure that it's done in a smooth way without large excursions in g and banked angle, so I'll give it a 4 for longitudinal. From a lateral direction on a banked angle is easier to control than the pitch. So it would be satisfactory without improvement, and there is some mildly unpleasant deficiencies. Minimal pilot compensation required for desired performance is a 3. Unpleasant deficiencies can feature a little nicer onset of the roll rates of what we have exactly now.

Pilot D. Pilot D, December 7, two-axis upsets, 6060. We only had one run. It's a very mechanical procedure. Pitch-up to 10° , down to minus 6, roll 15, hold 8 sec, and recover all shooting for 0.5 on pushovers and 1.5 on the pullups. I kind of leaned to stick force for g here, so we came reasonably close even with the digital on the g scale. It's such a mechanical task, it's kind of hard to get a rating that really means anything. But it's either 4 or 5. Let's see, let's make it a 5. I

would like to have an analog g scale. Pilot D again. The 5 is longitudinal. The lateral, there doesn't seem to be any problem. Let's make it a 3.

Pilot E. Okay this was run number 9 and test card 6060, the two-axis upset. Again, a fairly straightforward maneuver. Just pretty much cookbook approach, go by the book, and doesn't [do] too badly. The interesting comment: when you try to accept a half a g pushover, it's a very, very, very slow gamma rate that gives you that, and you almost ... becomes imperceptible to hold the half a g . It's fairly easy to go down to about 3/10 of a g until you kind of dampen out and kind of stabilize a little bit, but not a bad task at all. And the recovery is very easy. Is it controllable? This is for longitudinal rating. Yes. Is adequate performance attainable? Yes. Is it satisfactory without improvement? Yes, for a 3. Lateral directional: is it controllable? Yes. Is adequate performance attainable? Yes. Is it satisfactory? No. I'm going to rate it a 4, and the reason being, on the recovery, it tends to be a little bit oscillatory about 1° or 2° of ϕ about zero, and it seems to be not real stable. For some reason, that Mach number ... as you're pulling up you tend to, either because you, we need to perhaps fine-tune the pitch roll harmony in the control stick or whatever, but I did tend to excite the roll axis a little bit and get about $\pm 1^\circ$ or 2° ϕ oscillations. Now, I don't know if that's a control harmony problem with our control law lateral directional and longitudinal control law, but you're obviously coming from different sources or whether it's our stick or whether it's aerodynamic, I cannot tell, but at any rate, that's what appears to the pilot is a slight roll instability on the recovery.

Task 7010, Directional Control With One Engine Inoperative

Pilot A. You might not have been getting much on that previous run. Okay. So, on the longitudinal Cooper-Harper: it's controllable. Pilot workload is tolerable and satisfactory without improvement? It's either a 4 or a 3. There's a certain amount of workload involved in maintaining level flight. Let's call it a 3. Lateral directional: is it controllable? Well, that's a question mark, because when you release the ... first time I did it, I went up and it seemed to be smooth, but when I released it, there ... was on the verge of losing control. So I have to give that a—I guess a 9. Mainly because of the recovery from the sideslip ... seems to

be especially when you're pushing the rudder on the good-sided engines—number four out and pushing left rudder. The recovery was a real wild ride. If you release the controls, it seems to eventually settle down, but obviously that's a kind of PIO that's produced. Okay. (Okay, that was a 3, a 9.)

Pilot B. Comments, run 72, test 7010, direction of control in one engine inop. Task is a flat turn basically left and right at 15° in 15 sec with the right, outboard engine inop. Outboard, yeah. Going to the right and back, there is a problem in maintaining bank angle control and rate of sideslip control in terms of predictability, but it is essentially doable. Going to the left is a fairly significant problem on the return. The lower left, you get the max sideslip when you are coming back. If you let the sideslip come out too quickly, you tend to get bank angle excursions that saturate the lateral axis, and there's impending loss of control in that. Longitudinal axis is not much of a problem except that you don't have as much time to concentrate on it because of the lateral-directional task, so that would be the only thing that would cause degradation there. Okay ... longitudinal HQR: it is controllable; adequate performance is obtainable. However, I am working. I would say desired performance requires moderate pilot compensation—give an HQR of 4. In lateral directional axis, it's controllable but I would say that intense pilot compensation is required to retain control—give it an HQR of 9. Four and 9, yes. Okay, that concludes the comments.

Pilot C. Item 7010, which is $\pm 15^\circ$ of heading change with one engine out. We're to evaluate the handling qualities during wings-level heading change with an outboard engine failed. This task is quite difficult to do, and unless you do it very slowly and deliberately, you have a good chance of losing control of the airplane because of saturation of either the rudder or the ailerons. The workload is quite high to keep the airspeed under control. There is less chance of getting to saturation if the airspeed is where it is supposed to be. However, still with the pilot flying it and the airspeed controlled, it's still quite easy to lose control of the airplane. So, is it controllable? My interpretation of this maneuver where we go $+15^\circ$ one way and $+15^\circ$ the other, I would say yes, it is controllable if you go slow enough. Is adequate performance attainable with tolerable workload? No. And major deficiencies, considerable pilot compensation is required for control—it is

an 8. And again I think I described it problematically well there. There's no pitch and roll left to do, just the one Cooper-Harper? The longitudinal and the lat dir: well, the longitudinal is not there. That was Cooper-Harper rate: is for the lateral directional. Pitch axis: is it satisfactory without improvement? I would give that a, say yes. And fair to mildly unpleasant deficiencies; minimal pilot compensation required for desired performance, a 3.

Pilot D. Pilot D, on December 7. We just did a one engine inoperative, outboard, directional control task of 7010. We ended up on run 18. The task is to make a flat turn, using the rudder, 15° in each direction. We are allowed 15 sec; typically we were taking 12 sec. The technique I was using is just "hands off the stick." This lets the control system hold gamma and phi within limits. Then I was using rudder, obviously, and the largest task is trying to hold the airspeed with the throttle. It diverges fairly fast, and you get a large displacement between the two display elements. You are looking at the waterline and the heading box and the flight path where the airspeed is indicated. Pilot ratings—a little hard to figure out exactly what to do. Longitudinally, pilot ratings—the only task there—the only part of longitudinal I'm doing anything on is the speed. And it's got some moderately objectionable deficiencies. We don't have any performance criteria, but the workload is pretty high trying to hold the airspeed. Let's give it a 5, and laterally all I'm doing is pushing on the rudder pedal ... is yawing. The control bank angle and again pretty high rudder forces ... not as bad as we had supersonically ... those are pretty big yaw angles. Actually not too bad. Let's give it a 4.

Pilot E. Okay, that was run number 10, 11, and 12; it was 7010, directional control of one engine inop, and I need longitudinal and lateral-directional rating. In general, this was one of those interesting maneuvers where, if it's done smooth enough within the desired criteria, you can accomplish the maneuver and not depart the airplane or lose control. If you try to be a little bit aggressive, especially at the reversal point, where you go from feeding in full right rudder to feeding—in a great deal of right rudder to feeding in a great deal of left rudder. If you're not very, very smooth and slow, at that point it will get into probably a rate-limited roll PIO, which, since you end up getting rate-limited, it can easily go divergent and you would depart the airplane, lose control. So the ratings

for lateral directional: if you are a teeny bit too aggressive, it would be a 10. If you are smooth, you can still meet desired criteria and not depart. So it's a real cliff right there based on how rapidly you feed the rudder from one direction to the other. Longitudinal rating: is it controllable? Yes, it is, longitudinally. Is accurate performance attainable? Yes. Is it satisfactory without improvement? I would say no. There is no really longitudinal—yes there is—±200 ft. I'm not really sure—what's my altitude? Okay. I was within desired, but it is a high workload longitudinally, so I'm going to rate that a 4. Lateral directional: is it controllable? Yes. Is adequate performance attainable? Yes. Is it satisfactory without improvement? No. Even though I don't think I really met the desired overshoot, but I'm saying the workload is going to be such, so I'm not going to give it a desired rating. I'm going to rate it a 5/10. The 5 is if you are smooth; the 10 is if you reach a point where you're slightly more aggressive on the rudder reversal, it will depart and you will lose control.

Task 7020, Lateral Control With One Engine Inoperative

Pilot A. And this is heading ... run 43, and heading changes left and right 30°, 7020 is the task and longitudinal Cooper-Harper is ... it's pretty easy. I'd give it a 2 and the lateral-directional Cooper-Harper ... really, it's quite easy too and there's no problem there. I'll give it a 2. And the biggest problem there is throttle friction and maintaining speed.

Pilot B. Task 7020, lateral control with one engine inop. Basically from straight, level flight, 20° angle bank to the left and then a reversible angle bank to the right, performed level without a throttle drop, holding speed within 5 knots. Holding time to roll between 5 and 10 sec, with a target of 5, altitude within 200 ft, overshoot within 2°. Probably the most difficult of this tolerance is the overshoot within 2° with the faster roll rate. In terms of anything else, not much of a problem really. It's controllable, adequate, and sat longitude and minimal pilot compensation, HQR of 3. Lateral directional, very much the same thing: controllable, adequate, and sat, with minimal pilot compensation, HQR of 3. That concludes the comments.

Pilot C. That is 7020, and ... the item number ... and it's a 20° bank, 30° of heading change, plus or minus.

The task is a moderate level of difficulty to do smoothly and without oscillations. The parameters can all be met. Is adequate performance obtainable and tolerable pilot workload? We answer that yes. Is it satisfactory without improvement? My tendency is to give it, in a pitch axis, satisfactory without improvement? No, with minor but annoying deficiencies, desired performance requires moderate pilot compensation ... a 4 ... and just a little difficult with the displays we have to keep the altitude as nice as you would like to be able to do it, and it ... results are kind of jerky ... motion and the pitch input ... in order to fly with the task. And for the roll axis, adequate performance is obtainable with a tolerable pilot workload, and is it satisfactory without improvement? Essentially it's the same kind of comments as for the pitch axis. Minor but annoying deficiencies and desired performance requires moderate pilot compensation. I noticed that, as I tended to roll out on both of these, that my roll was not real smooth. Near the end it tended to be abrupt as I tried to settle in the proper heading in a zero bank angle. And also, another thing I noticed in both cases, when you end up on heading, you end up with a commanded ... flight-path marker command that is not centered over the heading, as you end up with some residual beta no matter which direction you go.

Pilot D. Pilot D on December 7, task 7020, one engine inop. We're making a 30° heading change with a 20° bank, and we want to have the roll to the 20° in less than 7 sec for desired. Just a couple of comments. It's really not too bad. As I commented earlier on the landing approach stuff, the roll tends to drift a little more than I would like to see it after you release the stick. It's a very long time constant to come down to snub down the roll attitude. And so you have to lead it quite a bit [which] increases the workload there. Airspeed as on the previous one is backside and pretty hard to control, although the display here is a little better. We don't get the large sideslip angles, so at least the elements you're looking at are on the same part of the display. Pilot rating. Longitudinally, the airspeed control is the primary one. Let's make it a 5. Laterally, the roll overshoot, or the lower snub time—the long snub time constant there—let's make it a 5 also.

Pilot E. Okay, that was run number 15, 7020, lateral control with one engine inop. Not a bad task. I thought I did really well on the altitude control, sacrificing

possibly several knots of speed for altitude. I noticed in the turn there was some sustained sideslip displayed. I kept my feet pretty much on the rudder pedals but I did not put any rudder in and I accepted that slight sideslip. The ability to predict the rollout and capture a heading was not terribly difficult. Obviously your attention is divided between maintaining speed with the back side airplane, which does take a lot of effort and altitude, and capturing your heading. The HUD is excellent for this task. It provides all the information you need. The roll in—the bank capture—is pretty good. It does take a certain amount of effort. I was trying to roll in fairly aggressively. On the last one, I think I was getting to 20° in about 3 or 4 sec, the way I was counting. So for longitudinal: is it controllable? Yes. Is adequate performance attainable? Yes. Is it satisfactory without improvement? Yes, a 3. I think my heading—my total altitude loss—was on the order of single digit, and we're allowed 200 ft. So obviously I was able to stay well within the desired on that, for whatever reason. I attribute it to the gamma command control law. Lateral directional: is it controllable? Yes. Is adequate performance attainable? Yes. Is it satisfactory without improvement? No. I'm going to rate it a 4, mainly because of the workload. The holding—capturing the bank angle and holding it—does take a certain amount of effort. If I ... I think if I got into the rudders, it may have complicated task, so I chose not to do that. So, a little bit more effort in the lateral axis.

Task 7030, Minimum Control Speed—Ground

Pilot A. [No pilot comments recorded since no Cooper-Harper ratings were collected for this demonstration task.]

Pilot B. [No pilot comments recorded since no Cooper-Harper ratings were collected for this demonstration task.]

Pilot C. [No pilot comments recorded since no Cooper-Harper ratings were collected for this demonstration task.]

Pilot D. Pilot D on December 5th. This is task 7030, which is V_{mcg} ground, with no nosewheel side forces. Continued thrust. The last run was run 25. The engine cut was at 127. On the first run I made, not knowing what direction I was going to be—and so there was a little of reaction time there—I got 62 ft off; the next

two, I had 30 to 35 ft. I feel the 127—based on the fact that we were trying to keep it under 30—is maybe just a little bit slow, but it’s in the ball park.

Pilot E. [No pilot comments recorded since no Cooper-Harper ratings were collected for this demonstration task.]

Task 7035, One-Engine-Out Takeoff

Pilot A. Comments on run 29. Engine failure at V_1 , looks like about 6° of yaw or sideslip, to counteract, hands-off, steady-state, wings-level condition. Momentarily, I was looking for the commanded flight-path vector; it was slightly out of view in the bottom of my windshield. I had to raise up in the seat to see it. When we rotated, we came very close to a tail-strike situation. I wonder whether we ought to consider some kind of pilot cue or visual tactical cue or some kind of deterrent to tail strike by increasing force so that you don’t inadvertently get a tail strike. I think I was very close. Did we in fact get a tail strike? I was trying to follow the guidance. What I’m doing is blindly following the guidance; what I probably would need to do is follow the guidance to about 8° and look at $10\ 1/2$ and see where that’s at and then come up and stop on it. The only thing that seemed a little unusual about the takeoff is how close I got to a tail strike. I don’t know how far away it was ... within a couple tenths of a degree ... and the other thing, it seems like there’s a lot to sideslip.

Pilot B. At the engine failure, you’re going to get some deviations. You have to work hard to get it back again. So I think the adequate is consistent to what I’m seeing. Of course, this only has to be Level III, because it’s an emergency type situation. Desired, ± 10 ; adequate, ± 27 . We’re at 17.6 maximum. Desired throughout most of the run. I’ve talked about that before. So for the directional Cooper-Harper rating: it’s controllable; adequate performance is attainable. So we’re actually in the Level II area. Considerable ... moderate to considerable ... but you guys aren’t going to let me give half readings here ... that spreadsheet won’t do it. Call it considerable pilot compensation and give it an HQR of 5, with the caveat that it’s probably something less than considerable. Directional tracking on runway centerline. Takeoff rotation promptness—it is relatively prompt—plenty of control authority. Easy to establish liftoff attitude and rela-

tively easy to capture the pitch attitude. The throttles are at full, so I’m not really capturing airspeed here. Tail strike did not occur to my best knowledge. Do you have any numbers here? I’ve broken the code on what it’s looking for. I didn’t have a problem with longitudinal during the rotation. The lateral directional: I guess the problem here is scanning. I don’t find beta indicator intuitive at all. I’ve seen flags that get put on the vertical tail of the velocity vector, used in the past. I’ve seen little balls that appear below the velocity vector going back and forth. Some of those are a bit better. The fact that you have to look in two places to control the aircraft and the fact I don’t find that triangular cue peripheral—I don’t find it intuitive. You have to interpret it. So that’s what’s primarily causing the lateral-directional problems. I don’t have a directional task, do I?

I don’t have a lateral-directional task here do I? But I’m not tracking the centerline at that point. I’m not even looking at it at that point.

On the other hand, as soon as I raise the nose, the runway kind of goes away. There’s a problem here with what we’re doing.

I’m going to give you a Cooper-Harper based on $\pm 2^\circ$ of banking control. That seems to be the knee of the curve of where we have tail-strike problems close to the ground—at least, close to 10° pitch attitude. My lateral directional for rotation is going to be based on desired of $\pm 2^\circ$ and an adequate of $\pm 5^\circ$, just for lack of a better number right now.

Did I already give you a longitudinal? That was relatively easy. Longitudinal is controllable, adequate performance is attainable, and it’s satisfactory without improvement. I’d say minimal pilot compensation required for desired performance. For lateral directional: I’m really working in the directional axis and the lateral axis to maintain. If I can give you two different Cooper-Harpers, I probably would for lateral and directional, because most of the compensation is in the directional axis. I don’t have a problem maintaining bank angle laterally. Directionally—and again, I don’t have a task here—to maintain the target somewhere near the center within, let’s say, 20 percent of the width of the indicator to the center, I’m really working hard. So it’s controllable; adequate performance is attainable; but I’d say considerable pilot compensation required. So directional axis and HQR of 5 with the task I just made up ... the two tasks I just made up. Lateral, if I were to split it out is going to be

more like a 2. Negligible deficiencies, relatively predictable performance, 5. Make sure I say the same thing. It's controllable, adequate performance is attainable, satisfactory, minimal pilot compensation, let's give it an HQR of 3. The climb phase during reconfiguration—and it's not reconfiguration for noise abatement—you can strike that out there. It's just during reconfiguration. No objectionable transients. Longitudinal again: relatively easy to follow the track. Lateral: relatively ... well it's not as easy as it was before, because it's a combined lateral-directional task. Maintaining the guidance symbol requires a lot of workload, consisting of very frequent recorrections and rudder inputs and relatively frequent lateral inputs to center the guidance. So it's controllable; adequate performance, I think, is attainable with a lot of work. So I'd say considerable pilot compensation again and give it an HQR of 5. That was lateral directional. Longitudinal is controllable; adequate performance is attainable. Satisfactory longitudinally. With an HQR of 3, with some un ... mildly unpleasant deficiencies and minimal pilot compensation. Just cross-checking the longitudinal inputs. There is a link between lateral directional and longitudinal. The longitudinal task is degraded somewhat by the workload than lateral directional axis. That was run 45. That concludes the comments.

Pilot C. Run 12, and it's item 7035—one-engine-out, takeoff, past V_1 . For the runway centerline tracking, I thought the task was relatively easy after the engine failed. I was able to jump on the rudder pedals. It was a little jerky in side force as I brought it back to the center, but there was good positive control and I felt quite good about that. It was quite easy to accelerate to the rotation speed, and the rotation to liftoff [was quite satisfactory]. Let's talk about the rotation. So basically, on the ground I thought it was quite good. Is it controllable? Yes. Adequate performance attainable with tolerable pilot workload? Yes. Is it satisfactory without improvement? I'm going to give a Cooper-Harper of 4. Minor but annoying deficiencies—desired performance requires moderate pilot compensation. And that's a little bit of a sensitivity there ... rather accumulative. Not a very smooth way to get good, positive control without being jerky.

OK. I am back on again and it's still run 12, and we are evaluating the takeoff rotation for item 7035. I thought the rotation was relatively easy. It seemed like a little slower than for the no-engine-out case and

therefore tended to be a little easier. It was easier to establish the maximum pitch angle for the rotation. And then, because things were happening a little slower, it was easier to transition to flying the meatball after liftoff. So all in all, in the pitch axis it was quite successful. Certainly adequate performance with a tolerable workload, and it was satisfactory without improvement, I'd say. Yes. There are some mildly unpleasant deficiencies which I have ... a little difficult to describe. But I can imagine it being a little smoother getting to that pitch attitude. It's a Cooper-Harper of 3. And lat dir, for the same circumstance here ... no particular problem with ... how did the beta look there? Do we have a ... for the rotation? During the rotation, it was keeping the beta indicator centered. My impression of it was ... easily desired performance, anyway. Had no particular problem with that, so I give that a Cooper-Harper of 3—that's along with the pitch axis. I'm happy with a Cooper-Harper of 3 from this point. On the climbout part here, I guess my comments are similar to yesterday with the little magenta meatball. Flying the airplane throughout that departure is no particular problem, and it seems to me, just to ... easily meets desired performance, although the effort it takes to keep the meatball exactly in the center is more of a workload than I think we need to do a really nice job with the airplane. So I have a little misgivings about it. But, is adequate performance attainable? Yes. Is it satisfactory without improvement? No. And my minor but annoying deficiencies give it a Cooper-Harper of 4. Just the workload and concentration it takes to do the meatball task in order to do the desired performance. I suspect it's because the display could be better somehow, to relieve that problem—or change the criteria—because it looks to me like that's a perfectly good job we are doing. Basically, the same comments are for lateral directional also, because it's just chasing the meatball again. So, same Cooper-Harper rating for it.

Pilot D. Okay, Pilot D, December 5th. This was an OEO—one engine out. Task 7035, last run was run 22. It's really no big problem. The asymmetries associated with the engine outs aren't that big on the ground or in the air. On the last run there, I started the second rotation just a little early and I think that's why we blew the desired pitch attitude. I'm only making adequate on the lateral deviation. I kind of feel it's because I don't have that nice runway centerline, and I'm not having time to really concentrate on the runway centerline, and I felt I was doing a reasonable job but for

getting out to the order of getting out 20 to 25 ft all the time. The rudder control is fairly natural. Don't have any really big problems there. The sideslip display is a little bit out of the field of view, but because the rudder is so natural, you have time to look at it. So let's go ahead to the pilot ratings. On the centerline tracking, there's really no difference between that and the ones without failures, because the failure is coming right at rotation. What was I getting? A centerline tracking is a 3 because of that slight PIO tendency in heading that the vehicle has. Okay, now for the rotation task. Longitudinally: it's not too bad. Again, I think it's very similar to the conventional takeoff. In fact, maybe a little bit easier, although you have less time to concentrate on it because you're concentrating on the lateral task. I think it's still on the order of 4, primarily because it's a fairly complicated display to use there. Four, longitudinal. Now comes the tough one. The lateral for the rotation, and that of course is the biggest task of the whole maneuver here. It's definitely adequate. Yes. Is it satisfactory without improvement? I would almost say yes, but we're not obviously making the performance for that. In fact, I'm down to a 5 for performance. Let's give it a 5 just based strictly on performance. From workload, the naturalness of the rudder control, everything else, I would tend to say that it's satisfactory without improvement. Maybe marginal there. But because of the performance, we're giving it a pilot rating of 5. Okay. Climb: a little bit easier if anything, longitudinally. Because we don't have any thrust cutback, and we don't have to rotate such high gammas and everything, it's almost like the acoustic one, but a little bit harder. I think, let's still give it a 4. I'd say primarily it's a flight director problem. Flight director is 'cause, up and down, up and down, up and down ... trying to chase them. Let's make it a 4. Laterally, it's not too too bad. Once you get the trim for the engine-out in, which is the case here. Is it satisfactory without improvement? I'm up that far, so it's yes or no there. I was doing okay in the performance, so I do have desired performance. Yeah. We made it. Definitely and particularly laterally. Okay, yeah, it's really pretty good. Let's give it a 3. I guess I could use a rudder trim tab here, which we have, which I haven't been using here. Does it work? Let's give it a 3. Okay.

Pilot E. Okay, task 7035, one-engine-out takeoff. The rating's for the runway centerline tracking. I am going to include this up to the engine failure, I believe. The takeoff rotation will include the engine failure. It's my

lateral-directional Cooper-Harper would be in line with what I've done with the previous takeoff. Obviously the task was controllable. Adequate performance was obtainable. Satisfactory—improvement? Yes. Again, a Cooper-Harper of 3, because there is compensation. And I noticed that I really am having to work above 100 knots with very, very kind of high workload, very, very small inputs to keep it on the centerline. When I say high workload ... high workload in a typical workload I am used to flying is much more directionally stable, not quite so sensitive just prior to rotation speed. The takeoff rotation ... this is where I have the most problems maintaining ... right at rotation ... maintaining the directional criteria within ± 10 ft, and we were able to in the last one. The reason I was, because I was anticipating putting in left rudder at the engine failure, which, typically you're not going to be anticipating engine failure so you would not be keyed, so in a way I trained myself to doing better. With that in mind it was, the task was controllable. Accurate performance was obtainable. Satisfactory without improvement? This is the lateral-directional Cooper-Harper I am talking about now, and I am going to say no and give it a Cooper-Harper of 4. I did meet the desired criteria but I think the ... when you lose the engine, the airplane does tend to fairly quickly diverge out of the desired criteria. Now, I am not necessarily saying that criteria is maybe a little bit tight criteria, but maybe I am looking strictly at criteria performance; then I will have to go with a 4 on that. Ten ft is pretty tight tracking for an engine failure for an airplane like this, I would think. For longitudinal Cooper-Harper, also the overall higher workload of holding rudder and try to maintain directional control, I tended to overshoot the limit borderline guidance there a couple of times, and I finally had to concentrate hard to keep that from happening in the last one. So I am going to also say the workload has increased on that task. Aircraft is controllable, adequate performance is obtainable. Satisfactory? No. I am going to rate that a Cooper-Harper of 4 also. So longitudinal, lateral, were both 4s for that. The climb with the configuration changes—that was very, very easy, relatively speaking, compared to the rotation. For longitudinal: is it controllable? Yes. Adequate? Yes. Satisfactory? Yes, 3. It does take pilot compensation, but the numbers for the one I took out to 6 miles were almost 100 percent, so I guess you can't complain about that. Lateral directional is very—almost identical—near 100 percent of desired scores there, so

that would also come in with a 3 and not any higher than a 3 because of the compensation that was required.

Task 7040, Minimum Control Speed—Air

Pilot A. Okay, I'm looking at 7040 and run 47. Question for longitudinal Cooper-Harper: is it controllable? Well, that depends on whether you start bumping up against 20 plus on the alpha for whatever reason. I can't really tell you within 5° heading change. It probably did. So I think we have more than that, so I don't really think we really made adequate performance. It is controllable? Adequate performance attainable with tolerable pilot workload? Probably not. So it's a Level III type of rating, with major deficiencies being displayed. I would say it's somewhere between a 7 and a 8. I would give it a 8 primarily because of the ... in longitudinally ... there seems to be wild swings in actual gamma versus commanded gamma. And there's a tendency to drop off the edge when you go to high, very high alphas ... tendency for the control law to take you into a stall unless you actively, aggressively avoid it, and trying to hold a constant speed at that point requires constant pitching down, basically. So it's a highly dynamic maneuver. It's very difficult to stabilize on it at 120 knots. When engine's cut, the response ... it isn't apparent that anything is happening for about 2 to 3 sec; then there's a slow need for some rudder and then pitching to recover is fraught with tendencies towards PIO. Okay, lateral directional, is it controllable? Barely. I guess I never lost control, so I have to say yes. Is adequate performance attainable with tolerable pilot workload? And probably, no—Level III, major deficiencies. So we are talking about, I would say, [CNR] 8. You are having to actively release the stick, to get the airplane to recover. The quickest recovery is simply release the stick so you are actively trying to do something with the airplane, and you are going straight into a PIO, it seems as though. Okay.

Pilot B. Task 7040, minimum control speed—air. The technique was a somewhat normal takeoff, except after takeoff, the pitch-up to about 35°, full throttle, a lot of airspeed decayed to 120 knots, and then fail the right outboard engine. The technique that I settled on was to lower the nose fairly quickly and to be less quick about trying to settle the beta down. When I did that I was able to control it fairly easily. The one time when I tried to get beta corrected fairly quickly while

we were at the lower speed and before the nose had come down, I got out of phase with the beta and I was getting a rate limiting in the lateral axis. When you get into rate limiting it takes intense pilot control to maintain control ... intense pilot compensation ... you are talking about an HQR of 9 there, although I was able to maintain control throughout. When you use the second technique that I used or when I used the second technique that I used—being to get the nose down quickly and to smoothly reduce the beta instead of trying to do it quickly—it was much more controllable, and controllability was not an issue at that point. Okay, so with that caveat in mind and obviating the one case when I had to fight to regain control, longitudinal HQR: it's controllable, adequate performance is obtainable, satisfactory without improvement—well there is moderate compensation in the pitch axis. This is a fairly intensive pitch-pitch type task, so I am going to give it an HQR of 4. Now hang on ... give it an HQR of 3 with minimal pilot compensation. That is clearly Level I; it's not Level II. Sorry about that. And then lateral directional: it's controllable, adequate performance is obtainable with extensive pilot—no, call it considerable pilot compensation. I am going to give it an HQR of 5, because you are fighting in the lateral axis. That concludes the comments.

Pilot C. Run 30, item 7040, evaluate maximum centerline deviation. On this particular maneuver, I'm not sure that I really have a good idea what it is we are trying to achieve with it. But during the maneuver the way we did—pulling up to 35° and getting it to slow down to 120—and if you fail two engines then ... if you lower nose and you don't lower the nose enough so the beta builds up, then start chasing after the beta, you can experience a roll PIO as you try to keep the roll axis under control. If you leave the nose too high and the beta builds up and you just chase after the beta with your rudder pedal, then eventually the airspeed decays and it departs again. If you are more prompt to lower the nose—and I would say a large amount, like 30° or 40° of pitch attitude—then the beta stays mostly under control, and you can fly it easily and maintain the heading where you would like. I'm going to give a Cooper-Harper rating now. Is it controllable? Yes. Is adequate performance attainable with a tolerable pilot workload? I'll say yes. Is it satisfactory without improvement? No. I'd say moderately objectionable deficiencies, and adequate performance requires considerable pilot compensation. It takes a lot

of concentration in the simulation here to be able to do this maneuver successfully without getting out of parameters. So we'll give it Cooper-Harper of 5. And that's in both, I think: Cooper-Harper 5 in both lateral and pitch axis.

Pilot D. Pilot D, December 7. Did a V_{mca} takeoff at 120 knots. The climb angles are pretty spectacular at that condition. Comments—correction—that's task 7040, and run 24. The comments are ... it's pretty hard to control pitch attitude, which is what you're really doing on this kind of task with a gamma V control system. It really increases the workload significantly. Data control is a little ... is pretty hard here ... probably easier when you have ... if you have motion cues to help warn you that you do have some sideslip, and then heading control is hard to do after losing the horizon. You have to rely on the little digital number, whereas in real life ... well, I guess it means you wouldn't be able to see outside. You might have better visibility in real life. But with those comments, let's give it pilot ratings for longitudinal—I think as far as performance went longitudinally—I probably wasn't too bad on the performance longitudinally, but because of the control system characteristics I'm going to give it a 5. Laterally, I was probably adequate on the performance criteria, which kind of goes along with the ... I was adequate on performance but I'm going to ... which is consistent with a 5, which is what I'm going to give it for the beta control—sideslip control. So 5, 5.

Pilot E. Okay, run 16, 7040, minimum control speed—air, basically just a demonstration of the 120 knot. We actually end up getting a little bit below 120, because I thought I had my seat full up. It wasn't quite full up. At the high angle of attack approaching 120 knots, I lost the velocity-vector airspeed and altitude display underneath the glare shield and I had to kind of use one hand to hold myself up to see if that resulted in some pitch bobbling, which in fact then put us below 120, about 5 knots or so. So the recovery still was smooth. I didn't have any departure. I probably oscillated back and forth about, oh maybe 2° to 3° to 4° angle of bank, but around 5 or less and my heading deviated no more than about 3° , so that was desired also. So I met desired in both of them. We're electing to move on rather than try to really nail that, because on the first pass it seemed to be desired criteria. Pretty easy to accomplish even though I got slower than desired. So longitudinally: is it controllable? Yes. Is

adequate performance attainable? Yes. Is it satisfactory without improvement? Yes. I would rate it a 3, with a caveat that we're trying to do a theta command task with a gamma command control law. So trying to hold the 35° theta and then the 27° theta takes some effort because we're commanding the wrong ... we're trying to ... we're commanding the wrong thing for what we're trying to hold. So that—we'll accept that. We know that's not really a problem there. That leads to a little bit of the pitch bobbling. I'm not going to let that affect my rating on the overall aerodynamic configuration. For lateral directional: is it controllable? Yes. Is adequate performance attainable? Yes. Is it satisfactory? Yes. I'll say a 3. It's borderline 3 to 4 and I think aerodynamically I'm probably going to ... leaning towards ... I think we could tailor the control law to feed in kind of a little bit of ... with the smart system like we have ... to feed in some rudder to negate the sideslip. I think that would be the directional axis, 'cause it'd certainly be enhanced—optimized—but aerodynamically it'd certainly have all the control power you need. It's just a question of learning how to do the task. So I'll say 3 and 3. The lateral 3 is borderline Level I and Level II. Editorial note: Lou Glaab informs us that we maxed out the rudder authority on that one. I didn't realize that. We have no way of knowing, as Bruce let me know, so basically when I say we had plenty of control authority, I need to modify that to say, to the pilot it appears that I had enough control authority when in fact we were starting to run low, which would have meant I probably would have rolled off and exceeded my angle of bank. But still, to my perception I'll leave it as a 3, with my caveat it was Level I to Level II for lateral.

Comments for Task 7050, Dynamic V_{mcl-2}

Pilot A. Okay this is task 7050, dynamic V_{mcl-2} , last run number was 19. I think the dynamic V_{mcl} is kind of a small ... like you should label this “test engine failure” during the approach, because you're not really using max thrusts on the other engines, so you're just holding speed. Longitudinal Cooper-Harper: is it controllable? Yes. Satisfactory without improvement? Adequate performance attained? Yes. Satisfactory without improvement? Yes. And I really had no problem with the flight path—the pitch control—so I guess I'm going to have to give it a ... once I came up to a learning curve ... I'm going to have to give it a 1, longitudinal. Lateral directional was not a super demanding task—didn't get full thrust in or full rudder in. I

used a little more inboard throttle than outboard—by about a knob width. Is it controllable? Yes. Adequate performance? Yes. Satisfactory without improvement? Yes. And in this particular task, I don't see any real problem with it. I give it a 1. Let me backtrack a little bit. There is the requirement, you know ... how much ... exactly how much rudder to put in to optimize performance. At first I put in too much. I think that there needs to be some obvious indication of when you've got the proper amount of rudder in. The alignment of the indices at the top perhaps is ... I guess that that's sideslip ... then that's probably a good combination to use. So in retrospect, I guess if I had more time to use that—apply that tool—that would probably be satisfactory. So I'll give it a 2, for lateral directional.

Pilot B. Run 65, task 7050, dynamic V_{mcl-2} . The task was to maintain 3° glide slope and bank angle and heading deviation and deviation in speed with a second engine failure on the right-hand side. Summary: the only anomaly that I noted was that ... the requirement to lead the correction with bank angle. When I tried to leave the bank angle at 0 and correct the rudder alone, I developed a fairly large side slope angle with no corresponding yaw rate, and I can't really explain that, given that the steady-state bank angle with—or the steady-state sideslip with—0 bank was fairly low. So you would think that any additional side slope would have generated a flat turn, and it didn't. So I'm at a loss to explain why. However, when I modified the technique to lead the correctional bank angle it was fairly benign, given the situation of two engine failures on the airplane. So you just want one HQR for both longitudinal and lat dir. In terms of performance, max heading deviation and max bank angle, I thought, was relatively easy. Certainly 10° of bank angle is a lot, and I was able to keep it within 5. I felt 5 knots of speed deviation was again no problem. So for the areas that we're talking about, I didn't have a problem, and let me give you the HQR for those, and then I'm going to talk a little bit more about something else. Longitudinal was controllable, adequate, and satisfactory, and mildly unpleasant deficiencies. Probably ... well let me think about this for a second. Yeah, given the workload increase, I'd say minimal pilot compensation for desired performance with mildly unpleasant deficiencies. Give it an HQR of 3.

For lateral directional, it was controllable, adequate, and satisfactory, but again minimal pilot com-

ensation—I can't say that it wasn't a factor for desired performance in those phases. Now, the last thing I wanted to talk about on this is a couple times I have noted when there's a need for a large correction, I'll make the correction, then go into rate limiting, so I feel like there's a rate problem in the currently modeled actuators in the lateral axis. When you do get into rate limiting, you start several cycles of PIO. Now the PIO goes away when you relax your gains, but the PIO is there, and you're going to find pilots that fly it that are going to get into PIO in the lateral axis. So I think there's lateral control authority and/or bandwidth problems with the actuators associated with the lateral axis. I can't tell you whether it's lateral directional or whether it's both, but in the lat dir axis there's a problem in terms of rate that you can get versus what you want for the task. That concludes the comments.

Pilot C. Task 7050, dynamic V_{mcl-2} , and it's run number 74, and the pilot is C, and it is controllable. Is adequate performance obtainable with tolerable pilot workload? Yes. Is it satisfactory without improvement? Yes. There are some mildly unpleasant deficiencies and what were those deficiencies? Well, it took some work with the rudder to get the beta back in the center and I noticed in my pitch control ... would go bad a little bit because I would be carrying some force, and then all of a sudden the command marker would move an astonishing amount compared to what I wanted it to—so just in general, control. Basically the maneuver is quite good. Minimal pilot compensation is required for the desired performance. Cooper-Harper of 3.

Pilot D. Comments at least on the 7050 task, the landing configuration, two engines out, and it was run 48. No real problem. Feels to me like we have adequate rudder power and we felt we are limiting intermittently apparently, and lots of thrust. The only thing that would really have helped me a little bit more would be some phi forward on the longitudinal acceleration diamond to help control the power. Other than that it looks pretty straightforward.

And Pilot D, December 6 again, back on 7050 for some pilot rating. Longitudinal: it's definitely adequate for emergency consideration conditions. Level II; it's moderately objectionable deficiencies. I think primarily because of ... that longitudinal acceleration caret is hard to control. Laterally, it's got some

minor but annoying deficiencies. You have to coordinate the rudder and the bank angle to get the beta down. Other than that, it's pretty good.

Pilot E. Okay, dynamic V_{mcl} with two engine failure, task 7050. The task isn't too bad at all. Having lost all your engines on one side, I thought it would be a little more difficult. I did not. I did two runs. First run my seat was too low. I couldn't see, I actually had to use the one hand to hold myself up in the air to see the velocity vector, and that certainly detracted from the task. Second task I got my seat situated better. I did not see too much of a problem. I did tend to get some rudder, or some cues from the sideslip indicator that seemed a little odd. With both engines out on the right side, I had assumed I would need left rudder, and at times I was actually having to put in right rudder, and I don't understand that. And the sideslip indicator, you know, was telling me that I had it in left rudder and needed actually some more right rudder or at least less left rudder. It seemed a little bit odd. The angle of bank ... I had no trouble maintaining it pretty much 5° or less and speed was not that difficult with the cues ... the acceleration of the tape. I didn't notice any on the second one especially; the first one I had a little bit of lateral instability because I got a little bit slow. I was trying to ... I couldn't see the velocity vector and I had to stand up in the seat, more or less, so we got to throw that out. The second one everything was very nominal. I think I could have continued down that to a landing without too much trouble, is my extrapolation of that. So for longitudinal Cooper-Harper, for that task with the criteria as mentioned: controllable? Yes. Adequate? Yes. Satisfactory without improvement? Yes, a 3. For lateral directional: controllable? Yes. Adequate? Yes. Satisfactory without improvement? I think I was well within the desired criteria, so I would say yes and give it a 3 based on what appeared to be fairly nice criteria. Certainly not ... I think certainly ... I was well ... I was only 2° or 3° heading deviation, so I was well below the desired border for that. It pretty much ... at least halfway below the desired border for bank angle. So I think it's not too bad a task.

Task 7060, Ripple Unstart

Pilot A. It serves as our backup, in case all the other records fail.

I guess you would need some distinctive annunciation, I'd say aural warning of some kind, which there

was none. The visual doesn't seem to be adequate to me—an aural and a visual and some distinctive. I saw just at first glance no distinctive information that isolated the problems in this particular engine.

Brought all four engines back and then brought the inboards up. Checked those and isolated it to the 3. Brought 2 up and then brought the others up to see whether that was the problem with either one of those. It looks like the first reaction is probably quite path vector down to about 5° or in that ball park, when you get with each engine that comes back to life, you can bring that up about 1° . A good rule of thumb: keep the lock number in the ball park while you try to triple treat the engine. The rudder trim needs to be within ... and it appears as though you have to do these things very slowly and methodically, to keep from jostling the rudder, especially rudder and pitch. Keep that flight-path vector moving very slowly, steadily and also try to keep the sideslip down to a minimum so that you don't inadvertently unstart the engines. Rudder trim seems like it's very necessary for me, because the forces involved are fairly high, and seems a little higher than desirable. Want them a little lower, and also this seat is a little bit on the high side, so that geometry of ergonomics of getting that rudder in is a little less than optimum. It seems like I'm sitting a little high—of course I have short legs. Is there anything specifically that I missed that you'd like to add comments on?

As far as the annunciation when you get the light, there should be some kind of aural warning, sound, and a distinctive place to look where you can determine what it is that's causing the warning. Okay, you said something about Cooper-Harper ratings.

(We have some target values for a desired and adequate, somewhat arbitrary, appearing on your lower display as a readout in this half of performance results. You get the maximum of 0.2 negative g during probably the unstart.)

If they had some motion feedback, perhaps I wouldn't have been so aggressive.

I might make an additional comment on the g 's, and that is that perhaps it ought to take a fairly good force, heavy force, to change g 's. That might be a little more deterrent to inadvertently exceed in g 's. But then

again, I didn't have any motion cues, that comment's made from that perspective.

Is it controllable? Yes. Is adequate performance attainable with tolerable pilot workload? Well, I exceeded my g limit, went negative quite a bit, was a little overaggressive in pushing the nose over, and I didn't have the feedback on the motion, so from that standpoint I didn't achieve my adequate performance. I think had I known what the [limits were, I could have] better correlated the g 's and the motion of the flight-path vector. I could have reduced those g 's without too much trouble.

I can give you an initial rating here; we do it again and see what happens. Is it satisfactory without improvement? I would say, from the standpoint of performance it would be like a Level III—deficiencies require improvement—and I would say that would be in the pitch area, depending upon whether you get g feedback. I think that pilot compensation ... having gone through this 3 or 4 times in a simulator ... you could get the g levels within a reasonable value, although mine is 0.2, since the structural limits are not very comfortable for passengers, especially while having a meal. Cooper-Harper rating, based on what I saw, would be somewhere around a 4.

Lateral directional, I say, would be similar: about a 4 because of the high rudder forces and the criticality of maneuvering—criticality of not causing unstarts due to your inputs.

This doesn't have TAC—thrust asymmetry control—does it? That would help this task considerably in terms of keeping the engines from unstarting. We have the triple seven. If you have an asymmetry in thrust and the rudder comes in, in flight like this, it would completely compensate for thrust asymmetry and that would help these engines keep from unstarting considerably. It would just be a big difference. Then all you have to concentrate on is the pitch access in keeping the g excursions from being too great.

Rudder just comes in to compensate, keep the yaw at zero, sideslip to zero, or something close to that. It may not compensate completely—I think it does actually, when in up-and-away cruise, but not in this predicament.

I would say that with training, scanning up to the Mach number, and to the g 's, would be helpful. I think an analog type of g indication would, just from the visual standpoint, be helpful. The rolling digits take just a few milliseconds, a little more time to process g 's, yes, and it's quite a ways to scan from the flight-path vector up to the Mach number and to the g 's. Actually you've got speed down there right next to the flight-path vector, and it is in knots equivalent, I guess. It would be more helpful or appropriate, it seems to me to have it—once you're above 8/10 Mach or something like that—to go to Mach number instead of your airspeed or relegate airspeed to a secondary level, or perhaps be able to select which one you want to look at. In addition, since you're pitching nose down, it would be nice, like I say, to have some indication of your limit, V_{mo} or M_{mo} , indication so you don't overshoot the speed in descent. Rolling digits help give you cues of how fast things are changing; they give you good rate information.

Pilot B. Okay, run 163, test 7060, ripple unstart. Relatively simple task for everything except for controlling beta. It lags a bit in controlling beta and there's an overshoot tendency which I feel might develop in the PIO if I let it keep on, so you are deliberately kind of reducing the gains to get the beta under control. One of the great criteria's max load factor deviation and recovery and primarily the technique is to leave the longitudinal and lateral systems alone—let it do its thing—and that is where I am getting peak in g . And so I am not able to get that, but I am not in control when that happens either. Max bank angles: no problem. Deviation in Mach is no problem once I learn the technique. And the technique basically is to let it decelerate level, to get down below 2.2 when you can start the engines again, and then start downhill as a last step because it takes a while to decelerate to 2.0. So that is not really a problem. Heading deviation is also not a substantial problem, so that the basic problem in control is in the directional axis. Longitudinal is entirely predictable: it's controllable, adequate performance obtainable, satisfactory without improvement, pilot compensation largely not a factor. I am doing HQR of 2. Lateral directional—keeping in mind this is primarily directional: it's controllable, adequate performance is obtainable. I would say that desired performance requires moderate pilot compensation—give an HQR of 4, compensation consisting of directional

inputs and predictions of response. That concludes the comments.

Pilot C. The best technique for doing this is to leave your hand pretty much off the stick and let the commanded bank and roll functions of the flight control system take care of it. The pilot needs to come on with his feet and take care of the beta. It takes a rather rapid, large input of the rudder pedals, very aggressively, to control the beta—bring all the throttles to idle. And then once the beta is under control, start bringing 2 and 3 back up. It's unclear to me why some times it hangs up and doesn't restart. But if you wait a little longer and keep the beta controlled, you could probably bring the engine that will still run back on-line. Following that, as long as you take care of the beta with rapid rudder inputs, you can keep it small enough so that you could bring 3 and 4 or 4 and 1 up immediately; they typically come very promptly. The going to 0g is probably not as we would like it, so a better technique might be to pull aft for a while so that the nose doesn't drop quite so rapidly. But, nevertheless, it's an easier workload for the pilot to leave the controls with hands off. Cooper-Harper-wise: is it controllable? Yes. Is adequate performance attainable with a tolerable workload? How did we do with your measures of "adequate" there?

(These are pretty loose. I'd say we were certainly adequate, perhaps even desired in everything but the *g*.)

I think the *g* is still a problem here. I don't think we can call that adequate performance. So, that would be a "no." We'll go to a major deficiency, adequate performance not attainable with maximum tolerable pilot compensation—controllability not in question. So it's a 7, given this level of training. I think that we might be able to find a technique that would help us with the *g*, especially if we had real *g* in the seat-of-our-pants; we probably could have a technique that could improve that circumstance. So a proper 7. Lat dir in the roll axis, it's best just to let the airplane take care of itself in roll axis and not deal with it there. In the directional axis, the pilot is required to keep the beta small, and that is a significant task. Trying to do it in a purely closed-loop fashion causes you to chase it back and forth from side to side, so it requires a different technique—rather large inputs to step on the ball of the indicator—and then as it starts to press back,

you probably will have to reverse controls in order to try to stop it with a lot of pilot lead—a lot of compensation required to keep in the center. To do a good job of keeping it in the center requires the pilot to concentrate solely on that. Looking at other tasks, like watching the engines come back up, is apt to let it slip out of tolerance and then the engine won't restart. Let's look at the Cooper-Harper for that. Is it controllable? Yes. Is adequate performance attainable with a tolerable pilot workload? I'm going to say yes. Is it satisfactory without improvement? I would say no. The amount of lead required here is significant, it's more than minor but annoying deficiencies. I think we might say adequate performance requires considerable pilot compensation, with Cooper-Harper 5.

Pilot D. Okay, Pilot D, December 7. We're looking at the ripple unstart, task 7060, ended on run 11. It looks like you get a big negative *g* spike or roll with negative *g* spike at unstart, which is going to be very difficult to catch manually. It looks like we could use some cross feed from thrust to the elevator. The rudder forces are very high for beta control. And I was using the technique here of just trying to hold level flight for ATC purposes and let the airplane slow down below Mach 2 to get a reliable relight. And it looks like the service ceiling, three engines, though, is significantly lower than the cruise altitude. But this at least allows you to get the engines relit and allow adequate time for advising ATC. Pilot rating: I am obviously blowing the heck out of everything on the criteria that's given here, but it's really—the workload involved in the task is not all that high. You know, workloadwise it's 5-ish; moderately objectionable deficiencies particularly just the rudder forces. But you know, if I go by your performance criteria, I'm down in 7's and 8's.

Pilot E. Okay, December 14, Pilot E. Okay, this is the ripple unstart, test card 7060. Have you not been hearing me very well in the past? Okay, it looks like, for the criteria that I had any control over, I was well within desired on phi and Mach deviation control and heading was in desired. The ... basically, the ... it's not too difficult a task. Longitudinally, it's a little bit sensitive as the engines come off on the ripple unstart mode. I did notice some uncommanded gamma. I pitched down quite a bit, about maybe a degree and a half or 2° with the command on the horizon, but the actual ... actually pitched down so I put in some ... commanded a higher gamma ... and it corrected itself

back to the horizon. I lost about 400 ft in the attempt to maintain directional control, and gradually pulling the stick back to get the ... to take care of the downward pitching moment and regain my altitude. I didn't have too much trouble holding bank angle. A little bit of nonintuitive sideslip problems, in that I would put in some rudder and would get ... sometimes seemed like I would get way ... a great deal of effectiveness ... and other times I would be full rudder and still have the sideslip. So, the directional control throughout the maneuver ... I didn't ... I felt it was a bit unpredictable, but not too bad. I maintained heading pretty closely, but on the first one and the second one, and maintained the angle of bank, so all in all, not too difficult. For the longitudinal criteria: is it controllable? Yes. Is adequate performance attainable? Yes. Is it satisfactory? No. I'm going to rate it a 4, because the control law is not able to compensate for the $C_{M\Delta P}$ when we lose all of the engines, and so therefore you end up losing some altitude and it becomes a little bit of a nuisance trying to regain your altitude. For lateral directional: is it controllable? Yes. Is it adequate? Yes. Is it satisfactory? No. I'll rate that a 4 also, the reason being that the directional inputs that I had to make seem to be a bit—just a bit to unpredictable. Of course, a lot of things are happening with the ripple unstart that's making the sideslip change kind of unpredictably, but I would think it might require some tailoring to try and make that a little bit nicer task. Aerodynamically again, trying to remove the control law from the aerodynamic end of it, the vehicle obviously is capable of directional control and holding altitude, I believe. So in that regard I don't see any holes in the aerodynamic model.

Task 7070, Engine-Out Stall

Pilot A. Okay, and this is the stall. Which one is this—7070? Okay, let's look at longitudinal Cooper-Harper: is it controllable? Yes. Adequate performance available for tolerable pilot workload? I'd say yes. Is it satisfactory without improvement? No. It has a tendency to drop right into a stall, so it requires basically full nose-down elevator to keep you out of a stall. It should be the other way around. You should be fighting the deterrents, and moderately. Okay, I would say moderate pilot compensation. It would be 4, [CHR] 4 (Level II) on longitudinal. Lateral directional: is it controllable? Yes. Adequate performance attainable with tolerable pilot workload? Probably yes. And is it satisfactory without improvement? No. And major

deficiencies require improvement. Very objectionable, but tolerable deficiencies. Gee, well, I'm going to back down and call this a major deficiency, Level III. I'll call it a 7. That's because of the tendency to go into a PIO. You have to periodically take your hand off of the stick to let it settle out.

Pilot B. Run 43, task 7070, engine-out stall. Task required was at deceleration rate, basically maintain bank angle throughout maneuver, $\pm 5^\circ$. That maneuver was done per the card. I created a task of longitudinal pitch attitude control, of $\pm 1/2^\circ$ for the longitudinal task. It's controllable, adequate performance—that was for desirable, by the way. It's controllable, adequate, and satisfactory. And from a longitudinal standpoint I'd say minimal pilot compensation required, HQR of 3. Lateral directional: it's controllable and adequate; you are working a bit, though. I'd say desired performance requires moderate compensation; give it an HQR of 4. The task basically ... the compensation was basically to maintain that sideslip as the speed changed. You're just working to do that. That ends the comments.

Pilot C. Okay, this is run number 28, task 7070, C is the pilot. Well, okay there's several things that need to be mentioned here. The first one is that, when you pull the nose up to do the entry into the task and as you try and hold the attitude constant, the flight-path marker has to go down, of course. And the only way you can do that is to ride just a tiny little bit above breakout force to make the marker move smoothly, which you cannot do, so it goes down in steps, which causes the pitch attitude to go down in steps, so that's kind of aggravating. And also, the forward force required to keep the nose from coming up is abnormal. It's not normal. Okay, and then when it's time to recover, if you keep the beta centered then you can pitch straight over and recover without any significant problem. If you keep your feet on the floor, on the other hand, and just maneuver around a little bit in beta $\pm 5^\circ$ or so—I mean in bank angle $\pm 5^\circ$ —and then by the time you are ready to recover you're apt to have a significant beta and the airplane will depart. I didn't try bringing my feet on to try and correct it there because previous experience in turning stalls showed that my feet weren't smart enough to solve the problem. Okay, is it controllable? Yes. Is adequate performance obtainable with tolerable pilot workload? I would say—for those conditions where we go to 21° —I'll say no. Adequate

performance is not obtainable with maximum tolerable pilot compensation—controllability not in question. I think that's not right. It's controllability—considerable pilot compensation is required for control. Cooper-Harper of 8, and that's the requirement to keep the beta within certain limits; otherwise you'll be uncontrolled. So let's see: you like to have them divided into (two parts). I would give that for the lateral directional. Cooper Harper of 8 for the lateral directional. And for the pitch axis: I think we can give that a different rating. We can say it's adequate. Is it satisfactory without improvement? Moderately objectionable deficiencies, adequate performance requires considerable pilot compensation, a 5. And that's the inability to make smooth attitude adjustments to enter this maneuver.

Pilot D. Okay, new day, December 13, first pilot is Pilot D. Okay, Pilot D on December 13. We just looked at card 7070, which is one engine inoperative climb stall, and we ended with run [13]. We made [4] runs. The first one I didn't have any problem at all. I only maxed bank angle at 3. Second one was probably more representative. We got up to a max bank angle of 13. On the third one I was making intentional roll inputs up at the stall, and we lost control during the recovery. Pilot rating longitudinal: the thing is, it's fairly easy to maintain a reasonable decel rate. Let's give it a 4. And laterally: I'm not quite sure what to do. Did you lose control? Yes. Although that was abused condition but probably not—it certainly wasn't excessive abuses. I think it really did lose control, and I think that's probably representative in the control, and the pilot rating ought to go along with that abuse case, so let's give it a 10. And I think this is an indication the thing needs some kind of stall protection.

Pilot E. Okay, this was 7070, run number—what was the run, Bruce? Thirty-three, okay, basically, your engine-out stall. The only thing I noticed was that, as you pulled up and decelerated, you got some kind of odd betas, some odd sideslip that did not necessarily seem to be consistent in the direction of the failed engine. So I was having to put in both right and left rudder to correct for it. And I assume—and Bruce this question to you: is the rudder doing anything on its own while I'm pulling up? It's trying to trim things out, so I'm working with the control system. I'm probably in phase with it, but at any rate, holding constant sideslip or holding beta zero is a bit of an effort.

Another question: are we showing lateral acceleration or are we showing beta on the display? Okay, at any rate, it's a little bit of a task. I elect to be smooth with this; just my previous experience has been that on all these control inputs, if you were smooth, and with the highly delta wing planform, that is kind of the way I generally would have my instinctive piloting abilities. So I will accept a little bit of beta and smoothly try to correct it, rather than put in an abrupt rudder input, which I have noticed tends to cause things to go downhill quickly. So I tend to accept a little bit of beta and smoothly try and take care of it because sometimes there are some unpredictable responses. At any rate, longitudinally, the recovery is not a real problem. It does tend to push over very well and [is] controllably. I can stop the nose downward rate when I feel like I should. The one thing I will comment is that the ... it's very difficult for me, having a relatively short torso: I have to kind of sit up on my tiptoes to see the airspeed and velocity vector on the bottom of the CGI. So it's kind of awkward—I'm trying to keep my heels on the floor, keep my toes on the rudder, so I can keep beta in there, and at the same time kind of stand up—so it's just a little comment there. Okay, longitudinally: is it controllable? Yes. Is adequate performance attainable? Yes. Is it satisfactory without improvement? I would say yes and rate it a 3. Lateral directional: is it controllable? Yes. Is adequate performance attainable? Yes. Satisfactory without improvement? I would say no, even though I met the desired criteria for bank angle very well. I think my bank angle was only about 1° to 2° at most, and I kept my heading this last time within a degree or two. I still felt that there was some things between the coupling—between myself and the control law directionally—that I didn't particularly care for, so more—using the lateral as the lateral-directional rating—I'm going to say that ... a little unpredictable beta that took a lot of effort trying to keep zeroed ... so I'm going to rate that a 4.

Task 7080, Engine-Out Turning Stall

Pilot A. Alpha protection is an important ingredient of this thing. Okay, this is 7080, turning stalls, and the run number is 59. We'll look at longitudinal Cooper-Harper: is it controllable? No. It must ... I would have to give it a 10. And lateral-directional Cooper-Harper: is it controllable? No, 10.

Pilot B. Run 52, task 7080, engine-out turning stall. Finally settled on a technique that involved recovering on angle of attack at 21° . When we did that the minimum speed was about 110 knots, but we were recovering as we hit 110 knots. And the other key seemed to be to keep the beta down in the recovery, to lower the nose but keep the beta down as you are lowering the nose with gentle inputs. And then as the card says: as airspeed starts accelerating, then zero out the bank angle. Fairly critical maneuver, if you don't do it right; it likes to go into a flat spin right away. There's no longitudinal CHR criteria but I'm going to assume once again that holding pitch attitude where I wanted it in the deceleration and in the recovery, plus or minus a half a degree desired, is what I'm looking for. In that regard: it's controllable, adequate, and satisfactory, with minimal pilot compensation required, HQR of 3. Lateral directional: the only task is to set a maximum bank angle. I am going to assume that means a bank angle and sideslip control—bank angle within $\pm 2^\circ$ adequate, 1° degree desire, and sideslip within a half of an indicator desired and within a full indicator adequate. Given those criteria, lateral directional was controllable and adequate; however, adequate performance requires considerable pilot compensation, HQR of 5. That ends the comments.

Pilot C. Task 7080, turning stall with right engine out, so you're turning right into the dead engine. Some comments first—the same kind of comments with the pitch axis and the entry. The recovery is very dependent upon pushing the stick straightforward until you get the alpha back in reasonable range. That way the beta stays well centered, and then you can roll out when your wings come through—about when your nose comes through the horizon and everything seems very good. If you aggravate it with the aileron, you'll have some ... if you do the aileron first, the rollout, then you have very little chance of recovering. So is it controllable? Yes. Is adequate performance obtainable with a tolerable pilot workload? I am going to say that putting the stick in first is a tolerable pilot workload. So is it satisfactory without improvement? The deficiencies warrant improvement? Yes. So satisfactory without improvement is a no. And very objectionable but tolerable deficiencies. Adequate performance requires extensive pilot compensation. I think that's what I would consider that level to be, so Cooper-Harper of 6. And that's—well, I am going to say in both axes because it's an operational procedure which

makes me to have to do it in a particular way, and if I do it successfully that way, then I'll give that as an extensive pilot compensation.

Pilot D. I want to go back and change my pilot rating on the previous one and make it the same. Let's make it a 5. I think it is moderately objectionable; that pitch attitude tends to bother me. I've gotten use to it. Lateral: this time we didn't lose control. Is it controllable? Yes. Is adequate performance? Yes. Satisfactory? We can't give halves huh? For the workload it's 5, but give it a 6 there. I was getting into that wing rock. You feel like you're on the edge of a cliff or something. I say that official, let's make it a 6. That's for this one. That's lateral. A 5 and a 6. Yea. A 5 longitudinal and 6 lateral.

Pilot E. Okay, that is 7080, run number 35. Again, longitudinally: not too many problems. I was trying to be fairly smooth. We're not really spending hours on these things looking at every possible control technique. The second time I did it, I tried to be a little more aggressive. I noticed some ... a little bit, as I try to be more aggressive ... in pitch I got kind of an uncommanded roll towards wings level. Either I coupled with the control stick or somehow an aerodynamic coupling occurred. But at any rate, I did try to roll wings level as I was starting my recovery. Since I didn't want to have any aileron or any phi-dot occurring during the recovery, I actually backed off on my pitch rate, which then stopped the roll rate. So there was some type of pitch-roll coupling that occurred when I was more aggressive on the second recovery attempt. I did not notice it so much on the first, although I did have to work to maintain my constant 30° angle of bank on the pitchover on the first one. Again, a more aggressive pitchover on the second run resulted in some pitch-roll coupling of some sort, and I relaxed my pitch rate a little bit and the pitch-roll coupling stopped. So something interesting is going on there. If we had plenty of time, I think it would be worth spending some time looking at this and trying different degrees of aggressiveness on the recovery, but we'll move on. Also, the pitch rate appeared at times to be a little bit unpredictable; and in other words, I would have a constant stick position and my pitch rate would vary and tend to almost slightly hang up. So that was a little interesting too. Again, something I think, if we had more time, we would spend a lot more time looking at it. Okay, however, meeting

the evaluation basis of the criteria; longitudinally: is it controllable? Yes. Is it adequate? Yes. Is it satisfactory without improvement? I would say no and rate it a 4, simply because there is a little bit of a tendency to be a little bit or very, very subtle unpredictable behavior as you pitch over. I would like to spend more time looking at it some time. (That's a 4?) A 4. For lateral directional: controllable? Yes. Adequate? Yes. Satisfactory? No. A 4 also. I would like to know more about this coupling I observed, and it took a little bit of effort to hold the 30° angle of bank as we decelerated. Also, during the recovery, as I pushed over I got a beta spike. I pretty much ... the beta was very constant ... as I pushed over the beta showed me a great deal of left sideslip very abruptly, which kind of puzzled me a little bit. So there's a lot of things I guess I don't really have a real warm feeling about. There're more things I would like to spend time looking at, but we'll move on.

Task 7090, All-Engines-Out Landing

Pilot A. Okay, this is task 7090, all-engines-out landing. For longitudinal Cooper-Harper: I think was actually quite good—2000 ft down to -10° flight path—actually I was using -15° flight path. So really, is it controllable? Adequate performance? Yes. Without improvement? The only improvement would be guidance, I guess, through this maneuver—flight director cue of some kind. I would say, given that, improvement not required. Well, I'd say it's good. I'll give it a 2. In lateral directional: controllable? Yes. Adequate performance? Yes. Satisfactory without improvement? Yes. And I'll give it a 2 on lateral directional. No problem there. The landing at itself, actually was, other than making the distances and speeds—if you throw those out, is it controllable? Yes. Performance? Yes. Satisfactory without improvement? Oh, I suppose you could try—you're at the mercy of wind conditions in this situation. Satisfactory without improvement? I would say yes, and improvement not required as far as touching down at a higher speed kind of makes it easier for the flare, and so I give it a 2. Lateral directional a 2. You don't necessarily make all these numbers in terms of distances, but it's certainly ... you have the capability of applying ... actually I don't know how close I came to 250 on the scorecard—feet per minute—deviation from rate of descent—you don't call out a rate of descent. Yeah. Okay. As far as the handling qualities, it's fine.

Pilot B. Run 24, task 7090, engine-out landing. The technique was a little bit different than what I anticipated or what I thought I might have flown while doing it for real. We start out at about 5° flight-path vector depression at about 200 knots and the technique I finally settled on was to fairly abruptly push the nose over to about 15° nose down and you pick up 250 just about the same time you pick up 1700 ft. From then on it's pretty much as written. A general preflare to an aim point about 1500 ft shy of the runway and then at about 400 ft, when the flaps start transitioning, move the velocity vector up to the aim point and play the decel and the altitude to arrive in the touchdown box. Surprisingly, not all that difficult given the technique, and once I learned the technique, in both the longitudinal and lateral axes.

Okay, the first segment is descent and preflare ... let's see ... which is from 3000 ft to crossing the runway threshold. Longitudinal HQR: it's controllable, adequate performance is obtainable, and I think it's satisfactory without improvement, with minimal pilot compensation required for desired performance, HQR of 3. Lateral directional was real easy, I don't even recall thinking about that. It's controllable, adequate performance is attainable, satisfactory without improvement, negligible deficiencies, pilot compensation not a factor for desired performance. Give that an HQR of 2. It's a big airplane and you're moving around a little bit when you move it laterally, so it's kind of hard to give it a 1. For the landing segment, and this is from the threshold to nosewheel touchdown, I didn't recall any tendency for APCs or any bobbling in pitch or roll. No tendency to float or bounce after touchdown. Fairly controllable, fairly consistent. Longitudinal HQR: controllable, adequate performance attainable, satisfactory without improvement, minimal pilot compensation. Again, just hunting around for the touchdown point. I'm going to give it an HQR of 3. Lateral directional: again, I don't recall working at all there. It's controllable; adequate performance is attainable. It's satisfactory. Pilot compensation largely not a factor. I'm going to give that an HQR of 2. And that concludes the comments.

Pilot C. Okay, task 7090, the all-engines-out landing. It's run number 83 and C is the pilot. So first is the initial approach segment of—no the far-out segment, as I might say, in pitch axis. Is it controllable? Yes. Is adequate performance obtainable with tolerable pilot

workload? Yes. Is it satisfactory without improvement? I would say, no—minor but annoying deficiencies, desired performance requires moderate pilot compensation—Cooper-Harper of 4. And the reason for that is my normal complaints about how the control stick controls the pitch attitude command bar and that it mostly takes jabs instead of nice forces, because the breakout seems pretty large. For the lateral directional: I didn't have any trouble with that whatsoever. We could call that—is it satisfactory without improvement? Yes. And a Cooper-Harper rating of 3. Minimal pilot compensation required for desired performance. For the close-in part, the difficulty you have in pitch axis and a little closer is similar to a normal approach, except you end up with a lot more airspeed, and therefore you have to float down the runway in order to get it stopped. It is an energy mismatch and there's no way to really get rid of that excess energy. In the pitch axis I would give that a ... in this case I don't think it's fair to charge those long landings to the airplane. It's more an energy management circumstance. As far as I'm concerned the airplane flies and does this pretty well for the circumstance. Is adequate performance obtainable with tolerable workload? I would say yes. Is it satisfactory without improvement? I would say moderately objectionable deficiencies, Cooper-Harper of 5. Adequate performance requires considerable pilot compensation. You wish you had a way to modulate the velocity a little more. That would be my objectionable deficiency for this case. In the lateral directional axis I tried to do a slip to help me get rid of the extra airspeed, and that looks like it was getting ... working all right. I would have preferred to try to do that further out on a more stabilized flight path, controlling the airspeed that way, and then I would have had time to roll out and get reestablished for the touchdown. The poor dynamics in directional axis leads me to say that it's not satisfactory without improvement, and very objectionable but tolerable deficiency. Cooper-Harper of 6, because it was too hard to do the directional part of the slip and get it under control again for landing.

Pilot D. Okay, Pilot D, December 6, work task ... what number was this Dave? Task 7090, and we got up to run 58, huh—59? Run 60. Okay. We did that many, huh? Okay, I think, at least based on my experience 25 years ago, the procedure is not being used in the Shuttle, or what was being used in the lifting bodies, or what I had seen with [F-]104 simulations of lift-

ing bodies or the Shuttle. The procedure is not the same. I think it's just a little bit of a game here. You just take the IC and you just vary your procedure until you get to the end of the runway. Whereas the Shuttle or the lifting body procedure ... really, it was a procedure that put you on the correct energy no matter what your IC was. But at least the handling qualities of the vehicles are very nice. It can handle the large gamma changes with no problem, and I think if you really wanted to look at this you could come up with something that would work. Pilot ratings: am just going to kind of ignore the performance specs there a little bit and give it 4—4's. You know it's really pretty good. The landing, you know, I think ... well, in view of the fact that you can just get it on the runway ... I think is pretty damn good ... and get it stopped, but longitudinally we're probably a 5. We're not making desired every time, for sure. Laterally, it's still a 4.

Pilot E. Okay this is task 7090, all-engines-out landing, pilot is E. Thank you once again, Dave, for that very special introduction. The all-engines-out landing, a nice task, probably my favorite task that we do. The longitudinal performance is very well. Obviously we are setting it up in absolute desired parameters to begin with. If it is flown right, it can end up beating all these criteria, as evidenced by the last approach we did. Let's see, looking at the target ... is 5 ... I pretty much ... that is kind of the up and away ... that is, you pretty much get 250 and then you start your preflare at 700 ft, so you start your decelerating, so it's kind of a tough little parameter there to judge. I don't know even if we were even measuring our rate—deviation rate of descent. It's kind of bogus, right? Okay, all right, basically, up-and-away, down to—let's see—descent and preflare, cross runway threshold. Okay, all right, and on that one, it is a pretty benign task laterally. There's nothing really to do longitudinally. It's just basically being smooth. I found that if I was very aggressive in pushing over to get my 250 knots that—Dave brought this point out—you end up getting down to 400 ft too soon and your autoflaps come in and your drag allowed to last over a long period of time, which bleeds you of energy and makes you land a little short. The better way to do it is to kind of actually delay your pushover and then do a very gentle pushover. So your're actually starting your preflare probably just shy of 250 knots, but as you continue to preflare you do reach 250 knots briefly before you start slowing down. This puts you closer into the runway before you

get to 400 ft, which gives autoflaps less time to affect your energy state. When you come into this approach, it's a very flat approach over the threshold, which sets you up very nicely for your flare attitude. So it's pretty nice to make a nice flare attitude. It's pretty nice to make a spot landing, if you have enough energy to get there. The last run I did, I think was the definitive one and glad we stayed up for a couple more of those. At any rate, for longitudinal Cooper-Harper for up-and-away: is it controllable? Yes. Is adequate performance obtainable? Yes. Is satisfactory without improvement? I would say yes and rate it a 3. For lateral directional: it's a nonfactor really. Controllable? Yes. Adequate? Yes. Satisfactory? Yes, and a 3. For the landing, this is runway threshold to touchdown. Again, if you fly by the numbers, it's not terribly difficult. It's controllable. Yes. Adequate performance is obtainable. Is it satisfactory without improvement? Assuming you do everything right, up-and-away, there's really not a whole lot you can do in close except set the flare attitude and land at the proper speed, and if you've done it right up-and-away, you will land in the box with just enough energy. And in that very, very flat attitude coming over the ramp, it's pretty nice to set your flare attitude. So I think I would rate this based on the last approach, where I kind of figured out the best way to manage the energy. Controllable? Yes. Adequate? Yes. Satisfactory? Yes, for a 3. And lateral directional, similarly a 3. There's no issues there. The longitudinal for the flare, I might make it borderline Level I, [rating] 2, 3, 4, because there is a certain amount of effort required there. But it really is a pretty nice task. Pretty much all Level I in my opinion.

Task 7095, Manual Throttle Landing

Pilot A. Okay, this is task 7095, manual throttle landing, and the last run number is 22. Longitudinal Cooper-Harper, doing a 1500 down to 400 ft with manual throttles: is it controllable? Yes. Adequate performance? Yes. Satisfactory without improvement? Yes. Improvement not required. I'll give it a 2. The throttle friction: I guess this has nothing to do with the longitudinal controls, but the throttle friction is quite high. It would be helpful to have some accel/decel cue. If you have an accel/decel cue, however, the optimum capture for the airspeed might ... some kind of indication for that might be helpful ... kind of flight director for the throttle type thing, although the cue as presented is mighty helpful. Lateral directional: that was

really not a factor. It's controllable. Adequate performances? Yes. And without improvement? Yes, and frankly it did quite well. I will have to give it a 1, I guess. And on the precision landing—longitudinal: controlled? I have no problem with that. This is for 400 ft down to nosewheel touchdown. Pilot decisions. Is it controllable? Yes. Adequate performance? Yes. Satisfactory without improvement? Yes. I guess I'd have to give it a 1. The lateral-directional Cooper-Harper, based on the performance and what was required for this particular task: is it controllable? Yes. Satisfactory performance? Yes. Without improvement? Yes. And I would have to give it a 1 for this situation. No problems at all with it.

Pilot B. Run 67, task 7095, manual throttle landing—actually, approach and landing. Let's see, in the evaluation segment, no major problem with the acceleration cue. This is primarily a display issue more than anything else. The acceleration caret tends to lag quite a bit. What I've seen done in the past is to put a washed out throttle angle to help lead the acceleration caret. Obviously you haven't done that here: you're just using N1 or N2. You get a lot of lag when you do that, and sometimes you get a little bit out of phase with the acceleration caret, and I'm finding what really helps the workload is if you put in some washed in, or washed out rather, throttle angle to help lead that display cue a little bit. Other than that, once you get it established on the speed, it's fairly straightforward—it's pretty easy to control it. So, I don't have a major problem with that. It doesn't appear to affect the longitudinal or lateral-directional flying qualities in the approach any at all, so I'll give you the HQR's. It's controllable, adequate, and sat, longitudinally. I'd say minimal pilot compensation and give it an HQR of 3. For lat dir: it's controllable, adequate, and sat, and compensation is essentially not a factor in this task, and give it an HQR of 2.

On the precision landing segment, no pronounced tendency for APC's or bobbling in pitch and roll this time, a little bit of a tendency to float. I tend to float with this control law. No tendency to bounce that I noticed. Longitudinally, I'm hunting. The problem is that I've done enough of these today now that I'm getting to the point where I can no longer call it moderate compensation, but on the other hand, I'm not getting desired very often either, so let me leave it where it is. It's controllable, adequate, and I still think I'm hunting

for desired performance and given that desired performance is awfully tight. I'd call an HQR of 4, longitudinally.

A lateral directional on this task is much easier. It's controllable, adequate, and sat, and lateral control is essentially not a factor. I'll give it an HQR of 2, lateral directional. That concludes the comments.

Pilot C. The task is 7095, run 76, and it's a manual throttle landing. It is controllable. Adequate performance obtainable with a tolerable pilot workload? Yes. Is it satisfactory without improvement? No. I would say moderately objectionable deficiencies—adequate performance requires considerable pilot compensation, a 5. It's still getting the touchdown and the touchdown H-dot, and the touchdown position is still my nemesis. I can't seem to get both of those going good. The good news is that the manual throttle part along with the little acceleration diamond is actually quite nice to fly. It can do a pretty good job keeping the airspeed all the way down the final approach and through the landing with it—much better than I thought it was going to be. So the Cooper-Harper rating of 5 is basically the same kinds of things I've seen before, as opposed to an increased difficulty with the manual throttle. I didn't find it that much more difficult with a manual throttle under these daylight conditions. Probably when my workload is higher on something else, that would be more difficult. Okay, so those comments were primarily related to the 400 ft and below part and the glide-slope interceptor and localizer part before 400 ft. There is still a Cooper-Harper of about 3, with similar comments as before.

Pilot D. Pilot D on December 6 ... got our date right. Just finished a manual landing, 7095. We ended up on run 52. The airspeed control during the approach is a little bit of a workload. Again, I think primarily because of the X-double-dot lag. The back-sidiness does not seem to be much of a factor. I think if we could improve the display, you know, we could get a much better pilot rating for this task. Down into the flare, I actually found the flare a little easier. We've only got two throttles to pull back so the forces are much less, which kind of confirms that the sticky throttles have been affecting the landing, and also we don't have to make the awkward autothrottle disconnect. These two things actually make the longitudinal part of the flare easier here with the manual throttles.

Okay, pilot ratings for the approach: we got up to ... is satisfactory without improvement? I would say no, and I would say moderately objectionable deficiencies, a 5 because of the laggy longitudinal acceleration. Lateral: I will give it my same ol' 4. Landing: is it satisfactory without improvement? With ... since I'm busting the H-dot we got to go into the Level II, and I really do need some help. I'm still just a little bit lost as to where I'm touching down. Although that was easier that time. Okay, minor but annoying deficiencies, 4. Actually I would have to go to 5, don't I with my hard landings? Yeah, let's make it a 5, and 5 on performance and if ... you know, again, I think maybe the touchdown sink rates there are, well, they're definitely higher than what we were using at Ames. So if it wasn't for that constrained sink rate, I would give it a 4 but a 5 because of the performance. Laterally, during the landing it's the same ol' 4. Okay, I would like to add a comment on the longitudinal landing. Since we're measuring landings from 400 ft down, I still have that airspeed control problem. Particularly during the flap transition, which requires some, you know, changes in the nominal throttle setting. So I'm a little bit ... the flare was actually here but the glide-slope tracking is definitely up. I think we can give it a 5 even for handling qualities if we include that airspeed tracking task on the landing task there.

Pilot E. Okay, this is December 12, and the pilot is E, task 7095, manual throttle landing. Thank you Dave. Okay, this has probably been introduced, 7095. I don't think it was too bad. Obviously we have a back-sided configuration here and the airspeed ... effort to hold airspeed is more difficult than a more standard configuration. But it's not too bad, and scorecard is a bit strict in that it measures a momentary impedance, not really a time history of average type performance. So at any rate, I'm going to probably elect to disregard these scorecards to some degree, in that I thought the approaches were a little better than the scorecard may indicate. As far as localizer tracking, not difficult, but I put tracking as more difficult, simply because you have to concentrate so much on the velocity vector and the speed error and climb from that point ... the acceleration indicator and the ... actually I find the acceleration indicator very, very useful. The actual error tape I don't really incorporate in my scan, so I'm not actually using that. That is not proven of value to me, but the acceleration diamond is very helpful. So the tape: I look at more visual speed readout, rather [than] the tape, so I do without that and not miss it. At any rate,

longitudinally, you do have to work a little bit when on speed control, and that takes away your attention to your glide slope, so I had a couple of glide-slope deltas. I tend to try and stay slightly below glide slope, anticipate the autoflap ballooning effect, and I probably was a little too relaxed with that. I wasn't tight enough or strict enough on myself to hold it tight on the glide slope, which I believe I probably could have. Localizer tracking: I did work hard on that, and I think I did very well on that. It's not that difficult a task on this particular approach. Okay, for the 400-ft glide-slope and localizer intercept. Localizer intercept, of course, is not really applicable. I met the easily adequate airspeed deviation. I'm going to go with that and say, for the vast amount of time, I met the desired. I'm not going to let that one exceedance for each approach color my rating on that. And also, I think localizer is pretty much right on. Glide slope is—most of the time—less than a half. So basically, I think it's generally a desired type performance. So for the longitudinal Cooper-Harper: is it controllable? Yes. Adequate performance attainable? Yes. Is it satisfactory without improvement? No mainly due to backslidiness, which takes away so much of your concentration. I'm going to rate it a 4. The lateral directional: is it controllable? Yes. Adequate performance attainable? Yes. Satisfactory without improvement? Yes. I will rate that a 3. Lateral straight-in approach like that, there's really no issues involved with the lateral axis. For the precision landing, generally my sink rates were 3.2 up to 4.7—3.24 and 4.7. And pretty much, I had good box location except for one. So I think there's a borderline desired adequate there. Longitudinally again, from 400 ft on down, the autoflaps are coming in. It's pretty much ... you're not ... it, you're looking at the ground, and your symbology tries to overcome this autoflap balloon effect. It takes a little bit of effort there. Lateral directional is really not an issue. So longitudinal: is it controllable? Yes. Adequate performance attainable? Yes. Is it satisfactory without improvement? No. I will rate that a 5 because of the ... I never really did get the desired sink rates. One thing I did notice different on this approach that I have not noticed before, and that is, in the flare my actual gamma tended to exceed my commanded gamma, and typically I have not noticed that and I'm not sure why that is. Why it was, whenever I would make my flare, the actual gamma would always pop up to about a velocity vector—maybe two thirds of the velocity vector—circle diameter above the commanded, and I had not ever seen that

until this approach. What that did to me, though, was made me think my actual gamma was actually above the horizon and therefore I would be climbing, and so I would drop the nose a little bit and that's why my sink rates were not quite as good. I'm going to talk to Dave a little bit more about that after we get off of the tape. But at any rate, so that results in a 5 Cooper-Harper for longitudinal. For lateral directional: controllable? Yes. Adequate? Yes. Satisfactory? Yes, a 3, and again there were no issues there.

Task 7100, Unaugmented Landing

Pilot A. Okay, this is task 7100, unaugmented landing. Okay, this is run number 27, is the last run. Looking at longitudinal Cooper-Harper for the unaugmented approach: is it controllable? Yes. Is adequate performance attainable with a tolerable pilot workload? Probably it's bordering on the intolerable because of the added lateral deviation. I give it a Level III and say we have major deficiencies. Adequate ... well ... controllability? Not. Well, let's see ... adequate performance not attainable with maximum tolerable pilot compensation. I would say ... well it's right on the borderline. It's either a 6 or a 7. I guess I'd give it a 7 on this one. Some of the things were adequate, so I give it a 7. Lateral Cooper-Harper ... well it's ... yeah, lateral Cooper-Harper down to 400 ft: is it controllable? Yes. Adequate performance with tolerable pilot workload? Yes. Satisfactory without improvement? No, and I would say there's some ... I give it a 5. And from 400 ft down to nose-roll touchdown, longitudinal: is it controllable? Yes. Adequate performance attainable with tolerable pilot workload? No, I don't think so. Deficiencies require improvement. I would give it a 7. It could be a 6, depending on the luck of the draw, what kind of upsets you have, how far out you go. If you could give it a half of a credit, I would probably say 6 1/2. Let's make it a 7 in pitch. In lateral direction: is it controllable? Yes. Adequate performance attainable? Yes. Satisfactory without improvement? No, I don't think so. I'd give it a 5.

Pilot B. Run 19, task 7100, unaugmented landing. For the glide-slope and localizer intercept, plus or minus a half a dot, you're really working hard, obviously—lots and lots of stick inputs in both axes. I wasn't using the rudders at all. I was pretty much just leaving those alone, but lots and lots of stick activity and lots and lots of workload to keep the airplane under control.

Pronounced propensity for overcontrol in both axes. I feel like there's a propensity for PIO that I'm providing the damping for. OK, for longitudinal HQR: it's controllable; adequate performance is obtainable. However, adequate performance requires considerable pilot compensation. I'd give that an HQR of 5, longitudinal.

Lateral directional: it's controllable; adequate performance is obtainable. However, moderate or considerable pilot compensation is required for adequate performance. I'd give that an HQR of 5. I just ... qualitatively, I don't feel like I'm working harder in either axis. I feel like it's hard in both axes pretty much uniformly.

Okay, for the precision landing from 400 ft down, I was able to get desired performance on everything except for the landing zone. I was consistently floating in the landing zone, and I would not correct for that. The problem being that large inputs really create problems in that area, you pretty much want to accept what you get, and I think, if you follow the end point all the way down and follow the flare cue, you're going to float in this control law. So I think the best I can do is adequate on this.

As far as longitudinal HQR: it's controllable; adequate performance is obtainable. However, adequate performance requires—well it's between considerable and extensive. I'm going to call it 6, because it's probably closer to extensive in the landing flare.

For lateral directional: qualitatively, lateral directional was a little bit easier than longitudinal. I felt like once I got the lateral directional suitcased, I could just pretty much leave it alone ... once I got the drift rate under control, and didn't have to worry about that, but the longitudinal you're really really working on coming in. Okay, as far as lateral directional: it's controllable, adequate performance is obtainable and requires considerable pilot compensation. Give that an HQR of 5. That concludes the comments.

Pilot C. Okay this is run number 80, and task number 7100, unaugmented landing. So the first comments are going to be for far out on the localizer for the pitch axis. I don't see much difference in the pitch axis now than I did on previous ones coming in without the SAS. Is it controllable? Yes. Is adequate performance

obtainable with a tolerable pilot workload? In this case, actually, I begin to wonder whether that's ... whether I can answer yes to that. I think I would prefer to give it a no. Adequate performance not obtainable with maximum tolerable pilot compensation, Cooper-Harper 7. And that's because the difficulties with everything combined makes it quite difficult to keep all of the parameters in order, including the pitch axis. The nose feels relatively loose, and it's a little bit difficult to make the attitude and/or the flight-path markers settle down in the proper place; when you have to do a bank combined, it just makes it that much harder. So for the pitch axis: Cooper-Harper 7. Now for the lateral directional axis: it was about the same difficulty. I was able to do it pretty much without using my feet to control the beta, and if I tried to control the beta with my feet, I was reasonably successful, but I preferred to just let the airplane take care of itself because I had so many other things to do. I was able to put the beta back in the center by using my feet when I tried to do that. The roll axis seemed to me about the same as before. I couldn't separate out any particular thing, but although ... again, in the lateral directional axis I'd still give the airplane a Cooper-Harper of 7, adequate performance not obtainable with maximum tolerable pilot compensation. Another point about that is, it was very difficult to roll out on the proper heading and keep the heading, this time, with the roll with the directional problem. Okay now, going to the part of the approach inside of 400 ft: is it controllable? Yes. Is adequate performance obtainable with a tolerable workload? No. I did have a feeling that considerable pilot compensation was required for control. I was able to ... the attention I was applying to it did make me feel like I was going to lose control of the airplane or exceed limits, so I would say adequate performance is not obtainable with maximum tolerable pilot compensation, and near the runway the compensation is quite large. The good news is the airplane is still landable, and if the touchdown spot tolerances are made larger, then we would be able to do a much better job of touchdown dot—H-dot—so pitch axis is a 7. And for the lateral directional axis there, having to start to play with the rudder pedals in close to the ground just made the rest of the task that much worse. Is it controllable in the directional axis? Yes. Is adequate performance obtainable with a tolerable workload? I think I still have to give it the same thing—major deficiency, adequate performance not obtainable with maximum tolerable pilot compensation, Cooper-Harper 7. And

when I think about the major difficulty, it's just having to deal with trying to put the beta back where you want it and keep the nose of the airplane where you want it when you have so many other things to do. It just makes that much more difficult. Cooper-Harper 7.

Pilot D. Okay, Pilot D on December 6. We just did the completely unaugmented landing, and initially I thought it was going to be significantly worse than the ... just the 7110 task because that Dutch roll is very slightly damped, and if there's any turbulence, it really sets it off. But by taking it very easy on the aircraft, it's fairly controllable. So I think the longitudinal is the dominating effect here. Let's see, any more comments there? Yeah. Yeah, I think if we had any more turbulence, the Dutch roll could very rapidly become completely unacceptable. But for this task the lateral doesn't seem to be completely out of feasibility. Okay, pilot ratings: approach—longitudinally, I think I did pretty good that time. I'm going to give it the same ratings as I did last time, a 7. It's just too loose in the pitch access. Now the lateral: I'm not sure what our performance was. I am assuming it was okay. It may or may not have been, but going up the outside I think it's Level II. Particularly if you had a longitudinal axis I think you could handle that lateral axis. But even in the presence of this horrible longitudinal axis, I was able to do reasonably well laterally. But let's make it a 6—lightly damped Dutch roll. Okay, for the landing: again, longitudinally, let's make it 7, and lateral, let's make it 6. It was adding to the workload ... my longitudinal workload just a little bit so I ... but it's 6, okay.

Pilot E. Okay, this is task 7100, unaugmented landing, pilot is E. Thank you, Dave, for that nice introduction. Okay, on this one, very similar to the previous unaugmented landing. I did not notice that much more difficulty with the lateral axis being unaugmented. I didn't notice any Dutch roll tendencies. It could be because 90 percent of my effort was put into the longitudinal task—the speed task. So I may just have stayed out of the lateral loop enough to [not] really excite anything, but I really couldn't tell a whole lot about the lateral axis losing its augmentation. So with that in mind, my comments from the previous approach remain, and I will only say that one of the problems with this is that when you do get to the very high gain task of setting the flare attitude, it's very difficult to establish and hold an attitude which results in ... in that case I got a little bit high when I tried to flare ... it ended up a little

bit high, so it just more or less floated and it's difficult, when you're slightly off when you flare, to readjust the proper attitude to save the approach. So in that case we floated. We started getting a little bit slow, but as soon as we touched down at 144 1/2, which is right where we want to be, it felt like we started to dip a little bit. I had to tip the nose forward just a little bit to get it coming down, and that gave us a little bit firmer sink rate. However, it's not that bad, and that certainly explains the long landing, long touchdown. So therefore, my comments from the previous configuration on unaugmented longitudinal axis are very much appropriate here. The ratings are probably going to be almost identical for the longitudinal up and away. Is it controllable? Yes. Is adequate performance obtainable? Yes. Is it satisfactory? Absolutely not. I rated it a 6 once again. Lateral directional: controllable? Yes. Adequate? Yes. Satisfactory? No. I rated it a 4. I met the desired criteria—just a little bit squirrely but almost imperceptible. This is real borderline Level I and Level II in lateral axis. For the landing: controllable? Yes. Adequate? Yes. This is for longitudinal. Satisfactory? Absolutely not. Once again, a 6. The reason being, I don't like the fact that I don't ... I can tend to really overcontrol my attitude in the flare, and that can result in a very high sink rate if you're ... if things don't work out just right. For lateral directional again, I didn't see a whole lot of problem in this. I almost ... I was so busy longitudinally that I didn't have a chance much to worry about lateral. My Y-dispersion was very good on both approaches. So I'm not having any trouble—of course, there are no winds or anything. I'm not having any trouble putting it in the box laterally, but so I'll say it is controllable; adequate performance is obtainable. Is it satisfactory without improvement? I'm going to say yes and give it a 3, only because I have absolutely no recollection of anything going on laterally that was annoying. It could be, it was there but it was masked by the very, very high longitudinal workload.

Task 7110, Unaugmented Landing—Longitudinal Axis Inoperative

Pilot A. Okay, this is task 7110, unaugmented landing, longitudinal axis inop. And is it controllable in longitudinal? Yes. Adequate performance attainable with a tolerable pilot workload? Well, it certainly is high workload, but it seems to be tolerable. Satisfactory without improvement? I'd say no. Deficiencies require improvement. I would say, give it a 6. Very

objectionable but tolerable deficiencies. Adequate performance requires extensive pilot compensation. Lateral-directional Cooper-Harper is basically the same. Is it controllable? Yes. Adequate performance? Yes. Without improvement? Good. Negligible. I give it a 2. And from 400 ft on down to nosewheel touchdown, longitudinal: is it controllable? Yes. Adequate performance? I seem to be getting adequate performance, in general, yes. Satisfactory without improvement? No. I would have to give it a 6 because of the pilot's need to anticipate instabilities in pitch and the very high—there's kind of a high workload situation. Lateral-directional Cooper-Harper: it seemed to be quite good. I give it a 1.

Pilot B. Run 70, task 7110, unaugmented landing, longitudinal axis inop, the glide-slope and localizer intercept, and this is in manual throttle. Workload is extremely high. Desired performance is obtainable but you are really, really working hard to get it. So longitudinal HQR, plus or minus half a dot: it's controllable, adequate. However, you're really working hard; this is more appropriate for Level II type performance. For longitudinal: I'd say considerable pilot compensation is required for either adequate or desired performance and give it an HQR of 5. Lateral directional: it's adequate, it's controllable—adequate and sat. However, for desired performance I'm looking at moderate pilot compensation. There is some crosstalk between the axes. I realize that the lateral directional was augmented, but you're working so hard in the longitudinal, you're spending more time in the lateral directional as well. So I'd give this an HQR of 4.

For the precision landing, the workload stays pretty constant all the way to touchdown. For longitudinal, it's controllable and adequate, however, again you're really working hard. I'd call it considerable pilot compensation and give it an HQR of 5. Two years? It's bordering on extensive compensation. Again, if I could give it half numbers I would, but I'll give it the benefit of the doubt and give it a 5. For lateral directional: pretty much the same workload as any approach. It's controllable and adequate; however, you'd have to say, it's moderate compensation involved to keep the lateral directional axis under control too, and give it an HQR of 4.

That concludes the comments. By the way, no tendency for PIO noticed in the lateral directional axis

[but] a pronounced tendency for PIO in the longitudinal axis. I felt like I was really having to work hard to keep from overcorrecting and getting out of phase with the airplane, but I was successful at it. And that concludes the comments.

Pilot C. Okay, yeah, most, alright I think I am probably to rate it. It's run number 78, task 7110, and it's unaugmented landing, longitudinal axis, and the part up to 400 ft is significantly more difficult task with trying to keep the attitude smooth. There's one aspect I like about it: the flight-path marker moves now, more like a real airplane instead of in little steps, where it just seems to have a better dynamic now. But of course, the lack of stability makes it more difficult to actually control where the marker is going to be. In the ... of course, these comments are for the pitch axis: it is controllable; adequate performance obtainable with tolerable pilot workload. Is it satisfactory without improvement? No. I would have to say very objectionable but tolerable deficiencies; adequate performance requires extensive pilot compensation—6—and the difficulty in controlling the pitch axis makes several things become worse. It makes your airspeed control become worse, and the glide-path and localizer control becomes worse, and heading control. All those things become bigger workload items now because of the poor pitch axis. Okay, that's pitch comments on localizer segment, and for lateral directional you are so overwhelmed by the pitch axis problems that the roll axis doesn't play much of a factor. You hardly notice that part of it, so it would look as if it is satisfactory without improvement. There are some mildly unpleasant deficiencies [with] minimal pilot compensation required for desired performance. Cooper-Harper of 3. That doesn't mean that it's improved over what it was before; it just means that it's ... that task is so suppressed compared to the other one now that is not so annoying. Okay, now we want to head below the 400 ft for the landing. For the pitch axis: is it controllable? Yes. Is adequate performance obtainable with a tolerable workload? My inclination is to say that adequate performance is not obtainable with maximum tolerable pilot compensation. Controllability is ... I didn't feel like controllability was a question really, so I think 7 is probably the right place for it. And the major deficiency is the lack of stability and significant increase in pilot workload in the pitch axis, which makes everything else difficult. The throttle control becomes difficult—airspeed—and the flare is far more

difficult to deal with. But for a failure mode, the airplane can be successfully landed that way. Cooper-Harper of 7. And for the lateral directional: again, one doesn't appreciate any significant problems in the lateral directional during that part of the exercise, or at least I didn't have any particular problem with it. I think I would give it a satisfactory without improvement. No. I would give it minor but annoying deficiencies: Cooper-Harper of 4. And it's hard to define that because the pitch task is so much more dominant.

Pilot D. Pilot D on December 6. We just did the unaugmented longitudinal landings, unaugmented longitudinally landing, 7110; we end up on run 54. The airplane is very, very loose longitudinally. There doesn't seem to be any restoring moment, if any. And it's also very lightly damped, which contributes to a tendency to PIO and pitch. It's not bad enough that it's not controllable, but definitely warrants some sort of a backup system; backup dampers or something would really help. Two other things that are giving me problems are the airspeed control—I think primarily because of the display, as before in the lag and in the X-double-dot display, longitudinal acceleration—and the flight-path symbology group, that is, the flight-path symbol on the tape, the longitudinal acceleration. All of those symbols are all white. When you get down into the ... close to the approaching the flare, all that symbology gets lost in all the white lines that make up the runway symbology also. It's very difficult to see what's going on there. Room for improvement there. Pilot ratings: Approach—longitudinally, I am going to ignore my airspeed. I think that's just a little bit different technique. There's no need to get slowed down real early, so I'm going to give it ... now wait. Let me go over the left-hand side and do this right. Is adequate performance obtainable with a tolerable pilot workload? Well, that's definitely true, but I think the deficiencies require improvement. I think it's too loose longitudinally to turn loose. You need to have some redundant, or backup, system, I think. I don't think you would want to try and fly an airplane like that. Let's give it a 7. Major deficiencies: deficiencies require improvement; so that was a 7. Okay, and that's too loose. Okay, laterally we can give it its good ol' 4. Landing, it falls right into the same category. I think we were doing all right on the landing, but you know, I wouldn't want to turn that thing loose. Let's give it a 7 also, with a 4 for lateral. Okay.

Pilot E. Okay, this is task 7110, unaugmented landing with longitudinal axis inop. The ... interesting task ... the last approach I ... you people were looking at the data strips. On the second approach I had a headset come off. When I was fighting to find the headset—this was subsequent to my ear itching—I took my hands off the stick and throttle and the airplane kind of dove, so we had a big glide-slope excursion, which later manifested itself in an airspeed excursion in an interesting ride to touchdown. However, on the first and third, especially third, it was a much more stable approach in my opinion. I met the desired criteria for airspeed control, glide-slope control, and localizer control on the last one. For the up and away and for the precision landing it was just barely outside the desired for H-dot, and everything else was desired. So that tends to make me think, with a sufficient amount of workload, that you can complete this task in desired criteria. However, the problem is, if you are not actively in the loop, the airplane can diverge very, very rapidly. And as we saw when my headset fell off, I just absolutely ... for just a second or two took my hands off the stick and throttle and got almost a full dot excursion glide slope—probably a dot and a half. So there's a real problem with that. The airplane ... if you have the ability to fly the airplane ... but the workload is extremely high and if any moment of tension can result in very quickly divergent performance ellipsis. So I'm up with the situation, where I met pretty much desired criteria, but certainly I cannot call this a desirable configuration. So, is it controllable? Yes it is controllable. This is for longitudinal up-and-away Cooper-Harper. Is adequate performance attainable with a tolerable workload? Yes it is. Is it satisfactory without improvement? No. Even though I met the desired criteria for up and away, I am going to rate this a 6, mainly because that performance does require considerable pilot compensation, and I don't like the fact that if you get out of the loop even for a split second you would go to almost borderline loss of control. So I was able to meet the performance criteria; however, I am also having to work to maintain control. So this rating configuration really could be rated more Level III, except that I almost met desirable criteria. For lateral-directional Cooper-Harper: is it controllable? Yes. Is adequate performance attainable? Yes. Is it satisfactory without improvement? I would say yes and rate it a 3. There's just this: basically I had no remembrance of anything laterally going on—clearly

dominated by the longitudinal task, for the precision landing, pretty much, since the last one, which I think was more definitive of the approaches. I'll throw out the second one. Oh, the second one worked ... resulted in a fairly decent save ... it shows numbers certainly pretty to look at. The ... and my ... stable, tending to complement myself with more making notes ... configuration has the ability to respond to pilot inputs, and I was very lucky. Okay, for the longitudinal task—the longitudinal rating: is it controllable? Yes it is. Adequate performance attainable? Yes, it's true, it is. Is it satisfactory without improvement? Absolutely not. Even though I met almost desired criteria for that last approach for the landing, I'm going to rate it a 6. The problem being that you can get into a pitch PIO, up and away, and in close. And the pitch PIO in close is a very—kind of low frequency, high magnitude. You

get very, very large pitch excursions—pitch or gamma excursions—which could result in very high sink rates. We were fortunate on the second approach, but the ... it's difficult to say if it's really PIO. It's more of a ... if you make an input, it tends to be divergent. And then if you start the nose coming down, it way overshoots your intention. So I guess the PIO is potential, and I did see some cases where I thought I was going to PIO, but more cases of just ... it's just divergent when you make an input, and it way overreacts to what you request. For lateral directional: again, no problem there. Controllable? Yes. Adequate? Yes. Satisfactory? Yes, a 3. The main thing to understand is, 6's are probably the highest ratings just because of performance, but certainly not reflective of potential problems you can have.

Appendix D

Flight Cards

Abbreviations and Symbols

AGL	above ground level
ALT, H	initial altitude, ft
AOA	angle of attack, deg
A/P	autopilot
APC	aircraft-pilot coupling
A/T	autothrottle
accel	acceleration
app, appr	approach
BGV	Boeing $\dot{\gamma}/V$ longitudinal control system
Cat	category
CDU	control display unit
C.G., CG	center of gravity, percent \bar{c}
CHR	Cooper-Harper rating
$C_{M\Delta P}$	pitch acceleration with changes in power
\bar{c}	mean chord length, ft
config	configuration
DME	distance measuring equipment, in this study, measures distance from brake release, nmi
DPB	Douglas p/β lateral-directional control system
decel	deceleration
EPR	engine pressure ratio
F/D	flight director
FL	flight level, hundreds of feet

Flt	flight
FPM	feet per minute
Fwd	forward
Grad1	initial climb gradient for the PLR procedure, percent
Grad2	secondary climb gradient for the PLR procedure, percent
G/S	glide slope
GW	gross weight, lb
Hdg	heading
HUD	head-up display
ILS	Instrument Landing System
Inop	inoperable
\dot{H}	initial horizontal tail deflection
KCAS	calibrated airspeed, knots
KEAS	equivalent airspeed, knots
KIAS	indicated airspeed, knots
kts	knots (nm/hr)
Lat	lateral
LEF	initial leading-edge flap deflection, positive down, deg
LOC	localizer
Long	longitudinal axis control rating
M	Mach
M_D	maximum Mach
M_{MO}, M_{mo}	maximum operating Mach
MCF	final cruise mass case (384 862 lb)
MCT	maximum continuous power setting

Max	maximum
Min	minimum
Mod	moderate
MTE	mission task element
MTOW	maximum takeoff weight
N/A	not applicable
OM	outer marker of ILS approach system
PF	pilot flying
PIO	pilot induced oscillations
PLR	program lapse rate takeoff procedure
PNF	pilot not flying
PSCAS	pitch-axis stability and control system
R/C	rate of climb
RSCAS	roll and yaw axis stability and control system
Rwy	runway
rot	rotation
SDB	Structural Dynamics Branch at Langley Research Center
Tanner	developed landing-gear cornering model from SDB
TCA	terminal control area
TEF	initial trailing-edge flaps, positive down, deg
TFLF	thrust for level flight
T0	initial thrust level, percent net thrust
T1	first cutback thrust level for PLR procedure, percent net thrust
Turb	turbulence
VMCA, V_{mca}	minimum airborne control speed, knots

V_{MCG}, V_{mcg}	minimum control speed on ground, knots
V_{MCL-2}, V_{mcl-2}	minimum control speed with 2 engines on the same side failed, knots
V_D	maximum speed, knots
V_{LO}	estimated lift-off speed, knots
V_{app}	approach speed, knots
V_{climb}, V_c	climb speed for PLR task
V_{ef}	engine failure speed, knots
$V_{g/a}$	go-around airspeed, knots
V_{man}	maneuvering speed, knots
V_{min}	minimum speed to maintain 3-percent climb gradient with one engine failed or minimum speed during approach, knots
V_{mo}	maximum operating speed, knots
V_r, V_r	takeoff rotation speed, knots
V_{ref}	reference approach speed, knots
V_1, V_1	takeoff decision speed, knots
V_2, V_2	one engine failed safety speed, knots
$V_2 + 10$	climb speed for non-PLR tasks
V-vector	velocity vector

Cards

An index to the flight cards are given in the following table:

Task	Name	Page
1050	Rejected Takeoff—0-Knot Crosswind	408
1051	Rejected Takeoff—15-Knot Crosswind	409
1052	Rejected Takeoff—35-Knot Crosswind	410
2010	Acoustic Profile Takeoff	411
2030	Acoustic Programmed Lapse Rate Takeoff	412
3020	Transition to Level Flight	413
3022	Transition to Supersonic Cruise	414
3030	Profile Climb	415
3040	Level Flight Transition to Climb	416
3050	Profile Descent	417
3060	Transition to Supersonic Descent	418
3062	Transition to Transonic Descent	419
3070	Airspeed Change in Subsonic Climb	420
3072	Airspeed Change in Supersonic Cruise	421
3074	Transonic Deceleration	422
3076	Airspeed Change in Low Altitude Cruise	423
3080	Heading Change in Transonic Climb	424
3084	Heading Change in Supersonic Cruise	425
3086	Heading Change in Low Altitude Cruise	426
3088	Heading Change in TCA Descent	427
4012	Configuration Change in Straight Flight—Moderate Turbulence	428
4020	Nominal Approach and Landing	429
4025	Nominal Approach and Landing With Flight Director	430
4050	Precision Landing	431
4062	Landing From Lateral Offset—Moderate Turbulence	432
4066	Landing From Lateral Offset—Category I, Moderate Turbulence	433
4072	Landing From Vertical Offset—Moderate Turbulence	434
4076	Landing From Vertical Offset—Category I, Moderate Turbulence	435
4080	Go-Around	436
4085	Go-Around With Minimum Altitude Loss	437
4090	Crosswind Approach and Landing [15 Knots]	438
4095	Crosswind Approach and Landing, 35 Knots	439
4100	Category IIIa Minimums Landing	440
4110	Approach and Landing With Jammed Control	441
5010	Stall—Idle Power	442

Task	Name	Page
5020	Stall—Maximum Takeoff Power	443
5040	Turning Stall—Idle Power	444
5050	Turning Stall—Thrust for Level Flight	445
5060	Diving Pullout	446
5070	Emergency Descent	447
6040	Center of Gravity Shift—High Speed	448
6050	Inadvertent Speed Increase	449
6060	Two-Axis Upset	450
7010	Directional Control With One Engine Inoperative	451
7020	Lateral Control With One Engine Inoperative	452
7030	Minimum Control Speed—Ground	453
7035	One-Engine-Out Takeoff	454
7040	Minimum Control Speed—Air	455
7050	Dynamic VMCL-2	456
7060	Ripple Unstart	457
7070	Engine-Out Stall	458
7080	Engine-Out Turning Stall	459
7090	All-Engines-Out Landing	460
7095	Manual Throttle Landing	461
7100	Unaugmented Landing	462
7110	Unaugmented Landing—Longitudinal Axis Inoperative	463

18 Dec 95

17B.305.102.0.7 Landing From Vert. Offset - Cat I / Mod Turb 4076

Date: _____ Pilot: _____ Runs: _____

Flight Phase	MTE	Weather State	Failures	Landing
17B. 400 ft AGL w/ G/S Offset	305. Precision Landing from Vertical Offset	102. Cat I Minimums - Moderate Turb	0. None	7. MCF- Final Cruise, Alt C.G.

ALT : 400	V _{man} 133	PSCAS : BGV	ABNORMALS/EXCEPTIONS: NONE
GW : 384,862	V _{app} 157	RSCAS : DPB	
C.G. : 53.2	V _{ref} 152	A/T : ON	
GEAR : DOWN	V _{g/a} 159	HUD : ON	
TEF/LEF : Auto	KEAS 157	F/D : OFF	
H : Trim	V _{min} 133	A/P : OFF	

Rwy Hdg	Wind Speed / Dir	Ceiling	Visibility	Rwy Surface	Initial Position
360	0/000	200 ft	0.5 nm	Dry, Grooved	400 ft AGL On LOC On offset G/S

Note: ILS system glideslope should be artificially offset so runway intercept is 500 further down the runway.

Procedure-Evaluation Pilot (PF):

1. PF establishes aircraft in steady descending flight at the noted conditions.
2. PF tracks LOC and G/S using HUD.
3. On breakout of clouds, PF visually maneuvers to correct the offset and touchdown on the aim point on the runway with a normal flare and landing.
4. After touchdown, PF lowers the nosewheel to the runway while retarding thrust to idle.
5. After nosewheel touchdown, apply full braking until below 80 knots, maintaining runway centerline.

Procedure-Test Engineer / Pilot Not Flying (PNF):

1. Reset simulator to noted conditions.
2. At breakout, call "Runway in sight".

Evaluation Segment	Precision Vertical Offset Landing	Long CHR	Lat / Dir CHR
Start Evaluation:	400 ft. AGL, Landing Speed, Descending, On LOC		
End Evaluation:	Nosewheel Touchdown		

Evaluation Basis: Evaluate the ability to recover from an off-nominal glideslope. Evaluate effectiveness of approach aids in correcting for off nominal glideslope. There should be no tendency for APC's, or to bobble in pitch or roll. There should also be no tendency to float or bounce after touchdown.

Performance Standards	Target	Desired	Adequate
Landing Zone (for ref. point btwn main gear) (ft)	Aim Point	50 x 500	100 x 1000
Maximum Bank Angle Below 50 ft AGL (deg)	0	±5	±7
Deviation from Landing Airspeed at Touchdown (KIAS)	140	±5	±10
Maximum Touchdown Sink Rate (ft/sec)	≤3	3	6
Deviation from Runway Heading at Touchdown (deg)	0	±2	±4

2A.100.1.0.3 One Engine Out (OEO) Takeoff 7035

Flight Phase	MTE	Weather State	Failures	Loading
2A. Takeoff	100. OEO continued Takeoff	1. Light Turbulence	0. None	3. M13

ALT: Field	V ₁ : 188	PSCAS : BGV	ABNORMALS/EXCEPTIONS:
GW : 649914	V _r : 174	RSCAS : DPB	NONE
C.G. : 48.1	V _{L0} : 192	A/T : OFF	Lift off pitch attitude=10.5 degs
GEAR : DOWN	V ₂ : 209	HUD : ON	rot. pitch accel/decel=1.5/2.5 degs/sec-sq
LEF/TEF : 30/10	V ₂₊₁₀ : 219	F/D : OFF	rot. steady state pitch rate=3.0 degs/sec
	V _{min} : 181	A/P : OFF	Takeoff EPR: Max

Rwy Hdg	Wind Speed / Dir	Ceiling	Visibility	Rwy Surface	Initial Position
360	0/000	Unlimited	Unlimited	Dry, Grooved	End of Rwy, On Centerline

Procedure-Evaluation Pilot (PF):

- Set brakes after going into operate mode.
- Advance throttles to takeoff EPR (100%).
- Release the brakes and maintain centerline during ground roll. PNF will make airspeed call-outs, and monitors engine performance.
- At V₁ continue takeoff and accelerate aircraft to V_r.
- At rotation speed (V_r), initiate rotation to follow rotation rate pitch guidance indicators and maneuver the aircraft to intercept the lift off rotation pitch attitude. After liftoff, resume pitch rotation to capture and follow velocity vector guidance symbol.
- At positive climb-rate, call "gear-up".
- Terminate maneuver at 6.0 DME. Data is not needed for acoustic calculations.

Procedure-Test Engineer / Pilot Not Flying (PNF):

- Reset simulator to noted conditions.
- Make airspeed call-outs at 100 knots, and V₁.
- When engine failure is observed, call out "engine # failed, continue takeoff".
- Make airspeed call-out at V_r.
- Move gear handle to gear-up position, when requested by PF.
- Monitor gear retraction and automatic Vortex Fence extension and retraction.
- Terminate maneuver at 6.0 DME. Data is not needed for acoustic calculations.

Notes on maneuver: This maneuver is to be performed with the leading- and trailing-edge flaps fixed to 30/10 degrees.

7/27/98

Date: _____ Pilot: _____ Runs: _____

Evaluation Segment:	Runway Centerline Tracking	Long CHR	Lat / Dir CHR
Start Evaluation:	Stopped on Runway		
End Evaluation:	Liftoff	NA	

Evaluation Basis: The pilot is to evaluate the ease of tracking the runway centerline with rudder pedals alone as the aircraft accelerates during the takeoff roll.

Performance Standards	Target	Desired	Adequate
Runway Centerline Deviation (feet)	0	±10	±27

Evaluation Segment:	Takeoff Rotation	Long CHR	Lat / Dir CHR
Start Evaluation:	V ₁		
End Evaluation:	Liftoff		

Evaluation Basis: The pilot is to evaluate the promptness of the rotation, ease of tracking pitch rate guidance indicators, establishing lift-off pitch attitude, and ability to maintain runway centerline tracking during this maneuver sub-phase. Tail strike should not occur during this maneuver.

Performance Standards	Target	Desired	Adequate
Liftoff Pitch Rate Control (deg)	generated	<±5 bracket 90% of time	<±1 bracket 90% of time
Climb Pitch Attitude Control (deg)	10.5	±.5	±1
Runway Centerline Deviation (feet)	0	±10	±27

Evaluation Segment:	Climb with Configuration Changes	Long CHR	Lat / Dir CHR
Start Evaluation:	Liftoff		
End Evaluation:	6.0 DME from brake release		

Evaluation Basis: The pilot is to check the handling qualities in climb while following the velocity vector guidance symbol. Check for objectionable transients in airplane response during maneuver. Monitor airspeed control during climbout. Climb speed, V_c, is 219 kts.

Performance Standards	Target	Desired	Adequate
Longitudinal velocity vector control (deg)	generated	<±1 V-vector height 90% of time	<±2 V-vector height 90% of time
Lateral velocity vector control (deg)	generated	<±1 V-vector width 90% of time	<±2 V-vector width 90% of time

Appendix E

Guidance Algorithms

Rotation and Takeoff Guidance

HUD guidance was provided to the pilots to help them perform consistent and accurate rotations and takeoffs. Rotation guidance included information regarding pitch rotation rate and acceleration as well as target pitch attitude. Incorporation of this system was intended to standardize the rotation task and provide adherence to consistent, specified performance parameters. Incorporation of this system was intended to standardize the rotation task and provide adherence to consistent, specified performance parameters such as steady-state pitch rate and pitch rate accelerations. The desired rotation rate profile began at V_r , and employed a pitch acceleration of 1.5 deg/sec^2 , a steady-state pitch rate of 3.0 deg/sec , and a deceleration of 2.5 deg/sec^2 when approaching the target pitch attitude. Additionally, the target liftoff pitch attitude (10.5°) was displayed to the pilots. Desired pitch rate performance was $\pm 0.6 \text{ deg/sec}$ during 90 percent of the maneuver, and adequate performance was $\pm 1.2 \text{ deg/sec}$ during 90 percent of the maneuver. See figures 6 and B7 for a display of the HUD in this configuration.

Takeoff climb guidance was provided to the pilots to facilitate the generation of consistent takeoff trajectories which were required to accurately assess the noise characteristics of the vehicle. The presentation of the guidance was in the form of a velocity-vector guidance symbol as shown in figure 6. Desired and adequate goals were established for the pilot to gauge his performance. As can be seen in figure 7, the pilot's task was to keep the commanded velocity vector within certain limits of the velocity-vector guidance symbol. This appendix provides details regarding the movement of the velocity-vector symbol.

Lateral Movement of Velocity-Vector Guidance Symbol

The lateral movement of the velocity-vector guidance symbol was defined by the movement of the commanded velocity vector combined with a lateral error variable. Basically, the task of the pilot was to null the longitudinal and lateral error variables.

Total lateral error E_{lat} was a combination of four individual parameters multiplied by a scaling factor as follows:

$$E_{\text{lat}} = K_{\text{lat}}(E_1 + E_2 + E_3 + E_4) \quad (\text{E1})$$

where $K_{\text{lat}} = -0.01 \text{ deg/deg}$. The lateral error signal was limited to $\pm 10^\circ$ of HUD travel.

Lateral error E_1 was determined by the distance between the aircraft center of gravity and the extended runway centerline as follows:

$$E_1 = K_1 y \quad (\text{E2})$$

where

y distance from runway centerline, ft

$K_1 = 1 \text{ deg/ft}$

Lateral error E_2 introduced track angle to provide some artificial damping when trying to intercept and maintain runway centerline; this also provided guidance to maintain the runway heading when exactly over the extended runway centerline as shown in the following equation:

$$E_2 = K_2(\chi - \chi_{\text{ref}}) \quad (\text{E3})$$

where

χ aircraft actual track angle, deg

χ_{ref} runway track angle, deg

$K_2 = 50 \text{ deg/deg}$

Lateral error E_3 provided some bank angle limiting so that the pilot would not be inclined to use very high bank angles to follow the velocity-vector guidance symbol; this also provided guidance to maintain wings-level flight when exactly over the extended runway centerline as shown in the following equation:

$$E_3 = K_3\phi \quad (\text{E4})$$

where

ϕ aircraft bank angle, deg

$K_3 = 5 \text{ deg/deg}$

Lateral error E_4 was included to provide some quick response when a lateral command was issued and to reduce tendencies of the pilot to overcontrol bank angle as follows:

$$E_4 = K_4p \quad (\text{E5})$$

where

p body axis roll rate, deg/sec

$K_4 = -0.5 \text{ deg/deg/sec}$

Total lateral error E_{lat} was limited to $\pm 10^\circ$.

Vertical Movement of Velocity-Vector Guidance Symbol

The vertical movement of the velocity-vector guidance symbol depended on the type of takeoff selected. For takeoffs involving flight-path control, such as the PLR takeoff, the velocity-vector guidance symbol would simply indicate the desired climb gradient (4 percent) as illustrated in figure 7. For takeoff tasks that required the pilot to intercept and maintain a specific climb speed, which was true for all other takeoff maneuvers, the vertical movement of the velocity-vector guidance system was based on airspeed error and the aircraft acceleration along the flight path.

The block diagram of the algorithm used to generate the vertical movement of the velocity-vector guidance symbol is given in figure E1. The algorithm generated a commanded flight-path angle adjustment γ_{VVG} , which was added to the commanded longitudinal velocity-vector position.

In figure E1, V_{ref} is the complementary filtered airspeed. The variables K_{DVFD} and K_{DVDOT} were adjusted during real-time piloted simulation checkout to provide desired system performance with K_{DVFD} being set to 0.20 and K_{DVDOT} being set to 0.7.

The variable V_{ct} , the current commanded airspeed in knots, was defined, after liftoff as

$$V_{ct} = V_{lo} + V_{DOTC} dt \quad (E6)$$

and was limited to being less than or equal to the specified climb speed V_c . The variable V_{DOTC} is the current commanded acceleration in knots per second. Before intercepting the desired climb speed, V_{DOTC} was equal to 1.7 knots/sec, which is the nominal acceleration in knots per second.

When the current airspeed of the aircraft was within 7 knots of the desired climb speed, V_{DOTC} was linearly ramped down to zero over 8 sec to facilitate the capture.

Limits were placed on γ_{VVG} to keep the system from commanding unacceptable flight paths. The lower limit was set to a 3-percent (1.718°) climb gradient. This value was used because it is the climb gradient used by the FAA to evaluate OEO (one-engine-out) low-altitude climb performance of the aircraft. The upper limit on γ_{VVG} was set to 15° , which really was never a factor.

SW1 enabled the longitudinal velocity-vector guidance system to activate. It would close, and activate the system, once the aircraft was airborne.

Method for Calculating Complementary Filtered Airspeed

The variables used in the complementary filter are defined as follows:

$\dot{\alpha}_I$	estimate of rate of change of angle of attack, deg/sec
$\dot{\beta}_I$	estimate of rate of change of sideslip angle, deg/sec
\dot{V}_I	estimate of rate of change of inertial velocity, knots/sec
α_{comp}	complementary filtered angle of attack, deg
β_{comp}	complementary filtered sideslip angle, deg
ϕ	aircraft bank angle, deg
g	acceleration due to gravity, ft/sec ²
$N_{X, cg}$	longitudinal acceleration of aircraft center of gravity
$N_{Y, cg}$	lateral acceleration of aircraft center of gravity

$N_{Z, cg}$	vertical acceleration of aircraft center of gravity
θ	aircraft pitch attitude, deg
p	aircraft body axis roll rate, deg/sec
q	aircraft body axis pitch rate, deg/sec
r	aircraft body axis yaw rate, deg/sec
$V_{T, \text{lim}}$	aircraft true airspeed, limited to being greater than or equal to 200 ft/sec
$\tau_{\alpha_{\text{comp}}}$	angle-of-attack complementary filter time constant, 0.5 sec
$\tau_{\beta_{\text{comp}}}$	sideslip complementary filter time constant, 0.5 sec
$\tau_{V_{\text{comp}}}$	airspeed complementary filter time constant, 5.0 sec

The rate of change of inertial angle of attack (degrees per second) is estimated as follows:

$$\dot{\alpha}_I = -57.3 \frac{g}{V_{T, \text{lim}}} \left(N_{Z, cg} \cos \alpha_{\text{comp}} + N_{X, cg} \sin \alpha_{\text{comp}} - \cos \theta \cos \phi \cos \alpha_{\text{comp}} - \sin \theta \sin \alpha_{\text{comp}} \right) + q \quad (\text{E7})$$

Note that the previous iteration value of α_{comp} was used to estimate $\dot{\alpha}_I$. The rate of change of inertial sideslip angle (degrees per second) is estimated as follows:

$$\dot{\beta}_I = 57.3 \frac{g}{V_{T, \text{lim}}} (N_{Y, cg} + \cos \theta \sin \phi) - r \cos \alpha_{\text{comp}} + p \sin \alpha_{\text{comp}} \quad (\text{E8})$$

Note that the previous iteration value of α_{comp} was used to estimate $\dot{\beta}_I$. The rate of change of inertial velocity (knots per second) is estimated as follows:

$$\dot{V}_I = \frac{g}{1.6878} \left(N_{X, cg} \cos \alpha_{\text{comp}} - N_{Z, cg} \sin \alpha_{\text{comp}} + N_{Y, cg} \sin \beta_{\text{comp}} - \sin \theta \cos \alpha_{\text{comp}} + \cos \theta \cos \phi \sin \alpha_{\text{comp}} + \cos \theta \sin \phi \sin \beta_{\text{comp}} \right) \quad (\text{E9})$$

Note that the previous iteration values of α_{comp} and β_{comp} were used to estimate \dot{V}_I . The estimated values for $\dot{\alpha}_I$, $\dot{\beta}_I$, and \dot{V}_I are then used to generate filtered values of airspeed V_{ref} , angle of attack α_{comp} , and sideslip β_{comp} as shown in figure E2.

Profile Climb Guidance

Guidance was provided to the pilot for the profile climb task in two ways: the magenta velocity-vector guidance symbol was positioned vertically on the HUD to steer the aircraft in a vertical sense to capture and track the desired altitude-airspeed trajectory, and the velocity-altitude display (VHD) was

presented on a head-down display to provide secondary guidance information. The VHD display is shown in figure B5. The logic to drive both displays is shown in figure E3.

Flight Director Guidance

Altitude (Alt), inertial velocity ($V_{\text{total},i}$), and equivalent airspeed (EAS) were used as inputs to the guidance algorithm shown in figure E3. Altitude and inertial velocity were combined to form current total specific energy, which was used as the independent variable to look up scheduled altitude, equivalent airspeed, and flight-path angle in a linear table interpolation. This table was based upon precomputed fuel-optimal mission profiles. Errors in altitude and equivalent airspeed were used to modify the scheduled flight path through proportional and integral paths to form the commanded flight path, which was displayed to the pilot on the HUD.

Head-Down Guidance

The VHD provided a plot of altitude versus equivalent airspeed for the desired path, the present vehicle state, and the actual path of the vehicle relative to the design envelope of the aircraft. To provide additional guidance to the pilot, a predicted path was projected 40 sec ahead of the present vehicle position. The derivation of the relationships and the algorithm to calculate this projection is given in this section.

Derivation: A predicted vertical flight path is generated by using the time rate of change of specific energy \dot{e} to estimate the specific energy e of the vehicle at some point in the future. This energy estimate, along with a prediction of either velocity or altitude, is used to estimate the other quantity.

The specific energy e of the vehicle is the sum of kinetic and potential energy per unit mass as follows:

$$e = \frac{1}{2}V^2 + gh \quad (\text{E10})$$

where

V local velocity, ft/sec

g gravitational acceleration, ft/sec²

h altitude, ft

To predict the energy state of the vehicle in the future, the time rate of change of specific energy \dot{e} can be calculated from successive simulation frames:

$$\dot{e} = \frac{e_n - e_{n-1}}{t_n - t_{n-1}} \quad (\text{E11})$$

where t is simulation time in seconds. This same numerical differentiation should be made to calculate the time rate of change of the density ratio:

$$\dot{\sigma} = \frac{\sigma_n - \sigma_{n-1}}{t_n - t_{n-1}} \quad (\text{E12})$$

where σ is the ratio of atmospheric density to sea level atmospheric density ρ_0 .

An estimate of future energy at time t_2 can be calculated by using a simple Euler integration:

$$\hat{e}_{t_2} = e_{t_1} + \dot{e}_{t_1} \Delta t \quad (\text{E13})$$

where Δt is the amount of time advance desired and is equal to $t_2 - t_1$.

To predict how this future energy will be distributed, we choose to estimate the altitude (potential energy) of the vehicle at time t_2 and then calculate the resulting velocity (kinetic energy). Since rate of climb \dot{h} is given by

$$\dot{h} = V \sin \gamma \quad (\text{E14})$$

(where γ is the vertical flight-path angle of the center of gravity, in radians above the horizon), we can differentiate to generate vertical acceleration \ddot{h} as follows:

$$\ddot{h} = \dot{V} \sin \gamma + V (\cos \gamma) \dot{\gamma} \quad (\text{E15})$$

To estimate the time rate of change of flight-path angle, we use the approximation

$$\dot{\gamma} \approx -\frac{g}{V} (N_z \cos \phi + \cos \gamma) \quad (\text{E16})$$

where N_z is Z body axis acceleration in g units and ϕ is bank angle in degrees. The prediction of future altitude, by using an Euler integration for climb rate and a trapezoidal integration for altitude, becomes

$$\hat{h}_{t_2} = \hat{h}_{t_1} + \ddot{h}_{t_1} \Delta t \quad (\text{E17})$$

$$\hat{h}_{t_2} = h_{t_1} + \frac{1}{2} (\hat{h}_{t_2} + \dot{h}_{t_1}) \Delta t \quad (\text{E18})$$

We now have predictions of the specific energy and the altitude of the vehicle at time t_2 . All that remains is to calculate the estimated equivalent velocity at t_2 as well. With the definition of specific energy (eq. (E10)), we get

$$\hat{V}_{t_2} = \sqrt{2(\hat{e}_{t_2} - g\hat{h}_{t_2})} \quad (\text{E19})$$

as an estimate of the true velocity at t_2 in feet per second. This estimation must be converted to equivalent airspeed by using a prediction of σ as follows:

$$\hat{\sigma}_{t_2} = \sigma_{t_1} + \dot{\sigma} \Delta t \quad (\text{E20})$$

thus

$$(\hat{V}_{\text{equiv}})_{t_2} = \hat{V}_{t_2} \sqrt{\hat{\sigma}_{t_2}} \quad (\text{E21})$$

This predicted equivalent velocity \hat{V}_{equiv} may now be converted to knots for final display.

Algorithm

To generate a predicted flight path, a series of predictions of future altitude and equivalent airspeed is made from present conditions for $\Delta t = 10, 20, 30,$ and 40 sec in the future with a straight-line segment drawn to these coordinates on the display from the present position. Estimates of the rate of change of specific energy and atmospheric density ratio at the present time are made by using equations (E11) and (E12). The present value of vertical acceleration is calculated by using equation (E15) and vertical climb rate is calculated from equation (E14). Starting with $\Delta t = 10$, the future specific energy at time $t + \Delta t$ is estimated with equation (E13); similar estimates for altitude rate, altitude, and velocity are generated with this result and equations (E17), (E18), and (E19). The estimated future velocity is converted to knots equivalent by the proper scaling and equation (E21). Estimated altitude and equivalent airspeed are then displayed for this value of Δt , and the prediction loop repeats for Δt values of 20, 30, and 40 sec.

Approach and Landing Guidance

The primary guidance supplied to the pilot for the approach and landing tasks consisted of a standard ILS glide-slope and localizer display shown on the HUD as illustrated in figure E4. This symbology was present on the HUD during all the approach and landing tasks. A flare guidance symbol was also supplied on the HUD for all the approach and landing tasks. An explicit flight director symbol, indicated in figure E4, was provided for only one of the approach and landing tasks, the nominal approach and landing with flight director (task 4025). The operation of the flight director symbol and the flare guidance symbol is described in the following sections. Also present on the HUD was a tail-strike attitude indicator bar whose position varied as a function of altitude to depict the pitch attitude at which the aircraft tail would contact the runway. This symbol was of particular importance in the go-around tasks (4080 and 4085) because it allowed the pilots to avoid tail strikes during the go-around pitch-up maneuver.

Operation of Flight Director Symbol Used in Task 4025

This element of the display is an adaptation of the HUD guidance algorithms and symbology developed for use with the NASA Ames HSCT simulation.¹ The flight director symbol shown in figure E4 represents an aircraft that is flying down the ILS approach trajectory ahead of the pilot's aircraft. To perform an approach, the pilot flies in formation behind an imaginary leader aircraft by placing his

¹ Unpublished work from Richard S. Bray, Distinguished Research Associate, Ames Research Center.

flight-path marker symbol on the velocity-vector guidance symbol. This form of flight director has been referred to as “pursuit guidance.” When atmospheric disturbances cause the aircraft to vary from the ideal trajectory, the flight director symbol provides a flying reference for recapturing the ideal approach profile. The algorithm that was used to drive this symbol is described below. As noted earlier, this symbol was provided for only one of the approach and landing tasks, the nominal approach and landing with flight director (task 4025). The location of the flight director symbol relative to the origin of the pitch ladder is shown in figure E5. The locations x and y are defined as follows:

$$x = \Delta\psi - K_{loc} E_{loc} \frac{1}{\tau_{loc}s + 1}$$

$$y = \gamma_{GS} - K_{GS} E_{GS} \frac{1}{\tau_{gs}s + 1}$$

The parameters in these equations are defined as follows:

$\Delta\psi$ is heading offset from runway, deg

$$E_{\psi} = 260^{\circ} - \psi$$

$$\Delta\psi = E_{\psi} - 360^{\circ} \quad (E_{\psi} > 180^{\circ})$$

$$\Delta\psi = E_{\psi} + 360^{\circ} \quad (E_{\psi} < 180^{\circ})$$

$$\Delta\psi = E_{\psi} \quad (\text{Otherwise})$$

K_{loc} is gain on angular offset from localizer

$$K_{loc} = 0.0004 (27000 - x_{cg}) \quad (0 < K_{loc} < 18)$$

where x_{cg} is distance from vehicle center of gravity to runway threshold in feet, negative and τ_{loc} is lag time constant on angular offset from localizer

$$\tau_{loc} = 0.15K_{loc}$$

γ_{GS} is ILS glide-slope descent angle, deg

$$\gamma_{GS} = -3.0^{\circ}$$

Flare guidance: If $h_{gear} < 50$ ft, then $\gamma_{GS} = -0.2^{\circ}$ where h_{gear} is landing gear height above runway and γ_{GS} is subject to a *rate* limit of 0.42 deg/sec.

K_{GS} is gain on angular offset from glide slope

$$K_{GS} = 0.0005 (5000 - x_{cg}) \quad (0 < K_{GS} < 10)$$

E_{GS} is angular offset from glide slope, deg

$$E_{GS} = \text{Arctan} \left(\frac{E_h}{X_{ILS}} \right)$$

where E_h is vertical offset of center of gravity from glide slope in feet.

τ_{gs} is lag time constant on angular offset from glide slope

$$\tau_{gs} = 0.10K_{GS}$$

E_{loc} and E_{GS} are localizer and glide-slope errors computed as depicted in figure E6.

Operation of Flare Guidance Symbol for Approach and Landing Tasks

The flare guidance symbol appeared on the HUD at a gear altitude of 100 ft. This symbol took the form of two segmented horizontal bars located below the commanded flight-path indicator as shown in figure E7. The flare symbol moved vertically on the HUD until it contacted the commanded flight-path indicator at a gear altitude of 55 ft, at which point the pilot followed the upward motion of the flare cue with his flight-path command, resulting in a final flight path of -0.2° in the ideal case. The flare initiation altitude and final flight-path angle were tuned in an iterative fashion during the simulator setup. The reason for the relatively shallow flight-path angle at the flare exit was the lag between commanded flight path and actual flight path in the $\dot{\gamma}/V$ system through the flare. This made it necessary to bias the final flight path of the flare cue to a shallow value of -0.2° so that when the pilot placed his commanded flight-path symbol on the flare cue, the actual flight path was about -0.5° . The lag between the actual and commanded flight-path angle through the flare was highly dependent on the pilot's throttle activity in the $\dot{\gamma}/V$ system, and differed somewhat from pilot to pilot. Each pilot developed their own technique for retarding the throttles while leading the flare guidance symbol to account for this lag. The velocity-vector guidance symbol and the flare guidance symbol both disappeared when gear altitude was less than 0.5 ft.

y_{flare} is defined as

$$y_{flare} = 0.0345 (h_{gear} - 55)$$

where

$$0^\circ < y_{flare} < 3.0^\circ \text{ (positive downward)}$$

$$y_{ref} = -3.0 \quad (h_{gear} > 50 \text{ ft})$$

$$y_{ref} = -0.2 \quad (h_{gear} < 50 \text{ ft})$$

y_{ref} is subject to a *rate* limit of 0.42 deg/sec

h_{gear} is landing gear height above runway, ft

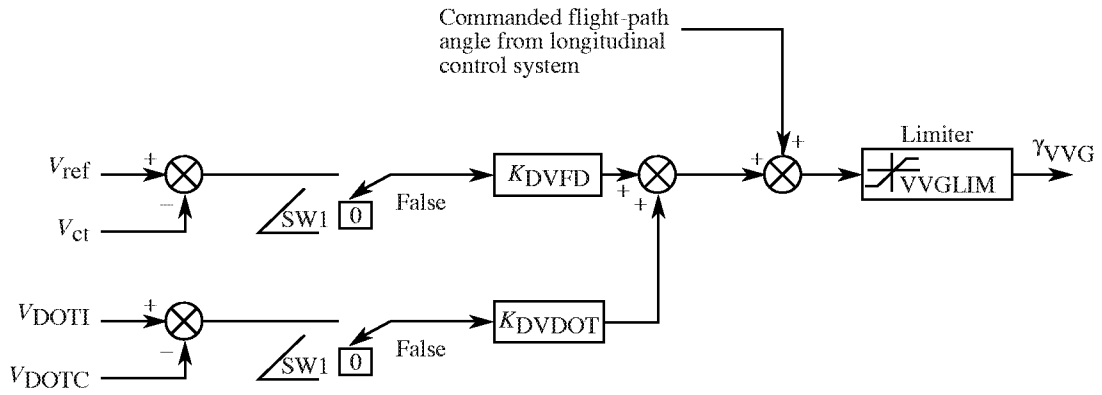

Figure E1. Block diagram of system used to provide longitudinal velocity-vector guidance to intercept and maintain specified climb speed V_{ct} .

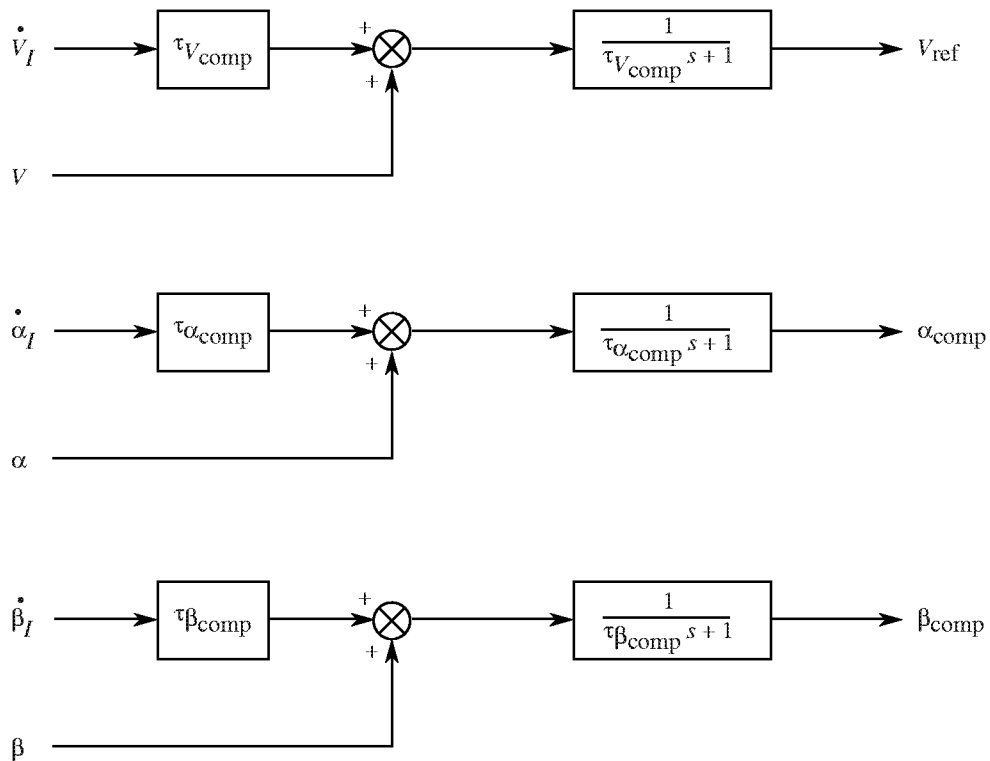

Figure E2. Filters used to generate complementary filtered airspeed, angle of attack, and sideslip angle.

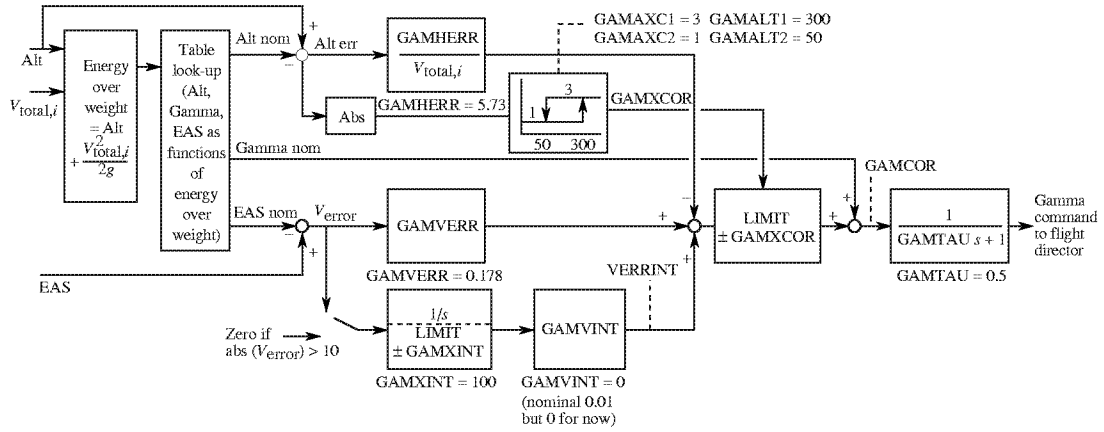

Figure E3. Profile climb guidance algorithm.

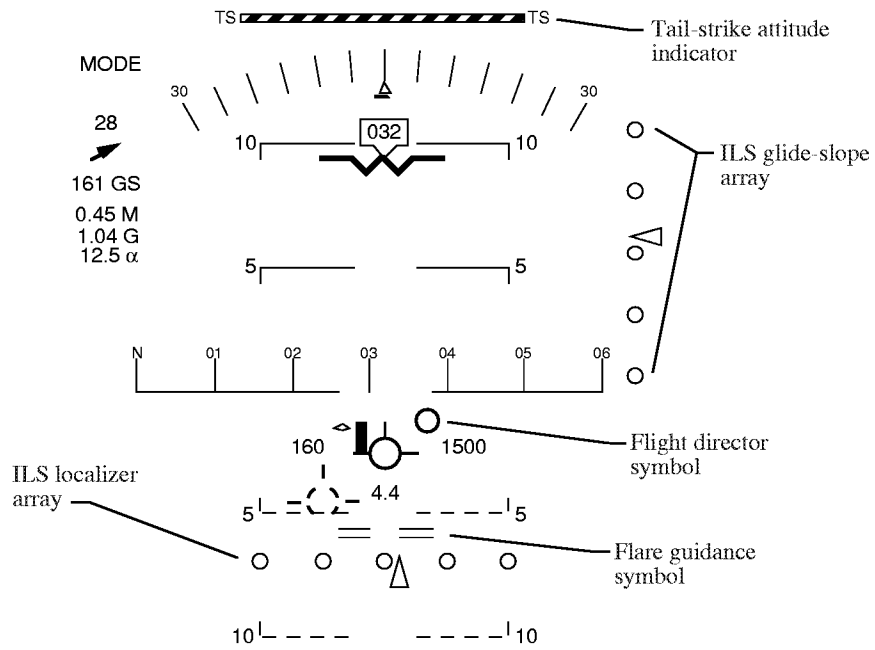

Figure E4. Diagram of head-up display used in approach and landing tasks.

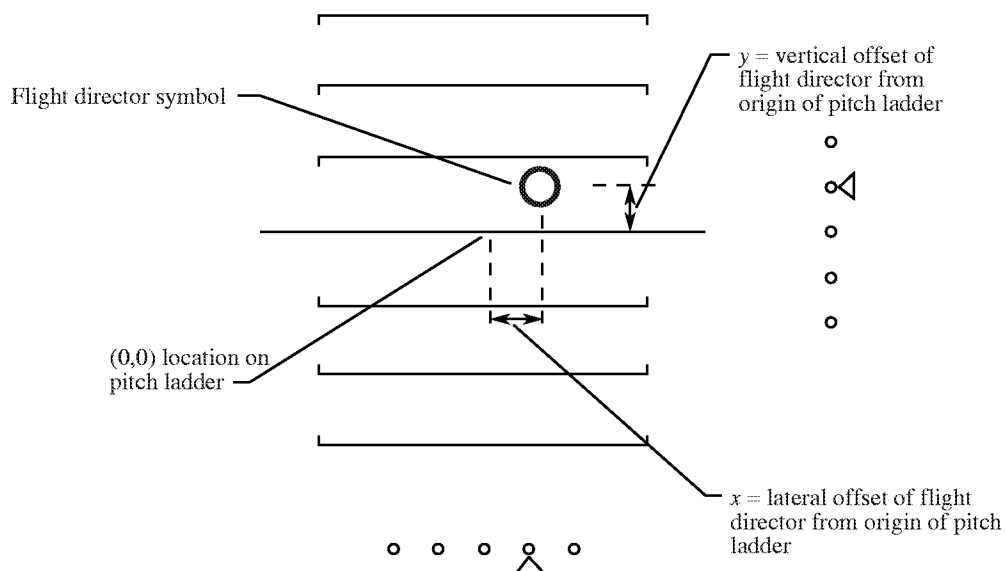

Figure E5. Placement of flight director symbol.

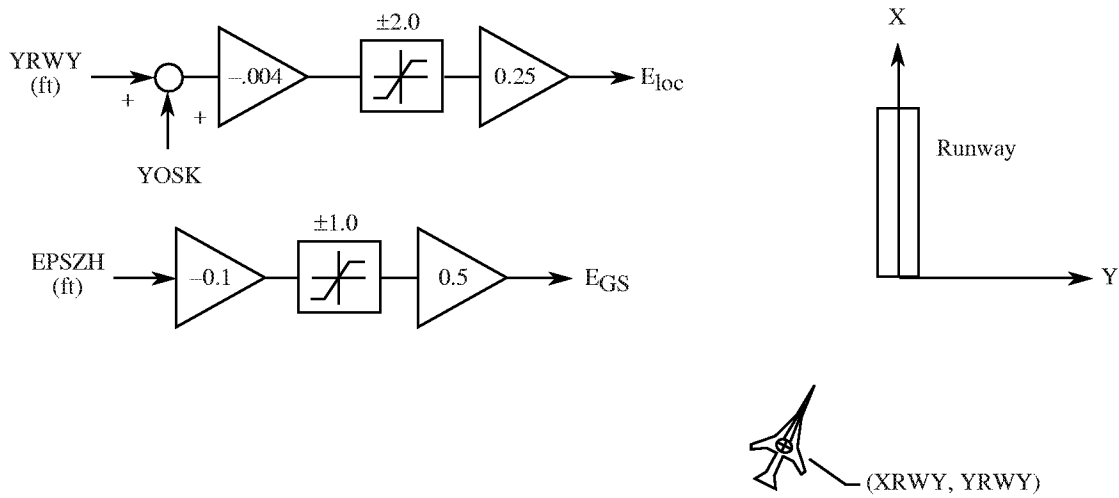

Figure E6. Computation of E_{loc} and E_{GS} . $EPSZH = h_{gear} - h_{GS} + HOSK$; $HOSK =$ Glide-slope offset from cockpit; $YOSK =$ Localizer offset from cockpit.

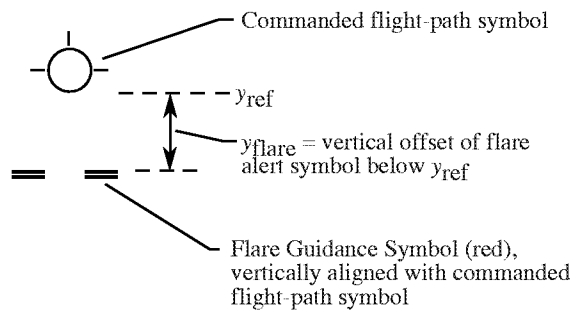

Figure E7. Operation of flare guidance symbol.

Appendix F

Algorithm for Calculation of Cabin Pressure Altitude for Emergency Descent Maneuver

Symbols

A	hole size, ft ²
h	altitude
k	specific heat ratio, 1.4
m	mass of cabin air, slugs
M	Mach number
p	pressure, lb/ft ²
R	gas constant, 17.5 ft-lb/slug-°R
t	time, sec
T	temperature, °R
V	volume
w	mass flow, slugs/sec
ρ	air density, slugs/ft ³

Subscripts:

ambient	outside of cabin
cabin	inside of cabin
in	airflow in
out	airflow out
throat	at exit hole

Initialize Variables

1. Set V_{cabin} to value specified for test (default 30000 ft³)
2. Set T_{cabin} to value specified for test (default 532°R)

3. Set h_{cabin} to initial value specified for test (default 8000 ft)
4. Calculate initial p_{cabin} from h_{cabin} using atmosphere tables
5. Calculate initial ρ_{cabin} from perfect gas law:

$$\rho_{\text{cabin}} = \frac{p_{\text{cabin}}}{RT_{\text{cabin}}}$$

6. Calculate initial cabin air mass:

$$m_{\text{cabin}} = V_{\text{cabin}} \rho_{\text{cabin}}$$

7. Calculate cabin air replenishment rate (estimated to be one quarter of cabin volume per minute at cruise conditions):

$$\frac{\partial}{\partial t} m_{\text{in}} = \frac{1/4 \rho_{\text{cabin}} V_{\text{cabin}}}{60}$$

8. At simulated rupture, set A to hole size, in ft^2

The following steps are performed at each iteration:

1. Determine p_{ambient} (outside static pressure) from standard atmosphere model
2. Determine Mach number at exit hole from ratio of pressures:

$$M_{\text{throat}} = \sqrt{5 \left[\frac{1}{(p_{\text{ambient}}/p_{\text{cabin}})^{0.28571}} - 1 \right]}$$

If p_{ambient} is higher than p_{cabin} use inverse of pressure ratio to calculate M_{throat} . Flow will be reversed (into cabin).

3. Limit $M_{\text{throat}} \leq 1.0$
4. Determine exit mass flow:

$$\frac{w}{A} = \sqrt{\frac{k}{R}} \frac{\rho_{\text{cabin}}}{\sqrt{T_{\text{cabin}}}} \frac{M_{\text{throat}}}{\left(1 + \frac{k-1}{2} M_{\text{throat}}^2\right) \frac{k+1}{2(k-1)}}$$

$$\frac{\partial}{\partial t} m_{\text{out}} = 0.028571 \frac{A M_{\text{throat}} \rho_{\text{cabin}}}{\sqrt{T_{\text{cabin}}} (0.2 M_{\text{throat}}^2 + 1)^3}$$

Note: if p_{ambient} is higher than p_{cabin} , change sign on m_{out} , since airflow will be into cabin.

5. Determine net mass flow:

$$\frac{\partial}{\partial t} m_{\text{cabin}} = \frac{\partial}{\partial t} m_{\text{in}} - \frac{\partial}{\partial t} m_{\text{out}}$$

6. Integrate mass flow to update cabin air mass

7. Using new cabin air mass, calculate new cabin pressure:

$$p_{\text{cabin}} = \frac{RT_{\text{cabin}} m_{\text{cabin}}}{V_{\text{cabin}}}$$

Appendix G

Quantitative Summary Metric

The following table presents the quantitative summary:

Task	Definition	Anticipated task occurrence	Desired maximum CHR	Maximum assessed CHR	CHR deficiency
1050	Rejected takeoff—0-knot crosswind	Infrequent	6.5	4	0
1051	Rejected takeoff—15-knot crosswind	Infrequent	6.5	4	0
1052	Rejected takeoff—35-knot crosswind	Infrequent	6.5	4	0
2010	Acoustic profile takeoff	Common	3.5	4	0.5
2030	Acoustic programmed lapse rate takeoff	Common	3.5	4	0.5
3020	Transition to level flight	Common	3.5	5	1.5
3022	Transition to supersonic cruise	Common	3.5	5	1.5
3030	Profile climb	Common	3.5	5	1.5
3040	Level flight transition to climb	Common	3.5	4	0.5
3050	Profile descent	Common	3.5	4	0.5
3060	Transition to supersonic descent	Common	3.5	5	1.5
3062	Transition to transonic descent	Common	3.5	5	1.5
3070	Airspeed change in subsonic climb	Common	3.5	4	0.5
3074	Transonic deceleration	Common	3.5	4	0.5
3076	Airspeed change in low-altitude cruise	Common	3.5	5	1.5
3080	Heading change in transonic climb	Common	3.5	4	0.5
3084	Heading change in supersonic cruise	Common	3.5	4	0.5
3086	Heading change in low-altitude cruise	Common	3.5	4	0.5
3088	Heading change in TCA descent	Common	3.5	5	1.5
4020	Nominal approach and landing	Common	3.5	5	1.5
4025	Nominal approach and landing with flight director	Common	3.5	5	1.5
4050	Precision landing	Common	3.5	5	1.5
4062	Landing from lateral offset—moderate turbulence	Common	3.5	10	6.5
4066	Landing from lateral offset—category I, moderate turbulence	Common	3.5	7	3.5
4072	Landing from vertical offset—moderate turbulence	Common	3.5	7	3.5
4076	Landing from vertical offset—category I, moderate turbulence	Common	3.5	7	3.5
4080	Go-around	Common	3.5	7	3.5
4085	Go-around with minimum altitude loss	Infrequent	6.5	7	0.5
4090	Crosswind approach and landing [15 knots]	Common	3.5	7	3.5
4095	Crosswind approach and landing—35 knots	Common	3.5	10	6.5
4100	Category IIIa minimums landing	Common	3.5	10	6.5
4110	Approach and landing with jammed control	Emergency	6.5	5	0
5010	Stall—idle power	Infrequent	6.5	5	0
5020	Stall—maximum takeoff power	Infrequent	6.5	5	0
5040	Turning stall—idle power	Infrequent	6.5	8	1.5
5050	Turning stall—thrust for level flight	Infrequent	6.5	8	1.5
5060	Diving pullout	Emergency	6.5	8	1.5
5070	Emergency descent	Emergency	6.5	8	1.5
6050	Inadvertent speed increase	Infrequent	6.5	4	0

Task	Definition	Anticipated task occurrence	Desired maximum CHR	Maximum assessed CHR	CHR deficiency
6060	Two-axis upset	Infrequent	6.5	5	0
7010	Directional control with one engine inoperative	Infrequent	6.5	9	2.5
7020	Lateral control with one engine inoperative	Infrequent	6.5	5	0
7035	One-engine-out takeoff	Infrequent	6.5	5	0
7050	Dynamic VMCL-2	Emergency	6.5	5	0
7060	Ripple unstart	Infrequent	6.5	8	1.5
7070	Engine-out stall	Infrequent	6.5	10	3.5
7080	Engine-out turning stall	Infrequent	6.5	10	3.5
7090	All-engines-out landing	Emergency	6.5	6	0
7095	Manual throttle landing	Emergency	6.5	5	0
7100	Unaugmented landing	Emergency	6.5	7	0.5
7110	Unaugmented landing—longitudinal axis inoperative	Emergency	6.5	7	0.5
Averages				5.94	1.47
Metric score, percent		exp(-Average)			23.0

Appendix H

Lessons Learned From This Study

The lessons that were learned from this study are given as follows:

Takeoff rotation guidance needs to be improved. Some elements of the guidance system, however, were very useful, such as the tail-strike bar. Pilots employed the tail-strike bar during takeoffs, landings, and go-around maneuvers.

An error in the vortex fence logic prevented proper operation during takeoff rotations. This error increased elevator and stabilizer deflections by 10 percent to 20 percent.

The use of a lateral offset landing maneuver was instrumental in identifying the roll control power deficiency. Although this maneuver is somewhat artificial, it should be retained for future studies.

An error in the propulsion system model prevented completion of the profile climb task.

Throttle friction and breakout, as used in this study (and documented in appendix A), were too high.

The test conductor's station needs to be better automated to help keep up with the rapid pace of the test.

Sidestick longitudinal breakout, as used in this study (and documented in appendix A), was too high, especially in cruise conditions.

Sidestick longitudinal forces were too light in cruise conditions.

Several improvements to the head-up display were recommended: (1) localizer deviation scale was too close to the flight-path symbol with 0/30 flap setting (after the automatic flap reconfiguration); (2) the central (zero deviation) markers on the localizer and glide-slope deviation scale need to be made more distinctive; (3) the flare guidance cue was difficult to track precisely, was difficult to see, and did not produce desired touchdown performance; and (4) during the profile climb maneuver, misleading lateral guidance caused the pilots to violate the heading deviation performance standard.

The following need to be provided for flight-test-style maneuvers: (1) an analog *g* tape for flight test maneuvers specifying levels of normal acceleration, (2) an analog angle-of-attack tape for the recovery from limit flight maneuvers, (3) an indication of the desired deceleration rate to the pilot during recovery from limit flight maneuvers, and (4) analog airspeed and altitude tapes for the airspeed and altitude intercept maneuvers.

An error in the control surface mixer model caused the lower rudder segment to be locked out (frozen at zero deflection) at airspeeds above 250 knots equivalent instead of the upper segment.

A useful procedure was developed to facilitate rapid change from one maneuver or flight card to the next. The simulation operator entered the task ID, which reset the simulation to the specific initial conditions of that task, weather conditions, cockpit display arrangement and format, and armed touchpanel triggers (if required) to fail or unstart engines or simulated fuel transfer pumps, etc. A special trim display appeared to both the simulation operator and the pilot not flying that used color highlights to identify cockpit controls that did not match the stored initial conditions file, making it easy to note an

improper positioning of the landing gear handle, for example. The simulation then was trimmed at the new initial conditions to remove any accelerations. Again, a color highlight indicated when the trim solution was adequate for smooth initiation of motion cues.

Appendix I

Head-Up Display Symbology

The head-up display (HUD) symbology (fig. I1) was provided to the pilots as an appendix to the Pilot Briefing Guide. The symbology for each part of the HUD is defined in table I1, starting with the top left and then counterclockwise around the display. All symbols are white unless noted.

Table I1. HUD Symbology and Description

Symbology	Description
Heading readout	Magnetic heading in degrees; significant integer value only with leading zero and no sign; range 000–359
HUD format annunciator	Displays HUD format option in effect—one of TO, CLMB, CR, DESC, or APP
Wind indicator	Displays present steady wind magnitude, in knots, and, if current winds are greater than 5 knots, wind direction in degrees magnetic
Ground speed	True ground speed, in knots; significant integer value only
Mach	Flight Mach; two significant digits after decimal point with leading zero
Normal <i>g</i>	Normal acceleration at aerodynamic reference point; two significant digits after decimal point with leading minus sign and zero if necessary
Angle of attack	Air mass relative angle of attack at aerodynamic reference point; one significant digit after decimal point with leading minus sign and zero if necessary
Actual flight-path marker	“Ghost” duplicate of flight-path marker appears only if difference between actual and commanded flight path exceeds 1.5°; appears with flight-path command flight control modes only (GCGH and γ/V)
Climb gradient command	Dashed magenta line shows specified climb gradient angle relative to horizon line, including a numerical value in percent with one significant digit followed by percent sign (%)
Heading tape	Heading ticks are perpendicular to horizon line, topped with first two digits of magnetic heading except cardinal directions (N, E, S, W) which are given as capital letters; leader lines are 1.5° high; total tape width same as width of horizon line
Horizon line	Horizon line extends $\pm 30^\circ$ from center of HUD; gap in middle to accept width of flight-path marker plus approximately 10 percent of flight-path marker width
Acceleration symbol	Diamond marker moves vertically proportional to VDOT; maximum range is 3° above (speed increasing) or 3° below (speed decreasing) left wingtip of flight-path marker; scale of motion is 1° per 3°/(knot/sec) or 1.777°/(ft/sec/sec)
Airspeed	Given as integer values of knots equivalent airspeed (KEAS)
Airspeed error	Tape indicator grows above or below left wingtip of flight-path marker; maximum range 3° above (airspeed too fast) or 3° below (airspeed too slow) left wingtip of flight-path marker; scale of motion is 1° per 4 knots difference in equivalent airspeed from reference airspeed (reference airspeed in KEAS set independently by task)
DME	Distance in nautical miles from runway threshold
Flare cues	Magenta flare cues appear when $h_{\text{gear}} < 100$ ft; vertical angle between flight-path marker and top of flare cue is given by $0.0345(h_{\text{gear}} - 45)$; movement of flare cue constrained between 0° and 3° below flight-path marker
Run and time stamp	Displays current run number, elapsed time since start of run, and current date

Table I1. Concluded

Symbology	Description
Localizer deviation indicator and scale	Shows “raw” ILS localizer error; full-scale deflection represents $\pm 2.5^\circ$ error, per conventional ILS indicator
Flight-path marker	Represents velocity vector of pilot’s eyepoint; if flight-path command system in use, flight-path marker shows commanded flight-path angle instead of actual flight-path angle
Altitude	Readout is normally height of center of gravity in feet above mean sea level (MSL); below 700 ft above ground level, switches to radar altitude, in height of gear above ground, and has an ‘R’ appended to numeric value
Vertical flight-path director bar	Magenta vertical bar used when horizontal guidance required without pitch guidance information or when pilot chooses to use both bars in place of circular flight-path director
Horizontal flight-path director bar	Magenta horizontal bar used when horizontal guidance required without pitch guidance information or when pilot chooses to use both bars in place of circular flight-path director
Flight-path director	Magenta circle, 75 percent size of flight-path marker circle; used when both pitch and roll guidance available; alternatively, both director bars may be used instead
Glide-slope deviation indicator and scale	Shows “raw” ILS glide-slope error; full-scale deflection represents $\pm 0.7^\circ$ error, per conventional ILS indicator
Pitch ladder	Displays vertical pitch angle scale; bars and numbers above white horizon line are bright blue; symbology below horizon line are brown dashed lines; pitch scale compression used at large pitch attitudes (see SAE ARP4102/7, “Aerospace Recommended Practice,” Appendix A, on Electronic Display Symbology, item 6 on p. 12 of 1991-12 issue, for more information)
Pitch attitude marker	Waterline symbol has two sizes, depending on flight control system response type in use; when in flight-path command mode, marker is normal size; when pitch rate command (RCAH) system used, marker is twice normal size
Pitch rate error markers	Pair of magenta markers, 20° high, centered about desired pitch attitude during takeoff rotation maneuver
Side-force indicator	Symbol slides left and right of roll angle indexer to indicate amount of side force in <i>g</i> units; side-force indicator moves to right of roll angle indexer to indicate positive (rightward) side force at pilot’s station; scale factor should be $\pm 0.1g$ at full-scale deflection, which should be $\pm 5^\circ$ laterally
Roll angle indexer	Marker remains fixed in HUD while roll angle scale rotates about center of horizon line
Roll angle scale	Scale rotates about center of horizon line to indicate bank angle; tic marks provided (but unannotated) for bank angles of 10° , 2° , and 45° ; 30° and 60° tic marks include annotation of bank angle value; 60° tic mark appears only when bank angle exceeds 30°
Tail-strike bar	Red and white striped barber pole shows pitch attitude at which aft portion of fuselage will come in contact with ground as function of vehicle altitude
Pitch attitude target	Flashing, dashed-line magenta copy of pitch attitude marker provides guidance for pitch attitude related tasks, such as takeoff rotation

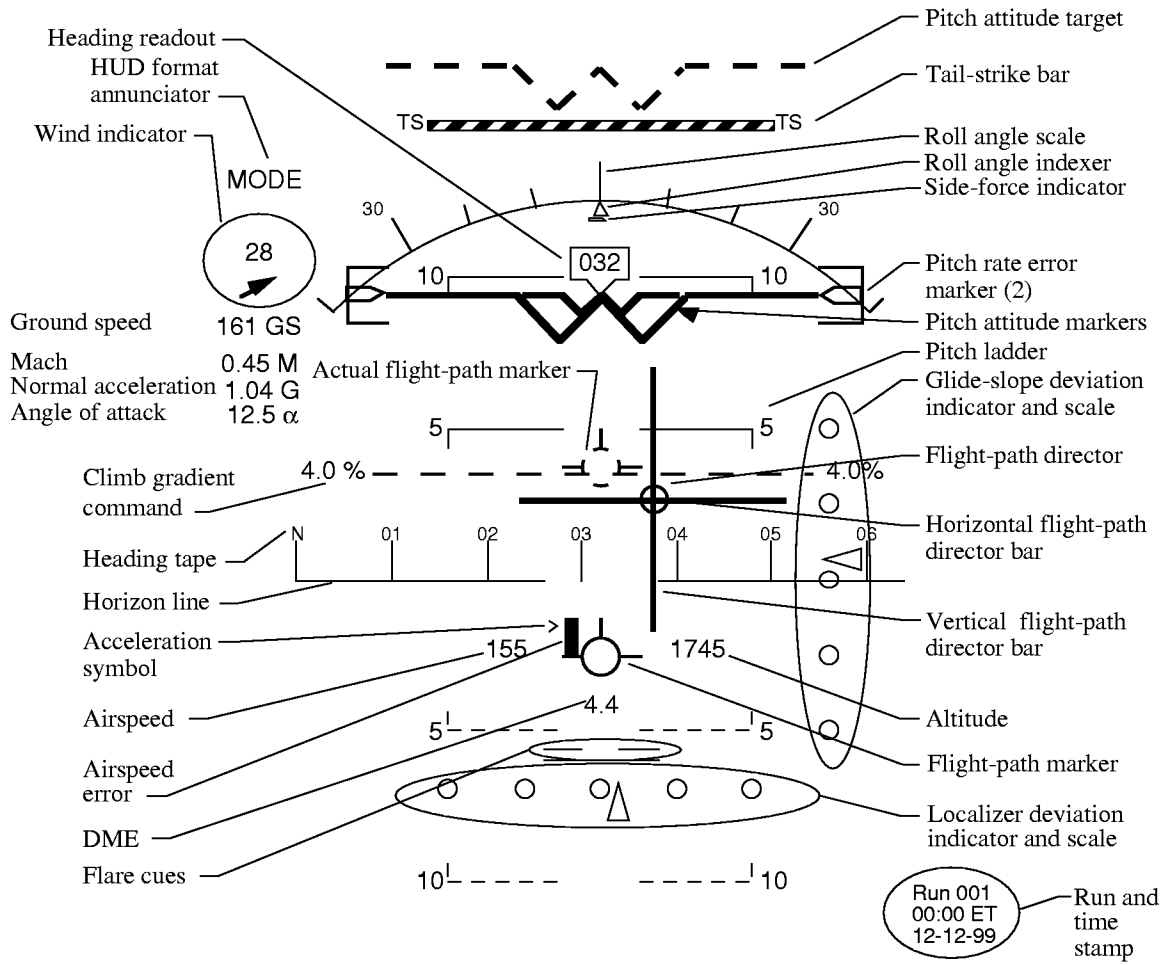

Figure I1. Head-up display symbology.

REPORT DOCUMENTATION PAGE

Form Approved
OMB No. 0704-0188

Public reporting burden for this collection of information is estimated to average 1 hour per response, including the time for reviewing instructions, searching existing data sources, gathering and maintaining the data needed, and completing and reviewing the collection of information. Send comments regarding this burden estimate or any other aspect of this collection of information, including suggestions for reducing this burden, to Washington Headquarters Services, Directorate for Information Operations and Reports, 1215 Jefferson Davis Highway, Suite 1204, Arlington, VA 22202-4302, and to the Office of Management and Budget, Paperwork Reduction Project (0704-0188), Washington, DC 20503.

1. AGENCY USE ONLY (Leave blank)	2. REPORT DATE March 2002	3. REPORT TYPE AND DATES COVERED Technical Publication	
4. TITLE AND SUBTITLE Piloted Simulation Assessment of a High-Speed Civil Transport Configuration		5. FUNDING NUMBERS WU 537-07-24	
6. AUTHOR(S) E. Bruce Jackson, David L. Raney, Louis J. Glaab, and Stephen D. Derry			
7. PERFORMING ORGANIZATION NAME(S) AND ADDRESS(ES) NASA Langley Research Center Hampton, VA 23681-2199		8. PERFORMING ORGANIZATION REPORT NUMBER L-17587	
9. SPONSORING/MONITORING AGENCY NAME(S) AND ADDRESS(ES) National Aeronautics and Space Administration Washington, DC 20546-0001		10. SPONSORING/MONITORING AGENCY REPORT NUMBER NASA/TP-2002-211441	
11. SUPPLEMENTARY NOTES Jackson, Raney, and Derry: Langley Research Center, Hampton, VA; Glaab: Lockheed Martin Engineering & Sciences Corporation, Hampton, VA.			
12a. DISTRIBUTION/AVAILABILITY STATEMENT Unclassified-Unlimited Subject Category 08 Availability: NASA CASI (301) 621-0390		12b. DISTRIBUTION CODE	
13. ABSTRACT (Maximum 200 words) An assessment of a proposed configuration of a high-speed civil transport was conducted by using NASA and industry research pilots. The assessment was conducted to evaluate operational aspects of the configuration from a pilot's perspective, with the primary goal being to identify potential deficiencies in the configuration. The configuration was evaluated within and at the limits of the design operating envelope to determine the suitability of the configuration to maneuver in a typical mission as well as in emergency or envelope-limit conditions. The Cooper-Harper rating scale was used to evaluate the flying qualities of the configuration. A summary flying qualities metric was also calculated. The assessment was performed in the Langley six-degree-of-freedom Visual Motion Simulator. The effect of a restricted cockpit field-of-view due to obstruction by the vehicle nose was not included in this study. Tasks include landings, takeoffs, climbs, descents, overspeeds, coordinated turns, and recoveries from envelope limit excursions. Emergencies included engine failures, loss of stability augmentation, engine inlet unstarts, and emergency descents. Minimum control speeds and takeoff decision, rotation, and safety speeds were also determined.			
14. SUBJECT TERMS HSCT; Flying qualities; Takeoff rotation guidance; Optimal climb; Inlet unstart; Emergency descent; Decelerating approach; Approach and landing; HRS; Supersonic transport; Reference-H; Noise abatement			15. NUMBER OF PAGES 476
			16. PRICE CODE
17. SECURITY CLASSIFICATION OF REPORT Unclassified	18. SECURITY CLASSIFICATION OF THIS PAGE Unclassified	19. SECURITY CLASSIFICATION OF ABSTRACT Unclassified	20. LIMITATION OF ABSTRACT UL