

NASA/TM—2002-210774



Plant Production Systems for Microgravity: Critical Issues in Water, Air, and Solute Transport Through Unsaturated Porous Media

Editors:

*Susan L. Steinberg, PhD
Doug W. Ming, PhD
Don Henninger, PhD*

*Liberated Technical/JSC
NASA/JSC
NASA/JSC*

THE NASA STI PROGRAM OFFICE . . . IN PROFILE

Since its founding, NASA has been dedicated to the advancement of aeronautics and space science. The NASA Scientific and Technical Information (STI) Program Office plays a key part in helping NASA maintain this important role.

The NASA STI Program Office is operated by Langley Research Center, the lead center for NASA's scientific and technical information. The NASA STI Program Office provides access to the NASA STI Database, the largest collection of aeronautical and space science STI in the world. The Program Office is also NASA's institutional mechanism for disseminating the results of its research and development activities. These results are published by NASA in the NASA STI Report Series, which includes the following report types:

- **TECHNICAL PUBLICATION.** Reports of completed research or a major significant phase of research that present the results of NASA programs and include extensive data or theoretical analysis. Includes compilations of significant scientific and technical data and information deemed to be of continuing reference value. NASA's counterpart of peer-reviewed formal professional papers but has less stringent limitations on manuscript length and extent of graphic presentations.
- **TECHNICAL MEMORANDUM.** Scientific and technical findings that are preliminary or of specialized interest, e.g., quick release reports, working papers, and bibliographies that contain minimal annotation. Does not contain extensive analysis.
- **CONTRACTOR REPORT.** Scientific and technical findings by NASA-sponsored contractors and grantees.

- **CONFERENCE PUBLICATION.** Collected papers from scientific and technical conferences, symposia, seminars, or other meetings sponsored or cosponsored by NASA.
- **SPECIAL PUBLICATION.** Scientific, technical, or historical information from NASA programs, projects, and mission, often concerned with subjects having substantial public interest.
- **TECHNICAL TRANSLATION.** English-language translations of foreign scientific and technical material pertinent to NASA's mission.

Specialized services that complement the STI Program Office's diverse offerings include creating custom thesauri, building customized databases, organizing and publishing research results . . . even providing videos.

For more information about the NASA STI Program Office, see the following:

- Access the NASA STI Program Home Page at <http://www.sti.nasa.gov>
- E-mail your question via the Internet to help@sti.nasa.gov
- Fax your question to the NASA Access Help Desk at (301) 621-0134
- Telephone the NASA Access Help Desk at (301) 621-0390
- Write to:
NASA Access Help Desk
NASA Center for AeroSpace Information
7121 Standard
Hanover, MD 21076-1320

NASA/TM—2002—210774



Plant Production Systems for Microgravity: Critical Issues in Water, Air, and Solute Transport Through Unsaturated Porous Media

Editors:

Susan L. Steinberg, PhD

Doug W. Ming, PhD

Don Henninger, PhD

Liberated Technical/JSC

NASA/JSC

NASA/JSC

National Aeronautics and
Space Administration

Johnson Space Center
Houston, Texas 77058-3696

February 2002

Preface

This NASA Technical Memorandum is a compilation of presentations and discussions in the form of minutes from a workshop entitled Plant Production Systems for Microgravity: Critical Issues in Water, Air, and Solute Transport Through Unsaturated Porous Media held at NASA's Johnson Space Center, July 24-25, 2000. This workshop arose from the growing belief within NASA's Advanced Life Support Program that further advances and improvements in plant production systems for microgravity would benefit from additional knowledge of fundamental processes occurring in the root zone. The objective of the workshop was to bring together individuals who had expertise in various areas of fluid physics, soil physics, plant physiology, hardware development, and flight tests to identify, discuss, and prioritize critical issues of water and air flow through porous media in microgravity.

NASA's Advanced Life Support Program at Johnson Space Center sponsored the workshop. Douglas W. Ming, Ph.D., transcribed the minutes of the workshop, and Susan L. Steinberg, Ph.D., prepared introductory materials and compiled the transcribed text into a representation of the events. Chapter 3 describes the minutes of the meetings as authentically as possible while still conveying the intent of the workshop. We thank all participants for their contribution and support of this document.

Available from:

NASA Center for AeroSpace Information
7121 Standard
Hanover, MD 21076-1320

National Technical Information Service
5285 Port Royal Road
Springfield, VA 22161

This report is also available in electronic form at <http://techreports.larc.nasa.gov/cgi-bin/NTRS>

Contents

| | Page |
|--|-------------|
| 1.0 SUMMARY | 1 |
| 1.1 Presentations | 1 |
| 1.2 Structure and Function..... | 1 |
| 1.3 Summary of Findings..... | 2 |
| 1.3.1 Critical Research Areas..... | 2 |
| 1.3.2 Summary of Critical Research Areas or Needs by General Topics..... | 3 |
| 2.0 INTRODUCTION | 4 |
| 2.1 Historical Overview | 4 |
| 2.2 Factors That Have Contributed to Problems With Development of Root Modules.. | 7 |
| 2.2.1 Mass, Volume, and Power Constraints | 7 |
| 2.2.2 Water and Air Transport in a Porous Media in Microgravity..... | 8 |
| 2.2.3 Conflicting or Inadequate Requirements | 9 |
| 2.2.4 Experiments | 9 |
| 2.2.5 Condition of Payloads..... | 9 |
| 2.3 Charter to the Workshop..... | 9 |
| 3.0 MINUTES OF THE WORKSHOP | 9 |
| 3.1 Opening Remarks: Henninger..... | 10 |
| 3.2 Purpose and Goals of the Meeting: Steinberg..... | 11 |
| 3.3 Overview of Russian Flight Experiments Involving Solid Substrates: Bingham and Podolsky | 11 |
| 3.4 Overview of U.S. Plant Growth Units involving Solid Substrates: Levine..... | 12 |
| 3.5 Summary of Water Flow through Solid Substrates in Microgravity: Jones | 14 |
| 3.6 Discussion Topic 1: Microscale Fluid Physics (Alexander and Daidzic, discussion leaders) | 16 |
| 3.7 Discussion Topic 2: Optimizing Water Retention and Aeration (Steinberg, discussion leader)..... | 18 |
| 3.8 Discussion Topic 3: Rhizosphere (Steinberg, discussion leader) | 22 |
| 3.9 Discussion Topic 4: Modeling (Steinberg, discussion leader)..... | 24 |

Contents **(continued)**

| | Page |
|--|-------------|
| 4.0 LITERATURE CITED | 28 |
| Appendix 1: Meeting Participants | 34 |
| Appendix 2: Substrate Property Characteristics | 36 |
| Appendix 3: Water Delivery and Distribution..... | 37 |
| Appendix 4: Microgravity Effects on Water Flow and Distribution in Unsaturated Porous Media | 38 |
| Appendix 5: Range for Optimized Water and Gas Fluxes | 46 |
| Appendix 6: Soil Hydraulic Characteristics | 47 |
| Appendix 7: Hydraulic Functions for Unsaturated Porous Media Based on Pore Scale Processes | 49 |

1.0 SUMMARY

Participants of the workshop entitled "Plant Production Systems for Microgravity: Critical Issues in Water, Air, and Solute Transport Through Unsaturated Porous Media," held at NASA's Johnson Space Center on July 24 and 25, 2000, included representatives from private companies involved in flight hardware development and scientists from universities and NASA Centers with expertise in plant flight tests, plant physiology, fluid physics, and soil physics.

1.1 PRESENTATIONS

Dr. Donald Henninger, Chief Scientist and Manager of NASA's Advanced Life Support (ALS) Program, gave an overview of the program that focused on the probable role of plants. He concluded by noting that many of the problems with growing plants for research or food production in microgravity are related to controlling the root zone environment.

Dr. Susan Steinberg, Scientist Specialist (plant water relations), Johnson Space Center, advised participants that, although there were many important issues related to growing plants in controlled environments, the purpose and goals of the workshop were to focus on basic soil physics issues related to water and air flow through porous media.

Dr. Igor Podolsky, Senior Scientist, Institute of Biomedical Problems, Moscow, Russia, and Dr. Gail Bingham, Space Dynamics Laboratory, Logan, Utah, spoke to the group about problems controlling water and air in Balkanine substrate during wheat growth experiments in the SVET plant growth unit aboard *Mir**.

Dr. Howard Levine, Kennedy Space Center, gave an overview of U.S. plant growth units involving solid substrates. He concluded by describing his upcoming flight test comparing microporous tube systems with nutrient solution or particulate substrate.

Dr. Scott Jones, Research Associate, Utah State University, discussed the question: Do capillary flow models work in microgravity? He presented his analysis of water flow data from several flight tests.

Other participants are listed in Appendix 1.

1.2 STRUCTURE AND FUNCTION

Roundtable discussions focused on microscale fluid physics, optimizing water retention and aeration, rhizosphere, and modeling. A summary of research needs was compiled at the conclusion of discussion of each topic.

* For further information about the *Mir* SVET Greenhouse plant growth facility, see "SVET Space Greenhouse onboard experiment data received from Mir station and future prospects." Ivanova, T., S. Sapunova, I. Dandalov, Y. Ivanov, G. Meleshko, A. Mashinsky, Y. Berkovich. 1994. *Advances in Space Research* 14:343-346.

1.3 SUMMARY OF FINDINGS

1.3.1 Critical Research Areas

The group identified a substantial list of critical research areas for “microgravity soil physics”:

- Predict enhanced hysteresis/microscale flow techniques
- Develop an oxygen (O₂) module for water transport model
- Understand sensor performance in microgravity
- Consider porous media/engineered media for microgravity
- Define minimum set of parameters for experiments
- Adapt existing models for microgravity (develop a specific “tool box” for microgravity)
- Use planned risk-mitigation experiments to get substrate water transport data
- Evaluate water retention curves and hydraulic conductivity in microgravity
- Conduct series of small-scale experiments in microgravity, e.g., space, drop towers, KC-135
- Conduct theoretical scaling of KC-135 experiments to microgravity and ground-based experiments
- Determine how the flight community can get more direction from the scientific community to maximize current flight experiments?
- Incorporate solute transport and solution chemistry microgravity models (note: may need an electrical conductivity sensor)
- Define requirements for an ideal substrate for microgravity, and test in space
- Combine modeling with experimentation and data acquisition
- Determine similarity criteria
- Measure O₂ diffusion in microgravity (gas flow)
- Assess vibrations and g-forces (controlled and uncontrolled)
- Define a more detailed plant boundary for the model; include soil-vegetation-atmosphere model
- Develop an experimental design for multiple and replicated experimental treatments in spaceflight
- Design ground control for flights that minimize substrate differences; include substrate scaling
- Measure water retention curve and hydraulic conductivity for a fixed geometry medium to remove variability of particulate substrate
- Research the effects of roots on the performance of substrate for water and sensors
 - Substrate volume displacement
 - Effect on small volume system
 - Effect of multiple crops
 - Recycling nutrients
 - Breakdown or decay of roots, etc.
 - Sensor function

- Look at particle-particle interactions
 - Packing – how we might improve preflight packing
 - Soil chemistry
- Control system issues/strategies for water and O₂
 - Sensor feedback
 - Control variables
 - Strategies
- Define requirements for plant performance
- Study materials science; new materials for wicks, mats, substrates, etc.
- Investigate interfaces acting as a third media, e.g., porous tubes/media and media/roots
- Set up a database for these types of experiments to disseminate information/communication/publications:
 - Experiments
 - Data
 - Publication list

1.3.2 Summary of Critical Research Areas or Needs by General Topics

- Modeling
 - Tool box for microgravity
 - Conceptual for microgravity (hysteresis, plant-soil-atmosphere, etc.)
 - Use of agreed upon similarity criteria
- Basic scientific approaches
 - Definition of requirements and parameters
 - Substrate development: engineered (requirements, materials science)
 - Substrate characterization: packing, solute chemistry, water retention, etc.
 - Microgravity
 - Drop tower, KC135, microgravity
 - Risk mitigation
 - Gas Exchange: O₂ diffusion
 - 1 g similarity approaches/experiments/ground controls (i.e. similarity criteria)
 - Multiple treatments
 - Models coupled with experiments
- Sensor development and evaluation
 - O₂ sensors
 - Soil moisture
 - Pressure transducers
 - Electrical conductivity

- Biological components/requirements
 - Plants
 - Roots/rhizosphere
 - Microbiology
- Other
 - Define: glossary and units
 - Database
 - External spacecraft and other forces (i.e. vibration)
 - Provide information to flight community to address basic scientific concerns

2.0 INTRODUCTION

2.1 HISTORICAL OVERVIEW

The key to successful plant research or crop production in space is to understand the effect of microgravity on plant physiological functions. Problems with controlling the plant environment have made it impossible to isolate microgravity as a variable of study.¹ Over the last 10 years, millions of dollars have been spent on flight experiments with plants, with most considered only marginally successful. Although a number of environmental factors such as light, air quality, and ventilation impact plant growth in microgravity, none have had such a limiting effect as control of water, air, and nutrients in the root zone.^{1,2} Problems with water and air control in the root zone have been inferred from soil and plant measurements.^{3,4,5,6}

Development of plant growth systems for microgravity has been driven by mass, volume and power constraints; water and/or media containment; water/air phase separation; and the need to recycle water, nutrients, and growth media.^{7,8,9} Suggested criteria for successful plant production in a controlled environment life support system include maximizing yield per mole photon (power) or unit area or unit volume. Early conceptualization of plant production systems for space-based applications, such as lunar or martian bases, relied on hydroponic water and nutrient delivery systems (NDSs).^{8,10} On Earth, nutrient solution culture provides a consistently high degree of control of water, nutrient, and aeration status of the plant root zone that is hard to match with solid media.¹¹ Because high growth rates can be maintained in relatively small-volume root zones, with a resultant high yield, hydroponic culture has been used to study maximization of plant growth in terrestrial controlled environments.¹²

Mixed-phase systems such as hydroponics or aeroponics are problematic in microgravity due to difficulties with water containment and lack of density-driven separation of the liquid and gas phases. Schwartzkopf¹³ proposed several methods to address the problems of fluid handling and mixed-phase separation of air and water in microgravity. Hessel et al.¹⁴ and Clawson et al.¹⁵ have recently examined the usefulness of aeroponics for spaceflight. Researchers at the Kennedy Space Center have developed a vacuum-operated NDS for microgravity.¹⁶ At present however, no mixed-phase system is a serious candidate for spaceflight.

Henninger, 2000, personal communication

Wright et al.⁹ addressed the problem of water containment and liquid and gas phase separation in microgravity by using microporous membranes to control nutrient solution delivery to roots. Nutrient solution was maintained under a slight suction on one side of the membrane; the membrane acts as a capillary interface to control delivery of the solution to plant roots on the other side of the membrane. Currently microporous tubes are used to deliver nutrient solution to seeds that germinate directly on the tubes; subsequent root growth wraps around the tubes (porous tube nutrient delivery system, PTNDS or porous tube NDS).¹⁷ Nutrient solution must be actively recirculated through the porous tube system to avoid localized nutrient depletion.¹⁸

The PTNDS is robust enough to support growing periods of various lengths, including complete life cycles.^{5,19} Moisture control,²⁰ sensing,²¹ and seed holding²² have been examined for this system. Tsao et al.²³ developed a conceptual model to describe water uptake by plants cultivated in a PTNDS. Dreschel & Sager¹⁷ and Berry et al.²⁴ reported 30% to 40% reductions in wheat yield when porous tube water pressures were decreased below -0.4 kPa in terrestrial tests. Likewise, Bubenheim et al.²⁵ found that harvest index and dry matter production of lettuce were lower with PTNDS than with conventional hydroponics. It is likely that the surface area of the tubes limited root water uptake.

Separate-phase systems using porous solids to separate air and water have been developed and used in microgravity. Early researchers used passive water and nutrient delivery systems consisting of small, premoistened aliquots of vermiculite²⁶ or soil,²⁷ filter paper,^{28,29,30} or agar³¹ to supply water, nutrients, and O₂ to plant roots for periods ranging from a few hours to several days. Solidified agar nutrient medium^{32,33,34} and horticultural foam³⁵ have been used on Shuttle flights to support plant growth for as many as 12 days. Root zone aeration in agar and foam, as compared with PTNDS, were inadequate when measured by alcohol dehydrogenase activity, an enzyme that catalyzes anaerobic respiration.^{5,36}

Particulate substrates have been used to support full-life-cycle wheat production on Earth and in microgravity. Substrates that have been used for ground and/or flight tests include glass beads,³⁷ peat-vermiculite mixes,^{38,39} arcillite,⁴⁰ isolite,⁴¹ Profile (porous ceramic aggregate),⁴² Turface (porous ceramic aggregate),⁴³ zeoponics,^{4,38,39,44} and Balkanine.^{3,39,45}

Several delivery methods to replenish the water and/or nutrient supply in the substrate have been used or proposed for microgravity:

Active control of water delivery:

1. Water is injected into the substrate through a hydroaccumulator (tube surrounded by foam) under positive pressure using a pump and solenoid valve³ (SVET plant growth unit, *Mir*). Heat pulse sensors⁴⁶ measuring substrate water content have been used to control irrigation timing. Questions about root zone aeration led to the use of large particles (3-5 mm), which then resulted in water transport problems and plant water stress.³ Currently, particles in the 1- to 2-mm size range are in use for U.S. and Russian flights.[‡] Canopy gas exchange and water loss were measured on *Mir*; evapotranspiration rates were

[‡] Monje, Levine, Bingham, 2000, personal communication

similar on Earth and in microgravity.⁴⁷ Questions about sensor placement, calibration, and use to control substrate water content in microgravity are numerous.

2. Constant water tension within microporous tubes is actively controlled by a pump (Astroculture™[§])⁴⁰ or a gravity-based siphon system.⁴⁸ The matric potential of the particulate substrate can be controlled by the water tension within the microporous tubes. Adding plants causes the substrate matric potential to become slightly more negative than the tube water pressure during light periods when transpiration is occurring. The gradient in water potential between the tube and plant root depends on the degree of pressure control in the tubes, the rate of transpiration, and substrate and tube hydraulic properties.⁴² Steinberg & Henninger⁴² studied substrate and plant water relations in the tube/substrate/plant continuum and found that, when substrate matric potential was maintained at a level optimal for plant growth, resistance within the plant was most limiting to water flow. Substrate O₂ content measurements have been minimal.

Both active control methods have flown on the Shuttle or *Mir*.

Passive control of water delivery:

1. Heathcote et al.¹⁹ controlled moisture in particulate media by a hydrophilic moisture sensor located in the culture matrix (On-Demand Nutrient Delivery System, NASA/Ames Research Center). When the sensor dried, it permitted air entry into a water reservoir, disrupting the vapor lock and releasing water into the root tray. This system did not adequately control substrate water content in a tray fitted with a lid to contain particulates, resulting in poor plant growth. Jones & Or⁴⁹ connected microporous tubes or plates to the water source via a pressure-controlled check valve. They measured soil matric potential and O₂ content in the root zone, but did not report diurnal changes associated with plant transpiration in any detail. Neither system has been tested in microgravity.
2. Gas permeable bags containing substrate or agar have been placed on a water source.^{32,34} Wicking strips allow the substrate water content to reach equilibrium with the water source. As mentioned previously, root zone aeration is a potential problem with agar systems.⁵

Like active systems, root water uptake and substrate and membrane hydraulic properties control water transport gradients.

In any of these systems, nutrients can be supplied via nutrient solution or substrate. An advantage of external nutrient supply is the ability to control nutrient composition, pH, and electrical conductivity. If nutrient solution is used, salt may build up in the medium if active control of water delivery is not used to carry unused nutrient ions away.⁹ Where the substrate provides nutrients (nutrient saturated zeolite,^{45,50} or slow-release fertilizer), the system can be run

[§] This is essentially the same as PTNDS, with the addition of substrate. For additional information on Astroculture, see "A matrix-based porous tube water and nutrient delivery system." Morrow, R.C., R.J. Bula, T.W. Tibbits, W.R. Dinauer. 1992. SAE Technical Paper Series No. 921390. SAE International, 400 Commonwealth Drive, Warrendale, PA 15096).

in the passive mode, simplifying mechanisms used for water pressure control and reducing volume, power, and mass requirements—all advantageous for spaceflight.¹⁸

Several studies have made side-by-side comparisons of microporous tube/substrate culture with hydroponics. Cao & Tibbitts⁴¹ found that many growth and gas exchange parameters were reduced in potato grown in isolite with half-strength nutrient solution provided at -0.5 kPa via microporous tubes, as compared with free water in nutrient film technique. TubORIZATION appeared to increase in microporous tube culture and was attributed to the lack of water flowing past stolons. By contrast, Steinberg et al.⁴⁴ found that microporous tube irrigation seemed able to meet the water requirements of wheat as well as hydroponics under the rigorous growing conditions of 24-day length and photosynthetically active radiation of $1700 \mu\text{moles m}^{-2} \text{s}^{-1}$. Differences in biomass production and harvest index were attributed to the differences in nutrition between hydroponic nutrient solution and zeoponic substrate. Goins et al.³⁸ compared the growth and biomass production of wheat grown in the microporous tube system with nutrient solution (PTNDS), the microporous tube system (Astroculture™) with zeoponic substrate,⁵⁰ drip-irrigated (water) zeoponic substrate, and drip-irrigated (nutrient solution) peat-vermiculite. Yield and harvest index was highest in drip-irrigated peat-vermiculite, followed by PTNDS, and then the two zeoponics treatments. Direct comparisons of growth and water relations of plants produced in microporous tube systems with zeoponic substrate or nutrient solution culture^{38,44} have been complicated by the fact that the nutrition of zeoponic substrate is significantly different from nutrient solution.

Jones & Or⁴⁹ noted that a root mat developed between the membrane and substrate in their growing trays. It was more pronounced for flat bottom sheets and less pronounced for tubular membranes. A root mat developed on the bottom of the tray for wheat grown in zeoponic substrate^{**}.⁴⁴ Soybean roots explored the whole volume of Profile substrate, with the majority of roots being located on the bottom of the tray.⁴²

It is not known whether water stress, gravitropism, hydrotropism, or another factor is responsible for the development of root mats, noted in several studies. Roots can show both gravitropic and hydrotropic responses.⁵¹ Ruff et al.⁵² found that reduced soil volume caused the growth habit of tomato root systems to change from a long taproot to a highly branched mat. Root-zone stress can induce root:total biomass ratios higher than the optimal considered for hydroponics.⁸

2.2 FACTORS THAT HAVE CONTRIBUTED TO PROBLEMS WITH DEVELOPMENT OF ROOT MODULES

2.2.1 Mass, Volume, and Power Constraints

Mass, volume, and power constraints will minimize space allotted to root modules, resulting in small volumes of media and high root densities. For example, the root module of the Biomass Production System^{††} (Orbitec Technologies Corp., Madison, Wisconsin) is approximately

^{**} Steinberg, 2000, personal communication

^{††} For additional information on the Biomass Production System, see "Biomass Production System (BPS) Plant Growth Unit." Morrow, R.C., T.M. Crabb. 2000. *Advances in Space Sciences* 26:289-298.

30 cm² with a 2.54-cm-depth root zone. The root module of the SVET plant growth unit used on *Mir* consisted of two 31.5 × 5.8 × 11-cm cuvettes. On Earth, small containers such as root modules often suffer from inadequate total water and minerals, and excess water content and poor aeration due to the perched water table at the bottom.⁵³ We find little information available about the nature of problems that might occur in small volumes in microgravity. Ground and flight research has focused on hardware development for plant growth in microgravity.

2.2.2 Water and Air Transport Through Porous Media in Microgravity

Despite nearly 20 years of plant research in microgravity, only very recently has any attempt been made to understand physical issues associated with water and air transport in a porous media in microgravity. Several researchers have measured and described various aspects of water transport through porous substrate in microgravity.^{37,40,45,54,55} Repetitions in these experiments have yielded inconsistent results, the cause of which may be a number of things, such as unknown or uncontrolled initial and boundary conditions, air entrapment, or particle separation. The work by Podolsky & Mashinsky⁵⁴ and Jones & Or⁵⁶⁻⁵⁸ represent the first attempts to put transporting water and air through porous media in microgravity on a sound theoretical basis. Jones & Or⁵⁶ also used physically based models to optimize particle size distribution for aeration and water retention. Scovazzo et al.⁵⁹ recently modeled and defined design criterion for two-phase flow of air and water in a membrane/solid substrate system.

Jones & Or⁵⁸ used data from two flight tests^{3,40} in their analysis of water transport through porous substrate in microgravity. They eliminated the gravity term from the Richard's equation⁶⁰ to simulate microgravity. Their analysis of water transport through porous substrate suggests that accentuated hysteresis, reduced hydraulic conductivity, and altered soil-water characteristic curve occur in microgravity. These differences between terrestrial and microgravity behavior were attributed to mechanisms such as enhanced interfacial flow, particle rearrangement, and air entrapment.

However, the current understanding of the nature of water and air transport in microgravity is not sufficiently well developed to allow unambiguous interpretation of microgravity experiment results. For example, published studies of water flow in plant growth media in microgravity give no description of the media-packing procedure or post-packing bulk density.^{3,37,40,45,54} In addition, the effects of g-forces and vibration during launch on media packing and bulk density have never been documented. Water transport through porous media seems to behave differently depending on whether substrate is launched wet or dry (see analysis of Bingham et al.³ and Morrow et al.⁴⁰ in Jones & Or⁵⁸). Root modules must be sealed to prevent particulate media from escaping in microgravity. The outer top casing of root modules may consist of a plastic cover and a foam wicking material to germinate seeds and secure the plants. This containment may limit air transport into and out of the substrate,⁴ although air transport between cabin and root module has never been measured or documented.

2.2.3 Related Technologies

Technologies related to irrigation management for containerized production in the greenhouse or nursery industry developed during most of the 20th century. Trickle, capillary mat, and ebb and flow are common irrigation systems used in commercial greenhouses.⁶¹ Their success can partially be attributed to the development and characterization of potting media for shallow root zones commonly found in the greenhouse and nursery industry including soilless mixes, sponges, and foams.⁶¹⁻⁶⁷ By contrast, irrigation management technologies for microgravity are still young, with limited collective time on orbit.

2.2.4 Conflicting or Inadequate Requirements

Conflicting or inadequate requirements for water delivery systems and growth media may impede progress in developing plant growth systems. The ALS Program and Fundamental Biology Program have the different goals of food production and plant research, respectively. The programs often operate as separate entities despite both requiring plant growth systems. Understanding water and air transport in porous media and the basics of water delivery should be fundamental to both programs.

2.2.5 Experiments

Mass, volume, and power constraints severely limit plant growth experiments on the Shuttle. Flight experiments are one-time-only, with no replication.

2.2.6 Condition of Payloads

Most payloads are required to be launched in an un-powered dry condition.^{3,43,45} Jones & Or⁵⁸ suggest launching partially wetted media to minimize wetting and settling problems in microgravity.

2.3 CHARTER TO THE WORKSHOP

NASA's ALS Program currently believes that particulate solid substrates are best suited to meet the short- and long-term needs in microgravity. These needs include longevity and repeated use, repeated crops in the same substrate, eventual use of local lunar or martian materials, and recovery of roots for research purposes. Solid substrate systems have the additional advantage of being able to support root and tuber crops that would be problematic with PTNDS. Therefore, it is crucial that water, air, and nutrient transport in small volumes of porous media be well understood.

3.0 MINUTES OF THE WORKSHOP

The following subsections describe minutes of the workshop. Names referred to will be those of the workshop's attendees and/or speakers.

3.1 OPENING REMARKS: HENNINGER

JSC has been the Lead Center for the ALS Program since 1996. The ALS Program includes the Kennedy Space Center for biological research, the Ames Research Center for physicochemical research, the New Jersey NASA Specialized Center of Research and Training (Rutgers and Stevens Institute of Technology), Iowa State University's Food Technology Commercial Space Center, and Tuskegee University's Center for Food and Environmental Systems for Human Exploration of Space.

The ALS Program focuses on post-International Space Station long-duration human exploration missions. For example, a nominal mission to Mars is on the order of 1000 days—six months for each one-way trip and approximately 550 days on the surface of Mars. Resupplying life support consumables is not a viable option, necessitating regeneration and reuse. There will be severe restrictions on mass, volume, power, and crew time for all systems for such long-duration missions. Emphasis will be on systems capable of long-term operations with very high reliability and minimum crew involvement. ALS is a diverse research and technology development program ranging from basic or fundamental research through all levels of technology development up to and including flight-testing. The ALS Program's five technical areas are:

- *air revitalization*: remove CO₂; provide O₂; and control trace gas contaminant, temperature, and pressure
- *water recovery*: remove organics and inorganics, certify and maintain potability
- *biomass production*: grow food crops
- *food processing*: process, package, and prepare menu items
- *solid waste processing*: recover resources from solid wastes
- *thermal control*: acquire, transport, and reject waste heat

These technologies are expected to be a combination of physicochemical and biological approaches. Use of planetary resources is also being evaluated.

Plants probably will be grown both on board transit vehicles and on planetary surfaces. Plant growth on transit vehicles will likely consist mainly of salad-type crops and may have to be grown in a microgravity environment as well. It is generally accepted that a culturing method involving some sort of solid material for the root zone is necessary to avoid releasing liquid into the cabin atmosphere under microgravity conditions. NASA and Russia have flown a number of flight experiments to investigate plant response to the microgravity environment. Most of these have suffered from an inability to control the root zone environment so that the plant has adequate moisture, air, and nutrients such that the variable of interest, microgravity, could be evaluated in terms of plant response. We believe that much of this difficulty stems from an incomplete understanding of the fundamental principles operating within a solid matrix functioning as a plant-rooting medium under microgravity conditions. NASA must better understand these principles to be able to specify design requirements for plant growth systems for microgravity environment use.

3.2 PURPOSE AND GOALS OF THE MEETING: STEINBERG

The overall goal is to develop an effective plant growth unit(s) to serve ALS Program needs. There are many important issues related to growing plants in a controlled environment in microgravity. The specific objective of this meeting is to examine the control of air, water, and solutes in a root zone containing solid substrates.

Conditions in which plants are grown in current flight units are not ideal by horticultural standards. Low light and high humidity characterize controlled environments for spaceflight. When evapotranspiration is low, air-filled porosity can be inadequate. Small root zones are the norm for spaceflight due to mass and volume limitations. Small containers often suffer from inadequate total water and nutrients, and excess water content and poor aeration.

Water or nutrient delivery systems that have been developed for microgravity have had to address two needs: water and air phase separation and water containment. These two issues have made deploying traditional hydroponics systems (mixed-phase systems) difficult in microgravity. These two issues have driven the development of separate-phase water delivery systems. One separate-phase system that is familiar to all of us is solid substrate.

Water and air have been delivered to substrate via microporous tubes, membranes, pouches, and plates. Two examples of flight systems are here today: the Russian 'LADA,' the next-generation plant growth unit (Space Dynamics Laboratory, Logan, Utah, and Institute of Biomedical Problems, Moscow, Russia), which is being developed for the International Space Station, and the Orbitec (Orbitec, Madison, Wisconsin) unit, which has flown on the Shuttle. The design and engineering problems associated with water delivery are important, but they are not the focus of this meeting.

At this meeting we would like to stop, step back, and revisit very basic soil physics issues that affect air and water flow through unsaturated porous media in microgravity. These are the issues that will drive improvements or refinements in existing water delivery systems, or the design of new ones.

We will first hear from several different researchers about using solid substrates to grow plants in microgravity. Discussions of air and water issues will follow. While we are not trying to be critical of past crop-growth flight experiments, we need to look at some of the basic science issues and to bring in the expertise of microgravity fluid physicists.

3.3 OVERVIEW OF RUSSIAN FLIGHT EXPERIMENTS INVOLVING SOLID SUBSTRATES: BINGHAM AND PODOLSKY

Space Dynamics Laboratory has been involved with the *Mir* flight program for over 10 years and has been involved in 10 plant growth experiments. Early experiments were hampered by high ethylene levels, which inhibited seed production. Bingham pointed out that we are getting better with plant growth in microgravity, but need major inputs from soil physicists. Poor results from early experiments were likely due to inadequate substrate O₂ levels. Due to aeration problems, the Russians optimized substrate for O₂ by increasing the particle size, resulting in water transport problems. The 1990 experiment used a substrate with 3- to 5-mm particle size

diameter. The Russian system used a water injection system, but water did not flow out of the wick into the substrate due to a mismatch between wick and substrate pore sizes. The Russians then moved toward using a substrate that was 1 part 2 to 3 mm:2 part 1 to 2 mm (they kept the particles that rested on a 1-mm screen).

The SVET Growth Chamber was outfitted for a gas-exchange measurement system so that environmental factors could be monitored in order to separate them from the effects of microgravity. The Greenhouse-2 experiment used a Balkanine substrate.³ Most of the recent substrates have been in the 1- to 2-mm-size fraction. The root tray was also outfitted with heat pulse sensors to measure substrate moisture content. The first water distributions were derived during the Greenhouse-2 experiment. Scott Jones, the first trained microgravity soil physicist, analyzed water flow data from this experiment. The root module was 10 cm deep. Heat pulse sensors were located at 3-, 5- and 7-cm depths.

The crew provided a lot of hands-on time on Greenhouse-2; they liked to touch and work with the plants. Ethylene (300 ppb) was a problem in the chamber due to the lack of an ethylene scrubber. Bingham believed that ethylene production was due to the U.S.'s periodic deliveries of fresh fruit.

Ethylene levels were probably below 50 ppb in Greenhouse-4 and -5 experiments. About this time (Greenhouse-4 and -5), *Mir* began to have methane problems. The methane scrubber probably brought the ethylene levels down as well.

Bingham presented data on hysteresis, which was significantly greater in Turface than isolite or zeolite (Appendix 2). Water flows in external pore spaces, but thicker water films predominate.

Space Dynamics Laboratory is currently working with the Russian Space Agency to develop LADA, which is expected to fly in the Russian module of the International Space Station.

3.4 OVERVIEW OF U.S. PLANT GROWTH UNITS INVOLVING SOLID SUBSTRATES: LEVINE

To date, most of the U.S. plant growth investigations conducted in space have used passive NDSs that provided an initial reservoir of water and nutrients designed to last for the duration of the experiment. The PCOC experiment by Brown and Chapman used pre-watered particulate substrate in this manner.⁶⁸ In a non-particulate approach, Cowles et al.³¹ used a sandwich support medium (consisting of white urethane foam and Miracloth over a 1% agar slab) to which nutrients were added pre-flight. Horticultural foam was subsequently used in a similar manner during the CHROMEX-01, -02, -04, and -06 spaceflight experiments. Levine & Krikorian⁶⁹ describes the general methodology, which essentially consists of cutting blocks of phenolic foam to fit the root zone container and then adding measured volumes of nutrient solution (pre-flight) upon which the plants draw during the mission. Provisions were made for the in-flight crew to replenish the foam's nutrient solution during the CUE (Cooperative Ukrainian Experiment) mission (STS-87). Tubes, plates, or bags filled with agar-solidified media have also been used in the CHROMEX (Chromosomes and Plant Cell Division in Space)-03, -04, -05, PGF (Plant Growth Facility, Arthur Anderson, Inc.), and PGBA (Plant Generic Bioprocessing Apparatus, BioServe Space Technologies, Boulder, Colorado) spaceflight experiments. While agar has a

number of advantages, especially for short-duration experiments and with small plants, its use generally results in poor root zone O₂ availability and altered root morphology.

Increasingly, active NDSs (which provide automatic nutrient replenishment from a remote reservoir) are becoming available for culturing plants in space. Some of these use porous or perforated water input tubes embedded within particulate substrates (WCSAR's Astroculture, the Russian SVET Greenhouse, Orbitec's Biomass Production System). In a less technologically complicated approach, substrate-filled bags containing wicking strips that come to a wetness level equilibration with an external water source have been used in the ASTRO-PGBA flight series. Additionally, Ames Research Center developed an on-demand NDS that relies upon drying out the substrate to trigger the resupply of water to the substrate.

Another approach currently under development is the PTNDS, in which plant roots grow directly on the surface of porous tubes through which a nutrient solution is passed. This eliminates the use of particulate substrates and minimizes problems associated with a lack of O₂ in the rhizosphere. The upcoming WONDER (water offset nutrient delivery experimental research) spaceflight experiment will undertake a side-by-side comparison of both a porous tube and a substrate-based NDS within a single plant growth chamber (as provided by the ASTRO-PGBA carrier produced by BioServe Space Technologies, University of Colorado, Boulder, Colorado). It will evaluate a minimum of three different wetness level treatments (for both categories of NDSs). The primary objective of the experiment is to determine if, or how, the optimum NDS wetness levels shift in space relative to the 1-g condition. Ground studies are currently evaluating alternative experiment scenarios regarding wetness level treatments (and the means by which they will be controlled), substrate composition, nutrient provision, etc.

Alexander asked what major treatments are being looked at in WONDER. Levine replied that he would be looking at indirect spaceflight effects and plant performance. He will be comparing different levels of "wetness." He wants to define "optimal" growing conditions on the ground (i.e. optimal root zone water content) and ask the question – "Will they be the same in microgravity?" Levine believes that the flight test will have an "optimal" porous tube water pressure and then two other water pressures: one wetter and one dryer. For example, the porous tube insert module will have 6 porous tubes and 3 wetness treatments. Or it could have three substrates – 3 wetness levels. Wetness levels could be 60%, 75%, and 85% relative water content. Final details of the treatments will be determined. The flight test will have substrate moisture sensors. Currently 1- to 2-mm Turface with Osmocote pellets is being used, but the type of substrate could change. Other potential candidates are zeponics and a fibrous mat with incorporated nutrients. The fibrous mat could be used with the PTNDS by wrapping the mat around tubes. It could also be used in conjunction with the solid substrate NDS.

The ALS Program has requested that the system be launched dry and initiated on orbit. This is a considerable challenge, but in the space station era we are entering, most plant experiments will face the challenge of being stowed dry and initiating seed imbibition when crew and resource schedules permit. This capability also will be required for an extended-duration mission to Mars. One reason to launch dry is that power is limited during launch. Bingham also notes that root modules on *Mir* may be stored 2-3 months before wetting-up. Launching wet may present problems with microbial or fungal growth, and premature seed germination. Since U.S. systems

are automated, seed sowing on orbit may not be practical. Substrate wetting and seed germination are as big a challenge as growing the plants in microgravity.

There is considerable debate about where the water introduction tubes should be situated within the rhizosphere of the substrate-based NDS. At 1 g, a top-most location would be ideal analogous to the natural condition where rain falls on a field and excess water percolates downward, thereby wetting the entire substrate without over-wetting the top-most layers. Most space hardware designs (SVET-Greenhouse, Astroculture, Biomass Production System) place the watering tubes in the center of the root matrix. Levine et al.⁴³ (Appendix 3) have made the argument that a bottom placement of the watering tubes makes most sense relative to the task of initially wetting the substrate in as uniform a fashion as possible, and in terms of maintaining a valid ground control capability.

This brings up the question of how best to perform a ground control experiment. Naturally, it will always be preferable to perform experimental controls in space on 1-g centrifuges, but clearly the opportunities to do so will be limited (especially for larger-scale experiments). In the absence of this capability, it has been argued that we can employ different water tube placements or different substrate particle-size distributions to make the ground control's water distribution patterns more similar to that obtained under microgravity conditions. To some, these types of solutions are counter to the traditional concept of the spaceflight ground control, but perhaps a reevaluation of the "ground control" mentality is required. Bingham notes there is a mentality among this group that you have to make plants behave as they do on Earth. For the water offset nutrient delivery experiment... what is the offset and what is the best replication? Microgravity will not provide the same conditions as Earth. A control on the ground does not behave as in space; it is best to do controls in space. You don't have to fly the same system as used for the Earth control; or the control may not be optimal for microgravity flights.

3.5 SUMMARY OF WATER FLOW THROUGH SOLID SUBSTRATES IN MICROGRAVITY: JONES

In his research, Jones asked whether capillary flow models work in microgravity and what are the areas of concern (Appendix 4).⁵⁶⁻⁵⁸ Jones applied existing capillary flow models to simulate water content and flow in microgravity using the Richard's equation⁶⁰ and the HYDRUS-2D model for simulating the two-dimensional movement of water in variable saturated media (U.S. Salinity Laboratory, USDA, Riverside, California). His analysis focused on the few flight data sets available: Astroculture-1 porous tube delivery system (U.S.)⁴⁰ and Greenhouse-2 (Russian)³ wheat growth experiment. Both experiments had rectangular root modules: about 25 mm deep for Astroculture-1 and 15 cm deep for Greenhouse-2. There was significant difference between water content and time for 1 g and microgravity. Jones identified potential mechanisms of concern.

Astroculture-1 had a 5- × 4-cm root tray filled with arcilite (0.6-1 mm) that was launched wet. Microporous tubes delivered water. A reduced saturation level was determined for microgravity due to air entrapment. In microgravity, 'n'—an empirical parameter for the Van Genuchten equation for predicting hydraulic conductivity of unsaturated media⁷⁰—is 2 to 3 times larger, indicating a narrower pore size distribution for water flow. Not all pores were participating in

water flow, possibly due to air entrapment. The Richard's equation and HYDRUS-2D worked fairly well in describing data from this flight test.

The Greenhouse-2 experiment had heat pulse moisture probes in a Balkanine growth media that was launched dry. Heat pulse moisture sensors were placed at depths of 3 (short), 5 (medium), and 7 (long) cm in a 15-cm-deep tray. Water was pulsed into the media through a wick located at 6 cm. It was a slow process getting water into smaller pores. Large differences in water content with depth were noticed. It was hard to model long (7-cm) depth. Water content was higher in the bottom of the tray (7- to 15-cm depth) as measured by the sensor at the 7-cm depth. Water did not flow easily from wick to media due to a disparity in pore size between wick and media. HYDRUS-2D did not adequately explain hydraulic conductivity. Balkanine exhibited a dual pore size distribution. Internal pores filled at 25% water content. Water content greater than 25% filled interaggregate pores.

To use HYDRUS-2D, Jones had to reduce hydraulic conductivity by four orders of magnitude; this is an area that needs further study. It may involve the form of the hydraulic conductivity function in the model and parameterization. Or noted that it was not likely that hydraulic conductivity was reduced by four orders of magnitude. The saturated conductivity should not be different. On Earth, one cannot extrapolate between saturated and unsaturated hydraulic conductivity due to macropore flow. Schaap replied that inverse modeling could be used here. Optimum flow parameters could be derived from water transport data through porous media.

Jones presented several mechanisms that may explain the microgravity scenario including particle capturing and interfacial flow. Monolayer glass beads in 1 g show significant capillary forces that draw particles away and create air gaps. There is a need to look at dry and saturated conditions in a free-floating condition (microgravity). During drying, void space is created.

A macroscopic versus microscale approach to the problem was introduced. Discussion focused on microscopic effects after expansion of the time scale from micro to macro, and the time it takes to reach equilibrium. Root modules are also difficult to model because of a) pore size disparity, b) hydraulic discontinuity that creates a barrier to gas diffusion and root growth, and c) the fact that the Richards equation⁶⁰ is for the macroscale.

Possible mechanisms affecting water transport in microgravity were broken into two areas: 1) enhanced interfacial flow and altered liquid-solid forces leading to 2) capillary particle capturing, Haines jump^{††}, particle rearrangement, particle separation, unstable wetting front, air-entrapment, particle rearrangement and dynamic pore distribution, liquid entrapment, and hysteresis...which all result in a modified water retention curve.

^{††} So named for W. B. Haines, who published "Studies in the physical properties of soils. V. The hysteresis effect in capillary properties and the modes of moisture distribution associated herewith" in 1930 in the Journal of Agricultural Science (Vol. 20, pps. 97-116).

3.6 DISCUSSION TOPIC 1: MICROSCALE FLUID PHYSICS (ALEXANDER AND DAIDZIC, DISCUSSION LEADERS)

Five topics were proposed for discussion: contact angle, capillary pressure and interfacial flow instability, visco-elastic continuum approach to porous media, transport phenomena, and gaseous diffusion in microgravity.

Is capillary and contact angle hysteresis a problem? Do we need to understand it? One could do an uncertainty analysis of the contact angle problem. It may be a question of competing gradients and how they affect each other. It may deal with fundamental versus volume-averaged approaches. We may need to understand the dynamic contact angle, which can be done with a water characteristic curve (water retention curve, desorption curve). Accentuated hysteresis can be explained from the dynamic contact angle, as well as the process of wetting an initially dry media. How important is it to understand contact angle hysteresis on water conductivity?

Scovazzo suggested that how the characteristic curve changes in microgravity may be more important than the contact angle. Gravity has little effect on small pore sizes; the Bond^{§§} number is small. Gravity and surface roughness affect the contact angle, but gravity does not affect surface tension. Also, how we measure determines what we measure. Again, the question of microscale factors over time was discussed.

In microgravity, macropore changes are likely while micropore changes are unlikely. Bingham said that once a water film is broken in microgravity, it is difficult to rewet. A thick water film needs to build up to pull particles back into contact—to bridge gaps before water transport can occur. Podolsky noted that there were still void spaces after employing the Russian packing technique of poking the medium with a finger followed by a pen. Large void spaces decrease capillary pressure. Or summarized that, for a given matric potential, you should have less water content in microgravity. The bond number changes by 3 to 4 orders of magnitude. A suggestion was made to do scaling experiments. Scovazzo suggested constructing a microgravity equivalent soil and comparing the water retention curve. The group suggested a research topic: enhanced hysteresis versus bond number or another number to be determined.

A change in packing will affect the water retention curve. A suggestion was made to measure water retention curve under dynamic conditions and look at time-dependent soil hydraulic properties. Jones believes that hydraulic property models need improvement, as there are problems with them on Earth. An example was assuming a tubular model for capillary flow. The suggestion was made that it should be film flow on capillary surfaces.

Podolsky suggested that a model should be constructed specifically for microgravity.

Or stated that there are issues related to the geometry of the media. As examples, he asked whether solid-liquid interactions would be the same in microgravity and 1 g, and whether there is a reconfiguration of the solid and liquid interfaces and what the consequences of this

^{§§} Bond number is the ratio of body force due to gravity-to-surface tension force. For additional information, see *Fundamentals of low gravity fluid dynamics and heat transfer*. Antar, B.N., V.S. Nuotio-Antar. 1993. CRC Press. Boca Raton, FL.

reconfiguration would be. Klutenberg suggested conducting simple experiments in space to show that macroscale modeling does not explain flow and hence, bringing in the microscale modeling. Podolsky brought up the point of model coefficients and the need to investigate what they might be in microgravity. There was general agreement of the need to develop 'space' coefficients for standard soil water transport models.

Or suggested that there was a need for experiments with a fixed space medium to rule out factors due to geometry (and changes in geometry, i.e., particle separation). With regard to packing the substrate a suggestion was made, for a predetermined water content, to pack the medium to an optimal density, dry the medium, and launch it dry after packing.

Podolsky showed pictures of Russian experiments with different media. There were more roots in aeroponics versus substrate; roots explored and extracted N_2 from all areas of the substrate. He stated that they have added substrate water content probes (heat conductivity). The sensitivity was about 1% in microgravity. Levine brought up the question of how to calibrate these sensors. The need to recalibrate after launch was discussed. Podolsky presented a theoretical model for microscale effects in microgravity. The critical need for good soil moisture and gas sensors for use in substrate in microgravity was discussed. Sensors are needed for basic flow through porous media research as well as control and monitoring the root zone in plant production units. Podolsky said he is considering using ultrasonic methods to enhance gas movement through substrate. Scovazzo pointed out that this might also enhance gas and liquid separation.

The decrease in air and water permeability in microgravity was discussed. There was an observation that water stays in the system rather than draining, even if you overfill it. The effect of interfacial wetting on air entrapment was described: a pore in 1 g will have water at the bottom of the pore and air at the top; a pore in microgravity will have water film around the outside of the pore with air entrapped in the middle.

Reusing soil was discussed, along with the issue of particle separation. The root mass may stabilize particles and decrease particle separation. Scovazzo brought up the need to look at interface resistance because interfaces between two media can act as a third virtual media. Interfaces would include media:root and media:tube.

SUMMARY OF MICROSCALE FLOW RESEARCH NEEDS

1. Pore geometry
 - a) Liquid-gas interface configurations (possible causes of enhanced hysteresis)
 - Film vs. channel flow
 - Air entrapment
 - Packing density
 - Packing rearrangement
 - Fluid/gas interface rearrangement
2. Consequences of pore geometry on transport
 - a) O_2 diffusion
 - b) Hydraulic conductivity
 - c) Transport coefficients (for models) dependent on g conditions
3. Water retention

- a) Definitive experiments
 - b) Results applied to design
4. Water flow resistance of interfaces

3.7 DISCUSSION TOPIC 2: OPTIMIZING WATER RETENTION AND AERATION (STEINBERG, DISCUSSION LEADER)

Substrates used or proposed for plant growth: Zeolites and expanded clays are somewhat complex. There was discussion on uniform particle size distribution. Is it necessary? The narrower the range of pore size distribution, the flatter the plateau of the water release curve. The flat plateau may make it harder to control water transport and aeration. A plateau with greater slope (such as for a loam or clay) would provide a greater range of safety. Bingham showed the water retention curves for Turface, isolite, and the zeolite clinoptilolite (Appendix 2). Water retention curves look similar for the substrates, but hysteresis differs. Hysteresis is a significant microgravity control problem. The range of water potential control and how tightly it needs to be controlled is a strong function of particle size. The change in water content that results in significant change in matric potential is a control parameter. Bingham stressed that Turface would be more problematic to control as compared to isolite and zeolite.

The suggestion was made to use the porous tube system to pull excess water out of the media. Bingham said that if you pull the water out too fast in microgravity you create hydraulic discontinuity, which would result in incomplete water removal. How fast can you pull the water back before you break the water column?

Or showed a figure illustrating competing processes in media: high O₂ diffusion when the medium is dry and high hydraulic conductivity when the medium is wet. He emphasized the need to find a range where water and gas fluxes are optimized (Appendix 5). Schwab suggested developing an active air system to pump air into the media. Bingham stated that channelized flow occurs in microgravity. Using a porous distribution system, such as a gas permeable membrane, was suggested. Bingham stated that there would still be a channelized flow. The question of pore size distribution versus media aeration was brought up. Or stated that O₂ diffusion was limited by the smallest pore size.

Or stated that a way to overcome the complexity and uncertainty of using particulate media would be to engineer a material specifically designed for space. The material could be optimized using techniques from material science. Hydrophobic (e.g. Teflon) versus hydrophilic materials could be used to construct airflow pathways. The material would optimize pore space and water-holding capacity, and include encapsulated nutrients, etc. The material might be particulate or it could have a fixed geometry.

Levine showed a fibrous mat as an example of an engineered substrate. The point was brought up that the fewer active elements in the system the better it would work, both from an engineering and from a control point of view. For example, if you pulse water into the root zone rather than actively control tube water pressure, you will have a longer pump life. But if you flood (water pulse) the root zone and then draw the matric potential of the substrate back down, the slower the draw down rate, the better.

There was a question about supplying O₂ through irrigation. Bingham has done the calculation and it falls about 100 times below the needed O₂ amount.

What are the criteria for such an engineered substrate? Or explained that an engineered substrate would combine some or all of the following: controlled pore size; use of fibers to increase hydraulic conductivity; rheological studies to ensure good root exploration; recyclable, physical parameters, etc. The reusability of the solid substrate was discussed. From the ALS Program point of view, reusability is desirable, but several people suggested that requiring reusability might be counterproductive. Currently there is little data available to design a substrate. Participants suggested the following criteria or parameters that would be needed to engineer such a material:***

| | |
|--|---|
| Volume | Root penetration (reshaping) |
| Physical parameters | Nutrient storage (ion exchange, adsorption, encapsulation, nutrient solution) |
| Water flux (5 L/day/m ²) | Water storage |
| O ₂ flux (3 μmol/m ² /sec) | Spatial distribution |
| O ₂ content (>2%) | Reusability |
| Air-filled porosity (10% minimum) | Water supply system (porous tube, "trickle like") |
| CO ₂ flux | O ₂ supply system |
| Root volume (species dependent) | Microbes |

Packing of particulate media: This was acknowledged as a problem, and the question was asked: Do we need to come up with protocol for packing? Kluitenberg stated that medium should be packed wet, then dried for launch. The question was asked: Has anybody done basic packing studies on substrates used for flights? Soil physicists do packing experiments all the time. Bingham pointed out that the placement of wicks and sensors in the media complicates packing procedures. Kluitenberg noted that he packs his sensors in media all the time. The point is made that sensors that rely on thermal conductivity to measure media moisture content are highly sensitive to packing and bulk density. There was some discussion of the advantages and disadvantages of horizontal versus vertical placement of sensors with regard to packing protocol.

Levine showed an example of horticultural foam (Oasis), an example of a fixed geometry material that is used widely in the horticultural industry. It is available in various pore sizes. This foam has already been used in some flights. The discussion again centered on using fixed pore space versus particulate media, viscoelastic materials, and the need to research water transfer and water uptake.

The group proposed the research question: What is the effect of wet/dry packing, launch vibrations (10 to 20 g), etc., on the bulk density and water relations of particulate substrate? Two

*** Participants gave numeric parameters during the meeting with the understanding that they should be corroborated in the literature or by direct measure. m²=chamber area.

different scenarios were proposed: pack wet and then dry before launch, or launch wet. Steinberg noted that Astroculture-1 was launched wet⁴⁰ and that Jones' analysis of the data from that flight showed a good agreement with current water transport models. Jones agreed that Astroculture-1 data showed better results and less discontinuity in hydraulic conductivity than data from Greenhouse-2 (*Mir*),³ which was launched dry. Particulate media may survive launch vibration better when wet than when dry. The amount of wetness may also affect capillary forces. Shape may be an important parameter to look at for packing. Particle topology is the science that needs to be addressed here. Isolite has a uniform shape and may pack better as a result.

Sensors (moisture, air, O₂, pressure): *Pressure transducers:* There is a need for research and development of pressure transducers that can measure ± 1 cm or 0.1 kPa or better and that are compatible with water. Morrow noted that Orbitec uses Motorola sensors even though the company states they are not compatible with water. He stated that only about 40% of those sensors pass Orbitec's test requirements.

Soil moisture sensors: At present, time domain reflectometry is not useable on Shuttle, *Mir*, or ISS because of frequency interference (electromagnetic interference emissions). Is this something we need to look into? Bingham and others indicated this is the best way to measure soil moisture.

Bingham described the calibration procedure for heat-pulse moisture sensors (single probe sensors that measure heat conductivity) in space. A line is drawn between a measurement point taken in dry medium and in medium wetted to given water content. Kluitenberg warned that the calibration between sensor output and substrate water content is not linear. Bingham agreed. Kluitenberg pointed out that volumetric heat capacity measurements can be done without calibration.

Or restated that thermal conductivity measurement of soil moisture is a good method, as long as the substrate around the sensor is constant. Placing a 'bare' sensor directly in the particulate matrix is dangerous if bulk density is likely to change. There are ways to eliminate this problem, such as encapsulating the probe in a porous ceramic material. The matric potential of the porous ceramic material would equilibrate with that of the medium. Changes in bulk density would not affect this process as much as with a bare sensor. Encapsulation will cause a delayed response, but no loss of accuracy. There will be fewer problems related to decoupling the sensor from the surrounding medium. The sensor would require calibration. Its accuracy at the wet end would be based on the pore size of the porous material surrounding the sensor. A single probe sensor of this type is currently available from Campbell Scientific (Logan, Utah).

We discussed the dual-probe heat-pulse sensor, which comprises two needle-sized probes and uses volumetric heat capacity as a measure of soil water content.⁷¹ It has the advantage of requiring no calibration. Bingham suggested that if the probe diameter were similar in size to the particles there would only be random contact between the probe and the substrate. He said that the probe needed to be larger than the particles in the substrate to ensure that a sufficiently large number of particles are in contact with the probe. Kluitenberg said the dual probe was a 12-volt system based on heat impulse technique. The power consumption is similar to that of a line

source. The standard error is $\pm 2\%$, nearly the same as time domain reflectometry. The dual-probe heat-pulse sensor probe can measure heat capacity, thermal conductivity, electrical conductivity, soil water flux density, pore water velocity, and temperature. The probes are packed horizontally into the media.

O₂ Sensors: Bingham used a galvanic O₂ sensor. He pointed out that one is measuring O₂ in a saturated media with water vapor everywhere, and there is a need to eliminate water films that block diffusion. Current sensors are too large. Open air spaces in the sensor fill with water. Bingham and Monje suggested covering the sensor with Teflon tape to keep the water out. There is a need to solve this problem with improved sensor technology. The current sensor Bingham used has a 6-month to 1-year life span and also requires a temperature sensor. Apparently there are some new sensors that may last up to 6 years.

Oceanoptics produces a fiber optics sensor. Monje said that it works well in water or in air, but not in between, because of temperature sensitivity. There is a question of which calibration curve to use—the one for water or the one for air. The fact that the fiber optics sensor requires a spectrophotometer brought up the issue of size and volume constraints in microgravity. Scovazzo suggested covering the fiber optic sensor with a 'sock' containing water or gel that would act as an O₂ permeable membrane. Then one could use the calibration curve for water.

The laser diode sensor was described as hard to use and to calibrate. Even a small amount of water on the end of a sensor can make a big difference. Sensors for science and medicine have a diode laser sensor that may work in the solid substrate application. It is a small diode with a laser that is pulsed to measure O₂. Monje mentioned that this company is busy making medically related sensors. They are not interested in working with individuals, but have indicated a willingness to work with NASA as a single point of contact.

Monje mentioned a root O₂ bio-availability sensor—a thin film electrode coated with gel. It is an electrochemical polarographic sensor that has the dimensions and O₂ consumption characteristic of a plant root. One problem with this sensor is that it is dependent on the type of material used. Marshall Porterfield (University of Missouri) built a prototype, which was tested on a KC-135 flight.⁷² The advantage of this sensor over other root O₂ sensors is that it simulates a root, eliminating the need for a 'biological' root to conduct O₂ consumption experiments. However, this sensor is still in an experimental/developmental stage.

Another method is a Zr-high temperature sensor. It was agreed that this sensor would be problematic because of high temperatures of around 100°C.

It was recommended that we approach sensor development programs within NASA for development of an O₂ sensor. Do we need O₂ sensors all the time or just in the design phase? It was recommended that a sensors working group be formed to address sensor needs.

SUMMARY OF RESEARCH NEEDS FOR OPTIMIZING AIR AND WATER IN THE SUBSTRATE

1. Media selection, development, and characterization
 - a) Particulate, engineered, foam, mat
 - b) Definitions, material sciences issues
 - c) Characterization

- Hydraulic conductivity
 - Water retention curve
 - Geometry
 - d) Packing
 - Moist versus dry in relation to the effect of launch vibration
 - Amount of wetness in relation to capillary forces
 - Pack wet/then dry for launch
 - Launch wet
 - Particle geometry/topology
 - e) Solute transport and solution chemistry
2. Sensors
- a) Soil moisture
 - Look at coupling time domain reflectometry with conductivity
 - Bare versus embedded
 - b) O₂
 - c) Pressure
 - d) Electrical conductivity
 - e) Have NASA sensors group address items 2a-2d
 - f) Sensor performance in microgravity

3.8 DISCUSSION TOPIC 3: RHIZOSPHERE (STEINBERG, DISCUSSION LEADER)

What happens to substrate water content measurements made by heat pulse probes when you introduce roots and organic material into the medium? Roots are basically water, so does their presence affect the heat pulse probe measurement? How do roots modify the substrate? Or mentioned that the effect of root mucigel on substrate needs to be examined.

How will roots and microbes influence water content? What stresses develop? What are the interactions of roots with porous tubes? Do roots modify the function of porous tubes? Roots will likely cause bulk density changes, which modify the water relations of the substrate.

Podolsky pointed out that problems with their porous plates or tubes over 150 days of operation was due to clogging from roots, microbes, salts, etc. Morrow reported biofilm in their porous tubes after long-term plant growth studies using nutrient solution. Steinberg noted that, after a 90-day wheat test in zeponics, porous tubes showed no evidence of biofouling or root penetration when water was circulated in the tubes. Her tubes did have substantial deposition of an amorphous silica material on the outside. Ming attributed this to a form of apatite in the zeponic media, which is no longer used. It was noted that using nutrient-providing media might reduce biofouling inside the tubes because water instead of nutrient solution can be circulated. There was also discussion of using stainless steel tubes versus the more hydrophilic ceramic tubes on tube function. It was indicated that wettability might change during growth cycle. The Russians use the water-pulse water delivery method to get away from the problem of tubes clogging up or the pump wearing out.

Microbial/fungal growths in substrates need to be addressed. Damaging microbes and fungus come from somewhere. A suggestion was made to 'contaminate' or inoculate the substrate with

a variety of microbes in a controlled way with the purpose of maintaining a well-balanced population of microbes within the media.

There was discussion of the volume of substrate needed relative to canopy volume. Steinberg pointed out that the root mass in hydroponic culture was typically 3% of total plant mass. Hydroponics is considered the best way to control water, air, and nutrients in the root zone. Biomass partitioning to roots in solid substrate culture tends to be higher than in hydroponic culture because slight water or nutrient stress is always present.

Jones reported that, after 180 days of wheat growth in substrate, a root mat developed on a porous plate used for water delivery located on the bottom of the tray. Was this hydrotropism or geotropism? Steinberg reported that, after a 64-day wheat test with water delivered from porous tubes located several centimeters from the bottom of the tray, roots were present throughout the substrate with a significant number concentrated on the bottom.

Use of sensors to control or monitor the root zone: Levine asked the group for input on use of sensors: Do you rely on feedback from sensors to control water, or do you have a certain rate of water that you push through a system and use sensors to monitor the system? It was brought out that preprogrammed watering might be dangerous due to unplanned crop changes. It was also suggested that using soil moisture probes alone was not enough; visual analysis was also needed. Bingham commented that, when you use sensor feedback to control or change the system, it took some time to establish control and become comfortable with the measurements. In his experiments on *Mir*, establishing control took as long as 30 days. After that time, the system feedback was used for water control. The reason it took so long to establish control was not resolved. Bingham did not like to rely on a single sensor, but would feel confident with a series of sensors and a good control system. Schwab indicated soil chemistry could create problems with using sensors to control water. Monje reported that he had good water control for 6 to 12 days using sensors. Bingham said he controls the end point, but that the plant roots control the system.

Bingham reported that there is no problem with the controller/sensor; problems arise with changes in the system, for example, when the wick is wet, but the substrate is dry. Bingham reported having to flood the system to bridge the gap by creating thick water films. He noted that this was an example of hydraulic decoupling. The only way to counter this is to place sensors out in the substrate. Bingham stated that he pulsed the system with water and let the plants dry it down. Scovazzo replied that as the media dries down, it will pull away from the source, causing decoupling. If a nearly constant tension is maintained, the medium next to the tube will always be wet. When using membranes or microporous materials, the pressure drop across the material becomes important.

Levine provided an overview of the BioServe water control system. Bioserve begins with predetermined substrate water content, and then feeds water from the transpiration stream back into the substrate. The question was asked again about moisture sensors failing to maintain a set point: Do you use preprogrammed water delivery, or use a control set point? Bingham reinforced the idea that in space things are different. Scovazzo indicated that he would not trust soil moisture curves generated in 1 g because changes would likely occur during launch and plant growth. It was again reiterated that you need well-placed soil moisture sensors to validate your watering scheme.

Preprogrammed watering with sensor monitoring was brought up again. Bingham asked, "What do you do if your program is based on a full crop and you only have 50% germination?" He said germination is often poor because of a water shell around the seed. How good would preprogrammed watering for 100 plants be if you only had 50 plants? The issue of whether you control to a set substrate matric potential or feed rate was brought up.

RESEARCH ISSUES FOR USING SENSORS TO CONTROL/MONITOR THE ROOT ZONE:

1. Set points
2. Position of sensor relative to crop
3. How many sensors are needed
4. Packing sensors in solid substrate

3.9 DISCUSSION TOPIC 4: MODELING (STEINBERG, DISCUSSION LEADER)

Needs for modeling: The modeling effort would need to account for small volume root zones in microgravity. A model is needed for soil O₂. Or pointed out that there is a need for a "tool box" for the purposes of design, real-time control, and analysis of data. The starting point would be to drop the gravity term as a first approximation. One could then look at other gravity-related factors. It was suggested that a model like HYDRUS-2D could be the starting point after it was modified for microgravity. The second step would be to embed modules for CO₂ and O₂ and use it to explain/optimize gas and water flux in microgravity: Start with model and add data from planned ground and flight experiments to fill in unknown data sets. Bingham suggested forming a modeling group or workshop to address this problem.

Boundary conditions are more complicated for flight experiments. HYDRUS-2D uses atmospheric conditions and would have to be changed for controlled environment life support systems and plants. Schaap reported that HYDRUS-1D and -2D are working; HYDRUS-3D should be ready soon. A super computer may be needed to run the HYDRUS-3D Fortran program. Schaap also pointed out that, for small volume root zones, it may not take that much time to run on a regular computer. The core module of HYDRUS is freely available through the U.S. Salinity Laboratory web site (www.usssl.ars.usda.gov/). The U.S. Salinity Laboratory can send a demonstration CD to anyone wanting to examine the capabilities of HYDRUS. Bingham has a task in an Orbitec Small Business Innovative Research grant to model soil moisture in a substrate. It is desirable to be able to display O₂/water for planning payload control. Henninger reminded everyone that we could do some short-term microgravity experiments with the Glenn Drop Tower and the KC-135. Highest on the list of measurement/modeling needs is the conductivity function and water retention curve.

Schaap pointed out that inverse modeling could also be applied using HYDRUS-1D or -2D. The model is run with initial soil moisture parameters and then an iterative process is used to obtain hydraulic properties. Schaap presented data from Astroculture-1⁴⁰ converted to outflow and then simulated with HYDRUS-1D to illustrate how we can use inverse modeling to determine hydraulic properties after an experiment is conducted (Appendix 6). It was noted that many researchers have used this method. The inverse model is applicable to HYDRUS-1D and -2D and may be applicable to HYDRUS-3D. A potential drawback is that often there is not a unique solution. This problem can be minimized by carefully designing and/or controlling the experimental boundary conditions. An example is a multistep outflow experiment to measure

volume. Adding tensiometers decreases risk for a non-unique solution. Kluitenberg noted that a combination of process identification and hypothesis testing is needed.

Bingham reminded everyone that we must be cautious when modeling a system where there have never been measurements. Others made the point that you need to have both modeling and real data to address this problem. Levine suggested that planned risk mitigation experiments also could be used to obtain data about water transport through porous media. Two-phase flow (air and water) has not been incorporated into the HYDRUS models, but it is possible to do so. HYDRUS models have been applied to several different applications including agriculture, a Buddha statue, and Jones' space soil physics work. Podolsky suggested that direct measurement with sensors in microgravity is probably more important than building models. There was overall agreement that advancement in this area would be an evolution of data gathering and modeling.

Initial flight design involvement is critical in placing sensor(s) in a plant growth system. Once experimental protocol is set, it is nearly impossible to change. A model could be useful to evaluate what-if scenarios such as, "If I put a sensor here what would it do?" Bingham points out that there are few chances on the U.S. side for data-gathering experiments, whereas the Russians have had more opportunities, i.e., *Mir* (SVET) and ISS (LADA). Or again stated the need to establish a tool box for microgravity environments (e.g., HYDRUS-0g-3D).

The need for similarity criteria in relation to modeling was brought up.

Solute transport/nutrient transport: How important is this parameter in microgravity? Should it be modeled? Schwab brought up the importance of solute transport in optimizing plant nutrients. Packing will have a major impact on solute transport in microgravity. Solution chemistry, electrostatic interactions, and how it changes with time will control water films around particles. It may also affect gas exchange. Solution chemistry involves the plant, soil, and water with plants as a sink.

HYDRUS models have a component for CO₂ equilibrium and root water uptake. Models like HYDRUS do not account for dynamic changes in the system, such as root development. In the beginning, just a sink term could be used. Then a root growth module could be added. There are three-dimensional dynamic models (e.g., Clausnitzer & Hopmans⁷³) available that account for solute uptake. Schwab's main point was that we need to look at sinks, roots, etc.

Schaap brought up the need to address salinity. Do we have solid materials loaded with nutrients or do we supply nutrients via nutrient solutions? With the latter, we have the issues of buildup of unused materials, supply rates, and salinity. Levine said Osmocote is used at Kennedy Space Center, and that a series of experiments are done to find the optimum amount. It was agreed that smaller volume root zones will need more control of solution chemistry.

Kluitenberg stated that we are on the cutting edge of knowledge of microscale soil physics. Experiments in microgravity might be a way to get at it. Pore water is often divided into two phases: immobile water and mobile water. Kluitenberg said that when soil physicists don't understand what's going on at the micro-level, they divide water into these two phases and look at their effect on water transport (macropores versus fractures). One could look at the effect of

pore size and hydraulic conductivity. A tracer could be used to characterize immobile and mobile water. It is a time scale problem. Alexander and Kluitenberg both pointed out the need for microscale soil physics addressing water and solute transfer. There was general agreement that there is a need to look at ways to answer these questions with basic research. The KC-135 flights could be used for some research, but conducting experiments during the approximately 20 seconds of microgravity would be a challenge.

Or summarized his work on the effect of pore geometry on fluid flow (Appendix 7).⁷⁴⁻⁷⁶ Present models do not account for liquid vapor interfacial area (surface area). Or pointed out that this is an omission that needs to be addressed. Or showed recent work on pore size distribution and geometry and described the effect of corner flow and film flow on unsaturated conductivity. Water retention curves can be constructed using adsorptive and capillary water. Several models are available to measure and predict liquid-vapor interfacial area. The role of films, and film flow versus carrier flow, can be used to predict unsaturated conductivity. Pore water is unstable and reconfigures itself. When a saturated pore empties, it is not a continuous process but a jump (Haines jump) when the pore empties abruptly. This is a displacement process involving cavitation, and does not include air entry. The displacing phase is water vapor.

Similarity criteria: Scovazzo brought up the point that similarity criteria could be used to design and run an experiment in 1 g that is similar to microgravity. These are scaling parameters or dimensionless groups commonly used in engineering. An example is the Reynolds number associated with fluid dynamics.⁷⁷ The idea is to select a scaling parameter and make sure it has the same number in 1 g and microgravity.

Bingham gave as an example the need to use smaller particle size in ground tests as compared to microgravity experiment to simulate same conditions. Scovazzo suggested the need to come up with new parameters. Or pointed out that this type of exercise would be important, giving diffusion as an example. Alexander noted that you can do scaling for several parameters, but one parameter will always “kill you.” For example, it is hard to counter the effects of hydrostatic pressure. Podolsky said we just do not have enough information (data) in a space environment to address scaling parameters. Scovazzo suggested that scaling factors will also be important in going from small microgravity systems to larger microgravity systems (e.g., scaling up from flight tests to ALS applications). Scaling parameters would be useful for comparisons between flight units and other equipment. The field does not agree what the numbers should be. One would measure certain things as a package. Alexander suggested that a subgroup could define the terms that need to be addressed.

Scovazzo gave several example equations that could be used to obtain dimensionless numbers. The gravity term (g) in conventional formulations of these dimensionless numbers is a problem for microgravity applications. In microgravity the gravity term is very small [on the order of 10^{-3} to $10^{-6} g_0$ (where g_0 (earth) = 9.8 m/sec^2)] and becomes a problem if represented by zero. For instance the following is one set of conventional dimensionless numbers (or similarity criteria) based on the Brooks/Corey Soil-Water Characteristic equation.^{59,77}

Dimensionless length: $L^* = (pgh)/\Psi_d$
 Dimensionless matric suction: $\Psi^* = \Psi/\Psi_d$
 Dimensionless flow rate: $Q^* = (Q/A)(\mu/(k_m p g))$

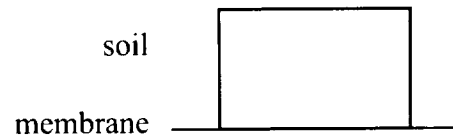

Where: p = density of water
 g = acceleration of gravity
 h = length in direction of fluid flux
 Ψ_d = matric suction at initial air entry
 Ψ = matric suction
 Q = volumetric flow rate
 A = area perpendicular to direction of fluid flux
 k_m = maximum permeability
 μ = viscosity of water

The development, and agreement, among researchers on a set of dimensionless numbers for microgravity similarity criteria would aid in comparing different microgravity experiments, designing data collection and reporting of experiments, and scaling up future microgravity systems based on current experimental work.

A dimensionless number is a ratio of relevant system properties such as the ratio of hydraulic head over matric head giving the conventional dimensionless length, L^* , shown above. Dimensionless numbers can be used to scale up from small experimental to larger systems. They would also be useful for comparing data between ground-based and flight-based experiments. Unfortunately, there is not one set of similarity criteria for use under conventional gravitation conditions, making the formulation of a universally accepted set for microgravity more difficult. The following is one possible set of similarity criteria for microgravity based on the Brooks/Corey Soil-Water Characteristic equation:

Dimensionless gravity: $g^* = (p g H) / \Psi_d$
 Dimensionless length: $L^* = h / H$
 Dimensionless matric suction: $\Psi^* = \Psi / \Psi_d$
 Dimensionless flow rate: $Q^* = (Q h / A) (\mu / (k_m \Psi_d))$

Where: H = total root zone height or thickness

SUMMARY OF RESEARCH NEEDS FOR MODELING

1. O₂ module
2. Use of HYDRUS-2D as a starting point
3. Define approaches for ground-based experiments
4. Lack of mature models for gas and liquid exchange in small volumes
5. Formation of a modeling group to channel the effort
6. Test media to simulate microgravity (microgravity equivalent)
7. Model coupled experiments
 - a) Hypothesis = model
 - b) Experiments to prove hypothesis
8. Detailed water characteristic curves (they would integrate microscale factors such as contact angle)

9. Boundary conditions for controlled environment life support systems
10. HYDRUS-3D – tool box
11. Inverse modeling to obtain parameters
12. Sensor development and placement
13. Model parameters (tubular versus film flow for capillary surfaces)
14. Special parameterization for 0 g, 1/3 g, 1/6 g
 - a) Hydraulic functions
 - b) Diffusion coefficients
15. Nutrient transport and solution chemistry: chemical potential changes and their effect on water transport
16. Mobile versus immobile water: rate transfer
17. Scaling up from micro- to macro-scale
18. Biological, including other gas exchange (CO₂)
19. Substrates
20. Similarity criteria for microgravity systems

4.0 LITERATURE CITED

- ¹Dutcher, F. D., E. L. Hess, and T. W. Halstead. 1994. Progress in plant research in space. *Adv. Space Res.* 14:159-171.
- ²Bingham, G. E., M. A. Levinskikh, V. N. Sytchev, and I. G. Podolsky. 2000. Effects of gravity on plant growth. *J. Gravitat. Phys.* 7:5-8.
- ³Bingham, G., S. B. Jones, I. Podolsky, and B. S. Yendler. 1996. Porous substrate water relations observed during the greenhouse-2 flight experiment. Soc. Automot. Eng. Techn. Paper 961547. SAE, Warrendale, PA.
- ⁴Porterfield, D. M., D. J. Barta, D. W. Ming, R. C. Morrow, and M. E. Musgrave. 2000. Astroculture root metabolism and cytochemical analysis. *Adv. Space Res.* 26:315-318.
- ⁵Porterfield, D. M., T. W. Dreschel, and M. E. Musgrave. 2000. A ground-based comparison of nutrient delivery technologies originally developed for growing plants in the spaceflight environment. *HortTechnology* 10:179-185.
- ⁶Porterfield, D. M., S. W. Mathews, C. J. Daugherty, and M. E. Musgrave. 1997. Spaceflight exposure effects on transcription, activity, and localization of alcohol dehydrogenase in the roots of *Arabidopsis thaliana*. *Plant Physiol.* 113:685-693.
- ⁷Averner, M. M. 1989. Controlled Ecological Life Support System. p.145-153. *In* D. W. Ming and D. L. Henninger (ed.) *Lunar Base Agriculture*. American Society of Agronomy, Madison, WI.
- ⁸Bugbee, B. G. and F. B. Salisbury. 1989. Controlled environment crop production: Hydroponic vs. lunar regolith. p.107-130. *In* D. W. Ming and D. L. Henninger (eds.) *Lunar base agriculture: soils for plant growth*. American Society of Agronomy, Madison, WI.
- ⁹Wright, B. D., W. C. Bausch, and W. M. Knott. 1988. A hydroponic system for microgravity plant experiments. *Trans. ASAE* 31:440-446.

- ¹⁰Kliss, M. and R. D. MacElroy. 1990. Salad Machine: A vegetable production unit for long duration space missions. Soc. Autom. Eng. Techn. Paper 901280. SAE, Warrendale, PA.
- ¹¹Rawlins, S. L. 1979. Watering. p.271-290. *In* T. W. Tibbitts and T. T. Kozlowski (ed.) Controlled environment guidelines for plant research. Academic Press, New York.
- ¹²Bugbee, B. G. and F. B. Salisbury. 1988. Exploring the limits of crop productivity. *Plant Physiol.* 88:869-878.
- ¹³Schwartzkopf, S. H., M. E. Oleson, and H. S. Cullingford. 1989. Conceptual design of a closed loop nutrient solution delivery system for CELSS implementation in a micro-gravity environment. Soc. Automot. Eng. Tech. Paper 891586. SAE, Warrendale, PA.
- ¹⁴Hessel, M. I., G. E. Richert, and Jr. G. E. Nevill. Airflow-contained aeroponic nutrient delivery for a microgravity plant growth unit. *Biotronics* 21:33-38.
- ¹⁵Clawson, J. M., A. Hoehn, L. S. Stodieck, P. Todd, and R. J. Stoner. 2000. Soc. Autom. Eng. Techn. Paper 00ICES-360. SAE, Warrendale, PA.
- ¹⁶Brown, C. S., W. M. Cox, T. W. Dreschel, and P. V. Chetirkiin. 1992. The vacuum-operated nutrient delivery system: hydroponics for microgravity. *HortScience* 27:1183-1185.
- ¹⁷Dreschel, T. W. and J. C. Sager. 1989. Control of water and nutrients using a porous tube: A method for growing plants in space. *HortScience* 24:944-947.
- ¹⁸Morrow, R. C., W. R. Dinauer, R. J. Bula, and T. W. Tibbitts. 1993. The ASTROCULTURE-1 flight experiment: Pressure control of the WCSAR porous tube nutrient delivery system. Soc. Automot. Eng. Techn. Paper 932282. SAE, Warrendale, PA.
- ¹⁹Heathcote, D. G., C. S. Brown, G. D. Goings, M. Kliss, H. Levine, P. A. Lomax, R. L. Porter, and R. Wheeler. 1996. The plant research unit: long-term plant growth support for space station. *Proceedings Sixth European Symposium on Life Sciences Research in Space.* Trondheim, Norway.
- ²⁰Tsao, D. T., M. R. Okos, and J. C. Sager. 1996. Controlling the water availability from a ceramic tube system subjected to non-standard gravities. Soc. Automot. Eng. Techn. Paper 961505. S.A.E., Warrendale, PA.
- ²¹Clark, G. J., G. E. Neville, and T. W. Dreschel. 1994. A root moisture sensor for plants in microgravity. *Adv. Space Res.* 14:213-216.
- ²²Johnson, C. F., T. W. Dreschel, C. S. Brown, and R. M. Wheeler. 1996. Optimization of moisture content for wheat seedling germination in a cellulose acetate medium for a space flight experiment. *Adv. Space Res.* 18:239-242.
- ²³Tsao, D. T., M. R. Okos, C. A. Mitchell, J. C. Sager, and T. W. Dreschel. 1994. Characterizing the transpirational uptake into plants cultivated on a ceramic tube hydroponic system. *Am. Soc. Agr. Eng. Paper No. ASAE, 2950 Niles Road, St. Joseph, MI 49085.*
- ²⁴Berry, W. L., G. Goldstein, T. W. Dreschel, R. M. Wheeler, J. C. Sager, and W. M. Knott. 1992. Water relations, gas exchange, and nutrient response to a long term constant water deficit. *Soil Sci.* 153:442-451.

- ²⁵Bubenheim, D. L., T. W. Dreschel, and C. A. Mitchell. 1987. Comparison of plant growth in a tubular membrane hydroponic system with that in conventional hydroponic culture. *HortScience* 22:10051.
- ²⁶American Institute of Biological Sciences. 1968. Wheat seedling experiments. *BioScience* 18:632-655.
- ²⁷Brown, A. H. and D. K. Chapman. 1984. A test to verify the biocompatibility of a method for plant culture in a microgravity environment. *Ann. Bot.* 54:19-31.
- ²⁸Merkys, A. J., R. S. Laurinavichius, O. J. Rupainene, D. V. Shvedzhdene, and A. V. Yaroshius. 1981. Gravity as an obligatory factor in normal higher plant growth and development. *Adv. Space Res.* 1:109-116.
- ²⁹Merkys, A. J., R. S. Laurinavichius, O. J. Rupainene, E. K. Savichene, A. V. Jaroshius, D. V. Shvegshdene, and D. P. Bendoraityte. 1983. The state of gravity sensors and peculiarities of plant growth during different gravitational loads. *Adv. Space Res.* 3:211-219.
- ³⁰Sytnik, K. M., E. L. Kordyum, E. M. Belyavskaya, E. M. Nedukha, and V. A. Taraseko. 1983. Biological effects of weightlessness and clinostatic conditions registered in cells of root meristem and cap of higher plants. *Adv. Space Res.* 3:251-255.
- ³¹Cowles, J. R., H. W. Scheld, R. Lemay, and C. Peterson. 1984. Growth and lignification in seedlings exposed to eight days of microgravity. *Annals of Botany (Supplement 3)* 54:33-48.
- ³²Heyenga, A. G. 1997. The utilization of passive water and nutrient support systems in space flight plant cultivation and research. *Proceedings of the 6th European Symposium on Space Environmental Control Systems*. Noordwijk, The Netherlands.
- ³³Heyenga, A. G., A. Forsman, L. S. Stodieck, A. Hoehn, and M. Kliss. 2000. Approaches in the determination of plant nutrient uptake and distribution in space flight conditions. *Adv. Space Res.* 26:299-302.
- ³⁴Hoehn, A., P. Scovazzo, L. S. Stodieck, J. Clawson, W. Kalinowski, A. Rakow, D. Simmons, A. G. Heyenga, and M. H. Kliss. 2000. Microgravity root zone hydration systems. *Soc. Automot. Eng. Paper 2000-01-2510*. SAE, Warrendale, PA.
- ³⁵Levine, H. G. and A. D. Krikorian. 1996. Enhanced root production in *Haplopappus gracilis* grown under spaceflight conditions. *J. Gravitat. Phys.* 3:17-28.
- ³⁶Salisbury, F. B. and C. W. Ross. 1992. *Plant Physiology*. Wadsworth Publishing Company, Belmont, CA .
- ³⁷Yendler, B., B. Webbon, and I. B. R. Podolsky. 1996. Capillary movement of liquid in granular beds in microgravity. *Adv. Space Res.* 18:233-237.
- ³⁸Goins, G. D., H. G. Levine, C. L. Mackowiak, R. M. Wheeler, J. D. Carr, and D. W. Ming. 1997. Comparison studies of candidate nutrient delivery systems for plant cultivation in space. *Soc. Autom. Eng. Techn. Paper 972304*. SAE, Warrendale, PA.
- ³⁹Levine, H. G. 1999. The growth of wheat in three nutrient-providing substrates under consideration for spaceflight application. *Acta Hort.* 481:251-258.

- ⁴⁰Morrow, R. C., R. J. Bula, T. W. Tibbitts, and W. R. Dinauer. 1994. The Astroculture flight experiment series, validating technologies for growing plants in space. *Adv. Space Res.* 14:29-37.
- ⁴¹Cao, W. and T. W. Tibbitts. 1996. Using a porous-tube system to study potato responses to constant water tension in a rooting matrix. *J. Amer. Soc. Hort. Sci.* 121:399-403.
- ⁴²Steinberg, S. L. and D. L. Henninger. 1997. Response of the water status of soybean to changes in soil water potentials controlled by the water pressure in microporous tubes. *Plant Cell Environ.* 20:1506-1516.
- ⁴³Levine, H. G., K. Louie, and O. Monje. 2000. A strategy for the initial wetting of a plant cultivation unit in space. Proceedings 37th Space Congress. Cape Canaveral, FL.
- ⁴⁴Steinberg, S. L., D. W. Ming, K. E. Henderson, C. Carrier, J. E. Gruener, D. J. Barta, and D. L. Henninger. 2000. Wheat response to differences in water and nutritional status between zeoponic and hydroponic growth systems. *Agron. J.* 92:353-360.
- ⁴⁵Ivanova, T. and I. Dandolov. 1992. Moistening of the substrate in microgravity. *Microgravity sci. techn.* 3:151-155.
- ⁴⁶Yendler, B. S., G. Bingham, S. Jones, and I. Podolsky. 1995. Moisture sensor for use in microgravity. Soc. for Automot. Eng. Techn. Paper 951471. SAE, Warrendale, PA.
- ⁴⁷Monje, O., G. E. Bingham, J. G. Carman, W. F. Campbell, F. B. Salisbury, B. K. Earnes, V. Sytchev, M. A. Levinskikh, and I. Podolsky. 2000. Canopy photosynthesis and transpiration in microgravity: Gas exchange measurements aboard *Mir*. *Adv. Space Res.* 26:303-306.
- ⁴⁸Tibbitts, T. W., W. Cao, and T. Frank. 1995. Development of a siphon system with porous tubes for maintaining a constant negative water pressure in a rooting matrix. *Biotronics* 24:7-14.
- ⁴⁹Jones, S. B. and D. Or. 1999. A capillary-driven root module for plant growth in microgravity. *Adv. Space Res.* 22:1407-1412.
- ⁵⁰Ming, D. W., D. J. Barta, D. C. Golden, C. Galindo, and D. L. Henninger. 1995. Zeoponic plant-growth substrates for space applications. p.505-513. *Natural Zeolites '93. Int. Comm. Natural Zeolites*, Brockport, NY.
- ⁵¹Takahashi, H., C. S. Brown, T. W. Dreschel, and T. K. Scott. 1992. Hydrotropism in pea roots in a porous-tube water delivery system. *HortScience* 27:430-432.
- ⁵²Ruff, M., D. T. Krizek, R. M. Mirecki, and D. W. Inouye. 1987. Restricted root zone volume: influence on growth and development of tomato. *J. Amer. Soc. Hort. Sci.* 112:763-769.
- ⁵³Spomer, L. A. 1974. Optimizing container soil amendment: The "threshold proportion" and prediction of porosity. *HortScience* 9:532-533.
- ⁵⁴Podolsky, I. and A. Mashinsky. 1994. Peculiarities of moisture transfer in capillary-porous soil substitutes during space flight. *Adv. Space Res.* 14:39-46.
- ⁵⁵Shah, S., W. E. Faller, A. Hoehn, M. Birdsong, and M. W. Lutgtes. 1993. Characterization of fluid distribution through a porous substrate under dynamic g conditions. *Biomed. Sci. Instrum.* 29:401-408.

- ⁵⁶Jones, S. B. and D. Or. 1998. Design of porous media for optimal gas and liquid fluxes to plant roots. *Soil Sci. Soc. Am. J.* 62:563-573.
- ⁵⁷Jones, S. B. and D. Or. 1998. Particulated growth media for optimal liquid and gaseous fluxes to plant roots in microgravity. *Adv. Space Res.* 22:1413-1418.
- ⁵⁸Jones, S. B. and D. Or. 1999. Microgravity effects on water flow and distribution in unsaturated porous media: Analysis of flight experiments. *Water Resour. Res.* 35:929-942.
- ⁵⁹Scovazzo, P., T. H. Illangasekare, A. Hoehn, and P. Todd. 2001. Modeling of two-phase flow in membranes and porous media in microgravity as applied to plant irrigation in space. *Water Resour. Res.* 37:1231-1243.
- ⁶⁰Hillel, D. 1982. *Introduction to soil physics.* Academic, New York .
- ⁶¹Hanan, J. J. 1998. *Greenhouses.* CRC Press, Boca Raton, FL.
- ⁶²Bunt, A. C. 1961. Some physical properties of pot plant composts and their effect on plant growth. III. Compaction. *Plant Soil* 15:228-242.
- ⁶³Spomer, L. A. 1974. Optimizing container soil amendment: The "threshold proportion" and prediction of porosity. *HortScience* 9:532-533.
- ⁶⁴Bunt, A. C. 1974. Some physical and chemical characteristics of loamless pot-plant substrates and their relation to plant growth. *Acta Hort.* 37:1954-1955.
- ⁶⁵Hanan, J., C. Olympios, and C. Pittas. 1981. Bulk Density, porosity, percolation and salinity control in shallow, freely draining, potting soils. *Journal of the American Society of HortScience* 106:742-746.
- ⁶⁶Handreck, K. A. 1983. Particle size and the physical properties of growing media for containers. *Comm. in Soil Sci. Plant Anal.* 14:209-222.
- ⁶⁷Bunt, A. C. 1988. *Media and mixes for container-grown plants.* Unwin Hyman, London.
- ⁶⁸Brown, A. H. and D. K. Chapman. 1982. The firsts plants to fly on the shuttle. *Physiologist* 25, Suppl.:S,5-S,8.
- ⁶⁹Levine, H. G. and A. D. Krikorian. 1992. Chromosomes and plant cell division in space: environmental conditions and experimental details. *Adv. Space Res.* 12:73-82.
- ⁷⁰Van Genuchten, M. Th. 1980. A closed-form equation for predicting the hydraulic conductivity of unsaturated soils. *Soil Sci. Soc. Am. J.* 44:892-898.
- ⁷¹Bristow, K. L., G. J. Kluitenberg, and R. Horton. 1994. Measurement of soil thermal properties with a dual-probe heat-pulse technique. *Soil Science Society America Journal* 58:1288-1294.
- ⁷²Porterfield, D. M., O. Monje, G. W. Stutte, and M. E. Musgrave. 2000. Rootzone hypoxic responses result from inhibition of gravity dependent oxygen transport in microgravity. *Gravitational and Space Biology Bulletin* 14:51.
- ⁷³Clausnitzer, V. and J. W. Hopmans. 1994. Simultaneous modeling of transient three-dimensional root growth and soil water flow. *Plant Soil* 164:299-314.
- ⁷⁴Or, D. and M. Tuller. 1999. Liquid retention and interfacial area in variably saturated porous media: Upscaling from single pore to sample scale model. *Water Resour. Res.* 35:3591-3606.

- ⁷⁵Tuller, M. and D. Or. 2001. Hydraulic conductivity of variably saturated porous media - Film and corner flow in angular pore space. *Water Resour. Res.* 37:1257-1276.
- ⁷⁶Tuller, M., D. Or, and L. M. Dudley. 1999. Adsorption and capillary condensation in porous media: Liquid retention and interfacial configurations in angular pores. *Water Resour. Res.* 35:1949-1964.
- ⁷⁷Corey, A. 1994. *Mechanics of immiscible fluids in porous media*. Water Resources Publications, Highlands Ranch, CO .

APPENDIX 1: MEETING PARTICIPANTS

J. Iwan D. Alexander, Ph.D.
Professor
Mechanical & Aerospace Engineering
Chief Scientist, National Center for Microgravity
Research on Fluids and Combustion
416 Glennan, Case Western Reserve University,
10900 Euclid Ave., Cleveland, OH 44106, USA.

Peter Kostka
Orbitec
1212 Fourier Drive
Madison, Wisconsin 53717

Gail Bingham, Ph.D.
Space Dynamics Laboratory
1695 N. Research Parkway
Logan, Utah 84341

Howard Levine, Ph.D.
Dynamac
DYN3
Kennedy Space Center, FL 32899

Nihad E. Daidzic, Ph.D.
The National Center for Microgravity Research
on Fluids and Combustion (NCMR)
NASA/Glenn Research Center at Lewis Field
21000 Brookpark Road, Mail Stop 110-3
Cleveland, OH 44135-3191, U.S.A.

Doug Ming, Ph.D.
Mail Code SX3
Johnson Space Center
Houston, TX 77058-3696

D. C. Golden, Ph.D.
Senior Scientist
Hernandez Engineering, Inc.
C-23 P. O. Box 58561
NASA/JSC
Houston, TX 77258-8561

Oscar Monje, Ph.D.
Dynamac
DYN3
Kennedy Space Center, FL 32899

Scott B. Jones, Ph.D.
Dept. Plants, Soils and Biometeorology
Ag. Sci Building - Old Main Hill 4820
Utah State University
Logan, UT 84322-4820

Bob Morrow, Ph.D.
Orbitec
1212 Fourier Drive
Madison, WI 53717

Donald L. Henninger, Ph.D.
Manager
Advanced Life Support Project
Johnson Space Center
Mail Code EC3, Building 7A, Room 234B
2101 NASA Road 1
Houston, TX 77058-3696

Dani Or
Professor - Soil Physics
Depts. of Plants, Soils, and Biometeorology
and Biological and Agricultural Engineering
Utah State University
Logan, Utah 84322-4820

Gerard J. Kluitenberg, Ph.D.
Associate Professor
Department of Agronomy
2004 Throckmorton Hall
Kansas State University
Manhattan, KS 66506-5501

Igor Podolsky, Ph.D.
Senior Scientist
Institute of Biomedical Problems
Khoroshevskoye Shosse, 76A
Moscow, 123007, Russia

Marcel Schaap, Ph.D.
U.S. Salinity Laboratory/USDA
450 W. Big Springs Road
Riverside, CA 92507

Susan Steinberg, Ph.D.
Scientist/Specialist
Liberated Technical
Mail Code C77
Johnson Space Center/NASA
2101 Nasa Road 1
Houston, TX 77058-3696

Paul Schwab, Ph.D.
Assoc. Professor
Department of Agronomy
1150 Lilly Hall of Life Sciences
Purdue University
West Lafayette, IN 47907-1150

Weijia Zhou, Ph. D.
Director
Wisconsin Center for Space Automation & Robotics
University of Wisconsin-Madison
545 Science Drive
Madison, WI 53705

Paul Scovazzo Ph.D.
Research Associate
Dept. of Chemical Engineering
Engineering Center ECCH 111
Campus Box 424
University of Colorado
Boulder, CO 80309

APPENDIX 2: SUBSTRATE PROPERTY CHARACTERISTICS

Courtesy of Gail Bingham, Space Dynamics Laboratory

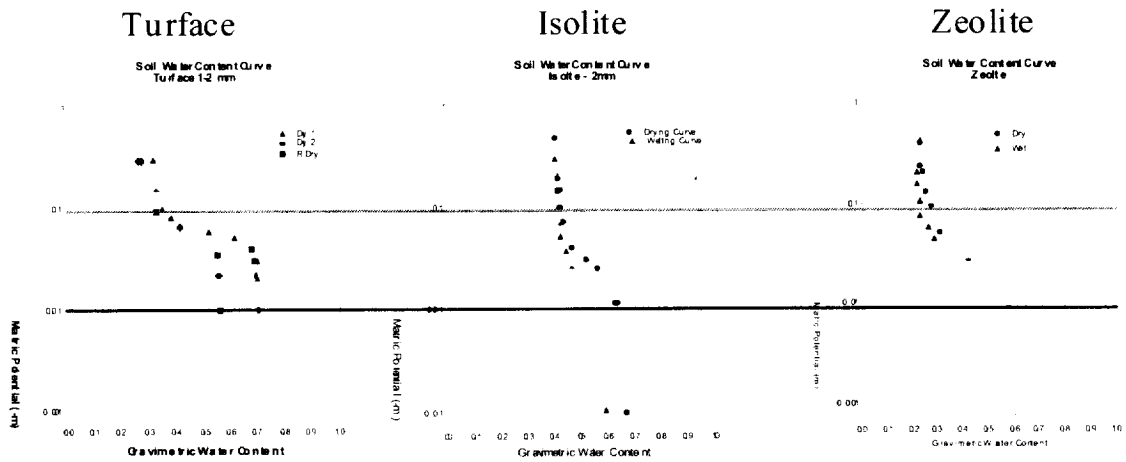

- Water retention curves look similar for the substrates, but hysteresis differs
- Hysteresis is a significant μg control problem (control deadband error)
- Range of water potential control is a strong function of particle size
- Range in matric potential that results in water content change is control range



Space Dynamics Laboratory

APPENDIX 3: WATER DELIVERY AND DISTRIBUTION

Courtesy of Howard Levine, Dynamac Corporation

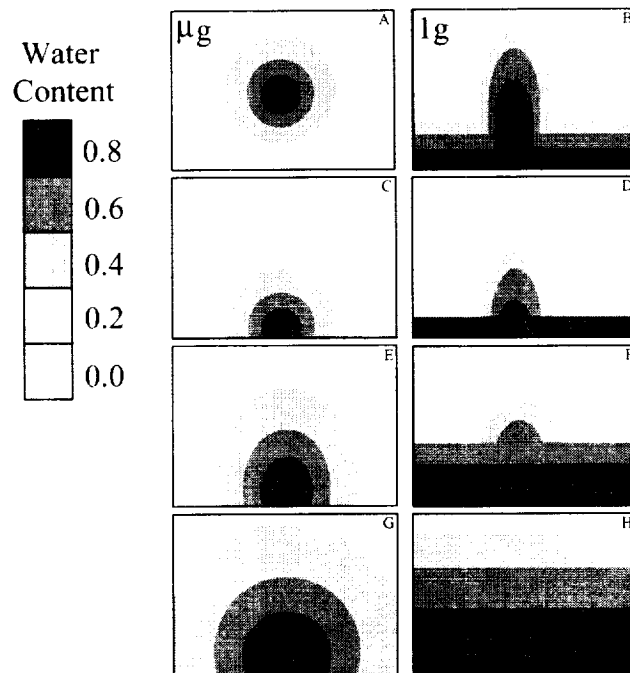

Critical to this endeavor is an understanding of the dynamics of water delivery and distribution under both 1 g and microgravity conditions. Data sets which address these questions were obtained during the Astroculture-I and Greenhouse-II space flight experiments, in which substrate-inserted moisture sensors generated the data diagrammatically represented by the patterns presented in Figures 1a,b (Jones & Or, 1999). In this depiction, the effect of microgravity can be seen to produce the highest concentrations of water immediately adjacent to the centrally situated (in the root zone) water input tube, and decreasing wetness levels with increasing distances from the water input tube (Figure 1a). In contrast, under 1-g conditions (Figure 1b), the effect of gravity was (not surprisingly) to pull the water down to the bottom of the chamber, resulting in an entirely different water distribution pattern. These patterns can be used to address the question of how to design the water delivery system for both spaceflight and ground control plant culture units. The argument has been made that different placements of the water input tubes for microgravity and 1-g operation would be the best way to optimize system performance for both conditions. However, there is a compelling justification to make the design the same for both units, i.e., so that the option to use the ground control unit would be available in the event of a preflight hardware failure in the flight unit. For 1-g operation, the optimal location for the water input tubes would be near the surface of the root zone so that the introduced water would percolate downward and uniformly wet the substrate (similar to the natural case in a field after a heavy rain). However, such a location would produce excessively wet upper layers in microgravity, and relatively (or completely) dry lower substrate layers (depending upon the volume of water introduced). A middle-situated water introduction tube would result in the patterns already discussed in Figures 1a,b. Clearly, this represents a drastically different growing regime for the spaceflight vs. ground control experiments, and would confound any attempt at discerning "direct" microgravity-related effects on plant growth and development. In contrast, if the water introduction tubes were situated on the bottom of the plant trays, it may be possible, at experiment startup, to completely flood and then remove the excess water under both 1-g and microgravity conditions. We present a hypothetical case for such a flooding regime scenario in Figures 1c,d,e,f,g,h. In both the microgravity (Figures 1c,e,g) and 1 g (Figures 1d,f,h) cases, a complete flooding of the root zone would be possible. And in theory, a subsequent draw-down or removal of the excess water would result in a uniformly wetted substrate which would approximate "field capacity" conditions.

APPENDIX 4: MICROGRAVITY EFFECTS ON WATER FLOW AND DISTRIBUTION IN UNSATURATED POROUS MEDIA

Courtesy of Scott Jones, Utah State University

Microgravity effects on water flow and distribution in unsaturated porous media: Analyses of flight experiments.

Scott B. Jones

Dani Or

Dept. Plants, Soils, and Biometeorology
Utah State University

Publications by Jones and Or

- A capillary-driven root module for plant growth in microgravity. *Adv. Space Res.* 1999.
- Design of porous media for optimal gas and liquid fluxes to plant roots. *Soil Sci. Soc. Am. J.* 1998.
- Microgravity effects on water flow and distribution in unsaturated porous media: analyses of flight experiments. *Water Resour. Res.* 1999.

Microgravity Experiments Analyzed

■ **ASC-1 porous tube nutrient delivery system**

- Matric suction was recorded

- Water volume change - inferred water content

■ **Greenhouse-2 wheat growth experiment**

- Spatial and temporal water content measurements

Objectives of Analyzing Past Microgravity Experiments

■ **Apply capillary flow models**

- Simulate water content and flow

- Hydrus 2-D - Richards equation

■ **Identify potential mechanisms of concern**

- Reasons for anomalous behavior

- Parameterization and comparison

Microgravity Root Modules

ASC-1

Greenhouse-2

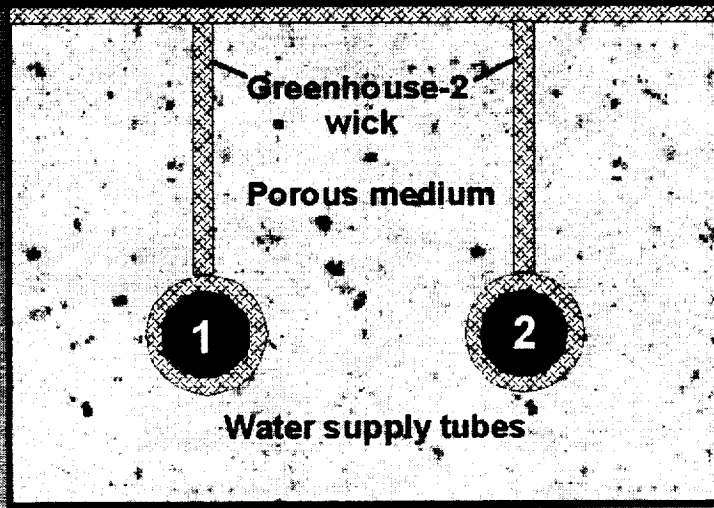

ASC-1

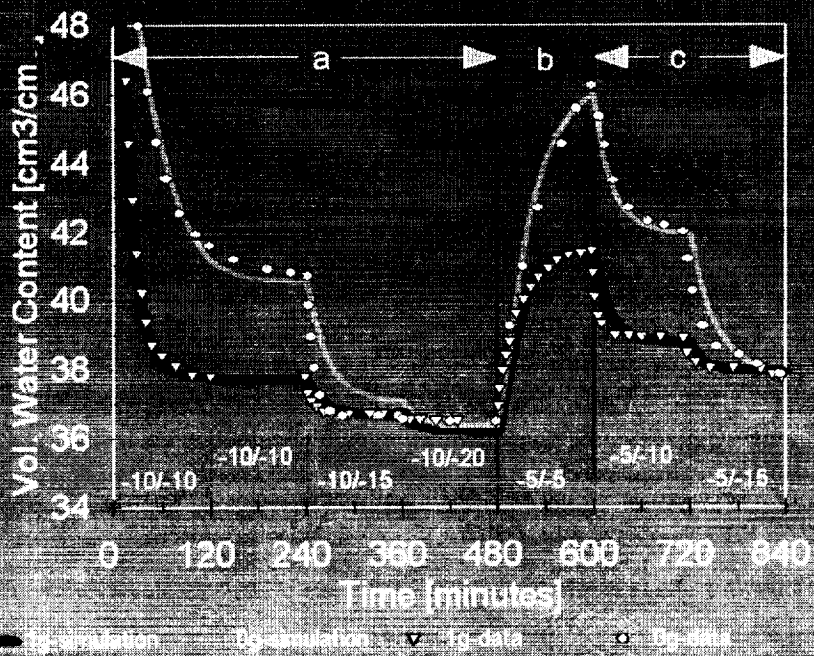

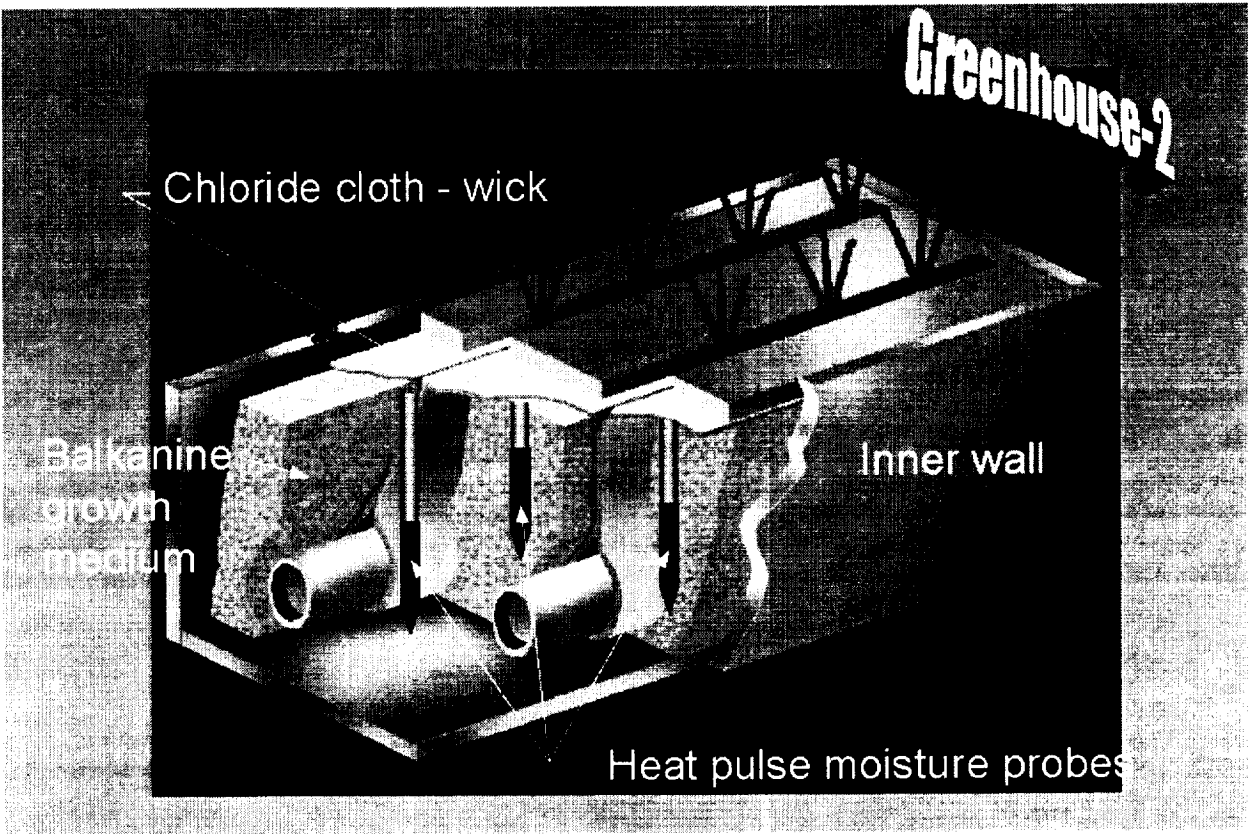
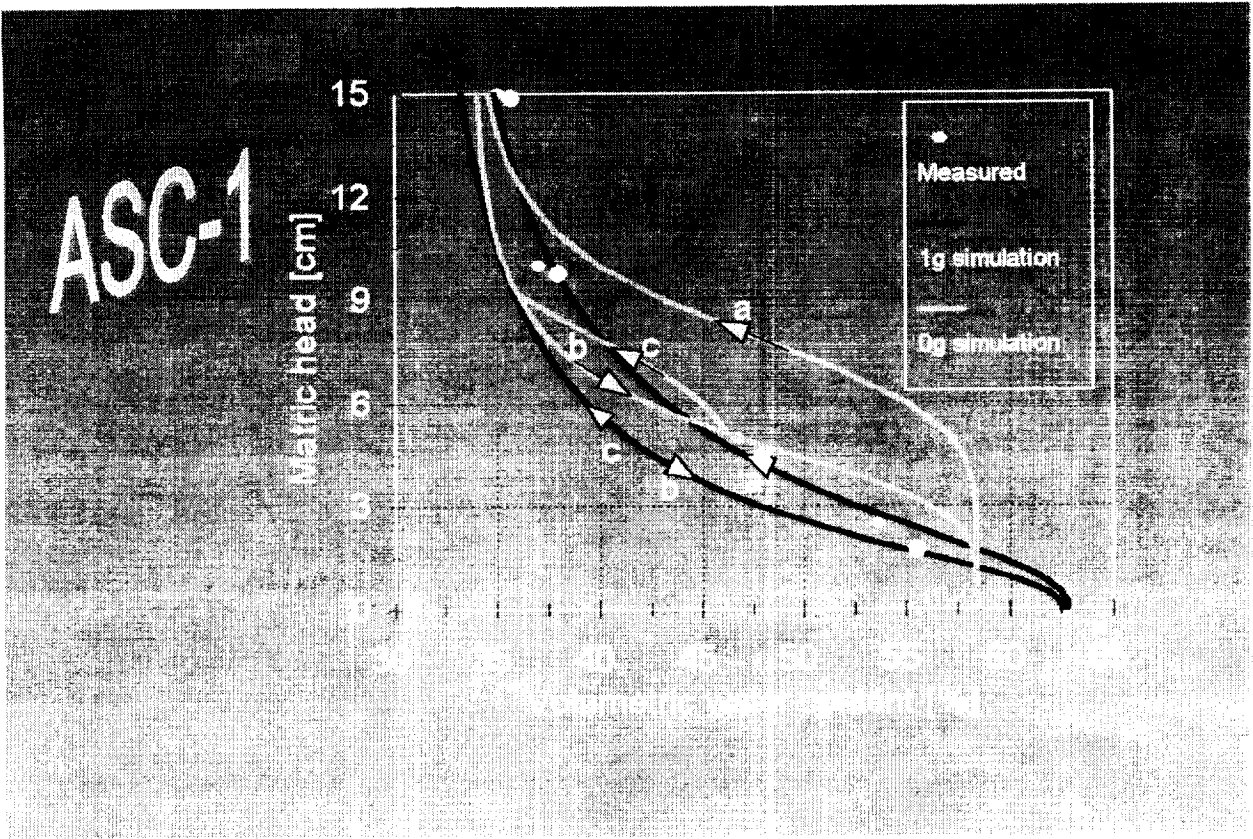

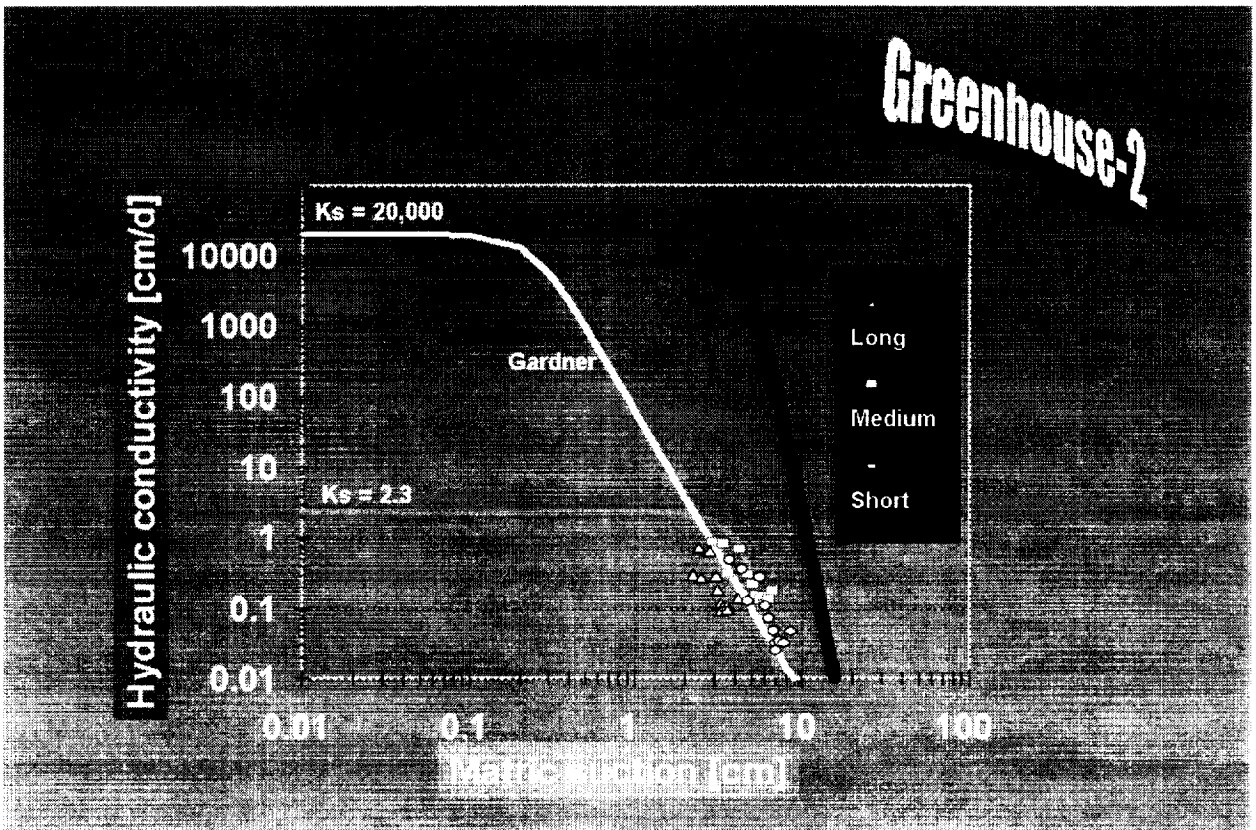
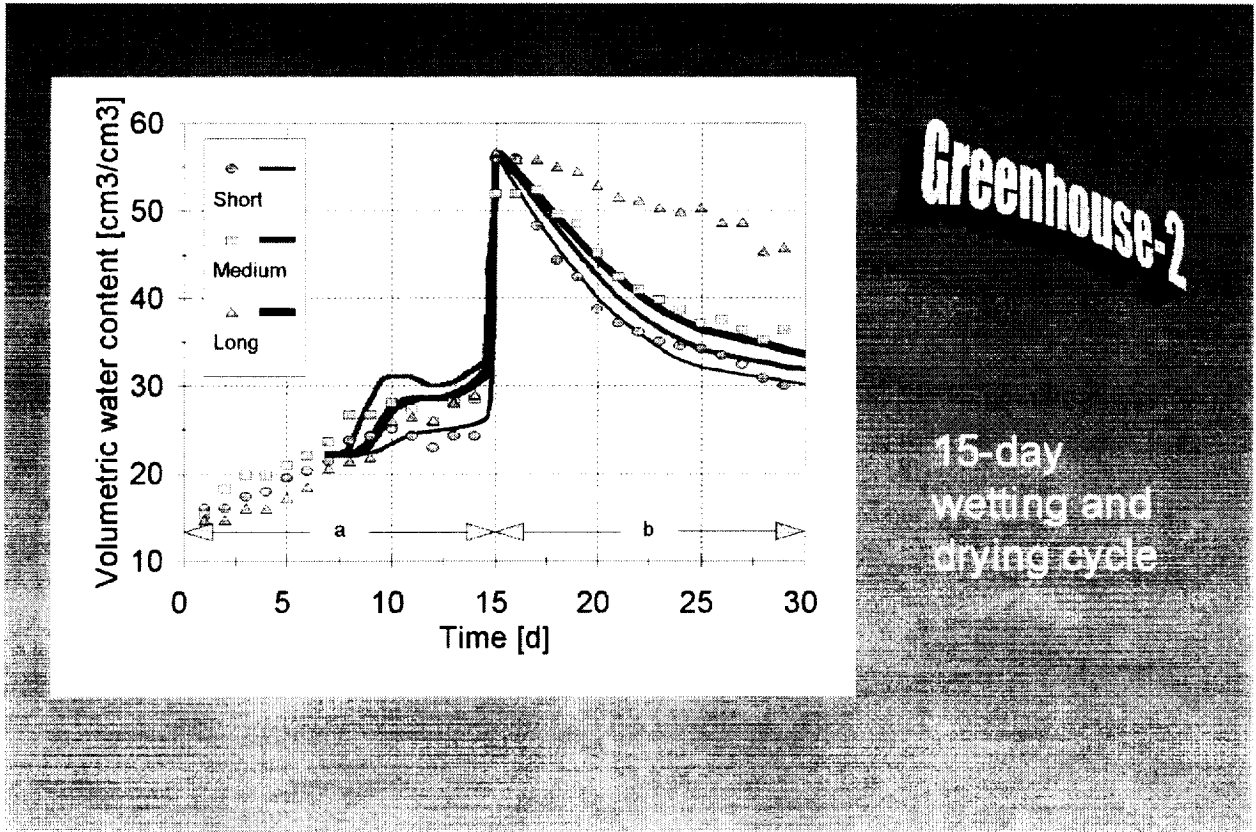

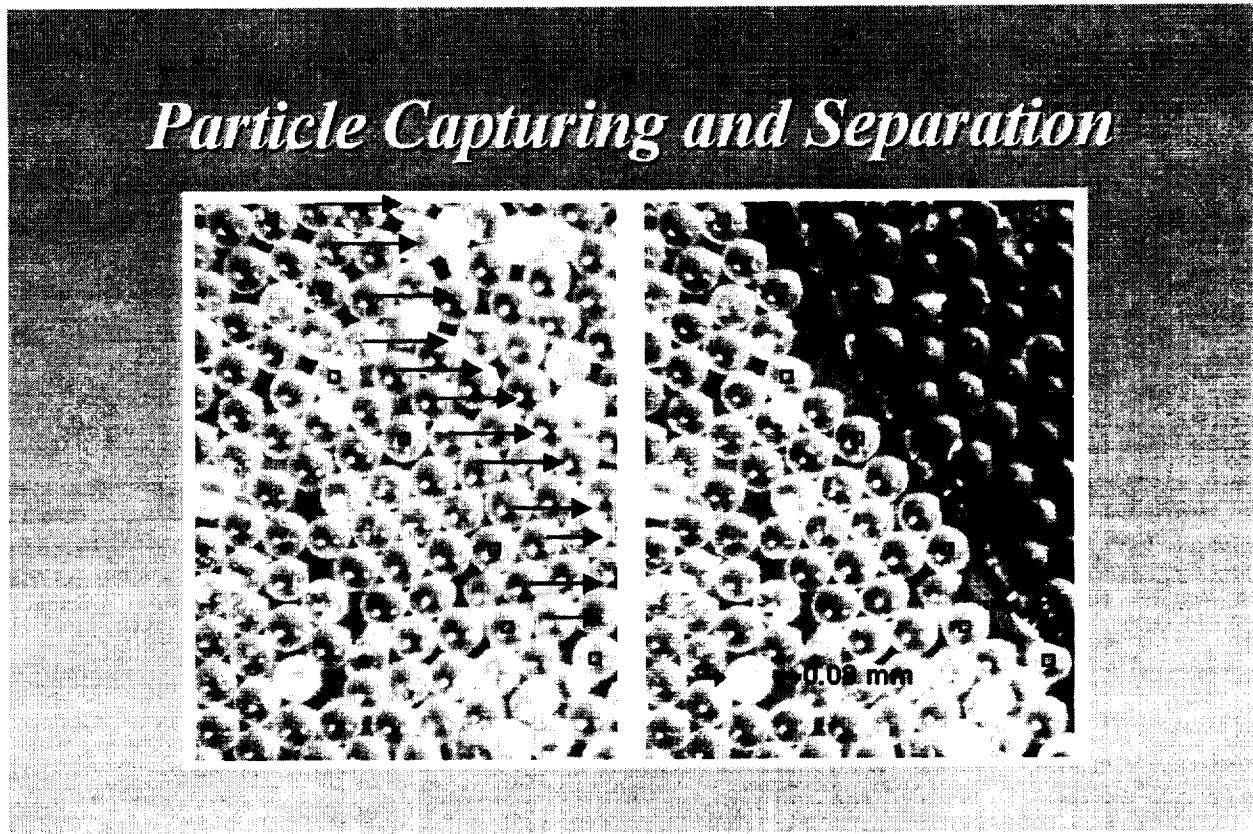
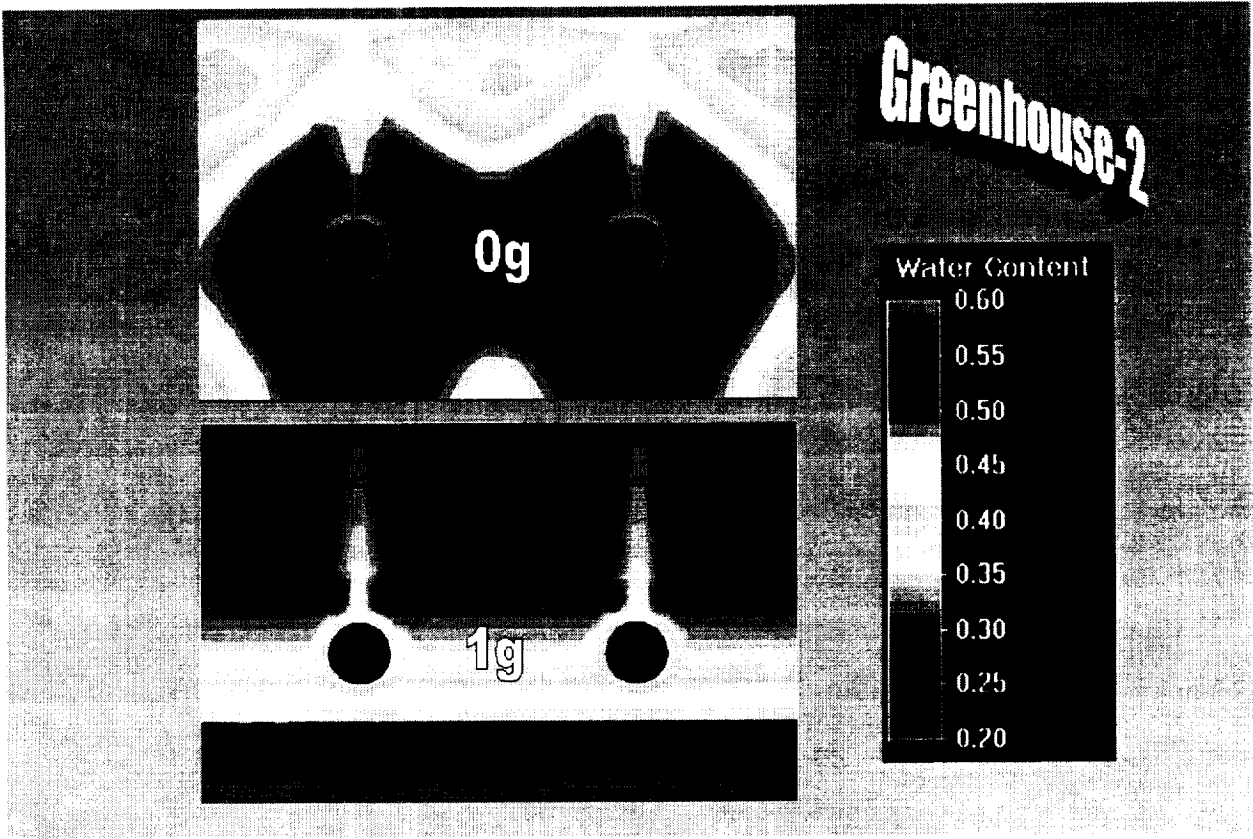

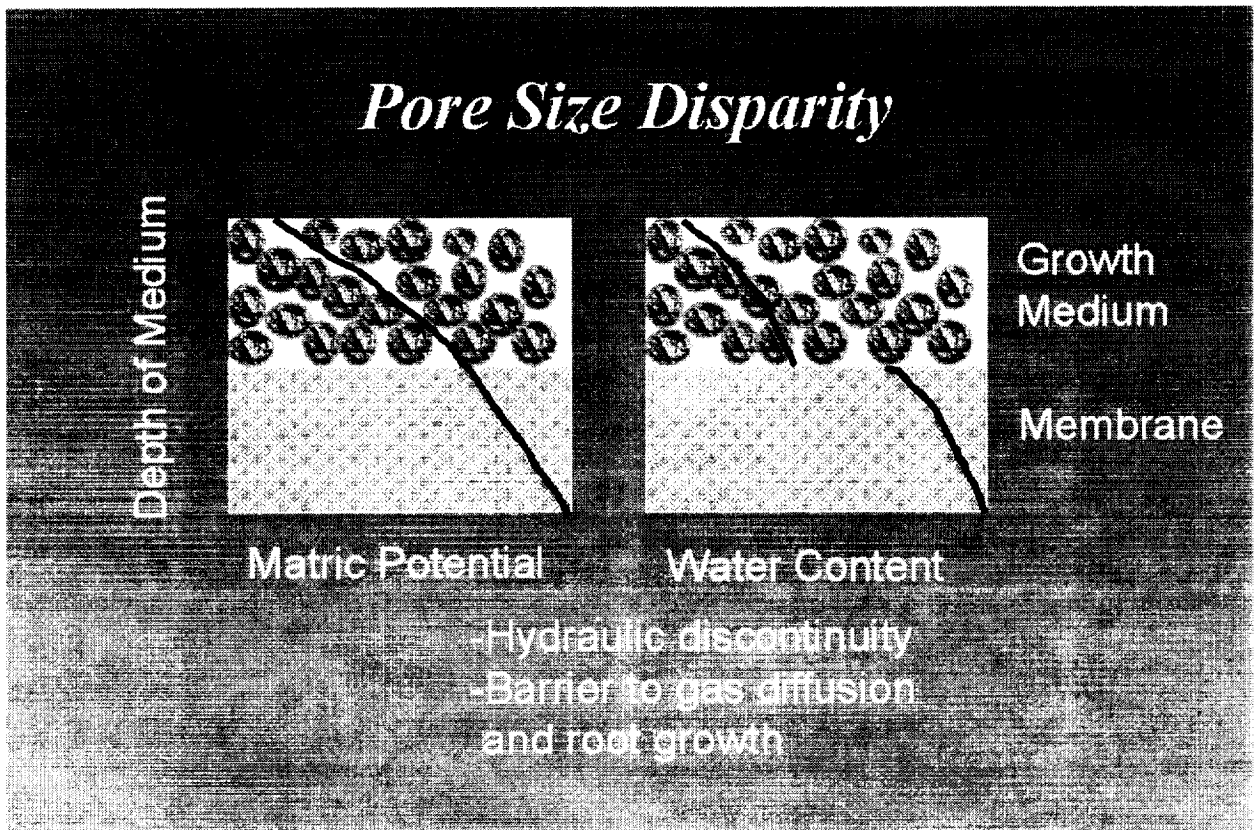
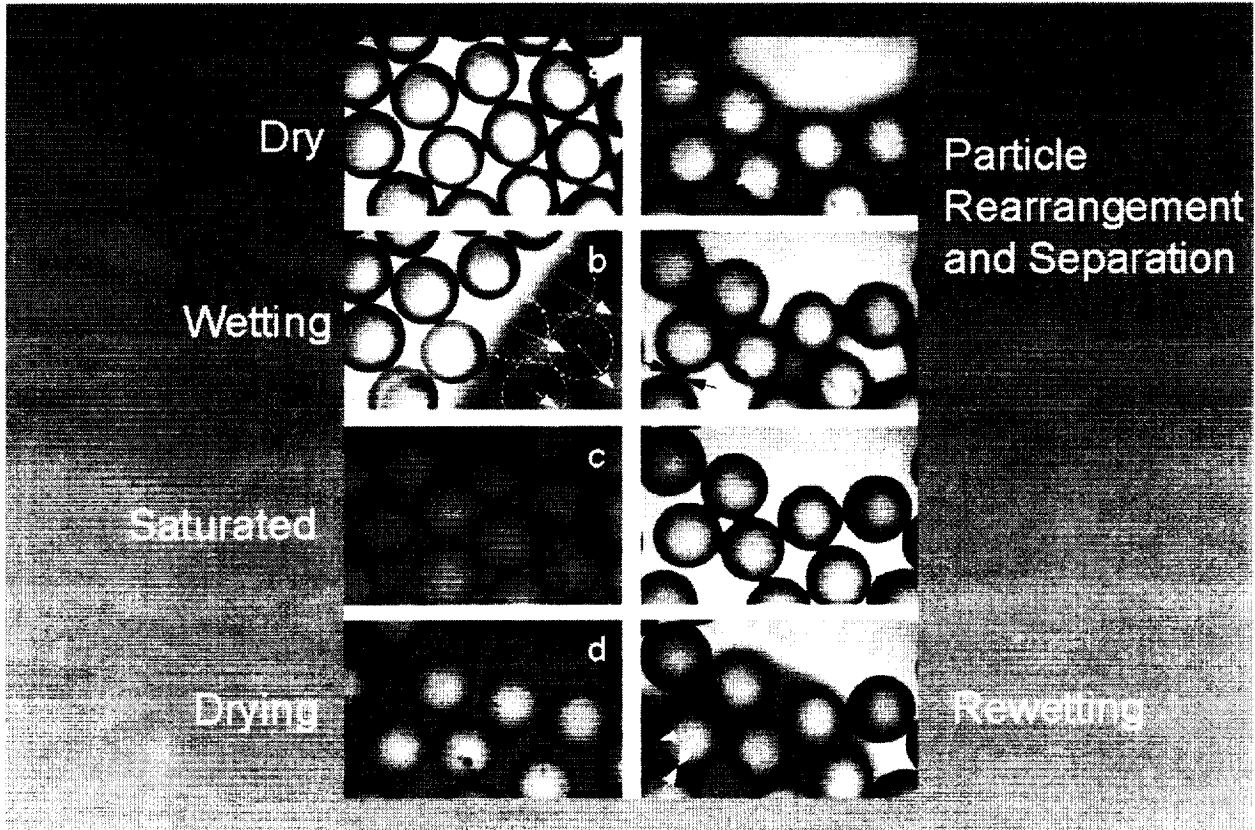

APPENDIX 5: RANGE FOR OPTIMIZED WATER AND GAS FLUXES

Courtesy of Scott Jones, Utah State University

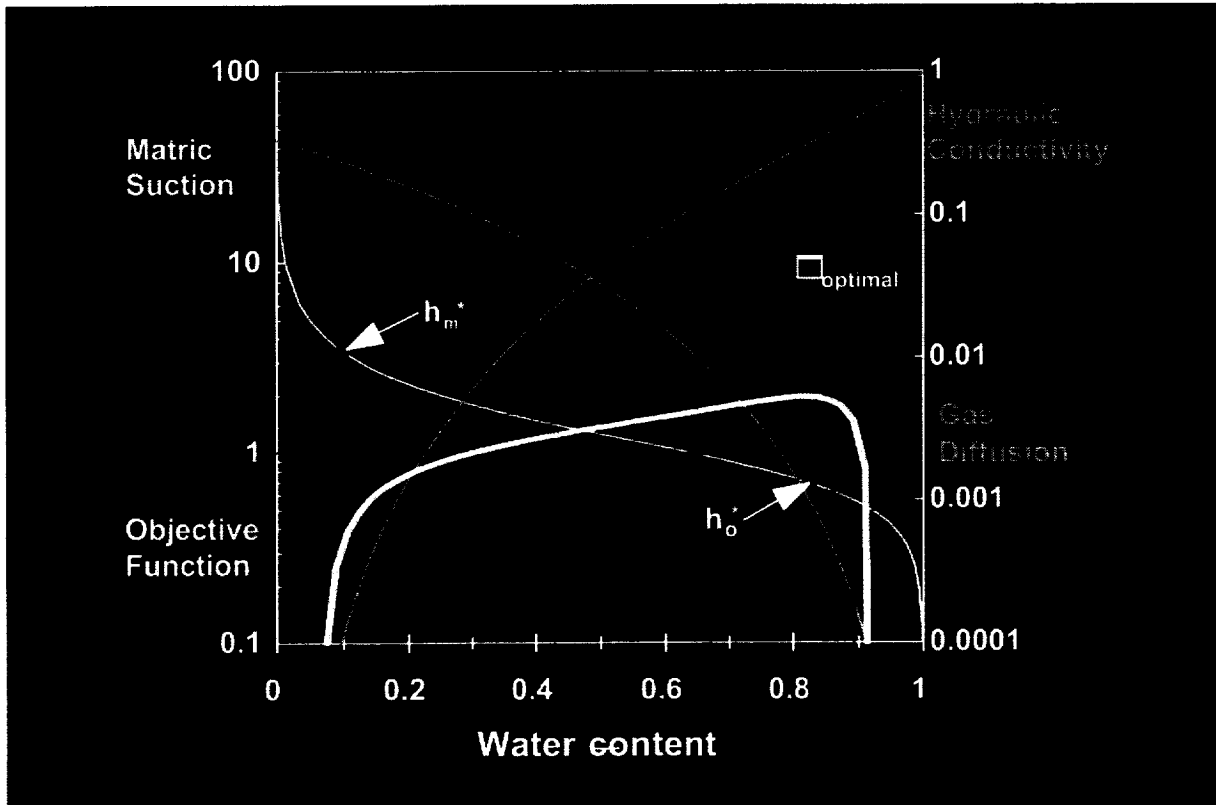

APPENDIX 6: SOIL HYDRAULIC CHARACTERISTICS

Courtesy of Marcel Schapp, U.S. Salinity Laboratory

Soil Hydraulic Characteristics

[Mualem, 1976; van Genuchten, 1980]

- **Retention Curve**

$$S_e = \frac{\theta - \theta_r}{\theta_s - \theta_r} = \frac{1}{(1 + |\alpha h|^n)^m}$$

- **Hydraulic Conductivity**

$$K(h) = K_s S_e^L \left[1 - (1 - S_e^{1/m})^m \right]^2$$

h - suction [L]

θ_s - saturated water content [-]

θ_r - residual water content [-]

α, m, n, L - empirical parameters [L⁻¹], [-], [-], [-]

S_e - effective water content [-]

K_s - saturated hydraulic conductivity [L.T⁻¹]

Analysis Structure and Flowchart

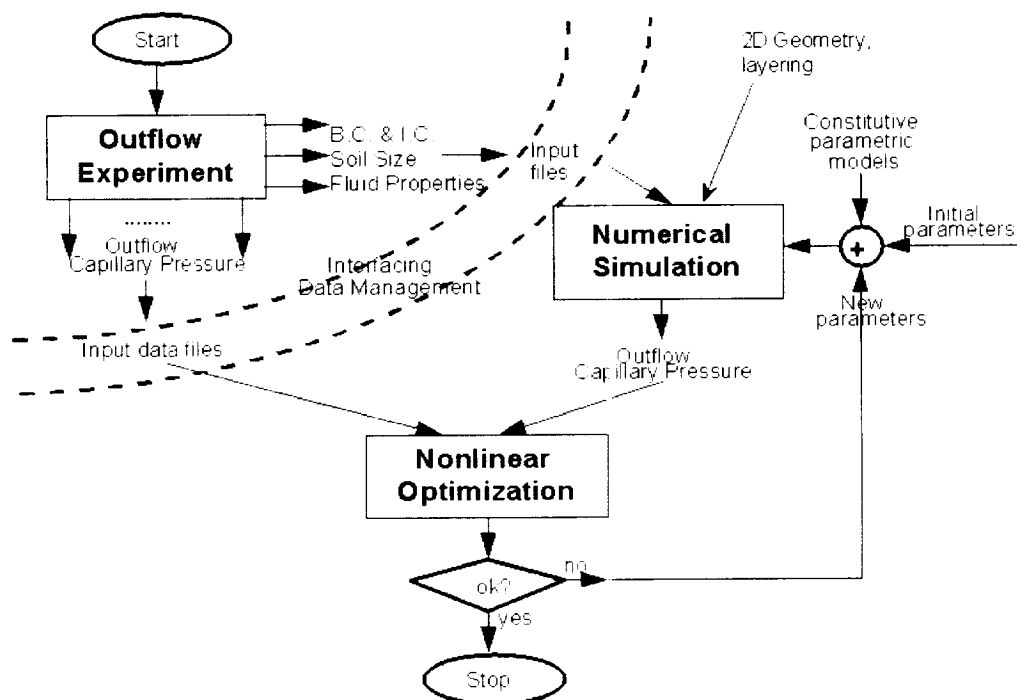

One- and Multistep Outflow Experiments

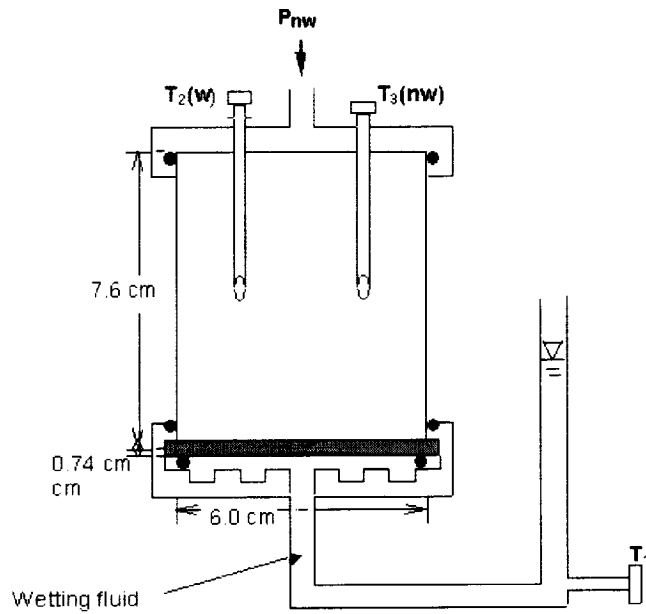

Multistep Outflow Experiment

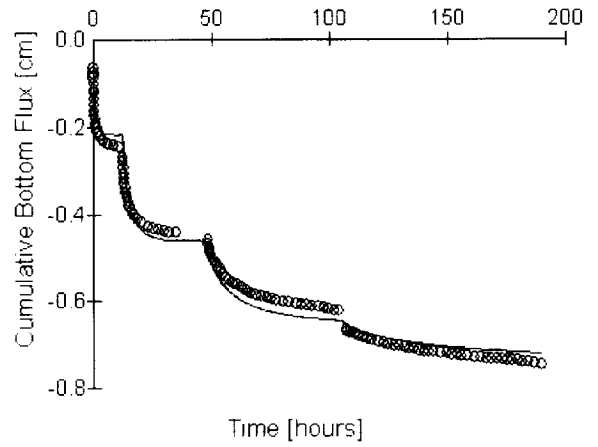
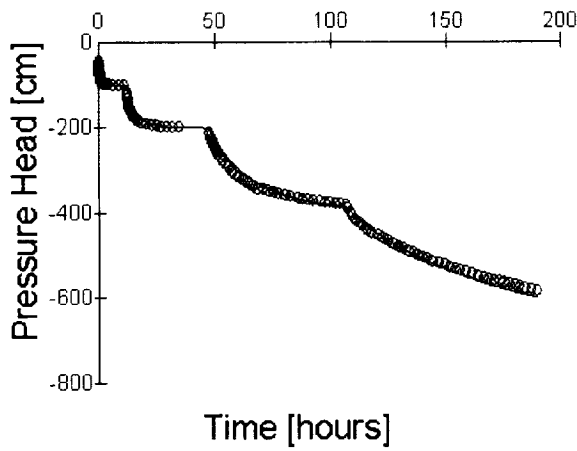

○ Data
 — Simulation

APPENDIX 7: HYDRAULIC FUNCTIONS FOR UNSATURATED POROUS MEDIA BASED ON PORE SCALE PROCESSES

Courtesy of Dani Or, Utah State University

Hydraulic Functions for Unsaturated Porous Media Based on Pore-Scale Processes

Dani Or and Markus Tuller

Dept. of Plants, Soils and Biometeorology, Utah State University



Presentation Outline

- **Introduction**
- **Capillary condensation and adsorption**
- **Pore geometrical aspects**
- **Applications for pore-scale liquid configurations**
- **Upscaling from pore- to sample-scale**
- **Illustrative examples of model applications**
- **Hydrodynamic considerations**
- **Hydraulic conductivity of unsaturated porous media**
- **Extension to dual-continuum (FPM, macropores)**
- **Preliminary experimental work**
- **Summary and conclusions**

Introduction

- **Conventional models for flow and transport in partially saturated porous media represent pore space as a bundle of cylindrical capillaries disregarding adsorption and retention in angular spaces.**
- **Practical interpretation of soil pore space structure from liquid retention measurements rely solely on capillarity, ignoring the role of surface area and adsorbed liquid films.**
- **Theoretical and experimental evidence clearly show a different picture for liquid configuration under unsaturated conditions whereby hydraulic connectivity is maintained through liquid-filled corners and pendular spaces that are further connected through thin liquid films coating solid surfaces.**

Cylindrical or Angular Pore Cross-Section?

Sandstone



Clay

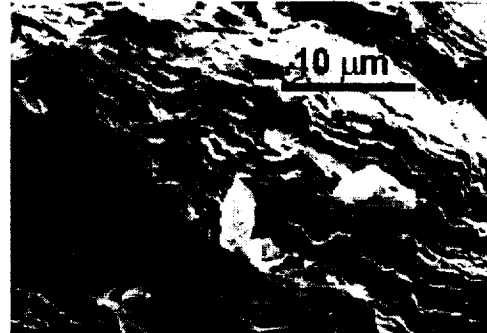

- Soil pore spaces are formed by aggregation of primary particles and mineral surfaces, their representation as angular pore cross-sections is a more realistic model than cylindrical.
- Angular pores allow dual-occupancy of wetting and non-wetting phases.

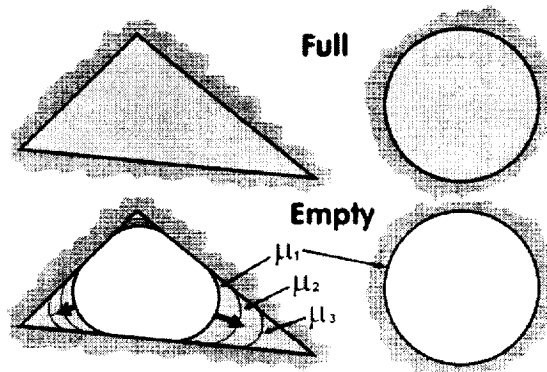

New Model for Pore Space Geometry

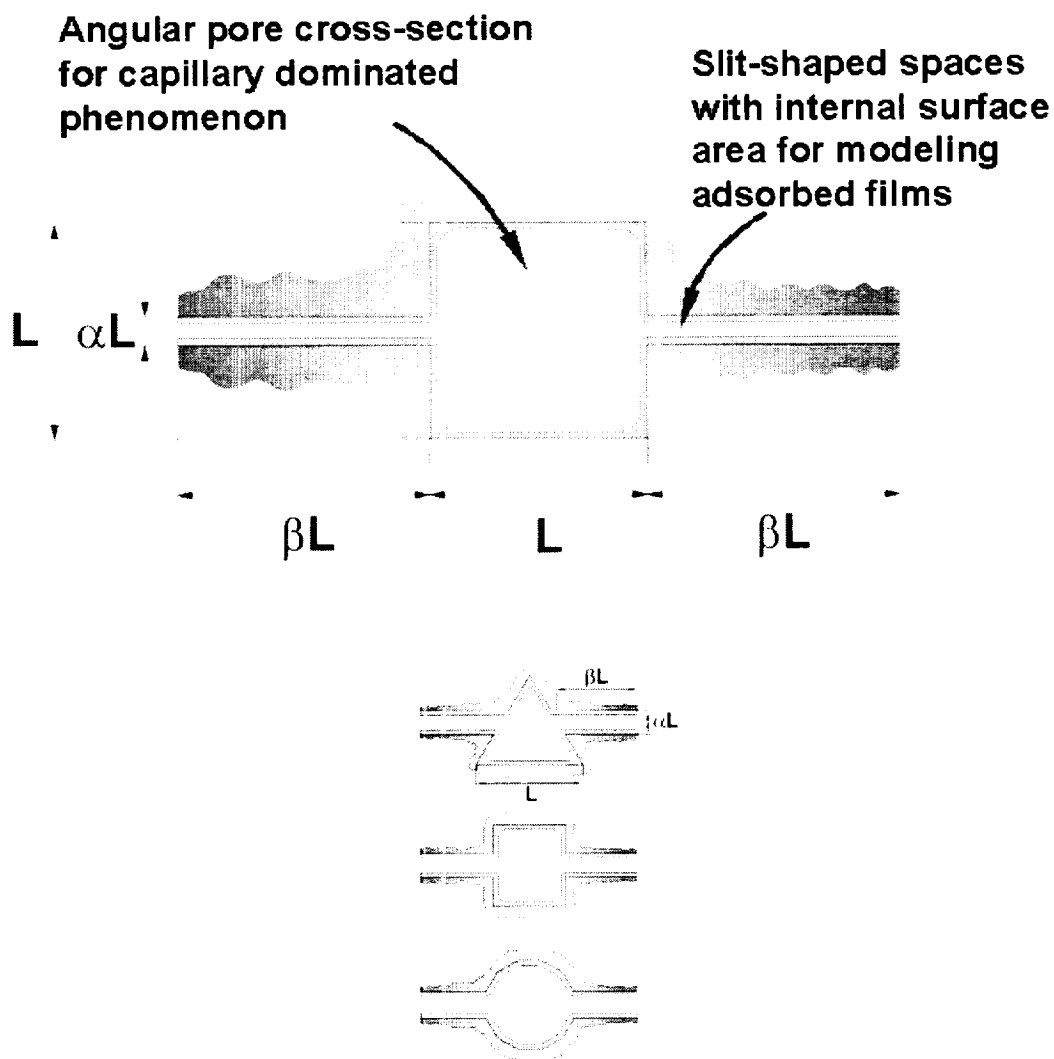

Snap-Off Mechanisms in the Unit Cell

- Assuming continuity of all phases, we consider pore and slit snap-off mechanisms (spontaneous redistribution of liquid) within the unit cell.
- Piston-like pore snap-off mechanisms are not considered under the slow laminar flow regimes.

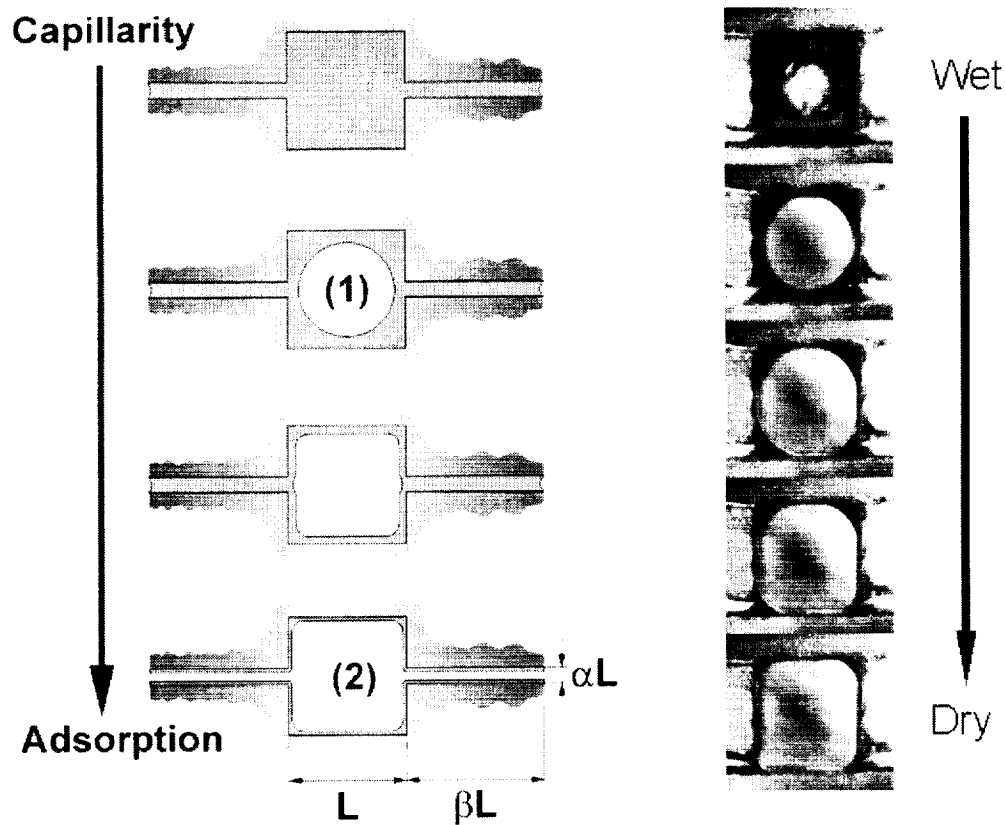

Pore Cross-Sectional Saturation vs. Chemical Potential

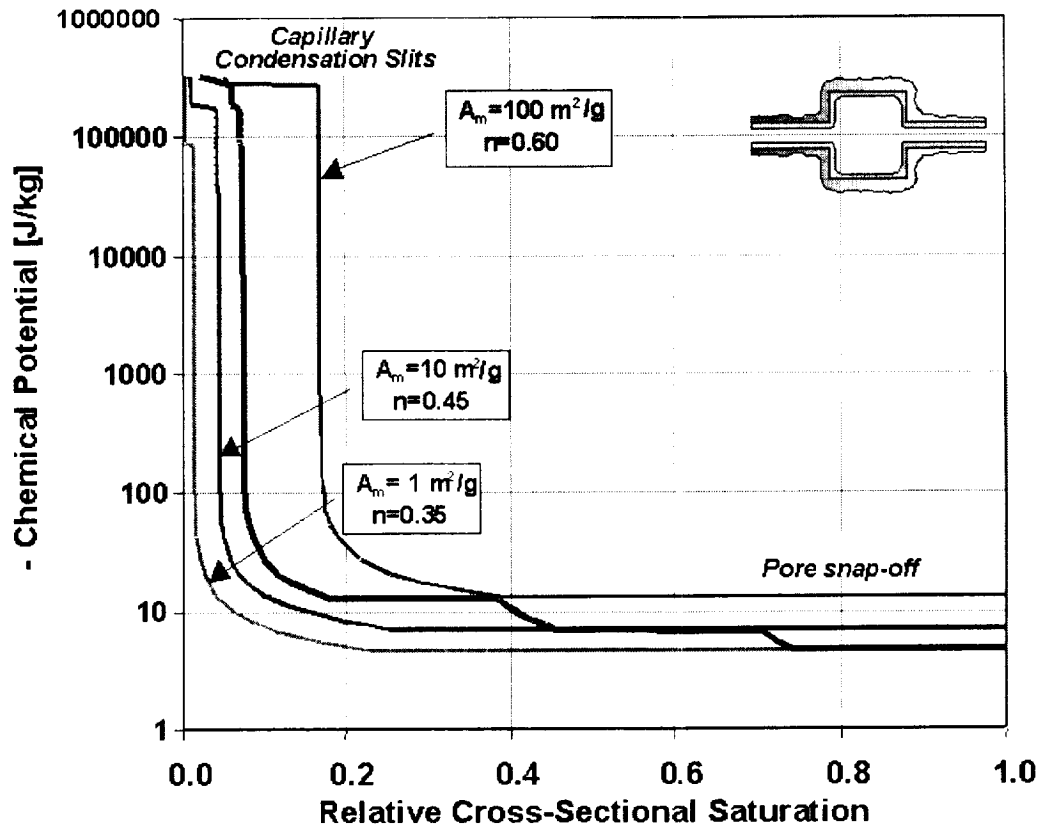

Upscaling From Pore- to Sample-Scale

- A statistical approach using gamma distributed cell lengths is employed to represent a sample of a porous medium.
- Upscaled equations for liquid retention were fitted to measured SWC data subject to porosity and SA area constraints.

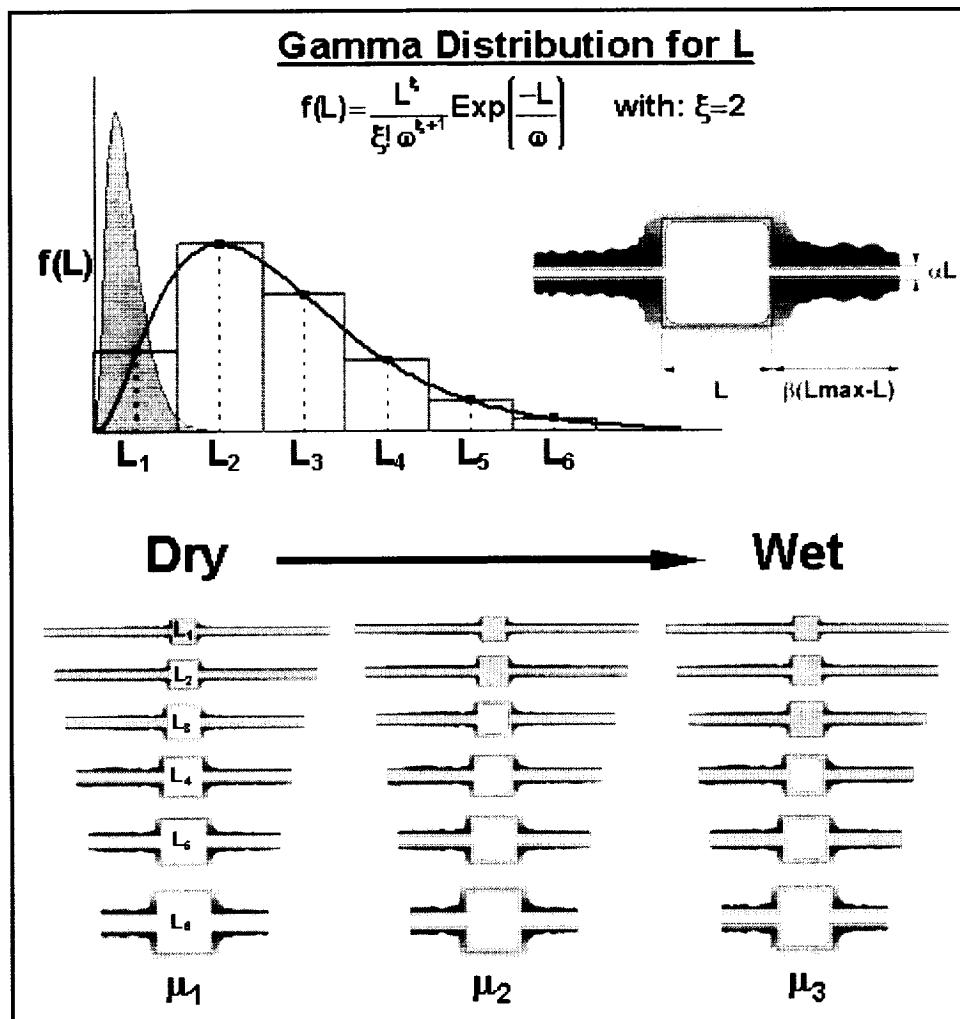

Limits of Integration for the Upscaling Scheme

Filling Stage

Boundary Cell Size

L_{min}

Full Cells

$$L_1 = \frac{\sigma}{\rho\mu} C_n$$

**Full Slits-
Partially-Filled
Pores**

$$L_2 = \frac{3^3 \sqrt{\frac{A_{svl}}{6\pi\rho\mu}}}{\alpha}$$

**Partially-Filled
Slits & Pores**

L_{max}

Measured and Upscaled Water Retention Curve

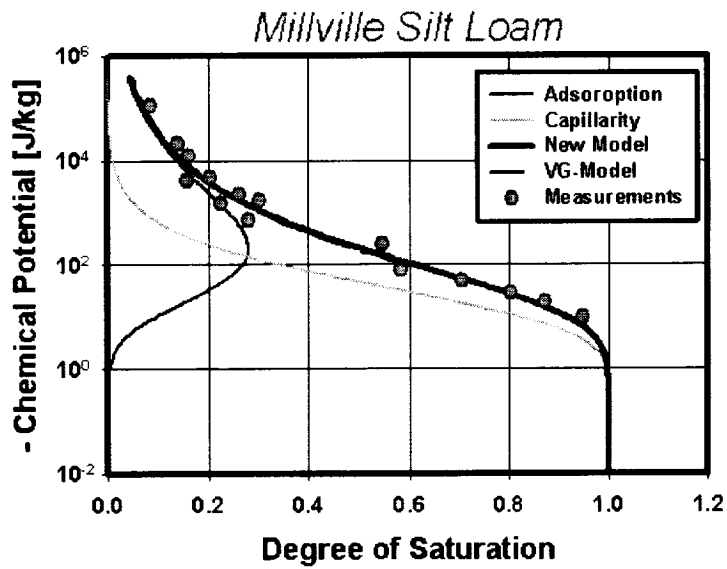
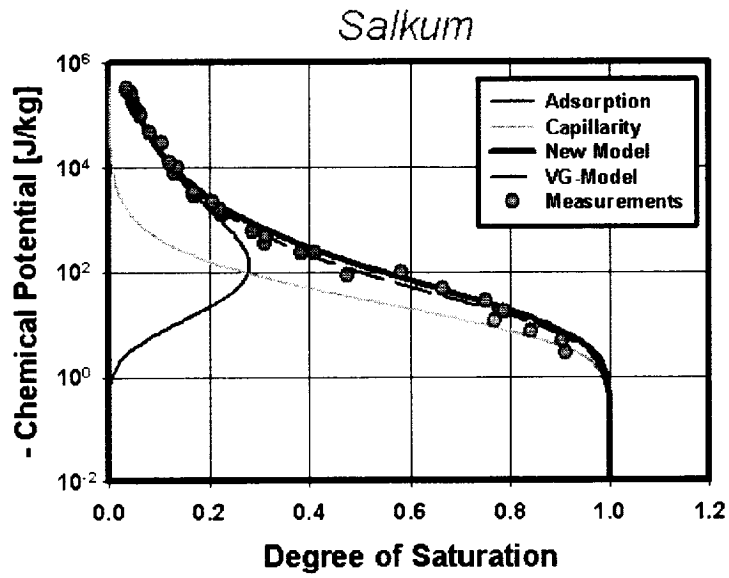

Measured and Predicted Liquid-Vapor Interfacial Area

Sand

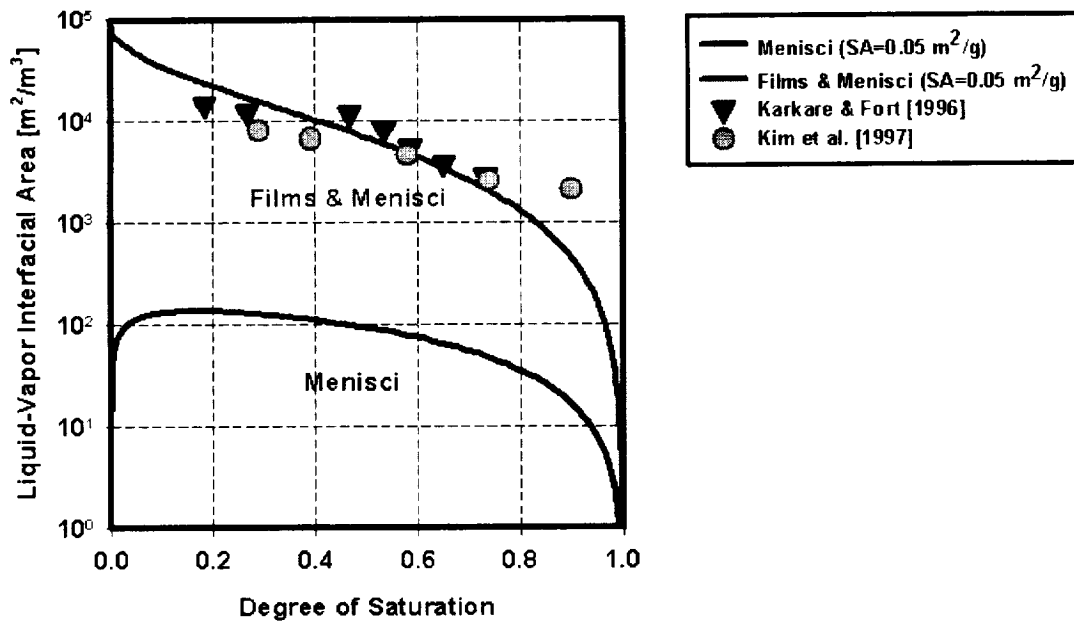

Hydrodynamic Considerations

- **Equilibrium liquid-vapor interfacial configurations at various potentials serve as fixed boundaries for the definition of flow regimes (laminar) in angular pore space (film and corner flows).**
- **The simple cell geometry and well-defined boundary conditions permit solution of the Navier-Stokes equations for average liquid velocity for each flow regime (i.e., geometrical feature).**
- **Analogy with Darcy's law is invoked to identify the coefficient of proportionality between flux and hydraulic gradient as the hydraulic conductivity for each flow regime under consideration.**

Primary Flow Regimes in a Unit Cell

- (1) Flow in ducts and between parallel plates for completely liquid-filled pores and slits.
- (2) Flow in thin liquid films lining flat surfaces following pore and slit snap-off.
- (3) Flow in corners (bounded by l-v interface) of the central pore.

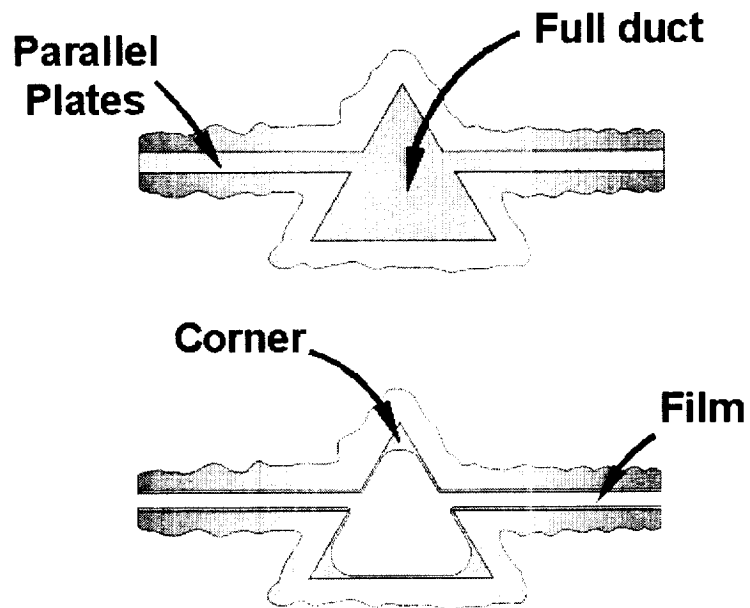

Primary Flow Regimes in a Unit Cell

Corner Flow

$$\bar{v} = \frac{r^2(\mu)}{\varepsilon\eta} \left(-\frac{dP}{dz} \right)$$

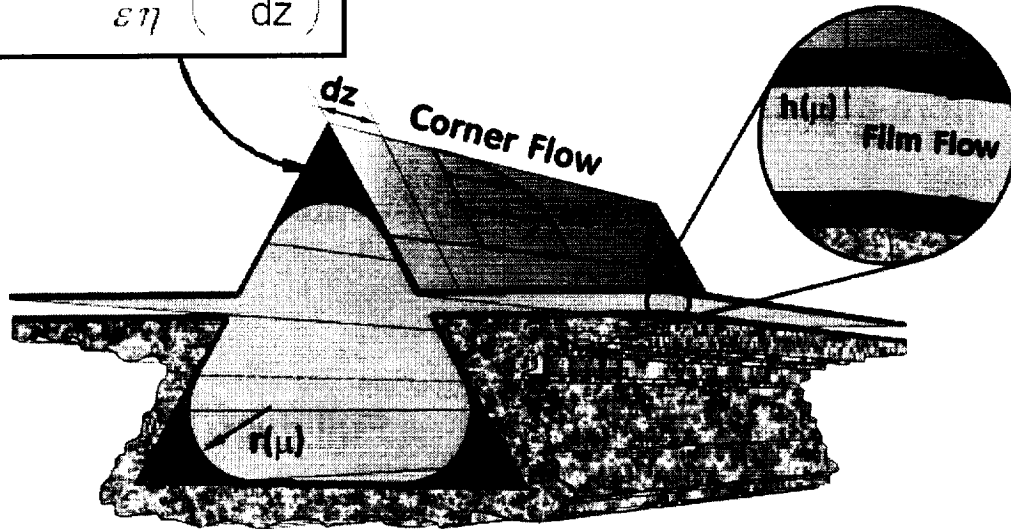

Film Flow $h(\mu) > 10nm$

$$\bar{v} = \frac{h^2(\mu)}{3\eta} \left(-\frac{dP}{dz} \right)$$

ε Dimensionless flow resistance
 η Viscosity of bulk liquid
 $A(\mu)$ Function for modified viscosity
 P Hydraulic pressure

Film Flow $h(\mu) \leq 10nm$

$$\bar{v} = \frac{A(\mu)}{12\eta h(\mu)} \left(-\frac{dP}{dz} \right)$$

Single Unit Cell Expressions Fitted to Measured Data [Hygiene Sandstone]

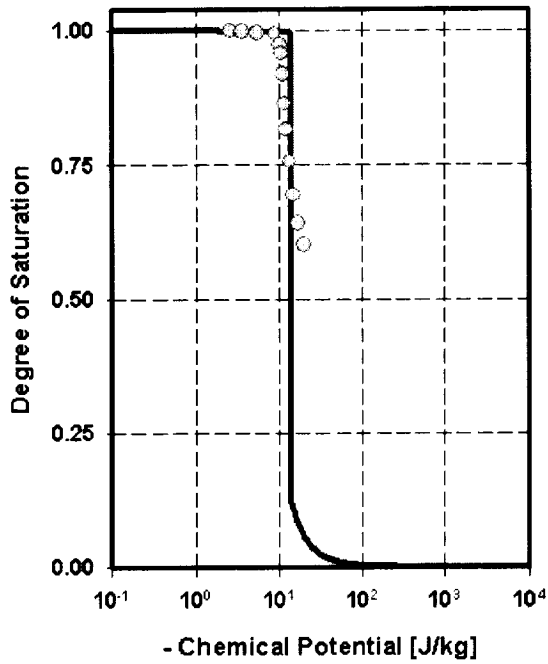

Liquid Saturation

Relative Hydraulic Conductivity

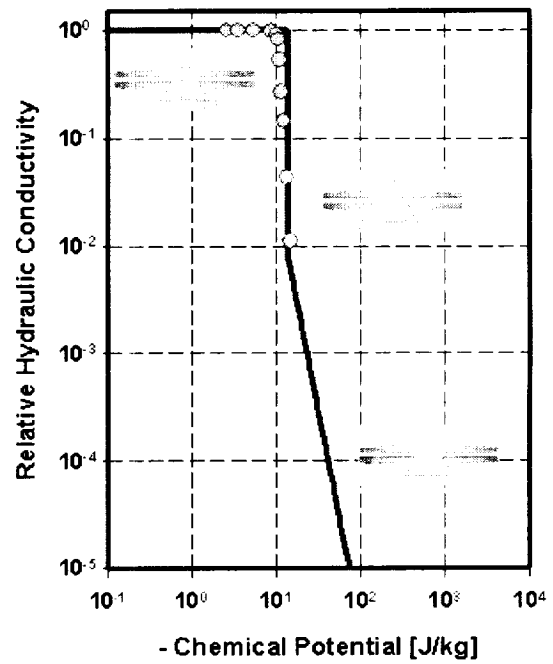

Upscaling Results for a Clay Loam Soil

[Source: Pachepsky et al., 1984]

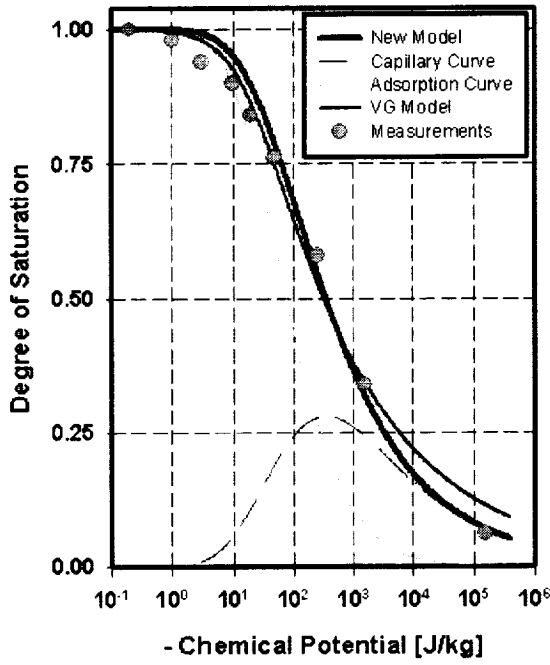

Liquid Saturation

Relative Hydraulic Conductivity

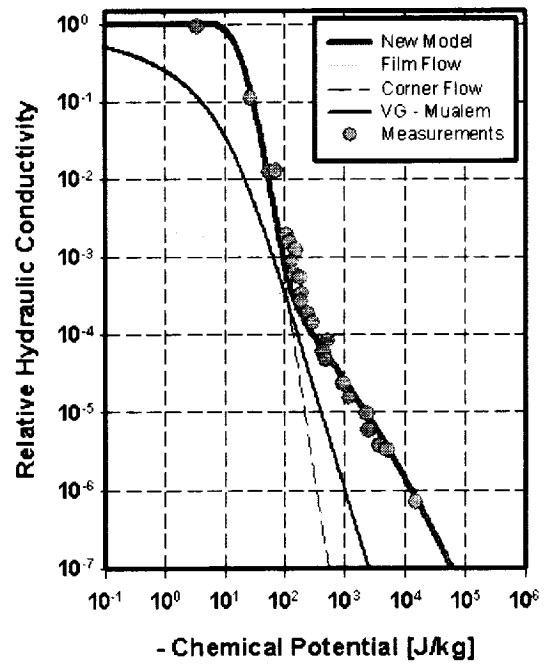

A Conceptual Model for Fractured Porous Media

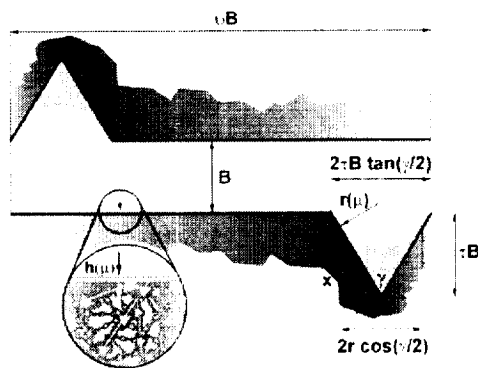
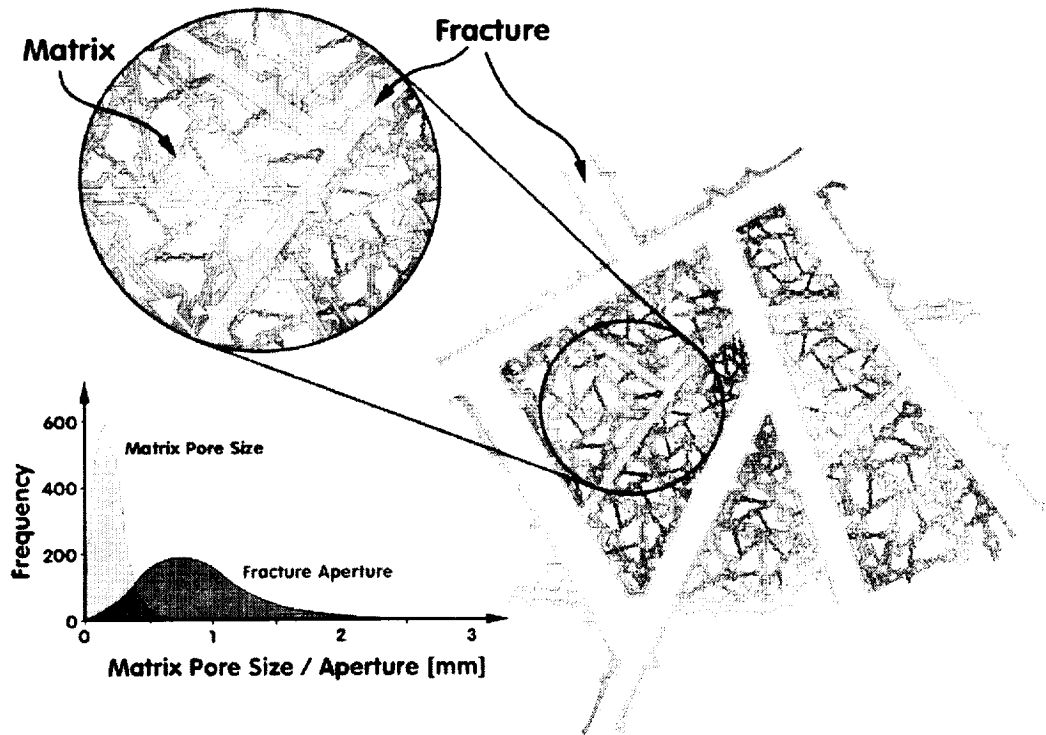

Unit Fracture Element

A Conceptual Model for Macroporous Media

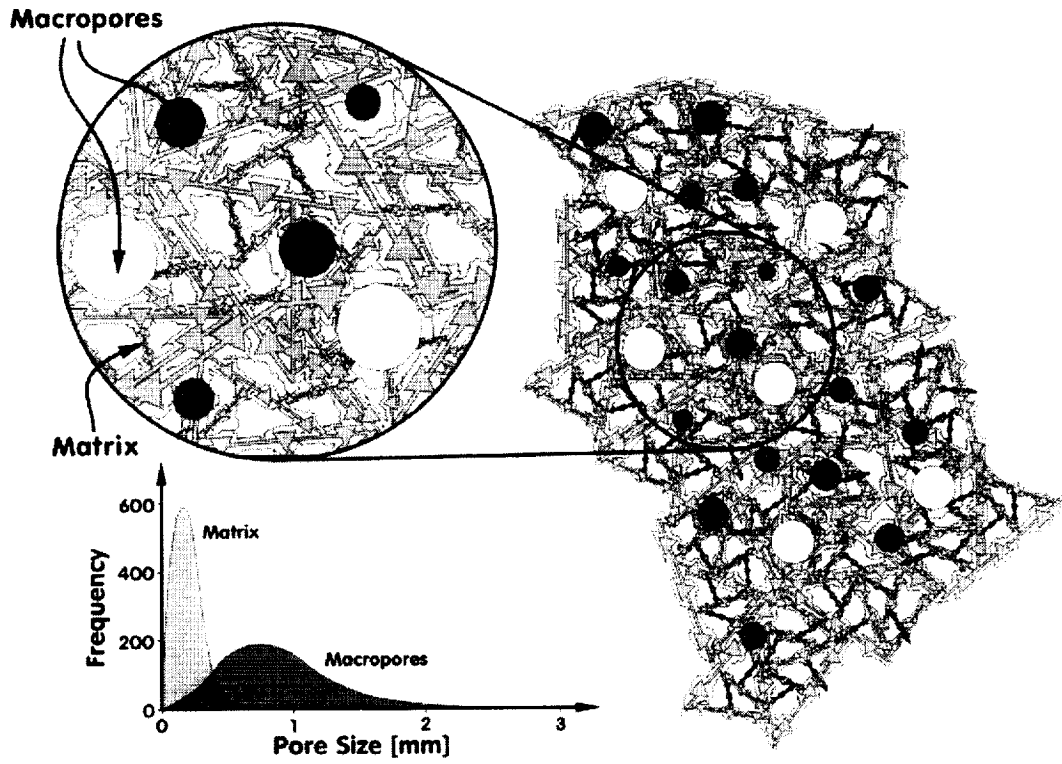

Aggregated Loam Soil

[Source: Smettem and Kirby, 1990]

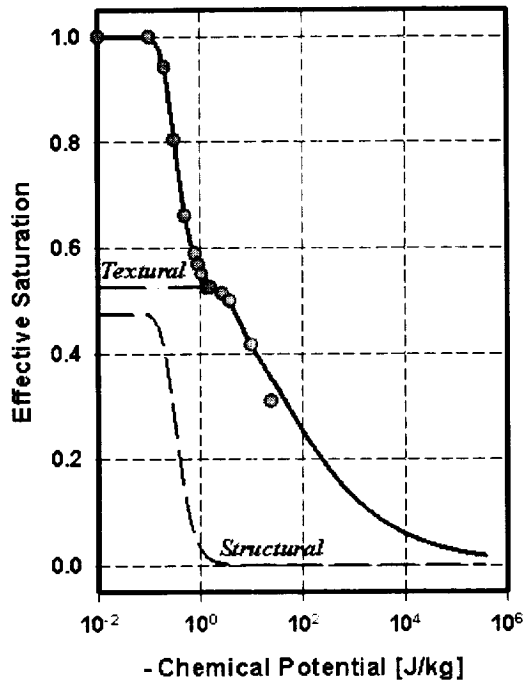

Fitted Liquid Saturation

Predicted Relative Hydraulic Conductivity

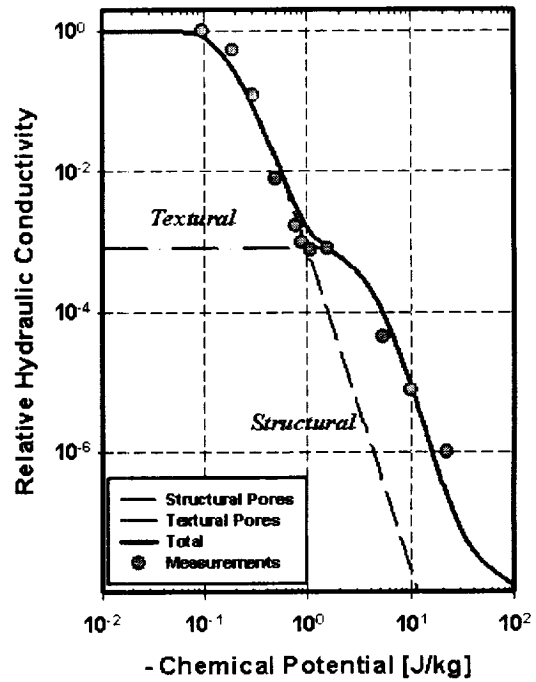

Microscopic Observation of Capillary Condensation in Glass Micromodels

- A high-resolution video microscope (1000x) with black & white CCD camera was used to detect liquid configurations using IR light (880 nm) emitted from an LED light source (capitalizing on water adsorption properties at this wavelength).
- A narrow bandpass interference filter with a central wavelength of 880 nm was installed on the CCD camera to increase image contrast for water.
- The observations were performed in a temperature- and vapor pressure-controlled chamber.

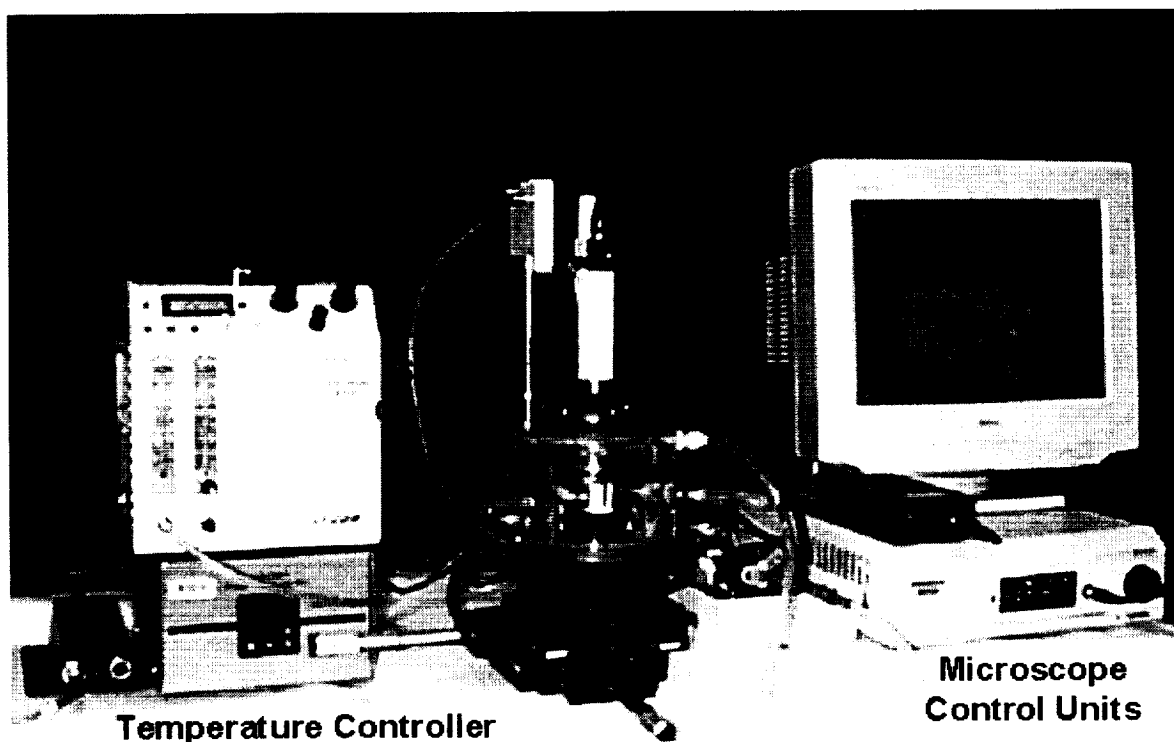

Observation of Capillary Menisci and Liquid Redistribution in a Micro Glass Cell

- Observations of capillary menisci at various chemical potentials and drainage snap-off mechanism were compared with calculations using the Young-Laplace equation for radius (r) of interface curvature and expressions derived by Tuller et al. (1999) and Mason and Morrow (1991) for radius (r_d) at drainage snap-off.

$$r = \frac{\sigma}{\rho\mu}$$

$$r_d = \frac{P}{2(F_n + \pi + \sqrt{\pi(F_n + \pi)})}$$

σ Liquid-vapor surface tension [N/m]
 ρ Liquid density [kg/m³]
 μ Chemical potential [J/kg]
 P Pore perimeter [m]
 F_n Pore angularity factor by Tuller et al. (1999)

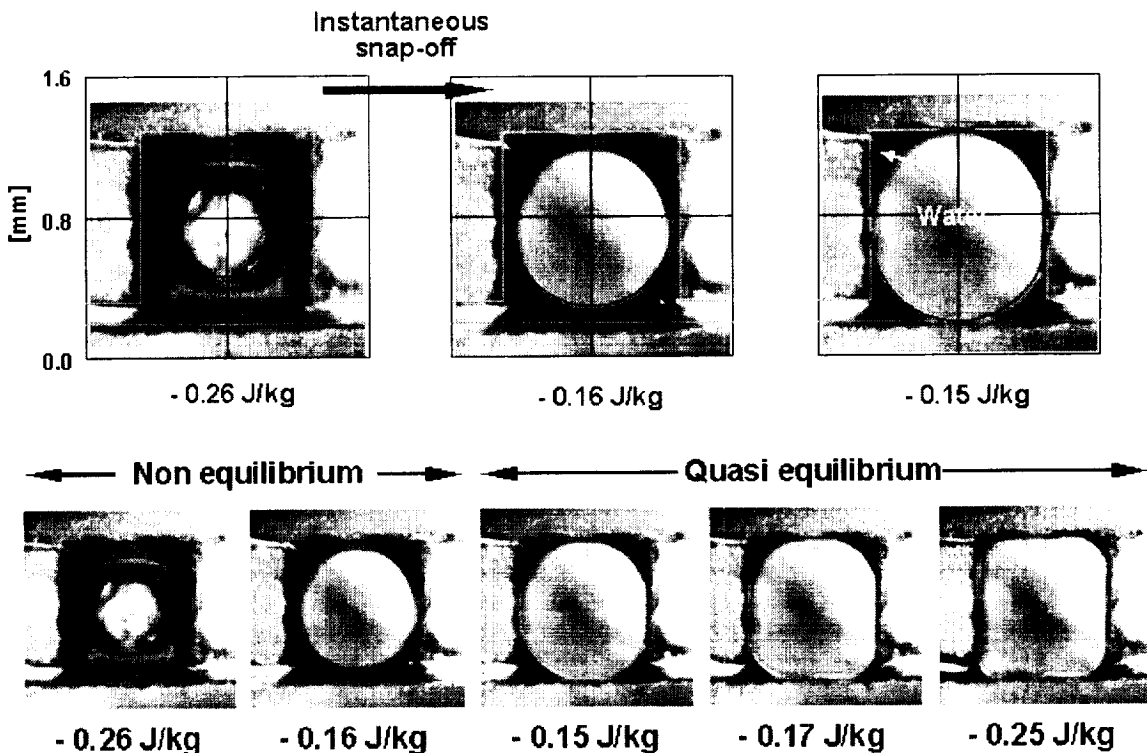

REPORT DOCUMENTATION PAGE

Form Approved
OMB No. 0704-0188

Public reporting burden for this collection of information is estimated to average 1 hour per response, including the time for reviewing instructions, searching existing data sources, gathering and maintaining the data needed, and completing and reviewing the collection of information. Send comments regarding this burden estimate or any other aspect of this collection of information, including suggestions for reducing this burden, to Washington Headquarters Services, Directorate for Information Operations and Reports, 1215 Jefferson Davis Highway, Suite 1204, Arlington, VA 22202-4302, and to the Office of Management and Budget, Paperwork Reduction Project (0704-0188), Washington, DC 20503.

| | | |
|----------------------------------|---------------------------------|---|
| 1. AGENCY USE ONLY (Leave Blank) | 2. REPORT DATE February 2002 | 3. REPORT TYPE AND DATES COVERED NASA Technical Memorandum |
|----------------------------------|---------------------------------|---|

| | |
|--|--------------------|
| 4. TITLE AND SUBTITLE Plant Production Systems for Microgravity: Critical Issues in Water, Air, and Solute Transport Through Unsaturated Porous Media | 5. FUNDING NUMBERS |
|--|--------------------|

| | |
|---|--|
| 6. AUTHOR(S) Susan Steinberg* Doug Ming, Don Henninger | |
|---|--|

| | |
|--|--|
| 7. PERFORMING ORGANIZATION NAME(S) AND ADDRESS(ES) Lyndon B. Johnson Space Center Houston, Texas 77058 | 8. PERFORMING ORGANIZATION REPORT NUMBERS S-884 |
|--|--|

| | |
|---|--|
| 9. SPONSORING/MONITORING AGENCY NAME(S) AND ADDRESS(ES) National Aeronautics and Space Administration Washington, DC 20546-0001 | 10. SPONSORING/MONITORING AGENCY REPORT NUMBER TM-2002-210774 |
|---|--|

| |
|---|
| 11. SUPPLEMENTARY NOTES *Libertaed Technical |
|---|

| | |
|--|------------------------|
| 12a. DISTRIBUTION/AVAILABILITY STATEMENT Available from the NASA Center for AeroSpace Information (CASI) 7121 Standard Hanover, MD 21076-1320 subject category: 54 | 12b. DISTRIBUTION CODE |
|--|------------------------|

| |
|--|
| 13. ABSTRACT (Maximum 200 words) This NASA Technical Memorandum is a compilation of presentations and discussions in the form of minutes from a workshop entitled Plant Production Systems for Microgravity: Critical Issues in Water, Air, and Solute Transport Through Unsaturated Porous Media held at NASA's Johnson Space Center, July 24-25, 2000. This workshop arose from the growing belief within NASA's Advanced Life Support Program that further advances and improvements in plant production systems for microgravity would benefit from additional knowledge of fundamental processes occurring in the root zone. The objective of the workshop was to bring together individuals who had expertise in various areas of fluid physics, soil physics, plant physiology, hardware development, and flight tests to identify, discuss, and prioritize critical issues of water and air flow through porous media in microgravity. Participants of the workshop included representatives from private companies involved in flight hardware development and scientists from universities and NASA Centers with expertise in plant flight tests, plant physiology, fluid physics, and soil physics. |
|--|

| | | |
|--|---------------------------|----------------|
| 14. SUBJECT TERMS plants (botany); plant roots; plant stress; microgravity; porous materials; porosity; microporosity | 15. NUMBER OF PAGES 77 | 16. PRICE CODE |
|--|---------------------------|----------------|

| | | | |
|---|--|---|---|
| 17. SECURITY CLASSIFICATION OF REPORT Unclassified | 18. SECURITY CLASSIFICATION OF THIS PAGE Unclassified | 19. SECURITY CLASSIFICATION OF ABSTRACT Unclassified | 20. LIMITATION OF ABSTRACT Unlimited |
|---|--|---|---|
