

NASA/CR-2002-211767  
ICASE Report No. 2002-31

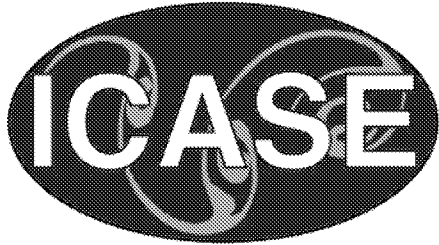

## **Modeling Reaction Control System Effects on Mars Odyssey**

*Jill L. Hanna  
ICASE, Hampton, Virginia*

*Zachary Q. Chavis  
The George Washington University, Hampton, Virginia*

*Richard G. Wilmoth  
NASA Langley Research Center, Hampton, Virginia*



---

July 2002

## The NASA STI Program Office . . . in Profile

Since its founding, NASA has been dedicated to the advancement of aeronautics and space science. The NASA Scientific and Technical Information (STI) Program Office plays a key part in helping NASA maintain this important role.

The NASA STI Program Office is operated by Langley Research Center, the lead center for NASA's scientific and technical information. The NASA STI Program Office provides access to the NASA STI Database, the largest collection of aeronautical and space science STI in the world. The Program Office is also NASA's institutional mechanism for disseminating the results of its research and development activities. These results are published by NASA in the NASA STI Report Series, which includes the following report types:

- TECHNICAL PUBLICATION. Reports of completed research or a major significant phase of research that present the results of NASA programs and include extensive data or theoretical analysis. Includes compilations of significant scientific and technical data and information deemed to be of continuing reference value. NASA's counterpart of peer-reviewed formal professional papers, but having less stringent limitations on manuscript length and extent of graphic presentations.
- TECHNICAL MEMORANDUM. Scientific and technical findings that are preliminary or of specialized interest, e.g., quick release reports, working papers, and bibliographies that contain minimal annotation. Does not contain extensive analysis.
- CONTRACTOR REPORT. Scientific and technical findings by NASA-sponsored contractors and grantees.
- CONFERENCE PUBLICATIONS. Collected papers from scientific and technical conferences, symposia, seminars, or other meetings sponsored or cosponsored by NASA.
- SPECIAL PUBLICATION. Scientific, technical, or historical information from NASA programs, projects, and missions, often concerned with subjects having substantial public interest.
- TECHNICAL TRANSLATION. English-language translations of foreign scientific and technical material pertinent to NASA's mission.

Specialized services that complement the STI Program Office's diverse offerings include creating custom thesauri, building customized data bases, organizing and publishing research results . . . even providing videos.

For more information about the NASA STI Program Office, see the following:

- Access the NASA STI Program Home Page at <http://www.sti.nasa.gov>
- Email your question via the Internet to [help@sti.nasa.gov](mailto:help@sti.nasa.gov)
- Fax your question to the NASA STI Help Desk at (301) 621-0134
- Telephone the NASA STI Help Desk at (301) 621-0390
- Write to:  
NASA STI Help Desk  
NASA Center for Aerospace Information  
7121 Standard Drive  
Hanover, MD 21076-1320

NASA/CR-2002-211767  
ICASE Report No. 2002-31

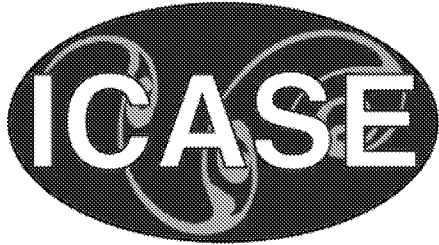

## **Modeling Reaction Control System Effects on Mars Odyssey**

*Jill L. Hanna  
ICASE, Hampton, Virginia*

*Zachary Q. Chavis  
The George Washington University, Hampton, Virginia*

*Richard G. Wilmoth  
NASA Langley Research Center, Hampton, Virginia*

*ICASE  
NASA Langley Research Center  
Hampton, Virginia*

*Operated by Universities Space Research Association*



Prepared for Langley Research Center  
under Contract NAS1-97046

July 2002

---

Available from the following:

NASA Center for AeroSpace Information (CASI)  
7121 Standard Drive  
Hanover, MD 21076-1320  
(301) 621-0390

National Technical Information Service (NTIS)  
5285 Port Royal Road  
Springfield, VA 22161-2171  
(703) 487-4650

# MODELING REACTION CONTROL SYSTEM EFFECTS ON MARS ODYSSEY

JILL L HANNA\*, ZACHARY Q. CHAVIS†, AND RICHARD G WILMOTH‡

**Abstract.** During the Mars 2001 Odyssey aerobraking mission, NASA Langley Research Center performed 6 degree of freedom (6-DOF) simulations to determine rotational motion of the spacecraft. The main objective of this study was to assess the reaction control system models and their effects on the atmospheric flight of Odyssey. Based on these models, a comparison was made between data derived from flight measurements to simulated rotational motion of the spacecraft during aerobraking at Mars. The differences between the simulation and flight derived Odyssey data were then used to adjust the aerodynamic parameters to achieve a better correlation.

**Key Words.** aerodynamics, Odyssey

**Subject classification.** Applied and Numerical Mathematics

## Nomenclature.

$\rho$	atmospheric density
$a_y$	acceleration in y body coordinate frame
$A$	reference area
ACS	Attitude Control System
$C_D$	drag coefficient
$C_m$	moment coefficient
DAC	DSMC Analysis Code
DOF	degree of freedom
DPTRAJ	Double Precision Trajectory program
DSMC	Direct Simulation Monte Carlo
IMU	Inertial Measurement Unit
$L$	reference length
$m$	spacecraft mass
$M_{CM}$	moment about the center of mass
MGS	Mars Global Surveyor
POST	Program to Optimize Simulated Trajectories
$q$	dynamic pressure
RCS	Reaction Control System
TCM	Trajectory Correction Maneuver

**1. Introduction.** Mars Odyssey successfully completed the aerobraking phase of its mission in January of 2002, achieving a nearly circular orbit, and after performing minor orbit corrections, project engineers began preparation for the science mapping mission. Successful aerobraking depends on numerous factors, not the least of which is maintaining a spacecraft attitude that provides optimum drag during the pass through the atmosphere. Although the Odyssey spacecraft was designed to be aerodynamically stable and was expected to maintain a specific average orientation with respect to the flight path, the small aerodynamic forces and moments exerted by the tenuous atmosphere were

---

\* ICASE, Mail Stop 132C, NASA Langley Research Center, Hampton, VA 23681. This research was supported by the National Aeronautics and Space Administration under NASA Contract No. NAS1-97046 while the author was in residence at ICASE, NASA Langley Research Center, Hampton, VA 23681-2199.

† Graduate Research Scholar Assistant, The George Washington University, Mail Stop 408A, NASA Langley Research Center, Hampton, VA 23665.

‡ Aerothermodynamics Branch, Mail Stop 408A, NASA Langley Research Center, Hampton, VA 23665.

insufficient to completely dampen any attitude oscillations induced by targeting alignment errors, atmospheric winds, residual inertial motions, etc [1]. Therefore, an attitude control system consisting of reaction wheels and reaction control system (RCS) thrusters along with appropriate control logic was used to maintain the spacecraft attitude within acceptable limits. Control during the drag pass was maintained by the RCS thrusters which were also used to desaturate the reaction wheels as necessary and to slew the spacecraft as required for solar power collecting and communications during the non-aerobraking portion of the orbit.

RCS thrusters firing in a vacuum or in the low-density Mars atmosphere encountered by Odyssey produce plumes which expand rapidly and may impinge on other parts of the spacecraft as well as interact with the flow around the spacecraft during aerobraking. These plumes may produce undesirable effects on the aerodynamic control effectiveness. Impingement effects were discovered during the termination phase of Magellan [2]. Analyses performed for Mars Global Surveyor (MGS) showed that certain thruster firings at the higher densities expected for MGS aerobraking could actually produce thrust reversing [3]. However, the Odyssey RCS thrusters were considerably smaller than those used on MGS, and such effects were expected to be small. Furthermore, the physical arrangement of the Odyssey RCS thrusters is such that the principle thrust directions are nearly perpendicular to the flight direction (see Figure 1), and any interactions with the flow around the spacecraft would be considerably different than for MGS. Therefore, pre-flight analyses were conducted using a simple engineering plume model coupled with flow simulations using the Direct Simulation Monte Carlo (DSMC) method to assess the magnitude of both impingement and plume-induced flow interaction effects on Odyssey aerodynamics [4,5]. The results from these simulations were used to augment the aerodynamic database already developed to extract atmospheric densities from accelerometer data and for other trajectory simulations used in various mission support tasks [1]. These aerodynamic databases both with and without RCS thruster effects were then used in 6-DOF simulations to assess the RCS model by comparisons to flight data.

This paper provides a brief description of the RCS plume model and the DSMC simulations used for flow field and aerodynamic predictions. The effects of firing various RCS thrusters will be presented for Odyssey aerobraking conditions, and the incorporation of the predicted increments in forces and moments into 6-DOF simulations will be discussed. Finally, comparisons of the 6-DOF predictions with flight data will be provided for selected aerobraking passes.

**2. ACS description.** The Attitude Control System (ACS) control frame for Odyssey is composed of two star cameras, two sun sensors, two local Inertial Measurement Units (IMU), two sets of two-axis gimbals, and four reaction wheels.<sup>1</sup> The IMUs contain the accelerometers from which atmospheric density is derived using Eq. (1).

$$(1) \quad a_y = \rho \frac{C_D A}{2m}$$

This density profile is input to the POST 6-DOF simulation. The reaction wheel desaturation profile is also input to 6-DOF POST. The remaining components of the ACS are not considered here.

**2.1 Reaction wheel model.** The Mars Odyssey ACS contained four reaction wheels: three axial and one skew, offset in the assembly frame so that equal torque is achieved in the  $x$ ,  $y$ , and  $z$  spacecraft coordinate frame.<sup>1</sup> The reaction wheels were modeled in 6-DOF POST. Telemetry received from the Odyssey spacecraft reported reaction wheel speeds. With the knowledge of reaction wheel gains and inertias, the reaction wheel speeds were converted to a net reaction wheel torque and summed into the environmental moments.

---

<sup>1</sup> *Mars Surveyor Program '01 – Orbiter ACS Hardware Coordinate Frame Definitions and Transformations*. Algorithm: LIB-6. Revision: 7. Revision Date: 2/5/01.

**2.2 Plume aerodynamic model.** The Odyssey RCS consists of four monopropellant hydrazine thrusters located approximately as shown in Figure 1.

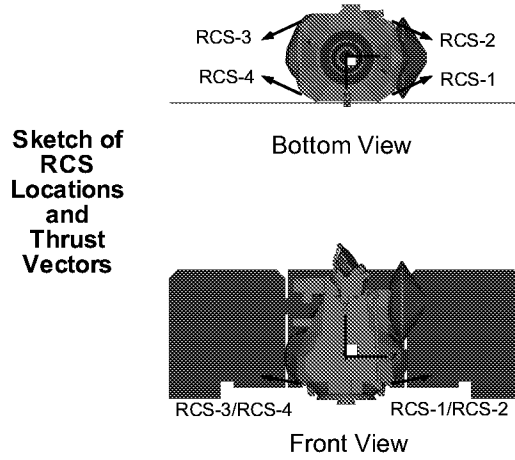

FIG. 1. Sketch of Odyssey spacecraft showing RCS locations.

These thrusters have a nominal thrust of 0.88 N, and their axes are canted such that they can be fired in various combinations to provide three-axis attitude control (see Table 1).

TABLE 1  
RCS firings that control individual axis rotations.

Axis	RCS-1	RCS-2	RCS-3	RCS-4
+x	On	Off	Off	On
-x	Off	On	On	Off
+y	On	On	Off	Off
-y	Off	Off	On	On
+z	On	Off	On	Off
-z	Off	On	Off	On

Outside the atmosphere, the thruster plumes expand rapidly and can produce impingement primarily on the backside of the solar panels. During aerobraking, the plumes may also interact with the flow around the spacecraft thereby altering the aerodynamics. Both of these conditions produce incremental forces and moments on the spacecraft in addition to those produced by the thrust of the nozzles themselves that must be taken into account for accurate attitude modeling. A complete analysis of these RCS aerodynamic effects requires modeling of the flow inside the thruster, the flow in the plume, and the resulting flow around the spacecraft. Since the latter effects depend on both the aerodynamic (relative wind) attitude of the spacecraft and the atmospheric density, the ultimate product of these analyses is an RCS aerodynamic database that can provide these incremental forces and moments throughout the aerobraking pass, i.e., as a function of attitude and density.

**2.3. Plume flow model.** The internal nozzle flow was computed using a Navier-Stokes solver to provide the exit plane properties [6]. The computations started upstream of the throat using the stagnation chamber pressure of 2.034 MPa and temperature of 1167 K. The geometry upstream of the throat was approximated to provide a smooth convergent section; the throat diameter was 0.29 cm and the divergent section was a 15° half-angle cone with an exit-to-throat area ratio of 100. The internal flow was assumed to be laminar, and the gas was modeled as a perfect gas.

The plume flow model used in the present study was devised by Woronowicz and adapted for Odyssey by Chavis [6,4]. The model is used to compute properties in the plume based on source-flow principles and derived from a free-molecular formulation of conservation of mass, momentum, and energy. The derivation assumes that the flow expands radially from each of a distribution of point sources whose properties are specified based on the exit plane solution described above. Although the free-molecular description of the flow is not valid in the continuum core of the plume and the source flow assumption breaks down near the nozzle exit, it has been found that the radial expansion assumption gives a reasonably accurate approximation of the spatial variations in plume flow properties at sufficiently large distances from the exit. Furthermore, this model has been shown to capture much of the functional dependence of these properties on nozzle exit conditions and to produce far-field plume properties that are comparable to those predicted by full Navier-Stokes computations [6,4].

**3. DSMC flow simulations.** The impingement of the plume on nearby spacecraft surfaces and the flow around the spacecraft was modeled using the Direct Simulation Monte Carlo (DSMC) method [5]. The DSMC computations were performed using the DSMC Analysis Code (DAC) of LeBeau which was also used separately to compute the basic aerodynamics of Odyssey [7,1]. DSMC models the molecular nature of low-density flows by tracking the motion and collisions of millions of individual molecules. These flows typically are not in thermodynamic equilibrium and cannot be modeled with conventional continuum methods. Macroscopic properties within the flow and forces and moments on surfaces within the flow domain are determined by statistical sampling. DAC can treat complex three-dimensional geometries and allows non-uniform inflow boundaries to be defined to simulate plumes or other inflows whose properties must be defined by other means.

The plume effects were introduced into the DSMC computations by defining an iso-density boundary from the plume source-flow solution to approximate the boundary between continuum and transitional flow. Although this boundary is more commonly chosen based on breakdown criteria established by Bird, these criteria are typically based on local density gradients which are not accurately captured with simple source-flow solutions [5]. Therefore, the iso-density condition was chosen for these studies based on a ratio of the local-to-freestream momentum flux of 100, which allows the DSMC solution to capture the bulk of the interaction of the plume and freestream flows. A typical iso-density boundary surface for Odyssey is shown in Figure 2. Since each of the Odyssey RCS thrusters have identical nozzle and plume characteristics, this surface is constructed such that it can be translated and rotated to represent any of the four thrusters. For multiple thruster firings, multiple surfaces are used. The location and size of these surfaces is such that these surfaces do not overlap, so that any plume-plume interactions are fully captured by the DSMC computations.

**4. Flow simulation and aerodynamic results.** Figure 3 shows surface contours from a typical DSMC solution which illustrate both the directed flux onto the spacecraft from the expanding plume and the resulting pressure contours on the surface for a typical aerobraking condition. The thrusters designated RCS-2 and RCS-3 produced the largest direct impingement effects on the solar panel even though they were further away than RCS-1 and RCS-4 because the thrust axes of RCS-2 and RCS-3 were canted toward the panel. However, these impingement effects are not as clearly evident in the pressure contours of Figure 3, because the atmospheric flow around the spacecraft during aerobraking interacts with the plume causing the impingement effects to be diffused. The plume also tends to act as a shield which blocks the atmospheric molecules from reaching the panel surface, so that the net effect on the aerodynamics is quite complex.

DSMC simulations were performed with and without RCS firings for various combinations of thrusters, various densities (including zero to capture direct impingement effects in the absence of the atmosphere), and various spacecraft attitudes. The aerodynamic forces and moments from these simulations were then used to construct a database which provided the increments in forces and moments that were needed to perform the 6-DOF simulations. A typical set of increments in moment coefficients about the spacecraft mechanical axes is shown in Figure 4 for RCS-1 and RCS-2. These



increments do not include the contribution from the actual RCS thrust forces but only those caused by impingement and aerodynamic flow interaction. Since these increments are shown here as coefficients ( $C_m = M_{CM}/qAL$ , where  $q$  is the dynamic pressure and  $M_{CM}$  is the moment about the center of mass), their values are singular as the density approaches zero. However, in the implementation of the database, the zero density increments are replaced by dimensional quantities that represent the vacuum impingement effects only

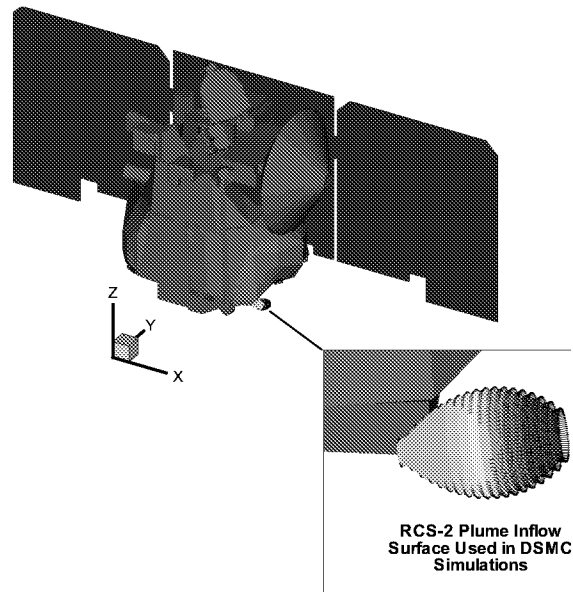

FIG 2. Plume inflow model used in DSMC simulations of plume impingement and plume-freestream interactions.

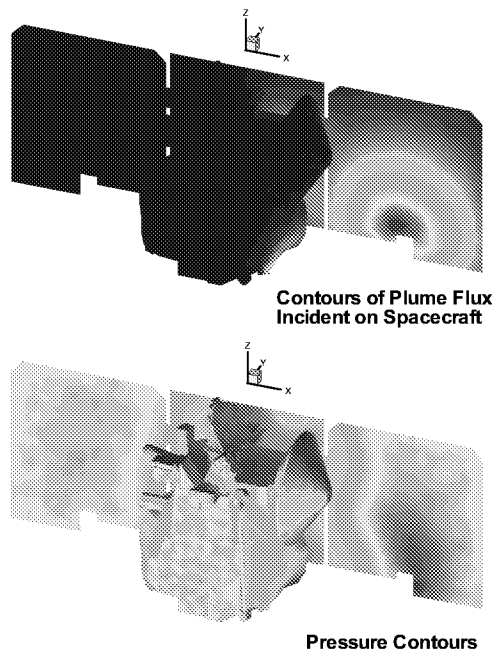

FIG 3. Plume impingement flux and pressure contours for RCS-2 firing during aerobraking. Atmospheric density =  $100 \text{ kg/km}^3$ . Spacecraft attitude at zero pitch and yaw.

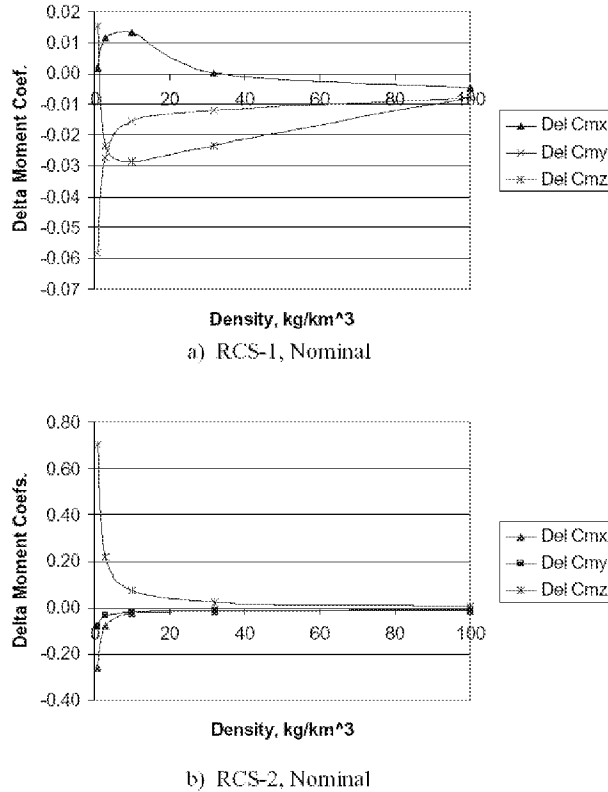

FIG 4. Increments in aerodynamic moments produced by various thruster firings. Spacecraft attitude at zero pitch and yaw.

The results shown here represent only a small part of the computations required to construct the database used for 6-DOF simulations. Further details of the computations and results are provided in Reference 2.

**5. 6-DOF models.** Initial inputs to POST 6-DOF were defined at a given time before periapsis passage. Depending on the duration of the drag pass, this time ranged from 600 seconds to 400 seconds before the time of periapsis. Inputs to the simulation were time, spacecraft position, velocity, orientation, angular rates, and reaction wheel speeds. Profiles of density and reaction wheel speeds throughout the drag pass were also included in the simulation.

Orientation, angular rates, thruster on-times, and reaction wheel speeds were obtained through spacecraft telemetry. Spacecraft position and velocity were acquired through .spk files generated by the Double Precision TRAjectory program (DPTRAJ) at the Jet Propulsion Laboratory. Thruster on-times were obtained from Small Forces Files (SFF) generated onboard the spacecraft. The SFF provides cumulative effects of delta V over a specific time interval.<sup>2</sup> During Odyssey operations, this time interval was set to  $\pm 600$  seconds from periapsis to incorporate any possible RCS thruster firings within the atmosphere.

Density profiles were 7 second running means of the density obtained through accelerometer measurements analyzed by the George Washington University accelerometer team at NASA Langley Research Center. A 7 second average was used to reduce noise within the density profile while still including density spikes or abnormalities within the atmosphere [8].

<sup>2</sup> Software Interface Specification Small Forces File for Mars Polar Lander, Stardust, Genesis and Mars Odyssey 2001 Orbiter Version 1.7 February 24, 2001 Custodian : C.Acton Navigation and Ancillary Information Facility.

**6. 6-DOF results.** The 6-DOF POST was used during the aerobraking phase operations at NASA Langley Research Center to validate or adjust the aerodynamics subroutine. Comparisons of body angular rates and Euler angles were available for every orbit, and any trends in substandard comparisons would possibly lead to changes or corrections in the aerodynamics subroutines. Validations of the 6-DOF POST were performed on several pre-aerobraking exoatmospheric situations to ensure that proper implementation of the non-aerodynamic models in POST were correct. These situations included the second Trajectory Correction Maneuver (TCM) on June 20, 2001 and several orbit passes around Mars before Odyssey first skimmed the Mars atmosphere.

**7. TCM2 validation.** During the cruise phase of the Odyssey mission, there were four scheduled TCM burns to correct trajectory dispersions in preparation for insertion into orbit around Mars. During the second of these burns designed as an optimization strategy to minimize total required propellant,<sup>3</sup> data were received at NASA Langley to validate the RCS and reaction wheel models in the 6-DOF simulation. This data required by the 6-DOF simulation of the TCM2 included thruster accumulated pulses, quaternions, angular rates, and reaction wheel speeds. From this data, a profile of Euler angles and angular rates were simulated using the 6-DOF POST.

Figure 5 shows 400 seconds of the TCM during which there were few or no thruster firings. If there were thrusters fired in this time period, they were fired for shorter than 0.1 second and did not record on the telemetry report. This comparison was made to validate the implementation of the reaction wheel model. There were slight variations in the reaction wheel speeds that corresponded to slight variations in the angular rates of Odyssey. Most of the high frequency oscillations in the flight data is attributed to IMU noise. The rates center about zero with no peaks greater than 0.025 deg/s. The 6-DOF POST captured the slight changes in rates and therefore validated this aspect of the simulation.

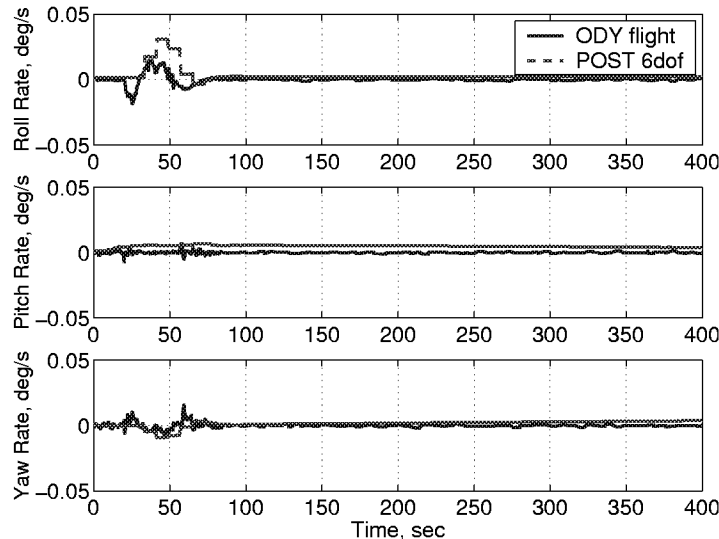

FIG 5. TCM2 validation, no RCS firing: Odyssey body angular rates.

Figure 6 shows a separate phase of the TCM2 during which there were several firings of the RCS thrusters. These firings are from RCS-1 and RCS-2 and are most prevalent in the roll rate, resembling steep almost instantaneous decreases in rate. The 6-DOF POST captures these firings at the correct time, but there is a small overshoot in the thrust that accumulates with time. The thrusters are simply not producing as much thrust as the simulation suggests, posing the possibility of thruster impingement effects upon the solar arrays that had not been modeled to date. Although the possibility of thruster

<sup>3</sup> Mars Surveyor 2001 Mission Plan Revision B, August 2000 JPL

impingement had been examined at the time of this validation, the RCS impingement model was not used in this validation. Because of the thrust overshoot after approximately 20 seconds, the pitch rate and yaw rate also deviate slightly from the flight data. Nevertheless, this test validates the correct implementation of the thruster model without impingement effects.

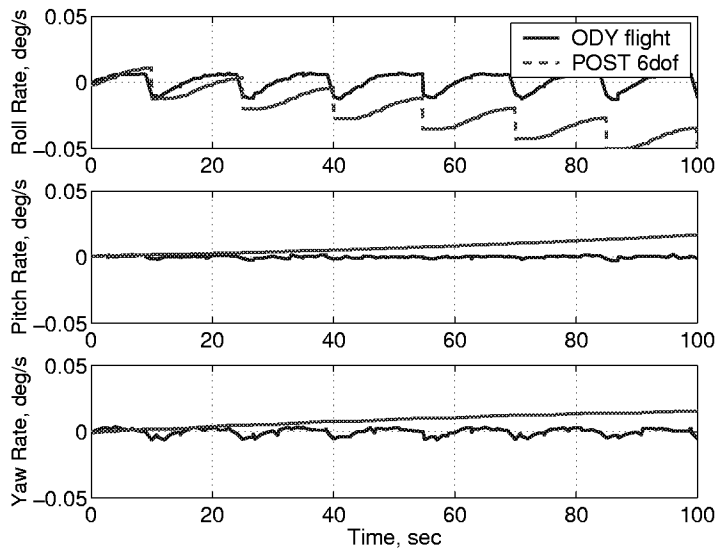

FIG 6. TCM2 validation with RCS firing: *Odyssey* body angular rates.

**8. Exoatmospheric orbit validation.** The first orbital passes of *Odyssey* around Mars provided for exoatmospheric orbital data analysis to again validate models that did not depend on atmospheric density. Periapsis altitudes prior to P008 were higher than 150 km above the reference ellipsoid of Mars, so the 6-DOF POST was run assuming flight in a vacuum.

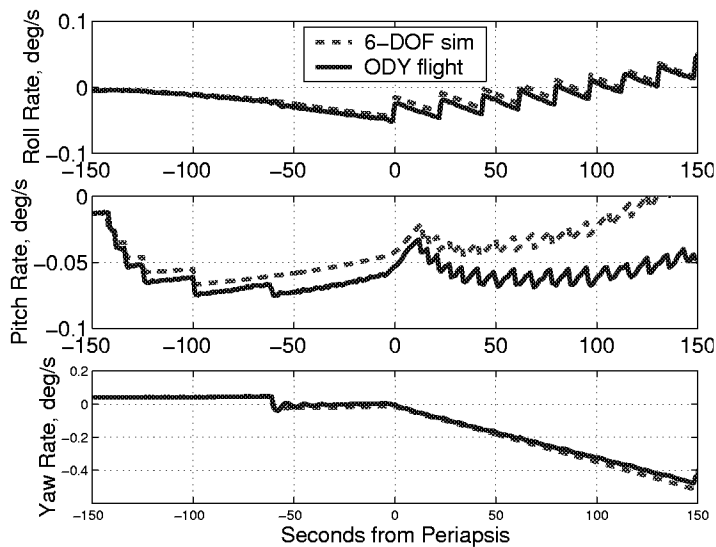

FIG 7. *Periapsis 4* body angular rates.

Figure 7 shows Odyssey angular rates 150 seconds prior to and after periapsis 4. The roll rate captures all of the thruster firings in this time interval. The vast majority of all thruster firings during Odyssey aerobraking were from RCS-1 and RCS-2 to control the roll rate of the s/c (see Table 1). The angular roll rate comparison is good to within 0.001 deg/s. The yaw rate also compares extremely well, simulating the flight data to within 0.05 deg/s. The pitch rate in the POST resembles the same pattern as the flight data with the exception of one point at approximately 65 seconds before periapsis where there is a sharp decrease in pitch rate that the simulation does not capture. This is either a thruster firing that the small forces file did not report or more probably, a coupling among the axes that the simulation did not model. Note that there is a decrease in the yaw rate at the same time which is simulated in the yaw rate but does not couple in the pitch rate simulation. If the simulation had followed the flight data at this point, the pitch rate would have matched better throughout this test.

Figure 8 shows the spacecraft roll, pitch, and yaw from the same periapsis. As expected, since the simulation of body angular rates and the flight data are so comparable, the Euler angles are similarly close; the roll and yaw angles are within two degrees of the flight data after 300 seconds of simulation, and the pitch angle is within eight degrees after the same time period. Note that this larger discrepancy is again due to the missed decrease in pitch rate at approximately 65 seconds before periapsis.

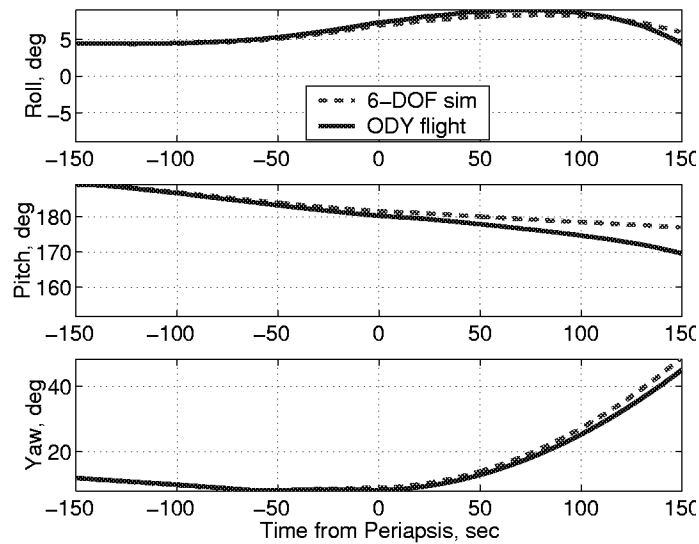

FIG 8. Periapsis 4 euler angles

**9. Aerobraking results.** Once Odyssey entered the Mars atmosphere, the RCS impingement model was implemented into 6-DOF POST. Using this model, comparisons of angular rates and roll, pitch, and yaw were generated for every orbit during Odyssey operations. The effect of the RCS impingement model is shown in figures 9 and 10 of periapsis 161. The blue dotted line indicates the Odyssey flight data. The red line indicates the 6-DOF POST without the RCS impingement model. The magenta dashed line indicates the 6-DOF POST with the implementation of the RCS impingement model. The maximum density of the 7 second running mean of density for this orbit was  $49.8 \text{ kg/km}^3$ , a typical maximum density approached by Odyssey. The discontinuities in the red line indicate RCS thruster firings simulated in 6-DOF POST without the thruster impingement model. As in every orbit during aerobraking, the thruster firings appear mostly in the roll rate. The accumulated thrust overshoot in the simulation reaches one degree per second after 100 seconds. When the thruster impingement model is added to the simulation, this error decreases by 50% within the same time frame. To correct this error further, a multiplier was incorporated into the roll moment coefficient within the impingement model only. Note that although RCS-2 and RCS-3 produced the most impingement effects on the spacecraft,

RCS-1 and RCS-2 were fired more frequently to control the roll rate, and therefore only a roll moment multiplier was necessary.

The multiplier for orbit 161 increased the impingement roll moment by a factor of 2.35. By decreasing the thrust effect, the roll rate was brought closer to the actual flight data. In figure 9 this adjusted impingement is indicated by the green '+' line that is comparable to the blue line indicating the flight data. As noted in the lower plots of figure 9 this adjustment in the impingement model did not much affect the pitch rate or yaw rate. The simulated yaw rate shows good agreement to the flight data. Although the pitch rate simulation does not correlate as well with the flight data, the frequency of the pitch rate oscillations is similar to flight.

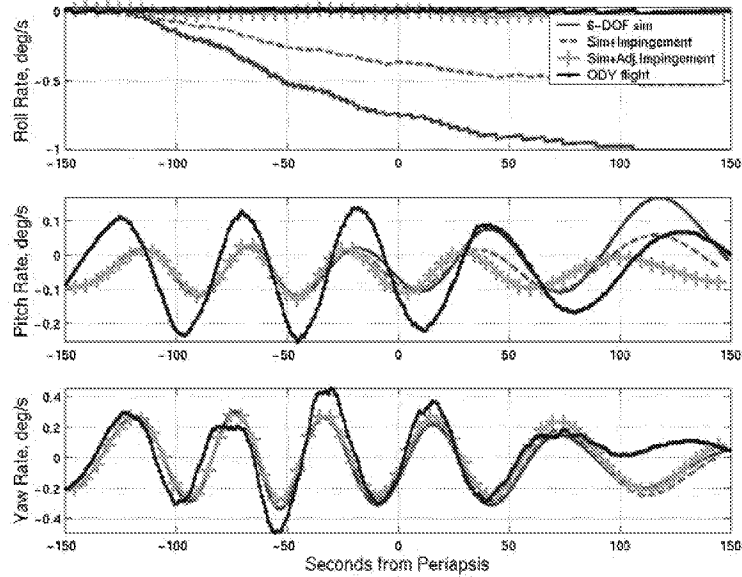

FIG 9. Periapsis 161 body angular rates.

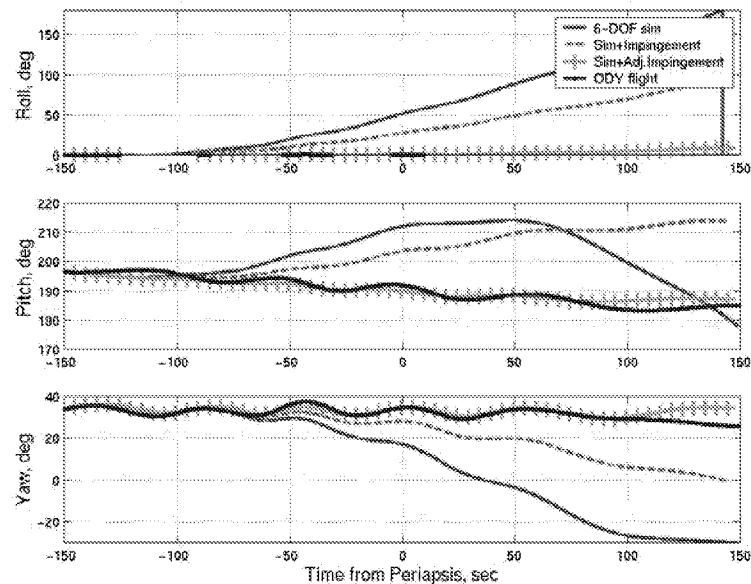

FIG 10. Periapsis 161 euler angles.

Figure 10 shows the roll, pitch, and yaw from the same orbit 161. Again, the red line of the POST simulation without the impingement model does not correlate well with the flight data. After the impingement model is added, this error decreases, but it is not until the inclusion of the 2.35 multiplier that the simulation compares to within a few degrees.

The inclusion of a multiplier on the roll moment coefficient of the RCS impingement model was introduced during Odyssey aerobraking operations on orbit 46 to adjust the simulation to better correlate to flight data. In time, a trend developed in the magnitude of this multiplier. Figure 11 shows the variation of roll moment multiplier with maximum density of each orbit since periapsis 46. As shown, the multiplier decreases as maximum density increases.

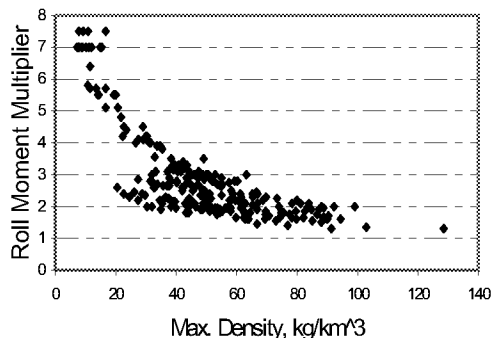

FIG 11. Variation of roll moment multiplier with maximum density after periapsis 46.

During Odyssey aerobraking, as a general rule, the larger density profiles required more thruster firings to stay within the control box. Figure 12 shows the on times for each RCS thruster with maximum density. RCS thrusters 1 and 2 fired most often, producing a negative roll about the spacecraft. As the spacecraft flew through denser regimes of the Mars atmosphere, the RCS-1 and RCS-2 fired more to keep the roll angle under control. From figures 11 and 12, it can be determined that with the increased number of thruster firings, the larger accumulated error in roll rate occurred, requiring a larger multiplier on the roll moment coefficient in the RCS impingement model to further reduce the effect of the simulated thrust.

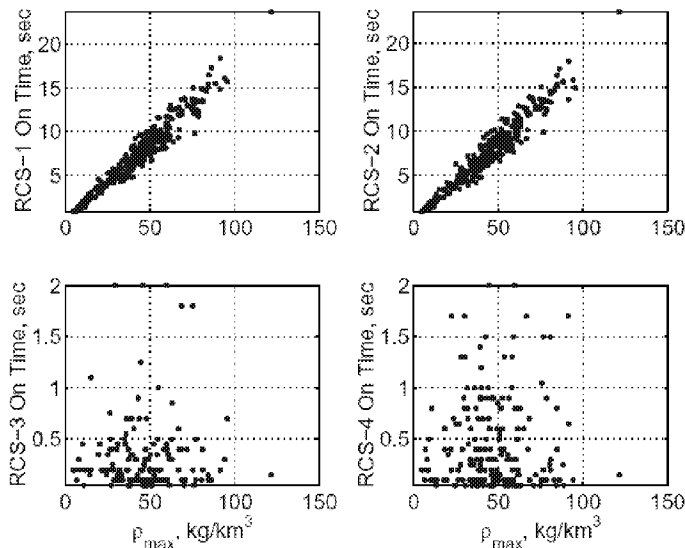

FIG 12. Variation of RCS on-times with maximum density after periapsis 46.

**10. Conclusion.** The 2001 Mars Odyssey successfully completed its aerobraking phase with the use of RCS thrusters to maintain attitude control within the Mars atmosphere. Several attitude control models including reaction wheel and thruster plume models were incorporated into a 6-DOF simulation to accurately simulate the rotational motion of the spacecraft during flight. Upon inspection of the thruster orientation and plume effects, impingement on the solar array and interaction with atmospheric molecules reduced the effectivity of the RCS thrusters. The 6-DOF analysis supported the research that was performed pre-flight, and with the use of adjustments to the RCS impingement model, an accurate simulation of Odyssey atmospheric flight was performed.

## REFERENCES

- [1] N. TAKASHIMA and R.G. WILMOTH, *Aerodynamics of Mars Odyssey*. AIAA Paper 2002-4809, AIAA Atmospheric Flight Mechanics Conference, August 5-8, 2002, Monterey, California.
- [2] F.J. CESTARO and R.H. TOLSON, *Magellan Aerodynamic Characteristics During the Termination Experiment Including Thruster Plume-Free Stream Interactions*. NASA CR-1998-206940, March 1998.
- [3] D.F. RAULT, *RCS Plume Effect on Spacecraft Aerodynamics During Aerobraking Maneuver*. Rarefied Gas Dynamics 20, edited by C. Shen, Peking Univ. Press, Beijing, PRC, 1996, pp. 549-554.
- [4] Z.Q. CHAVIS and R.G. WILMOTH, *Plume Modeling and Application to Mars 2001 Odyssey Aerobraking*. AIAA Paper 2002-2896, 8<sup>th</sup> AIAA/ASME Joint Thermophysics and Heat Transfer Conference, June 24-27, 2002, St. Louis, Missouri.
- [5] G.A. BIRD, *Molecular Gas Dynamics and the Direct Simulation of Gas Flows*, Clarendon, Oxford, UK, 1994.
- [6] M.S. WORONOWICZ and D.F.G. RAULT, *On Plume Flowfield Analysis And Simulation Techniques*. AIAA Paper No. 94-2048, AIAA/ASME 6<sup>th</sup> Joint Thermophysics and Heat Transfer Conference, June 1994, Colorado Springs, Colorado.
- [7] G.J. LEBEAU, and F.E. LUMPKIN, III, *Application Highlights of the DSMC Analysis Code (DAC) Software for Simulating Rarefied Flows*. Computer Methods in Applied Mechanics and Engineering, 191, Issue 6-7 (2001), pp. 595-609.
- [8] R.H. TOLSON, et al. *Application of Accelerometer Data to Mars Odyssey Aerobraking and Atmospheric Modeling*. AIAA 2002-4533, Astrodynamics Specialist Conference, August 5, 2002, Monterey, California.



REPORT DOCUMENTATION PAGE			Form Approved OMB No. 0704-0188	
Public reporting burden for this collection of information is estimated to average 1 hour per response, including the time for reviewing instructions, searching existing data sources, gathering and maintaining the data needed, and completing and reviewing the collection of information. Send comments regarding this burden estimate or any other aspect of this collection of information, including suggestions for reducing this burden, to Washington Headquarters Services, Directorate for Information Operations and Reports, 1215 Jefferson Davis Highway, Suite 1204, Arlington, VA 22202-4302, and to the Office of Management and Budget, Paperwork Reduction Project (0704-0188), Washington, DC 20503.				
1. AGENCY USE ONLY (Leave blank)	2. REPORT DATE July 2002	3. REPORT TYPE AND DATES COVERED Contractor Report		
4. TITLE AND SUBTITLE MODELING REACTION CONTROL SYSTEM EFFECTS ON MARS ODYSSEY			5. FUNDING NUMBERS C NAS1-97046 WU 505-90-52-01	
6. AUTHOR(S) Jill L. Hanna, Zachary Q. Chavis, and Richard G. Wilmoth				
7. PERFORMING ORGANIZATION NAME(S) AND ADDRESS(ES) ICASE Mail Stop 132C NASA Langley Research Center Hampton, VA 23681-2199			8. PERFORMING ORGANIZATION REPORT NUMBER ICASE Report No. 2002-31	
9. SPONSORING/MONITORING AGENCY NAME(S) AND ADDRESS(ES) National Aeronautics and Space Administration Langley Research Center Hampton, VA 23681-2199			10. SPONSORING/MONITORING AGENCY REPORT NUMBER NASA/CR-2002-211767 ICASE Report No. 2002-31	
11. SUPPLEMENTARY NOTES Langley Technical Monitor: Dennis M. Bushnell Final Report Submitted to AAS/AIAA Astrodynamics Specialist Conference, Monterey, CA, August 2002.				
12a. DISTRIBUTION/AVAILABILITY STATEMENT Unclassified-Unlimited Subject Category 64 Distribution: Nonstandard Availability: NASA-CASI (301) 621-0390			12b. DISTRIBUTION CODE	
13. ABSTRACT (Maximum 200 words) During the Mars 2001 Odyssey aerobraking mission, NASA Langley Research Center performed 6 degree of freedom (6-DOF) simulations to determine rotational motion of the spacecraft. The main objective of this study was to assess the reaction control system models and their effects on the atmospheric flight of Odyssey. Based on these models, a comparison was made between data derived from flight measurements to simulated rotational motion of the spacecraft during aerobraking at Mars. The differences between the simulation and flight derived Odyssey data were then used to adjust the aerodynamic parameters to achieve a better correlation.				
14. SUBJECT TERMS aerodynamics, Odyssey			15. NUMBER OF PAGES 17	
			16. PRICE CODE A03	
17. SECURITY CLASSIFICATION OF REPORT Unclassified	18. SECURITY CLASSIFICATION OF THIS PAGE Unclassified	19. SECURITY CLASSIFICATION OF ABSTRACT	20. LIMITATION OF ABSTRACT	