



# An Overview of the Antenna Measurement Facilities at the NASA Glenn Research Center

Kevin M. Lambert  
Analex Corporation, Cleveland, Ohio

Godfrey Anzic, Robert J. Zakrajsek, and Afroz J. Zaman  
Glenn Research Center, Cleveland, Ohio

## The NASA STI Program Office . . . in Profile

Since its founding, NASA has been dedicated to the advancement of aeronautics and space science. The NASA Scientific and Technical Information (STI) Program Office plays a key part in helping NASA maintain this important role.

The NASA STI Program Office is operated by Langley Research Center, the Lead Center for NASA's scientific and technical information. The NASA STI Program Office provides access to the NASA STI Database, the largest collection of aeronautical and space science STI in the world. The Program Office is also NASA's institutional mechanism for disseminating the results of its research and development activities. These results are published by NASA in the NASA STI Report Series, which includes the following report types:

- **TECHNICAL PUBLICATION.** Reports of completed research or a major significant phase of research that present the results of NASA programs and include extensive data or theoretical analysis. Includes compilations of significant scientific and technical data and information deemed to be of continuing reference value. NASA's counterpart of peer-reviewed formal professional papers but has less stringent limitations on manuscript length and extent of graphic presentations.
- **TECHNICAL MEMORANDUM.** Scientific and technical findings that are preliminary or of specialized interest, e.g., quick release reports, working papers, and bibliographies that contain minimal annotation. Does not contain extensive analysis.
- **CONTRACTOR REPORT.** Scientific and technical findings by NASA-sponsored contractors and grantees.

- **CONFERENCE PUBLICATION.** Collected papers from scientific and technical conferences, symposia, seminars, or other meetings sponsored or cosponsored by NASA.
- **SPECIAL PUBLICATION.** Scientific, technical, or historical information from NASA programs, projects, and missions, often concerned with subjects having substantial public interest.
- **TECHNICAL TRANSLATION.** English-language translations of foreign scientific and technical material pertinent to NASA's mission.

Specialized services that complement the STI Program Office's diverse offerings include creating custom thesauri, building customized databases, organizing and publishing research results . . . even providing videos.

For more information about the NASA STI Program Office, see the following:

- Access the NASA STI Program Home Page at <http://www.sti.nasa.gov>
- E-mail your question via the Internet to [help@sti.nasa.gov](mailto:help@sti.nasa.gov)
- Fax your question to the NASA Access Help Desk at 301-621-0134
- Telephone the NASA Access Help Desk at 301-621-0390
- Write to:  
NASA Access Help Desk  
NASA Center for AeroSpace Information  
7121 Standard Drive  
Hanover, MD 21076

NASA/TM—2002-211883



# An Overview of the Antenna Measurement Facilities at the NASA Glenn Research Center

Kevin M. Lambert  
Analex Corporation, Cleveland, Ohio

Godfrey Anzic, Robert J. Zakrajsek, and Afroz J. Zaman  
Glenn Research Center, Cleveland, Ohio

Prepared for the  
24th Annual Meeting and Symposium  
of the Antenna Measurement Techniques Association  
Cleveland, Ohio, November 3–8, 2002

National Aeronautics and  
Space Administration

Glenn Research Center

---

October 2002

## Acknowledgments

The authors would like to acknowledge the support of Dr. Felix A. Miranda, Chief, Applied RF Technology Branch, and Mr. Richard C. Reinhart, Manager, Integrated Communications Technologies Project, for their support in the continued development of the facilities and the presentation of this review. They also wish to thank Ms. Donna J. Clements for her assistance in the preparation of this paper.

Trade names or manufacturers' names are used in this report for identification only. This usage does not constitute an official endorsement, either expressed or implied, by the National Aeronautics and Space Administration.

Available from

NASA Center for Aerospace Information  
7121 Standard Drive  
Hanover, MD 21076

National Technical Information Service  
5285 Port Royal Road  
Springfield, VA 22100

Available electronically at <http://gltrs.grc.nasa.gov>

# Overview of Antenna Measurement Facilities at the NASA Glenn Research Center

Kevin M. Lambert  
Analex Corporation  
Cleveland, Ohio 44135

Godfrey Anzic, Robert J. Zakrajsek, and Afroz J. Zaman  
National Aeronautics and Space Administration  
Glenn Research Center  
Cleveland, Ohio 44135

## Abstract

For the past twenty years, the NASA Glenn Research Center (formerly Lewis Research Center) in Cleveland OH, has developed and maintained facilities for the evaluation of antennas. This effort has been in support of the work being done at the center in the research and development of space communication systems. The wide variety of antennas that have been considered for these systems resulted in a need for several types of antenna ranges at the Glenn Research Center. Four ranges, which are part of the Microwave Systems Laboratory, are the responsibility of the staff of the Applied RF Technology Branch. A general description of these ranges is provided in this paper.

## 1. Introduction

The Applied RF Technology Branch of the Communications Technology Division (CTD), at the NASA Glenn Research Center (GRC) develops antenna systems, subsystems, components and techniques for advanced communication systems. The advances in technology produced by the branch are used in both NASA and commercial applications. The work done by the branch encompasses antennas and related technologies for space, aeronautical and terrestrial terminals. The branch also works cooperatively with other Glenn divisions, NASA centers, industry, and educational organizations, which require assistance in studies of electromagnetic phenomena. The branch develops, maintains, and operates facilities for the measurement of such phenomena.

For the work involving the use of microwave and millimeter wave antennas, branch members and associates have four facilities available for their use. These facilities

include: a planar near-field range, an indoor spherical (far-field) range, a compact range, and a cylindrical near-field range. The purpose of this report is to briefly describe each of these facilities, their capabilities and their typical use. Examples from representative measurements, conducted utilizing the ranges, are provided. Program goals and requirements often require modification and improvement of the facilities. Current plans to meet future needs are also described.

The facilities are housed in the Microwave Systems Laboratory of the Glenn Research Center. The building, shown in figure 1 formerly known as the Altitude Wind Tunnel.

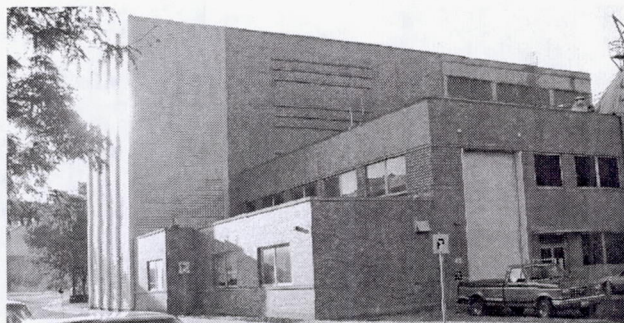

**Figure 1 - Microwave Systems Laboratory at the  
NASA Glenn Research Center.**

At the time of construction, it was the only known wind tunnel specifically designed to test aircraft engines at simulated altitude conditions. The first wind tunnel tests on American jet engine prototypes were conducted there. The building held the offices, shops, control rooms, and test section for the tunnel. Eventually engine testing was phased out and the facility was converted to a vacuum

facility for rocket testing and spacecraft separation tests. This was followed by installation of a multi-axis gimbaling rig for Project Mercury astronaut training. In the early 1980's, as the center continued its work in satellite communications with the beginning of the Advanced Communication Technology Satellite Project, the need arose to have the capability to measure full scale, prototype, satellite antenna systems. Since these were planned to be large reflector antennas, a facility had to have enough space to accommodate them. The near-field technique for antenna measurement had matured by that time and the high bay area of the building shop offered ample room for a suitable vertical, near-field scanner. Therefore, the decision was made to construct this type of range.

The large near-field test range was completed and operations began in 1983 [1]. This began the use of the building as an electromagnetic test facility. Research and development into microstrip patch antennas led to the conversion of the wind tunnel control room into a spherical (far-field) range in 1990. The building was expanded with an addition to the front in 1991. This allowed for a larger near-field test section, a permanent control room for the near-field range, and offices for personnel supporting the activity in the building. A compact range was added in a basement storage room in 1994 to perform radar cross-section and antenna measurements. In 2002, due in part to an increasing workload in the far-field range, a cylindrical near-field test range was completed. The cylindrical range was located within the addition to the original building.

## 2. Planar Near-Field Antenna Facility

Although it has been used for many purposes, the primary function of the Planar Near-Field Antenna Facility is the measurement of large microwave antennas. The test volume envelope that the antenna system under test (AUT) must fit within is approximately 40' × 40' and 60' in height. The dimensions of the vertical scan plane are 22' × 22' which defines the size of the largest antenna aperture that can be measured. The antennas are mounted to an azimuth over elevation positioner that has a total vertical load capacity of 30,000 lbs. A removable sidewall allows access from the preparation area for large structures. Antenna system installation and removal is assisted by an overhead crane. An image of the test area with a 2.7m reflector antenna installed is shown in figure 2.

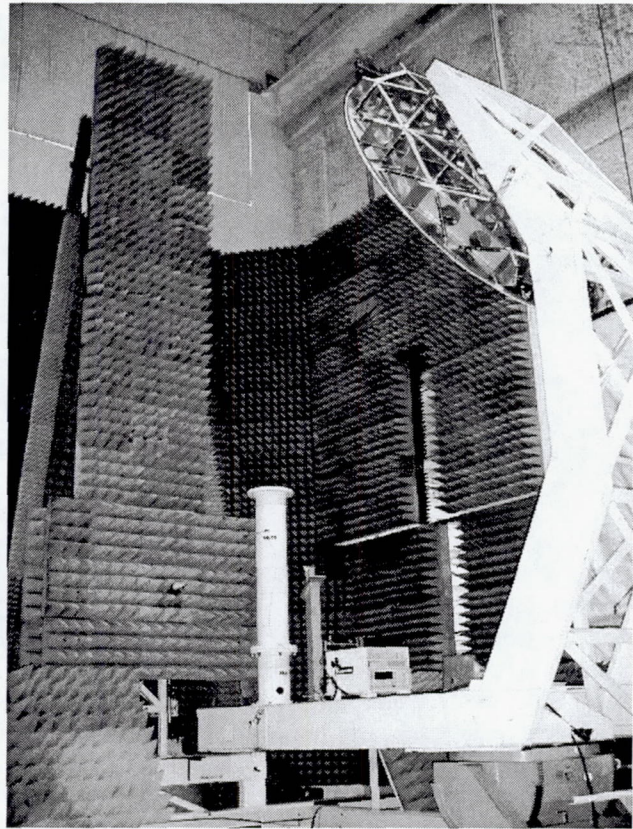

**Figure 2 - 2.7m Reflector Antenna in the Planar Near-Field Facility.**

Generally, a typical test uses the AUT as the transmit antenna and a rectangular waveguide as the receiving probe antenna. The aperture field of the AUT is sampled by performing a raster scan of horizontal steps and continuous vertical movement at each step. The position of the probe at each data point is determined with a laser interferometer system.

An Agilent 8510C Network Analyzer is used as the receiver for this range. The basic test configuration, shown in figure 3, can provide measurements over a 4- 40 GHz frequency range. The RF signal is generated in the range at the AUT. A reference signal is coupled from the RF input to the AUT and is down converted to a 20 MHz IF. The received signal from the probe is also down converted for a test channel of the receiver. To minimize LO phase changes and the weight of a cable as the probe is positioned, the LO is provided via a fiber optic link from the control room. This room, which is adjacent to the test section, is shown in figure 4. The experiment control and data processing computers are also located there.

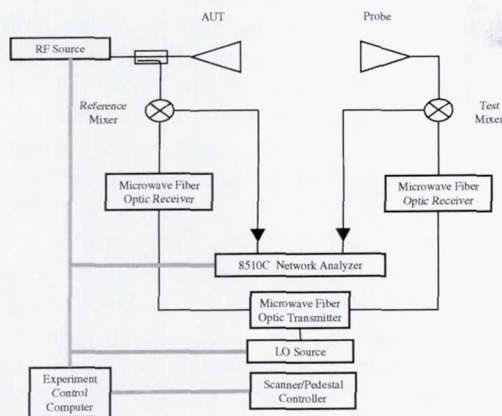

**Figure 3 - Measurement Configuration for the Planar Near-Field Facility.**



**Figure 4 - View of the Planar Near-Field Facility Control Room from the Test Section.**

Currently NASA personnel are in the process of refurbishing the drive motors and controls for the scanner. In addition, the original laser interferometer positioning system is obsolete and undergoing an upgrade.

### 3. Far-Field Facility

The Far-Field Facility was developed to investigate small, prototype microwave antennas such as reflector feeds, individual array elements and small phased arrays. Thus, this facility complements the function of the Planar Near-Field Facility. The range is located in a rectangular anechoic chamber that is approximately 18' x 12' in cross-section and 30' long. The usable range length is 24'. The facility can be readily configured to support any electromagnetic testing that can utilize the chamber. One permanent feature of the chamber is a centrally located,

12" steel beam that extends through the length of the chamber. A movable cart attached to the beam provides a range distance that can be continuously varied. Test equipment, including the pedestal for an AUT, can be located on a frame that attaches to the cart. An image which shows the chamber configured for receive pattern measurements of a phased array antenna is shown in figure 5. Here the movable cart and a portion of the test equipment are hidden behind the absorber panel. A view of the other end of the range, showing the transmit source for this test is shown in Figure 6. The location of the beam can be discerned by the raised absorber sections along the floor.

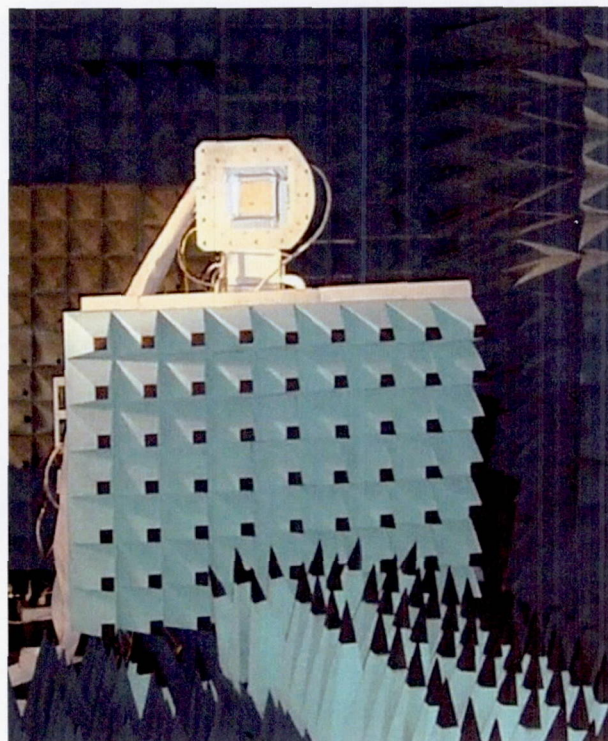

**Figure 5 - Far Field Facility Test Zone Configured for Pattern Measurements.**

The Far-Field Facility is currently being used to support a wide range of tests to characterize the effects of electronically scanned phased array antennas on communication link performance [2-4]. The data required from these tests are varied and thus equipment configurations are installed and adapted for each individual test. For standard antenna pattern and gain measurements between 2-40 GHz, a configuration similar to figure 3 is used. The differences are that an HP8410 Network Analyzer is used for the receiver and rather than the fiber, a conventional microwave cable is used for the LO signal. E-plane patterns at 19.85 GHz of the phased

array in figure 5 are presented in figure 7 as a function of scan angle.

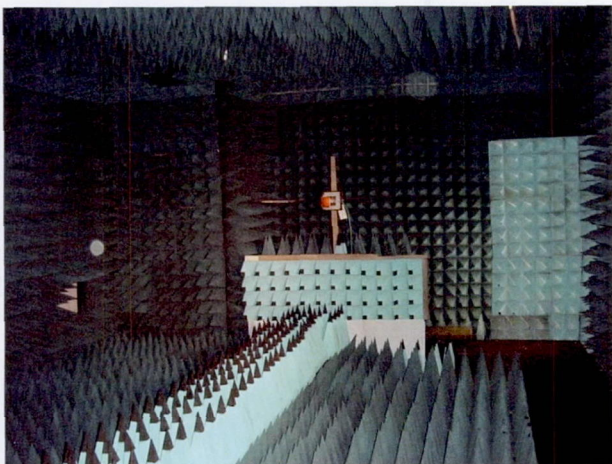

**Figure 6 – View of the Far-Field Facility Showing Source Location.**

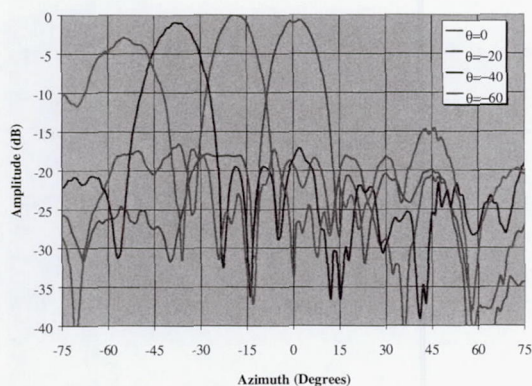

**Figure 7 - Phased Array Patterns from Far-Field Facility Measurements.**

The equipment configuration in the Far-Field Facility is continually being changed to support the different experiments. Therefore, studies are currently being conducted on how to efficiently switch between these configurations without experiencing appreciable range down time. Improvements are also anticipated in pedestal control, receiver capability, data processing, presentation, and computer networking.

#### 4. Compact Range Facility

In the early 1990's, GRC program goals required the ability to perform scattering measurements in addition to antenna measurements. These measurements included

tests of candidate materials for antenna systems that were lightweight but able to withstand the harsh environment of space. Leveraging the advances made in the development of ranges to measure radar-cross section, GRC worked with The Ohio State University—ElectroScience Laboratory to develop a dual use Compact Range Facility that performs both antenna and scattering measurements.

The compact range, shown in Figure 8, is a 12'× 10'× 26' rectangular chamber within a larger room of the Microwave System Laboratory. The separate chamber isolates the testing from the local environment and provides access to the test area with minimal operator interaction with the chamber itself. This allows increased accuracy and sensitivity especially when background subtraction is being used. The enclosure also maintains the integrity of the absorber treatment, the type and placement of which was chosen for minimal scattering into the quiet zone.

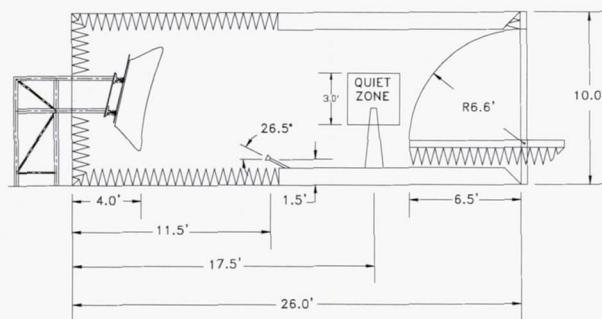

**Figure 8 - The Compact Range Facility.**

The 6'× 6' cross-section, offset parabolic reflector produces a cylindrical quiet zone of 3' diameter and 6' length [5]. The reflector can be seen in the image of range shown in figure 9. The blended edges of the reflector reduce the quiet zone amplitude ripple to 0.1 dB while maintaining amplitude taper less than 0.8 dB. The quiet zone phase performance is extremely flat, having been measured to be on the order of  $\pm 1^\circ$ . The reflector surface was machined to a finish that will allow testing above 100 GHz. However, the range is currently instrumented for 2 GHz to 36 GHz operations.

The instrumentation system used by the facility was built by OSU-ESL. This includes the radar receiver and the test pedestals and controller. The radar utilizes hardware range gating for clutter reduction and has approximately 100 dB of dynamic range. Data can be taken as a function of frequency, azimuth angle, or both. The radar features



two-channel operation between 2-18 GHz, which facilitates the use of the range for antenna measurements. The radar has a single channel from 18-36 GHz and antenna measurements are enabled by disconnecting the receive side of the T/R switch and connecting a cable from the receiving antenna. The polarization of the measurement is varied by rotating the entire range reflector feed assembly. The assembly can be seen in the center of figure 9. The rotation is performed by a stepping motor that is commanded remotely which also minimizes operator interaction with the range. The foam column shown in figure 9 and an azimuth rotator are used to support lightweight antennas and material samples. A metal ogive shaped pedestal is used for heavier test items.

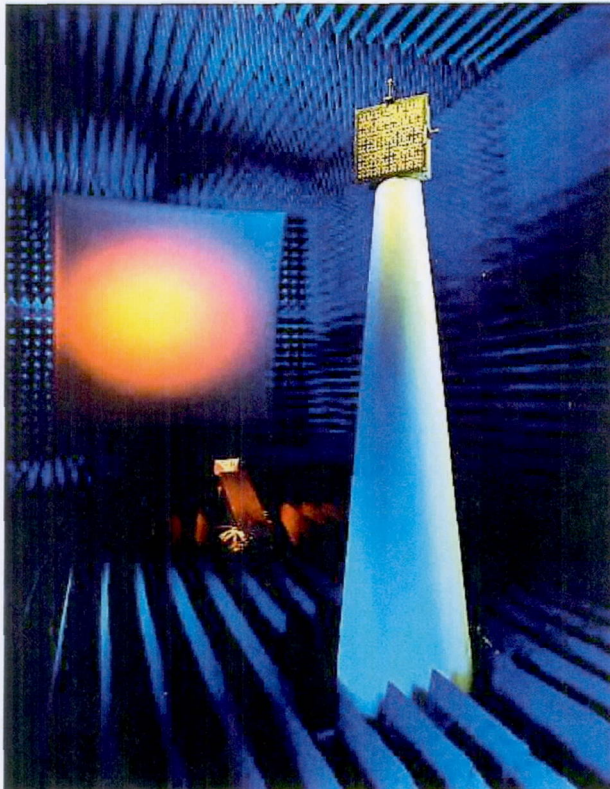

**Figure 9 - Interior of the Compact Range Facility.**

Experiments are controlled from the area adjacent to the chamber shown in figure 10. Computer resources for data storage, processing and presentation are available there as well. An example of data measured in the compact range is shown in figure 11.



**Figure 10 - Operations Area for the Compact Range Facility.**

NASA intends to move the Compact Range Facility to a more accessible, above grade location within the Microwave Systems Laboratory. Planning for the move has only recently been initiated and a time frame has not been finalized.

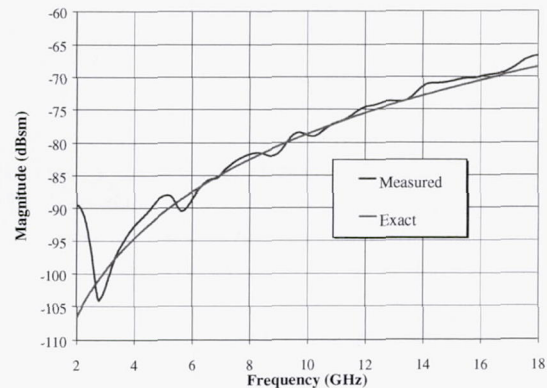

**Figure 11 - Measured and Exact Radar Cross-Section of a 1/16" Diameter Sphere.**

## 5. Cylindrical Near-Field Facility

The Cylindrical Near-Field Facility occupies a 10'×11'×9' high room within the Planar Near-Field Facility Control Room. The room, which was originally the computer room for the planar near-field range, has been converted into an anechoic chamber. A recently purchased NSI Model 600C-5 Cylindrical Near-Field Scanner System has been installed in the room. A view of this scanner in the room is shown in figure 12. The range is instrumented with an Agilent system consisting of an 8530A Microwave Receiver, 8511B Frequency Converter and 83650B Swept Signal Generator. This system provides for operation from 2 GHz to 40 GHz with different NSI waveguide probes. Checkout of the facility and operator training is currently under way.

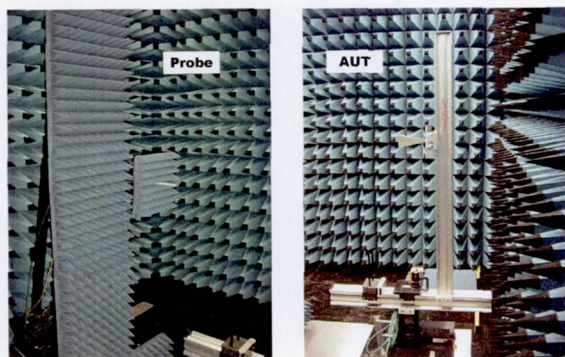

Figure 12 - The Cylindrical Near-Field Facility.

This facility is to be dedicated to assist in the research and development of small prototype antennas. The aperture size limitation on the AUT is approximately 10". It is expected that printed circuit, waveguide, horn, and wire antennas will be measured.

## 6. Summary

A description of the four antenna measurement facilities in the NASA Glenn Research Center, Microwave Systems Laboratory has been presented. These facilities provide NASA programs with a variety of options for obtaining performance information on microwave and millimeter wave antennas. The facilities are a flexible asset that can be utilized by research organizations for not only antenna measurements but other types of electromagnetic experiments as well.

## 8. References

- [1] Sharp, G.R., Zakrajsek, R.J., Kunath, R.R., Raquet, C.A., Alexovitch, R.E., "Characteristics and Capabilities of the NASA Lewis Research Center High Precision 6.7- by 6.7-m Planar Near-Field Scanner", NASA TM-83785, October 1984.
- [2] R. Acosta, S. Johnson, O. Sands, K. Lambert, "Characterization of Ka-Band Phased Array Systems: Modeling and Experimental Verification", AIAA 20<sup>th</sup> International Communication Satellite System Conference, May 2002.
- [3] O. S. Sands, "Beam-Switch Transient Effects in the RF Path of the ICAPA Receive Phased Array Antenna", submitted for approval as a NASA Technical Memorandum, NASA GRC, February 2002.
- [4] R. Acosta, S. Johnson, O. Sands, K. Lambert, "Ka-Band Phased Array System Characterization", 7<sup>th</sup> Ka Band Utilization Conference, Santa Margherita Ligure, Italy, September 26-28, 2001.
- [5] Gupta, I.J., Burnside, W.D., "A 6'×6' Compact Range Reflector for 2 GHz and Above Frequencies", Technical Report 722657-1, The Ohio State University ElectroScience Laboratory, March 1991.

# REPORT DOCUMENTATION PAGE

*Form Approved*  
*OMB No. 0704-0188*

Public reporting burden for this collection of information is estimated to average 1 hour per response, including the time for reviewing instructions, searching existing data sources, gathering and maintaining the data needed, and completing and reviewing the collection of information. Send comments regarding this burden estimate or any other aspect of this collection of information, including suggestions for reducing this burden, to Washington Headquarters Services, Directorate for Information Operations and Reports, 1215 Jefferson Davis Highway, Suite 1204, Arlington, VA 22202-4302, and to the Office of Management and Budget, Paperwork Reduction Project (0704-0188), Washington, DC 20503.

<b>1. AGENCY USE ONLY</b> ( <i>Leave blank</i> )	<b>2. REPORT DATE</b> October 2002	<b>3. REPORT TYPE AND DATES COVERED</b> Technical Memorandum	
<b>4. TITLE AND SUBTITLE</b> An Overview of the Antenna Measurement Facilities at the NASA Glenn Research Center		<b>5. FUNDING NUMBERS</b>  WU-322-10-2B-00	
<b>6. AUTHOR(S)</b>  Kevin M. Lambert, Godfrey Anzic, Robert J. Zakrajsek, and Afroz J. Zaman			
<b>7. PERFORMING ORGANIZATION NAME(S) AND ADDRESS(ES)</b> National Aeronautics and Space Administration John H. Glenn Research Center at Lewis Field Cleveland, Ohio 44135-3191		<b>8. PERFORMING ORGANIZATION REPORT NUMBER</b>  E-13566	
<b>9. SPONSORING/MONITORING AGENCY NAME(S) AND ADDRESS(ES)</b> National Aeronautics and Space Administration Washington, DC 20546-0001		<b>10. SPONSORING/MONITORING AGENCY REPORT NUMBER</b>  NASA TM-2002-211883	
<b>11. SUPPLEMENTARY NOTES</b> Prepared for the 24th Annual Meeting and Symposium of the Antenna Measurement Techniques Association, Cleveland, Ohio, November 3-8, 2002. Kevin M. Lambert, Analex Corporation, Cleveland, Ohio; Godfrey Anzic, Robert J. Zakrajsek, and Afroz J. Zaman, NASA Glenn Research Center. Responsible person, Kevin M. Lambert, organization code 5640, 216-433-6388.			
<b>12a. DISTRIBUTION/AVAILABILITY STATEMENT</b> Unclassified - Unlimited Subject Category: 33  Available electronically at <a href="http://gltrs.grc.nasa.gov">http://gltrs.grc.nasa.gov</a> This publication is available from the NASA Center for AeroSpace Information, 301-621-0390.		<b>12b. DISTRIBUTION CODE</b>	
<b>13. ABSTRACT</b> ( <i>Maximum 200 words</i> ) For the past twenty years, the NASA Glenn Research Center (formerly Lewis Research Center) in Cleveland, Ohio, has developed and maintained facilities for the evaluation of antennas. This effort has been in support of the work being done at the center in the research and development of space communication systems. The wide variety of antennas that have been considered for these systems resulted in a need for several types of antenna ranges at the Glenn Research Center. Four ranges, which are part of the Microwave Systems Laboratory, are the responsibility of the staff of the Applied RF Technology Branch. A general description of these ranges is provided in this paper.			
<b>14. SUBJECT TERMS</b> Antenna measurements; Compact range; Cylindrical near-field; Facility descriptions; Far-field ranges; Planar-near field			<b>15. NUMBER OF PAGES</b> 12
			<b>16. PRICE CODE</b>
<b>17. SECURITY CLASSIFICATION OF REPORT</b> Unclassified	<b>18. SECURITY CLASSIFICATION OF THIS PAGE</b> Unclassified	<b>19. SECURITY CLASSIFICATION OF ABSTRACT</b> Unclassified	<b>20. LIMITATION OF ABSTRACT</b>