

THERMAL EXAMINATION OF AN ORBITING CRYOGENIC FUEL DEPOT

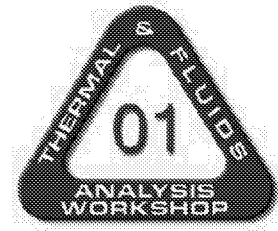

Name of Author(s)

Patrick V. Hull
Steven L. Canfield
Tennessee Technological University

Name of Co-Author(s)

Connie Carrington
John Fikes
NASA/MSFC

ABSTRACT

For many years NASA has been interested in the storage and transfer of cryogenic fuels in space. Lunar, L2 and other chemical propulsive space vehicle missions now have staged refueling needs that a fuel depot would satisfy. The depot considered is located in lower earth orbit. Many considerations must go into designing and building such a station. Multi-layer insulation systems, thermal shielding and low conductive structural supports are the principal means of protecting the system from excessive heat loss due to boiloff.

This study focuses on the thermal losses associated with storing LH₂ in a passively cooled fuel depot in a lower earth equatorial orbit. The corresponding examination looks at several configurations of the fuel depot. An analytical model has been developed to determine the thermal advantages and disadvantages of three different fuel depot configurations. Each of the systems consists of three Boeing rocket bodies arranged in various configurations. The first two configurations are gravity gradient stabilized while the third one is a spin-stabilized concept. Each concept was chosen for self-righting capabilities as well as the fuel settling capabilities, however the purpose of this paper is to prove which of the three concepts is the most efficient passively cooled system.

The specific areas to be discussed are the heating time from the fusion temperature to the vaporization temperature and the amount of boiloff for a specific number of orbits. Each of the previous points is compared using various sun exposed surface areas of the tanks.

INTRODUCTION

For many years NASA has been interested in the storage and transfer of cryogenic fuels in space. Lunar, L2 and other chemical propulsive space vehicle missions now have staged refueling needs that a fuel depot would satisfy. The depot considered is located in lower earth orbit. Many considerations must go into designing and building such a station. Multi-layer insulation

systems, thermal shielding and low conductive structural supports are the principal means of protecting the system from excessive heat loss due to boiloff.

This study will focus on the thermal losses associated with storing liquid hydrogen (LH_2) in a passively cooled fuel depot in a lower earth equatorial orbit. Three candidate designs will be analyzed and discussed, each resulting from a different depot configuration. Each design is based on a Boeing Delta IV Heavy Rocket. The specific analyses used to evaluate the designs are the heating time from the fusion temperature to the vaporization temperature and the boiloff losses. Multi-layer insulation systems, thermal shielding and low conductive structural supports are the principal passive means of reducing boiloff in systems storing cryogenic fuels.

An extensive analytical model has been developed and tested to determine the thermal losses for the three different fuel depot configurations. Each system is shown in figure 1

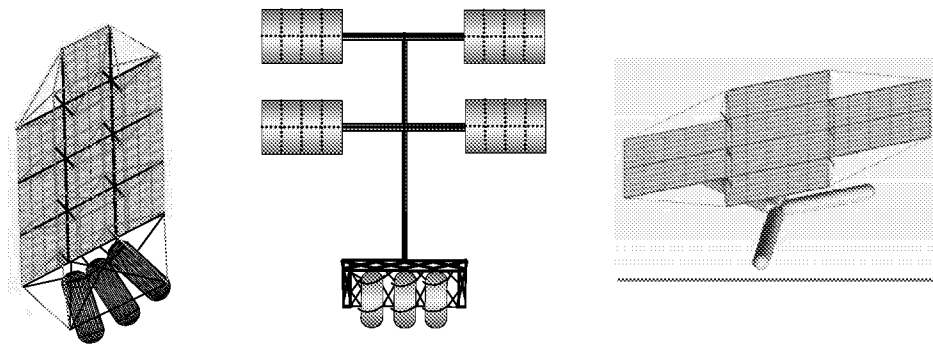

Figure 1: Abacus Tail Feather Concept, b) Four Wing Concept and c) Spinner Concept

ANALYTICAL MODEL

The vaporization temperature for LH_2 is 20.4K; the corresponding fusion temperature is 14K. Storage of LH_2 within this range will prevent slushing and boiloff. The greater concern is boiloff. Boiloff is mass loss due to phase changes from a solid to a gaseous state. Boiloff causes two severe problems within the system: (1) fuel loss and (2) over pressurization of the tank. Fuel loss due to vaporization is very expensive considering the mass transfer rate to LEO is \$10,000/lb. Over pressurization of the tank from fuel vaporization is due density change in the fuel. This increase in volume could rupture the tank.

Analysis Assumptions

Design of the model required the development of several assumptions to govern the process: They are as follows:

1. All potential and kinetic energy changes are considered negligible
2. Neglect the heating of the boiloff vapor, it is small enough too become negligible.
3. Storage depot should maintain an Lower earth equatorial orbit,
4. Assume steady state surface conditions of the following
 - (a) 1/10 of tank is considered against dark space

- (b) 2/5 of tank is covered by the Earth
 - (c) The Sun and the thermal shield are combined to cover 1/2 the area of the tank
5. Isothermal conditions for each area section of the tank

CONTROL VOLUME

Analysis of the storage tank shown in Figure 2 begins by the application of the first law of thermodynamics to the control volume shown. The control volume in this case is the cryogenic tank itself as shown below.

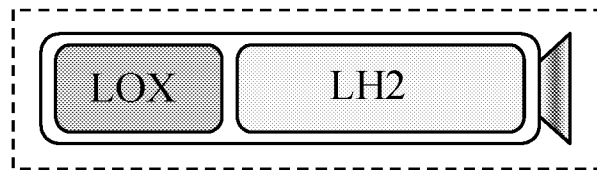
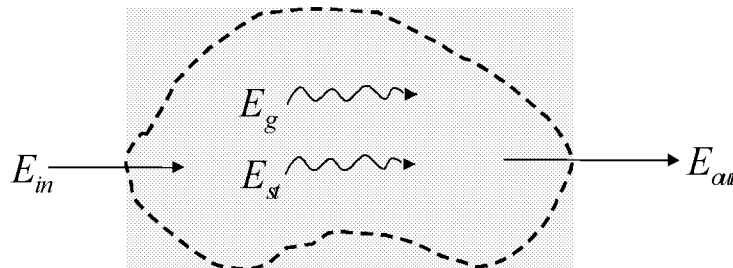

Figure 2: Control volume of the system

This is a passive system, meaning that no additional heat comes in or is taken away by thermal control system. The corresponding energy balance equation is $E_{in,\dot{}} + E_{g,\dot{}} + E_{out,\dot{}} = E_{st,\dot{}}$



$$E_{in} + E_g - E_{out} = E_{st}$$

Figure 3: Theoretical control volume of the system

where E_{in} is the energy into the system from outside sources, E_{out} is the energy loss from the system. Each of these energy components is associated only with the surface of the control volume, meaning the radiation added and lost to the system. E_g is the thermal energy generation and E_{st} is the rate of energy stored within the system. The energy stored is in the form of increasing LH₂ temperature.

The control volume and energy balance theory stated above is attributed to the specific problem of the cryogenic fuel tank. A orbiting space vehicle experiences three sources of heat

addition, E_{in} , radiation from the sun, radiation from the earth and the radiation from the vehicle itself. The vehicle radiation in this case is from the thermal shield and or support structure.

The core problem of cooling cryogenic fluids is to combat the radiant heating by direct and indirect means. The effective radiation heat transfer constant used for the sun is 1143 W/m^2 . Radiation emitted from the earth at LEO of 400Km is given by the radiation constant of $q_{earth} = 60 \text{ W/m}^2$ for the lighted portion and $q_{earth} = 20 \text{ W/m}^2$ for the shadow. Radiation absorption occurs from the thermal shield also. The thermal shield blocks some % of the sunlight from direct heat transfer to the tanks but in turn the shield is heated and thus emits radiation. The radiation constant is assumed to be 10 W/m^2 .

E_{in} results from the sum of the sources:

$$E_{in} = Q_{radSun} + Q_{radEarth} + Q_{radShield} \quad (1)$$

Heat is also lost from the system from the tank surface. The effective radiation from the tank takes the form as radiation:

$$Q_{radTank} = e \cdot \sigma \cdot A \cdot T_s^4 \quad (2)$$

Where e is the emmissivity and σ is the Stefan-Boltzman constant. Other heat transfer mechanisms and heat lost due to the heat sink in boiloff are neglected:

$$E_{out} = Q_{radTank} \quad (3)$$

Figure 4 depicts the control volume of the tank with the heat additions and losses due to radiation heat transfer:

The total heat balance for the surface of the control volume is:

$$Q_{radTot} = Q_{radSun} + Q_{radEarth} + Q_{radShield} - Q_{radTank} \quad (4)$$

SURFACE TEMPERATURE CALCULATION

To calculate the surface temperature of the tanks requires the determination of the roots of a fourth degree polynomial. Equating the conduction and radiation heat transfer rates and the polynomial is shown in Eqn 9-12.

$$\begin{aligned} Q_{Cond} &= Q_{Rad} \\ \frac{(T_s - T_i)}{R_{EQ}} &= Q_{TOT} - e\sigma AT_s^4 \\ (Q_{TOT})R_{EQ} - e\sigma AT_s^4 R_{EQ} - T_s + T_i &= 0 \\ Q &= \begin{bmatrix} R_{EQ}e\sigma AT_s^4 & 0 & 0 & -T_s & (Q_{TOT})R_{EQ} + T_i \end{bmatrix} \end{aligned} \quad (5-8)$$

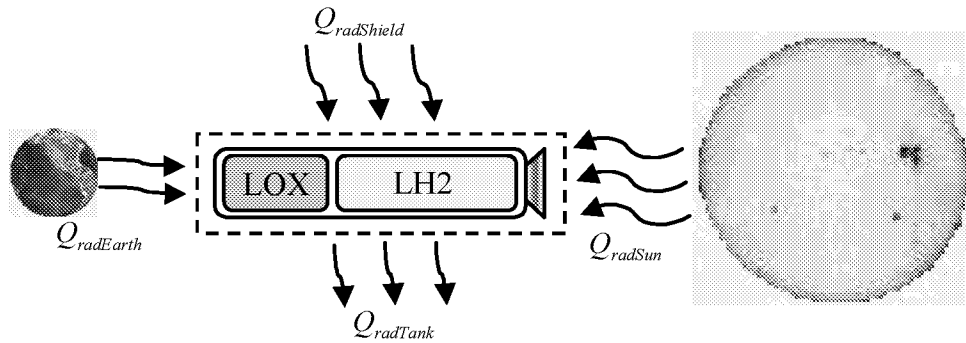

Figure 4: Control volume for radiation absorbed by the tank from the sun, earth and the shield and radiation emitted by the tank

The properties of the tank skin and substructure affect the thermal heating and cooling. The assumed tank absorptivity and emissivity are assumed $\alpha = 0.4$ and $e = 0.018$. Another strong factor contributing to the heating and cooling of the cryogenic tanks is the time spent in the sun. The assumptions are made that the time spent in earth's shadow is equivalent to 40% of the time in orbit, as shown below.

TANK CONDUCTION HEAT TRANSFER

Now that the surface heat exchange has been established the thermal resistance through the tank wall must be established. Thermal resistance is the ratio of the driving potential to the corresponding transfer rate. The driving potential for heat transfer through the tank is the outside surface temperature inside fuel temperature, $(T_i - T_s)$. Thermal resistance for conduction through multi-layered insulation (MLI) is modeled as follows:

$$R_{Fuel} = \frac{1}{h_{Fuel} \cdot A}, R_A = \frac{L_A}{k_A \cdot A}, R_F = \frac{L_F}{k_F \cdot A} \quad (9-11)$$

Where h is the convection heat transfer coefficient, k is the thermal conductivity and L is the wall thickness.

Equivalent thermal resistance through tank wall:

$$R_{EQ} = R_{Fuel} + R_A + R_F \quad (12)$$

The resulting conductance equation is as follows:

$$Q_{Cond} = \frac{(T_s - T_i)}{R_{EQ}} \quad (13)$$

A visual model of the tank wall and the corresponding resistance is seen below.

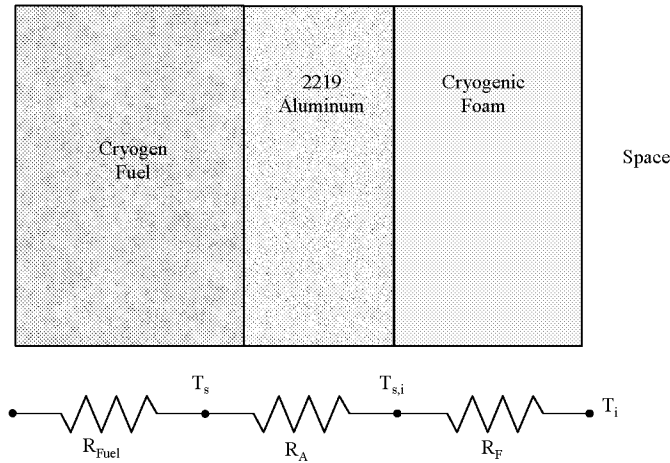

Figure 5: Equivalent thermal circuit for a series resistance wall of the Delta IV Tank

BOILOFF

The description for the rate at which energy is stored in the system is in terms of the temperature increase in the fuel and tank wall. This phenomenon occurs succeeding the radiation transfer due to small transport delays. Once the inner surface of the tank, T_s , changes the results are directly related to the changing temperature in the fuel, through natural convection heat transfer. The nucleate pool boiling equation to evaluate the heat transfer to the fuel from the tank wall is as follows:

$$q_s = A\mu_l h_{fg} \left[\frac{g(\rho_l - \rho_v)}{\sigma} \right]^{\frac{1}{2}} \left(\frac{c_{pl} \Delta T_e}{C_{sf} h_{fg} Pr_l^n} \right)^3 \quad (14)$$

Where A is area, C_{sf} is the coefficient for surface tension combination, C_p is the specific heat at constant pressure, g gravity at lower earth orbit, h_{fg} latent heat of vaporization, Pr_l is the Prandtl number, μ is the Viscosity, ρ is density of liquid fuel and σ is the Stefan-Boltzman constant.

Once the boiling heat transfer rate has been determined, assuming temperature and surface area does not change, all heat addition to the tanks will result in raising the temperature and or boiloff. Determination of the boiloff rate is accomplished using Eq. 15.

$$m_{b,\dot{}} = \frac{q_s}{h_{fg}} \quad (15)$$

q_s is the boiling heat transfer rate and latent heat of vaporization.

MODELS

As mentioned this paper addresses three different types of models, abacus tail feather concept, four wing concept and spinner concept. Each of the three concepts possesses certain similar

thermal characteristics. All three of the concepts are based on construction of Delta IV Boeing rocket tanks. Thus, the thermal properties and geometry of the tanks are the same. In addition to the thermal and geometric similarities of the concepts, a thermal shield is used with each design.

The shield and the sun combined are assumed to cover approximately 50% of the total area of the fuel tanks, while the remaining 50% of the surface area is exposed to either the earth or space. The ratio of sun-exposed area to the shaded area depends solely on the area of the tank in direct sunlight. For example, if the sun hits 10% of the total area, the shield will shade the remaining 40%. This is true for the abacus and four wing concepts. An exception, however is the spinning concept, for which the amount of sunlight is dependent on rotation period of the tanks.

The abacus concept has three tanks situated at the bottom of the thermal shield. The shield will cover each tank for a portion of the time in orbit. Forty-percent of the orbit time is spent in the shadow of the earth and the remaining sixty-percent of the time is a constant exposure to sunlight. The percentage of exposure can vary from 2% to 50% of the total area of the tanks. Naturally, the less time in the sun the lower the heat gains.

The spinner concept also consists of three tanks. The tanks are attached to a central hub located beneath the thermal shield. The tanks are spun for cooling and fluid collation purposes. The spin rate of the tanks to this point is not valued; however, an assumed value is used here for calculation purposes. This value is calculated as follows

Acceleration due to spinning is:

$$a = \omega^2 \cdot r = \omega \times \omega \times (-\bar{r}) \quad (16)$$

Solving for get an effective artificial gravity of 1/4 g gives:

$$\omega = \sqrt{\frac{5\% \cdot g}{r}} \text{rad / sec} \quad (17)$$

Thus the total rotation speed for the system is:

$$T_{rotational} = \frac{60}{\frac{2 \cdot \pi}{\omega}} \text{Hz} \quad (18)$$

The tail feather / gravity gradient concept uses a series of arrays mounted on the system. Even if the solar cells double as a thermal shield, it will not likely cover a large enough area to effectively block the sun's radiation heat.

RESULTS

The gravity gradient is surprisingly the design with the most massive thermal penalties. The spinner concept proved to be the best design for reducing mass boiloff in a passively cooled system. The abacus and spinner concepts were compared directly using the same time in equatorial orbit, and altitude. In addition, the concepts varied exposure to the sun from 2% to 50% of the total surface area. However, the spinner concept had an opportunity to cool the tanks during the period of rotation in the shade while the abacus and gravity gradient did not.

From figure 5 the heating time from the fusion temperature to vaporization temperature is shown for the three concepts for different sun exposed surface areas. The spinner concept is the best for the majority of the time, however the abacus method the better for the smaller exposed surface area. And the tail feather concept is better for the greatest exposed surface area.

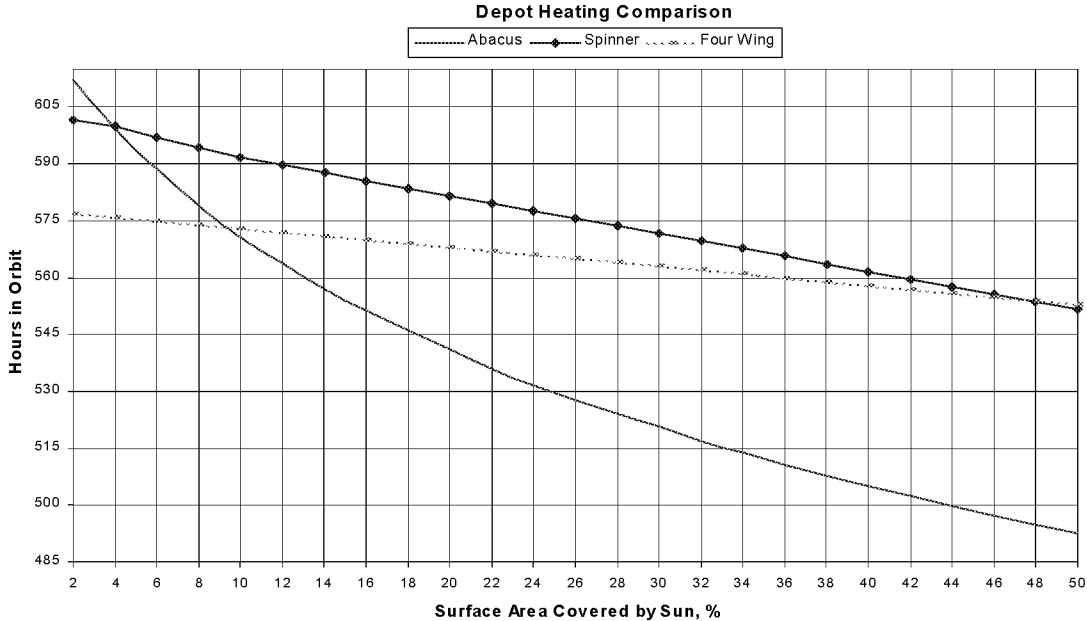

Figure 6: Fuel depot heating comparison chart. At any given sun exposed surface percentage the heating time from fusion temperature to vaporization temperature is known.

The analysis of boiloff rates for the three designs showed some staggering results. The spinner concept is by far the best design thermally of the three proposed, followed by the abacus concept and, last, the gravity gradient concept. The abacus concept had a boiloff amount of 119 times greater than the spinner concept for 450 orbits. From this analysis it is apparent that a system of these types cannot exist with passive cooling in orbit, active cooling must be employed.

CONCLUSION

Consideration must be taken for the energy balance using the first law of thermodynamics. In the design of cryogenic storage the minimum boiloff rates of systems in LEO should be optimized. Several recommendations for making this project work effectively are:

1. Increase the insulation thickness on the Delta IV tanks. Do not shave any off for weight considerations; allow the insulation system to be the payload itself,
2. Decrease the time the fuel depot spends in the sun while subsequently increasing the thermally shielded surface
3. Attach an active cooling system to reduce the effective boiloff

4. Use the boiloff gasses to cool the thermal shield, cooling the tank surface and possibly, use to cool the MLI
5. Use a spherical storage; surface tension dictates that a body of fluid neutrally floating in a gas will assume the smallest shape possible. Thus a spherical tank has the smallest effective surface area.
6. Design the system such that it has low conductive structural supports.

ACKNOWLEDGEMENTS

I would like to thank the Summer Faculty program at NASA/MSFC for funding this research.

REFERENCES

1. Dorsey, J. W. and Kleder C. L.: "Thermal Mass Penalties associated with Cryogenic Propellant Storage on Manned Mars and Venus Missions, Propulsion and Thermodynamics Department", Conference on Long-Term Cryo-Propellant Storage in Space, pp1-29, October 1966.
2. Knoll, R. H., Bartoo, E. R. and Boyle, R. J., "Shadow Shield Experimental Studies, Lewis Research Center, Conference on Long-Term Cryo-Propellant Storage in Space", October 1966, pp 83-93.
3. Fendell, F. E., "Heat Transfer to Rotating Cryogenic Fuel Tanks in Orbit, TRW Systems, Conference on Long-Term Cryo-Propellant Storage in Space" pp 195-211, October 1966.
4. Kittel, P. NASA Ames Research Center Moffet Field, CA and Parmley, R. T., Lockheed Palo Alto Research Laboratory, Palo Alto, CA., "Long Term Cryogen Storage in Space: A Feasibility Study", 679-686, 1996.
5. Anderson, J. E., Fester, D. A. and Czysz, P. M., "Evaluation of Long-Term Cryogenic Storage System Requirements", Martin Marietta Space Systems, Denver, CO., Advances in Cryogenic Engineering, Vol 35, pp 1725-1731, 1988.
6. Beduz, C., Rebiai, R. and Scurlock, R. G., Institute of Cryogenics University of South Hampton, South Hampton, UK, "Thermal Overfill, and the Surface Vaporization of Cryogenic Liquids Under Storage Conditions", pp 795-803, 1981.
7. Gursu, S., Sherif, S. A., Veziroglu, T. N. and Sheffield, J. W., "Optimizing Liquid Hydrogen Storage Systems", 13th Canadian Congress of Applied Mechanics, pp 540-541, 1991.
8. Cunningham, G. R., "Thermodynamic optimization of a Cryogenic Storage System for Minimum Boiloff", American Institute of Aeronautics and Astronautics, 1982

9. Harrison, J. K., "Thermal Characteristics of a Storage Vessel on the Moon", NASA-N-D-3785, 1967.
10. Incropera, F.P. and DeWitt, D.P., Fundamentals of Heat and Mass Transfer, 1990, John Wiley & Sons.

NOMENCLATURE, ACRONYMS, ABBREVIATIONS (STYLE=PAPERHEADINGS)

A	area, m^2
a	absorbivity of the fuel tanks
C_{sf}	coefficient for surface tension combination
C_p	specific heat at constant pressure, $J/kg \cdot K$
e	emissivity of the fuel tanks $W/m^2 \cdot K$
g	gravity at lower earth orbit, m/s^2
h_{fuel}	convection heat transfer coefficient
h_{fg}	latent heat of vaporization, J/kg
k_A	thermal conductivity, $W/m \cdot K$
L_F	thickness of insulation, m
\dot{m}	mass boiloff rate, kg/sec
n	exponent for surface tension combination
Orbit	number of orbits in analysis
P_r	Prandtl number
Q	overall heat delivery to the system, W
q	Radiation constant, W/m^2
R	Resistance
T	Temperature, K
μ	Viscosity, $kg/s \cdot m$
ρ_l	density of liquid fuel, kg/m^3
ρ_g	density of gaseous fuel, kg/m^3
σ	Stefan-Boltzman constant, $W/m^2 \cdot K^4$