

NASA/CP—2002-211845

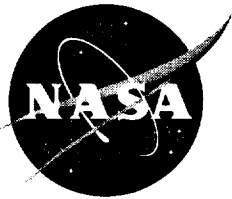

# **Virtual Airspace Modeling and Simulation (VAMS) Project First Technical Interchange Meeting**

*Prepared by Computer Sciences Corporation*

*Recording Secretaries:*

*Robert Beard*

*Robert Kille*

*Richard Kirsten*

*Paul Rigterink*

*Henry Sielski*

*Edited by: Melinda F. Gratteau, Raytheon ITSS*

Proceedings of a technical interchange  
meeting sponsored by the  
National Aeronautics and Space  
Administration and held at  
NASA Ames Research Center  
Moffett Field, California  
May 21-23, 2002

---

July 2002

## The NASA STI Program Office ... in Profile

Since its founding, NASA has been dedicated to the advancement of aeronautics and space science. The NASA Scientific and Technical Information (STI) Program Office plays a key part in helping NASA maintain this important role.

The NASA STI Program Office is operated by Langley Research Center, the lead center for NASA's scientific and technical information. The NASA STI Program Office provides access to the NASA STI Database, the largest collection of aeronautical and space science STI in the world. The Program Office is also NASA's institutional mechanism for disseminating the results of its research and development activities. These results are published by NASA in the NASA STI Report Series, which includes the following report types:

- **TECHNICAL PUBLICATION.** Reports of completed research or a major significant phase of research that present the results of NASA programs and include extensive data or theoretical analysis. Includes compilations of significant scientific and technical data and information deemed to be of continuing reference value. NASA counterpart of peer-reviewed formal professional papers, but having less stringent limitations on manuscript length and extent of graphic presentations.
- **TECHNICAL MEMORANDUM.** Scientific and technical findings that are preliminary or of specialized interest, e.g., quick release reports, working papers, and bibliographies that contain minimal annotation. Does not contain extensive analysis.
- **CONTRACTOR REPORT.** Scientific and technical findings by NASA-sponsored contractors and grantees.
- **CONFERENCE PUBLICATION.** Collected papers from scientific and technical conferences, symposia, seminars, or other meetings sponsored or co-sponsored by NASA.
- **SPECIAL PUBLICATION.** Scientific, technical, or historical information from NASA programs, projects, and missions, often concerned with subjects having substantial public interest.
- **TECHNICAL TRANSLATION.** English-language translations of foreign scientific and technical material pertinent to NASA's mission.

Specialized services that complement the STI Program Office's diverse offerings include creating custom thesauri, building customized databases, organizing and publishing research results ... even providing videos.

For more information about the NASA STI Program Office, see the following:

- Access the NASA STI Program Home Page at <http://www.sti.nasa.gov>
- E-mail your question via the Internet to [help@sti.nasa.gov](mailto:help@sti.nasa.gov)
- Fax your question to the NASA STI Help Desk at (301) 621-0134
- Telephone the NASA STI Help Desk at (301) 621-0390
- Write to:  
NASA STI Help Desk  
NASA Center for AeroSpace Information  
7121 Standard Drive  
Hanover, MD 21076-1320

NASA/CP—2002-211845

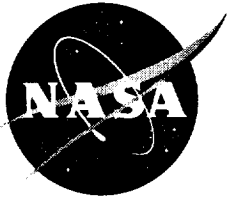

# **Virtual Airspace Modeling and Simulation (VAMS) Project First Technical Interchange Meeting**

*Prepared by Computer Sciences Corporation  
550 Weddell Drive, Suite 7, Sunnyvale, CA 94089*

*Recording Secretaries:*

*Robert Beard*

*Robert Kille*

*Richard Kirsten*

*Paul Rigterink*

*Henry Sielski*

*Edited by: Melinda F. Gratteau, Raytheon ITSS  
NASA Ames Research Center  
Moffett Field, CA 94035-1000*

Proceedings of a technical interchange  
meeting sponsored by the  
National Aeronautics and Space  
Administration and held at  
NASA Ames Research Center  
Moffett Field, California  
May 21-23, 2002

National Aeronautics and  
Space Administration

NASA Ames Research Center  
Moffett Field, California 94035-1000

---

July 2002

Available from:

NASA Center for AeroSpace Information  
7121 Standard Drive  
Hanover, MD 21076-1320  
301-621-0390

National Technical Information Service  
5285 Port Royal Road  
Springfield, VA 22161  
703-605-6000



# Virtual Modeling and Simulation (VAMS) Project

## Technical Interchange Meeting Number 1

### Table of Contents

Preface

Agenda

1	Welcome	Jacobsen
2	VAMS TIM	Swenson
3	SLIC Sub-element	Fong
4	VAST Sub-element	Romer
5	SEA Sub-element	Lozito
6	ATM Conops and their Impact on the NAS	MacKenzie
7	System Level Capacity Increasing Concept	Schwab/Sipe
8	Technologies Enabling All-Weather Maximum Capacity by 2020	Krozel
9	Massive PTP and On-Demand ATS Investigation	Sorensen
10	Optimization in the National Airspace System	Sridhar
11	Daily Agenda Questions and Comments	Swenson
12	Capacity Improvements Through Automated Surf. Traffic Control	Capozzi
13	Surface Operations Automation Research	Cheng
14	Centralized Terminal Operation Control	Fergus
15	Terminal Area Capacity Enhancement Concept	Arkind
16	Langley Wake Vortex Research Supporting VAMS	Rutishauser
17	Advanced Airspace Concept	Erzberger
18	An approach to Technology Roadmaps	Weathers
19	University Concept Team Draft Report	Zellweger
20	Breakout Session No. 1 – Technology Roadmaps	Facilitators <sup>1</sup>
21	AATT: Distributed Air Ground Traffic Management (DAG-TM)	Mogford
22	Daily Agenda Questions and Comments	Swenson
23	Breakout Session No. 2 – Metrics/Scenarios	Facilitators <sup>1</sup>
24	Breakout Session No. 3 – Guidelines	Facilitators <sup>1</sup>
25	VAST Prototype Demonstration	Roth/Miraflor
26	Socio-Economic and Demand Forecasting	Cavolowsky
27	Next Steps in Concepts and a Preview of TIM 2	Swenson
28	Summary of Recommendations for Future TIMS	CSC

Appendix A: Acronyms

Appendix B: Attendee List

Appendix C: Presentations

<sup>1</sup> Corker, Del Balzo and Van Lamingham

This page intentionally left blank.

## PREFACE

A three-day NASA Virtual Airspace and Modeling Project (VAMS) Technical Interchange Meeting (TIM) was held at the NASA Ames Research Center in Mountain View, CA, on May 21 through May 23, 2002. The purpose of this meeting was to share initial concept information sponsored by the VAMS Project. An overall goal of the VAMS Project is to develop validated, blended, robust and transition-able air transportation system concepts over the next five years that will achieve NASA's long-term Enterprise Aviation Capacity goals. This document describes the presentations at the TIM, their related questions and answers, and presents the TIM recommendations.

This TIM provided a forum for concept developers to discuss their proposals with each other and with the modeling and simulation elements of the project. The objective was to present a level of detail that is fully equivalent to that found in technical proposals and related work. For those TIM participants discussing a specific operational concept, this level of detail meant exchanging information equivalent to their NRA proposed operational concept guideline topics.

Breakout meetings, separate from the concept discussions, were held on concept guidelines, metrics and operational scenarios and technology roadmaps. The purpose of the breakout meetings was to achieve a common and consistent view of these critical topics by leveraging the experience and expertise of the TIM participants. After each breakout session a special topic was discussed, these included NASA's work on the Distributed Air Ground concepts (DAG), the Virtual Airspace Simulation Technologies (VAST) modeling system prototype and the initial socio-economic and demand forecasting effort. The purpose of these special topics was to convey information about related work that may impact the concepts.

This page intentionally left blank.



**TIM #1 Agenda**

PST	21-May Tuesday	22-May Wednesday	23-May Thursday
7:30	Facility opens and Meeting Registration	Facility opens	Facility opens
7:45		<b>Daily Agenda</b>	<b>Daily Agenda</b>
8:00			
8:15	<b>NASA Welcome (Jacobsen)</b>	Automated Airport Surface Traffic Control <i>Metron</i>	Breakout #2: <b>Metrics/Scenarios</b> (3 separate parallel sessions)
8:30		Surface Operation Automation Research <i>Optimal Synthesis</i>	
8:45		Centralized Terminal Operation Control <i>Northrop Grumman</i>	
9:00	VAMS Project overview (Swenson)	Break	Break
9:15	SLIC Sub-element overview (Fong)		
9:30	Break	Air Transport System Capacity Increasing Concept <i>Raytheon</i>	<b>Breakout report writing #2 with a parallel special topic -- VAST Prototype</b>
9:45		Wake Vortex Avoidance Concept (Rutishauser)	
10:00	VAST Sub-element overview (Romer)	Advanced Airspace Concept (Erzberger)	Report on Breakout #2
10:15		Catered Lunch in Patio Room	Catered Lunch in Patio Room
10:30			
10:45	SEA Sub-element overview (Lozito)	An Approach to Technology Roadmaps (Weathers)	Breakout #3: <b>Guidelines</b> (3 separate parallel sessions)
11:00	Federal Aviation Administration (MacKenzie)		
11:15	Catered Lunch in Patio Room	University Concepts (Zellweger)	Break
11:30			
11:30	System Level Capacity Increasing Concept <i>Boeing</i>	Breakout #1: <b>Technology Roadmaps</b> (3 separate parallel sessions)	Breakout report writing #3 with a parallel special topic -- <b>Business Modeling</b>
11:45			
12:00	Technologies Enabling All-Weather Max. Cap. By 2020 <i>Metron</i>	Break	Report on Breakout #3
12:15	Break		
12:30	Massive PTP & On-Demand ATS Invest. <i>Seagull Tech.</i>	<b>Breakout report writing #1 with a parallel special topic -- Distributed Air Ground</b>	Next Steps in Concepts and a Preview of TIM 2
12:45			
1:00	System Wide Optimization (Sridhar)	Report on Breakout #1	
1:15	Special Breakout Session: <b>Facilitator/Recorder Meeting</b> (others adjourn for day)	Breakout report writing #1 with a parallel special topic -- <b>Distributed Air Ground</b>	Next Steps in Concepts and a Preview of TIM 2
1:30			
1:45	Break	Breakout report writing #1 with a parallel special topic -- <b>Distributed Air Ground</b>	Next Steps in Concepts and a Preview of TIM 2
2:00			
2:15	Special Breakout Session: <b>Facilitator/Recorder Meeting</b> (others adjourn for day)	Breakout report writing #1 with a parallel special topic -- <b>Distributed Air Ground</b>	Next Steps in Concepts and a Preview of TIM 2
2:30			
2:30	Break	Breakout report writing #1 with a parallel special topic -- <b>Distributed Air Ground</b>	Next Steps in Concepts and a Preview of TIM 2
2:45			
3:00	Special Breakout Session: <b>Facilitator/Recorder Meeting</b> (others adjourn for day)	Breakout report writing #1 with a parallel special topic -- <b>Distributed Air Ground</b>	Next Steps in Concepts and a Preview of TIM 2
3:15			
3:30	Special Breakout Session: <b>Facilitator/Recorder Meeting</b> (others adjourn for day)	Breakout report writing #1 with a parallel special topic -- <b>Distributed Air Ground</b>	Next Steps in Concepts and a Preview of TIM 2
3:45			
4:00	Special Breakout Session: <b>Facilitator/Recorder Meeting</b> (others adjourn for day)	Breakout report writing #1 with a parallel special topic -- <b>Distributed Air Ground</b>	Next Steps in Concepts and a Preview of TIM 2
4:15			
4:30	Special Breakout Session: <b>Facilitator/Recorder Meeting</b> (others adjourn for day)	Breakout report writing #1 with a parallel special topic -- <b>Distributed Air Ground</b>	Next Steps in Concepts and a Preview of TIM 2
4:45			
5:00	Special Breakout Session: <b>Facilitator/Recorder Meeting</b> (others adjourn for day)	Breakout report writing #1 with a parallel special topic -- <b>Distributed Air Ground</b>	Next Steps in Concepts and a Preview of TIM 2

This page intentionally left blank.

# 1.

## **NASA Welcome to the Virtual Airspace Modeling and Simulation Project Technical Interchange Meeting No. 1**

**Mr. Robert Jacobsen**

**Director, Airspace Systems Program, NASA Ames Research Center**

A copy of Mr. Jacobsen's presentation is attached as part of the appendix and is available on the Web site.

Dr. Victor Lebacqz gave the introduction and welcome to the first technical interchange meeting (TIM) of the Virtual Airspace Modeling and Simulation (VAMS) project. He indicated that the VAMS efforts will be the baseline for the start of the next 10 or more years of work in capacity improvements.

### **Key Comments by Mr. Jacobsen**

#### **NASA's Aerospace Technology Enterprise (Slides 2 – 3)**

An increase in the capacity of the national airspace system (NAS) is mandatory in order for the system to handle the passenger demands that are projected over the next 25 years. The Airspace Systems Program (ASP) has identified a set of goals based on projections of annual passenger enplanements. These goals include doubling the capacity of the aviation system within 10 years and tripling the capacity within 25 years. Intercity transportation time will be reduced by half in 10 years and two-thirds in 25 years. Long-haul transcontinental travel time will be reduced by half in 25 years. Mr. Jacobsen indicated that VAMS is the most important project the country is working on in this area.

#### **Airspace Systems Goals and Objectives (Slide 4)**

The ASP is required to develop "revolutionary operations systems and vehicle requirements" to meet these goals. "Vehicle requirements" mandate that we develop operations concepts using Short Takeoff and Landing aircraft (STOL) and Vertical/Short Takeoff and Landing (VSTOL) aircraft systems to make better use of existing facilities, rather than the aircraft themselves. Initial development of these concepts was part of an earlier ASP [the Short-Haul Civil Tilt-rotor (SHCT) project].

#### **FAA Operational Evolution Plan (OEP) (Slides 5 – 6)**

The FAA has an OEP approved by the Secretary of Transportation and endorsed by the RTCA. This plan represents the national policy for NAS modernization. OEP support is important to the program, but the degree of capacity improvement in the OEP falls short of what will be needed. The necessity for new operational concepts for the future has led to VAMS and its System-Level Integrated Concepts (SLICs).

## **Airspace Systems Projects and Roadmap (Slides 7 – 9)**

VAMS is the starting point for defining and developing ideas on the direction for the future. The VAMS project will build on previous or current ASPs, which include the following:

- Terminal Area Productivity (TAP) (1994 – 2000), which developed AVOSS technology and that will now will be brought into VAMS to turn it from a “technology” project to a system concept (WakeVAS)
- Short Haul Civil Tilt-Rotor (SHCT) (1994 – 2001), an aircraft technology project, whose data need to be used to develop new aircraft operations concepts
- Airspace Operations Systems (AOS) Base project, the basic Human Factors project
- Advanced Air Transportation Technologies (AATT) (1996 – 2004)
- Small Aircraft Transportation System (SATS) (2001 – 2005), which is new in ASP and will be the focus of point-to-point (PTP) concepts

Concept of operations research is not in the VAMS name, but it is the most important part of the VAMS effort. Congress is verbally supportive but wants to see something concrete before providing real support. VAMS will develop the vision for the future.

### **Synopsis of Questions and Answers for Mr. Jacobsen**

There were no questions or comments for Mr. Jacobsen from the NASA research announcement (NRA) participants.



## 2.

### **Virtual Airspace Modeling and Simulation Technical Interchange Meeting**

**Mr. Harry N. Swenson  
VAMS Project Manager, NASA Ames Research Center**

A copy of Mr. Swenson's presentation is attached as part of the appendix and is available on the Web site.

#### **Key Comments by Mr. Swenson**

##### **Introduction (Slides 1 – 3)**

This meeting is a TIM not a workshop. For the purpose of Ames' Legal office this TIM is a closed meeting; participants and companies signed nondisclosure agreements, contracts or Space Act Agreements to participate. Open exchange of information is desired. The VAMS NRA contracts, Space Act agreements, and any other method to get the project goals accomplished will be used to bring participants to the project. This agreement to share and blend ideas will be critical to the success of the project and for the Aviation community at large.

We're looking for a vision of the future in operational concepts and we are planning to utilize NASA and other's (FAA/RTCA) concepts to do this. NRA participants are expected to provide a significant contribution to operations concepts. We need to develop a view of the future that links NASA and the FAA far-term visions. This includes development of the National Airspace System modeling and simulation tools, along with evaluation methods and techniques, to help us understand how these concepts can be put into operations over time and an with the understanding of their benefits, limitations and costs. The three pillars of VAMS which form the vision of the project are: Modeling and Simulation Tools; Evaluation Methods and Techniques; and Operational Concepts.

The remainder of this briefing will discuss project description, project management, project schedule, and an overview of the TIM, its objectives and agenda.

##### **A View of the Current System (Slides 4 – 6)**

I will describe my view of today's baseline air transportation system (ATS) operations. Today's ATS operations concept starts with an airplane at a gate and a dispatcher giving him a request to fly the aircraft (passengers and/or cargo) from its location (gate) to its destination (gate) in a specified period of time. Then the aircraft asks for clearance from a controller in a tower to achieve this request and it then progresses through the surface operation to the takeoff phase. Today, this is all done through voice directions from dispatch, to the pilot and back to the controller, with the pilot and controller using just their eyes as sensors. The takeoff phase is the stage at which advanced technology starts being used (radars,

etc.). The aircraft then moves through one or perhaps several controllers as it enters and leaves the terminal phase into the en route airspace. The aircraft climbs and enters en route airspace, going through many sectors and perhaps many centers. Each handoff requires voice interaction between the pilot and a controller. The aircraft then starts its descent phase back into a terminal environment, talking to controllers and then finally to the surface again. The taxi surface phase occurs when the flight plan is cleared. After the pilot talks to the dispatcher, they begin their next adventure. Again, this is my view of the ATS.

As an example, a flight (Swenson's usual flight to NASA headquarters) from San Francisco to Dulles passes through 35 sectors in a single flight:

- Six surface and terminal departure sectors
- Twenty-three en route sectors
- Six arrival sectors

At each stage of this flight a request has to be made to transition each of these sectors along with the generation of permission to proceed. Now this example is for a single aircraft, but the daily operations of 5000+ aircraft simultaneously is a very complex scenario. The possible implication is that with the required amount of coordination, and the large number of control structures to support them in the current ATS, may be causing the system to become highly inefficient and overly complex. On the other hand, with all the necessary checks and balances it is very safe.

The new concepts must support *known* as well as *unknown* demands.. Since many flights encounter off-nominal conditions in the routine of a 24 by 7 operation, these advanced concepts must be tested against off-nominal conditions. The most noteworthy example is September 11, 2001. (Video of FACET/ETMS playback of September 11<sup>th</sup> shutdown of the NAS is shown). The shutdown of the NAS is just one of the off nominal conditions that our current ATS handles, and one which must be handled by any future system.

### **VAMS Project Goals and Issues (Slides 7 – 9)**

VAMS is required to provide new models and simulations to provide the safe investigation of new concepts and technologies. The current process for conceptual and technological introduction into the NAS includes extensive and expensive real-time simulation and field testing, but the process is limited in the complexity of analysis it can support. Typically, we simulate our technologies using the feedback of one to four controllers, where the concept or technology can have impact on hundreds of controllers or aircraft. VAMS will try to extend the number of controllers' actions that can be used to evaluate, via simulation, the real impact of advance concepts and technologies. The VAMS project was given enough money to think and analyze, but not enough to develop technologies other than those necessary to model or simulate the airspace system.

New operational concepts need to be explored in relation to the following:

- Benefits, risks, and limits

- Infrastructure requirements
- Transitional strategies for operations and infrastructure

We need to start developing the advanced concepts today. This will lead to developing technology roadmaps for R&D as well as transition. In addition, we need to determine how our ideas will address limits, i.e., infrastructure challenges to achieve NASA’s long-term performance goals (three times enplanements, twice the mobility).

A good way to understand this requirement is to look at historical demand. The propagation of existing enplanement data into the future supports the goals to achieve three times capacity for the NAS in the 2020’s. There is also a direct relationship between the speed of the transportation system and the economic growth it supports. If we wish to continue the long-term economic growth that is attributed to the quick and expeditious movement of people and goods, then we need to find ways to increase the capacity of the NAS. We were questioned in the days following September 11<sup>th</sup> as to why we’re starting VAMS now. Couldn’t we wait a couple of years? Data shows that in the past, demand has leveled off at times (as in our current crisis) but there has always been a rebound that is followed a steady growth in delays.

There are several issues that this project is addressing. The NAS is on the verge of gridlock and this will have severe negative impacts on our economy and mobility. New concepts are needed to meet the future capacity demands. Substantial change is needed to NAS operations. What we are doing is focusing this project beyond the current path of development (i.e., over the next 5-7 years) — looking beyond 2010 to 2020. A substantial change in the system requires substantial improvement to the tools. This implies a revolutionary approach (concept) and the ability to model, simulate, and evaluate these tools and concepts in the NAS as a whole. In other words, we need to develop a “seamless digital airspace” as described in the NASA Blueprint for Aviation.

### **VAMS Project Overview (Slides 10 – 13)**

We know that there are existing models that need to be pulled into an extensible architecture. There is also a need for improved models, which are more encompassing in nature. A need also exists to validate a tool set developed as part of this effort.

Three major project goals exist:

1. Validate a tool set based on existing ATS concepts.
2. Evaluate and assess a revolutionary integrated operational concept based on validated tool set.
3. Develop a technology roadmap to implement the advanced concept.  
This is really the project’s major deliverable.

The terms and definitions we’ve been using within VAMS are consistent with the way the has FAA described the evolution of the NAS operational concept for a

number of years. Definitions how here are: Operational Concept; Modeling; Simulation; Real Time; and Non Real Time. Operational Concept definition addresses the functions required in an ATS. The future system will have to address all the functions that the current air transportation system addresses. How VAMS functions are implemented may change over time, and we will need to be aggressive to meet future needs (i.e., adding new, more aircraft). We need to establish a functional link between the current FAA OEP-oriented approach and this future-oriented program that looks backwards from the performance needs of the future. Modeling and simulation definitions are pulled very nearly from Webster's. The real-time is a special qualifier on simulation that is needed to support the human-in-the-loop (HITL) experiments. Non-real-time simulations can be faster or slower than real world, usually to support Monte-Carlo approaches to analysis.

The VAMS technical process describes, "how we're going to do it." Within this process, we are defining and analyzing operational concepts and scenarios using the taxonomy you'll hear more about later from Rob Fong. We need to analyze these with policy goals and socio-economic models. We are also developing a modeling environment. This environment will start out low fidelity and non-real-time, but will evolve to high fidelity and real-time over the next few years. We need to do this keeping in mind our three project goals. This process of developing concepts and using our modeling environment to evaluate them and the development of our roadmaps is an iterative one. It will be cycled at least twice with an integration step over the next five to six years.

There are lots of technical challenges. (The technical challenges for each of the three VAMS areas – Modeling and Simulation; Evaluation and Assessment; and Operations Concept and Analysis - in slide 10 were discussed.) Operations Concept and Analysis, the focus of this TIM, centers on figuring out how to develop operational concepts that will achieve NASA's Enterprise goals (e.g., the three times the emplanements). Seamless integration of all the concepts and tools to be developed requires people meeting and working together. We need to answer how we will accomplish the Enterprise goals using analysis of operational concepts developed and their supporting technologies. As a result, we will bring together and evaluate various operational concepts, that are expected to result in a "best of breed."

### **Future Concepts (Slides 14 – 17)**

A goal of the VAMS project is to break down barriers across all airspace domains (strategic, regional, and tactical) for "seamless operation and reduced constraint." The use of predictive aircraft trajectory knowledge of the future to break down the barriers, is an extension of what we've been trying to accomplish with AATT, OEP, and free flight phase 1 (FFP1).

In the next 2-3 years we, as part of VAMS, will develop and assess the new concepts. We'll have to develop tools to assess these new concepts and define the "goodness of being seamless" as part of this project. Mr. Tom Romer will

provide details of the system tools approach for the airspace concept evaluation in one of the next briefings.

Major steps include the following:

1. Requirements
2. Gap analysis and validations
3. Extension: a major extension of models—adding the real-time aspect

A library of models and an open architecture will be created for expansion of the project into the community, so its members can participate in an evaluation of concepts. We will also provide access to simulation and laboratory capability to increase the fidelity of the “best” concepts. Annual software builds and an incremental increase in capability will also be built into the project.

### **VAMS Project Summary, TIM Objectives (Slides 18 – 23)**

VAMS will not deviate from project goals (the project deliverables are restated). Annual updates to all the products associated with meeting these goals (including annual builds of the modeling system) will be produced. Accomplishing these goals requires us to do many jobs in parallel. You can see by looking at the VAMS Roadmap (a linearized version of the VAMS Process chart), that this is a complex project. Parallelism of elements increases development speed, but challenges development integration. We’re identifying concepts, scenarios and metrics to meet the long-range goals of the Enterprise. The early focus will be on requirements, definition, and non-real-time simulation and later on real-time experiments. Facility integration isn’t important until later when we get to the large real-time experiments necessary to validate our integrated concepts.

We want to look to the future and define real-time experiments that extend what we are currently able to do. We know how to do simulations with small numbers of pilots and controllers. Our goal is to be able to simulate the actions of a large number of controllers, increase fidelity by adding larger numbers of aircraft and facilities, and validate the advanced concepts we develop. As we progress over time on VAMS, we want be able to do NAS wide simulations first in non-real-time and later, if required, with as many real-time attributes as required to understand the critical interactions of the humans within the NAS. We can then feed the results of these experiments back to the concept developers, who can use the later builds of the tools to evaluate them. The final activity at the end of the roadmap is an evaluated, integrated system-wide concept of operations that NASA can be proud of, and which is consistent with the project’s interpretation of the OMB and NASA management guidance.

As seen from this organization chart, VAMS is a large, distributed project. (Identification of Harry as project manager, Del Weathers as deputy, administrative support plus Project Level 3 leaders.)

One of this TIM’s objectives is to integrate and begin to organize the project to help manage it across multiple NASA centers and organizations: Ames Research Center (ARC), Langley Research Center (LaRC), and Glenn Research Center

(GRC), along with our FAA and DOT collaborators. This is a programmatic constraint of the project. VAMS is following the contracting guidance of NASA Headquarters that specifies approximately 70 percent of its resources will be contracted to the US aerospace industry and universities. To facilitate coordination, all participants will meet twice a year. At this TIM we're going to discuss the initial air transportation system concept definitions that we acquired via the out NRA's. There were numerous proposals and we selected the best concepts via this fair and open competition. I congratulate the awardees and welcome them aboard. There are also three items we've been struggling with, which are the focus of the breakout sessions we have scheduled during this TIM: initial technology roadmap definition; initiation of evaluation scenarios and metric definition and development; and guideline development for concepts assessment. In particular, we have not received guidance from Headquarters on what a technology roadmap is. We hope we have the brainpower here to help us determine what we will need to develop in this regard.

(Description of Agenda, along with TIM logistics is presented).

#### **Synopsis of Questions and Answers for Mr. Swenson**

There were no questions for Mr. Swenson.

### 3.

## **System-Level Integrated Concepts (SLIC) Overview**

**Mr. Robert Fong**

**Level 3 Manager, SLIC Sub-element, NASA Ames Research Center**

A copy of Mr. Fong's presentation is attached as part of the appendix and is available on the Web site.

### **Key Comments by Mr. Fong**

#### **SLIC Overview (Slides 1 – 5)**

The System-Level Integrated Concepts (SLIC) sub-element development process is introduced. This first TIM has a concept element focus and is designed to develop a common understanding of the problem, share initial concepts information among all the concept developers, and transfer concepts information to the modeling/simulation and assessment groups. The TIM will help the SLIC meet its goals, which are to 1.) develop a unified capacity-increasing concept from the concepts presented by the participants and 2.) create a technology roadmap on how to develop and implement the unified concept. This will require SLIC and participants to analyze, integrate, and synthesize the independent concepts presented in the TIM into a unified capacity-increasing system concept.

#### **Developing the Concepts (Slides 6 – 14)**

SLIC will use a broad-based system engineering approach to develop the concepts. The goal of this process is to produce mature concepts ready for blending into a unified system-level operational concept. SLIC will use a four-phased concept development approach over the next 5 years. The initial concepts were developed by six companies and also include three Government and one university concept. These concepts will be discussed in more detail later in the TIM. Note that social, economic, and political challenges exist and participants must consider cost and safety benefits as well. Also note, the interactions that will occur among the SLIC, VAST, and SEA sub-elements to exchange the necessary requirements and information to develop, in-parallel, the mutually-dependent concepts, simulation and modeling tools, and common scenario and metrics to meet the VAMS project goals

#### **Future Challenges (Slides 15 – 16)**

SLIC will assign technical monitors to each concept team and participate in TIMs twice a year to ensure necessary information is passed between concept developers. It is important to note that the groups must continue to collaborate to meet the key challenges.

### **Synopsis of Questions and Answers for Mr. Fong**

After Mr. Fong's presentation, Harry Swenson (NASA VAMS project manager), volunteered the following comments:

- This is no longer a competition. (The competition is over.)  
Companies need to focus on developing and sharing their concepts. (There will be plenty of opportunities for private companies in the implementation of the concepts.)
- Participants need to cooperate and interact in an open dialog.



## 4.

### **Virtual Airspace Simulation Technologies (VAST) Overview**

**Mr. Tom Romer**

**Level 3 Manager, VAST Sub-element, NASA Ames Research Center**

A copy of Mr. Romer's presentation is attached as part of the appendix and is available on the Web site.

#### **Key Comments by Mr. Romer**

##### **Introduction and VAST Overview (Slides 1 – 5)**

The Virtual Airspace Simulation Technologies (VAST) sub-element includes development of models and simulation capabilities to assess air transportation system concepts and technologies. Presented today will be a VAST description, VAST development approach, VAST interdependencies, VAST challenges, and a summary.

VAST provides a validated virtual airspace simulation environment to assess the integrated behavior of current and future air transportation system concepts by developing two key components: the Airspace Concept Evaluation System (ACES) - a system-level non-real-time environment, and the human-in-the-loop (HITL) real time simulation environment. The next VAMS TIM, which will occur in August, will be for VAST.

The ACES environment will be the initial focus of VAST development. ACES will be used to identify the impact of new technologies, procedures and concepts of operation on the safety, capacity, economics and security of the nation's air transportation system.

The VAST organization consists of the following sub-task managers under Tom Romer: Karlin Roth, ARC (ACES); Scott Malsom, ARC (HITL); and Steve Mainger, GRC [Communication, Navigation, Surveillance (CNS)]. In addition, Roger Remington, ARC [Human/Team Performance (HTP)] as a Level IV manager looks to Karlin Roth for guidance on modeling. The ACES work is under active development now. The HITL work is in a requirements development phase through mid-2003. The CNS modeling at GRC is just getting underway. It, and the HTP work, are scheduled for initial integration within ACES Build-3 (to occur during CY04).

The VAST development approach for airspace modeling and simulation begins with the development of ACES. This includes the system architecture and development of models to support ATM system assessments through simulation and analysis. Appropriate models and technologies developed within ACES will be transferred and leveraged within the real-time simulation environment.

## **ACES Prototype and Simulation Build Development (Slides 6 – 10)**

Current air transportation modeling and simulation systems are typically monolithic and provide limited flexibility to evaluate new concepts. ACES will be an airspace modeling toolbox designed to be flexible and expandable. Users will be able to select interactive agent-based models appropriate for their investigations. ACES development is leveraging the DOD's high-level architecture (HLA) Run-Time Infrastructure (RTI) for the architecture framework. Simulation control for the agent-based models will be provided by a simulation command and control system, and historical and generated data will reside and be collected in a data repository.

**Prototype demonstration scenario.** Demonstration of the proof-of-concept prototype occurred in February, 2002. It included federates of multiple airlines flying through en route/sectors managed by controller federates. The prototype used low-fidelity models, had 1,000 aircraft, and controllers in multiple sectors and centers. Data, including fuel usage, conflicts and near misses, were recorded to a database. A demonstration of this prototype will be conducted for the TIM participants on Thursday.

**ACES, Build-1 development.** Build-1 will establish the core architectural foundation designed for flexibility, scalability and extensibility, and will expand the initial set of models within the toolbox. In this build, efficiency will be traded for improved run-time capability. Build-1 will not include the ability to study radical system changes such as "free flight" (FF). This is due at the end of CY02.

**Build-1 simulation description.** Demonstration of Build-1 will use a scenario based on the current ATM system, with multiple federates representing functionality of the ATCSCC, ARTCCs, TRACONS, Airports, Aircraft, and AOCs. The demonstration will prove the feasibility of the development approach to capture the interactions between NAS entities.

**ACES development summary.** ACES will be developed and released in multiple Builds throughout the life of the VAMS Project. The initial build focuses on architecture development with low-to-medium model development. ACES will progress with toolbox enhancements that will add more NAS functionality at higher levels of fidelity. System and model validation will occur for each build. The timeframe for the releases will be: Build-1 at the end of CY02, Build-2 at the end of CY03, Build-3 in late CY04, and Build-4 at the end of CY05.

## **HITL Simulation (Slides 11 – 12)**

Preliminary requirements are currently being established for the design of a distributed network capability that integrates ATM simulators with real-time software models. Requirement definitions will be completed in mid-CY03. Development of the initial real-time system will progress until late CY04 and will conclude with a validation experiment. Applicable models and technologies will be leveraged from ACES and other uniquely real-time elements will be developed. Multiple facility integration will be added and tested in late CY05. Development of VAST real-time to support evaluations of future concepts will

continue through CY06 and experimental support will be provided through the end of the project.

### **Human/Team Performance Modeling (Slides 13-14)**

Human and team performance models will be defined and developed for the airspace modeling toolbox. Our current approach is to define cognitive demands, individual and team decision strategies, and to evaluate means to develop rapid reconfigurable operator models to assess new concepts. These models will be initially integrated into the toolbox in Build-3.

Two sub-modeling teams will focus on the following:

1. Human performance models and team models operating in supervisory paradigms and mixed initiative (human and automation) systems.
2. CNS modeling with focus on infrastructure requirements to support the OPCONS (Glenn Research Center is the lead on CNS modeling)

### **CNS Modeling and Simulation (Slides 15 – 16)**

Communication, navigation and surveillance modeling is being started at GRC by defining gaps and needs. Existing models and tools will be leveraged first.

The simulation concept involves identification and characterization of CNS element models for all NAS entities. An examination of all CNS interactions will then allow for development of transactions-based models. These efforts will be initially integrated into the toolbox in Build-3.

### **Conclusion and Summary (Slides 17 – 20)**

The virtual airspace simulation environment concept and philosophy of design, simply stated, is to create both non-real-time and real-time systems, with flexible and expandable architectures, that will support modular “plug and play” capabilities to select interactive models (and in the real-time system simulators) for the assessment of air transportation system concepts.

Many VAST has interdependencies with other VAMS level 3 elements. Specific inputs and outputs at each stage are required, with feedback to SEA and SLIC. Annual Build releases of all software (minimum) will occur.

VAST challenges exist. VAST will need to be able to handle concepts that push the limits of today’s simulation capability. Identifying models in use across multi-elements, multi-agency, and multi-country boundaries will be demanding. The project will need to impose some model structure standards to ensure the plug-and-play structures will cooperate. There are also process challenges. How and when do you give access to users? Early in the project? Late? As it matures, release it to the whole community? We need to gain a consensus from other modelers. Current models are internal to the lab and concept developers will initially look to NASA for development.

## **Synopsis of Questions and Answers for Mr. Romer**

After the presentation, Mr. Romer responded to questions from NRA participants as follows:

**Question:** How do you find “gaps” in modeling capability?

**Answer:** As concepts mature we will have a better picture of what needs to be modeled and we will begin to see gaps. Hopefully, future TIMs will provide a mechanism we can use. A framework for finding the gaps will need to be created.

**Question:** If we have existing models, can we bring them to the table? Or, will NASA develop all the VAMS models?

**Answer:** Tom Romer and Harry Swenson: A framework will exist to allow integration of legacy models through the Federation Object Model specification (initial version to be released by the next TIM). This specification can also be used to develop new models and form the basis for others to contribute models, both open and “proprietary” ones.

**Question:** When will you do integration between HITL and the non-real-time component?

**Answer:** The two systems are envisioned to be separate systems supporting different perspectives of assessment. They will be complementary to each other and provide feedback for improvement. The combined use of the two systems will probably occur in 2005, sometime after the release and validation of the initial real-time system.

## 5.

### **Systems Evaluation and Assessment (SEA) Overview**

**Sandy Lozito**

**Level 3 Manager, SEA Sub-element, NASA Ames Research Center**

A copy of Ms. Lozito's presentation is attached as part of the appendix and is available on the Web site.

#### **Key Comments by Ms. Lozito**

##### **VAMS Sub-Elements Relationships (Slides 2 – 3)**

The Systems Evaluation and Assessment (SEA) sub-element is new to the VAMS project. The role of SEA is to develop the methods and metrics that the VAMS project will use for evaluation of concepts. The SEA sub-element is interdependent on the SLIC sub-element and the VAST sub-element. SEA will provide scenario and metrics requirements to VAST, which will develop the models for use in concept evaluation. SEA will then test the models and provide strategies for testing to the SLIC sub-element. SLIC will provide the developed concepts to SEA for evaluation. SEA will conduct the assessment and evaluation of the selected concepts.

The SEA sub-element also has a relationship with the concept developers. The concept developers will conduct a self-assessment of their concepts using their own scenarios and metrics. The self-assessment metrics and scenarios will be provided to the SEA sub-element for use in the overall definition of scenario and metric requirements.

##### **SEA Technical Challenges (Slides 4 – 5)**

The VAMS project has identified key technical challenges in modeling and simulation, evaluation and assessment, and operational concept and analysis. SEA will focus on the evaluation and assessment technical challenges, which include defining gate-to-gate and door-to-door measurable metrics, supporting and defining appropriate scenarios, and the application of appropriate evaluation methods. Evaluation methods and techniques similar to those used in the air-ground integration experiment will be the starting point for SEA activities.

##### **SEA General Tasks and Goals (Slide 6)**

SEA will be responsible for developing the requirements for the scenarios and metrics that will drive the real-time tools created by the VAST sub-element. After these tools are developed by VAST, the SEA sub-element will conduct an evaluation assessment on the tools.

SEA will then use the VAST tools to conduct an initial assessment of the concepts submitted to VAMS. A combined or blended set of concepts is planned for Phase

4 of VAMS. SEA will use the VAST tools to conduct an initial assessment of this integrated set of concepts and the final evaluation of the selected concepts.

### **Scenario/Metric Requirements, Topics and Issues (Slides 7 – 9)**

A common set of scenarios and metrics will be developed and used to evaluate the capacity-increasing concepts of the VAMS project. SEA will be responsible for defining the requirements of this standard set of scenarios and metrics. However, it is realized that the scenarios and metrics will have to be tailor able to evaluate some concepts. The starting point for the definition of the VAMS scenarios and metrics will come from the concept developers themselves. Each concept will be required to conduct a self-assessment using a set of scenarios and metrics. These scenarios and metrics will be provided to SEA for use in developing the VAMS scenario and metrics requirements.

SEA has also developed a set of guidelines that are listed in this presentation. In addition, a set of scenario/metric questions has been developed that are the subject of this TIM's second breakout session. These guidelines, and the output from the breakout session, will be used by SEA to define the framework for the scenario and metrics development.

### **SEA General Team Members (Slide 10)**

The SEA team consists of NASA researchers along with representatives from San Jose State University, VOLPE Transportation Systems Center, Seagull Technology, Inc., and Monterey Technologies, Inc. The team is working on the scenario definitions, metrics definitions, and framework to support the sub-element.

### **Synopsis of Questions and Answers for Ms. Lozito**

After the presentation, Ms. Lozito responded to questions and comments from NRA participants as follows:

**Question:** Is there a requirement for SEA to validate the real-time tools developed by VAST?

**Answer:** Sandy Lozito: There is not a specific requirement for SEA to validate the real-time tool. The SEA group will do this implicitly through the use of the real-time tool. It is a milestone in the VAST system engineering plan.

**Question:** Will the methods and metrics developed by SEA consider the business case as a stakeholder? How much of the business side will VAMS consider?

**Answer:** Harry Swenson: There has been some delving into the business case that has already been started by concept developers. There will be a need to have limits put on the business-related issues addressed by VAMS.

**Question:** Will the new models be validated against the 1997 baseline of concepts?

**Answer:** Yes, they will be validated both for non-real-time and real-time model evaluation (a challenge).

6.

**Air Traffic Management Concept of Operations and Their Impact  
on the National Airspace System (NAS)**

**Wayne MacKenzie**  
**FAA/ATP-401, Deputy Air Traffic Planning Division**  
**Member Nominated by the US on the ICAO Air Traffic Management**  
**Operational Concept Panel (ATMCP)**

A copy of Mr. MacKenzie's presentation is attached as part of the appendix and is available on the Web site.

**Key Comments by Mr. MacKenzie**

**Background (Slides 1 – 5)**

Evolution of an air traffic management (ATM) system from concept to implementation proceeds through the "vision/operational capabilities" phase, the "architectural development" phase in which the ATMS system design is formulated, and the implementation phase.

Operational concepts relate to the planning process, with the global planning [developed by the International Civil Aviation Organization (ICAO)] and regional planning [also performed by ICAO] serving to facilitate the integration of operational concepts from the national level, so that they do not conflict or become counterproductive with each other, but, rather, work together. Regional planning is influenced in a top-down fashion by global planning and in a bottom-up fashion by the national plan. National planning is performed by the ICAO member states (e.g., USA) themselves.

Operational concepts, along with other plans and services, affect the NAS modernization process of the USA. This includes the NAS architecture and its R&D efforts. Results in enhanced capabilities for the NAS are achieved through the guidance/approval process under the FAA's Acquisition Management System.

**Gate-to-Gate ATM Operational Concept (Slide 6)**

The focus of the ICAO ATMCP has been to develop and describe a gate-to-gate ATM operational concept that facilitates evolutionary implementation of a seamless global ATM system. Such an operational concept is visionary, i.e., not limited by the present level of technology, lead to the benefits expected from CNS/ATM, and provide the basis for cost-benefit analyses of the ATM systems.

ICAO has now developed such a gate-to-gate operational concept. This endeavor has required two years of effort, by 29 people representing 29 nations that include representatives from the International Federation of Air Traffic Controllers Association and the International Association of Airline Pilots Association.



## **Invariant Processes and Their Key Conceptual Changes (Slides 7 – 10)**

ICAO's Operational Concept Document has identified the following items as invariant processes (i.e., must be considered in any ATM system design), each with the key conceptual changes listed:

- **Airspace organization and management:** all airspace will be the concern of ATM, airspace management is dynamic and flexible, and any airspace restrictions are transitory.
- **Aerodrome operations:** runway occupancy time is reduced, safe maneuvering occurs in all weather, precise surface guidance occurs, and the position and intent of all vehicles and aircraft are known.
- **Demand and capacity balancing:** assets are optimized to maximize throughput, adjustment is made to mitigate imbalance, and dynamic adjustment is made to the organization of airspace.
- **Traffic synchronization:** dynamic 4-D trajectory control and negotiated conflict-free trajectories are made, chokepoints are eliminated, and traffic sequencing is optimized.
- **Airspace user operations:** accommodation of mixed-capabilities and worldwide implementation needs are made, ATM data are available as needed, relevant airspace information is available, dynamically optimized 4-D trajectory planning is performed, impacts on the ATM system are taken into timely account, and aircraft are designed with ATM system optimization as a key consideration.
- **Conflict management:** strategic conflict management reduces separation provision, the pre-determined separator is the airspace user, role of the separator may be delegated, separation provision intervention capability is made, conflict horizon is extended, and collision avoidance systems are a part of safety management.
- **ATM service delivery management:** services are delivered on an as-required basis; ATM design is determined by collaborative decision making (CDM), safety, and business cases; services are balanced and user-requested trajectories optimized; and management is by trajectory.

Information services are included as enablers, but are not invariant processes; these include information management, meteorological information, and other essential services.

## **RTCA NAS Concept of Operations (Slides 11 – 12)**

The RTCA NAS concept of operations (CONOPS) relates to the ICAO model with the following observations: it is NAS-specific (i.e., at the national level), incorporates needs and requirements of NAS users and service providers, and is

based on the Free Flight (FF) concept. Thus, further development of FF will affect the RTCA concept.

The RTCA NAS CONOPS has the following characteristics:

- Safety is the first priority.
- Environmental considerations are taken into account.
- Implementation of any new technologies must improve safety and efficiency of the operation environment.
- HITL is included.
- Quality of data, information exchange, and collaborative decision making are key.
- Separation assurance remains the responsibility of the service provider (although it can be delegated to flight crews for specific operations).
- It is divided into near-term (2005), mid-term (2005 – 2010), and far-term (2010 – 2015).
  - In contrast, the ICAO global operational concept is based on 2025.
- It specifically mentions the following:
  - Systems [instrument landing system (ILS), microwave landing system (MLS), global positioning system (GPS), enhanced ground proximity warning system (EGPWS), cockpit display of traffic (CDTI), etc.]
  - Facilities [Air Traffic Control System Command Center (ATCSCC), Airline Operations Center (AOC), final operating capability (FOC)]
  - Procedures (DPs)
  - Solutions (pre-departure clearances, ATIS-type messages)
  - In contrast, a global operational concept is technology independent; no system acronyms exist.
- It is written with the civil user, DOD users, and space transportation users as the only community affecting or depending on use of the NAS.
  - In contrast, the ICAO global operational concept defines the “ATM Community” as one that includes the airport operators, support industry, regulatory authorities, etc.

### **Where Do We Go from Here (Slide 13)**

The International Civil Aviation Organization plans the release of the draft ICAO Operational Concept Document in the June/July time frame to all member states.

It is their intent that it be adopted at the ICAO meeting in 2003. (A copy of this draft document has been placed on the Web site for this NRA TIM, [www.asc.nasa.gov/vams/](http://www.asc.nasa.gov/vams/).)

Based on the Operational Concepts Document, the ICAOP's ATMCP will prepare operational capabilities, needs, and requirements.

The RTCA is currently working on the next version of the NAS CONOPS, which will include the addition of security functions.

#### **Conclusions (Slide 14)**

Concept of operations should be the basis for R&D and requirements development, thus ensuring a focus on operational needs, not necessarily technical capabilities. CONOPS are of critical importance to understanding future directions of the NAS.

#### **Synopsis of Questions and Answers for Mr. MacKenzie**

There were no questions for Mr. MacKenzie.

## 7.

### **System Level Capacity Increasing Concept**

**Mr. Bob Schwab and Mr. Al Sipe  
Boeing Operational Concepts Team**

A copy of Mr. Schwab's and Mr. Sipe's presentation is attached as part of the appendix and is available on the Web site.

#### **Key Comments by Mr. Schwab and Mr. Sipe**

##### **Boeing's Development Process (Slides 1 – 6)**

Comments by Mr. Schwab: The Boeing development process includes the use of "working together teams" to address the broad questions needed for operational concepts that drive the system's technical requirements and architecture. Especially important is the need to use a formal system engineering process that establishes a measure of mission, a measure of effectiveness, and system performance requirements. Trade studies are an important part of the process and should focus on processes as well as provide answers to specific questions. The initial operational concept is capacity driven with cost as an important factor. The fundamental services a new ATC system will perform with the support services required are described. In preparing their concept, Boeing has separated the planning component from the execution component.

An operational concept trade study result is depicted in slide 5. In this study, Boeing is determining how far they can push the planning horizon to facilitate separation management. The lower the traffic density, the more one can use free flight and procedural control instead of traffic management advisor radar vectoring and strategic concepts.

##### **Concepts (Slides 7 – 12)**

Comments by Mr. Sipe: The core concepts and key ATM functions of a new ATC system are described. The identification of core concepts allows an analyst to study the functions supported by the users of the system. Boeing quantifies requirements to trade off performance against system constraints. Trade studies are used to optimize total system performance. Three trade studies are cited as examples. The first study's objective was to determine how far you can plan and still keep the system stable (e.g., if something unusual happens, the effect this has on the plan). The second study's objective was to determine what functions needed to be done on the ground versus in the air. The third study's objective was to determine which functions were to be done by machine and which required human beings. Boeing has identified more than 150 trade studies that need to be completed. The overall schedule is shown in slide 12.

## **Synopsis of Questions and Answers for Mr. Schwab and Mr. Sipe**

After the presentation, Mr. Schwab and Mr. Sipe responded to questions from NRA participants as follows:

**Question:** What equipage will be needed?

**Answer:** Boeing is laying out their operational concepts before they determine their technology and equipage needs. The trade studies will provide metrics for making decisions.

**Question:** How does Boeing know they have the right answer given that different users need different things?

**Answer:** Boeing's decisions will be based on affordability. Their challenge is to price each aspect.

**Question:** What is the stability of their answer? Are they working with a non-linear system?

**Answer:** Part of Boeing's assessment will be to evaluate the stability of their plan.

**Question:** Are Boeing's activities similar to those conducted to determine scenarios and metrics?

**Answer:** They must collaborate with the group, determining scenarios and metrics for maximum efficiency.

**Question:** Does Boeing separate planning activities?

**Answer:** Yes, establishing the planning horizons is a key part of our concept.

## 8.

### **Technologies Enabling All-Weather Maximum Capacity by 2020**

**Dr. Jimmie Krozel**  
**Metron Aviation**

A copy of Dr. Krozel's presentation is attached as part of the appendix and is available on the Web site.

#### **Key Comments by Dr. Krozel**

##### **The Need for All-Weather Capabilities (Slides 1 – 8)**

Weather is a key factor in an effort to increase capacity. Currently, the NAS is not robust to weather disturbances. Systems work in low weather interference but when increased demand and weather interference are combined, an interactive amplification of the problem occurs. Use of the Post-Operations Evaluation Tool (POET) tool can be leveraged to show differences in flights as flown, as opposed to as filed, to identify hotspots or trials done.

##### **Core Ideas (Slides 13 – 18)**

The triad of stakeholders [flight decks (FD), airline operation centers (AOC), and air traffic service providers (ATSP)] all need to have buy-in. Key ideas are optimal weather avoidance and robust weather avoidance. The notion of a feasible route has implications for sensitivity studies. We'll also need to look into incorporation of weather predictions into estimated time of arrivals and be able to accommodate the maximum information available into collaborative decision making to improve predictability.

##### **Enabling Technologies (Slides 19 – 23)**

In the area of weather sensing and prediction, we will completely mosaic the NAS by 2010. Data mining and prior historical data will be used to focus the areas of concern in the NAS and weather. Synthetic vision, new displays, etc., for ATSP and the flight deck will be used to lessen the impact of severe weather. Further efficient surface automation is needed to reduce the impact of severe weather on capacity.

##### **Metrics of Goodness (Slide 24)**

Capacity, flexibility, efficiency, predictability, safety, environment, and delay are important metrics.

##### **Costs and Benefits (Slides 27 – 31)**

The tools POET, Future ATM Concepts Evaluation Tool (FACET), Noise Integrated Routing System (NIRS) Tool, and the Airspace, Design, Planning and Evaluation Tool (ADEPT) will be used to help visualize the problems and

solutions from the existing data, helping to provide the analysis of historical data and development of the metrics of goodness for the scenario-based concept development. Multiple iterations of this analysis and concept development/evaluation will be necessary.

**Getting There (Slide 32)**

We have the talent, knowledge, and ideas. We just need to pursue them and validate them through demonstrations.

**Synopsis of questions and Answers for Dr. Krozel**

No questions were asked following Dr. Krozel's talk.

## 9.

### **Massive Point-to-Point and On-Demand Air Transportation System Investigation**

**John Sorensen  
Seagull Technology, Inc.**

A copy of Mr. Sorensen's presentation is attached as part of the appendix and is available on the Web site.

#### **Key Comments by Mr. Sorensen**

##### **Concept PTP Team (Slide 3)**

The Point-to-Point (PTP) Concept team consists of industry representatives, each with a specific area of expertise. Seagull Technology will focus on air traffic management (ATM). Honeywell will focus on aircraft and avionics, weather delays, airborne human factors, and security. ITT will focus on CNS. Titan will focus on how to integrate safety and ground system human factors. United Airlines will provide information on general aviation and commercial operations, including fractional jet operations. Federal Express will supply a package delivery perspective.

##### **Issues with Future NAS (Slide 4)**

The hub-and-spoke system in use by the airlines is rapidly approaching gridlock. The addition of new runways at major hubs is costly and politically difficult to achieve. The hub and spoke system is becoming time inefficient and unpleasant to the traveler. Many business travelers are moving to smaller jets for direct flights. This will increase the need for new smaller jets requiring instrument flight rules (IFR) services.

The current airspace structure was designed to accommodate moderate traffic flows that follow static air routes. This design is inconsistent with the free flight systems under development. In addition, the static sector design is affected by dynamic weather conditions. En route densities will only increase with the addition of the smaller jet traffic.

The NAS has over 5,400 airports currently underutilized. Will they be converted to shopping malls or become an airport point of entry for terrorists?

##### **Concept PTP Core Idea (Slide 5, 9 – 10)**

Using census data, the Small Aircraft Transportation System (SATS) project has determined that 93 percent of the population resides within 30 minutes of a SATS-type airport, 41 percent reside within 30 minutes of any commercial airport, and only 22 percent reside within 30 minutes of a major or hub airport. The concept PTP core idea is to facilitate and incorporate massive use of point-to-point and on-demand air transportation, principally from the smaller underutilized



airports. The premise behind the PTP concept is that it will add overall transportation capacity and relieve hub and spoke gridlock. When implemented, the PTP concept will take advantage of SATS-type airports and new airplanes with augmentations to the existing NAS system components. These components include the ATM systems, fleet operations infrastructure systems, and commercial aircraft operations management processes.

### **Key Assumptions and Benefits to PTP Concept (Slides 6 – 7)**

The increase of passenger travel over the next 25 years will create a demand for smaller aircraft serving more airports and other facilities. Continued urban sprawl and road congestion will increase the overall door-to-door travel time. The increase in the number of aircraft to service the demand will create a demand for point-to-point routing between airports. Corporate America will require an on-demand travel service to avoid airport hassles, provide for improved security, and save time.

The PTP concept will harness the *existing* smaller unused airports to increase NAS capacity. The use of additional airports and the point-to-point routing will provide an increase in transportation efficiency. The benefit analysis with a door-to-door multi-modal perspective will measure the reduction in total travel time. The system modeling planned and subsequent benefit analysis will provide an estimate of the potential overall gain in NAS capacity.

### **Concept Poses Key Technical Challenges (Slide 8)**

The six core ideas of concept PTP are designed to address the key technical challenges that are anticipated in utilizing the smaller airports and increased number of aircraft. The key challenges to be addressed involve unifying fleet and flow management infrastructure; the need for a more flexible, distributed ATM system; and the need for better equipped aircraft in terms of capable and uniform avionics.

### **Six Basic Concept PTP Core Ideas (Slides 11 – 21)**

Each core idea is presented with a high-level summary of what areas the core idea will address. The six concept PTP core ideas are:

- Provide non-towered airports with ATM automation
- Use terminal area time-based ATM
- Integrate strategic en route ATM and flight management
- Integrate PTP fleet operations (dispatch)
- Accommodate broader aircraft spectrum with advanced avionics
- Provide integrated CNS and weather information infrastructure

### **First Steps in Describing Concept PTP (Slides 22 – 23)**

The first step of the PTP concept will concern the two models to be created. The initial model will be based on year 2020 projections for traffic demand and will focus on high-use areas such as the northeast corridor or the Los Angeles Basin. It will include city-pair flight plans within the region for various types and number of aircraft, and will be used to quantify ATM and fleet management challenges. This model will also be used to study what aircraft functions can be moved from large airports to small ones.

The second model the functional and will emphasize the components needed to complement the hub-and-spoke developments. This functional model will help define the roles of the participants and automation within the concept.

### **Synopsis of Questions and Answers for Mr. Sorensen**

After the presentation, Mr. Sorensen responded to questions from NRA participants as follows:

**Comment:** The new security requirements being considered may require all aircraft to be radar tracked.

**Comment:** There will be resistance from the aircraft owners and fleet operators to new equipment requirements that this concept may require.

**Question:** How much capacity increase will be available with Concept PTP?

**Answer:** That is a good question that is part of the task.

**Question:** Does the concept include any analysis of the environmental effect (noise, traffic) of small airport use?

**Answer:** Not at this time, but it could be added.

## **10. Optimization in the National Airspace System**

**Dr. Banavar Sridhar  
NASA Ames Research Center**

A copy of Dr. Sridhar's presentation is attached as part of the appendix and is available on the Web site.

### **Key Comments by Dr. Sridhar**

#### **Problem Description (Slides 1 – 5)**

Definitions of the terms capacity, throughput, efficiency, and traffic flow management (TFM) objective are provided so the participants can share a common perspective for the TFM problem that is being studied. The particular focus is on the development of en route algorithms to optimize traffic flow rates to meet demand. There is a potential of sector congestion in the en route area if one went from 10,000 to 50,000 aircraft. Air route traffic control centers having many inter-center boundary connections [such as the Kansas City Center (ZKC)] will have more complicated sector traffic.

#### **Research Plan (Slides 6 – 7)**

The research planned is divided into developing algorithms and concepts to maximize the capabilities of the current system, and, developing algorithms and concepts for the future system. The future system will require the development of a scenario database. Research efforts will be coordinated with other VAMS concept development efforts and evaluate research results with FACET. FACET provides an excellent tool for exploring advanced ATM concepts and has been created in a manner that balances fidelity with flexibility.

#### **Examples (Slides 8 – 14)**

Two examples of the use of FACET are provided. In the first example, he shows how FACET could be used to study departures from New York when "west gates" are not available. The current system is overloaded even in nominal conditions. Simulation shows that departure delays from LaGuardia and Newark can be used to solve the "no west gates" problem and the key is to determine the best combination of departure delays.

The second example demonstrates how FACET can be used when existing constraints are not in place (i.e., the free flight era). FACET compares the results from wind-optimal routes, versus sequential trajectory planning, versus great circle routes. Continuous replanning could take care of conflicts in the free flight era.

### **Synopsis of Questions and Answers for Dr. Sridhar**

After the presentation, Dr. Sridhar responded to questions from NRA participants as follows:

**Question:** Have you looked at uncertainties?

**Answer:** Yes, but it is unclear if examining probabilities helps the ATC that much.

**Question:** Are optimization algorithms iterative?

**Answer:** They are performed sequentially. The use of sequential calculations has not been a problem since only a few optimizations are performed.

**Question:** Was the optimal ATC video at 35,000 feet only?

**Answer:** Yes, this is why there were so few aircraft in the movie.

## 11.

### Daily Agenda Questions and Comments

**Mr. Harry Swenson**  
**VAMS Project Manager, NASA Ames Research Center**

Mr. Swenson encouraged participants of the TIM to forward any general questions and comments to him. He indicated he would provide the answers to the group during the Daily Agenda session on Day 2 and Day 3 of the TIM.

#### Questions and Answers for Mr. Swenson during the Daily Session for Day 2:

**Question:** Do we have an acronym list?

**Answer:** Yes, it is available at the registration desk.

**Question:** Will the VAST architecture support concept models?

**Answer:** Yes.

**Question:** Who will code the VAST product?

**Answer:** The VAST team will contribute the general models necessary for multiple concept modeling. Concept developers will work within the Federates Object Model (FOM) and the Application Program Interface (API) framework to produce concept models specific to their concept.

**Question:** When will the CD with the presentations be available?

**Answer:** The program is targeting Wednesday, 5/29, to mail a CD to each presenter and/or organization that is working on VAMS.

**Comment from floor:** Develop the Integrated Concepts sooner in the [VAMS] project. Do not develop separate concepts then try to “staple integrate” too late in the project.

**Response –** There is nothing in the project that stops this desire.

**Comment from floor:** It seems that CNS tools are integrated late, i.e, Build-3 of VAST. [VAMS] Needs to deliver and integrate sooner.

**Response –** Every build will have limited CNS capabilities as a function of the scenarios.

**Comment from floor:** Need to release VAMS framework requirements sooner.

**Comment from floor:** We need a common WWW-site location where information can be distributed on concepts, models and overviews.

**12.**  
**Capacity Improvements**  
**Through Automated Surface Traffic Control**

**Dr. Brian Capozzi**  
**Metron Aviation**

A copy of Dr. Capozzi's presentation is attached as part of the appendix and is available on the Web site.

**Key Comments by Dr. Capozzi**

**The Need for Surface Automation (Slide 3)**

The Metron Aviation concept will study improvements in the automation of surface movement of aircraft. It can be assumed that the number of runway and taxiway incursions will increase as the number of aircraft moving on the surface increases. Factors that affect the number of incursions include gate availability, runway configurations, runway occupancy time, wake vortex separation requirement, communications difficulties, visibility, and controller workload.

Metron has assembled a team of topical experts in the fields of path optimization, algorithmic design, autonomous systems, surface automation, decision support tools, ATSP experience, and human factors to address the concept.

**Concept Overview and Core Ideas (Slides 5 – 9)**

The automation of surface traffic will be controlled by a synchronized motion plan for each aircraft. This motion plan will be determined by a set of algorithms and will control a set of taxi lights imbedded into the airport surfaces. The pilot will simply follow the green taxi lights across the airport surface. Taxi clearances will be generated and received via automation. Aircraft positions will be monitored with the assistance of GPS and automatic dependent surveillance-broadcast (ADS-B) systems. Automation will provide updated flight strip information to the terminal and en route automation systems. The human role will be to establish the motion goals and parameters and monitor the system's safety.

The inputs to the planning algorithms will consist of the surface movement goals and constraints, NAS demand inputs, the number of gate resources available, and aircraft position. Output of the planning algorithm will be a set of best path maps with multiple plans to account for uncertainty in the system. The planning algorithm will also factor in non-constant constraints such as passenger load and unload times, gate services/maintenance times, de-icing requirements, and other traffic flow management initiatives.

Representative examples of the possible failure states of the operational concept are provided. The examples show what will happen when blunders or failure conditions are detected. The system will attempt to resolve the conflict. If the

conflict cannot be resolved, the system will generate a stop condition that will then require human intervention to resume operation.

### **Enabling Technology and Technology Roadmaps (Slides 10 – 3)**

This concept will require improvements in certain enabling technologies that include: aircraft positioning via GPS, ADS-B, or airport surface detection equipment-Model X; taxiway light control systems; and weather and user response prediction. Other advances in display technology such as cockpit display of traffic (CDTI) moving maps and augmented reality displays can be incorporated into the concept of automation of surface traffic.

The transition in the roles and responsibilities of pilots and controllers will also be a key factor in the transition to this system. But the transition will evolve over time as new technologies become available. The use of smaller airports such as those suggested by the point-to-point concept could be a starting place for this system, followed by a migration to larger airports.

### **Metrics of Goodness (Slides 14 – 16)**

Metron plans to use a number of their proposed metrics to evaluate this concept. These metrics, with available tools such as POET and FACET, will provide a measure of the performance of the system.

### **Synopsis of Questions and Answers for Dr. Capozzi**

After the presentation, Dr. Capozzi responded to questions and comments from NRA participants as follows:

**Question:** Who gives final (takeoff) clearances?

**Answer:** There is a handoff between the surface and terminal agents. The answer is it depends on what the terminal concept is. For an intelligent runway system, it may be that system.

**Question:** Would surface vehicles need special equipment?

**Answer:** In reality, the gate will probably be under the control of a person, so they will probably handle these. If the vehicle is on the runway, the tower controllers will probably handle this on an exception basis.

**Question:** The presentation mentioned that there would not be any equipment changes for the aircraft. What would be required for the airports?

**Answer:** That is a subject that will be explored in the concept.

## 13.

### **Surface Operations Automation Research**

**Dr. Victor H. L. Cheng**  
**Optimal Synthesis Inc.**

A copy of Dr. Cheng's presentation is attached as part of the appendix and is available on the Web site.

#### **Key Comments by Dr. Cheng**

##### **Background (Slides 1 – 8)**

The Federal Aviation Administration's National Airspace System (NAS) Operational Evolution Plan (OEP) has identified that congestion at key hub airports has become a major problem and airports are a congestion point for the NAS. The Surface Operations Automation Research (SOAR) concept seeks to increase capacity by enhancing space (increasing runways and taxiways) and density (reducing separation). Increasing real estate (runways) is only part of the solution. In particular, Dallas/Fort Worth airport (DFW) has seven runways, which has led to other problems, e.g., inside runways block outer runways and ramp areas. In addition, DFW now has more runway crossings to handle. An example is a taxi delay problem at DFW where up to nine aircraft may have to queue up to get to a runway. The OEP is seeking solutions for runway-crossing issues for the mid-term (2002 – 2004) and far-term (2005 – 2010).

##### **Surface Operation Automation Research (SOAR) Concept (Slide 9)**

The SOAR concept will depend on a centralized decision-making distributed control paradigm. SOAR will automate ground control and the flight deck. A prototype Ground-Operation Situation Awareness and Flow Efficiency (GO-SAFE) system has been developed as well as a flight deck automation for the ground operations system. The SOAR concept is founded on the integrated operation of both systems.

##### **Ground Control and Flight Deck Automation (Slides 10 – 22)**

The desired functions for ground-control operations are shown on slide 10. The GO-SAFE system addresses these desired functions. Controllers can edit taxi routes to optimize taxi routing with GO-SAFE. This system allows new taxi spatial routing and can be used to make taxi temporal adjustments. The GO-SAFE system contains conflict detection, resolution functions, and a decision support system. The cockpit will still have ultimate responsibility but the use of auto-taxi will require increased automation. The decision support system contains a schedule manager to perform scheduling for runway use and runway crossings. In particular, this system allows several aircraft to cross a runway at difference points. The GO-SAFE system also contains a clearance manager (see slide 19) and an information exchange system (see slide 20).



The desired functions that will be performed on the flight deck are shown in slide 21. A flight deck system is needed for the tight control requirements of precision-taxi. The pilot interface is a key challenge and current systems are not acceptable. It is expected that the near-term system will contain automation assistance for more control.

### **Integration of Automation Systems and Evaluation Metrics (Slides 23 – 25)**

The focus is on creating a more user-friendly integration of ground and flight deck automation systems. The top-level model for the new system is shown in slide 24 and the criteria for evaluating the new system is shown in slide 25. If you reduce uncertainty, there is less chance of conflict and safety is increased even if less separation exists.

### **Synopsis of Questions and Answers for Dr. Cheng**

After the presentation, Dr. Cheng responded to questions from NRA participants as follows:

**Question:** How will Metron and Optimal Synthesis concepts be integrated?

**Answer:** The VAMS environment and framework will be used to aid integration. The details of this integration have not been fully developed.

**Comment from the floor:** We will study the limiting factors and create a timeline of surface-movement stages in bottleneck situations.

**Question:** How effective has the system been to date?

**Answer:** The SBIR results did not focus on getting the required data.

**Comment from floor:** We need to know how accurately we need to make the required predictions.

## 14.

### **Centralized Terminal Operation Control (CTOC) Concept**

**John Fergus**

**Northrop Grumman Information Technology**

A copy of Mr. Fergus' presentation is attached as part of the appendix and is available on the Web site.

#### **Key Comments by Mr. Fergus**

##### **Operating Domains (Slide 3)**

The operating domain of the Centralized Terminal Operation Control (CTOC) concept will address is the terminal area. Specifically, the concept applies to the departure and arrival phase of a flight. The concept will provide for the sharing of information and interfaces with overlapping areas such as runway allocations and en route processing.

##### **Current Terminal Issues (Slides 4 – 5)**

An under-utilization of terminal airspace exists in the system in the form of spacing inconsistencies. Some of these are due to pilot reactions to controller directives, communications errors, reduced visibility conditions, and aircraft performance differences. There are also conditions for which a controller can identify an unauthorized use of the airspace but cannot prevent it.

##### **CTOC Concept and Core Ideas (Slides 6 – 8)**

The premise behind the Centralized Terminal Operation Control (CTOC) concept is to provide remote control of the aircraft while it is in the terminal area. This is similar to the maritime industry's use of a harbor pilot to navigate specific harbors and approaches. Terminal specialists will be the equivalent of the harbor pilot. The approach is based on the reasoning that having a single operator reduces communications and behavior variability.

This concept will depend on improved aircraft technologies such as datalink and flight management system (FMS). The CTOC will interface with decision support tools to provide predictable, consistent, and conflict-free trajectories. Remote control of the aircraft may be adjusted based on ATM flow constraints. The pilot will always have the ability to override the CTOC commands for flight safety.

##### **CTOC Benefits/Metrics (Slide 9)**

The potential benefits are increased capacity, efficiency, safety, and reduced costs. Each candidate benefit has its own set of metrics identified.

## **CTOC Challenges (Slide 10)**

The challenges to the CTOC concept will include acceptance by all parties, in particular the flight crew and flying public. Other CTOC challenges are the human factors considerations for the terminal specialist, operational procedures for transfer of control, overrides protocols to be established, and the presence of aircraft of different types. The legal impact of CTOC roles and responsibilities will also be a challenge for the CTOC concept.

### **Synopsis of Questions and Answers for Mr. Fergus**

After the presentation, Mr. Fergus responded to questions from NRA participants as follows:

**Question:** At what point would the pilot take over from the “specialist”?

**Answer:** The pilot may take over at the surface threshold. This is uncertain because an active runway system could be involved.

**Question:** Have you considered unmanned aerial vehicles?

**Answer:** Nothing we have done excludes this. It should fit into the concept.

**Question:** Have you considered different airport layouts like Dulles?

**Answer:** We have not really considered them.

**Question:** Have you considered departures, active weather, and satellite airports?

**Answer:** Yes, we have considered them to a limited degree at this point.

**Question:** Do you have specialists for different types of aircraft? How many aircraft do you think each can handle?

**Answer:** We do not know yet. It is a good research question.

## 15.

### **Terminal Area Capacity Enhancement Concept (TACEC)**

**Mr. Ken Arkind**  
**Air Traffic Management Systems, Raytheon**

A copy of Mr. Arkind's presentation is attached as part of the appendix and is available on the Web site.

#### **Key Comments by Mr. Arkind**

##### **Background (Slides 1 – 5)**

Raytheon's definition of the terminal area-operating domain mirrors the description in the Federal Aviation Administration's Operational Evolution Plan. VAMS and the OEP are predicting dramatic increases in the number of airport operations despite the fact that NAS is operating at or near capacity. To solve the capacity problem, the FAA OEP envisions that the majority of capacity growth will come from building new runways; in contrast, his capacity-increasing concepts will focus on new technologies. The consequences of increased traffic in the terminal area are shown on slide 5.

##### **TACEC (Slides 6 – 14)**

Raytheon's Terminal Area Capacity Enhancement Concept (TACEC) is built on the belief that the technology exists today to significantly reduce separation standards. We need to build confidence in this technology and, in particular, the fault-monitoring technology. The evolution will be difficult and all stakeholders' requirements must be addressed. Key elements for increasing capacity in the terminal area are the new data link which must provide *secure* communications and the use of the local area augmentation system.

Within TACEC, the operational environment can be created by computations with specific algorithm approaches developed to maximize throughput. TACEC will still require the human element as well as some enhancing automation. In particular, humans will be required to ensure proper response to abnormal situations. As an example of a problem that must be resolved, humans commit to vectoring an aircraft, while a computer does not commit if later calculations show a new alternative.

Implementing TACEC will require a redefinition of the human role in the system. The core of the redefined role will be the division between what the participant controls and what they manage. In addition, if personnel are working on multiple tasks, we need to know how quickly they can react to an abnormal situation and how quickly they can recover. We will need a variety of ways to get information to the controller in order to improve his or her situational awareness.

### **Examples (Slides 15 – 16)**

Two specific examples of visualization concepts for improving situational awareness are given. In the first example, visual displays for enhancing sequencing approach and departure aircraft are described. In the second, a visualization concept that uses visual metaphors to manage flight schedules in time-space is described. The key point is that if we relinquish control from the controller, can the controller react to situations properly. These examples show how research might answer the question “How will you rapidly acquire situation awareness?”

### **TACEC and the Government-Furnished Information (GFI) Model (Slides 17 – 19)**

A description of how the GFI top-level architecture would be modified for TACEC is shared. A focus on individual elements of the architecture is expected.

### **Safety and Benefits Assessment (Slides 20 – 21)**

Safety will be a key element of the research given that we are relinquishing some of the control function to the computer. However, the benefits of increased, more reliable operations make this research valuable.

### **Synopsis of Questions and Answers for Mr. Arkind**

After the presentation, Mr. Arkind responded to questions from NRA participants as follows:

**Question:** Will you get a factor of two increase in capacity? Will wake-vortex be a limiting factor?

**Answer:** It is uncertain how much capacity will increase at this time. Side-by-side landings could be used.

**Question:** Aren't environmental impacts and legal roadblocks a huge issue?

**Answer:** Yes, noise constraints are particularly an issue. A full solution to this problem does not exist at this time.

**Question:** Do you need a trajectory negotiation concept for decent (such as the DAG-TM concept)?

**Answer:** Yes, it is assumed it will be there.

**Question:** What is the expected link between the air and the ground?

**Answer:** The computational horsepower is expected to be on the ground with the air component supplying the data.

**Question:** What will be the impact of SATS on TACEC?

**Answer:** It is expected SATS will help. The focus is on hub-and-spoke technology.



**16.**  
**NASA Langley Research Center**  
**Wake Vortex Research Supporting VAMS**

**Mr. David Rutishauser**  
**NASA Langley Research Center**

A copy of Mr. Rutishauser's presentation is attached as part of the appendix and is available on the Web site.

**Key Comments by Mr. Rutishauser**

**AVOSS Background (Slide 2)**

NASA researchers have designed a system to predict aircraft wake turbulence on final approach, so airliners can be spaced more safely and efficiently. This technology, known as the Aircraft VORtex Spacing System (AVOSS), demonstrates an integration of technologies that provides weather-dependent dynamic aircraft spacing for wake avoidance in a real-time relevant environment.

AVOSS was successfully demonstrated at Dallas Fort-Worth Airport in July 2000. The demonstration represented the culmination of 6 years of field-testing, data collection, and development.

**Wake Vortex Issue (Slide 3)**

All aircraft produce wake vortices, two small horizontal tornadoes trailing behind the wing tips. The larger and heavier the plane, the stronger the wake. Weather plays a big part in the motion and decay rate of these trailing twisters. Until now, no system could accurately predict wake vortex patterns and quantify the spacing needed for safety. Current operations use fixed spacing intervals behind aircraft to avoid wake vortices. The spacing is preset based on aircraft weight classes. AVOSS determines how wind and other atmospheric conditions affect the wake vortex patterns of different types of aircraft. The system uses a type of laser radar, or lidar technology, to confirm the accuracy of those forecasts. All this information is processed by computers, which can then provide safe spacing criteria.

**AVOSS DFW Research Results (Slides 5 – 11)**

The maximum theoretical gain of instrument flight rules (IFR) throughput is calculated to be 16 percent based on a 50-second runway occupancy time. This improvement is interesting because it shows the system can approach the maximum capacity of the runway. When wake considerations are ignored, the maximum possible spacing compression gain is about 16 percent (based on 2.5-nm of spacing for all aircraft pairs at DFW). AVOSS research indicates use of wake turbulence detection systems will lead to arrival rates restricted by runway occupancy time rather than wake turbulence.

### **Future Wake Vortex Research Activities (Slides 12 – 14)**

Two organizations within NASA's Langley Research Center (LaRC) will support the VAMS project: the Airborne System Competency organization and the Aerospace Systems Concepts and Analysis Competence organization. These organizations will work on defining operational concepts and models, such as the Wake Vortex Avoidance System (WakeVAS), that will apply AVOSS products to the wake vortex problem. NASA plans to use the technology models developed by LaRC in the larger NAS simulations developed at ARC.

### **LaRC FY2003 and Beyond (Slide 15)**

LaRC will continue technology model development and target larger, more comprehensive NAS simulations as they are developed. Ongoing research will allow LaRC to refine existing technology models and concept designs. LaRC will continue to keep paths open to concept and/or technology implementation by maintaining consistency and synergy with FAA and NASA wake vortex research.

### **Synopsis of Questions and Answers for Mr. Rutishauser**

After the presentation, Mr. Rutishauser responded to questions and comments from NRA participants as follows:

**Question:** Is there a benefit to setting rules based on aircraft type and using different miles-in-trail spacing based on aircraft type?

**Answer:** Yes, these rules can then be programmed into a decision support tool (DST) or cockpit tools.

**Question:** Do you still need expensive (e.g., LIDAR-type) sensors even at SATS-type airports?

**Answer:** It will be necessary to rely on static tables without some sensors to recalibrate the prediction algorithm every so often.

**Question:** Is the data from the project available to the VAMS concept developers?

**Answer:** Yes, large amounts of data are available.

**Comment:** The NASA team may want to consider extending the parameters of the Wake Vortex program and experiment with the results of the parameter extensions.



## 17.

### **Advanced Airspace Concept**

**Dr. Heinz Erzberger**  
**Senior Scientist, NASA Ames Research Center**

A copy of Dr. Erzberger's presentation is attached as part of the appendix and is available on the Web site.

#### **Key Comments by Dr. Erzberger**

##### **Introduction (Slides 1 – 2)**

This presentation is an update to several presentations given over the last 10 years. Northrop and Raytheon have similar ideas for NASA, but the means to get there is still to be determined. The following items will be discussed: limitations of the existing system, the Advanced Airspace Concept (AAC), candidate architecture for the AAC, separation assurance and conflict avoidance system (Tactical Separation Assurance Flight Environment or TSAFE), and ground-air interactions.

##### **Current System Limitations (Slides 3 – 5)**

Limitations of the current paradigm lie fundamentally in the area of controller workload. Sector sizes cannot be made any smaller. Current DST technology can provide some improvements, but cannot achieve the gains necessary to circumvent basic controller workload limits. Operational errors were up 50 percent in the year 2000. Currently, NASA is focusing on en route limitations.

The cloning method for estimating en route airspace capacity potential is described. For this study we performed an estimate of all the sectors' en route capacity in the Cleveland Center, it was decided to assume one can fly aircraft through the airspace, maintaining separation without considering controller workload. The study looked at airspace available for 4D trajectories that were conflict free, given current separation standards, and used enhanced traffic management system data from high-occupancy sectors in Cleveland Center.

The advanced airspace concept has the potential to more than double (maybe triple) baseline capacity, based on even the worst cast analysis of the Cleveland Center sector data, if controller workload is not a constraint. The bottom line is that lots of airspace is available for additional trajectories as compared to the baseline without changing separation rules. Methods for reducing controller workload must be determined.

##### **Overview of AAC (Slides 6 – 8)**

The ground-based system sends separation assurance advisories to equipped aircraft while advisories are assumed to be sent via data link. Controllers are not responsible for monitoring and controlling separations of equipped aircraft. The

need for super-sectors to minimize coordination required between sector controllers has been hypothesized. As a backup, voice control is still available for both equipped and unequipped aircraft or emergencies. The ACC operational concept definition leads to the theme of a safety sub-system within the system managing a large airspace “chunk” (super-sector) to reduce coordination and to optimize routing efficiency.

Design guidelines envision the use of currently available technologies (Mode S, GPS, ADS-B, etc.). While onboard equipage will be kept to a minimum, the data-link and cockpit display of traffic are essential. Of course, an FMS is highly desirable to help with more advanced functions. Other than the need for voice backup, the safety net required for this system remains the greatest design challenge.

A simplified view of the AAC architecture is described: the Automated Airspace Computer System (AACS) augmented by TSAFE. An advanced version of CTAS could be used for the AACS. TSAFE is a redundant component and a simple backup supervisory system that can step in for safety assurance if AACS is lost.

### **TSAFE (Slides 9 – 15)**

TSAFE is needed because the AACS may encounter problems it was not designed to solve. Furthermore, AACS is too complex to verify. A completely different approach, independent of the 4-D trajectory solution provided by the AACS is needed. TSAFE will be less complex and easier to validate and maintain. It is symbiotic with the use of TCAS onboard, which operates without knowledge of intent.

Key functions of the TSAFE architecture are trajectory error analysis, conflict detection, critical maneuver and no-transgression-zone detection, and conflict avoidance advisories (resolution). The object is to try to create a short-term conflict-free (approximately 3-minute) condition to allow controller takeover.

The TSAFE conflict detection and avoidance strategy includes a short detection horizon (about 3 minutes) that allows simplifying assumptions to be made. This still allows conflict alerts to be provided with about 2 minutes of warning to loss of separation (LOS). An avoidance maneuver is then generated (climb or descend, turn right or left) to provide a short period of conflict-free flight. A simplifying assumption is that kinematic models of aircraft are used for generation of these maneuvers, which are then packaged in to the advisories and sent via data link. Then the aircraft are handed off to either the controller or the AAC system for implementation of a more “strategic” solution.

TSAFE’s critical maneuver detection is a key unique feature. A method for detecting critical horizontal and vertical maneuvers was shown. Critical maneuver detection was designed to see if a failure to execute a planned maneuver will result in conflict. During TSAFE development several incidents of involving operational errors that occurred at the Fort Worth Center over the last 3 years were examined. Most operational errors occur during climb or descent. TSAFE

was incorporated into CTAS (D2/CPTP) for research and evaluation and tested using live data. Eventually, it will be a separate system.

An example of a typical “critical maneuver” shows the ground tracks of two aircraft heading toward a meter fix. Failure of descending aircraft to stop at assigned altitude results in loss of separation. TSAFE first gives a critical maneuver warning and then a conflict alert 20 seconds before loss of separation occurs. It has application to current operational procedures. Alerting is based on geometry of intent (and human error propensity).

### **Discussion of Operational Responsibilities (Slide 16)**

Trajectory replanning and TSAFE alert monitoring will be added to the pilot’s duties. However, shifting the workload for separation monitoring to the fight deck will have consequences. A need exists to filter out unnecessary alerts in order to minimize pilot workload. TSAFE allows for the possibility of implementation in current operations.

### **Synopsis of Questions and Answers for Dr. Erzberger**

After the presentation, Dr. Erzberger responded to questions from NRA participants as follows:

**Question:** Is this applicable to TRACON airspace?

**Answer:** Yes.

**Question:** Does this concept rely on the existing route structure; i.e., is this compatible with free flight?

**Answer:** This is neutral vis-à-vis free flight.

**Question:** What is the difference between conflict alert and TSAFE?

**Answer:** We are very familiar with conflict alert. The differences lie mostly in the area of critical maneuver alerting and better use of knowledge of intent.

**Question:** What are the levels of false alerts within TSAFE?

**Answer:** False alerts can be minimized but never completely eliminated. The issue of how alerts will be displayed needs to be investigated.

**Question:** Does the MIT data include reduced vertical separation minimum (RVSM) data?

**Answer:** No, but this might make the workload problem for controllers worse.

**Question:** Have you seen more than one aircraft in conflict at a time when you add the clones?

**Answer:** Clones were eliminated when the first conflict was detected. Therefore, the multiple conflict situation did not arise. We just eliminated the clones did not attempt to resolve conflicts between parents and clones. Therefore, our capacity estimate is conservative.



## 18.

### **A Suggested Approach for Producing VAMS Air Transportation System Technology Roadmaps**

**Del Weathers**

**VAMS Deputy Project Manager, NASA Ames Research Center**

A copy of Mr. Weather's presentation is attached as part of the appendix and is available on the Web site.

#### **Key Comments by Mr. Weathers**

##### **Background (Slides 2 – 3)**

The Virtual Airspace Modeling and Simulation (VAMS) project requires the production of technology roadmaps to help guide the research. These roadmaps are to be produced by each concept team, updated annually, discussed at the technical interchange meetings (TIMs), shared among all VAMS participants, and made available electronically. These concept-specific technology roadmaps will be subsequently blended ("not pureed") into an integrated catalog of roadmaps, technical discussions, and research recommendations under the leadership of the System-Level Integrated Concepts (SLIC) sub-element lead, Rob Fong. Links will be provided to AvSTAR, the OEP, and NASA's long-term air transportation system strategy.

##### **Technology Roadmap Framework and Characteristics (Slides 4 – 12)**

The "rearview mirror of the past" helps us better see the future and technology roadmap framework examples already exist for the ATM models for 1940 through 1999. Such frameworks need to be created for 2002 (today), 2006 (near-term), 2010 (FAA OEP horizon), 2015 (medium-term vision horizon), 2020 (longer-term NASA vision horizon), and 2025 (longer-term stakeholder vision horizon).

The technology roadmaps need to show the time for a specific technology's evolution from concept to market availability (NAS use). Roadmaps will also discuss the science understanding, and the performance needs/requirements indicate the alternative approaches possible and the risks (technical, political, legal/certification), identify the critical challenges, estimate the costs (by phase), describe the scenarios to demonstrate the concept's features, and provide supporting documentation. Stovepipe solutions are not acceptable.

An informative graphical representation of the ATM architecture for each of the years 1940 through 1999 in 10-year increments is shared.

A key goal is to be able to show how each individual concept relates to each of the other concepts, and how to fit them into an integrated technology roadmap.

## **Synopsis of Questions and Answers for Mr. Weathers**

After the presentation, Mr. Weathers responded to questions from NRA participants as follows:

**Question:** Will there be other ways to get there? Is evolutionary the way to go? (Questioner remark that he does not know of any other way to go.)

**Answer:** This was purposely left this off the charts. This is TBD.

**Question:** What about affordability, cost, political, and legal issues? How are we to deal with these?

**Answer:** “A prepared mind is a better mind;” i.e., anticipate these issues/problems and address them as best you can. VAMS needs to exist in the real world. The solution must be coordinated and collaborative.

**Comment from Harry Swenson:** You must lay out what it takes to bring about your concept.

## 17.

### University Concept Team Draft Report

**Dr. Andres Zellweger**  
**Senior Scientist, NASA Headquarters**

A copy of Dr. Zellweger's presentation is attached as part of the appendix and is available on the Web site.

#### **Key Comments by Dr. Zellweger**

##### **Introduction and Team's Objective (Slides 1 – 3)**

The University Concept team's objective is to identify what university research is to do. This is essentially a mid-term report of a 10-person team. The final report is due in July. The most important charge is to identify a research agenda, and to this end the team has completed three of five planned meetings. The group recognizes that 25 years is a long time, and it must develop concepts that are resilient to changes in the assumptions made.

Since concept development rests on the development of good research, the team found it needed to do research before filling in the details of any particular concept.

##### **Drivers, Enablers, and Timing (Slides 5 – 7)**

High-demand urban centers will continue to use the hub-and-spoke model to some degree, as this is very efficient. At the same time, point-to-point and regional jet traffic are expected to increase.

Capacity/demand/security are important drivers (the focus is to not force general aviation (GA) related industries out of business later). More unmanned aerial vehicles (UAVs) are expected to meet cargo and military needs. General aviation will increase, especially if "air taxi" (for example, Ray Moore, Oregon) and Eclipse are successful. Low-cost operators need to be persuaded to not adding excessive costs. Developing regional approaches to ATM is a key driver and environmental issues (not just noise) are becoming more important. Other drivers are reduced homogeneity of speed, cost, and sustainability. Airspace is being viewed increasingly as a national resource. Markets and economics (regional interests) will be played off against national and (perhaps) international ones—globalization vs. what is best for the USA. As discussed earlier, technology is not really an issue. The future must be driven by policy for public benefit, not vested interests of special interest groups.

The program should be driven through policy, not benefits. Transition is viewed as a key inhibitor to system development; therefore a benefits-driven transition is not likely to work. Our team thinks its important to learn from the past and understand what's required for successful transitions to a new concept. A key point to note is that the public is the customer (not just the airlines).

In 5-7 years, when a significant percentage of controllers retire, a confluence of events will make the time ripe for political leadership to step up and drive change.

### **New Concepts (Slides 8 – 12)**

The bifurcated system concept involves a high-density network, low-density network, and the autonomous instrument meteorological conditions (IMC) operations that have been briefly studied by the team. The bifurcated system consists of two parts. The high-density network is highly structured for efficient flow. The low-density network is structured similarly to today's ATC environment. For the high-density network concept to be successful, the different elements of system have to be "impedance matched" to achieve robustness.

The high-density and low-density network boundaries will be based on traffic load, not geographical regions. Low-density network space will be external to but possibly intertwined around high-density airspace. Transition points will exist between high-density and low-density space and separate optimizations will be required for each instance.

Airport system flows are also important and the key will be taking care of the groundside.

### **The Tube Concept (Slides 12 – 15)**

Conducting research into the tube concept is the best chance of early success for en route. Like the high-density network, it is highly structured, with efficient flow, but offers limited flexibility. It is similar to TRACON flows but is throughout the network, allowing maximum use of key resources. It follows the "highway in the sky" metaphor and features routes, on/off-ramps, breakdown lanes, and standard (posted) detours around obstructions (like weather). Required aircraft control includes RTA, in-trail separation, and pair-wise maneuvering. Ground controls include sequencing, scheduling, and structure. The tube concept allows controllers to deal with aircraft in high-density (en route) situations, but problems will still exist at airports.

To overcome these transition issues, leadership must be established and political and public support must be obtained. In addition, workforce buy-in must be obtained early on. Issues, opportunities, and inhibitors/opposition must be identified and broken down. The tube concept will need to be demonstrated in experimental corridors in high-value target markets (ORD-NYC, LA-SFO, DCA-NY-BOS). For this experiment the number of corridors will be limited and simple on/off ramps and break-down lanes will be used. In addition, pair-wise self-separation (station keeping) will be implemented for closer spacing. Efforts will be made to keep technology and procedures simple. Preference should also be given to demo participants.

Research will be necessary to determine experimental corridors; design tubes and procedures, pair-wise separation protocols, and abnormal procedures; redesign airspace; identify equipment requirements; and prove interoperability.



### **Other Concepts (Slides 16 – 18)**

The highly interactive dynamic planner concept features dynamic air-ground trajectory negotiation (a la DAG-TM) with 4-D trajectories that facilitate self-separation. This concept evolves from the tube, but many issues still exist.

The market-based system involves the allocation of “slots” via public auctions. By employing strategic, near-term, and spot auctions, it may also be possible to put a price on runway occupancy. Eventually, this could ensure that peak runway loading is reduced to government-mandated safety standards and capacity-optimized schedules. This will force the aircraft size to be driven by a combination of airline profits and maximum emplanement opportunities.

The regional airport system concept’s objective is to increase the capacity of high-demand regions, especially where primary airport expansion is limited. Initially, regional/alternative airports are being examined. To be effective, this concept will require multi-modal transportation concepts.

### **Autonomous IMC Operations Concept (Slides 19 – 21)**

By 2025, there will be no “low-density” regions left, and there will be too many planes for ATC as we know it today. A Class Q, or automated airspace, will be established below 17,000 feet. Separation will be the responsibility of the aircraft and all aircraft will be fully equipped and capable of handling weather problems with advanced avionics and visualization tools. The ground will primarily provide a monitoring function. Traffic management will be limited to control of density, and Class Q airspace will be segregated from high-density airspace (Class A).

To facilitate a transition, mandating equipment that can effect acceleration must be considered. It is expected that Class Q airspace will grow to higher altitudes; however, a clear transition path must exist. Capstone or Safe Flight 21 transition models are inadequate. Small, but typical, “trial” regions will be necessary to prove the concept.

Research is necessary into airspace density limits (for safety) and failure modes (what they are, how to use them, what is the ground/satellite infrastructure, what ground ATM function is needed, how to co-exist with the rest of the ATC system, how to use SATS).

### **Autonomous “SATS” Airports (Slide 22)**

The goal of SATS is higher instrument meteorological condition (IMC) rates at non-towered airports. An hourly rate of 10-15 operations is needed. Research issues include feasibility, hourly rate to be achieved, avionics requirements, use of WAAS, the need for ground-based system for control, what to do about unequipped aircraft, and the interface to the rest of the ATC system.

### **Continue Current ATM Paradigm, “Muddling Along” (Slides 23 – 24)**

Attention will need to be focused on the issue of “muddling along.” The cost of doing the same things in the same way will lead to a system that cannot meet the

demand and will lessen the economic benefits of aviation. Non-part 121 will slowly be driven out of the transportation business and it is likely dispatchers will do more ATM in this scenario. Research is needed into WAAS enhancements, better information flow, common situational awareness, moving CDM to tactical, separation standards, and given knowledge of intent. The bottom line is that this is a band-aid that will have a negative effect on the economy.

### **Crosscutting Research to be Done (Slide 26)**

The following is an incomplete list of crosscutting research topics that need to be studied:

- understanding of the current system
- separation standards
- reduction of capacity variability
- how to deal with major anomalies
- total system performance
- transition, selection and training of controllers
- human factors

### **Synopsis of Questions and Answers for Dr. Zellweger**

After the presentation, Dr. Zellweger responded to questions from NRA participants as follows:

**Question:** How do you prioritize research?

**Answer:** It is not prioritized yet but this will be done.

**Question:** What is the life span of concepts?

**Answer:** This was not considered.

## 20.

### Breakout Session No. 1—Technology Roadmap

**Facilitators: Mr. Joseph Del Balzo, Dr. Kevin Corker, Mr. Earl VanLandingham**

A copy of their reports is attached as part of the appendix and is available on the Web site.

For the Breakout Session No. 1, the workshop participants were divided into three groups. Each group was asked to respond to the following four topics related to the creation of a “technology roadmap” for the development of the new airspace capacity concepts:

1. What is the purpose of the technology roadmap? Is it a tool for decision makers? Why do we need it?
2. What should a technology roadmap contain?
  - Timelines for technology insertion?
  - Probable cost for required research, development, and implementation?
  - Performance goals of a future ATM system?
  - Research options? Identification of key enabling technologies?
  - Socio-economic projections/assumptions? Dynamically mapped and adapted to changing projections/assumptions?
  - Socio-political activities necessary to implement the concept?
3. Where do transition plans fit into the roadmap? Is it a part of the roadmap?
4. Should the format of the technology roadmaps change to include a different emphasis for each phase of the project? What should the roadmap look like for each phase? What should the roadmap look like at the end of the project?

**Answer:** After the groups met, the facilitators for each group gave a 5- to 10-minute report on the key concepts discussed by their group. All agreed that having a technology roadmap was a good idea and additional detail for the roadmap should be supplied as the project progresses. There was a suggestion that more discussion of the technology roadmap be held at the next TIM. In addition, the participants generally agreed that the project needs to focus on more than technology issues if the concepts are to be fully implemented. For the VAMS Project to succeed, political, policy, environmental, legal, cost, human factor, weather issues, etc., also needed to be addressed.

Other comments included the following:

- A technology roadmap starts as a functional statement and then iterates into a specific technology.
- A technology roadmap should be updated iteratively and changed in form by project phase.
- The end result of using a roadmap needs to be standardized.
- All concepts should have the same functional architecture and roadmap.
- A roadmap identifies long technology poles and helps prioritize research; It should contain critical decision points.
- A roadmap provides guidelines and a timeline; it is different from the project plan.
- NASA needs to know what technology is required to be developed.
- Technical personnel need confirmation that they are on the correct track.
- The roadmap should contain key technology, functional architecture components, time frame, performance objectives, application of technology, measures of accuracy required, and cost.
- Key, essential technology needs to be established.
- A concept's viability and cost estimates are needed.
- The types of expertise that is required to implement different concepts need to be studied.

## 21.

### **The Advanced Air Transportation Technologies (AATT) Project: Distributed Air-Ground Traffic Management (DAG-TM)**

**Dr. Richard Mogford  
NASA Ames Research Center**

A copy of Dr. Mogford's presentation is attached as part of the appendix and is available on the Web site.

#### **Key Comments by Dr. Mogford**

##### **Background (Slides 1 – 7)**

This presentation presented an overview of active Distributed Air Ground Traffic Management (DAG-TM) work and reported on its overall progress to date. It does not include details on the concept elements (CEs).

The team includes NASA Langley and NASA Glenn Research Centers.

The DAG-TM research project is defined (see slide 3) as a concept development and definition project and no tools will be delivered.

The project is gate-to-gate but is also broken down into discrete concept elements that are segments of the gate-to-gate system. Of the 14 concept elements, three are being explored actively: CE-5, CE-6, and CE-11. VAMS could activate some of the other CEs if they are relevant to a capacity solution. DAG-TM will eventually transition from an AATT project to VAMS.

##### **Overview of CE-5 (Free Maneuvering for User-Preferred Separation Assurance and Local TFM Conformance) Presented (Slides 7 – 9)**

CE-5 is based on the premise that future demand will grow such that current ground-based ATC cannot accommodate all the requests for changes. The flight deck will get new equipment that will allow aircraft to self-separate and deviate from the flight plan or flight path. This assumes the existence of some ADS-B/GPS-type technology that will provide a technical basis for this equipage. The aircraft will manage its own trajectories (altitude and path), while ground-based tools will monitor separation.

The two animations shown to demonstrate benefit are examples of before (today's system) and after (how the system could operate).

##### **Overview of CE-6 [En Route (and Transition) Trajectory Negotiation for User-Preferred Separation and Local TFM Conformance] Presented (Slides 10 – 11)**

In contrast CE-6 is more ground-based, but has a very similar effect/benefit to CE-5. The controller clears the aircraft request change. It is assumed to be

automated through some FMS-to-ground-based tool exchange/negotiation. Onboard function initiates maneuver and monitors compliance with the cleared change.

An animation shows the trajectory negotiation between the aircraft and ground.

### **Overview of CE-11 (Self-Spacing for Merging and In-Trail Separation) Presented (Slides 12 – 14)**

CE-11 reduces the excessive spacing on final airport arrivals. A properly equipped aircraft allows the tightening up of spacing using maneuvering and self-merging algorithms. ATC monitors the overall spacing and parameters used.

An animation shows examples of CE-11 and its potential benefit.

**DAG BENEFITS.** The CE-5 self-management aspect support scalability and improved flexibility of the system. Failure modes will be included in CE evaluations.

**NASA DAG RESEARCH.** This slide identifies the work breakout for the DAG-TM project. ARC is mostly pursuing ground-based air traffic control aspects of CEs-5 and 11. LaRC is examining flight deck aspects of CE-5 and CE-11. (GRC work was not discussed.) ARC is also working on CE-6. Each team is pursuing parallel research but the integration of these efforts is planned to begin soon.

### **Research Concepts and Scenarios (Slides 18 – 22)**

These graphics represent how the research is planned to start with the basic scenario and then add complexity over time. This complexity will increase with the addition of static weather, and then increase again when dynamic weather when a Special Use Area (SUA) is added. There will be limited delegation of self-spacing and merging in the TRACON environment. The effort is focused on airspace leading to TRACON.

### **Facilities and Past Results (Slides 23 – 41)**

Ames and Langley facilities for pursuing DAG-TM research are presented. ARC will focus on research involving human factors. LaRC is working on algorithms and the past results from tests run at LaRC (AUTRII and ATAAS experiments) are discussed in terms of flight crew testing of the flight deck concepts and tools.

### **Synopsis of Questions and Answers for Dr. Mogford**

After the presentation, Dr. Mogford responded to questions from NRA participants as follows:

**Question:** Where is the transition zone of CE-5?

**Answer:** The boundary is at the edge of terminal airspace, plus from non-managed to managed airspace. This is a challenge to manage.

**Question:** Will the DAG program be continued by VAMS?

**Answer:** Harry Swenson: Yes.

---

**Comment:** Richard Mogford: We will put you on the DAG-TM mailing list, if you want. Documents are on the Web site.

**Comment:** Harry Swenson: Information on the dynamic weather server is now available. Dr. Mogford: Yes, it is a very rich set of data.

## 22.

### Daily Agenda Questions and Comments

**Mr. Harry Swenson**  
**VAMS Project Manager, NASA Ames Research Center**

Mr. Swenson encouraged participants of the TIM to forward any general questions and comments to him. He indicated he would provide the answers to the group during the Daily Agenda session on Day 2 and Day 3 of the TIM.

#### **Questions and Answers for Mr. Swenson during the Daily Session for Day 3:**

**Question:** Please clarify the VAMS Program goals and constraints regarding a common ground of concepts and implementation.

**Answer:** The VAMS program is not performing implementation of concepts. Concept developers are to complete their concepts including computer analysis.

**Question:** Since we have opened the door to changing ATC procedures, when will we open the door to discussing changes to AOC procedures (e.g. schedules)?

**Answer:** The door to AOC procedure changes has already been opened with the Point to Point concept proposed by Seagull Technologies.

**Question:** Can we get demographics study data and projections from SATS so that we can better understand demand in the future?

**Answer:** Yes, the data will be coming via the Airspace Systems Program Office.

**Question:** What is the long term plan to manage and disseminate concept updates to the supporting SEA and VAST teams?

**Answer:** TIMS will be a part of the dissemination process. In addition, program documentation will be available to all parties via distribution on common servers. The details of this distribution will need to be worked out.

**Comment from the floor:** The maximum capacity (and throughput) operational point is not necessarily the cost optimal operating point of the system.

**Comment from the floor:** SEA and VAST need to understand concept evaluation requirements sooner rather than later.

**Comment from the floor:** The VAMS TIM introduction mentioned concepts without implementation, but several projects have already been implemented, or plan field testing or implementation in the future.

**Comment from the floor:** There is a need multiple copies of handout book electronically

- Participants will take the old version first; and get a new version later



**Comment from the floor:** Please make the printed slides larger in the handout book. Most slides are unreadable.

- The notes space is not needed
- The margins could be much smaller.

## 23.

### **Breakout Session No. 2—Metrics/Scenarios**

**Facilitators: Mr. Joseph Del Balzo, Dr. Kevin Corker, Mr. Earl VanLandingham**

A copy of the breakout summary presentations are attached as part of the appendix and are available on the Web site.

Along with concept developers, the Systems Evaluation and Assessment (SEA) sub-element of VAMS will develop those scenarios and metrics required for testing the new concepts that reside within the System-Level Integrated Concepts (SLIC) sub-element in the VAMS project. These concepts will come from the NRA process, space act agreements, a university group, and other NASA researchers. The emphasis of those concepts is to increase capacity while at least maintaining the current safety level.

The concept providers will initially develop their own scenarios and metrics for self-evaluation. In about a year, the SEA sub-element will become responsible for conducting initial evaluations of the concepts using a common scenario and metric set. This set may derive many components from the scenarios and metrics used by the concept providers. Ultimately, the common scenario/metric set will be used to help determine the most feasible and beneficial concepts.

A set of 15 questions and issues, discussed below, pertaining to the scenario and metric set, and its use for assessing concepts, was submitted by the SEA sub-element for consideration during the breakout session. The questions were divided among the three breakout groups. Each breakout group deliberated on its set of questions and provided a report on its discussion.

#### **BREAKOUT GROUP A**

##### **1. What should we consider for our baseline scenarios and metrics?**

**Answer:** The baseline scenarios should be sufficient to address the 2x and 3x goals defined for VAMS. A question was raised in the group as to whether the OEP 2010 goals should also be considered for the baseline scenario definition.

At a high level, the baseline metrics should consider: cargo passengers and operations; passenger miles per unit of time; number of operations; average delays; economic value; operational costs; safety; environment considerations; trip time; and activity metrics.

##### **2. What are the special considerations for real-time and non-real-time scenarios?**

**Answer:** The answer to this question is not straightforward. The group determined that many questions needed to be addressed first. These questions include the following:

- What are the set of questions VAMS needs to answer?

- Does a difference exist between real-time and non-real-time scenarios?
- Does VAMS need different scenarios for real-time or non-real-time?
- When would a real-time scenario be used? When would a non-real-time scenario be used?

**3. What are the special considerations for real-time and non-real-time metrics?**

**Answer:** The answer to this question was developed after the group considered why the real-time metrics are different from the non-real-time metrics. Metrics to be collected during a simulation depend on the kind of scenario and the particular parameters expected to provide the researchers a measure of quality. . The metrics will also depend on the concept question, objective, level of detail, and scope. Some metrics for a concept cannot be measured in both a real-time scenario and a non-real-time scenario. In addition, the instrumentation used to collect the metrics measurements may be different in a real-time environment than in a non-real-time environment. A consideration for cost, availability of resources, and repeatability must be included in determining real-time and non-real-time metrics. The group provided examples of real-time and non-real-time metrics in the report out.

**4. What mixes of aircraft capability need to be represented in the scenarios?**

**Answer:** The group determined that the concept scenarios must address all aircraft relevant to that domain over a range of capabilities. Capabilities to be considered include aircraft performance, equipment capability such as Traffic alert and Collision Avoidance System (TCAS), aircraft type such as tilt rotor, and UAV. The emphasis needs to be placed on instrument flight rule operations.

**5. What CNS capabilities need to be represented in the scenarios?**

**Answer:** The group determined that the concept scenarios must address all CNS relevant to that domain over a range of capabilities. How the CNS capabilities are modeled or included in the scenario will depend on the concept question being addressed. Consideration should be made to represent the NAS architecture that is expected in the 2020 timeframe.

In summary, the group determined that the choice of scenarios and metrics depends on the VAMS concept area being addressed. The individual concept questions must clearly be defined before the development of scenarios and metrics can be determined.

**BREAKOUT GROUP B**

**6. What amount of traffic should we assume for our scenarios?**

**7. What amount of traffic should we assume for our metrics?**

**Answer:** The group combined these two questions into one and recommended that the scenario developers be mindful of a distinction between real-time

scenarios and non-real-time simulation requirements. These differences are related to the human variability in the scenario environment and the fidelity of the NAS system response required in the evaluation of a concept.

The traffic demand model will depend on the concept's influence on the capacity solution or business case. This applies to the real-time scenarios as well as the non-real-time scenarios. The traffic load should be scalable to the goals set with ASP and VAMS. A complexity factor (1x, 2x, 3x) should be considered in the scenario development.

#### **8. How long do the scenarios need to be to reflect realism for our concepts?**

**Answer:** The group determined the length of a specific scenario depends on whether the simulation is real-time or non-real-time. In a non-real-time scenario, the duration of a scenario should approximate a day's worth of time and this could range from 2 to 26 hours. In addition, since traffic loads vary depending on the day, the scenarios should have multiple "days" defined. The resolution of necessary scenario data (milliseconds or minutes) will depend on the concept under evaluation.

In a real-time environment the length of the scenario could be anywhere from 10 minutes to 2 hours. The duration will depend on the concept under evaluation. The duration will also depend on whether the scenario requires a NAS-wide simulation or is site specific. It is recommended that guidelines be established to facilitate the determination of a scenario duration. Guidelines should also include the durations required for local single concept events, pulse events such as an airport rush, and NAS-wide concept evaluations. It was generally agreed that durations for fatigue events or capacity strain evaluation could go as long as 8 hours.

#### **9. How do we try to ensure buy-in from the stakeholders regarding the validity of our scenario and metrics?**

**Answer:** The stakeholder community will include a range of users from the current concept developers to the super-users of the concepts and to any future users the concept will create. The start of stakeholder buy-in may come from using demand models provided by the airline community. The current set of practitioners can assist in the scenario buy-in by assisting with the definition of roles and responsibilities of those who will be the end user of the concepts.

The timing of the introduction of the new concept into the NAS will have an effect the buy-in of the concept and the scenarios used to validate it, and may be assisted by the use of the cadres of controllers.

#### **10. What are the "challenge" events that are relevant for these scenarios (e.g., choke points, weather)?**

**Answer:** The list of challenge events for scenario consideration should include: weather, failure modes, system shutdown conditions, military operations with NAS, security events, demand load variability such as holiday travel conditions,

airspace sectional loss, information infrastructure events, data integrity, and equipment-dependent failures. In addition, other conditions occur that may require exploration, but are not necessarily considered challenge events; these include the use of collision risk models, formation flying, and how tight the scenarios should be coupled. These should be addressed in a validation plan for the concept under evaluation.

### **BREAKOUT GROUP C**

#### **11. What are the “challenge” events relevant for these metrics (e.g., choke points, weather)?**

**Answer:** The group interpreted a “challenge event” to be a perturbation that must be included in the scenarios during the execution of the simulation of the concept. The important capacity metrics should include: weather events, schedule events for which demand exceeds capacity, scheduled and unscheduled outages, human error events, terrorist events, resource loading events, environmental factors, aircraft mix, airspace restrictions such as airspace closures or special use areas (SUA), runway events, wake vortices, different separation events, and labor/union events.

#### **12. What are the measures that need to be addressed in the scenarios? (These should consider economic, safety, security, environment, and human performance factors.)**

**Answer:** The group provided a list of various measures that need to be addressed in the scenarios. This list includes delay measures; passenger, cargo, and aircraft throughput; cost and cost allocation measures; equity; safety metrics; access measures; unused capacity; system stability; predictability; environment measures; passenger satisfaction; staffing measures; efficiency; sector density; and political constraints or public mandates.

#### **13. What are the technical challenges in scenario development?**

**Answer:** The group assumed technical challenges were framework issues (not events) that need to be considered in the development of scenarios. The list of challenges for scenario development include: schedules; demand; fleet mix; weather conditions; discernability of the phenomena; appropriate complexity/fidelity; ability to capture variability in procedures; scenario relevance to the concept; accurate reflection of the airline’s business case; non-normal operations; and human factors representation. In addition, a clear statement of the scenario objective should exist. The scenario should contain a representative set of conditions for concept evaluation.

#### **14. How do we ensure the appropriate testing of the concepts that include only one domain versus those that are gate-to-gate?**

**Answer:** The group provided a number of specific recommendations that must be considered in testing the concepts; however, some open issues were identified that are related to the question. Open issues that should be considered are

incompatible concept/system architectural issues and how to know when the concept has been tested enough.

**15. Since we will have multiple scenarios, how do we ensure some comparability between them so we can fairly test some single domain versus gate-to-gate concepts?**

**Answer:** To answer this question, the group determined that certain assumptions would have to be made. It must be assumed that the scenarios to be developed will facilitate the concept-blending process planned for later phases of VAMS. It must also be assumed that the scenarios to be developed are to be used for evaluation and validation of the concepts.

## 24.

### **Breakout Session No. 3—Guidelines**

**Facilitators: Mr. Joseph Del Balzo, Dr. Kevin Corker, Mr. Earl VanLandingham**

For the Breakout Session No. 3, the workshop participants were divided into three groups. Each group was asked to respond to the following six questions in three categories related to the creation of “guidelines” for the development of the new airspace capacity concepts.

#### **Breakout Session No. 3 Agenda, Six Questions in Three Categories**

##### Guidelines:

1. Can we achieve greater clarity on the descriptions of the guideline elements
2. Are the concept guidelines sufficient and necessary to meet project goals?

##### Concept grading guidelines and procedures:

3. Does the concept-grading guidelines and procedures provide the necessary feedback to the concept development process?
4. What clarifications are necessary?

##### GFI model of ATM functions:

5. Can the GFI model of ATM functions be improved to account for major paradigm shifts in the operation of the ATM?
6. Is the GFI model sufficient to blend, model, analyze, and assess the current collection of concepts? What more is needed?

#### **1. Can we achieve greater clarity on the descriptions of the guideline elements?**

**GROUP A:** Yes, but we suggest a change in the order as follows:

- Area 1: issues and operating domain (concept specific), quantitative goals
- Area 2: core ideas, assumptions
- Area 3: functions, performance, human factors (roles and responsibilities of persons and machines, user interfaces), system integrity and redundancy
- Area 4: architecture, technology requirement, challenges, transition plan (roadmaps)
- Area 5: NAS operational risks: security, safety

- Area 6: benefits/metrics, cost/metrics, conceptual competitors

**GROUP 2:** No response

**GROUP 3:** Probably, but the following obstacles were noted:.

- The functions in element (area) 2 for the top-level description do not follow through in the detail area (element 3).
- The GFI functional model is too constraining.
- A better set of definitions (VAMS terminology) is needed.
- Sector overload, capacity, throughput, demand, delay, etc.
- In element (area) 6, conceptual competitors is another term that needs clarification:
- Is this like the price of fuel going so high or some breakthrough in telecommuting lowering the demand for flying?
- What is NASA's intent for the information on the "conceptual competitors"?

## **2. Are the concept guidelines sufficient and necessary to meet project goals?**

**GROUP 1:** Assuming the project goal is to develop a blended unified concept at the end of Phase Four, the guidelines may be adequate, however:

- Not enough information exists to trade off parameters.
- Concepts address different aspects of NAS.
- Individual concepts may employ different scenarios and/or metrics.
- Mapping concepts to GFI helps but this will not ensure blending.
- It is difficult to fit concepts to the GFI top-level model.

**GROUP 2:**

- There lacks an explicitly defined compatibility link.
- Goodness may subsume costs and benefits.

**GROUP 3:** Yes, they are necessary. For now, the concept guidelines are sufficient, but this will need to be reviewed as the project evolves and prioritization of the guideline elements is needed:

- The importance of political and legal aspects should be higher.



- Area 3, “Human Factors,” should be “Human Performance.”
- Area 4, “Architecture,” should have a lower priority.
- Area 6, “Conceptual Competitors,” should probably have a lower priority. Maybe this should be an Area 1, “Issues” item.
- Prioritization should be a “living” attribute through the life of the program.

**3. Do the concept-grading guidelines and procedures provide the necessary feedback to the concept development process?**

**GROUP 1:** Yes

**GROUP 2:**

- A set of standards for grading is needed to level the playing field.
- Proper combination of criteria (weighting, etc) has to be developed to perform the assessment.

**GROUP 3:** Maybe, with the clarifications noted below.

**4. What clarifications are necessary?**

**GROUP 1:** Nothing.

**GROUP 2:**

- Clarifications are needed for the following terminology: practical; definable; self-diagnostic; constructible; documented; revolutionary; accurate; compatible; model able.
- Terminology that should *not* be on list as applicable to an OPSCON: constructible, compatible (with what?), accuracy.

**GROUP 3:**

- We assume that these are the evaluation criteria on page 3 of handouts.
- More explicit mapping is needed of concept guidelines to the evaluation criteria.
- Definition of criteria is needed.

**5. Can the GFI model of ATM functions be improved to account for major paradigm shifts in the operation of the ATM?**

**GROUP 1:** This cannot be answered until it is known what paradigm shifts will occur.

**GROUP 2:** The GFI Model lacks the following:

- Airports as a dedicated aggregate
- Domains of the transportation system
- Utility increases with intermodal considerations (transportation system: air, ground, quantum)
- The passenger/payload in the model
- A higher level of abstraction for information function
- Allocation
- Quantification
- Demand function

**GROUP 3:** Yes, but:

- It seems disconnected from the VAST architecture.
- Should we drive deeper into the GFI model or VAST architecture?
- A better understanding of VAST architecture is needed.
- Is there a plan for convergence?
- The model needs to accommodate the drawing of domain boundaries.

**6. Is the GFI model sufficient to blend, model, analyze, and assess the current collection of concepts? What more is needed?**

**GROUP 1:** No, because:

- It is not domain specific.
- Concepts do not always map cleanly/clearly into it.
- Lower level models are needed and may be more difficult to map.
- It is already busy.
- It does not describe the operational concepts behind the concept.
- It does not help present/explain/describe the concept.
- After the concept is developed, you could organize it this following the GFI model since it helps simulation but does not help define concept.
- The current GFI model will not help to blend all the current concepts -- more detail is needed.
- After year one we will have a better idea how to schematically communicate ideas in a common framework.

**GROUP 2:** Yes, but it needs further decomposition as follows:

- Matrix/vector compatibility within each function (reference Corker compatibility charts: high level, low level)
- Differentiate the tools from OPSCONs to support cross-OPSCON evaluation

**GROUP 3:** No, because it needs:

- A hierarchically decomposed model with more details.
- Other things for blending.
- Common scenario definitions.
- A comparison of assumptions.
- Analysis of incompatibilities, unions, intersections, and synergisms.

## 25.

### **VAST Prototype Demonstration**

**Dr. Karlin Roth and Mr. Ray Miraflor  
NASA Ames Research Center**

Dr. Roth and Mr. Miraflor presented the current status of the VAST prototype to the NRA participants. Dr. Roth made the following points before Mr. Miraflor performed the demonstration:

1. Excellent models are available but they are deficient in what is needed to understand gate-to-gate, and system-level effects. NASA has selected an approach that leverages DOD investments in modeling and simulation, supports the re-use between fast- and real time simulations and captures interactions among system entities.. The VAST prototype development effort started in October 2001 and completed a proof-of-concept demonstration in February 2002. The goal for Build-1 of the software is to establish the fundamental architecture that can be scaled and extended to address the needs of all the VAMS concepts.
2. Feedback is requested from the NRA participants on the VAST modeling and simulation requirements and the questions that this new system should be designed to answer
3. Everyone needs to have realistic expectations for the VAST modeling and simulation system. We are on an aggressive path that has developed an initial prototype in 4 months on the ATMSDI contract. The initial prototype runs on a distributed platform consisting of three PC workstations and on a laptop in a standalone mode for demonstration purposes. Build-1 is scheduled to be delivered in October 2002, and will contain a suite of low-fidelity models. NASA will continue to evaluate feasibility of the modeling approach and to set model validation practices using Build-1. Based on timing, new concepts unveiled at this TIM can be incorporated in later releases during FY03-04. NASA will need inputs from the concept developers to set modeling requirements for these later releases.

Mr. Miraflor: The existing prototype is demonstrated. It contains five federates and is designed to run on three PCs. The demonstration's data contains 500 managed flights (ATC-governed flights) and 500 unmanaged (free flights). The demo can be run in real-time or non-real-time.

In particular, the flight path of two aircraft is shown. One aircraft is managed and follows waypoints, while the other is unmanaged and goes directly to its destination. The system models the effect of ATCSCC directives on these flights including setting the sector capacity to "zero". (The managed aircraft requests permission to enter the sector whereupon the ATC denies the request and the

aircraft is put in a holding pattern. The unmanaged flight goes around the sector.) How a controller gives a command to an aircraft to go to a different waypoint was also simulated.

The data collected is performed by the data collection federate. The data includes metrics for managed and unmanaged aircraft (including conflicts and aircraft flight information).

### **Synopsis of Questions and Answers for Mr. Miraflor**

After the presentation, Mr. Miraflor responded to questions from NRA participants as follows:

**Question:** What are your data collection needs?

**Answer:** It is expected that the POET tool will be needed to collect data from the existing ATC system.

**Question:** What is the total number of airplanes that could be simulated in the presence of weather?

**Answer:** This has not been determined yet. Currently we are simulating 1,000 aircraft.

**Comment from floor:** The use of DOD standards such as HLA and distributed systems have had mixed results in the past.

**Comment from floor:** NASA expects to leverage the big investment DOD has made in HLA and leverage previous SAIC experience with DOD simulation systems.

**Question:** What are the bottlenecks in processing?

**Answer:** Currently the simulation slows down as the number of aircraft increases. Interprocessor communication may also slow the system's performance down.

## 26.

### **Socio-Economic and Demand Forecasting**

**John A. Cavolowsky, Ph.D.  
NASA Ames Research Center**

A copy of Mr. Cavolowsky's presentation is attached as part of the appendix and is available on the Web site.

#### **Key Comments by Dr. Cavolowsky**

##### **Introduction (Slides 1 – 7)**

VAMS is responding to heightened national needs. Socio-economic and demand forecasting research project complements the other NASA VAMS technology research projects by identifying the demonstrable benefits needed by stakeholders. An intermodal perspective and operational-level scenarios are being used to understand the role of transportation in general and air transportation in particular within the U.S. economy. Currently there is a 6-month effort underway with support from the Logistics Management Institute, Gellman Research Associates, Volpe National Transportation System Center, and affiliated consultants and universities to identify transportation scenarios with the greatest probability of being realized. These scenarios, along with driving forces and uncertainties, can predict air travel demand volume and its distribution.

##### **Ongoing Research (Slides 8 – 19)**

Research is being conducted in three parts:

1. Create a description of the current state of knowledge on the relationship between transportation and the economy (see slides 9 and 10). In particular, identify strengths and weaknesses of past studies and models.
2. Revise, update, and expand current transportation scenarios to reflect current and future conditions (see slides 11 to 16). Focus on demand drivers and supply issues to align demand to scenarios. Current existing forecasts run from 10 to 50 years.
3. Develop a set of demand forecasts for each defined scenario (see slides 17 to 19). The volume of air travel is a function of the overall health of the economy, demographic trends, security issues, and the relative attractiveness of competing surface modes.

##### **Follow-on Activities (Slides 20 -29)**

Follow-on activities are to include the identification of institutional factors and societal concerns affecting changes in the aviation system as well as identification of inhibitors to system improvement.

### **Synopsis of Questions and Answers for Mr. Cavolowsky**

After the presentation, Dr. Cavolowsky responded to questions from NRA participants as follows:

**Question:** How far are you projecting demand?

**Answer:** Projected demand is 20 years.

**Question:** Are you making forecasts of both point-to-point and hub-and-spoke systems?

**Answer:** Gellman Research Associates models do some of this.

**Question:** Will other studies such as terminal area forecasts supply much of the data he needs?

**Answer:** That will be determined after studying the existing literature.

**Question:** When will a rough forecast be available?

**Answer:** A product is expected at the end of the calendar year 2002.

**Question:** Are SATS data and studies available?

**Answer:** This is uncertain, but their availability will be determined.

## 27.

### Next Steps in Concepts and a Preview of TIM 2

**Harry Swenson**  
**VAMS Project Manager, NASA Ames Research Center**

A copy of Mr. Swenson's presentation is attached as part of the appendix and is available on the Web site.

#### **Key Comments by Mr. Swenson**

The amount of participation and feedback the group presented is encouraging. The next TIM is scheduled for August 27-29, 2002. The technical presentations will include the following subject areas:

- Developing VAST capabilities
- Airspace concept evaluation system – Build-1 requirements
- Real-time HITL
- Human and team modeling
- CNS Modeling
- Scenarios and metrics
- Other revolutionary ideas

#### **Synopsis of Questions and Answers for Mr. Swenson:**

After the presentation, Mr. Swenson responded to questions and comments from NRA participants as follows:

**Comment:** The team requests feedback from the VAMS Project Office as to guidelines and direction that come out of TIM No.1. In particular, 1) definitions are needed and 2) roadmap clarifications are required.

**Answer:** The VAMS Project Office will provide this direction.

**Question:** The contract calls for a specific amount of TIM attendance per phase. VAST TIM is not included as the second TIM. No contractor deliverables exist for the VAST TIM. Is there another TIM with deliverables for this phase?

**Answer:** Yes, the next contractual TIM is planned for January 2003.

**Question:** The preliminary concept is a contract deliverable. Does the deliverable need all sections filled in or should contractors provide what they have at the time? Some sections may not have a lot of content. This is a project milestone.



**Answer:** The Project Office needs to inform concept developers and contractors of specific requirements for this deliverable.

## 28.

### **Summary of Recommendations for Future Technical Interchange Meetings—5/23/02**

#### **Breakout Sessions**

- Facilities: Include a slide projector capable of being driven by a laptop for each Breakout session:
  - This facilitates group agreement by presenting the draft material to the entire group for corrections.
- Consider running all breakout session topics concurrently, e.g., roadmaps breakout session (and the same for each of the three topic areas) held during each of the three breakout sessions, rather than having all the breakout topics at any given time addressing the same topic.

#### **PRO:**

- This allows the NASA coordinator to attend and “resource” all breakout sessions of his or her topic.

#### **CONS:**

- The “discussions in the hallway” could be minimized (e.g., a given topic is on everyone’s mind since they have all just discussed the same topic).
  - This may cause lower participation in the later breakout sessions since the topics will no longer be new topics to the whole group. It will be easier to justify that one has heard enough from that topic just by talking with others, or that a given topic area was not very worthwhile just because one of the earlier sessions in that topic area was not productive.

#### **Presentation Slides Available to Note Takers Before a Presentation**

- This worked very well except for about three presentations for which slides were unavailable. Note taking was seriously degraded for these presentations.
- Note takers must have a hard copy *of all presentations* before the talk is given, even if the conference staff has to make those copies in real-time and then bring them to the note takers before the presentation can begin.
  - Format for note taker’s notebook: single slide occupying the first page, with the other page ruled for notes, printed double sided, and GBC-bound

- The original PowerPoint versions of the slides are needed to produce this format.
- Graphics in the presentations, such as drawing objects, can make the files very large, and hard to work with. We suggest giving presentation authors guidance to convert all drawing objects to simple “pictures” as a final step in production of their slides to minimize the sizes of the PowerPoint files. As an example, the Sorenson presentation (which contained a lot of MS Drawing objects) was reduced in file size using this technique from more than 15MB to less than 1MB.
- Printing of the note taker’s notebook: at the “gray-scale” option should be used in the print window, since otherwise a black-and-white print has a tendency to print the color pictures as all black. It is best to originally print each note taker’s book, since copier machines will totally blacken even most gray-scale figures.
  - Printing of a slide file name (author\_organization\_one-word-topic.ppt is our recommendation for a file-naming standard) as a footer on each slide will help note taker find slides quickly.
  - All slides must be page-numbered (even if submitted without page numbers) to facilitate communication and referencing.
  - It may be necessary to have the note taker’s name as a footer of the note taker’s notebook. This is not much extra effort due to the original printing of each note taker’s notebook. (We did not have this, but it allows for a note taker to simply Xerox his notes and hand them to the lead note taker for that session on the day of the talk.)
- Process for generation of the minutes: electronically transcribing notes is probably the best approach for many reasons, including:
  - Distribution
  - Configuration management
  - Ensuring that the note-author provides intelligible notes to the section leads
- Evaluation of TIM by attendees:
  - This was not done. A suggestion is to include an evaluation questionnaire to obtain good ideas.

■ Action items:

<b>Action Item</b>	<b>Assigned to</b>	<b>Due Date</b>	<b>Comments/ Resolution</b>
Discover if there is a way to compress bit-image graphics on PPT slides, without losing the ability to edit the slides.	H Sielski	Aug. 15, 2002	Closed 6/24/02 -- Suggestions developed for presentation authors.

## *Appendix A*

### *NASA VAMS Project TIM No. 1*

#### *Acronyms*

---

AAC	Advanced Airspace Concept
AACS	Automated Airspace Computer System
AATT	Advanced Air Transportation Technologies
ACES	Airspace Concept Evaluation System
ADS-B	Automatic Dependent Surveillance-Broadcast
AOC	Airline Operations Center
ARC	Ames Research Center
ARTCC	Air Route Traffic Control Center
ASP	Airspace Systems Program
ATC	Air Traffic Control
ATCSCC	Air Traffic Control System Command Center
ATM	Air Traffic Management
ATMCP	Air Traffic Management Operational Concept Panel
ATN	Aeronautical Telecommunications Network
ATMSDI	Air Traffic Management Software Development and Integration
ATSP	Air Traffic Service Provider
AVOSS	Aircraft Vortex Spacing System
AvSTAR	Aviation System Technology Advanced Research
CDM	Collaborative Decision Making
CDTI	Cockpit Display of Traffic
CE	Concept Element
CNS	Communications, Navigation and Surveillance
CTAS	Center/TRACON Automation System
CTOC	Centralized Terminal Operation Control
DAG-TM	Distributed Air Ground Traffic Management
DFW	Dallas/Fort Worth International Airport
DOD	Department of Defense
DST	Decision Support Tool
FACET	Future ATM Concepts Evaluation System
FD	Flight Deck
FF	Free Flight

FMS	Flight Management System
FOC	Final Operating Capability
FOM	Federates Object Model
GA	General Aviation
GFI	Government Furnished Information
GO-SAFE	Ground-Operation Situation Awareness and Flow Efficiency
GPS	Global Positioning System
GRC	Glenn Research Center
HITL	Human-In-The-Loop
HLA	High-Level Architecture
HTP	Human Team Performance
ICAO	International Civil Aviation Organization
IFR	Instrument Flight Rules
ILS	Instrument Landing System
IMC	Instrument Meteorological Conditions
LIDAR	Light Detection and Ranging
LOS	Loss of Separation
NAS	National Airspace System
NRA	NASA Research Announcement
NRT	Non-real-time
OEP	Operational Evolution Plan
POET	Post-Operations Evaluation Tool
PTP	Point-To-Point
R&D	Research and Development
RT	Real-time
RTI	Run-Time Infrastructure
RVSM	Reduced Vertical Separation Minimum
SATS	Small Aircraft Transportation System
SE	Systems Engineering
SEA	Systems Evaluation and Assessment
SHCT	Short-Haul Civil Tilt-rotor
SLIC	System-Level Integrated Concepts
SOAR	Surface Operation Automation Research
STOL	Short Take Off and Landing
SUA	Special Use Area
TACEC	Terminal Area Capacity Enhancement Concept

TAP	Terminal Area Productivity
TBD	To Be Determined
TCAS	Traffic alert and Collision Avoidance System
TFM	Traffic Flow Management
TIM	Technical Interchange Meeting
TRACON	Terminal Radar Approach Control
TSAFE	Tactical Separation Assurance Flight Environment
VAMS	Virtual Airspace Modeling and Simulation
VAST	Virtual Airspace Simulation Technologies
VSTOL	Vertical/Short Takeoff and Landing
Wake VAS	Wake Vortex Avoidance System

***Appendix B***  
***Attendee List***

Paul Abramson	PDA Associates
Anthony Andre	Interface Analysis Associates
Kenneth Arkind	Raytheon Company
Rose Ashford	NASA Ames Research Center
Stephen Atkins	NASA Ames Research Center
Ronald Azuma	HRL Laboratories
Robert Beard	Computer Sciences Corporation
Karl Bilimoria	NASA Ames Research Center
Matthew Blake	Seagull Technology, Inc.
Angela Boyle	Raytheon ITSS
Chris Brinton	Metron Aviation, Inc.
Wayne Bryant	NASA Langley Research Center
Karen Buondonno	Federal Aviation Administration
Brian Capozzi	Metron Aviation, Inc.
Burton Carniol	Metron Aviation, Inc.
Phillip Carrigan	Raytheon Company
Patricia Carroll	NASA Ames Research Center
Naomi Castillo-Velasquez	NASA Ames Research Center
John Cavolowsky	NASA Ames Research Center
Victor Cheng	Optimal Synthesis, Inc.
Jesse Clayton	Metron Aviation, Inc.
William Cleveland	NASA Ames Research Center
Kenneth Cobb	Raytheon ITSS
Thomas Cochrane	Raytheon ITSS
Kevin Corker	San Jose State University
George Couluris	Seagull Technology, Inc.
Goli Davidson	Metron Aviation, Inc.
Kevin Day	Northrop Grumman Information Technology
Joseph Del Balzo	JDA Aviation Technology Solutions
Dallas Denery	NASA Ames Research Center
Marie Dorish	NASA Ames Research Center
Donald Eddy	BAE Systems
Thomas Edwards	NASA Ames Research Center
Heinz Erzberger	NASA Ames Research Center
Todd Farley	NASA Ames Research Center
Greg Feldman	Northrop Grumman Information Technology
David Felio	Geneva Aerospace
John Fergus	Northrop Grumman Information Technology
L.S. Fletcher	NASA Ames Research Center
Robert Fong	NASA Ames Research Center
David Foyle	NASA Ames Research Center
Michael Freed	San Jose State University



Tsuyoshi Goka	Raytheon ITSS
Melinda Gratteau	Raytheon ITSS
Ty Hoang	NASA Ames Research Center
Becky Hooey	Monterey Technologies, Inc.
Alex Huang	Seagull Technology, Inc.
George Hunter	Seagull Technology, Inc.
Carla Ingram	Northrop Grumman Information Technology
Douglas Isaacson	NASA Ames Research Center
Mike Jackson	Honeywell Aerospace Electronic Systems
Robert Jacobsen	NASA Ames Research Center
Kevin James	NASA Ames Research Center
David Jara	San Jose State University
Matthew Jardin	NASA Ames Research Center
Charles Johnson	NASA Headquarters
Yoon Jung	NASA Ames Research Center
Kellie Keifer	Northrop Grumman IT
Rod Ketchum	Federal Aviation Administration ACB-100
Robert Kille	Computer Sciences Corporation
Richard Kirsten	Computer Sciences Corporation
Parimal Kopardekar	Titan Systems
Jimmy Krozel	Metron Aviation
Andrew Lacher	The Mitre Corporation
Michael Landis	NASA Ames Research Center
Victor Lebacqz	NASA Ames Research Center
Ronald Lehmer	Northrop Grumman Information Technology
Diana Liang	Federal Aviation Administration
Sandra Lozito	NASA Ames Research Center
Wayne MacKenzie	Federal Aviation Administration
Steven Mainger	NASA Glenn Research Center
Scott Malsom	NASA Ames Research Center
Lynne Martin	San Jose State University
P.K. Menon	Optimal Synthesis, Inc.
Mary Miller	Raytheon Company
Raymond Mirafior	NASA Ames Research Center
Sarah Nowlin	Northrop Grumman IT
Neil O'Connor	NASA Langley Research Center
Robert Padilla	NASA Ames Research Center
Mariano Perez	NASA Ames Research Center
Jack Perkins	Volpe National Transportation Center
James Poage	Volpe National Transportation Center
Martin Pozesky	MTP Associates
Leighton Quon	Northrop Grumman/Logicon
John Rekstad	Federal Aviation Administration
Roger Remington	NASA Ames Research Center
Paul Rigterink	Computer Sciences Corporation
Tom Romer	NASA Ames Research Center
David Rosen	Orbital Sciences

Robert Rosen	NASA Ames Research Center
Karlin Roth	NASA Ames Research Center
David Rutishauser	NASA Langley Research Center
David Schleicher	Seagull Technology, Inc.
Bob Schwab	Boeing Air Traffic Management
Barry Scott	NASA Ames Research Center
Tom Sharkey	Monterey Technologies
Marianne Shelley	NASA Ames Research Center
Henry Sielski	Computer Sciences Corporation
David Signor	Seagull Technology, Inc.
Alvin Sipe	Boeing Air Traffic Management Division
George Solomos	The Mitre Corporation
John Sorensen	Seagull Technology, Inc.
Edward Spitzer	Volpe National Transportation Center
Banavar Sridhar	NASA Ames Research Center
Edward Stevens	Raytheon Company
Douglas Sweet	Seagull Technology, Inc.
Harry Swenson	NASA Ames Research Center
Terrence Thompson	Metron Aviation
Leonard Tobias	NASA Ames Research Center
William Usab	Continuum Dynamics, Inc.
Earl Van Landingham	NASA Ames Research Center
Savita Verma	San Jose State University
Michael Wambsganss	Metron Aviation, Inc.
Chris Wargo	Computer Networks & Software, Inc.
David Waring	Boeing Air Traffic Management Division
Del Weathers	NASA Ames Research Center
Sheryl Wold	Raytheon ITSS
Daryl Wong	NASA Ames Research Center
Robert Yackovetsky	NASA Langley Research Center
Andres Zellweger	NASA Headquarters
Robert Zimmerman	Raytheon ITSS

*Appendix C*  
*Presentations*

This page intentionally left blank.

# Airspace Systems Program

## Virtual Airspace Modeling and Simulation Project

### Technical Interchange Meeting #1

**Robert Jacobsen**  
Director,  
Airspace Systems Program

May 21, 2002

1

## NASA's Aerospace Technology Enterprise

### Goals

- ◆ **Revolutionize Aviation**  
Enable a safe environmentally friendly expansion of aviation (Baseline: 1997)
- ◆ **Advance Space Transportation**
- ◆ **Pioneer Technology Innovation**
- ◆ **Commercialize Technology**

**Airspace  
System  
Program**



### Objectives

- Reduce the aircraft accident rate by a factor of five within 10 years, and by a factor of ten within 25 years
- Double the capacity of the aviation system within 10 years and triple within 25 years based on 1997 levels
- Reduce inter-city door-to-door transportation time by half in 10 years and by two-thirds in 25 years; reduce long-haul transcontinental travel time by half within 25 years
- Reduce NOX emissions of future aircraft by 70% five within 10 years, and by 80% within 25 years.
- Reduce the perceived noise of future aircraft by a factor of two within 10 years, and by a factor of four within 25 years

2

## NASA Capacity Goals vs. Passenger Demand

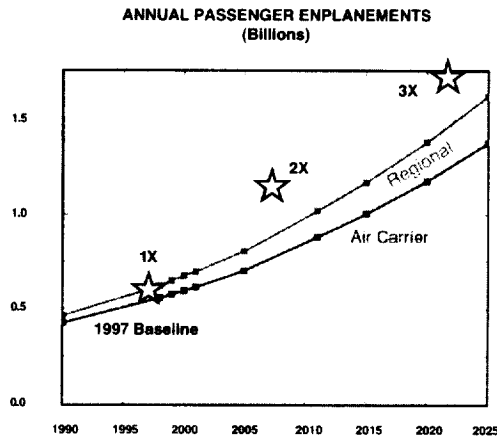

Source: FAA Aerospace Forecasts FY 2000-2011 (March, 2000)  
FAA Long-Range Aerospace Forecasts FY 2015, 2020, and 2025 (June, 2000)

**Demand is escalating faster than the  
general economic growth**

3

## Airspace Systems Goals and Objectives

### Goal:

Enable major increases in the capacity and mobility of the air transportation system through development of revolutionary operations systems & vehicle requirements



### Primary Objectives:

- Improve NAS capacity and mobility
- Develop, validate & transfer advanced concepts, technologies and procedures to the customer community

### Secondary Objectives:

- Improve access, flexibility, collaboration and predictability of the NAS
- Maintain system safety, security and environmental protection
- Enable runway-independent aircraft and general aviation operations
- Enable modeling and simulation of air transportation operations

4



## Airspace Systems Projects

Improve gate-to-gate air traffic management to increase capacity and flexibility



AATT Project '96-'04

Model/simulate the NAS and explore next generation of advanced concepts



VAMS Project '02-'07

Improve public mobility & community access with small aircraft/airports



SATS Program '01-'05

Reduce airport capacity constraints due to weather (Completed in 2000)



TAP Project '94-'00

Understand & model human/ systems



AOS Base Project

Off-load small commuter traffic from runways for use by large transports (Completed in 2001)



SHCT Project '94-'01

7

## Airspace Systems Roadmap

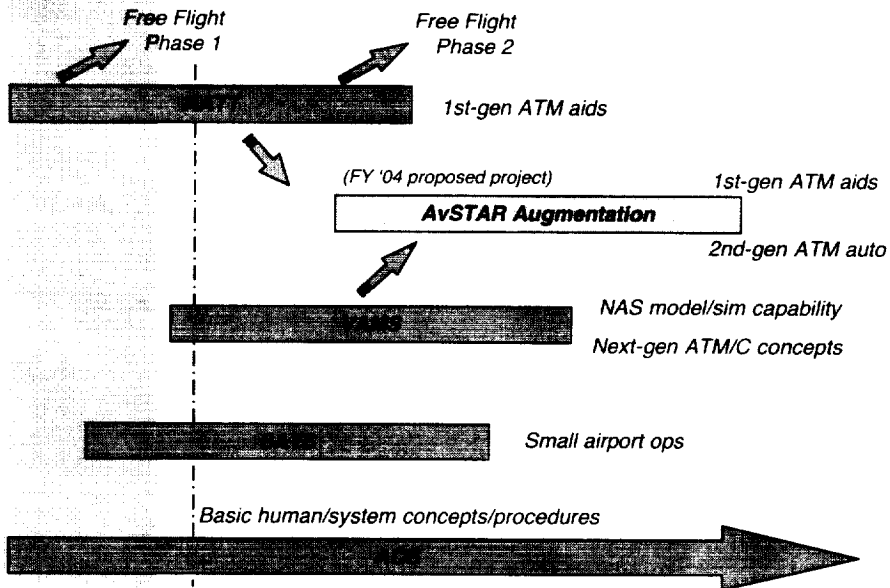

8



## VAMS-AvSTAR Projects

Explore, simulate and develop advanced concepts and technologies for next generation air transportation system

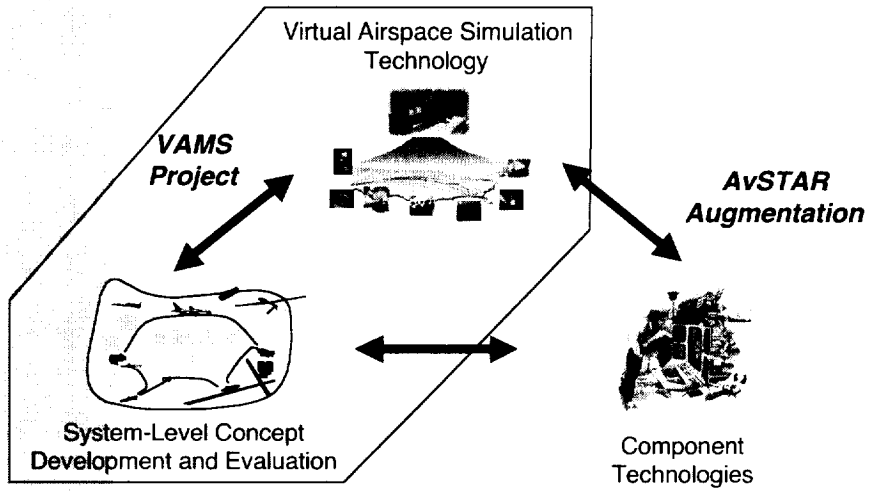

9

# VIRTUAL AIRSPACE MODELING AND SIMULATION

## Technical Interchange Meeting

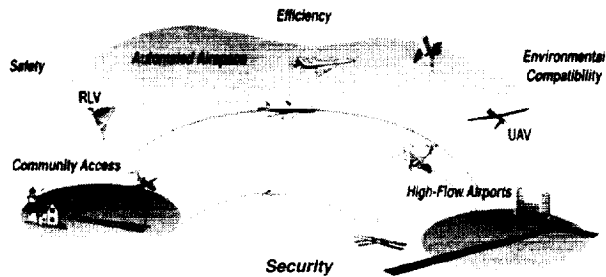

**Harry N. Swenson**  
**Project Manager**  
**NASA Ames Research Center**

May 21, 2002

## Project Vision

The Virtual Airspace Modeling and Simulation Project will provide the technologies and processes for conducting trade-off analyses amongst future air transportation system's concepts and technologies

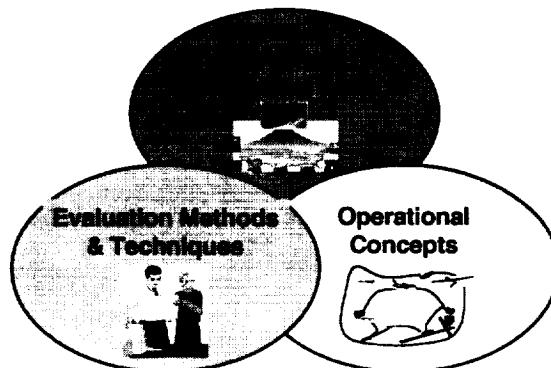

- VAMS Project Description
- VAMS Project Management
- VAMS Project Schedule
- Technical Interchange Meeting
- Objectives
- Agenda

### Background: Today's ATS Operational Concept Baseline

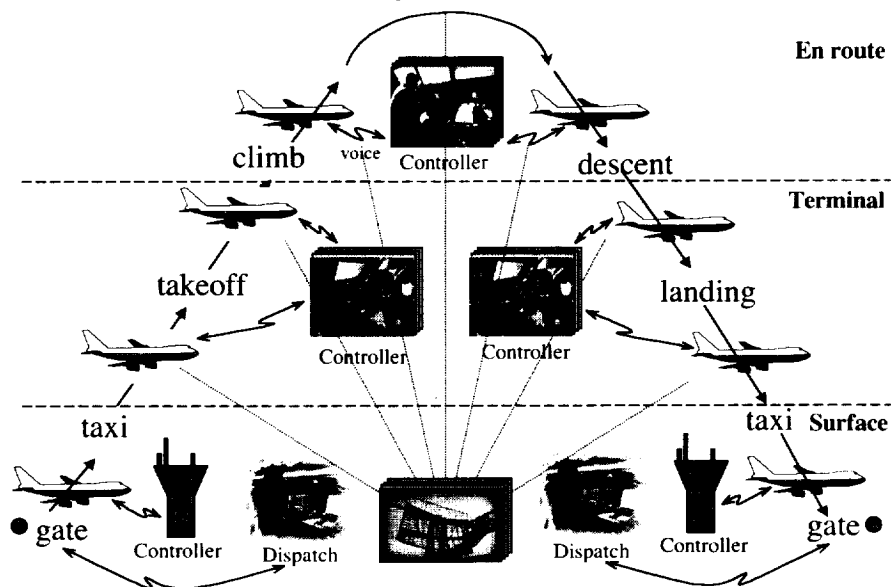

AS **Flight from San Francisco to Dulles** **VMS**

Animation Simulation Airspace Aircraft Applications

Status Running File TSM Stoked EP Number Party UTC Time

Route of flight includes transition through 35 sectors:

- 6 surface/terminal area sectors (departure)
- 23 en route area sectors
- 6 terminal/surface area sectors (arrival)

AT 5

AS **Off Nominal ATM Scenario** **VMS**

Animation Simulation Airspace Aircraft Applications Internet

Status Running File TP2 speed of TP2 Number Party UTC Time

AT 6

### Project Goals & Objectives



- Develop the capability to model and simulate behavior of air transportation system concepts and their elements to never-before-achieved levels of fidelity
  - Develop a set of analytical and computational models and methods to conduct detailed assessments of candidate operational concepts
  - Establish simulation capability that will enable safe investigation of complex advanced air transportation concepts, and develop a deeper understanding of human performance interaction within it
- Develop advanced air transportation concepts
  - Develop a set of potential operational concepts, concepts of use, and architectures, providing definitions of the future air transportation system and its elements
  - Develop technology roadmaps to achieve these concepts
- Conduct assessments of advanced air transportation concepts
  - Address potential benefits, identify risks and limits, and evaluate performance, safety, operations, and National Airspace System infrastructure and transition challenges

### Air Transportation System Status



TOTAL U.S. ATC SYSTEM DELAY  
(Thousands of Flights with Delay > 15 mins)

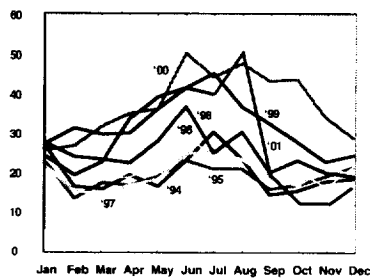

MONTHLY PASSENGER ENPLANEMENTS  
(Millions)

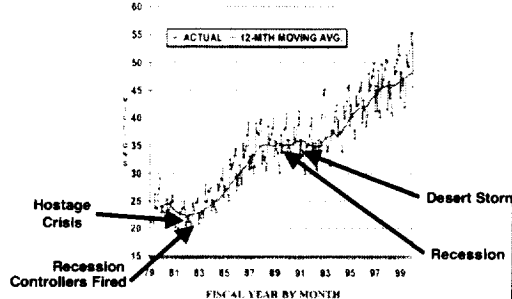

ANNUAL PASSENGER ENPLANEMENTS  
(Billions)

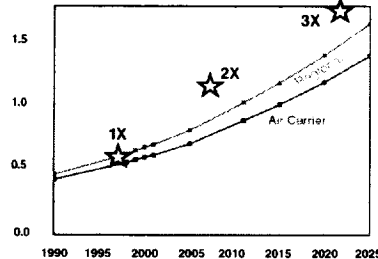

- **The National Airspace System (NAS) on the verge of gridlock**
  - Excessive delays result
  - Negative impact on economy and mobility
- **New concepts beyond currently planned are needed to meet future capacity demands**
- **Substantial change is required in the approach to NAS operations**
- **Total NAS evaluation requires substantial improvement to current modeling and simulation capabilities**
- **NASA has extensive experience in airspace systems development and an outstanding modeling and simulation capability**

## Project Summary

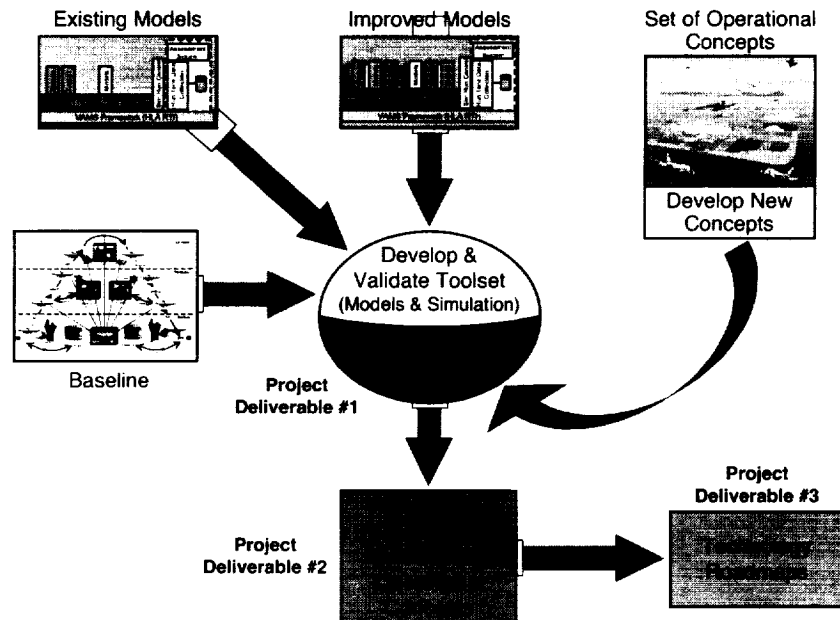

## Terms & Definitions

**Operational Concept:** An operational concept describes what a specific set of air transportation system capabilities does or will do to provide specific operational services to an identified set of system users.

These operational services include:

- Flight Planning
- Situational Awareness & Advisory
- Traffic Management—Strategic Flow
- Traffic Management—Synchronization
- Infrastructure/Information Management
- Separation Assurance
- Navigation & Landing
- Airspace Management
- Emergency/Alerting

An operational concept may be limited to a subset of these services and the technology used to accomplish that concept; for example, the operational concept might be “the air transportation system provides separation assurance between aircraft”

**Modeling:** A set of mathematical constructs or equations and parameters that describe a phenomenon or concept

**Simulation:** The time-based integration of models that use the passage of time as one of its parameters

**Real-Time:** Simulations in which the passage of time replicates the passage of time in the ‘real’ world associated with human-in-the-loop (HITL)

**Non Real-Time:** Simulations in which the passage of time is either slower or faster than the real world

## VAMS Technical Process

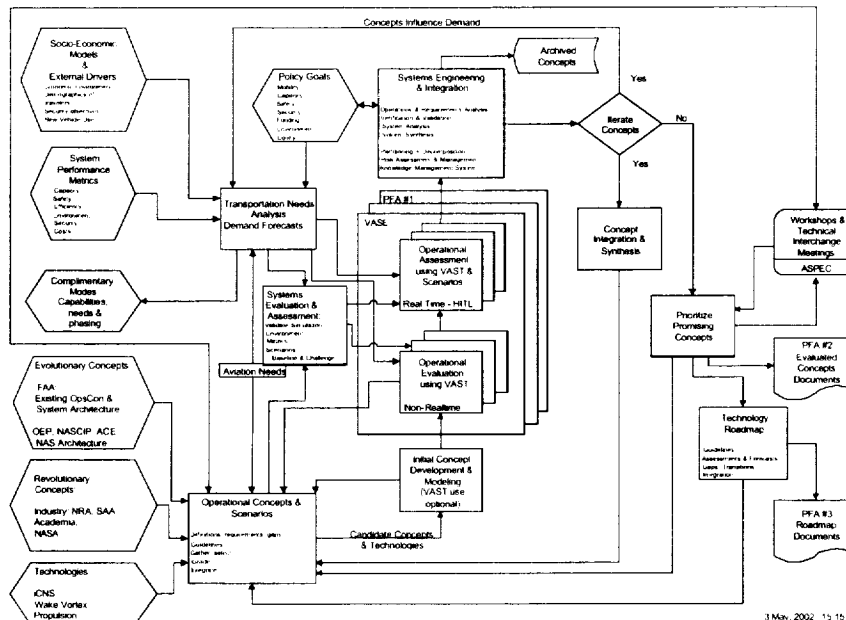

### Technical Challenges

Visual Interface Management & Information Presentation

- Identifying and prioritizing a set of existing models
- Developing models to fill gaps
- Integrating and validating the set of models
- Integration with human-in-the-loop simulation and validation
- Using appropriate evaluation methods
- Defining gate-to-gate and door-to-door measurable metrics
- Supporting and defining appropriate scenarios (utilization)
- Identifying Enterprise goal-achieving concepts
- Comprehensive modeling and analysis of concepts and supporting technologies
- Seamless integration of concept elements
- Knowledge management
- Technology/concept assessments
- Information flow

Modeling & Simulation

Evaluation & Assessment

Operational Concept & Analysis

### Conceptual Domains

Visual Interface Management & Information Presentation

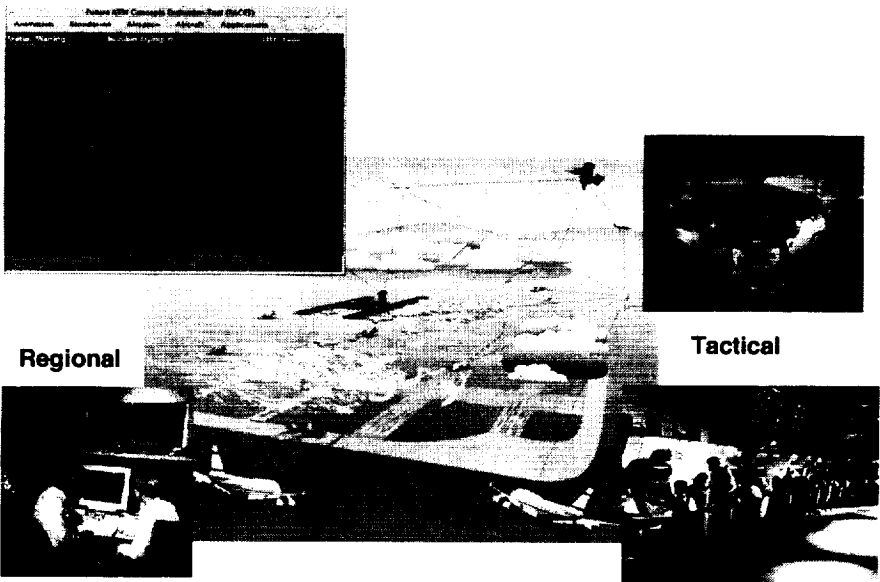



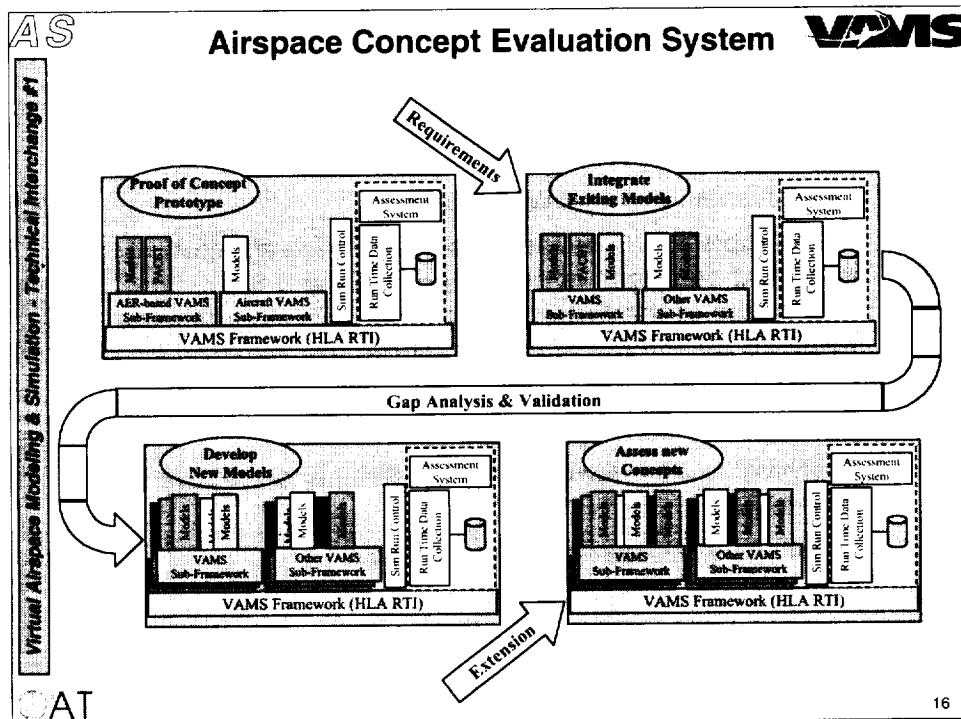
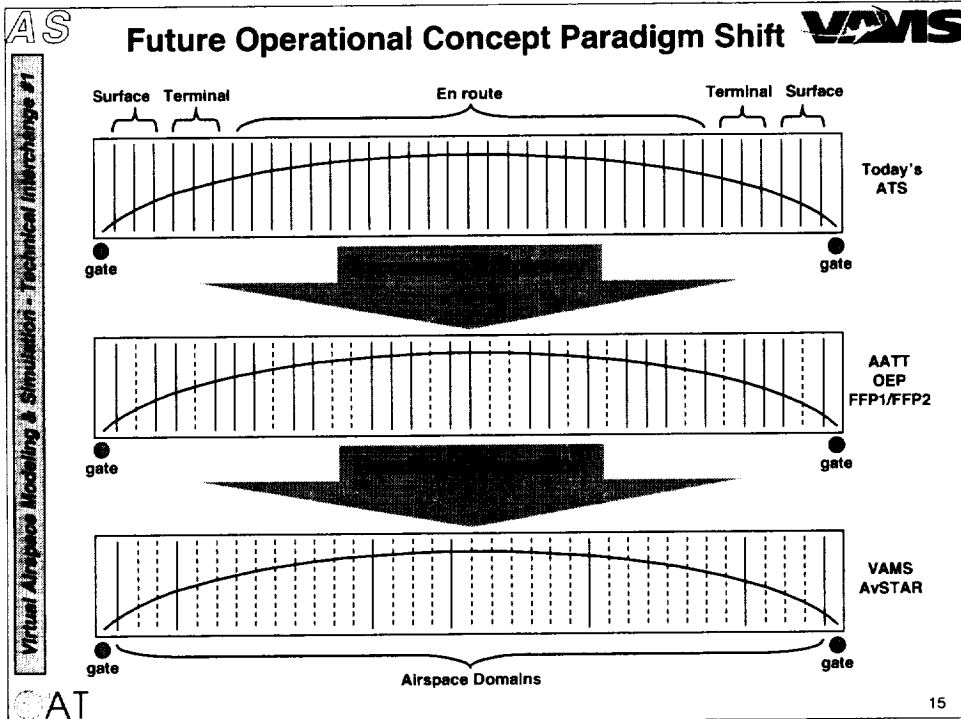

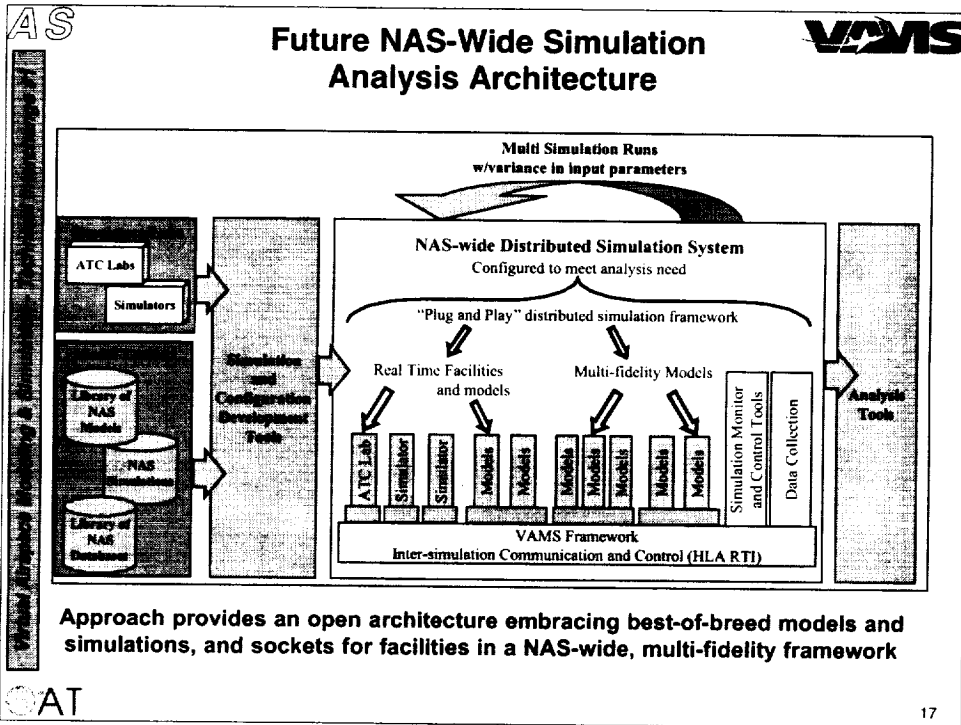

CAT

- VAMS Project Deliverables**
- **Deliverable #1 – A real-time virtual airspace simulation environment (3QFY06)**
    - Annual build of simulation capability
  - **Deliverable #2 – The identification and evaluation of potential concepts of operation that meet the objectives of the Enterprise’s long-term capacity and mobility objectives of the *Revolutionize Aviation* Goal (3QFY07)**
    - Interim deliverables on a yearly basis
  - **Deliverable #3 – Technology roadmaps to achieve the identified concepts (3QFY06)**
    - Interim deliverables on a yearly basis

CAT

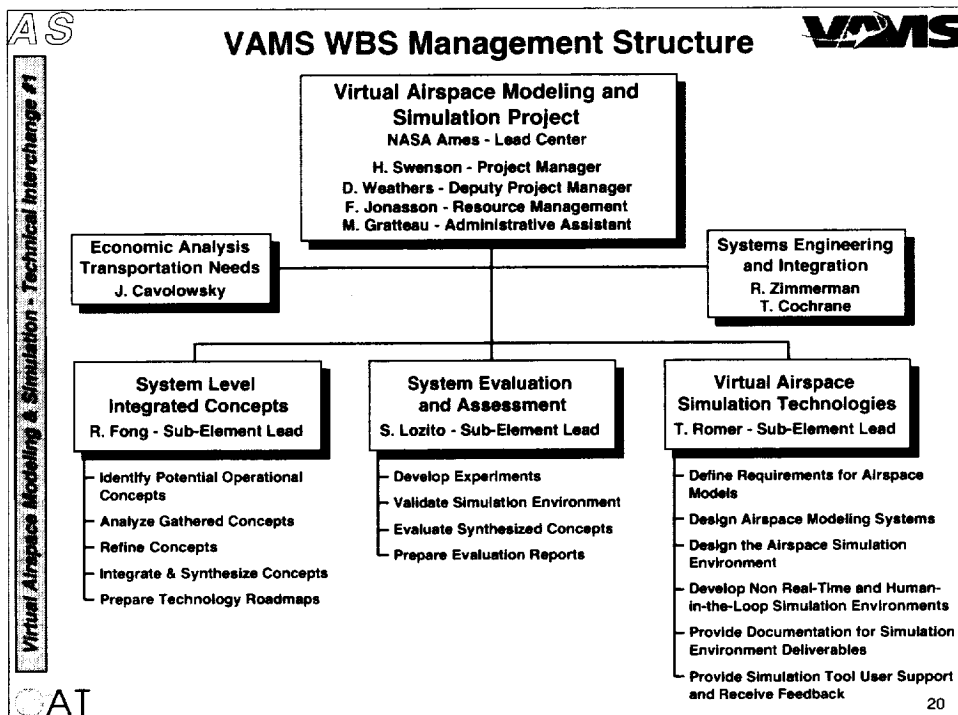
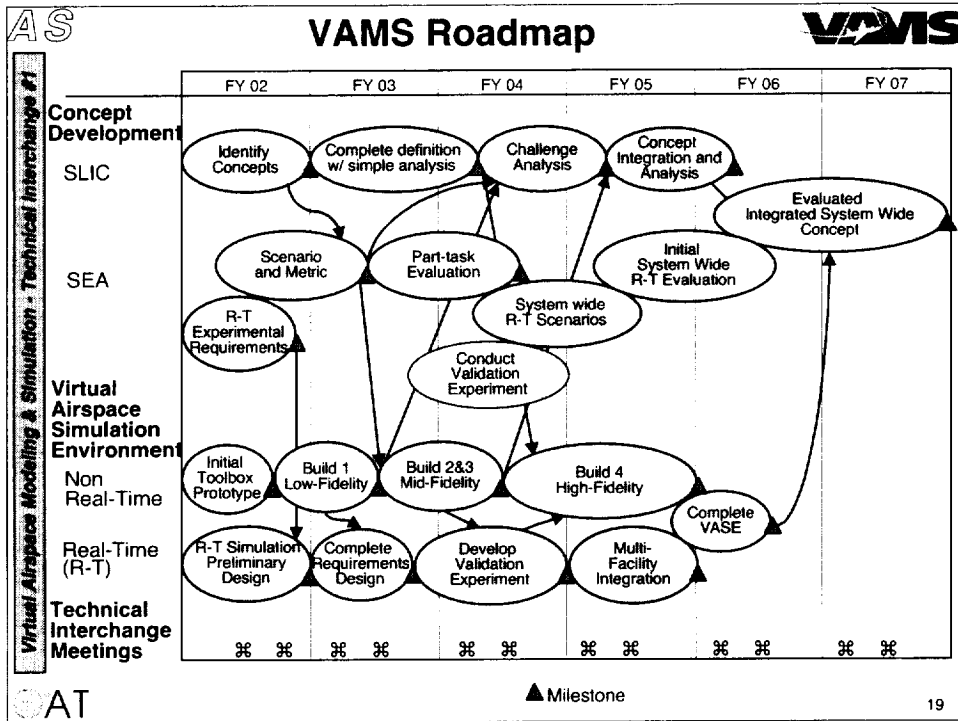

### TIM Objective

- Project integration and risk management
- Initial air transportation system concept information definitions
- Initial technology roadmap definition and development
- Initiate evaluation scenarios and metric definition and development
- Guideline development for concepts assessment

### TIM Agenda

21-May Tuesday	22-May Wednesday	23-May Thursday
Facility opens and Meeting Registration	Facility opens	Facility opens
NASA Welcome (Zachman)	<b>Daily Agenda</b> Automated Airport Surface Traffic Control <i>Metron</i>	<b>Daily Agenda</b>
VAMS Project overview (Swenson)	Surface Operation Automation Research <i>Optimal Synthesis</i>	Breakout #2 Metrics/Scenarios (3 separate parallel sessions)
SLIC Sub-element overview (Fong)	Centralized Terminal Operation Control <i>Northrop Grumman</i>	Break
Break	Break	Break
VAST Sub-element overview (Romer)	Air Transport System Capacity Increasing Concept <i>Raytheon</i>	Breakout report writing #2 with a parallel special topic - <i>VAMS Package</i>
SEA Sub-element overview (Lozito)	Wake Vortex Avoidance Concept (Rutishauser)	Report on Breakout #2
Federal Aviation Administration (Liang)	Advanced Airspace Concept (Erzberger)	Catered Lunch in Patio Room
Catered Lunch in Patio Room	Catered Lunch in Patio Room	Catered Lunch in Patio Room
System Level Capacity Increasing Concept <i>Boeing</i>	University Concepts (Zeilweger)	Breakout #3 Guidelines (3 separate parallel sessions)
Technology Enabling Air-Weather Max. Cap. By 2020 <i>Metron</i>	Breakout #1 Technology Roadmaps (3 separate parallel sessions)	Break
Break	Break	Breakout report writing #3 with a parallel special topic - <i>Business Modeling</i>
Massive PTP & On-Demand ATS Invest. <i>Seagull Tech</i>	Break	Report on Breakout #3
System Wide Optimization (Sridhar)	Breakout report writing #1 with a parallel special topic - <i>Identifying Air Demand</i>	Next Steps in Concepts and a Preview of TIM 2
Special Breakout Session Facilitator/Recorder Meeting (others adjourn for day)	Report on Breakout #1	

- Phone Calls

Messages can be left at (650) 604-2926 or 604-2082

- Computing

Macintosh computers and hookups for laptops are available for your use in the Fireside area.

- Refreshments & Registration

- Breakout Assignments

- ★ Macon
- ★ Northwing
- ★ Showroom

- Restrooms

Located on the right side of the ballroom and on your left just as you past the registration area.

**AS** **Background: Air Transportation System** **VAMS**

**Origin**

**Destination**

**Security**

**Economy**

**Infrastructure**

**AT**

25

## System-Level Integrated Concepts (SLIC)

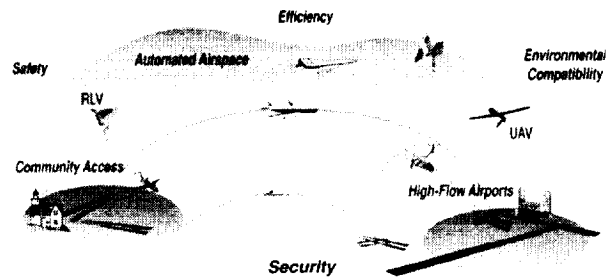

**Robert Fong**  
 System-Level Integrated Concepts Manager  
 NASA Ames Research Center

May 21, 2002

## Outline

- Criteria for a successful meeting
- SLIC Goals
- Approach
- Concept Development Process
- Concept Development Timeline
- Concept Development Framework
- Gathered Concepts
- Phase one focus
- VAMS Participant interactions

AS

## Criteria for a Successful Technical Interchange Meeting



What is the purpose of this meeting?

**We all achieve a common understanding of:**

- The project goals and approach
- The concept-development goals and approach
- The project terminology
- The necessary interactions between the concepts, modeling/simulation and assessment group

AT

3

AS

## SLIC Goals



What is the purpose of this meeting?

- The goal of this concept development effort is to produce, and evaluate the benefits of, a **Unified Capacity-increasing Concept**.
- Develop **Technology Roadmaps** to layout out how such a concept can be developed and implemented in the NAS.

AT

4



# SLIC Approach

- Gather Concepts from industry, NASA, universities, and other sources; concepts cover distinct domains of the Air Transportation System (surface, terminal, en route, and gate-to-gate)
- NASA's baseline references include OEP, RTCA 2005, ICAO...
- Concepts will address NASA's long-range Aerospace Technology Enterprise goals (3X increase by 2022)
- Develop and Analyze Independent Concepts
- Integrate and Synthesize the independent concepts into a unified capacity- increasing system concept

# Concept Development Process

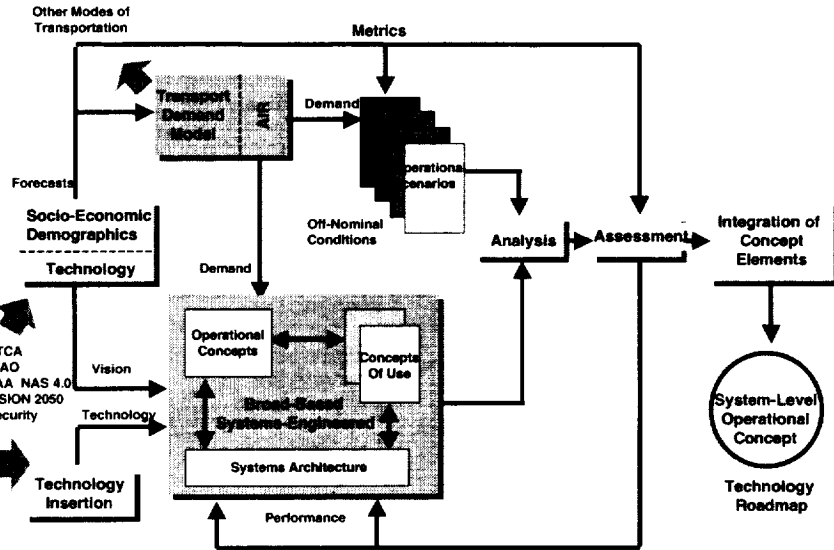

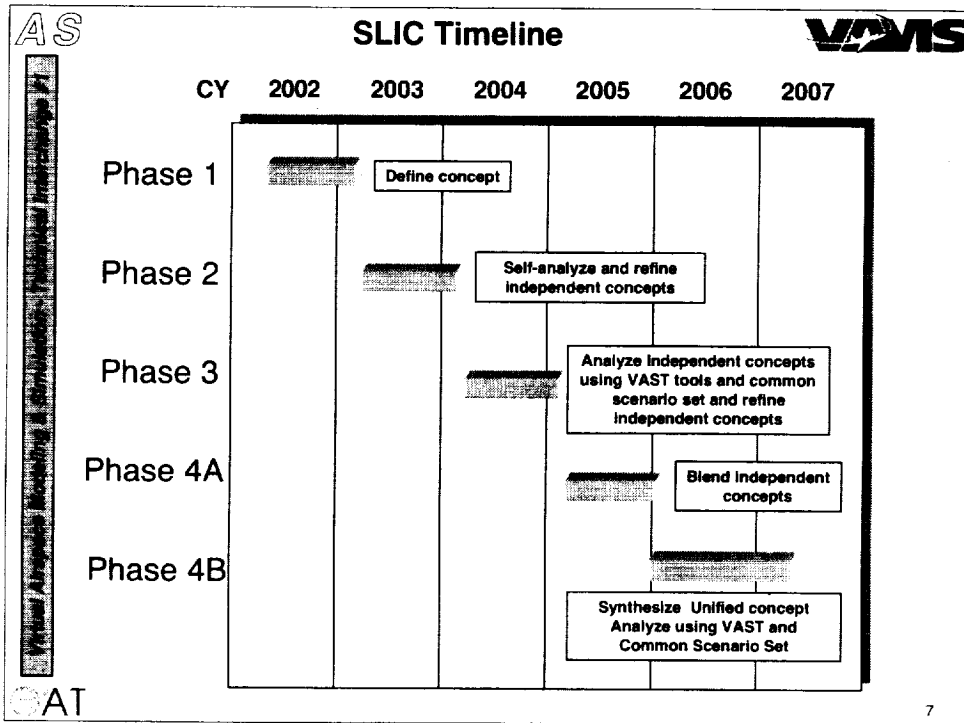

AS VAMS

### Summary of Concept Development Phasing

Phase	Work Requirements	Scenario Requirements	Tools for Evaluation
Phase One	Develop concept	Develop concept specific scenario	N/A
Phase Two	Evaluate and refine concept	Use concept specific scenarios	Own or available VAST tool set
Phase Three	Evaluate and refine concept	Initial common scenario set	VAST Tool set
Phase Four A	Participate in blending of unified system concepts	Expanded common scenario set	VAST Tool Set
Phase Four B	Support synthesis and analysis of unified system concept	Full common scenario set	VAST Tool Set

AT 8

- All concept developers shall describe their concept using a common framework, the “guidelines”, to facilitate:
  - Modeling and simulation of concepts
  - Evaluation and assessments of concepts
  - The eventual blending of the concept.

**Concepts include:**

- Issues
- Assumptions
- Challenges
- Operating domains
- Core Ideas
- Functions
- Roles/Resp of Human/Mach
- Performance
- User interfaces
- Architecture
- Controls philosophy
- Error Recovery ideas
- Metrics of goodness
- Technology requirements
- Costs/Benefits
- Conceptual competitors

**Evaluation Criteria address:**

- |                                                                                                                                                                                                                                                   |   |             |
|---------------------------------------------------------------------------------------------------------------------------------------------------------------------------------------------------------------------------------------------------|---|-------------|
| <ul style="list-style-type: none"> <li>• Safe</li> <li>• Useful</li> <li>• Effective</li> <li>• Definable</li> <li>• Practical</li> <li>• Stable</li> <li>• Robust</li> <li>• Reliable</li> <li>• Self-Diagnostic</li> <li>• Adaptable</li> </ul> | } | Functions   |
| <ul style="list-style-type: none"> <li>• Available</li> <li>• Accurate</li> <li>• Responsive</li> <li>• Predictable</li> <li>• Time/Effort Saver</li> <li>• Maintainable</li> <li>• Compatible</li> </ul>                                         | } | Performance |
| <ul style="list-style-type: none"> <li>• Documented</li> <li>• Transition</li> <li>• Constructible</li> <li>• Productible</li> <li>• Environmentally Compatible</li> <li>• Affordable</li> <li>• Model-able</li> <li>• Revolutionary</li> </ul>   | } | Feasibility |

## Gathered Concepts - NRA

Boeing	Air Transportation System Capacity Increasing Concepts Research	Gate-to-Gate
Metron Aviation	Technologies Enabling All-Weather Maximum Capacity by 2020	Gate-to-Gate
Seagull Technologies	Concept PTP: Massive Point-to-Point and On-Demand Air Transportation	Gate-to-Gate
Northrop Grumman	Centralized Terminal Operation Control	Terminal
Metron Aviation	Capacity Improvement through Automated Airport Surface Traffic Control	Surface
Optimal Synthesis	Surface Operation Automation Research (SOAR)	Surface

## Gathered Concepts - NASA

NASA-ARC	Advanced Airspace Concept	En route
NASA-ARC	System-wide Optimization	Gate-to-Gate
NASA-LaRC	Wake Vortex Avoidance System (WVAS)	Terminal

### Gathered Concepts - Others

Virtual Airspace Modeling & Simulation - Technical Interchange #1

Raytheon	Terminal Area Capacity Enhancing Concept (TACEC)	Terminal
University Group (Zellweger)	University Concept(s)	System

### Sub-element Interactions

Virtual Airspace Modeling & Simulation - Technical Interchange #1

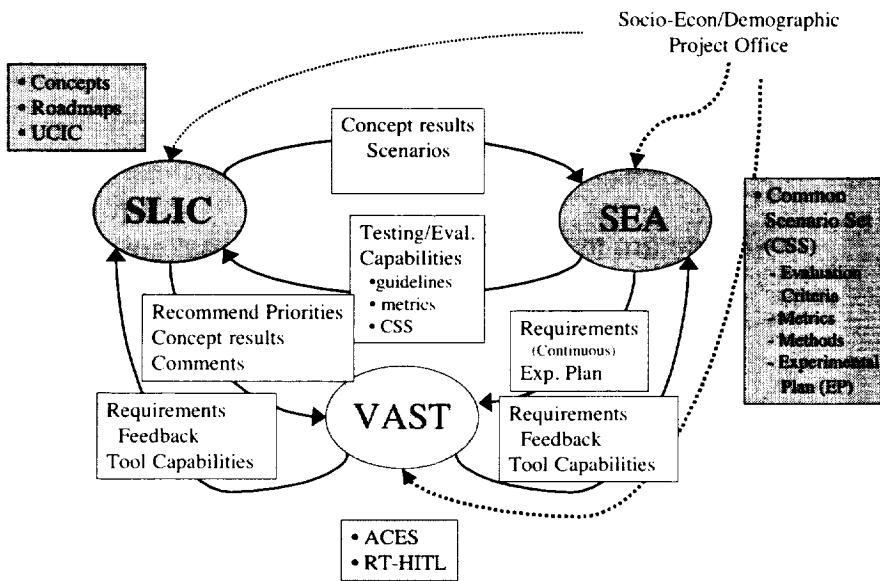

## VAMS Participant Interactions



- Technical Monitors assigned to each Concept
- Technical Interchange Meetings – two per year
- Concept developer “deliverables”

## Key Challenges



- Can the concept be analytically modeled?
- Can concepts be successfully blended?
  - These are topics for the Guidelines Breakout

## Virtual Airspace Simulation Technologies (VAST)

Tom Romer  
VAST Sub-Element Lead  
NASA Ames Research Center  
tromer@mail.arc.nasa.gov

May 21 2002

- VAST Description
- VAST Development Approach
- VAST Interdependencies
- VAST Challenges
- Summary

- **VAST provides a validated virtual airspace simulation environment with modeling and simulation capabilities to assess the integrated behavior of current and future air transportation system concepts and technologies at the system-wide level and at the detailed human-in-the-loop level**
- **Airspace Concept Evaluation System**
  - Interoperable models representing the actions and highly coupled interactions of the air transportation system's key components
  - Non-real-time environment capable of assessing the impact of new technologies, procedures and concepts of operation on the safety, capacity, economics and security of the nation's air transportation system
- **Human-In-The-Loop Simulation**
  - Distributed network simulation capability that integrates real-time software models, human interfaces and simulation labs and facilities
  - Real-time simulation environment that adequately addresses human interactions with air transportation system technologies

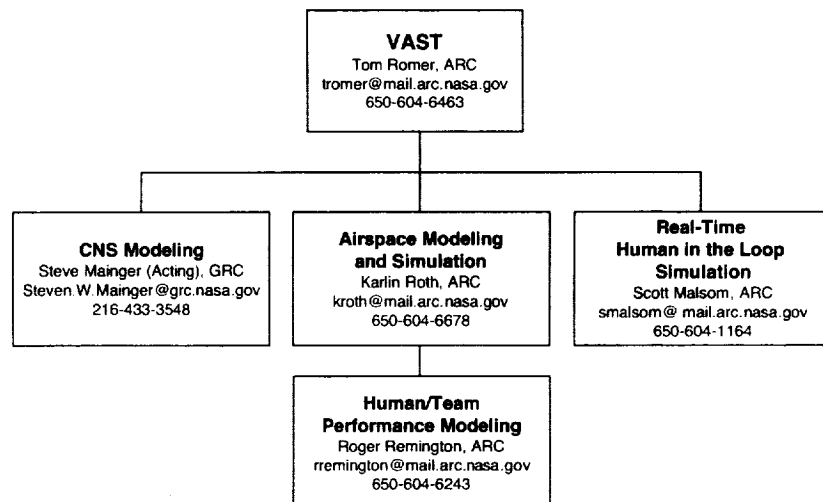



### Airspace Modeling and Simulation

- Develop the architecture for the Airspace Concept Evaluation System
- Develop models to support ATM system assessments through simulation and analysis

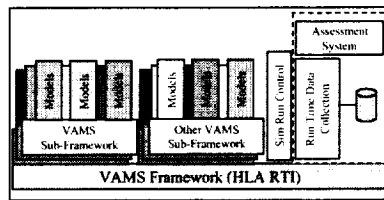

- Transfer appropriate models and technology for application within the real-time simulation environment

### NAS- Wide Enroute Simulation

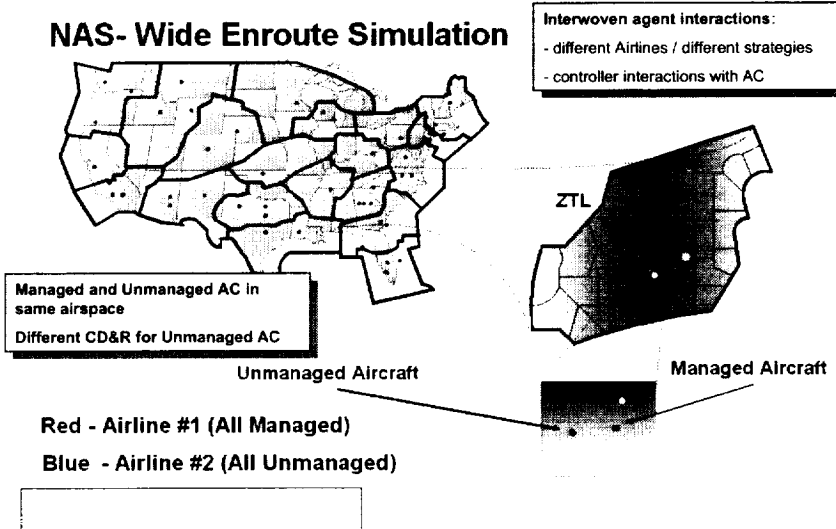

- **Airline federate schedules**
  - Airline #1 with a fleet of 500 unmanaged aircraft
  - Airline #2 with a fleet of 500 managed aircraft
  - Flight schedules generated using a “random flight scheduler” based on ETMS data
- **En Route federate**
  - Simulates En Route NAS, modeling geometry, infrastructure, and various NAS dynamic and static agents at low fidelity (Pilots, AOCs, ATCSCC, ARTCC, Controllers, NAS geometry, etc.) as these airlines fly across the NAS
- **Controller federate**
  - Simulates ZNY56, ZDC04, ZDC12
- **Simulation Manager controls the simulation**
- **Data Collection federate**
  - Fuel, conflicts, near misses logged to a database

- **Emphasizes establishment of the core architectural foundation that is designed for flexibility, scalability and extensibility**
- **Expands the initial set of models within the toolbox**
  - Enables study of benefits from candidate improvements such as ATC and flight deck enhancements
  - Enables evaluation of the effect of increased future traffic demand
  - Precludes study of radical system improvements such as aggressive implementation of free flight
- **Focuses on run-time capability versus efficiency**
- **Integrates / develops basic simulation control, data collection and visualization**

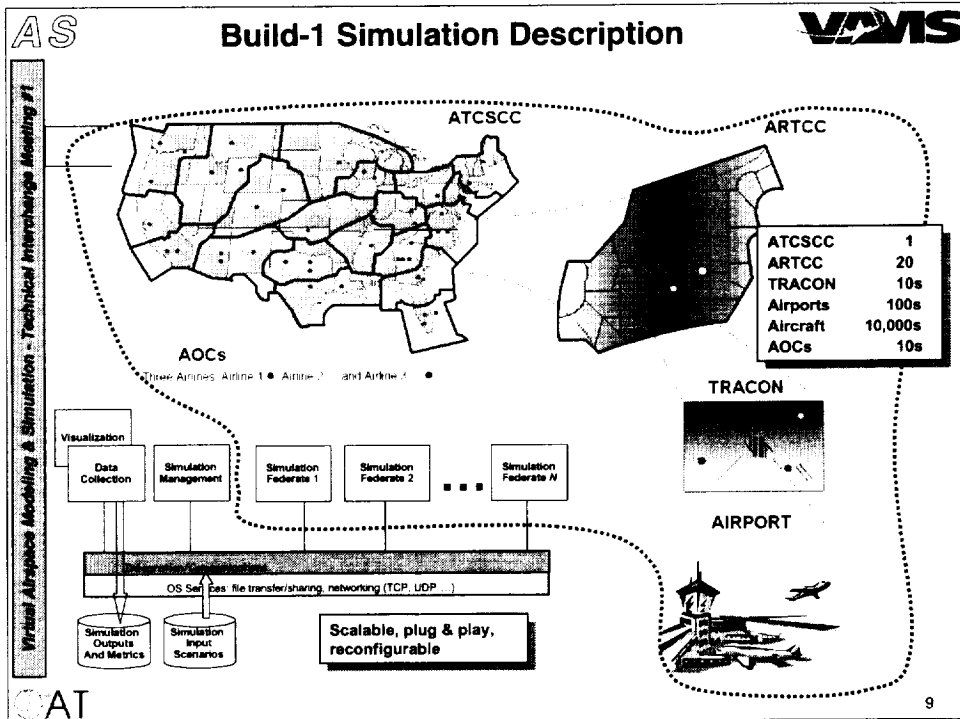

- AS** **Airspace Concept Evaluation System Development Summary** **VAVIS**
- Virtual Airspace Modeling & Simulation - Technical Interchange Meeting #1
- **Demonstrated a proof-of-concept prototype**
    - Selected the DoD's HLA-RTI infrastructure with agent-based software to enable fast-time NAS-wide simulation
    - Established a modeling lab that leverages existing and emerging models and tools
  - **Proving the feasibility of the approach to capture the interactions between NAS entities (Build-1)**
    - Integrate a suite of low-medium fidelity NAS models
    - Model dynamic effects of interactive agents
    - Assess NAS operational performance
  - **Enhancing the modeling toolbox by adding NAS functionality**
    - Develop and validate new models of NAS components
    - Increase model fidelity and simulation speed
  - **Defining requirements for usability to enable technology transfer to airspace analysts**
- AT** 10

- **Design a distributed network capability that integrates ATM simulator facilities, labs and real-time software models to support assessments of human interactions with airspace concepts and technologies**
  - Define real-time environments and establish preliminary design
  - Complete requirements and initial design
- **Develop initial capability and validate against a defined operational concept**
  - Adapt models developed within the Airspace Modeling and Simulation Task for use in real-time simulation
  - Develop models unique to real-time simulation
  - Develop interface requirements to simulators and labs
- **Enhance capability to include multi-facility functionality**
  - Establish infrastructure to conduct multi-facility simulations
- **Complete capability to support concept development**

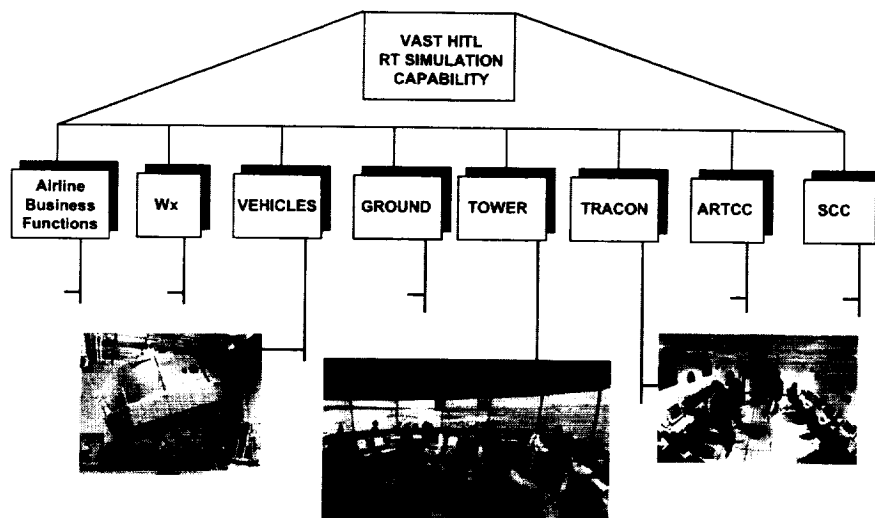

- **Develop and validate human and team models that predict operator performance within VAMS operational concepts**
  - Define and model cognitive demands of supervisory control in highly-automated human-machine systems
  - Define and model individual and team decision strategies
  - Define and model performance characteristics of mixed-initiative systems
  
- **Develop rapid re-configurable airspace operator models for new concepts**
  - Software architecture: interoperable, portable, versatile, scalable, extensible
  - Usability: high-level modeling language, model debugging support, and data visualization tools
  - Model building blocks: templates for human-computer interaction, and libraries of reusable physical environment widgets
  - Integrate Human/Team Performance models into Build 3 of modeling toolbox

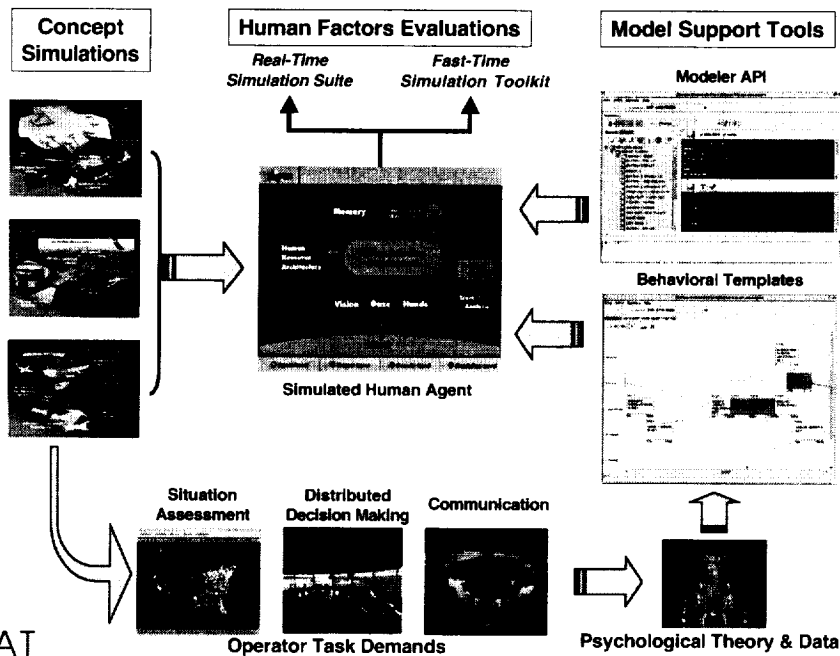

- **Develop requirements for CNS modeling that supports evaluation of VAMS operational concepts**
  - Identify and categorize CNS modeling and simulation capabilities and needs
  - Identify approach to CNS model and CNS infrastructure assessment
- **Develop communication, navigation and surveillance models for today's system, technologies currently being considered within the FAA's OEP, and technologies being considered for the future**
  - Develop and demonstrate standard communications traffic model for assessing CNS model elements and architectures
  - Integrate CNS modeling activities into Build 3 of modeling toolbox

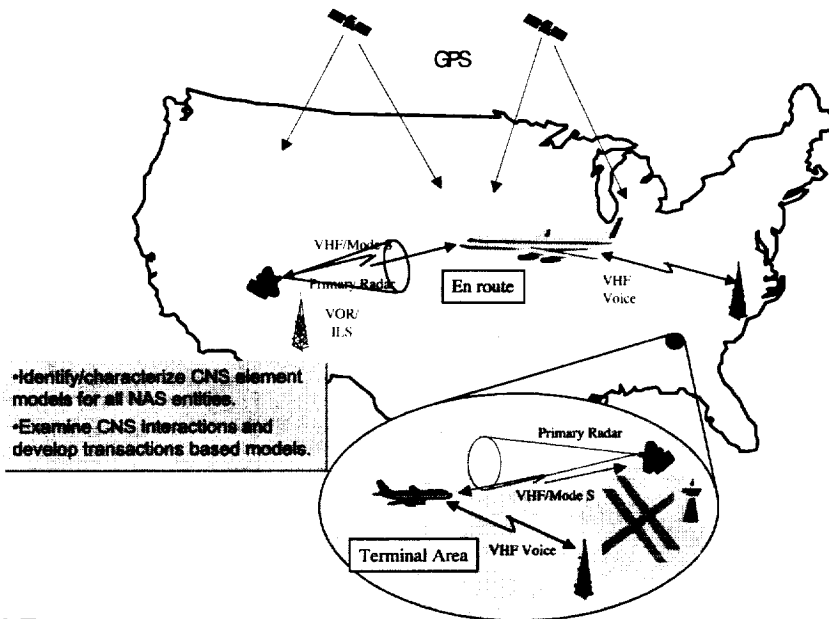

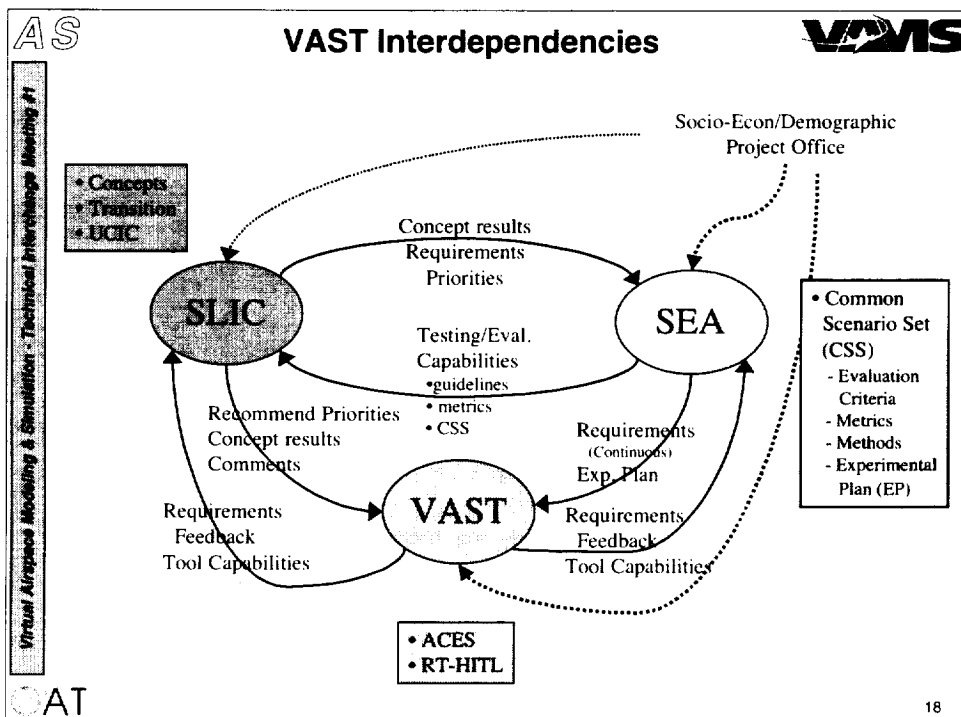
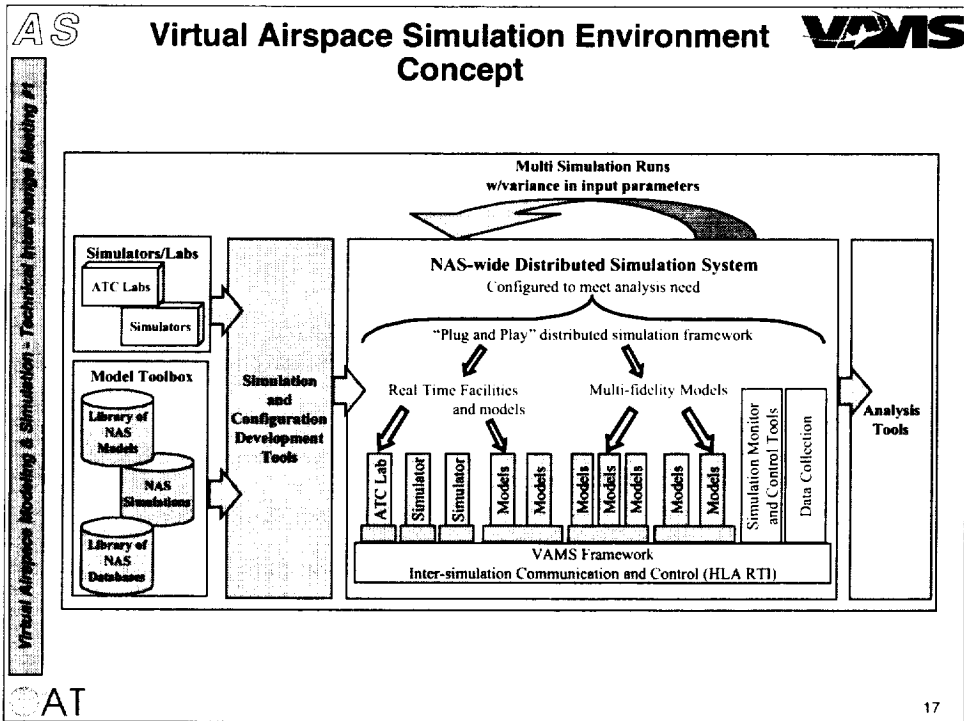

- **VAST's overarching measure of success is to produce analytical models and analysis results that enable the implementation of new ATM technologies and concepts**
- **Technical Challenges**
  - Identifying and prioritizing a set of existing models
  - Developing models to fill gaps
  - Integrating and validating the set of models and methods
  - Integrating with human-in-the-loop simulations and validating those methods
- **Process Challenges**
  - Fostering a cooperative environment and proposing standards within the ATM modeling and simulation community
  - Providing verified and validated simulation testbeds that represent the air transportation system
  - Advancing the fundamental understanding of the dynamic interactions within the NAS
  - Making the tools accessible to users

- **VAST seeks to produce new national capabilities to assess airspace concepts at the system-level and detailed human-in-the-loop level**
  - Architectures that are scalable, extendable and re-configurable, and support distributed simulation in non-real-time and real-time domains
  - Toolbox of agent-based models to select from and build simulations
  - Facility interface standards
  - Simulation and assessment tools and utilities
- **VAST success requires a cooperative effort**
  - Concept developers
  - Concept evaluators
  - Modeling and simulation developers
- **Efforts within VAST are underway and progressing well toward early project milestones**
- **VAST Focused TIM #2**



## Systems Evaluation and Assessment (SEA) Sub-element

Sandy Lozito  
Level 3 Manager  
SEA Sub-element

## Relationship between the VAMS Sub-elements

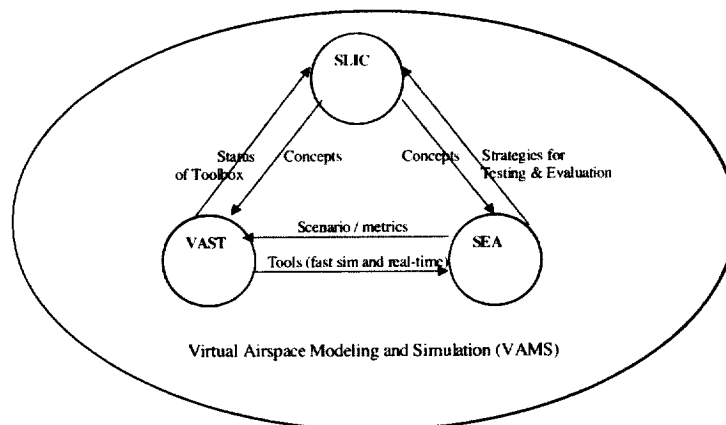

SLIC = System Level Integrated Concepts  
VAST = Virtual Airspace Simulation Technologies  
SEA = Systems Evaluation and Assessment

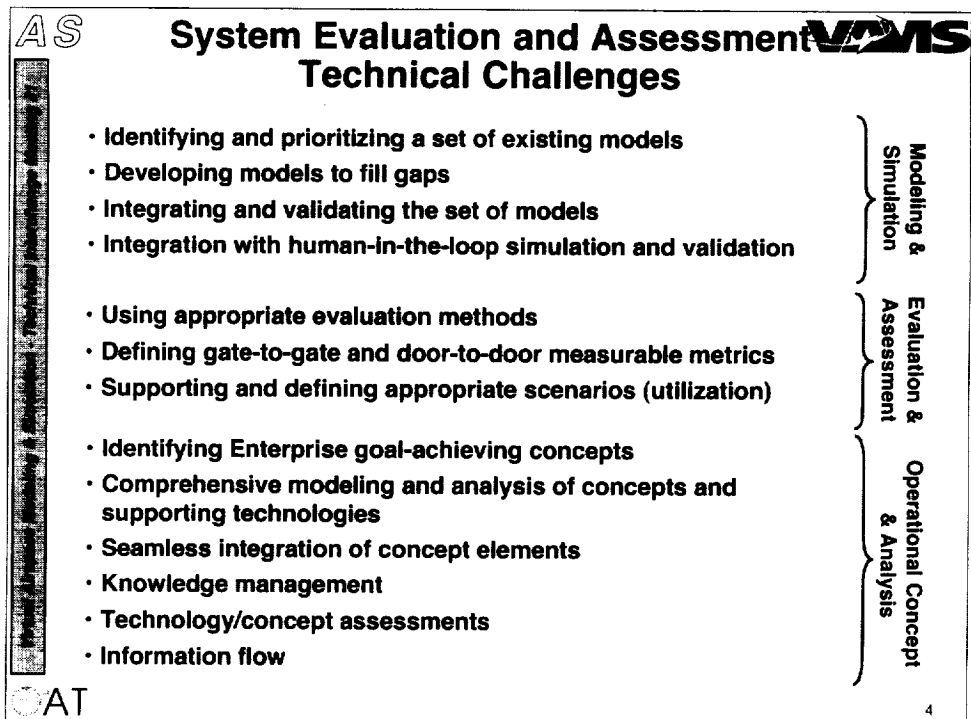
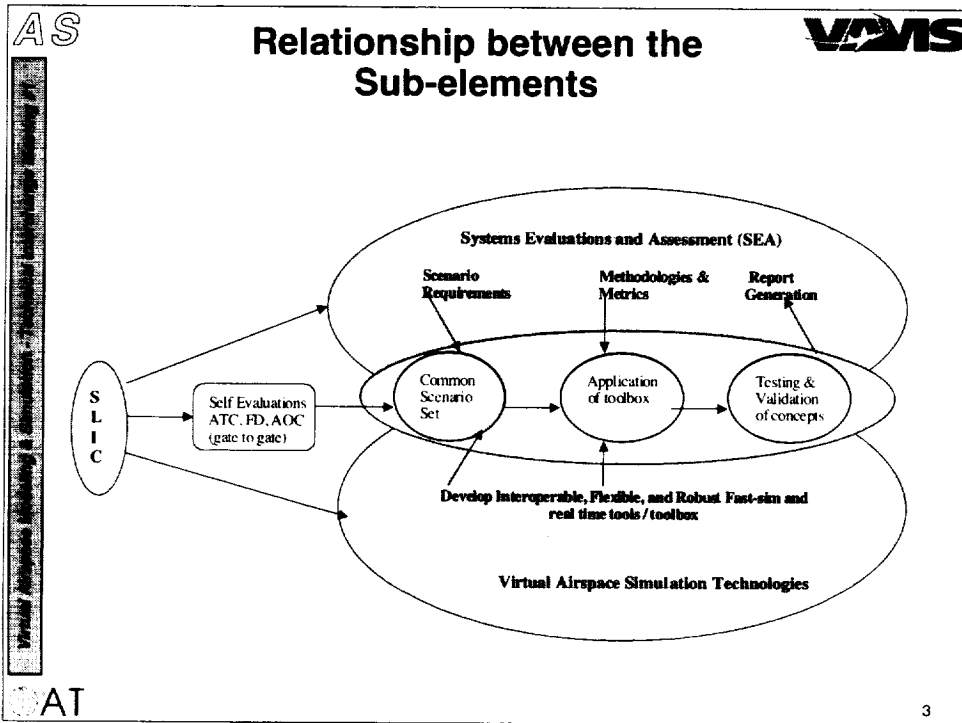

## Today's System Evaluation Methods and Techniques

B747-400 Simulator at NASA Ames



Real-Time Link



William J. Hughes Technical Center Lab

### Air-Ground Integration Experiment (2000)

#### Data

- Timing variables
- Closest Point of Approach
- Aircraft maneuvers
- Workload data
- Communication timing
- Cockpit display data
- Alerting logic data

#### Analysis & Recommendations



### Current Evaluation & Assessment Gaps

- High resolution data
- Reflects limited segment of the NAS

## System Evaluation and Assessment General Tasks and Goals

- Develop scenarios and metrics for evaluation of the SLIC concepts
- Conduct an initial validation assessment of the VAST real-time tools
- Conduct an initial assessment of the selected concepts
- Conduct an assessment of the integrated concepts
- Conduct the final evaluation of the selected concept(s) using the VAST tools

- Scenarios and Metrics will be used to help evaluate the concepts from VAMS/System Level Integrated Concepts
  - Initial evaluation of concepts will be self-evaluation
  - The scenarios/metrics for self-evaluation can be used to assist the SEA scenario/metric development
- There can be many scenarios and metrics, but ultimately they must be applicable for broad evaluations
  - Concepts addressing multiple airspace domain and concepts addressing more specific domains
  - Concepts addressing multiple parts of the triad (AOC/ATC/FD)

- Scenarios are necessary for the evaluation of the “capacity-increasing” concepts
- Scenarios must test the concepts’ ability to increase capacity and maintain (or increase) safety
- Scenarios must cover all domains (e.g., surface, terminal, enroute)
- Scenarios must consider normal and non-normal events
- Scenarios must cover real-time and fast-time testing
- Scenarios must test all parts of the NAS triad: AOC, ATC, flight deck
- Scenarios must be able to test both single-domain concepts and more broad concepts
- SEA is writing requirements for the scenarios, not the scenarios themselves.

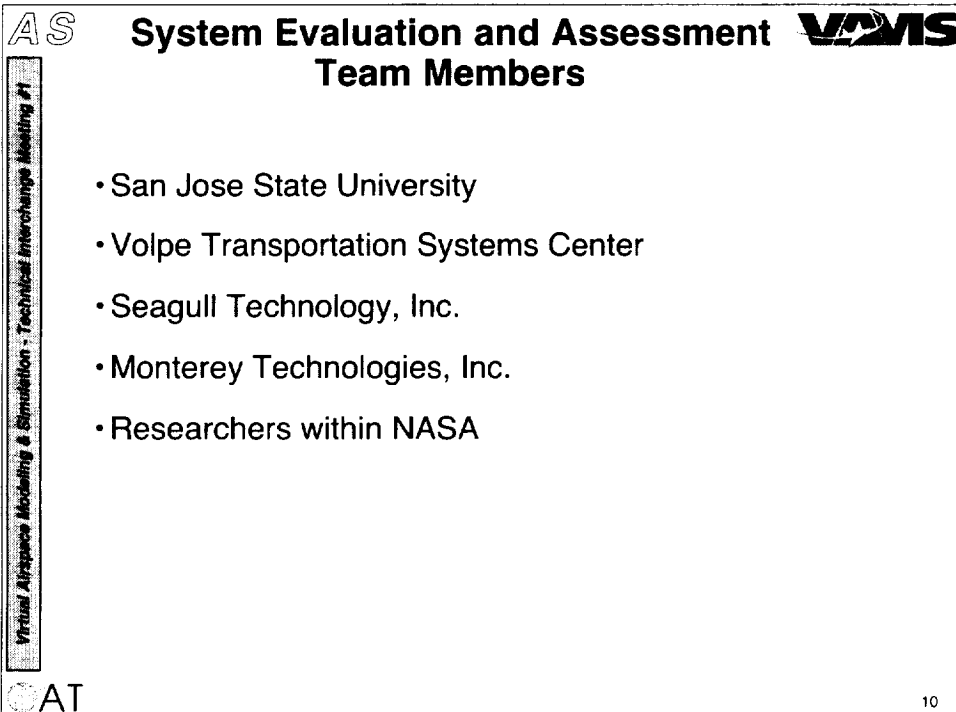
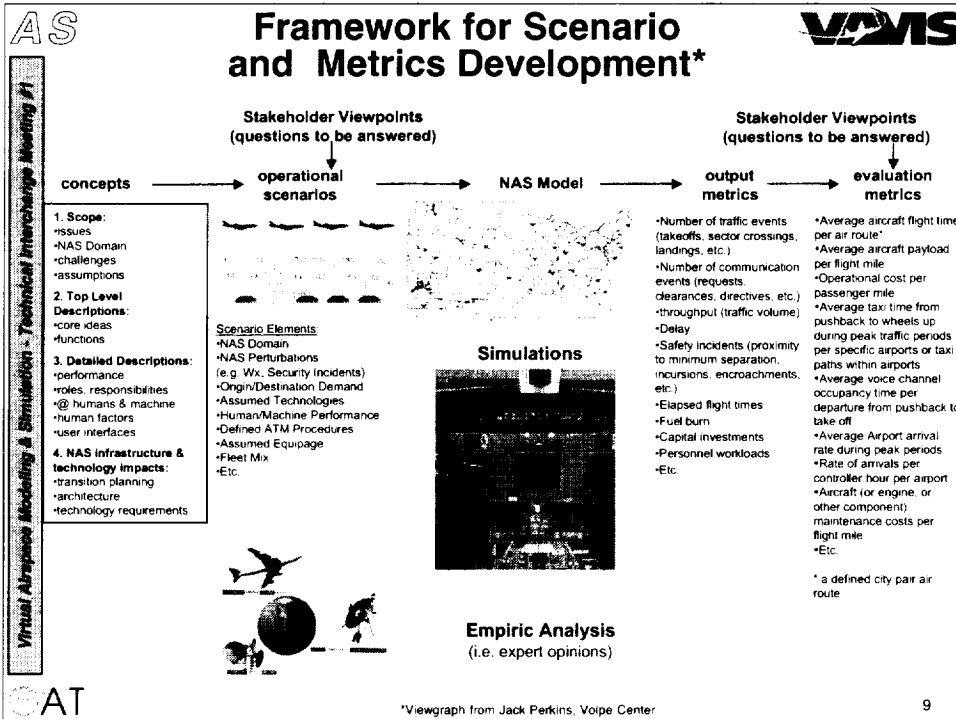

Briefing to  
NASA TIM

***Air Traffic Management Concepts of  
Operations and Their Impact on the  
National Airspace System (NAS)***

Presented by:

Wayne MacKenzie  
Deputy Air Traffic Planning Division (ATP-401), FAA  
And Member Nominated by the U.S. on the ICAO Air Traffic Management  
Operational Concept Panel (ATMCP)

May 2002

## **Outline**

- CONOPS Introduction
- NAS Modernization Process
- ICAO ATMCP Work Program
  - ICAO Operational Concept Document
  - Invariant Processes
  - Key Conceptual Changes
- RTCA NAS Concept of Operations
- Where Do We Go From Here & Summary

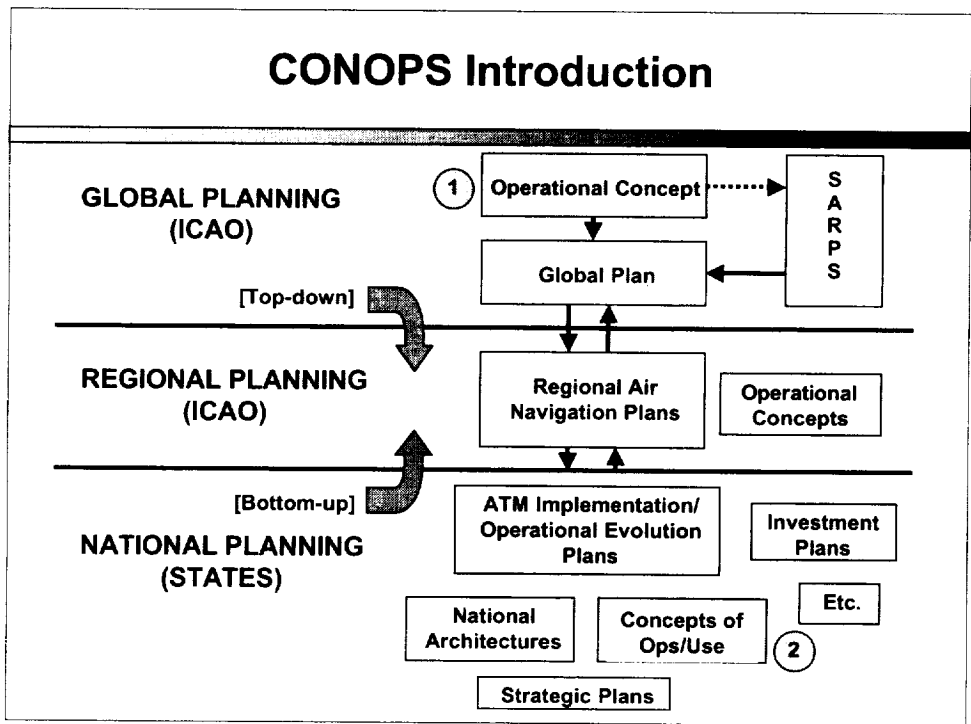
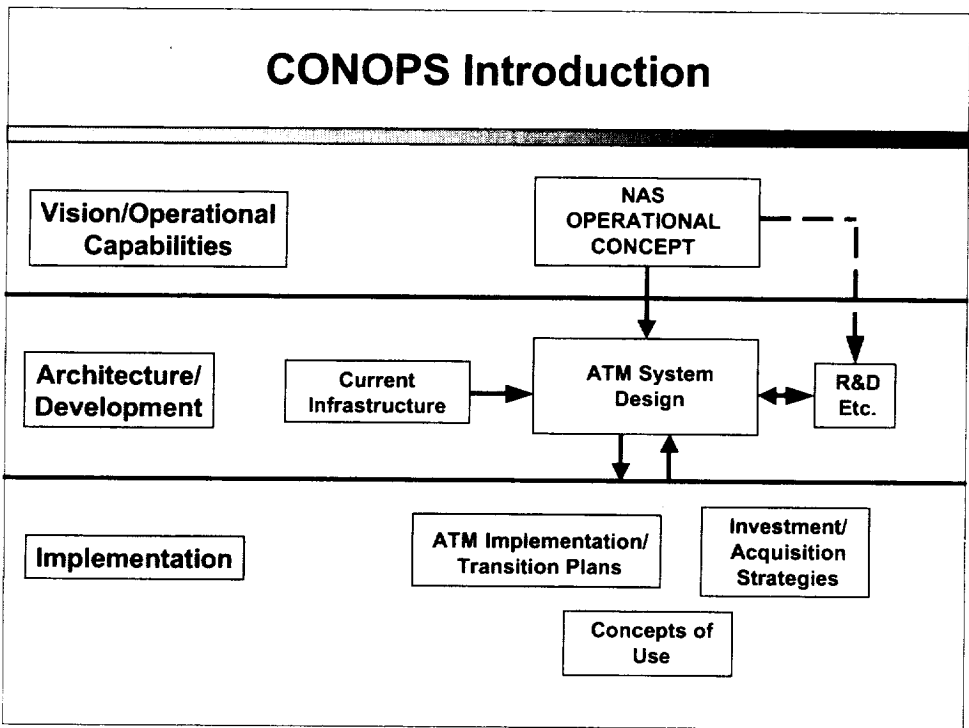

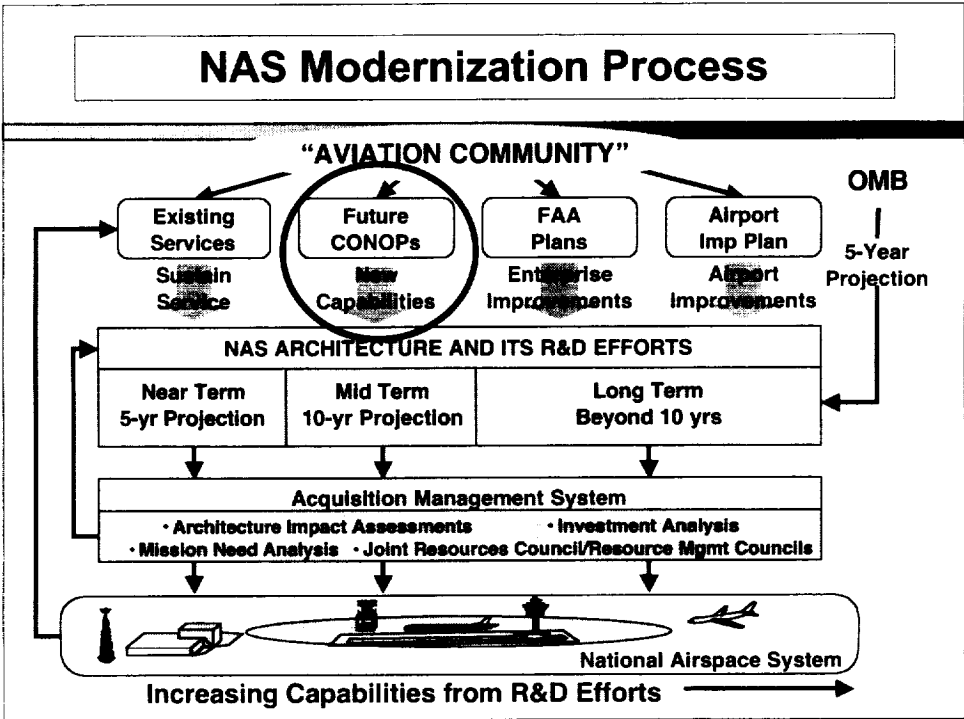

## ICAO ATMCP Work Program

→ Develop and Describe, in Sufficient Clarity and Detail, a Gate-to-Gate ATM Operational Concept That Will Facilitate the Evolutionary Implementation of a Seamless, Global ATM System.

→ The ATM Operational Concept Should:

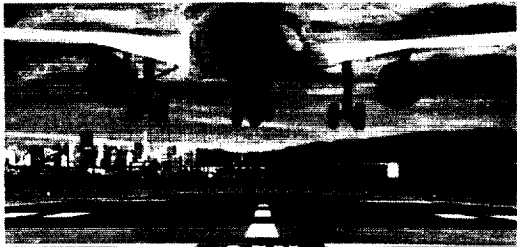

- be visionary in scope;
- not be limited by the present level of technology;
- lead to realization of all the benefits expected from CNS/ATM systems;
- provide the basis for cost-benefit analyses associated with the introduction of ATM systems.



## ICAO Operational Concept - Invariant Processes



**The Operational Concept Document lays out the foundation for the concept components and provides a general picture of the future performance of air traffic management based on the operational concept.**

- **Airspace Organisation & Management**
- **Aerodrome Operations**
- **Demand & Capacity Balancing**
- **Traffic Synchronisation**
- **Airspace User Operations**
- **Conflict Management**
- **ATM Service Delivery Management**

**Information Services**

## Key Conceptual Changes

- **AIRSPACE ORGANIZATION AND MANAGEMENT**
  - All airspace will be the concern of ATM;
  - Dynamic and flexible airspace management; and
  - Any airspace restrictions are transitory.
- **AERODROME OPERATIONS**
  - Runway occupancy time reduced;
  - Safe maneuvering in all weather conditions;
  - Precise surface guidance; and,
  - Position and intent of all vehicles and aircraft will be known.
- **DEMAND & CAPACITY BALANCING**
  - Assets optimised to maximise throughput;
  - Adjustments made to mitigate imbalance; and,
  - Dynamic adjustments to the organization of airspace.

## Key Conceptual Changes

- **TRAFFIC SYNCHRONIZATION**
  - Dynamic 4-D trajectory control and negotiated conflict-free trajectories;
  - Chokepoints eliminated; and,
  - Optimization of traffic sequencing.
- **AIRSPACE USER OPERATIONS**
  - Accommodation of mixed capabilities and worldwide implementation needs;
  - ATM data available as needed;
  - Relevant airspace information available;
  - Dynamically-optimized 4-D trajectory planning;
  - Impacts on ATM taken into timely account; and,
  - Aircraft designed with ATM system optimization a key consideration.

## Key Conceptual Changes

- **CONFLICT MANAGEMENT**
  - Strategic conflict management reduces separation provision;
  - The pre-determined separator is the airspace user;
  - The role of separator may be delegated;
  - Separation provision intervention capability;
  - Conflict horizon extended; and,
  - Collision avoidance systems part of safety management.
- **ATM SERVICE DELIVERY MANAGEMENT**
  - Services delivered on an as-required basis;
  - ATM design determined by CDM, safety, business cases;
  - Services balance and optimize user-requested trajectories; and,
  - Management by trajectory.
- **INFORMATION SERVICES**
  - Information Management, Meteorological Information Service and Other Essential Services

## RTCA NAS CONOPS

- Is NAS-specific (At the National Planning Level)
- Incorporates the Needs and Requirements of NAS Users and Service Providers.
- Based on Free Flight concept – thus, further development and validation of Free Flight will Impact RTCA Concept
- Operational Concept:
  - Safety is First Priority
  - Environmental Considerations are Taken Into Account
  - Implementation of Any New Technologies Must Improve the Safety and Efficiency of the Operational Environment
  - Human-in-the-Loop
  - Quality of Data, Information Exchange and CDM
  - Separation Assurance Remains the Responsibility of the Service Provider (Authority Can be Delegated to Flight Crews for Specific Operations)

## RTCA NAS CONOPS

- NAS Operational Concept:
  - Divided into Near-term (2005), Mid-term (2005-2010) and Far-term (2010-2015) – Global Operational Concept based on 2025
  - Mentions Specific Systems (e.g., ILS, MLS, GPS, EGPWS, CDTI, etc.). Mentions Specific Facilities (e.g., ATCSCC, AOC, FOC, etc.). Mentions Specific Procedures (DPs, etc.). Mentions Specific Solutions (e.g., Pre-Departure Clearances, ATIS-type messages, etc.) – Global Operational Concept is technology-independent – no system acronyms!
  - Is written with Civil Users, DoD Users and Space Transportation Users as the only community impacting or depending upon use of the NAS. - Global Operational Concept Defines “ATM Community” as Including the Airport Operators, the Support Industry, Regulatory Authorities, etc.

## Where Do We Go From Here?

- Draft ICAO Operational Concept Document to be Released for Comment in June/July to all Member States
- ATMCP Next Step: Preparing Operational Capabilities/Needs/Requirements Based on OCD
- RTCA Currently Working on Next Version of NAS CONOPS.

## Summary

- CONOPS are crucial to understanding future direction of the NAS
- CONOPS should be the basis for Research & Development and Requirements Development to ensure focus on operational needs not necessarily technical capabilities.

*Continued Industry and Aviation Community  
Involvement is Vital to Success*

## BACKUP SLIDES

### **Working Definitions**

#### **“OPERATIONAL CONCEPT”**

- A High Level Description of the Set of ATM Processes and Services Necessary to Accommodate Traffic at a Given Time Horizon.
- A Description of the Anticipated Level of Performance Required From, and the Interactions Between, the ATM Processes and Services, as Well as the Objects They Affect.
- A Description of the Information to be Provided to Agents in the ATM System.

more

cont.

## **Working Definitions**

### **“OPERATIONAL CONCEPT” UNIQUENESS**

The ATM Operational Concept Differs From “Architecture”  
and “Concepts of Use”

Architecture Includes the Infrastructure and a Technical  
System Description Including the Specific Technologies and  
the Functions of Personnel.

A “Concept of Use” is a More Detailed Description of HOW a  
Particular Functionality or Technology Could Be Used.

# System Level Capacity Increasing Concept

**Briefers: Bob Schwab and Al Sipe, Boeing  
Operational Concepts Team**

**Date: 21 May 02**

**Lead: Bob Schwab**

**Phone: 425.373.2522**

**Email: [robert.w.schwab@boeing.com](mailto:robert.w.schwab@boeing.com)**

Air Traffic Management

# Development Process

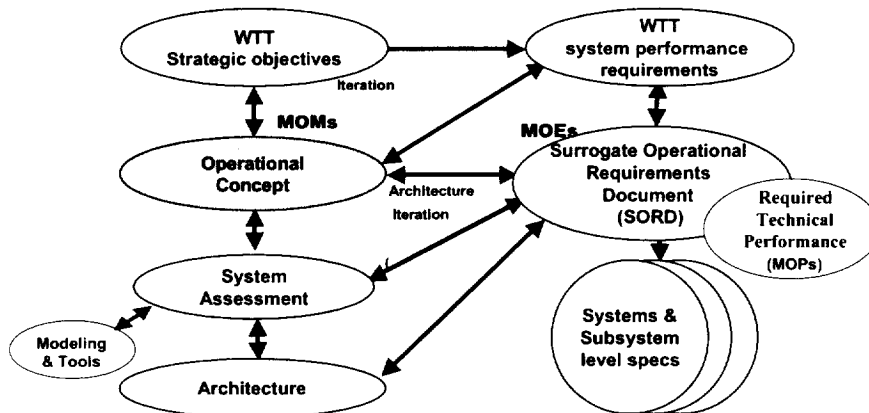

**WTT - Working Together Team**  
**MOM - Measures of Mission**

**MOE - Measures of Effectiveness**  
**MOP - Measures of Performance**

ATM 0119

Air Traffic Management

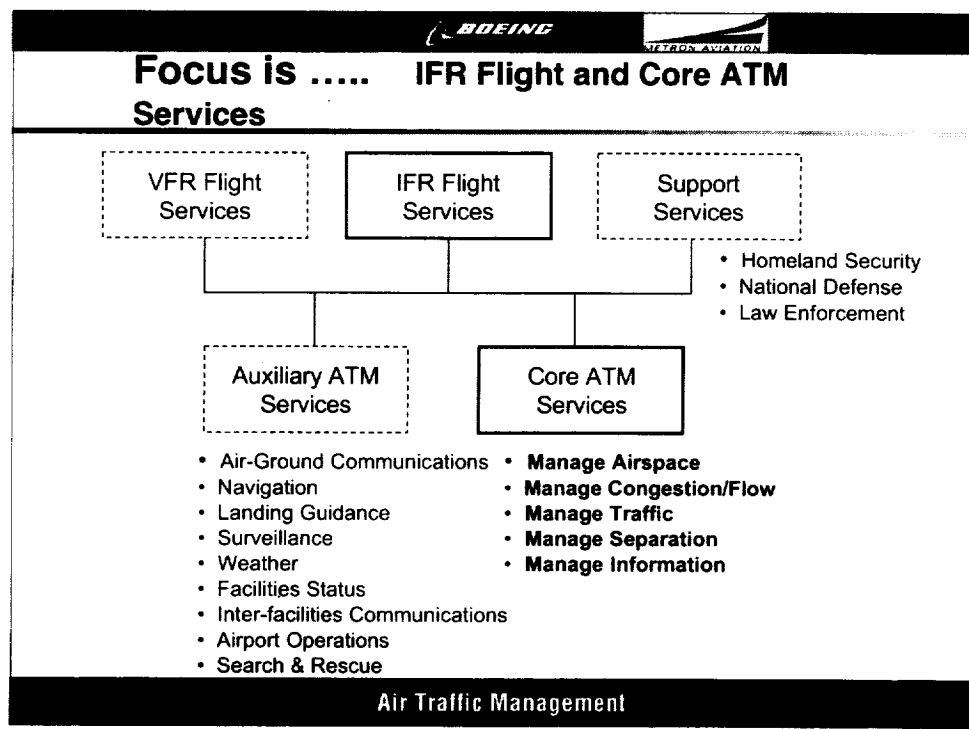
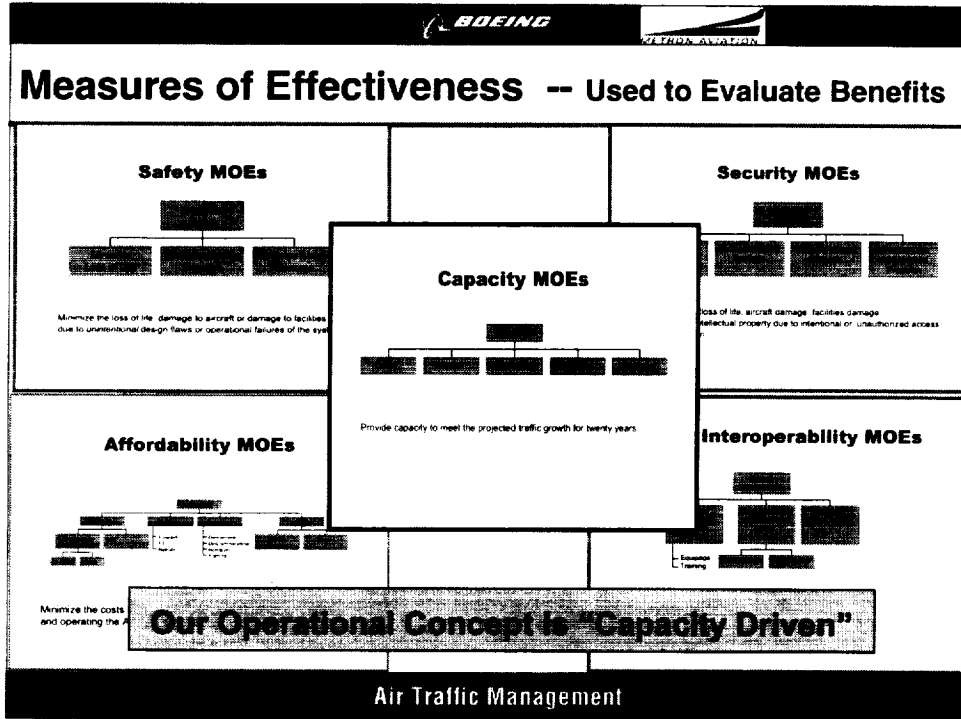



# Separation Management Concept

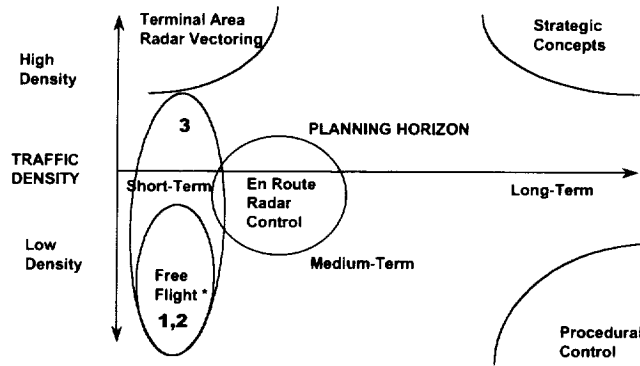

\* Free Flight:

1. The ability to operate without a flight plan, except where flow restrictions may be imposed
2. The ability to operate without constraints, given suitable traffic densities
3. The Provision of Airplane-Based Separation Assurance

Air Traffic Management

# Capacity Increasing Concept Impact on Causes of Delay

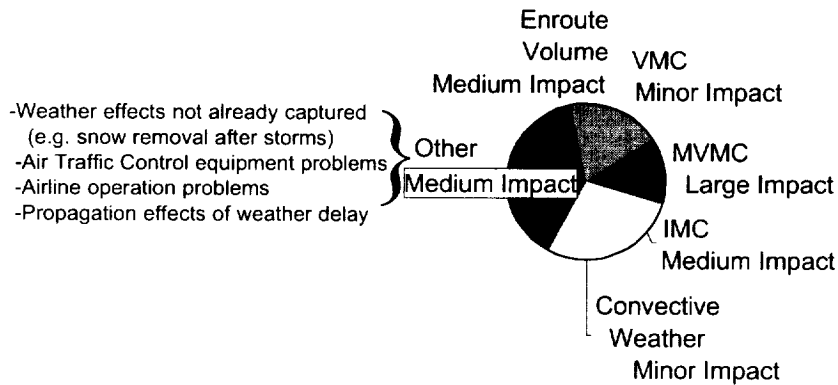

VMC – Visual Meteorological Conditions  
 MVMC – Marginal Visual Meteorological Conditions  
 IMC – Instrument Meteorological Conditions

Air Traffic Management

# ATM Operational Concept Functions

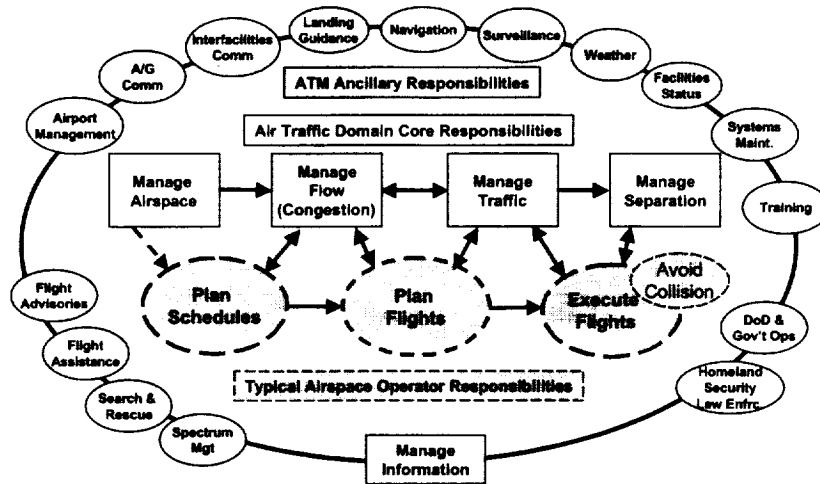

Air Traffic Management

# Current ATM Roles

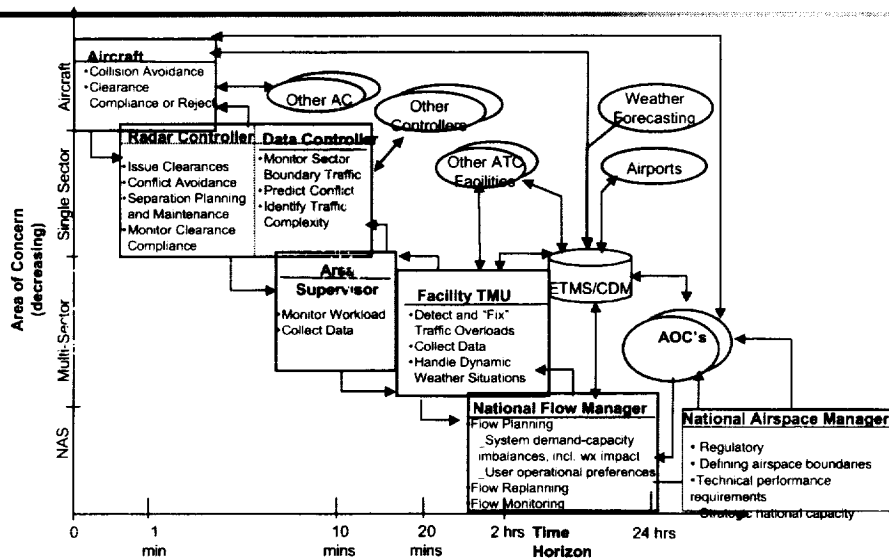

Air Traffic Management

# Manage Separation in 2020 -- Sub Functions & Benefits

**\*Trajectory based conflict prediction on the ground provides 60 minute look-ahead separation assurance**

**\*Improved information (aircraft state and intent) and technology allows aircraft separation distances to be closer to established standards**

**\*Separation responsibility in the A/C for IMC approaches under certain conditions**

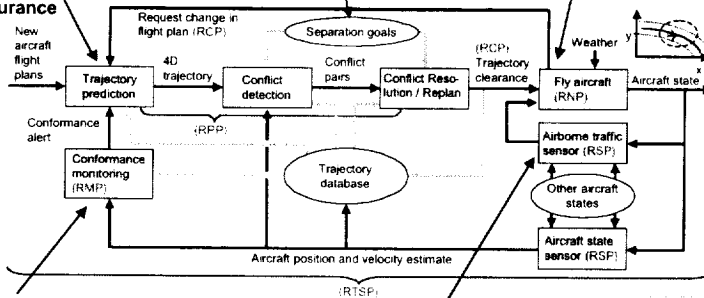

**\*Controller workload complexity managed through automated conformance monitoring**

**\*Collision avoidance responsibility resides in the aircraft**

## Air Traffic Management

### Interoperability: Strategic and Tactical Domains

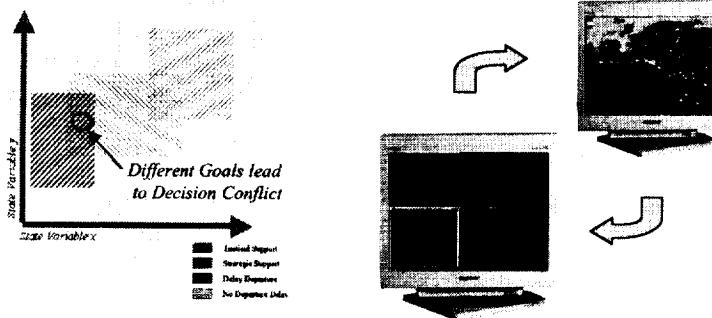

**Using decision spaces and stability analysis we identify the goal driven interactions that define system communications**

## Air Traffic Management

## Trade Study Examples

### •Planning Time Vs Predictability

- Looks at how far into the future the plan can be expected to be stable
- Impacts how far into the future trajectories are computed, how often the plan is recomputed, etc.

### •Ground vs Air

- Looks at what subfunctions are allocated to the agent in the air vs the agent on the ground
- Impacts workload and cost of airborne and ground agents

### •Human vs Machine

- Looks at workload and performance variables to decide which subfunctions are better done with humans vs added automation

Air Traffic Management

### ATM - Air Transportation Capacity Contract Increasing Surface Concept

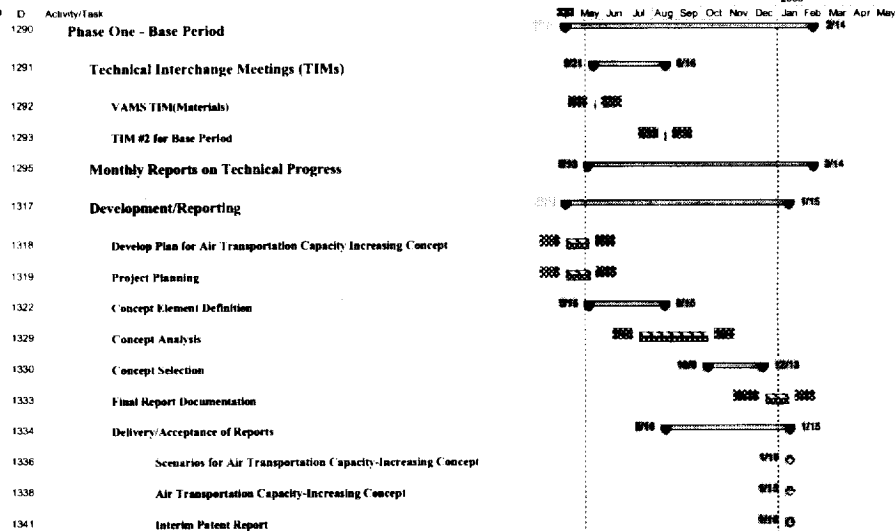

Air Traffic Management

**NRA  
TIM #1**



## **Technologies Enabling All- Weather Maximum Capacity by 2020**

Jimmy Krozel, Ph.D.  
Presented at NASA Ames Research Center  
Moffett Field, CA  
May 21-23, 2002



### **Agenda:**

- **Need for All-Weather Capabilities**
- **Who is the Metron Aviation Team?**
- **Core Ideas**
- **Enabling Technologies**
- **Roadmaps for New Technologies, Roles & Responsibilities**
- **Metrics of Goodness**
- **Costs/Benefits Tools and Analysis**
- **Motivation for Getting There**

May 21-23, 2002

NRA TIM #1

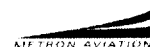

## Problem: NAS is not Robust to Weather Disturbances

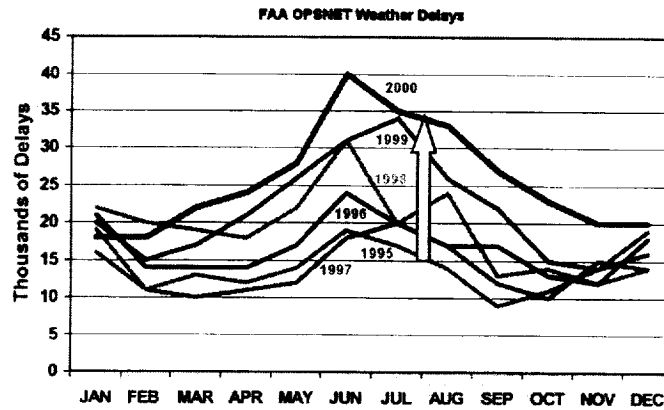

Weather related delays are currently increasing, especially during summer convective weather season.

May 21-23, 2002

NRA TIM #1



## Problem: Weather Reduces Capacity

- Flyable Airspace is reduced
- Stretched Paths occur as flights avoid weather
- Airspace Complexity Increases
- Workload Increases for Pilots and Controllers
- Capacity Decreases

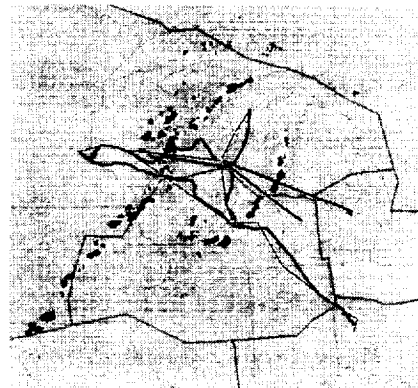

May 21-23, 2002

NRA TIM #1



## Metron Aviation Team Topical Experts:



Principal Investigator

*Jimmy Krozel, Ph.D*  
**Metron Aviation**  
Decision Support Tools  
Weather Avoidance  
Algorithms



*Terry Thompson, Ph.D*  
**Metron Aviation**  
Airspace Design  
Noise Abatement  
Route Optimization



*Mike Wambsganss*  
**Metron Aviation**  
Collaborative Decision Making  
Traffic Flow Management



*Kevin Kollman*  
**Metron Aviation**  
Airline Dispatch,  
Meteorology  
Considerations



*Tony Andre, Ph.D*  
**Interface Analysis**  
Human Factors  
Human-Computer  
Interfaces



*Prof. Phil Smith*  
**Inst. of Ergonomics**  
Human Factors  
Roles, Responsibilities &  
Procedures



*Prof. Joe Mitchell*  
**State Univ. of NY**  
Computational Geometry  
Weather Avoidance  
Algorithms Topology



May 21-23, 2002

NRA TIM #1



## Approach:

- **Systems Level Approach:**
  - **Distributed System**
  - **Competing Goals and Priorities**
  - **Geographically Dispersed Resources**
- **Data Driven – based on real NAS data to understand problems**
- **Human Centered Design Philosophy – an architecture that balances cognitive complexity constraints of human decision makers with the support of automation in terms of required Decision Support Tools (DSTs)**
- **Theoretically Founded and demonstrated Algorithms**
- **Capacity Driven:**
  - **Increasing Total Capacity**
  - **Identify Lost Capacity & Make Best use of the Available Capacity**

May 21-23, 2002

NRA TIM #1



### The Triad:

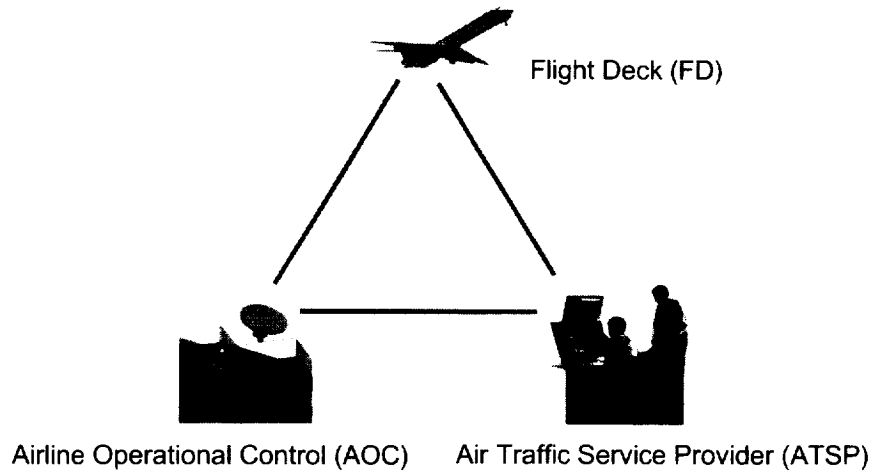

May 21-23, 2002

NRA TIM #1



### Core Idea 3 (a): Optimal Weather Avoidance

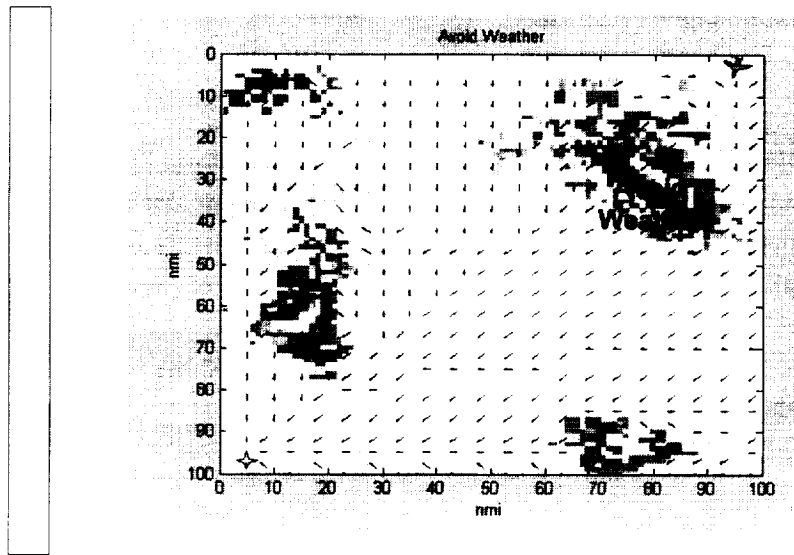

May 21-23, 2002

NRA TIM #1





### Core Idea 3 (b): Robust Weather Avoidance

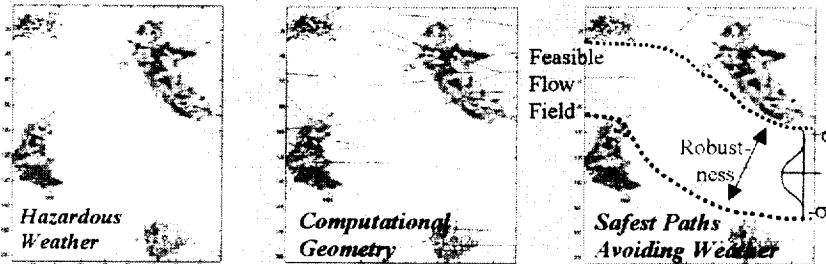

A robust route planning algorithm identifies sets of viable routes with the same topology, given uncertainties in aircraft and weather position information.

May 21-23, 2002

NRA TIM #1



### Core Idea 7: Incorporate Weather Predictions into ETAs

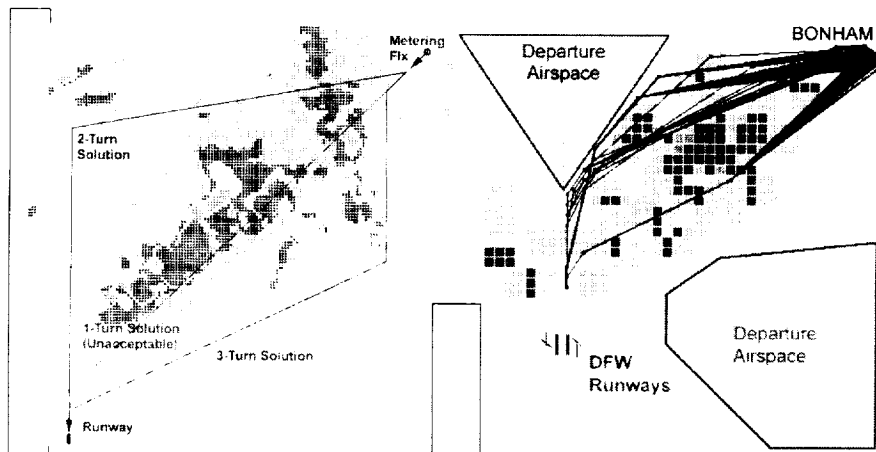

May 21-23, 2002

NRA TIM #1



## Core Idea 11: Accommodate Maximum Information Availability for CDM

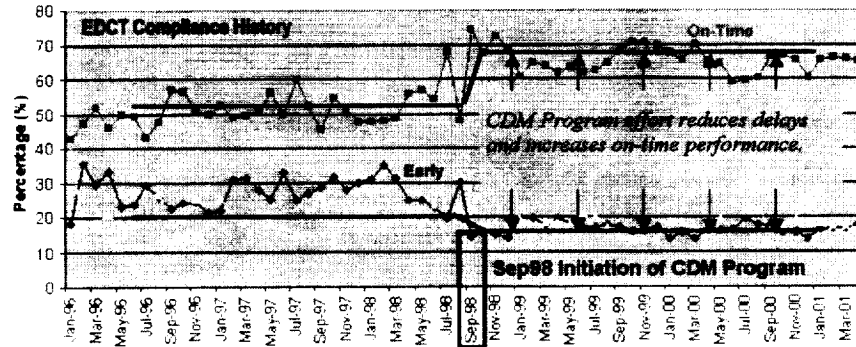

**CDM has been shown to increase predictability through information exchange, increasing NAS on-time performance.**

May 21-23, 2002

NRA TIM #1



## Enabling Technology 1: Weather Sensing and Prediction

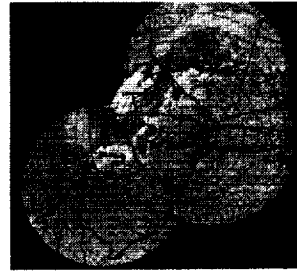
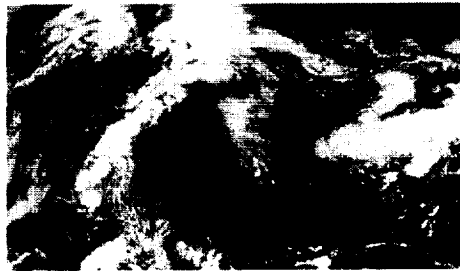

**Weather Sensing/Prediction will completely mosaic the NAS by the year 2010.**

May 21-23, 2002

NRA TIM #1



## Enabling Technology 4(a): New Displays for ATSP



ATM Magazine, Jan./Feb., 2000



Image Courtesy of Ron Azuma,  
HRL Laboratories

**New displays for ATSP will enable capacity benefits by allowing aircraft to land safely in adverse weather conditions.**

May 21-23, 2002

*NRA TIM #1*



## Enabling Technology 4(b): New Displays for the FD

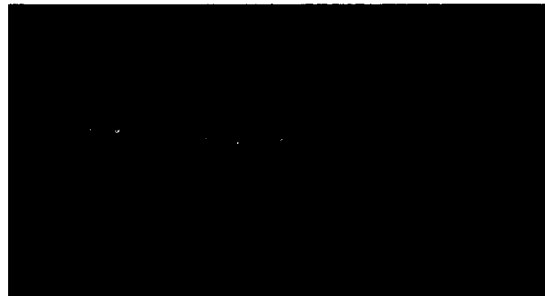

T-NASA Images Courtesy of NASA

**New displays for the FD will enable capacity benefits by allowing aircraft to land safely and taxi in adverse weather conditions.**

May 21-23, 2002

*NRA TIM #1*



## Enabling Technology 4(b): New Displays for the FD

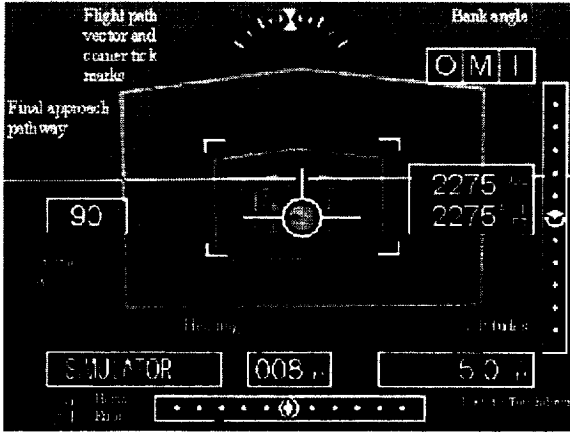

Image  
Courtesy of  
Stanford GPS  
Lab

**New displays for the FD will enable capacity benefits by allowing aircraft to accurately follow weather avoidance routes.**

May 21-23, 2002

NRA TIM #1



## Enabling Technology 5: Efficient Surface Automation

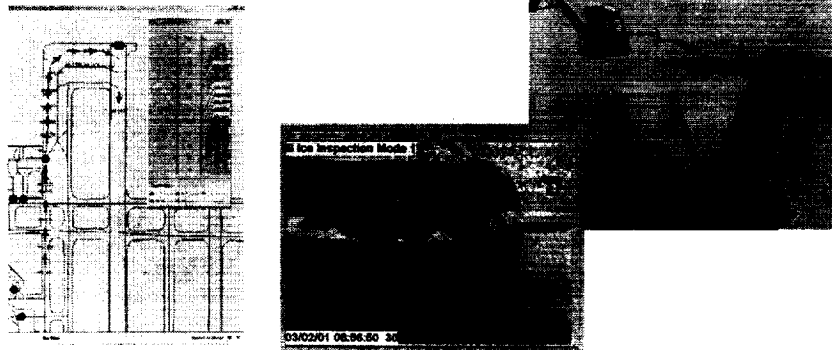

**New surface automation concepts will enable faster turn-around even in adverse weather conditions.**

May 21-23, 2002

NRA TIM #1



## Metrics of Goodness:

Metric	Category	Description
Capacity	Airport Capacity	Maximum number of operations, departures, and arrivals per hour (assuming steady-state)
	En Route Sector Capacity	Maximum number of aircraft within a given sector per hour, subject to workload constraints (pilot for DAG-TM concept; controller for ATSP concept)
Flexibility	User Preference	Accommodation of user preferences measured in terms of trajectory interruptions due to aircraft conflicts or weather deviations
Efficiency	Direct Operating Cost (DOC)	A metric determined by a combination of time and fuel
Predictability	Airport Time of Arrival (Departure) Prediction	Error in wheels on time (off time) as a function of prediction horizon time
	Sector Demand Prediction	Error in sector count as a function of prediction horizon time
Safety	Weather Exposure	Dwell time in hazardous weather
	Conflict Alerts	Trajectory deviations due to Conflict Detection
	Workload	Dynamic Density Complexity Metrics
Environment	Noise	Average annual noise exposure
	Pollution	Annual emissions of fuel-burn products
Delay	Average Delay	Average difference between planned arrival time and actual arrival time
	Average Block Time	Average time for gate departure to gate arrival

May 21-23, 2002

NRA TIM #1



## Technology Roadmaps:

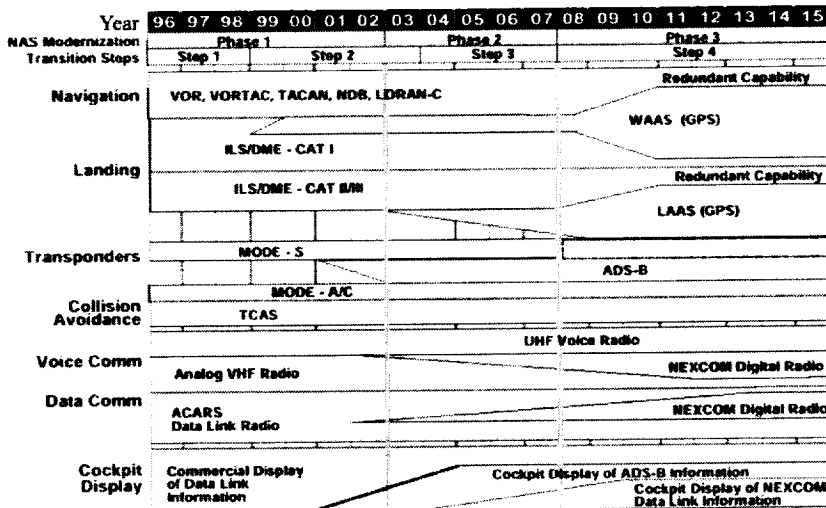

May 21-23, 2002

NRA TIM #1



## Other Roadmaps

### Roles & Responsibilities:

- Information Requirements
- Human / Automation Boundaries
- Transitional Plans

### Scenarios:

- Current NAS Baseline
- DAG-TM
- Automated Airspace Concept
- Transitional Plans

May 21-23, 2002

NRA TIM #1

METRON AVIATION

## Costs/Benefits

- Tools
  - POET
  - FACET
  - NIRS
  - ADEPT
- Analysis
  - Historical, 2000, 2010, 2015, 2020
  - Metrics of Goodness
  - Scenario-Based
  - Iterative Improvement on Capacity Improving Concepts

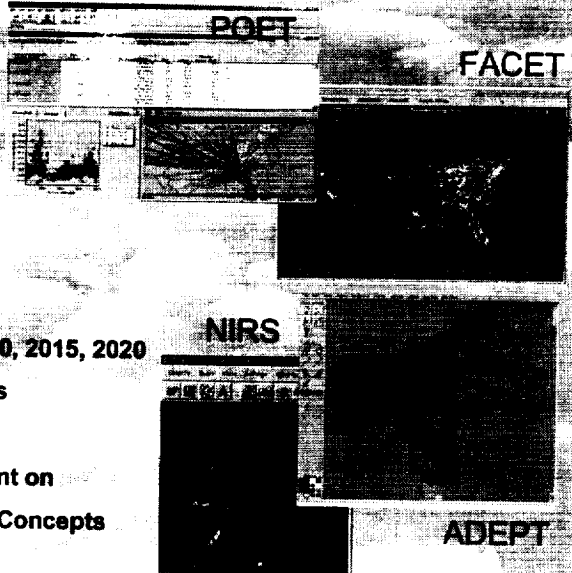

May 21-23, 2002

NRA TIM #1

METRON AVIATION

## Example Analysis with POET

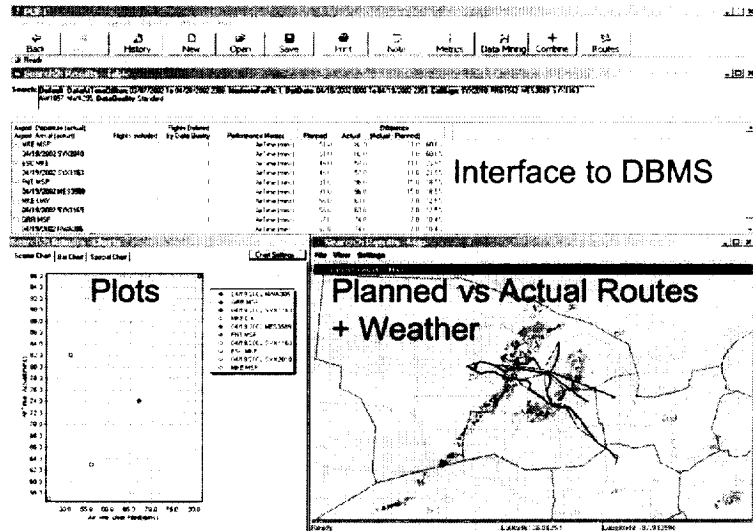

May 21-23, 2002

NRA TIM #1



## Getting There

- The Talent is in this room
- The Domain Knowledge is already learned
- The Collaboration has begun
- New Ideas have been proposed
- The Demonstrations will follow

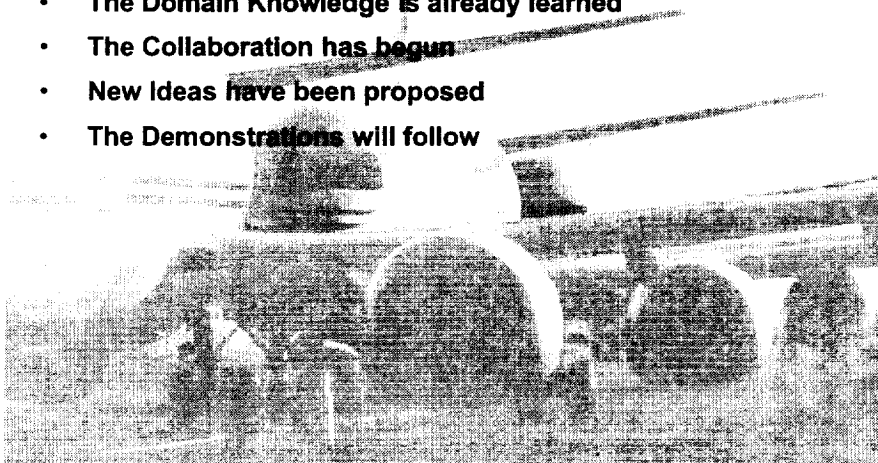

May 21-23, 2002

NRA TIM #1





# ***Massive Point-to-Point and On-Demand Air Transportation System Investigation***

## **Concept PTP Overview**

Virtual Airspace Modeling and Simulation (VAMS)  
Project  
Technical Interchange Meeting 1  
21 May 2002

**John Sorensen**  
**Seagull Technology, Inc.**  
**Tel: (408) 364-8200, jsorensen@seagull.com**

May 10, 2002

1



## **Outline**

---

- **Concept PTP Team**
- **NAS Issues and Assumptions Background**
- **Concept PTP Drivers**
- **Key Technical Challenges**
- **Core Ideas Overview**
- **Planned Early Steps**

May 10, 2002

2





## Concept PTP Team

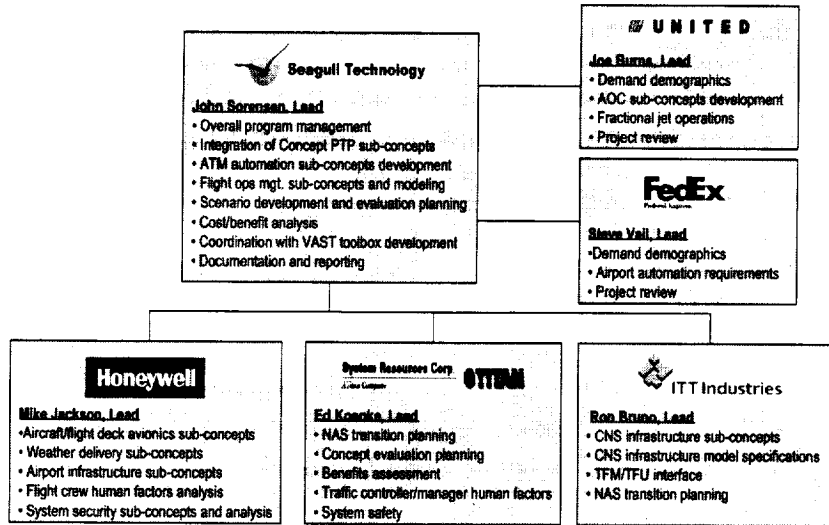

May 10, 2002



## Some of the Issues with the Future NAS

- **Approaching Hub Airport Gridlock**
  - Building more runways at hubs politically and economically difficult
- **Hub Delays and Hassle**
  - Hub-spoke system use increasingly time inefficient and unpleasant
  - Business travel moving to smaller jets for direct flights
- **Underutilized Public Airports**
  - 5400 airports are a valuable but underutilized national asset
- **Wave of new, smaller jet aircraft needing IFR services**
- **Static Sector Overload**
  - Sectors were designed to accommodate moderate traffic following static air routes
    - › Not consistent with “free flight”
    - › Problem exacerbated on storm days
    - › En route density will grow significantly with small jet PTP travel
- **Flight Security is a Relatively New National Concern**

May 10, 2002



## Concept PTP Core Idea

---

- **Enhance National Airspace System (NAS) Capacity**
  - Facilitate and Incorporate Massive Use of Point-to-Point (PTP) and On-Demand Air Transportation from Smaller Airports
- **Augment NAS Components to Implement the Concept**
  - Air Traffic Management Systems
  - Fleet Operations Infrastructure Systems
  - Aircraft Fleet Mix and Number
  - Commercial Aircraft Operations Management Processes
    - › Commercial air carriers (travel and shipping)
    - › Business jet operators
    - › Fractional jet ownership organizations
    - › Other aircraft operators (e.g., UAV, rotorcraft)
- **Concept PTP Adds Overall Transportation Capacity and Relieves Hub-and-Spoke Gridlock**

May 10, 2002

4



## Key Assumptions That Drive the Concept

---

- **Demand for smaller aircraft serving more airports and other facilities (e.g., heliports, UAV operations) will grow**
  - Continued urban sprawl and road congestion increase door-to-large-airport travel time
  - Use of small airport resources can shorten door-to-door travel time
- **Demand for point-to-point routing and “on demand” services will grow**
  - Business flyer dissatisfaction with large air carrier hub-and-spoke services
  - Willingness of corporate America to pay more to save time, avoid airport hassle, and provide personal security
- **These demands will produce a market force to create and use enabling technologies and enhanced NAS facilities**
  - New types of smaller, more economical aircraft (that will demand increased IFR services)
  - Better utilization of vast small airport resources

May 10, 2002

6



## Key Concept Benefits

---

- **Harness 5400 public airports to increase overall NAS CAPACITY**
  - System model and subsequent benefits analysis will estimate potential overall capacity gain
  - Greater small airport use will also unload larger hub-spoke airports
- **By-product is increase in overall transportation system EFFICIENCY**
  - Concept PTP model will include a door-to-door multi-modal perspective
  - Benefits analysis will measure a reduction in total travel time

May 10, 2002

7



## Concept Poses Key Technical Challenges

---

- **Need for an integrating, unifying fleet and flow management infrastructure**
  - Operators must provide flight crews and aircraft at airports to service travel and shipping demands
  - Traffic Flow Management service provider must coordinate interactions of up to ten-fold increase in flight plans
- **Need for a more distributed, flexible ATM system that simultaneously serves 5400 airports and up to 50,000 jet and other aircraft in all weather conditions**
- **System requires more capable, uniform avionics in most aircraft to function well**

May 10, 2002

8



## Utilize Related SATS Program Findings

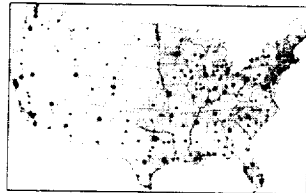

**Mobility**  
Enable people to travel faster and farther, anywhere, anytime

- 93% of population within 30 minutes of SATS-type airport
- 41% within 30 minutes of any commercial airport
- 22% within 30 minutes of major/hub airport

**Performance**  
Less travel time at an affordable price

**Accessibility**  
Safe reliable access to more locations, when & where you need it

**Cost**  
User cost  
System cost  
Provider cost

**Time**  
Doorstep to destination, with intermodal penalties

**Availability**  
Convenient, on-demand, with mission reliability

**Safety**  
Proven safer  
Perceived safer

May 10, 2002

Courtesy of NASA SATS Project



## Example SATS Demographics Model

"Reduce intercity travel time by half in ten years..."

500-1,000 mi. trip times

Without SATS

With SATS

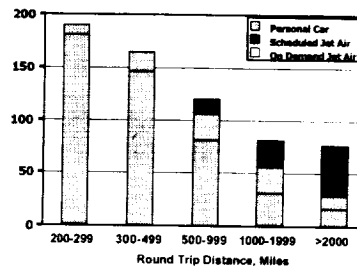
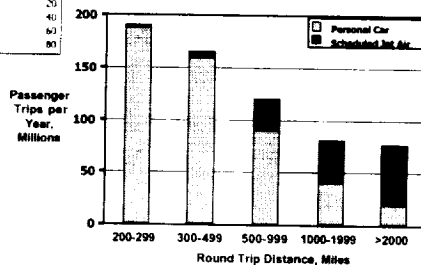
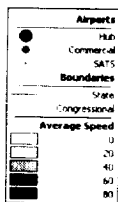
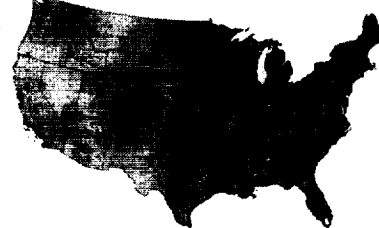
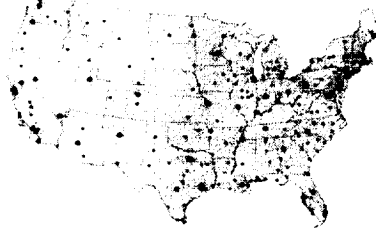

May 10, 2002

Courtesy of NASA SATS Project

10



## Concept PTP Core Ideas

---

- **1. Provide Non-Towered Airports with ATM Automation**
- **2. Utilize Terminal Area Time-Based ATM**
- **3. Integrate Strategic En Route ATM and Flight Management**
- **4. Integrate PTP Fleet Ground Operations (Dispatch)**
- **5. Accommodate Broader Aircraft Spectrum with Advanced Avionics**
- **6. Provide Integrated CNS and Weather Information Infrastructure**

May 10, 2002

11



## Core Idea 1 - Provide Non-Towered Airports with ATM Automation

---

- **Provide same traffic advisory, sequencing, weather and airport information as towered airport**
- **Provide LAAS and smart airport lighting for precision approach/departure**
- **Enable same capacity during IFR as in VFR**
- **Provide mechanism for the Greater NAS to monitor and incorporate small airport operations into emerging ATM decision support tools**
- **Increase small airport safety and perceived safety as well as capacity and travel efficiency**
- **Provide mechanism to monitor small airport operations - key element of system security**

May 10, 2002

12



## Core Idea 1 - Non-Towered Airport ATM Automation

### Increase Uncontrolled Airfield Safety, Capacity and Efficiency

Autonomous  
Airfield  
information,  
sequencing and  
traffic advisories

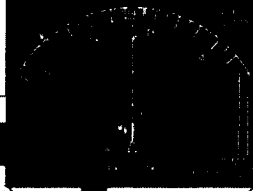

VHF, Datalink

*"Aircraft zero zero four, number two,  
following aircraft on five mile final"*

ATM Automation Hub

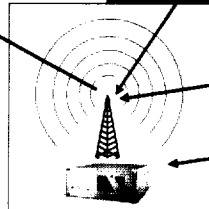

ADS-B



Weather  
Sensors

GPS

May 10, 2002

13



## Core Idea 2 - Utilize Terminal Area Time-Based ATM

- **Broaden TRACON regions to encompass small surrounding airports**
- **Replace region corner-post feeder fixes by airport anchor waypoints**
- **Expand Traffic Management Advisor (a la Multi-Center TMA) use to set non-conflicting required time-of-arrival (RTA) at anchor points and intermediate waypoints**
- **Use aircraft 4D FMS and CDTI to follow assigned transition to/from en route, approach/departure paths and RTAs (non-conflicting cells move along precise paths)**

May 10, 2002

14



## Core Idea 2 - Terminal Area Time-Based ATM

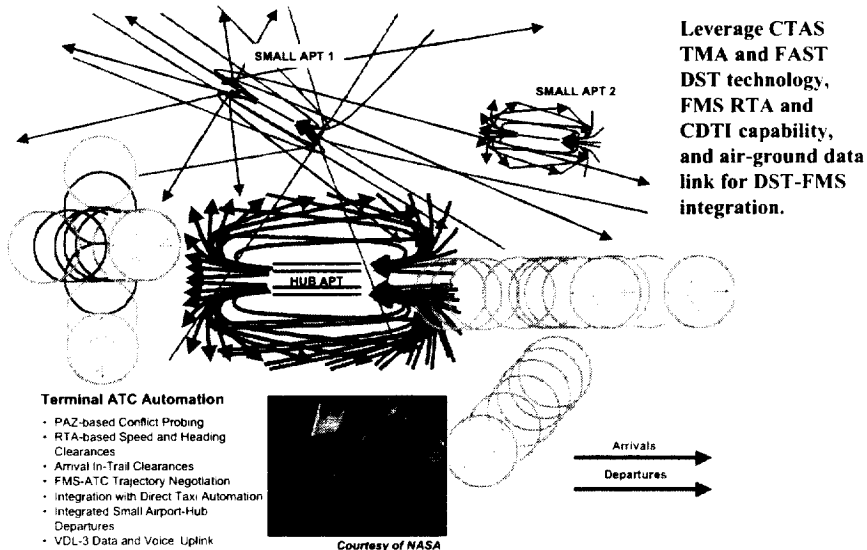

May 10, 2002

15



## Core Idea 3 - Integrate Strategic En Route ATM and Flight Management

- **Fleet operators create optimal flight plans connecting origin/destination city pairs**
- **Central and regional Traffic Flow Management adjusts plan paths and timing to lower statistical potential of conflict and to even spatial density**
- **Aircraft self separate (a la DAG TM CE-5 and CE-6) with ADS-B and 4D trajectory intent/guidance - if properly equipped**
  - Airspace segregated into sectorless altitude bands for equipped aircraft
  - Sectorized altitude bands used by non-equipped managed aircraft
- **ATM continues to provide tactical separation assurance backup, for self-separating aircraft**

May 10, 2002

16



## **Core Idea 4 - Integrate PTP Fleet Operations (Dispatch)**

---

- **Aircraft trips based on both scheduled and on-demand (taxi) bases**
- **Fleet operator/dispatcher optimizes individual aircraft/crew schedules to meet demand**
- **Auxiliary automotive services provide reserved ground transportation coinciding with aircraft arrivals and departures - complete door-to-door transportation**
- **Aircraft flight plans optimized but with timing and path constraints or adjustments (from regional TFM)**
- **Pre-trip security screening facilitates rapid multi-modal transitions**

May 10, 2002

17



## **Core Idea 5 - Accommodate Broader Aircraft Spectrum with Advanced Avionics**

---

- **Economic benefits promote use of highly equipped aircraft**
  - **Precise 4D guidance to follow timed flight plans**
  - **Required navigation performance (RNP) for precise lateral / vertical path control**
  - **Strategic conflict detection and collaborative spacing (CD&R)**
  - **Flight re-planning ability to adapt to changing winds/weather, traffic and arrival/departure RTAs**
  - **Highway-in-the-sky CDTI/PFD for situational awareness**
    - › **Precision approach and departure guidance**
    - › **Low visibility takeoff and landing**
  - **ADS-B for total airspace surveillance, CD&R, and flight plan monitoring**
  - **Full data link capability**
    - › **ATM/Dispatch information exchange with aircraft**
    - › **Collaborative flight/traffic management**
  - **Fleet size and types optimally fill the transportation demand**

May 10, 2002

18





## Core Idea 5 - Wider Aircraft Type Spectrum

### Eclipse Jet



• Price	\$627,200
• Cruise speed	285 mph (458 kph)
• Stall speed	80 mph (129 kph)
• Range	1,200 nm (2,200 statute miles) 2,000 nm (3,700 statute miles)
• Useful load	2,000 pounds

- Take-off & Land distance 2,050 ft.
- Advanced all glass cockpit
- Certified for single-pilot flight
- 5-seat configuration standard
- Semi-club and six-seat configurations optional
- Automotive-style appointments
- 41,000 ft ceiling
- 0.56 c/mi operating cost
- First Flight - Summer 2002
- Type Certification - December 2003
- First Customer Delivery - January 2004

May 10, 2002



Sonic Cruiser

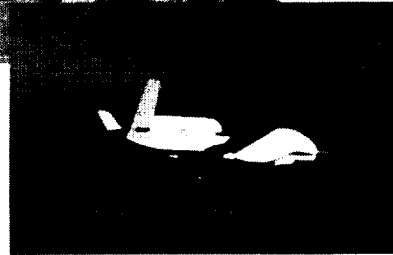

Civil and Commercial UAV Applications

19



## Core Idea 6 - Provide Integrated CNS and Weather Information Infrastructure

- **Communications - Data links, wireless, and land lines tie all nodes of system together at all times**
  - NAS Wide Information System (NASWIS) realized
- **Navigation - GNSS enhanced with redundant ground system**
  - All aircraft guided and monitored to be within flight plan envelopes for security and increased airspace capacity
- **Surveillance - All aircraft either ADS-B or radar transponder equipped**
  - All aircraft under continuous surveillance
  - Linked ground stations provide seamless aircraft state and intent data
- **Winds/weather/atmosphere - Integrated meteorological sensor system provides common weather data to all nodes**
  - Collaborative flight planning, re-planning, trajectory timing, weather avoidance based upon common data set

May 10, 2002

20



## Underutilized Airports and Airspace Provide ...

*... an Opportunity for Increasing System Capacity*

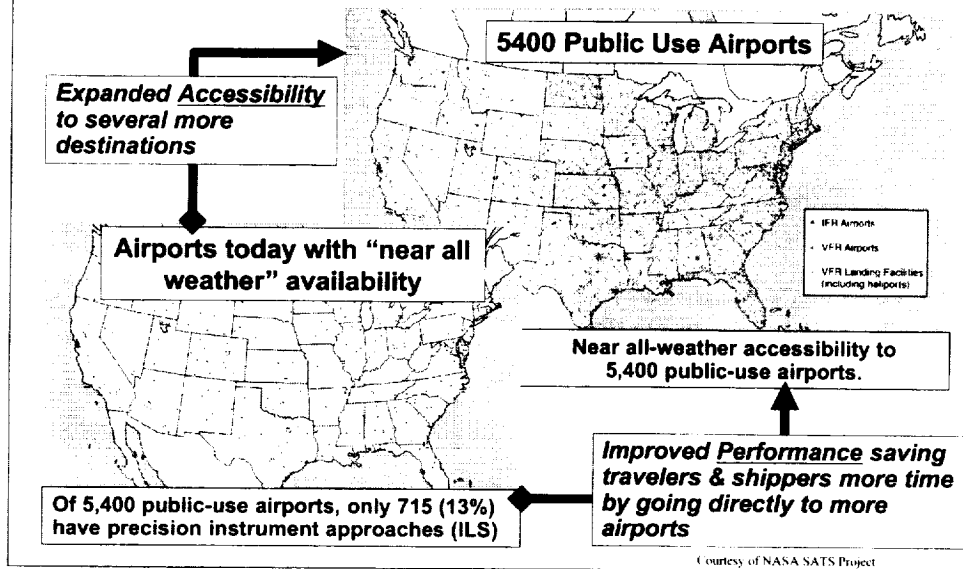

## First Steps in Describing Concept PTP

- **Build traffic demand model for 2020**
  - Select regions under-served or capacity constrained
  - Estimate types and numbers of aircraft involved
  - Develop city-pair flight plans within region
    - › Trajectories
    - › Arrival timing
  - Use to quantify ATM and fleet management challenges
  - Input as part of Concept PTP scenarios
- **Build functional model to implement Concept PTP**
  - Emphasize components needed to complement hub-spoke developments; leverage on-going technology development efforts where we can
  - Define roles of humans and automation

# Concept PTP: Massive Point-to-Point and On-Demand Air Transportation

**En Route**  
 Static sectors replaced by sectorless and flexible sector paradigms

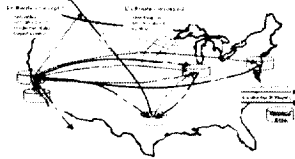

**Terminal**  
 4D approach and departure trajectory contracts to/from dense hubs and local small airports

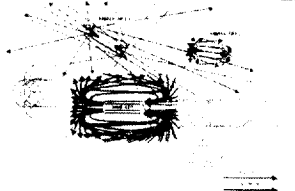

**Surface**  
 Non-towered airport ATM automation and precision landing guidance

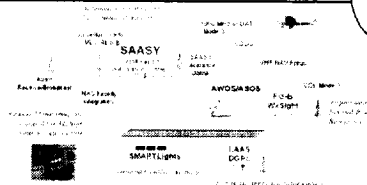

**Cross-cutting TFM**  
 May 10, 2002

High-fidelity trajectory-based flight planning and replanning coordination between aircraft operator and ATSP from pre-flight to gate-in

Point-to-Point Concept Facilitates Efficient Use of:



New Aircraft Types

More Destinations



**Result:**  
 Potential Order of Magnitude Increase in NAS Capacity

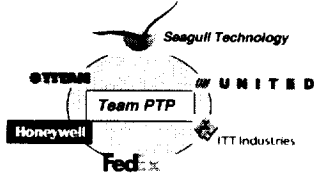



# Optimization in the National Airspace System

Dr. Banavar Sridhar  
NASA Ames Research Center  
Moffett Field, CA 94035  
bsridhar@mail.arc.nasa.gov

VAMS Technical Interchange Meeting  
May 21, 2002



## Outline

- Problem description
- Research plan
- Examples



## Traffic Flow Management (TFM ) Problem

- **Capacity**
  - Theoretical maximum flow rate supported by the separation standard
- **Throughput**
  - Rate of flow realized in operation
- **Efficiency**
  - How close is throughput to capacity?
- **Objective**
  - Maximize flow rate to meet traffic demand



## Characteristics of TFM

- **Hierarchical command and control structure**
  - 20 centers and 830 high and low altitude sectors
- **Time scales**
  - 1 to 6 hours (National and Center flow planning)
- **Large number of aircraft (~10,000)**
- **Inter-center boundary connectivity**
- **Sector congestion**
- **Aggregation and decomposition**





## Future ATM Concepts Evaluation Tool (FACET)

- **Simulation tool for exploring advanced ATM concepts**
  - Flexible environment for rapid prototyping of new ATM concepts
  - Interface with Host and ETMS data
  - Can be integrated with other tools of varying complexity and fidelity
- **Balance between fidelity and flexibility**
  - Model airspace operations at U.S. national level (~10,000 aircraft)
  - Modular architecture for flexibility
  - Software written in "C" and "Java" programming languages
    - » Easily adaptable to different computer platforms
    - » Runs on Sun, SGI, PC and Macintosh computers
  - Can be used for both off-line analysis and real-time applications

7



### Example: Current system NO WESTGATES/RBV Playbook Plan

The screenshot displays the FACET software interface. At the top, a window titled "NO WESTGATES/RBV" contains text: "Inserted Scenario: NO WESTGATE departure from ELIOT, PARKE, BIGGY, LAIRDA and RWY on RBV" and "Inserted Edge: ZNY Westbound departures via 36, 34, 33, 32, 31, and 27". Below this is a menu bar with "File", "Edit", "View", "Tools", "Help", and "Close". The main interface is split into two panes. The left pane, titled "Animation Simulation Airspace Aircraft Applications", shows a dark area with "Status Window" and "National Playbook" tabs. The right pane, titled "NAS Constraint Setup", has a "File" menu and a "Display Setup" section with a tree view containing "National Playbook", "ZNY Airway", "ZNY 35", "ZNY 32", "ZNY 31", "NO\_OTCH", "NO\_WAVE", "NO\_WAYE", and "NO\_WESTGATE". Below the tree is a "Suppressed Plans" section with "NO\_WESTGATE". At the bottom of the right pane are buttons for "Display Graphics", "Cancel Display", "Clear All", "Display Text", "Implement", "Cancel", and "Close".

8



### Impact of Rerouting and Departure Delays on ZNY

Sector Counts (In)				
File	EW	LGA	Table	
Time	ZNY73	ZNY42	ZNY34	ZNY10
Cap	8	14	14	14
13:06	8	14	14	14
13:21	14	16	11	17
13:36	16	16	19	18
13:51	8	12	15	13
14:06	11	8	10	14
14:21	12	8	8	10
14:36	8	11	10	12
14:51	7	11	7	10

Nominal Sector Counts

Sector Counts (In)				
File	EW	LGA	Table	
Time	ZNY73	ZNY42	ZNY34	ZNY10
Cap	7	15	19	9
13:06	7	15	19	9
13:21	9	12	20	12
13:36	14	18	14	15
13:51	8	10	17	10
14:06	11	7	14	11
14:21	12	8	11	9
14:36	7	10	14	9
14:51	7	10	10	13

NO\_WESTGATES Rerouting

Sector Counts (In)				
File	EW	LGA	Table	
Time	ZNY73	ZNY42	ZNY34	ZNY10
Cap	7	13	15	9
13:06	7	13	15	9
13:21	8	10	13	12
13:36	10	13	10	14
13:51	8	7	10	10
14:06	8	5	8	11
14:21	10	8	8	9
14:36	8	10	8	8
14:51	8	8	8	13

NO\_WESTGATES + EWR and LGA Departure Delays



### EWR and LGA Delay Contours

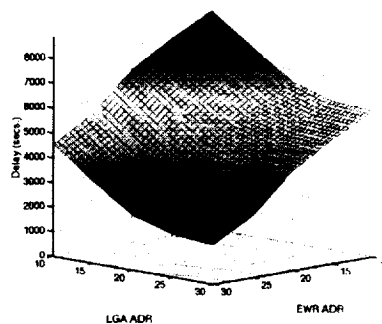
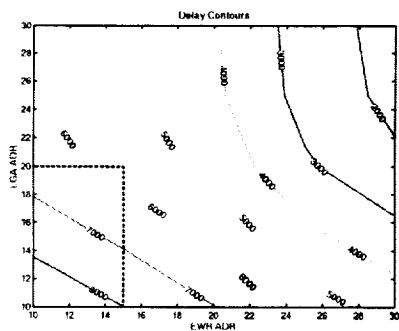





## Example: Future system Optimal en route air traffic control

- Sequential trajectory planning
- Wind-optimal routing
- Full-trajectory conflict resolution
- Periodically re-compute to mitigate disturbances
- Incorporate stochastic disturbances (Weather, SUA)



## Wind-optimal route

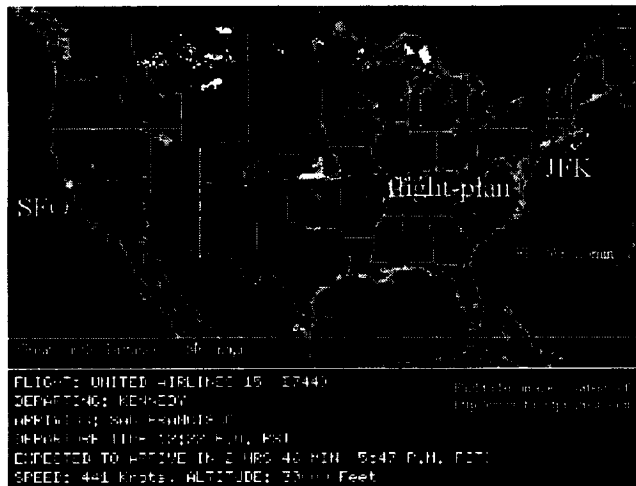



## Optimal routes

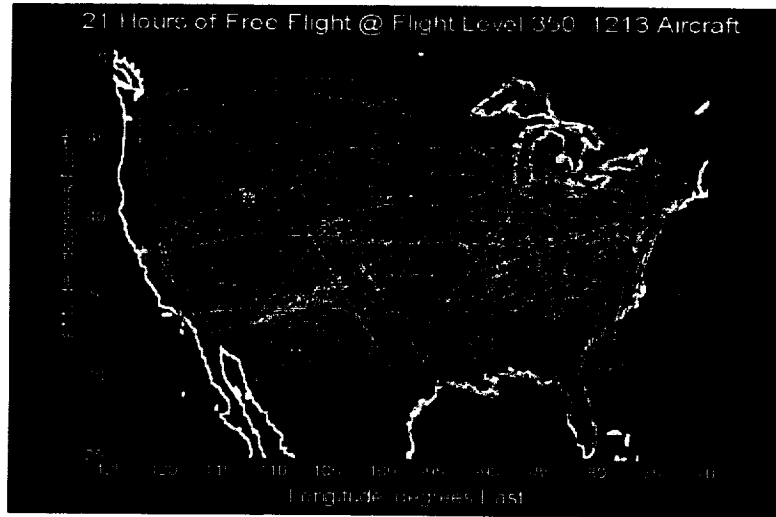

## Optimal ATC video

- Develop Integrated Concept sooner, i.e., don't just develop separate operational concept then try to "staple integrate" too late in the project.
  - *Nothing stops this desire.*
- Do we have an acronym list?
  - *Yes, it is available at the registration desk.*
- CNS tools are integrated late, i.e., Build 3 (VAST) deliver/integrate sooner.
  - *Every build will have limited CNS capabilities as a function of the scenarios required.*

- Need to release VAMS framework requirements sooner.
- We need a common WWW-site location where information can be distributed on concepts, models, and overviews.
- Will the VAST architecture support concept models?
  - *Yes.*

- Who codes?

- Options:

- ➔ *Concept developers working the FOM and the API definitions.*

- ➔ *VAST Team if generalizable, definable and within scope?*

- Options to be flushed out by next TIM

- Availability of CD from presentations?

- *We are targeting next Wednesday to mail to each presenter and/or organization that is working on VAMS.*

**NRA  
TIM #1**



## **Capacity Improvements Through Automated Surface Traffic Control**

Brian Capozzi, Ph.D.  
Presented at NASA Ames Research Center  
Moffett Field, CA  
May 21-23, 2002

### **Agenda:**

- **Need for Automation of Surface Control**
- **Meet the Metron Aviation Team**
- **Concept Overview and Core Ideas**
- **Enabling Technologies**
- **Roadmaps for New Technologies**
- **Metrics of Goodness and Costs/Benefits**
- **Summary and Motivation for Getting There**

May 21-23, 2002

NRA TIM #1

2



## The Need for Surface Automation...

## Surface Constrains NAS Throughput

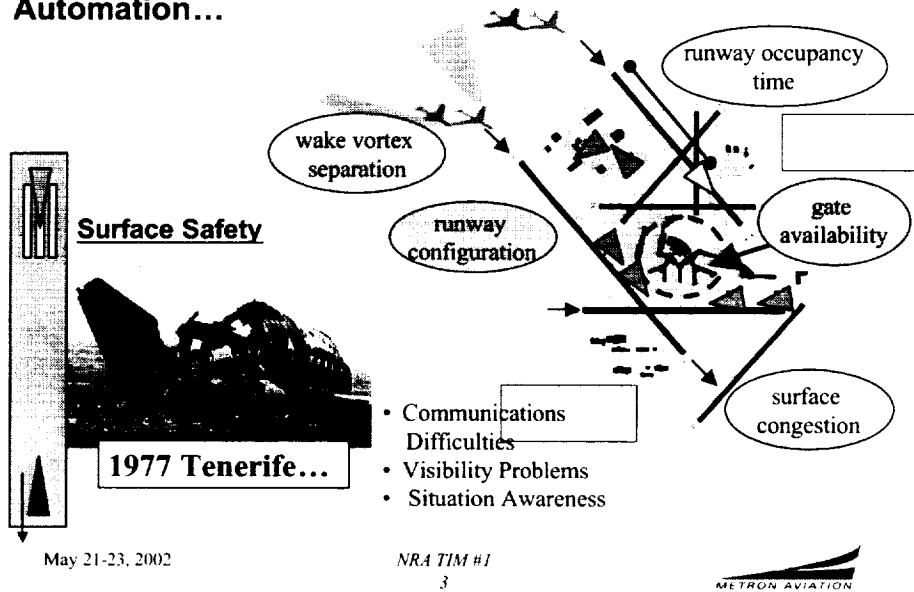

## Metron Aviation Team of Topical Experts



Principal Investigator

**Brian Capozzi, Ph.D.**  
Metron Aviation  
Path Optimization  
Autonomous Systems  
Algorithm Design



**Bruce Ware**  
Metron Aviation  
Ops Expertise  
Statistical Analysis  
ATSP Experience



**Prof. Phil Smith**  
Cognitive Systems  
Human Factors  
Roles, Responsibilities, &  
Procedures



**Chris Brinton**  
Metron Aviation  
Surface Automation  
Decision Support Tools  
Software Development

May 21-23, 2002

NRA TIM #1

4

METRON AVIATION

## Concept Overview

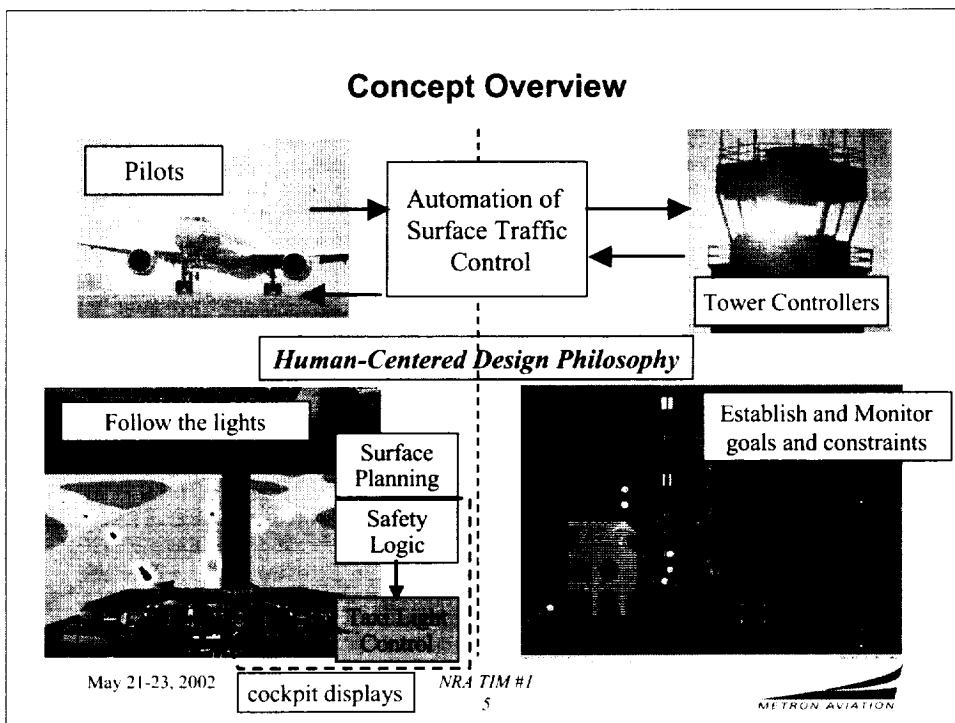

## Roles and Responsibilities

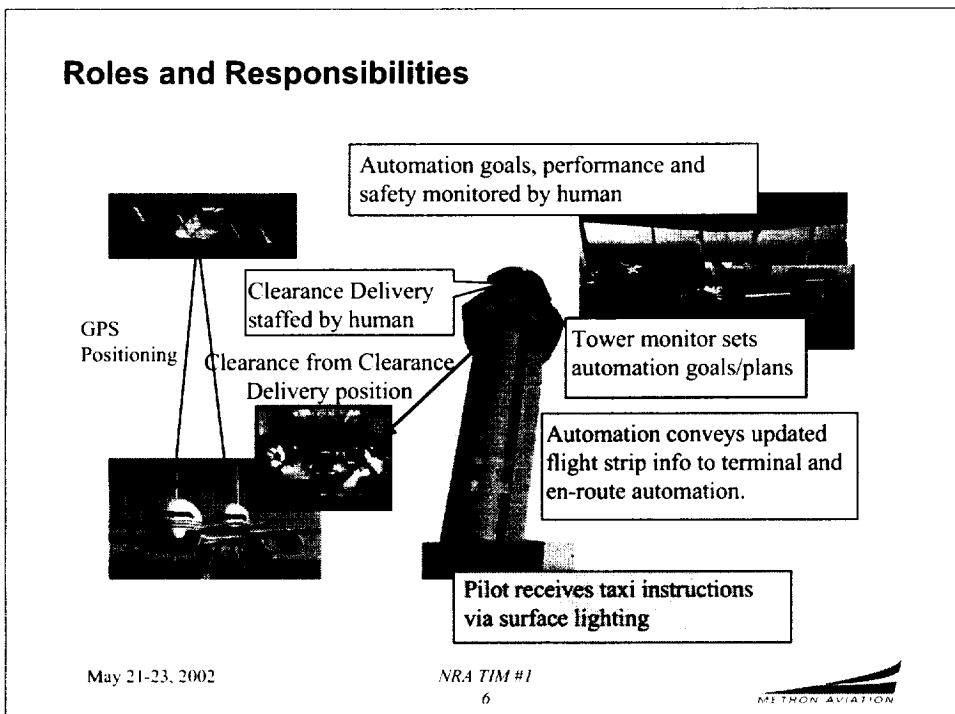

# Technical Aspects

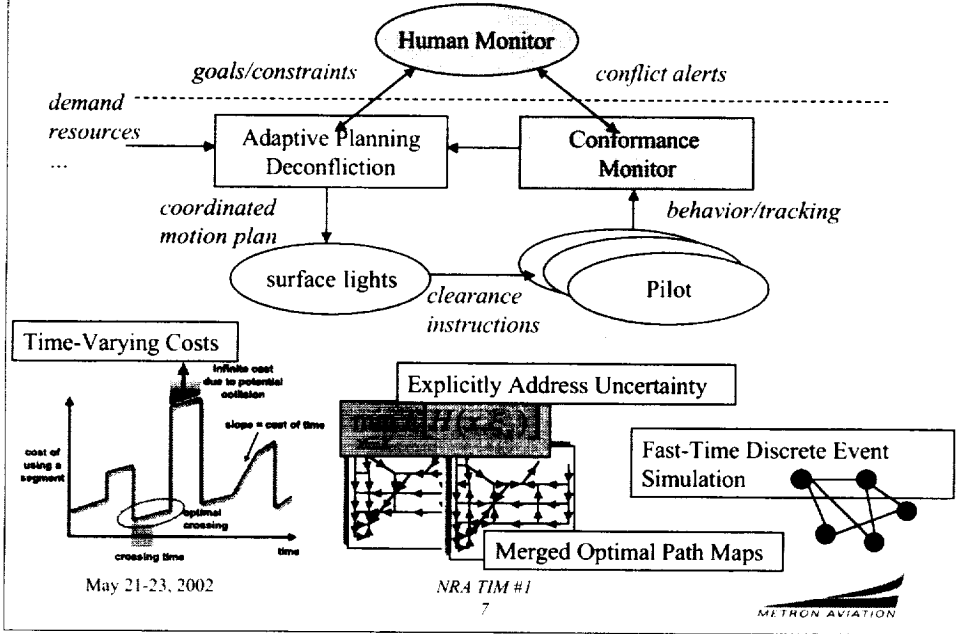

# Constraints on Solution

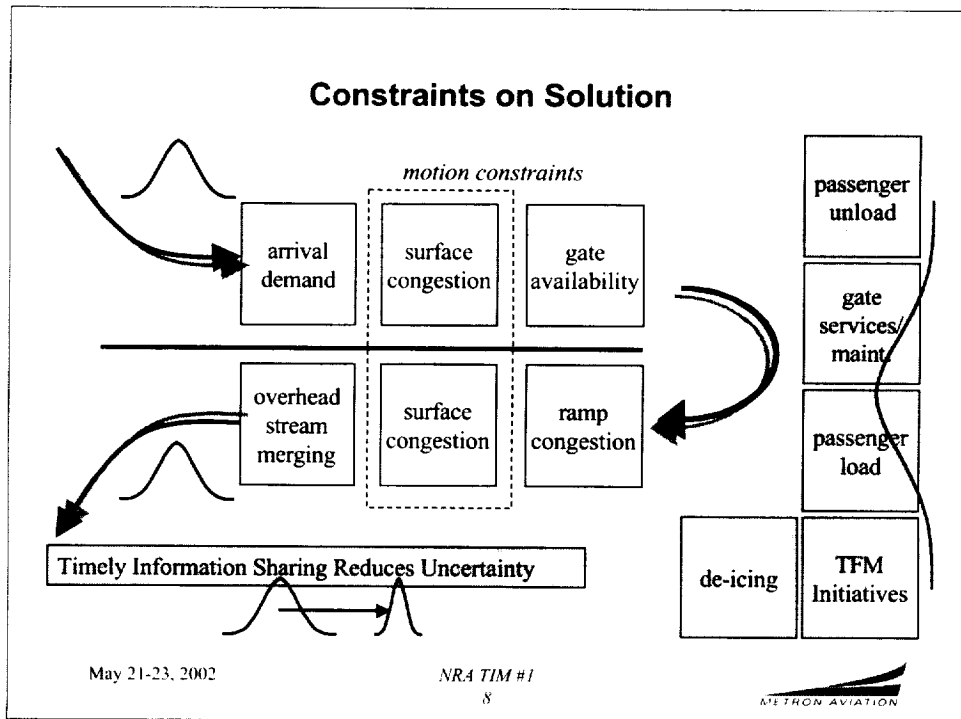



## Example Operational Concepts

Normal Operation

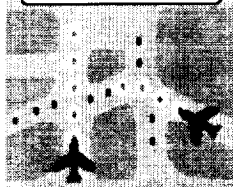

Blunder Detected

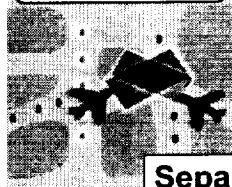

Conflict Resolved



Separate Safety Logic

Normal operation

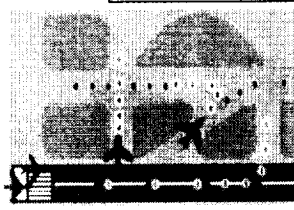

Failure Detected

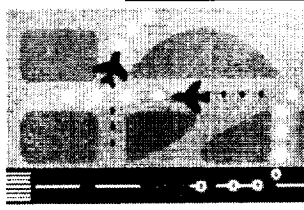

Stop Condition

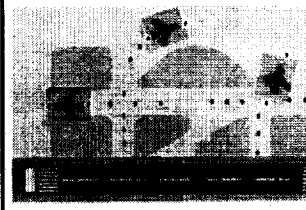

Fail Safe Operation

NRA TIM #1  
9



## Enabling Technologies

GPS, ADS-B, ASDE-X  
position, velocity, intent  
and uncertainty data used

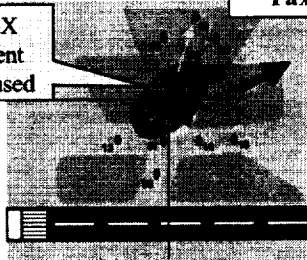

Taxiway Light Control System

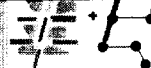

- 25 ●
- 26 ●
- 39 ●
- 40 ●

Assignment of  
updated colors to  
all applicable  
lights

Weather and User Response Prediction

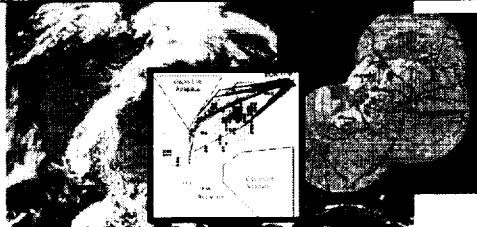

Microburst prediction  
Storm Location & Motion  
Terminal Winds

*Weather Sensing and  
Prediction will mosaic the  
NAS by 2010*

May 21-23, 2002

NRA TIM #1  
10



## Roadmaps for New Technologies: Evolution

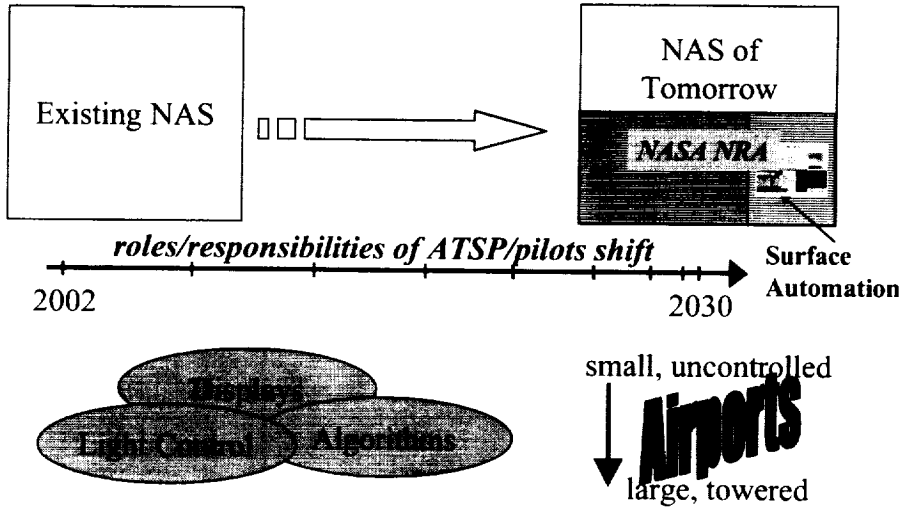

May 21-23, 2002

NRA TIM #1  
11

METRON AVIATION

## Roadmap for Surface Automation: Evolution

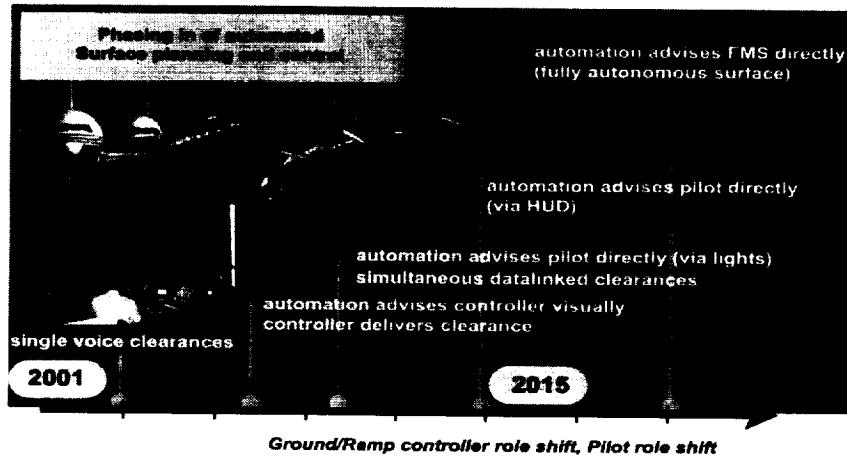

May 21-23, 2002

NRA TIM #1  
12

METRON AVIATION

## Use of Advances in Display Technology

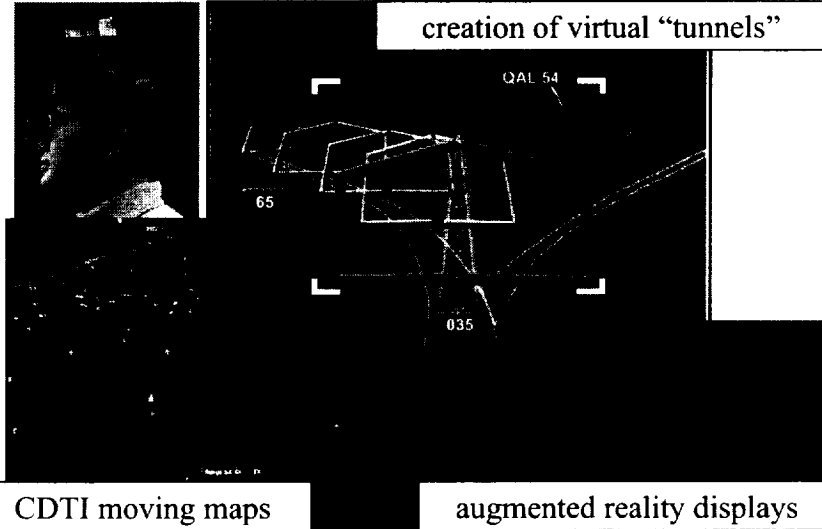

May 21-23, 2002

NRA TIM #1  
13



## Metrics of Goodness

Metric	Category	Description
<b>Capacity</b>	Airport Arrival Rate	Maximum number of arrivals (typically per hour) as measured by wheels "on" time upon landing
	Airport Departure Rate	Maximum number of departures per hour as measured by wheels "off" time
	End-to-End Throughput	Maximum number of arrival -to-departure events per hour (including gate turn time)
<b>Predictability</b>	Airport Time of Arrival (Departure) Prediction	Error in wheels on time (off time) as a function of prediction horizon time
<b>Efficiency</b>	Direct Operating Cost (DOC)	A metric determined by a combination of time and fuel
	Taxi-in time	Measured from touchdown to brakes applied at gate
	Taxi-out time	Measured from brake release to either wheels "off" time or radar target recognition (ACARS message)
	Average Queuing Time	Average amount of time spent in queues from pushback to start of departure roll

May 21-23, 2002

NRA TIM #1  
14



## Metrics of Goodness

Metric	Category	Description
<b>Environment</b>	Noise	Average annual noise exposure (DNL)
	Pollution	Annual emissions of fuel-burn products
<b>Safety</b>	Conflict Alerts	Trajectory deviations due to Conflict Detection
	Runway Incursions	Incidents on the airport surface due to controller error or lack of pilot situational awareness
	Blunder recognition time	The time required for the controller to become aware of pilot errors in following clearances
<b>Flexibility</b>	User Preference	Accommodation of user preferences measured in terms of surface trajectory interruptions due to aircraft conflicts
	Slot Swapping	Total number of slots exchanged in surface path plans
	Block Swapping	Exchange occurring across windows or blocks of time (0-15min, 15-30min, etc.)
<b>Equity</b>	Delay Deviation	Measure of Delay Deviation amongst Users and User Categories

May 21-23, 2002

NRA TIM #1  
15



## Metrics of Goodness – Cost/Benefits

**POET**

**DOC**  
Delay

**Capacity**

**Human Factors**

**AAR**  
**ADR**

**user preferences**

**situational awareness**

**workload complexity**

**equity**

**recognition time**  
**runway incursions**

- **Tools**
  - POET
  - FACET
  - Simulation-Based
  - Cognitive Walkthroughs
- **Analysis**
  - Historical, 2000, 2010, 2015, 2020
  - Scenario-Based
  - Iterative Improvement on Capacity Improving Concepts

May 21-23, 2002

NRA TIM #1  
16



## Summary and Motivation

- **Surface Automation is a Logical First Step to ATC Automation**
- **A Shift in Roles and Responsibilities of ATSP/FD is needed**
- **Our Concept requires no new equipment in the cockpit**
- **A revolutionary solution with an evolutionary implementation**
- **The Demonstrations will follow**



May 21-23, 2002

*NRA TIM #1*  
17

  
MITRON AVIATION

# Surface Operation Automation Research — SOAR —

Dr. Victor H. L. Cheng  
Optimal Synthesis Inc.  
Los Altos, California

Virtual Airspace Modeling and Simulation (VAMS)  
Air Transportation System Capacity-Increasing Research  
Technical Interchange Meeting  
May 21–23, 2002

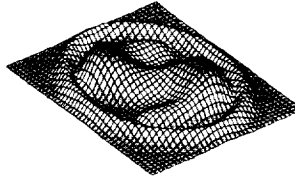

TIM 5/2002

1

## Outline

---

- Background
- SOAR Concept
- Ground-Control Automation
- Flight-Deck Automation
- Operational Integration of Automation Systems
- Remarks on Evaluation Metrics



TIM 5/2002

2

## Background

---

- Capacity problem identified in National Airspace System (NAS) Operational Evolution Plan (OEP):  
Traffic is concentrated at key airports
  - Two-thirds of scheduled traffic moves through hub airports
  - Approximately 90% of delay is experienced at these airports
  - Demand will grow by 200 million passengers at these airports over the coming decade
- Spatial constraints on NAS
  - ARTCC — 3D Space ⇒ Free Flight
  - TRACON — 2D Space and Patterns
  - Approach and Landing — 1D
  - Surface Operation — 2D Network ⇒ Orderly Traffic



TIM 5/2002

3

## Critical Factors Affecting Capacity

---

- Two factors of capacity  
$$\text{Capacity} = \text{Space} \times \text{Density}$$
  - Space enhancement: increase in runways and taxiways
  - Density enhancement: reduction in separation
- NAS OEP Solutions
  - Near-term (2001)
    - New runways at Detroit and Phoenix
  - Mid-term (2002–2004)
    - New runways or extensions at six of the top 31 airports: Houston, Minneapolis, Miami, Orlando, Charlotte, Denver
  - Far-term (2005–2010)
    - New runways at another six of the top 31 airports: Atlanta, Cincinnati, Dallas Ft. Worth, Dulles, St. Louis, and Seattle
- Increasing number of runways may be necessary, but often not sufficient



TIM 5/2002

4





## Example of Taxi Delay at DFW

### Arrivals on 18R

- exit at E3, E5, and E6
- often have to queue up on WL, WM, and B, three deep, prior to crossing 18L

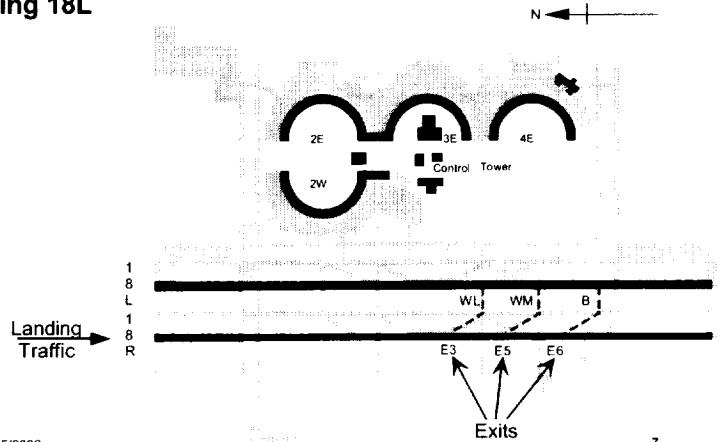

TIM 5/2002

7

## NAS OEP Solutions for Enhancing Efficiency

- **Mid-term (2002–2004)**
  - More efficient use of parallel and crossing runways (as well as more arrival runways in general) increases airport arrival/departure capacity
  - Coordinated management of surface movement at a larger number of airports increases efficiency of movement on airport surface in all weather
  - Improved runway configuration coordination between facilities and carriers reduces flow disruptions in the transition
- **Far-term (2005–2010)**
  - Surface navigation using cockpit display to augment visual data and provide common situational awareness improves robustness and efficiency
  - Enhanced surface management coordination increases efficiency of movement on airport surface in all weather
  - Improved runway configuration coordination between facilities and carriers across adjacent airports reduces flow disruptions in the transition

TIM 5/2002

8

## SOAR Concept

---

- **Advanced automation in Centralized Decision-making, Distributed Control (CDDC) paradigm**
- **Centralized Decision-Making: Automation for Ground Control**
  - Bases decisions on surveillance data, flight plans, and AOC requirements
  - Generates time-based taxi routes for optimum traffic efficiency
  - Existing prototype system: Ground-Operation Situation Awareness and Flow Efficiency (GO-SAFE)
- **Distributed Control: Automation for Flight Deck**
  - Executes time-controlled taxi routes
  - Provides auto-taxi capabilities or automation aids for pilots
  - Automation concept: Flight-deck Automation for Reliable Ground Operation (FARGO)
- **Integrated operation of both systems**

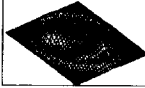

TIM 5/2002

9

## Desired Functions for Ground-Control Automation

---

- **User interface, including situational display for monitoring surface traffic, and alert of impending problems**
- **Taxi-route generation and editing**
- **Conflict detection and resolution**
- **Decision support tool for planning and adjusting taxi routes for delivering efficient and safe traffic**
- **Clearance manager for generating and processing advisories and clearances, and for monitoring the resulting progress**
- **Information exchange with relevant systems in the NAS infrastructure and other automation systems**



TIM 5/2002

10

## Overview of GO-SAFE GUI

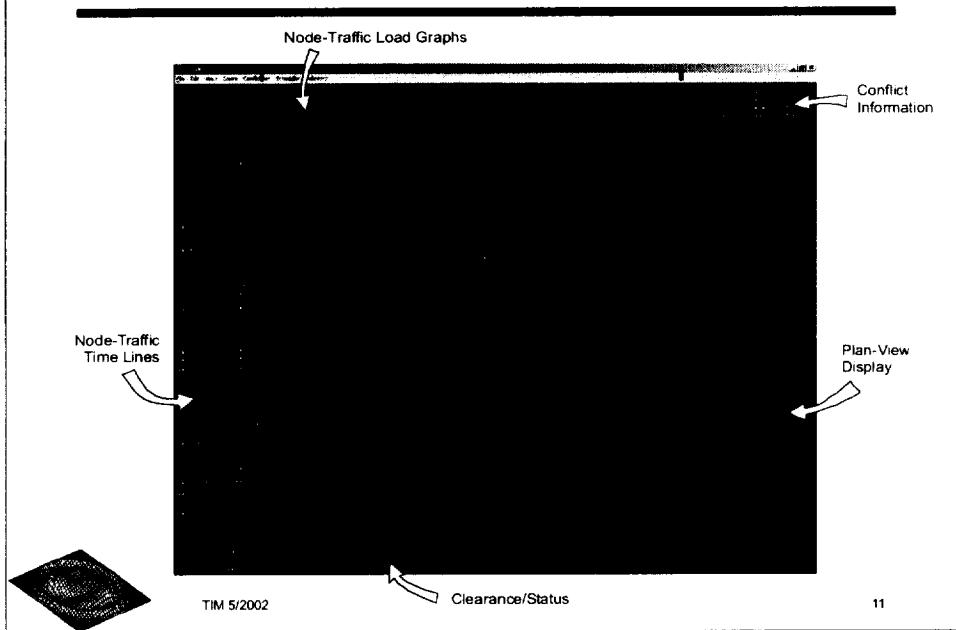

## Example of Route Editing by Changing Destination

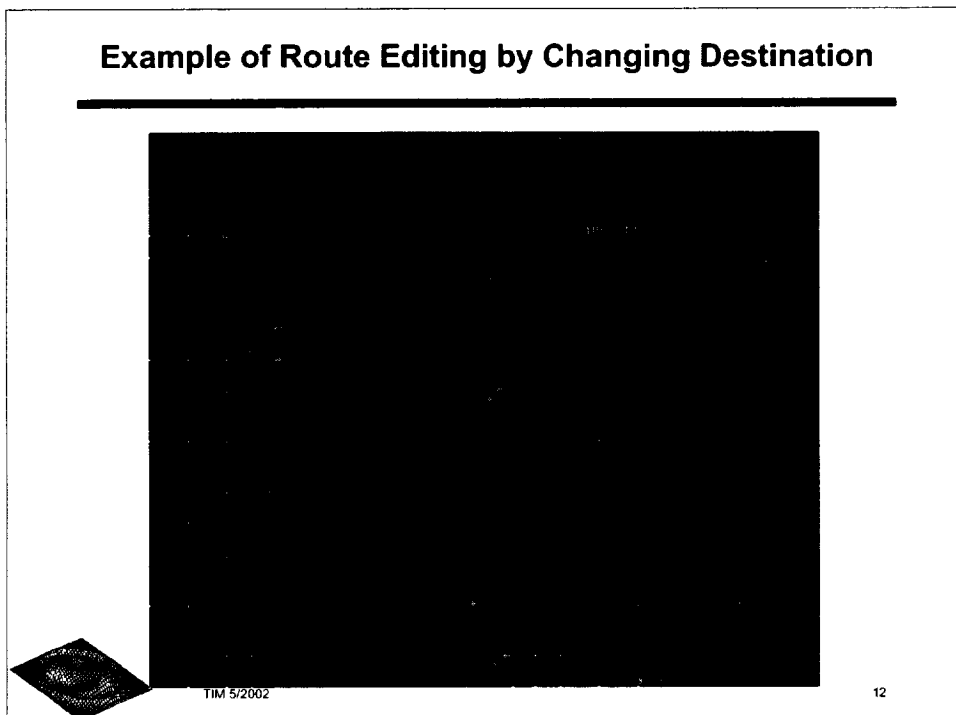

## Route Resulting from Dragging Destination Node

---

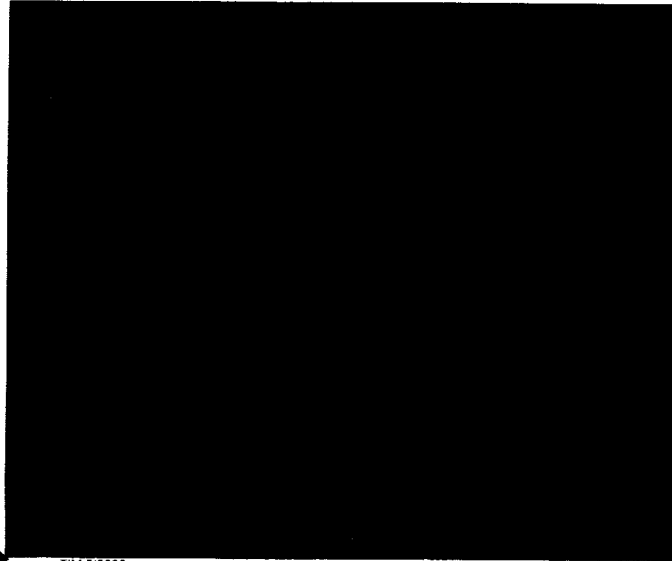

TIM 5/2002

13

## Example of Spatial Editing of Taxi Route

---

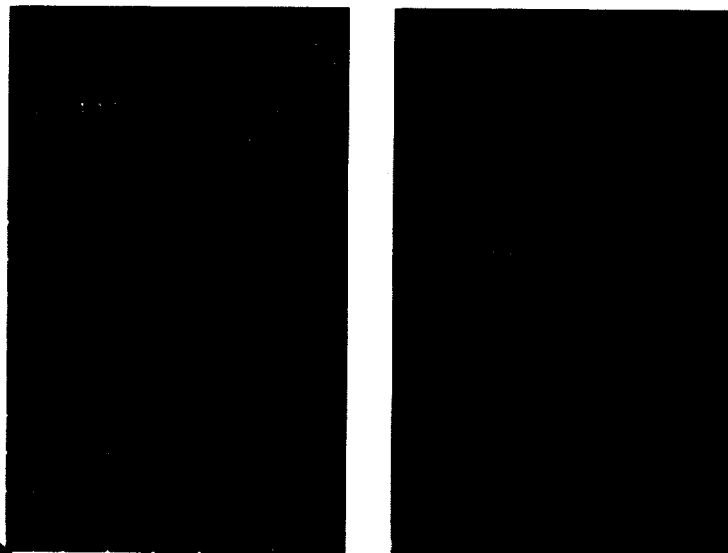

TIM 5/2002

14

## Example of Temporal Adjustment of Taxi Route

---

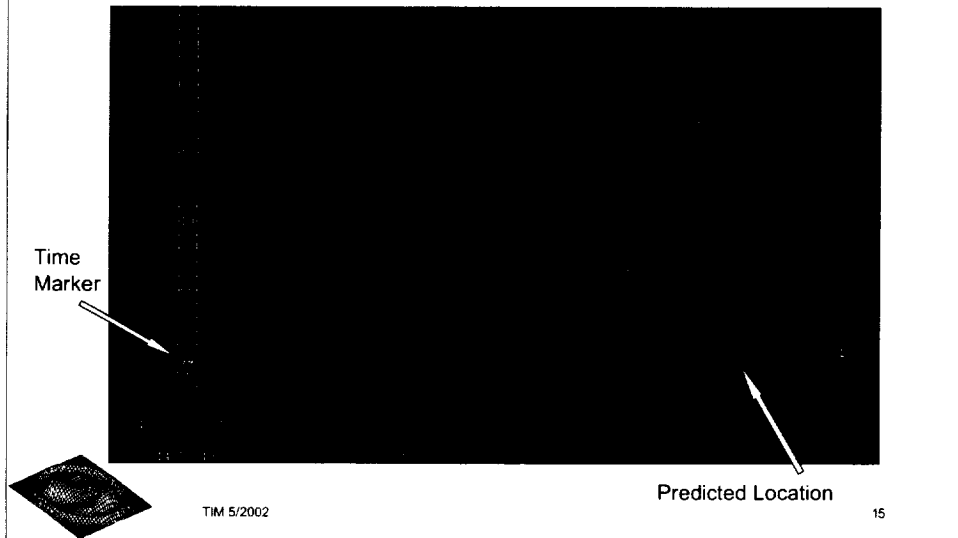

## Dragging Predicted Location to New Location

---

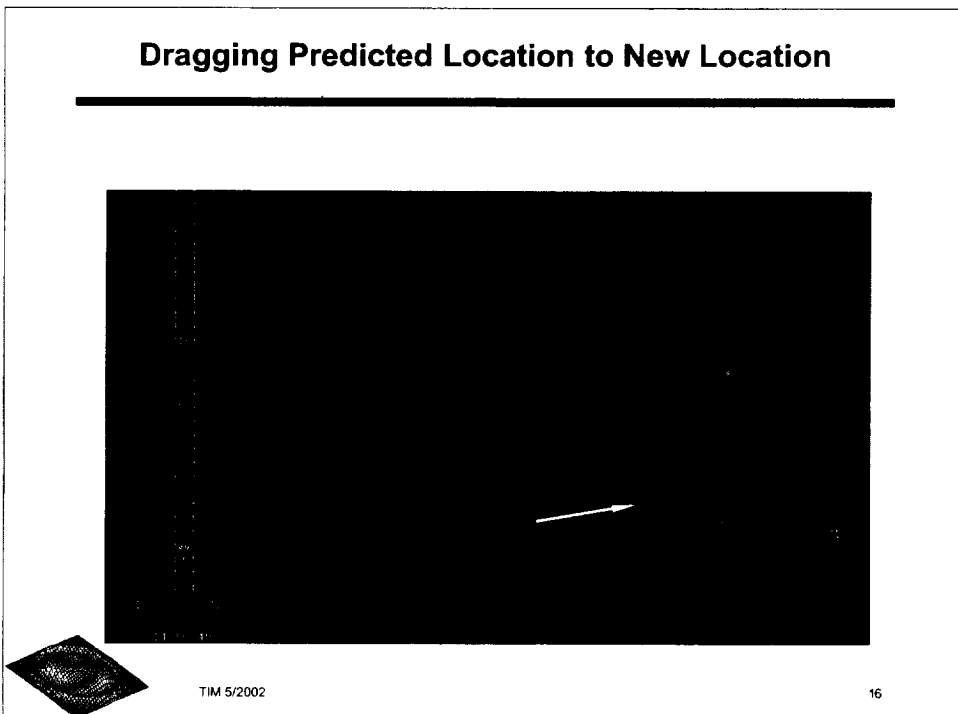

## Conflict Detection and Resolution

---

- Requirements for conflicts on airport surface not as serious as for IFR flights: in current operations, cockpit crew responsible for separation while taxiing
- Three general types of conflicts:
  - Node/intersection crossing
  - Overtaking
  - Head-on
- Node-crossing and overtaking conflicts appear only in GO-SAFE internal route computations, but are automatically resolved by crews in current operations.
- Head-on conflicts may lead to dead lock.
- Auto-taxi or high-workload taxi will require conflict-free clearances.

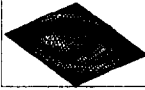

TIM 5/2002

17

## Decision Support System

---

- Core component for achieving efficient surface operations
- Schedule Manager
  - Calculates runway usage schedules for landing, takeoff and crossing traffic
  - Enables efficient active-runway crossing
  - Landing traffic has priority
  - Allows simultaneous runway occupancy under special conditions
- Challenge: Other decision-support functions to optimize efficiency of traffic over whole surface traffic



TIM 5/2002

18



## Desired Functions for Flight-Deck Automation

---

- **Auto-taxi function for precisely controlling the aircraft taxi to accomplish the taxi clearance with tight control margins**
- **Pilot interface to allow the pilots to perform precision-taxi**
  - Far-term: fully automatic taxi
  - Near-term: control signals generated by the auto-taxi function to direct manual control
- **Previous research established potential of high-precision aircraft taxi control for improving traffic efficiency:**
  - High-precision taxi operations are achievable with advanced guidance and control.
  - Potential benefits of automation can be sustained under manual control with effective pilot interfaces.

V. H. L. Cheng, V. Sharma, and D. C. Foyle, "A Study of Aircraft Taxi Performance for Enhancing Airport Surface Traffic Control," *IEEE Transactions on Intelligent Transportation Systems*, Vol. 2, No. 2, pp. 39-54, June 2001.



TIM 5/2002

21

## Pilot Interface Considerations

---

- **Landing, roll out, and turn off require deceleration followed by continuous taxi**
- **Traditional flight director concept**
  - Speed bug unsuitable for deceleration control during roll out
- **Other options**
  - Braking cue + Throttle/Speed cue
  - RTA at key locations, e.g. holding lines
- **Issues**
  - Mode awareness problems: switching from deceleration to constant-speed taxi
  - Discrete adjustments of brakes and throttle
- **Challenge: Future research particularly important for developing automation-assisted system for manual control**



TIM 5/2002

22



## Operational Integration of Automation Systems

- **Complex taxi routes with time constraints necessitate data-link clearances.**
- **Challenges:**
  - **Controllers cannot expect immediate acknowledgement.**
  - **Cockpit crew may be distracted from flight control**
    - **Reading clearances**
    - **Understanding details**
    - **Responding via console input**
  - **Near-term application of the technologies required different approaches.**
- **Route information can be more easily entered into FMS.**



TIM 5/2002

23

## SOAR Top-Level Model Relative to GFI Model

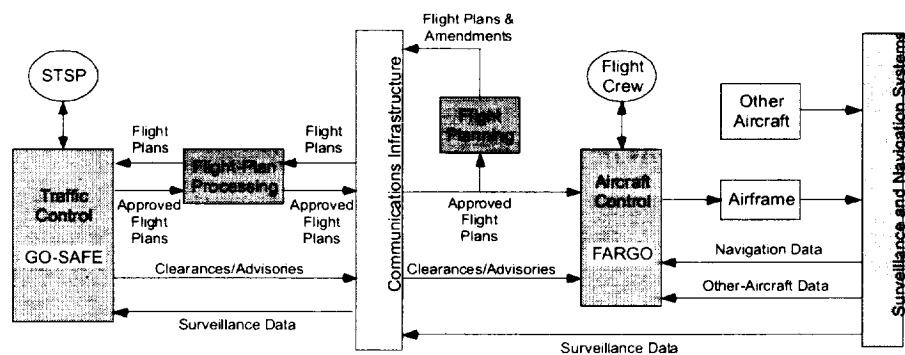

TIM 5/2002

24

## Remarks on Evaluation Metrics

---

- **Capacity:** Number of flights serviced in given time period
- **Efficiency:** Taxi time, delay
- **Workload:** Controller, Cockpit Crew
- **Safety:** Probability of incidents, not necessarily based on overly conservative separation requirements

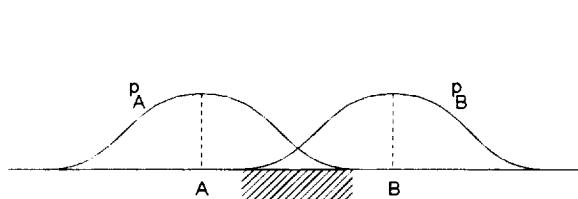

Imprecise control with large mean separation

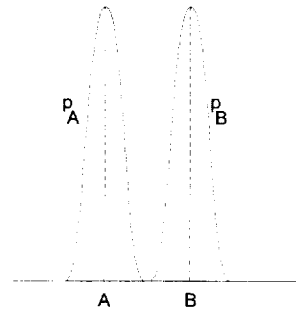

Precise control with small mean separation



TIM 5/2002

25

---

THIS PAGE INTENTIONALLY LEFT BLANK



TIM 5/2002

© 1986-2002 Victor Cheng

26



---

# Centralized Terminal Operation Control (CTOC) Concept

Capacity Increasing Concept TIM  
NASA Ames Research Center  
May 21-23, 2002

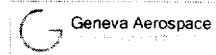

## Overview

---

- ◆ Operating Domains
- ◆ Current Terminal Issues
- ◆ CTOC Concept
- ◆ CTOC Core Ideas
- ◆ CTOC Benefits/Metrics
- ◆ CTOC Challenges
- ◆ Summary

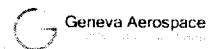



## Operating Domains

(Definitions from NASA NRA Solicitation, Appendix G)

### En Route

Concepts dealing with planning and implementation of aircraft paths between takeoff and landing. This includes creating more flexible aircraft paths, conflict detection and resolution, communication of environment and traffic data to aircraft and ground, traffic monitoring, more accurate navigation methods, and prediction of traffic conditions.

### System Level

Concepts dealing with all aspects of operations and management of the NAS.

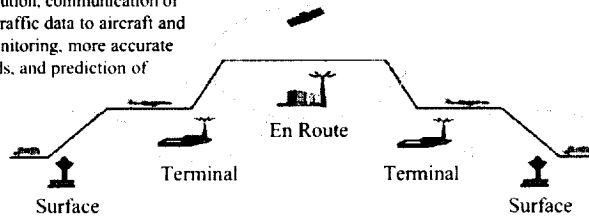

### Terminal

Concepts dealing with planning and implementation of departures and arrivals. This includes predicting and implementing runway allocations for takeoff and landing, dissemination of environmental data to ease planning, and methods to increase navigation accuracy for better flow management.

### Surface

Concepts dealing with planning and implementation of airport surface traffic. This includes planning and monitoring of airport traffic, intra airport environmental data and aircraft state data as pertains to airport traffic.

**NORTHROP GRUMMAN**  
Information Technology

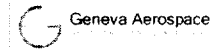

3



## Current Terminal Issues (1 of 2)

- ◆ Underutilization of the Terminal airspace
  - ❖ Variability in threshold separations above legal minimum separations
  - ❖ Variability in pilots reaction to controller directives
  - ❖ Transfer of control introduces additional space and variability
- ◆ Additional spacing required for Instrument approaches
  - ❖ When conditions prohibit visual approaches (fog, low clouds, sunset, etc.) extra spacing is required for aircraft on final approach
- ◆ Inefficient communications between controllers and pilots
  - ❖ Communication errors cause extra spacing or in some cases, safety hazards
  - ❖ Problem exacerbated for pilots whose native language is not English
  - ❖ Variability in the delay between the issuance of a command and the response to the command

**NORTHROP GRUMMAN**  
Information Technology

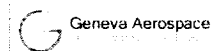

4

## **VIVIS** Current Terminal Issues (2 of 2)

---

- ◆ Controllers are able to identify but not prevent unauthorized use of airspace
  - ❖ As witnessed recently, controllers are able to recognize when an aircraft is not responding to control directives, but they are unable to affect control of the aircraft
- ◆ Special procedures are necessary for varying aircraft performances
  - ❖ Aircraft may not be available or capable of mixing into a stream of other aircraft
  - ❖ Special handling of these aircraft impacts efficiency of controller and the operations of other aircraft in the area

## **VIVIS** CTOC Concept

---

- ◆ The Centralized Terminal Operation Control (CTOC) concept is analogous to the Maritime Industry's Harbor Pilot
- ◆ CTOC provides remote control of aircraft in the Terminal domain
- ◆ CTOC merges the role of the controller and flight crews
- ◆ CTOC will interface to DSTs and/or enhanced ATM systems in the Enroute, Terminal, and Surface environments to ensure predictable, consistent, conflict-free trajectories
- ◆ CTOC depends on aircraft technologies (i.e. datalink and FMS) for response to Flight Control Commands and Trajectories from the Remote Controller



# CTOC Concept

Modified GFI Top-Level Model of ATM Functions

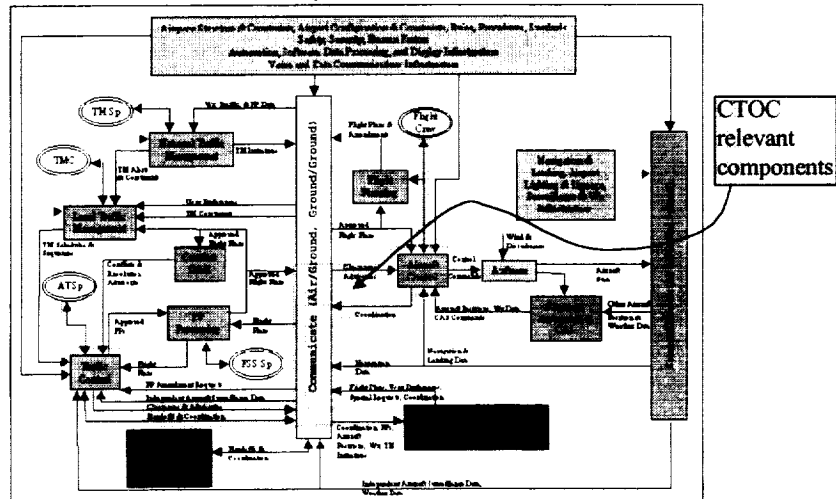

# CTOC Core Ideas

- ◆ Remote control of one or multiple aircraft from a single terminal specialist supported by a ground-based computer system
- ◆ Remote control will extend existing automation in the terminal domain and reduce variability in separation
- ◆ Flight control commands based on deconflicted trajectories will be sent from CTOC to the aircraft FMS
- ◆ Remote control of terminal aircraft may be adjusted based on Air Traffic Management flow constraints
- ◆ Terminal specialists will have the capability to take control of aircraft to prevent unauthorized use
- ◆ Pilots will have the ability to override CTOC commands for safety reasons only

## VMS CTOC Benefits/Metrics

Benefit	Mechanism	Candidate Metric(s)
Increased Capacity	Control to predictable and consistent trajectories in Terminal area	Flow Rates, Arrival Delay, Departure Delay, Overall Delay, Time/Distance Flown
	Reduce runway occupancy	Runway Occupancy Time
	Arrivals and departures make better use of Terminal airspace	Flow Rates, Arrival Delay, Departure Delay, Overall Delay, Time/Distance Flown, Tracks
Increased Efficiency	Reduce variability in separation for aircraft-to-aircraft, aircraft-to-obstruction, and aircraft-to-airspace	Separation Distances, Conflicts
	Eliminate missed approaches due to verbal communication errors	Missed Approach Count
	Control to predictable and consistent trajectories in Terminal area	Tracks, Workload
Increased Safety	Improve situational awareness between Terminal ATC and airline users	Workload
	Eliminate missed approaches due to verbal communication errors	Missed Approach Count
	Collaborative arrival/departure management with airlines	Workload
	Reduce workload for Terminal area ATC and flight crews	Workload
	Provide communication between CTOC and FMS through data link	Comm Load, Workload
Reduced Costs	Improve situational awareness between Terminal ATC and airline users	Safety Incident Count
	Provide communication between CTOC and FMS through data link	Comm Load
	Provide trajectory conformance monitoring	Separation Distances, Conflicts, Workload
	Provide flight deck override to CTOC	Safety Incident Count
	Provide ATC override for case of unauthorized use of Terminal airspace	Unauthorized Use of Airspace Count
	Terminal area operating costs	Operating Costs, Staffing Levels

## VMS CTOC Challenges

- ◆ Acceptance
  - ❖ ATC, Flight Crews, and Public
- ◆ Human Factors
- ◆ Legal impact of change in roles and responsibilities
- ◆ Procedures for transfer of control
- ◆ Overrides
- ◆ Presence of Mixed Equipage



## Summary

---

- ◆ CTOC is analogous to the role of a harbor pilot
- ◆ CTOC introduces multi-vehicle remote control by a single specialist in the Terminal domain
- ◆ CTOC increases Terminal domain capacity
- ◆ CTOC improves Terminal domain safety and efficiency
- ◆ CTOC reduces pilot-controller workload



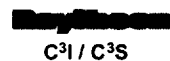

C<sup>3</sup>I / C<sup>3</sup>S

---

***TACEC***  
***Terminal Area Capacity Enhancement Concept***

**Advanced ATM Concept for 2020**

**prepared for**  
**VAMS Technical Interchange Meeting #1**  
**NASA Ames Research Center**  
**21-23 May 2002**



**Terminal Area  
Operating Domain**

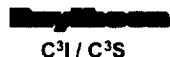

C<sup>3</sup>I / C<sup>3</sup>S

- 
- The Terminal Area is defined as airspace surrounding an airport or airport group (similar to today's TRACON) as well as the airport surface (runway, taxiway and ramp). In addition the Terminal Area includes gate and street side operations.
  - For comparison purposes the Terminal Area is similar to the environment addressed in the FAA's Operational Evolution Plan for Arrival and Departure Rate



### Problem

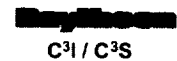

C<sup>3</sup>I / C<sup>3</sup>S

#### *Dramatically increase operational capacity*

- Today's NAS is operating at or near capacity
- FAA OEP predicts a 24% total growth in air traffic by 2010
- VAMS predicts a 4.5% growth per year through 2020

**Benchmark Airport Operations**

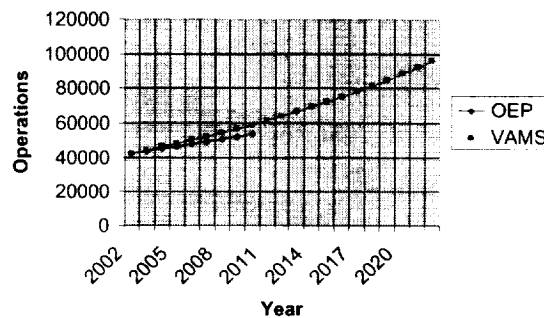

	2010	2022
OEP	54,000	-
VAMS	59,000	96,000



### Challenges

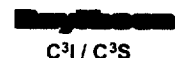

C<sup>3</sup>I / C<sup>3</sup>S

#### *Increase capacity using new technology and operations*

- Majority of FAA's OEP envisioned capacity growth comes from building new runways.
- Continued construction beyond 2010 is not envisioned
- Assuming similar regional operations in the future the 13 busiest airports today will see the majority of growth in 2020.

AIRPORT TODAY	OPS per HR		
	OEP/2010	VAMS/2020	
ATL	185	237	426
ORD	200	236	460
DFW	261	316	600
LAX	148	185	340
DTW	143	187	329
PHX	101	132	232
MSP	115	152	265
LAS	84	109	193
MIA	124	153	285
DEN	204	251	469
CVG	123	172	283
BOS	118	125	271
STL	104	135	239



## Increased capacity and operational requirements

**Raytheon**  
C<sup>3</sup>I / C<sup>3</sup>S

***Doubling OPS/Hr means twice as many aircraft in the airspace, on the runway, and at the gates....***

- Separation requirements between aircraft within the terminal airspace must be reduced by up to a factor of 2.
- Final approach and departures must be conducted at twice the rate achieved by any OEP improvements envisioned.
- Surface traffic must be increased by a factor of two and runway occupancy time reduced.
- Gate operations must double, either by increasing their number or halving their occupancy.



## TACEC is an Evolutionary Approach

**Raytheon**  
C<sup>3</sup>I / C<sup>3</sup>S

- **Technology exists today to significantly reduce separation**
  - Train, demonstrate, validate and instill confidence necessary over the next 20 years
    - » Integrate “intent” with current position to reduce uncertainty
    - » Distribute the separation responsibility between air and ground
- **Operational algorithms using today’s computational power can plan, schedule, and communicate ATC operations today**
  - Over the next 20 years more sophisticated algorithms and “super” processors can deal with the large number of ATC OPS factors required.....but confidence in these results must be developed.
    - » Establish proper parameters via research
      - Wake Vortex
      - Weather
      - Runway Occupancy Time
      - etc
    - » Optimize the human elements role and responsibility
    - » Provide NAS wide fault monitoring of all system elements



- **Issues to deal with**
  - Aircraft equipage
  - Ground side constraints
    - » road access
    - » noise
    - » emissions
    - » parking
    - » security
  - Human factors
  - Confidence in technology
  - Safety
  - Culture/folklore
- **Stakeholder Issues**
  - National Policy (DOT, FAA, Government)
  - Funding authority
  - Airlines, aircraft owners
  - Aircraft manufacturers
  - DOD/USAF
  - Pilots & controllers
  - Operations and Maintenance
  - Gate/Ramp management
  - Airport management



- Increasing capacity in the Terminal Area relies on following key elements:**
- **Accurate 4D Trajectory Calculation**
  - **Aircraft execution of required trajectories**
  - **Highly reliable and secure data link**
  - **Reduced separation standards**
  - **Improved surveillance**
    - WAAS enhanced GPS
    - Multi-sensor surface surveillance fusion
    - Mode S MSSR
  - **Airborne self separation**
  - **Complex finals - curvilinear, multi-aircraft formations landings**
  - **Optimized taxi routing**
  - **Integrated Terminal Area information network (all stakeholders)**

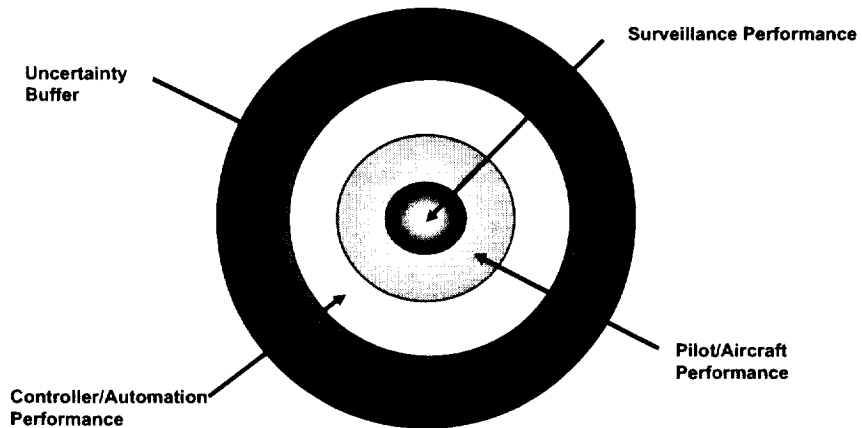
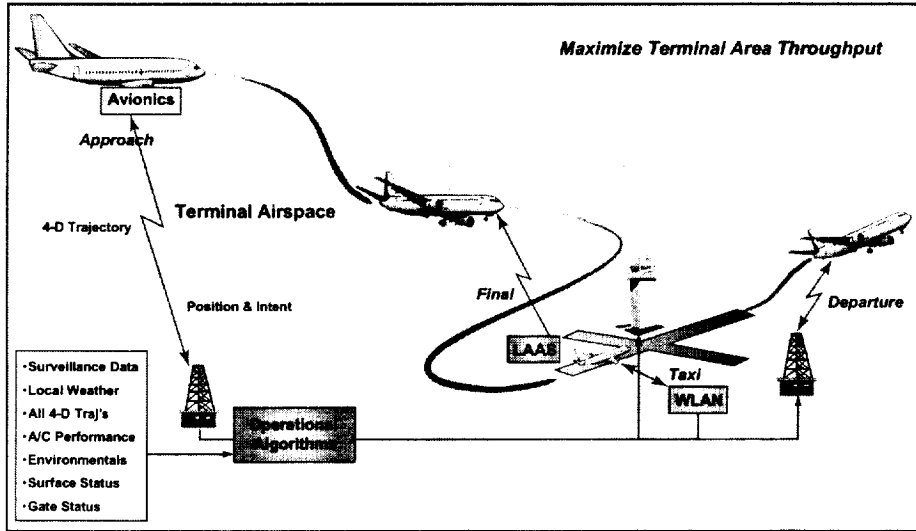



- **The most effective solutions will come from the proper blend of automation and human decision making.**
- **Human involvement is critical because:**
  - **Humans are better than automation at higher-order tasks such as complex pattern recognition, avoiding false alarms, generating imaginative solutions to difficult problems, and handling unique/exceptional situations**
  - **Humans must ensure proper response to non-normal situations**
- **Automation will augment human abilities**
  - **Automation can compensate for human limitations of attention and memory capacity (e.g., humans can only monitor and interact with a very limited number of aircraft simultaneously)**
  - **Cognitive-based visualizations can enhance situation awareness and management in a fusion with automation and what-if tools.**

11



- **Re-define the role of the Human in the system**
  - **Identify proper roles for all human activities in TACEC**
  - **Identify tools required to support and conduct role**
- **Primary objective of system solution is to maintain controller and flight crew situational awareness and responsiveness, in an automation environment.**
- **Establish pilot/controller commitment to the “situation” established by the 4D Trajectory calculation.**
- **First principle includes shared separation responsibility, appropriately between ground manager and flight crew.**

12

### Today's Division

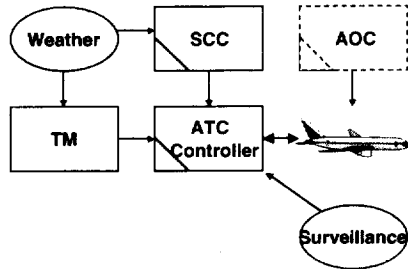

Management  
  Control  
  Information

### TACEC Division

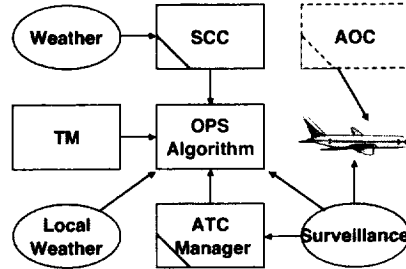

Management  
  Control  
  Information

13

- Rapid reacquisition of situational awareness will be a key problem in future ATM. While automation frees up humans to perform multiple tasks, there is a cost of switching between tasks.
- Situational awareness is disrupted by many factors (e.g., relying on automation or task switching) and takes too much time to reestablish.
- Cognitive-based visualizations will allow humans to rapidly acquire SA when:
  - Maximizing TRACON throughput
  - Responding to unexpected situations
  - Preserving safety during non-normal events

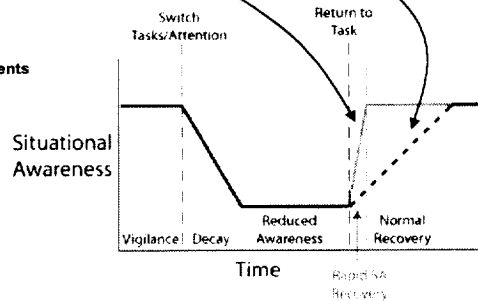

### Enhanced visual displays for sequencing approach (or departure) aircraft

#### Sequencing Schematic for approach sequencing

A sequencing ring is assigned to each aircraft

Each ring maintains safe separation & max throughput for all planes

Rings contract over time to sequence planes for landing

Colors denote ring status

Planes can enter from many fixes

A side view

#### Concept Display for 50 incoming planes

A top-down view

Regions can scale/zoom

Boxes correspond to rings

A linear representation of the same display

A 3D representation of the same rings (looking up at it)

#### Benefits

- Planes can be sequenced from multiple fixes, allowing for more throughput
- Allows managers to collectively monitor more planes; they track spatial patterns instead of each plane
- Increases the long-range info about time & space, so manager does not have to control individual aircraft
- Important areas can be isolated using scalable/zoomable displays
- Similar displays can also be developed as a tactical display for pilots

15

### A visualization concept that using visual metaphors to manage flight schedules in time-space

#### Future weather system evolving in time-space

Flight paths initially all safe

T=0    +1    +2    +3    +4

Present: Schedules Optimal (all lines horizontal & vertical)

Future: Off-Schedule

Potential conflict

#### Benefits

- Provides quick detection of deviations from normal operation
- Flow abnormalities "pop-out" as crooked lines
- Makes obvious a potentially dangerous schedule (crossing lines are visually salient)
- Allow operators to see and manage complex evolving situations and explore what-if solutions.

16



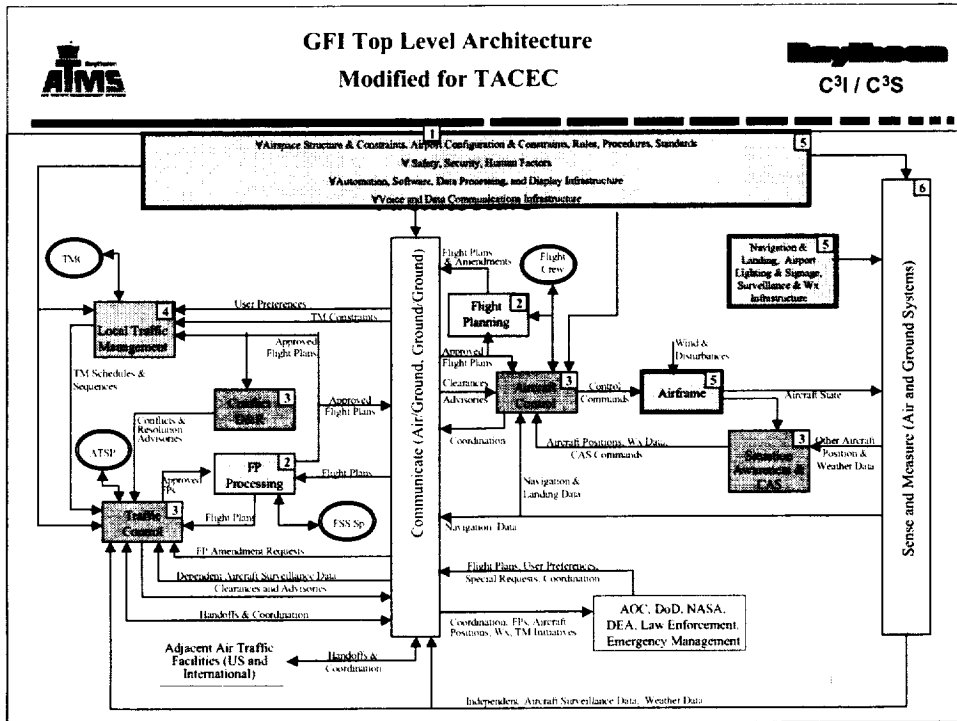

### TACEC and the GFI Model

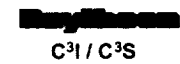
C3I / C3S

ATM Function (From the GFI Top Level Model)	Function per Concept Description
<b>Local Traffic Mgmt</b>	Participate in optimized flight planning using situational awareness and assessment tools. Specialized focus provided by "drill down" capability within automation.
<b>Adjacent Air Traffic Facilities (US and International)</b>	Share in situational awareness via linked displays.
<b>Traffic Control</b>	Terminal & Ground controllers provide primarily monitoring activities utilizing new Situational Awareness tools. Concur on Trajectory updates, participate in real time awareness activities to insure rapid response to abnormal conditions.
<b>FP Processing</b>	Now 4-D Trajectories - Automated for optimal routing, updates in real time, datalinked to a/c.
<b>Flight Planning</b>	Now 4-D Trajectories - Automated for optimal routing, collaborative process with all parties.
<b>Clearance</b>	Integral with 4-D Trajectory determination utilizing high accuracy surveillance and onboard (FMS) intent capability.

18



## TACEC and the GFI Model

**Raytheon**  
C<sup>3</sup>I / C<sup>3</sup>S

ATM Function (From the GFI Top Level Model)	Function per Concept Description
	FMS driven auto-flight, all phases of operation within the terminal area.
	Accommodate operational realities, flight path control meets required intent precision.
	Revised designs focus on current and future airspace situation. Embedded training provides minimal response time to abnormal situations ... both Ground and Cockpit capabilities.
	ADS-B using WAAS corrected position reporting primary surveillance tool. Mode S SSR is back-up source. Surface surveillance uses Multisensor Fusion (ASDE, ADS-B, et al)
	Collaborative Decision Making framework. Interchange of situation data based on a "need to know" criteria. Specific authorizations required when flight planning changes are issued, priorities communicated, and emergency procedures addressed.
	Integrated via Terminal Area Operations network with Operational algorithms and inter-facility linkage.

19



## Safety

**Raytheon**  
C<sup>3</sup>I / C<sup>3</sup>S

- **Failsafe Operational capabilities**
  - All major elements of the TACEC solution must be redundant
    - » Dual data link
    - » Dual Surveillance systems
    - » Dual Automation systems
  - Dual, independent trajectory calculations
    - » Approach, departure, landing and taxi trajectories use both current position and future intent data.
    - » Independent truth data (sensors), processors, and algorithms.
- **Robust Separation Assurance**
  - WAAS/LAAS accuracy, integrity, and reliability insures current and future position knowledge
  - Reaction times can be reduced based on improved intent information, automated control loops (aircraft/ground) and optimized information flow

20



## Benefits Assessment

**Raytheon**  
C<sup>3</sup>I / C<sup>3</sup>S

- 
- **Primary benefits derived from increased Terminal Area capacity**
    - Increased revenues
    - Safer operation
    - Passenger comfort
  
  - **Secondary benefits include;**
    - reduced operations costs
    - increased schedule reliability
    - enhanced ATM system reliability
    - excess capacity to absorb uncontrollable disruptions

# NASA Langley Research Center Wake Vortex Research Supporting VAMS

22 May 2002

David Rutishauser  
Crew Systems and Operations Branch  
NASA Langley Research Center MS 156A  
Hampton, VA 23681-2199  
(757) 864-8696  
d.k.rutishauser@larc.nasa.gov



## Background: NASA Aircraft VORtex Spacing System (AVOSS)

- Goal:
  - Demonstrate an integration of technologies to provide weather-dependent, dynamic aircraft spacing for wake avoidance
  - Operate real-time in a relevant environment
- System demonstrated at Dallas Fort-Worth Airport in July 2000; Represented the culmination of six years of field testing, data collection, and development

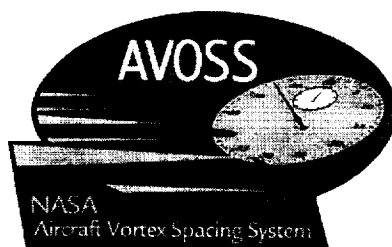

## The Wake Vortex Issue

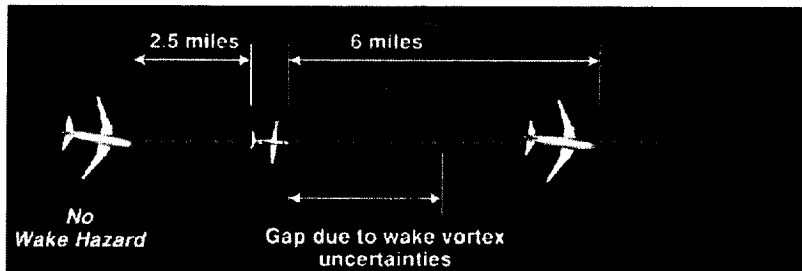

Following Aircraft Gap, (nm)	Lead Aircraft			
	Small	Large	B757	Heavy
Small	2.5	4	5	6
Large	2.5	2.5	4	5
Heavy	2.5	2.5	4	4

- US Minimum spacing when operating under IFR (Gap in nm)
- 757 special case as a lead aircraft
- Small  $\leq 41,000$  lbs,  $41,000$  lbs  $<$  Large  $\leq 255,000$  lbs, Heavy  $> 255,000$  lbs



## AVOSS Corridor

- Separate aircraft from wake vortex encounters:
  - Define a corridor of protected airspace
  - Windows co-locate predictions and sensor measurements
  - Predict wake motion and decay at all windows for all aircraft
  - Provide safe separation criteria for the entire approach
  - Monitor safety with wake vortex sensor

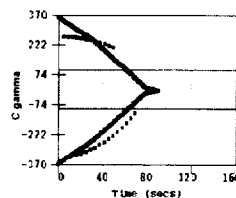
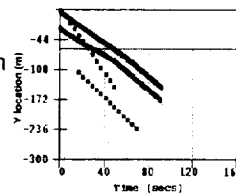
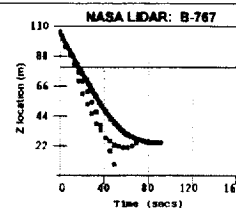
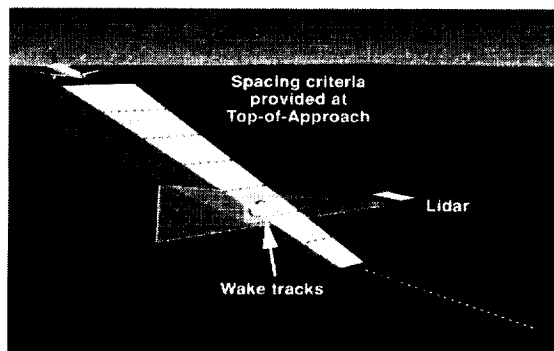

Solid lines Predictions  
 Dotted lines Measured  
 Red (bottom curves) Left wake  
 Black (top curves) Right wake  
 Wake no longer a factor in gray area

## AVOSS DFW Research Results

- Calculated maximum IFR throughput increase
  - Averaged 6%
  - Ranged from 0% to 16%
  - Maximum theoretical gain ~16%
    - 50 second Runway Occupancy Time (ROT)
- From 2301 wake comparisons:
  - 61% of all wakes exited corridor in less than the ROT
    - Transported away by crosswind
    - Sank below the corridor
    - Dissipated (circulation below 90 M<sup>2</sup>/sec)
  - 31% Separation reduced with no measurements exceeding predictions
  - 8% the wake observations exceeded the prediction bounds
    - Caused by variances either in weather estimation, wake prediction, or wake sensing, not necessarily a safety concern
    - 7% of the 8% determined to not be operationally significant



## Products of the AVOSS Program

- AVOSS effort represented the most comprehensive wake and weather data collection effort to date
  - Over 10,000 wakes measured with relevant ambient weather parameters captured
  - Measurements collected at three locations over the course of six years
- AVOSS provided platform for subsystem development & integration
  - Major progress made in wake modeling and sensing
  - Weather subsystems were integrated in new ways and data fusing algorithms were developed
- Demonstration of concept for system integration
  - Example guides future operational concept development



## AVOSS Weather Subsystems

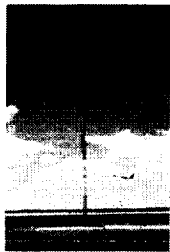

Tower

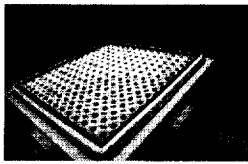

Sodar



Radar Profiler w/ Radio Acoustic Sounding System

Integrated Terminal Weather System Products

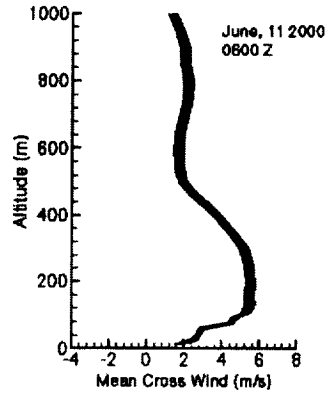

## Wake Sensors Evaluated – Pulsed Lidar

NASA Lidar

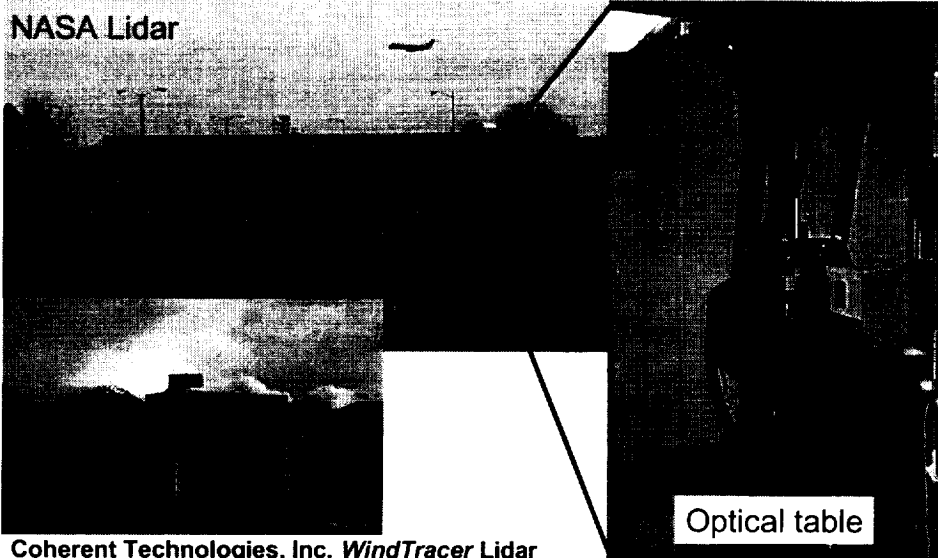

Coherent Technologies, Inc. *WindTracer* Lidar

Optical table

## Wake Sensors Evaluated - Continuous Wave Lidar

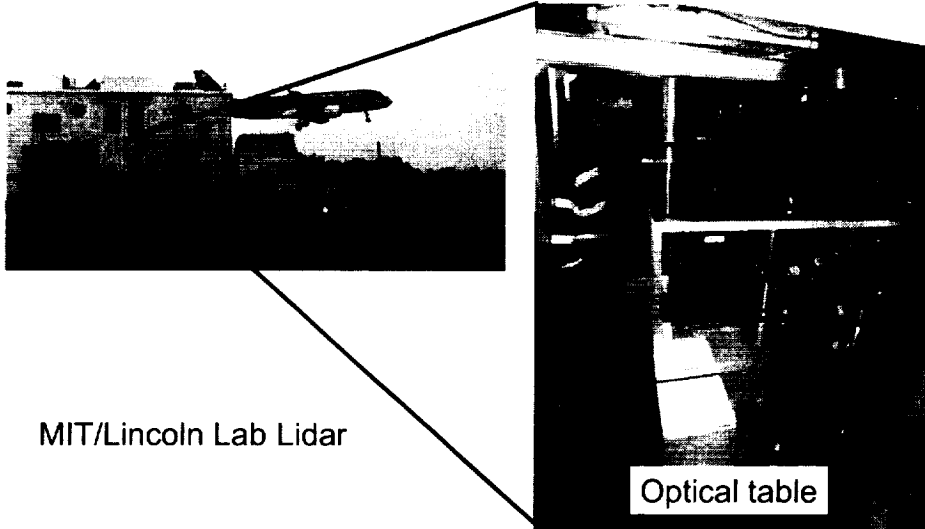

## Wake Sensors Evaluated - Windline

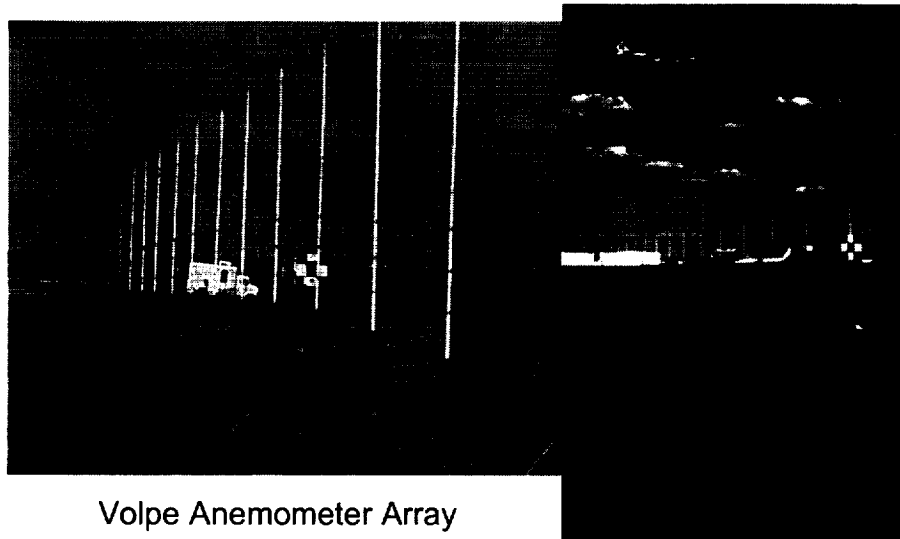



## AVOSS Technologies Applicable to all Terminal Operations



Inline Approaches



Departures

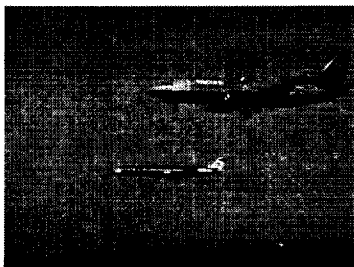

Parallel Runway Approaches



Intersecting Runways

## AVOSS Follow-on Work Requirements Support VAMS Vision

- Much work needs to be done in defining operational concepts that apply AVOSS products to the wake problem
- Concepts must be analyzed for costs, benefits, and impacts
- Analysis requires high-fidelity technology models and concept simulation capability
- Concept development method must be conducive to defining a roadmap to implementation



## NASA LaRC VAMS Plans

- VAMS work executed by two LaRC organizations, the Airborne Systems Competency (AirSC) and the Aerospace Systems Concepts and Analysis Competency (ASCAC)
- Work focus is on Wake Vortex Avoidance System (WakeVAS) concept development and the modeling that supports the development
- Technology models designed to be compatible with FAA's terminal procedure simulator, providing a clear roadmap to operation
- Technology models developed at LaRC could be used in larger NAS simulations developed at ARC



## FY2002 VAMS Tasks

- AirSC provides WakeVAS technology and concept models and parameters to ASAC for integration into an airspace simulation
  - Develop an in-house technology simulation capability that parallels the FAA Airspace Simulation and Analysis for TERPS tool
  - Continue evaluation of existing data for WakeVAS subsystem characterization and evaluation
  - Continue enhancements to wake behavior models
    - Improvements to analytical models
    - Development of wake probabilistic models
- Operational Concept development (in-house and solicited)



## FY2003 and Beyond

- Continue technology model development, targeting larger, more comprehensive NAS simulations as they are developed
- Continue Operational Concept Development
- Refine technology models and concept designs with the results of ongoing research
- Keep potential paths to concept and/or technology implementation open by maintaining consistency and synergy with FAA/NASA Wake Vortex Research Plan



## WakeVAS Concept Models

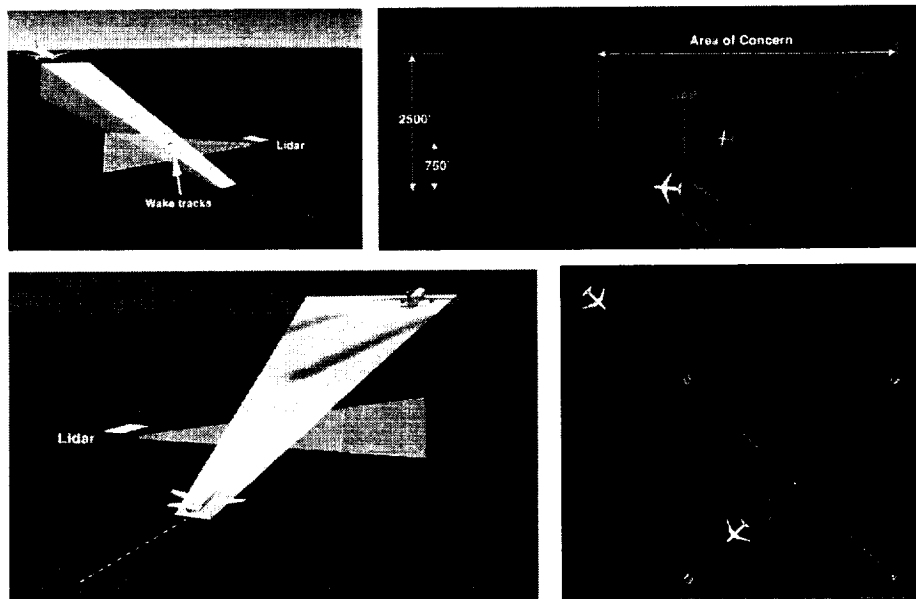

## Advanced Airspace Concept

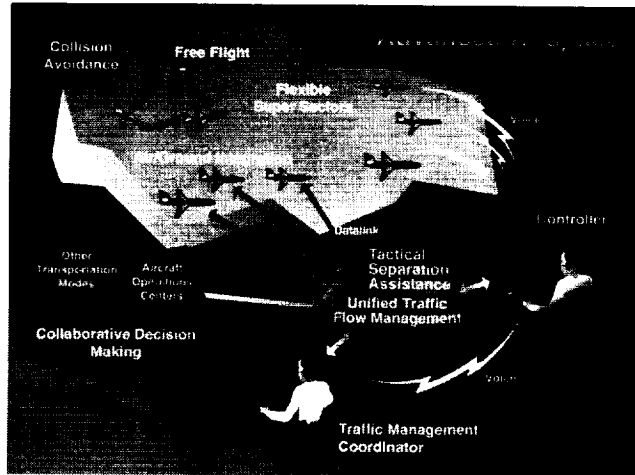

Presented at VAMS TIM

By

Heinz Erzberger

Senior Scientist, Ames Research Center

## Overview

- Limitations of the existing system
- The Advanced Airspace Concept
- Candidate architecture for the AAC
- Separation assurance and conflict avoidance system (TSAFE)
- Ground-Air Interactions

## Limitations of the Current Paradigm

- Controller workload limits growth in sector capacity and throughput.
- Capacity gains through resectorization and sector size reduction have reached the point of diminishing returns.
- Decision Support Tools provide some improvements but can't circumvent basic controller workload limits.
- Manual monitoring and control of separations is subject to human error ( FAA reports 50% jump in operational errors in 2000).

## Cloning Method for Estimating En Route Airspace Capacity Potential

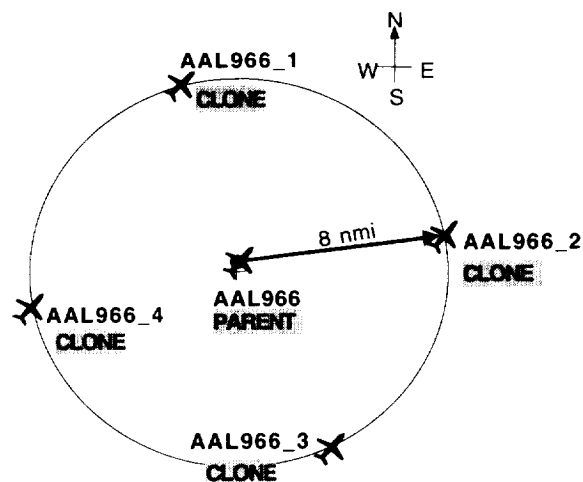

## Results of Cloning Experiments

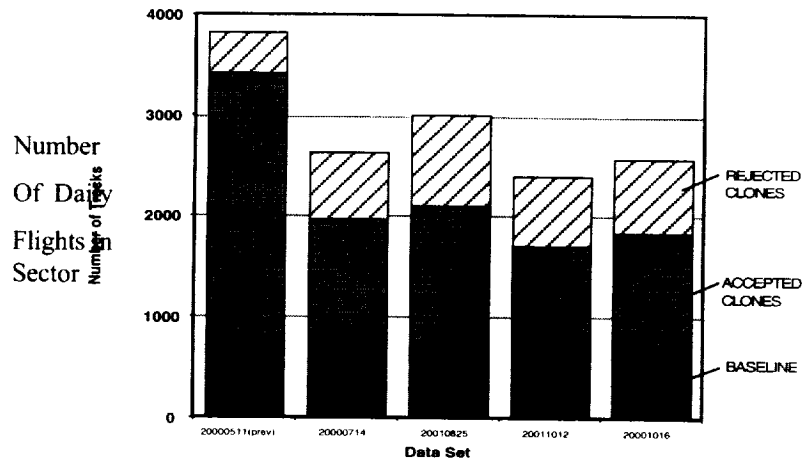

**Advanced Airspace Concept has potential to more than double base line capacity**

## Overview of Advanced Airspace Concept

- Ground-based system generates 4D trajectories and separation assurance advisories for equipped aircraft
- Pilots, with the aid of Flight Management Systems, fly trajectories and advisories, which are sent to aircraft via data link.
- Ground and on-board systems help pilots maintain separation and safe operation in the event of certain types of failures
- Advanced Airspace sectors consist of several conventional sectors combined into super-sectors
- Voice communications between controller and pilots are available to handle unequipped aircraft, special pilot request, emergencies, loss of data link, etc.

## Design Guidelines

- Utilize existing and planned infrastructure and operational systems
  - Mode S, ADS-B, GPS, Advanced FMS, Decision Support Tools, Data Link
- Keep on-board equipment requirements to a minimum
  - Data link and cockpit traffic display are essential
  - FMS highly desirable
- Provide safety net for specified failures
- Allow for transition from current operations to Advanced Airspace operations

## Advanced Airspace Architecture

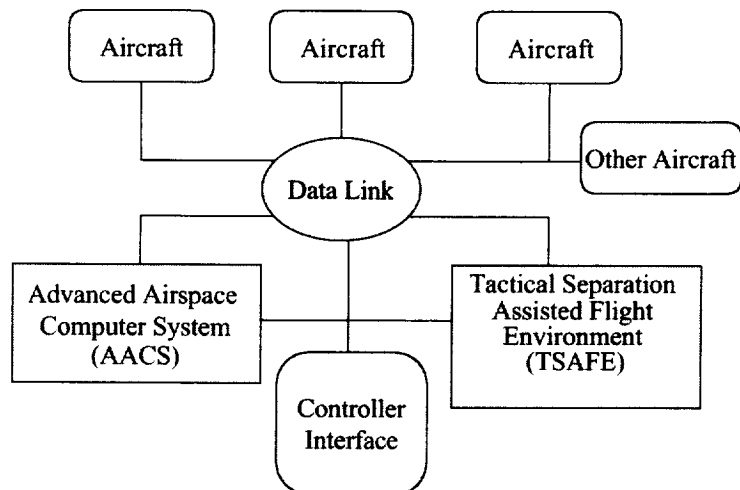

## Why TSAFE is Needed

- AACS is designed to solve a defined set of problems; however, its regions of solvable and unsolvable problems are indeterminate.
- Complexity of AACS software makes it difficult to establish its capabilities in providing tactical separation assurance.
- A separate system, TSAFE, whose main purpose is to provide tactical separation assurance, is less complex to design and easier to validate
- TSAFE uses knowledge of intent to warn against loss of separation
- The airborne collision avoidance system, TCAS, protects against collisions without knowledge of intent

## TSAFE Architecture

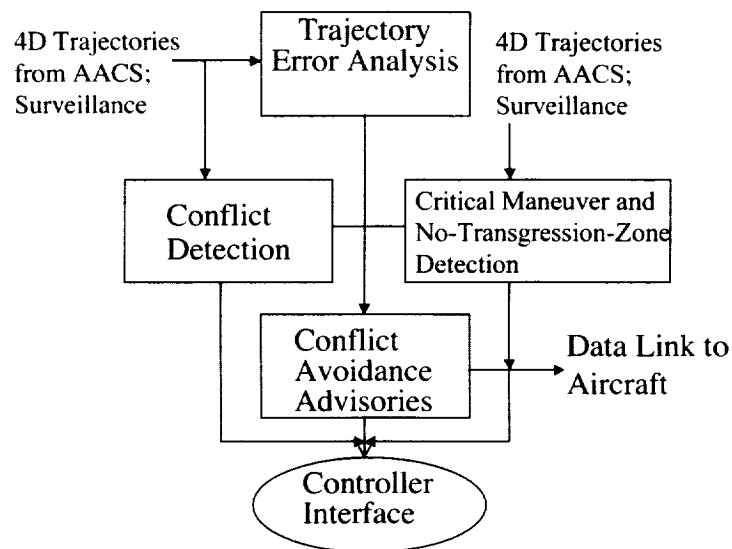



## TSAFE Conflict Detection and Avoidance Strategy

- Short detection horizon (~3 min.)
  - 3D velocity vector combined with near term flight plan intent is used for trajectory prediction
- Critical maneuver and no-transgression-zone alerts
- Conflict alerts with ~2 min. warning time to loss of separation
- Avoidance maneuvers to provide a short period of conflict-free flight (~3 min.)
  - Climb (or descend) to an assigned altitude level
  - Turn right (or left) to an assigned heading
  - AACS or controller follows up with strategic solution

## TSAFE Critical Maneuver Detection

Failure of AC1 to start planned turn on time produces immediate conflict with AC2

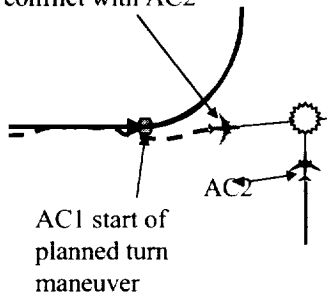

(a) Critical horizontal maneuver

AC1 descending below assigned altitude produces immediate conflict with AC2

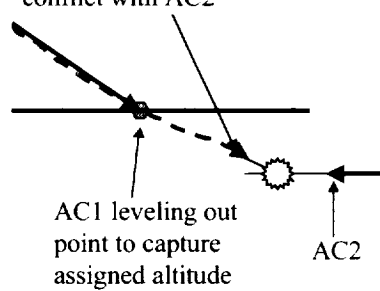

(b) Critical vertical maneuver

## TSAFE Development Approach

- Develop performance requirements by collecting and categorizing operational error data from historical records (in progress):
  - Error / deviation reports
  - Radar tracking data
  - Most errors found to have occurred during climb or descent
- Incorporate TSAFE functions in CTAS for research and evaluation (in progress)
- Evaluate TSAFE's alerting techniques by using recorded and live tracking data (in progress) .
- Prepare for controller and pilot-in-the-loop simulations field evaluation

## Example of TSAFE Critical Maneuver Alerting

(a) Ground Tracks

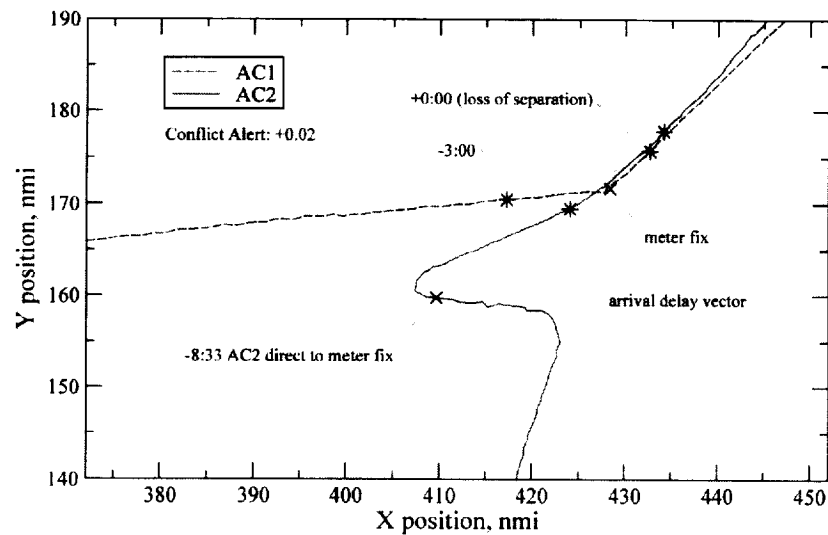

## Example of TSAFE Critical Maneuver Alerting

(b) Altitude Profiles

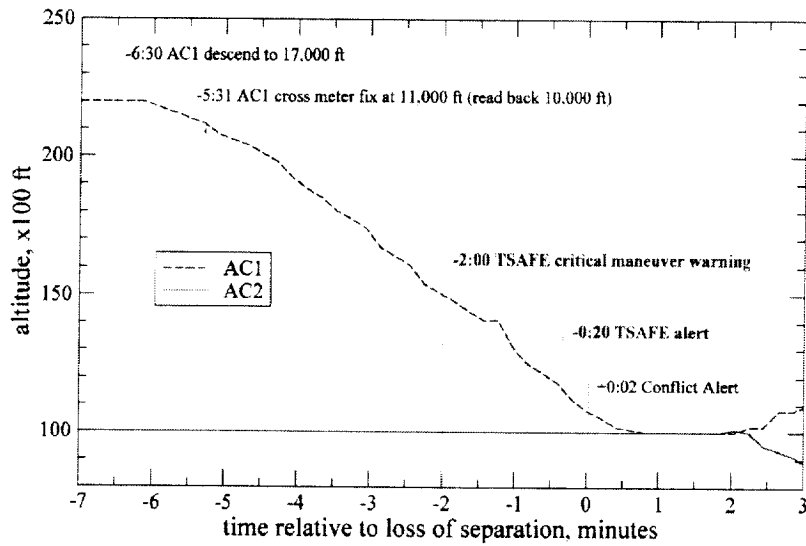

## Ground-Air Interactions in Advanced Airspace

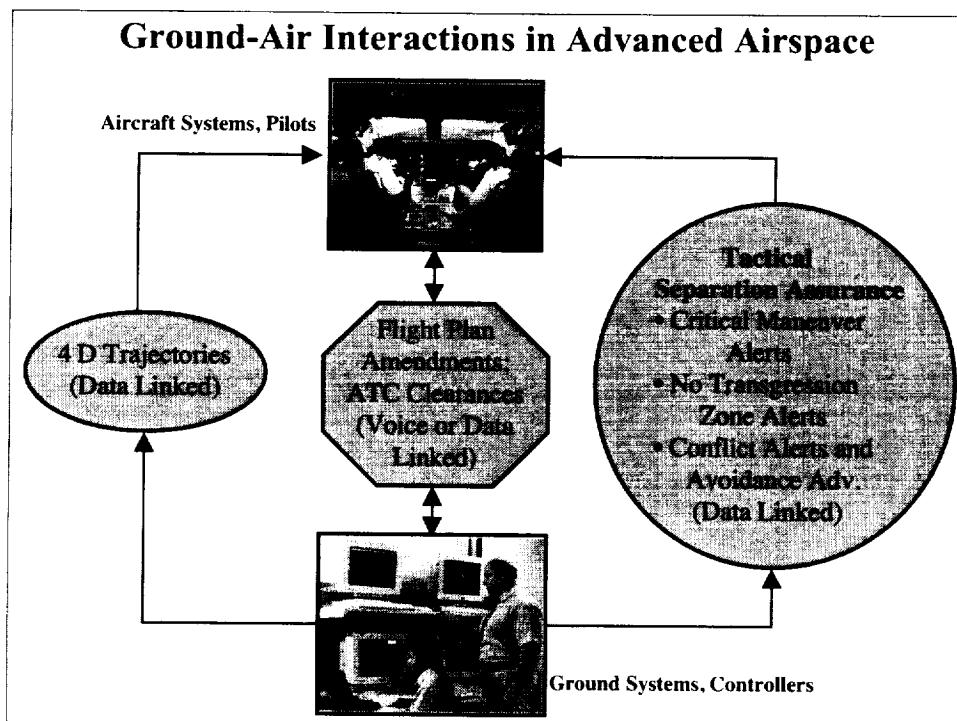

### **Concluding Remarks**

- Capacity of airspace is limited by controller workload associated with separation assurance
- Airspace has potential for more than twice the capacity of current system without changing current separation rules
- Advanced Airspace Concept has potential to increase capacity substantially by reducing controller workload associated with tactical separation monitoring and control
- Elements of Concept have been outlined:
  - Ground-based system provides 4D trajectories to equipped aircraft via data link
  - TSAFE provides separation assurance advisories to pilots via data link and protects against certain types of failures
  - Controller performs strategic control tasks and handles unequipped aircraft
- TSAFE has potential to reduce operational errors in current system

---

## **A Suggested Approach for Producing VAMS Air Transportation System Technology Roadmaps**

Del Weathers  
VAMS Project  
May 23, 2002  
AMES Research

1

---

## **Overview**

- VAMS Project Formulation Agreement Deliverable #3 requires the production of technology roadmaps to guide research
  - Producing this deliverable is the responsibility of the System Level Integrated Concepts (SLIC) sub-element lead by Rob Fong (rkfong@mail.arc.nasa.gov)
  
- Technical Approach
  - Use concept work to produce their own examples of technology roadmaps
  - Use system engineering work to produce an integrated catalogue of technology roadmaps along with technical discussions
  - The Top-level WBS steps are
    - 3.1 Top-level Technology and Operational Needs
    - 3.2 Top-level Technology Gaps
    - 3.3 Approach to Obtaining Transition Technologies
    - 3.4 Transitional Technologies - Round 2
    - 3.5 Integrated Roadmap: Top-down and bottom-up

2

## VAMS Project Policy

---

- Every concept that is nurtured within the VAMS Project will need to develop an ATS Technology Roadmap for that concept
- Those concept specific roadmaps will be:
  - Updated annually
  - Discussed at all technical interchange meetings
  - Shared amongst all VAMS participants
  - Maintained by their producer
  - Available electronically in a widely used format (MAC and PC)
- Concepts should follow the format described herein, suggest modifications, or independently develop an equally descriptive approach with examples
- As they are completed the ATS Technology Roadmaps will be:
  - Collected into a catalogue.
  - Integrated with each other into different topical sets
  - Linked to AvSTAR, the OEP and NASA's long term ATS strategy
  - Accompanied by technical discussions and research recommendations
  - An integration point for the University efforts (Dr. Zellweger team and others)

3

## Technology Roadmap Framework

---

- Suggested Starting Framework (AATT's Task Order 40 - SAIC)
  - ATM model
    - Existing examples
      - 1940 (in backup)
      - 1950 (in backup)
      - 1960
      - 1970
      - 1980
      - 1990
      - 1999 (in backup)
    - Need to be created
      - 2002 (today)
      - 2006 (near-term)
      - 2010 (FAA OEP Horizon)
      - 2015 (Medium term Vision Horizon)
      - 2020 (Longer term NASA Vision Horizon)
      - 2025 (Longer term Stakeholder Vision Horizon)

4



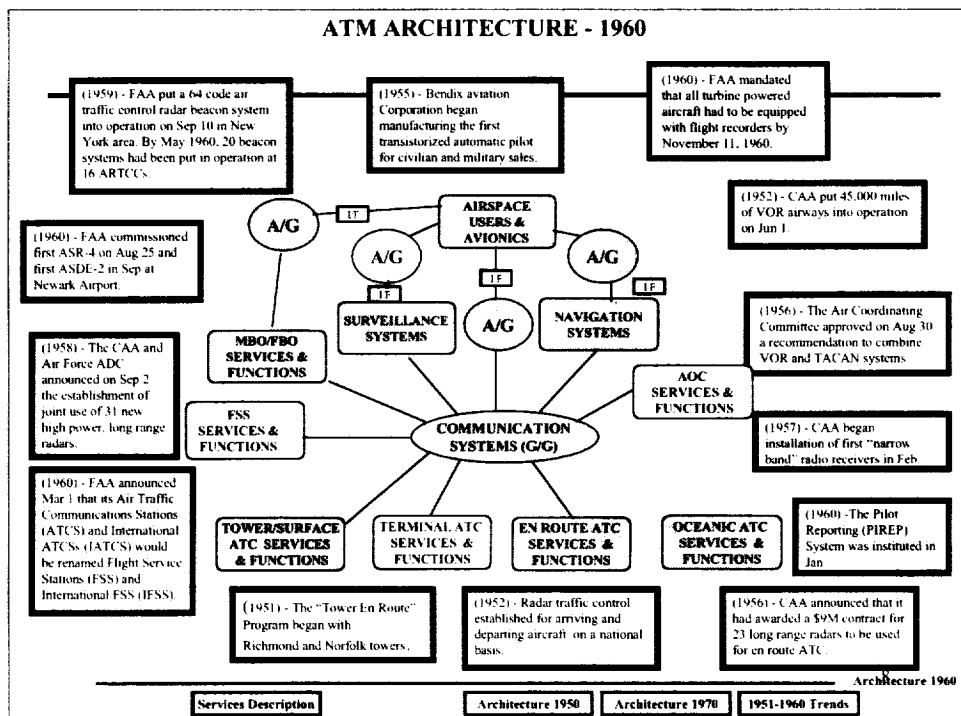
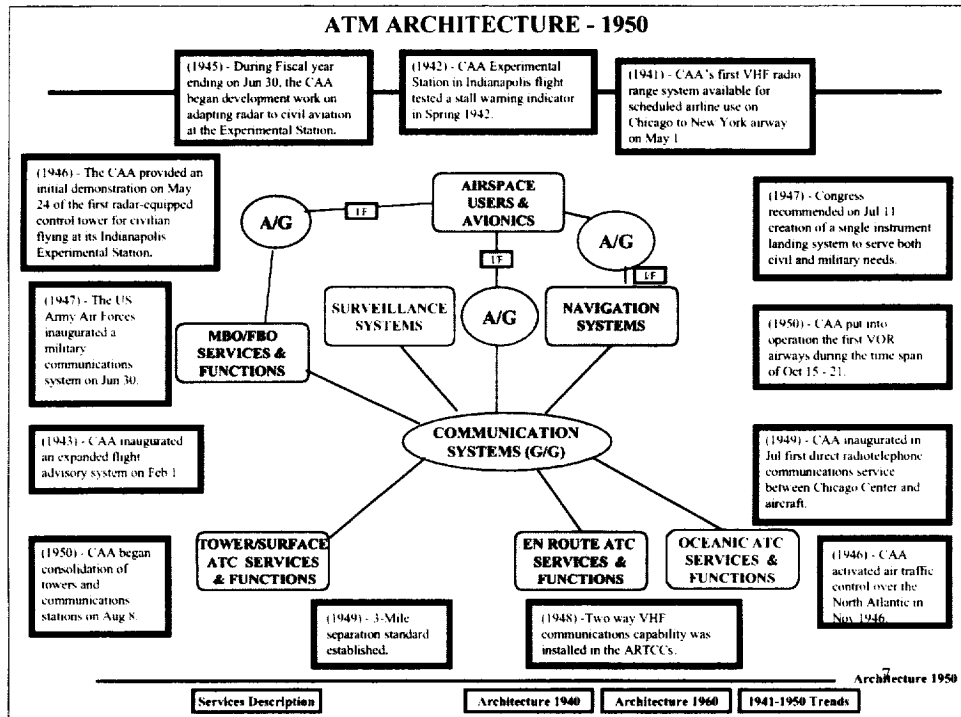



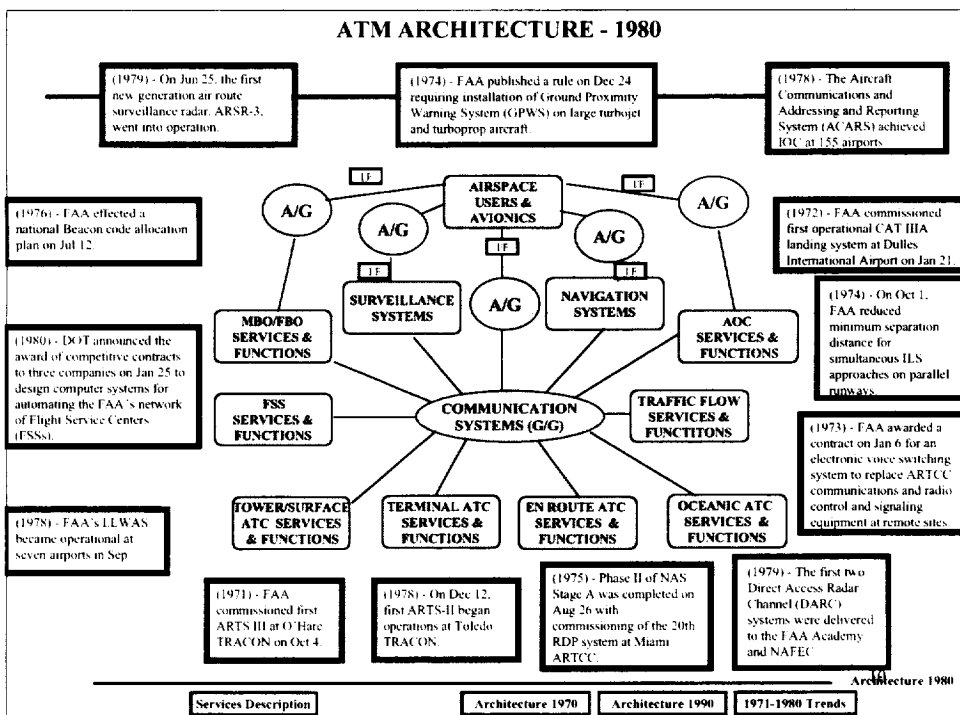
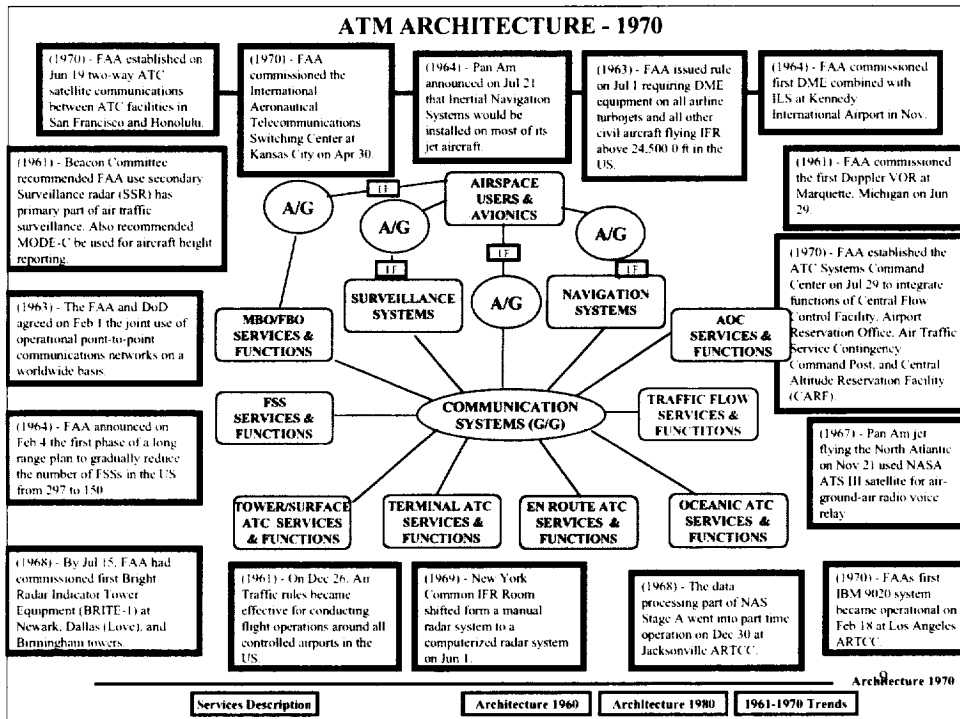

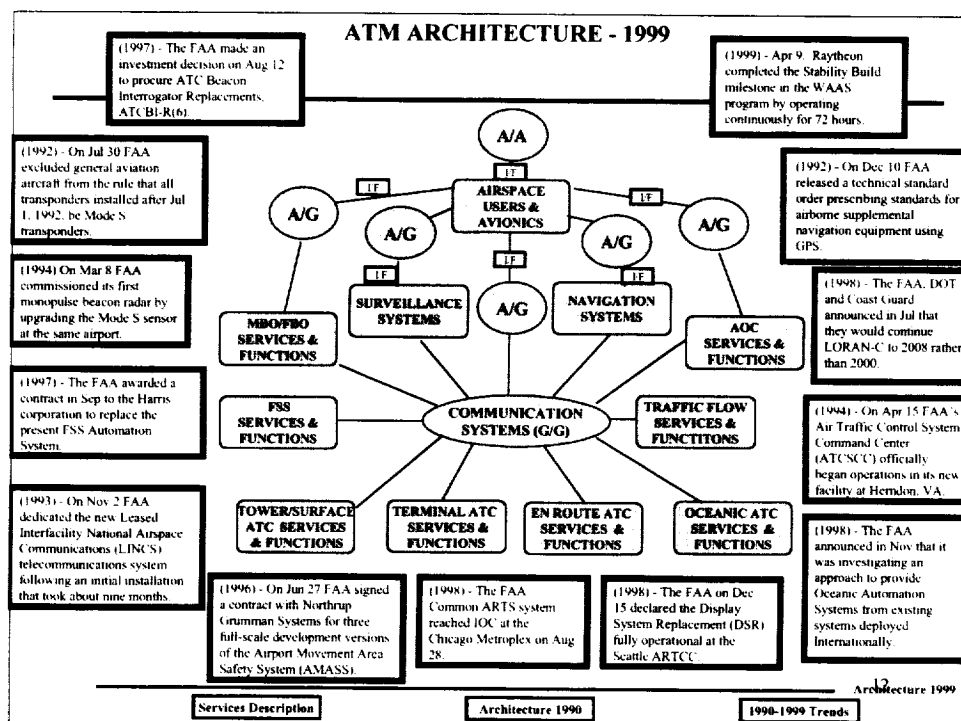
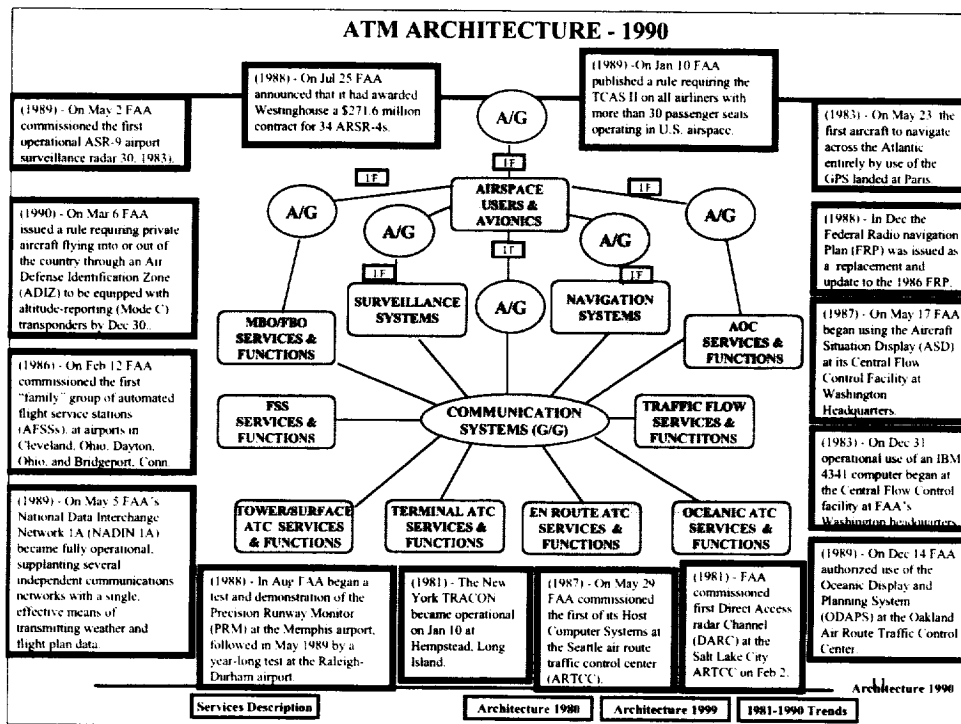



# University Concept Team Draft Report

Dres Zellweger

22 May, 2002

1

## The Team

Paul Abramson  
Kevin Corker  
George Donohue  
John Hansman  
John Kern

Dennis Koehler  
Ed Koenke  
Jim Poage  
Bill Wood  
Dres Zellweger

tap academic creativity, balance  
with ATM and flight ops expertise

2

## **The Charge**

- Develop 2025 Concepts
- Identify Transition Paths
- **Identify Research Agenda**
- Identify University Research Areas

Conduct 5 2-day meetings  
Deliver Final Report in July, 2002  
Participate in Summer Workshop

**Today's Brief – a work in progress**

3

## **Our Approach**

- Identify drivers
- Brainstorm concepts to accommodate drivers
- Identify research questions related to concepts
- Identify cross-cutting research questions
- Develop high level cut at possible transitions
- Update research questions based on transitions

4

## **Drivers**

- Capacity/Demand/Security
- Cost (sustainability)
- Technology
- Markets/Economics
- Globalization vs “what’s best for U.S.”

**Future must be driven by policy for public benefit,  
not vested interests of special interest groups**

5

## **Enablers**

- Change has traditionally been the result of “enablers”
- Research should be phased to match predicted timing of future “enablers”
- Transition problems have been an inhibitor
  - Our team thinks it’s important to learn from the past and understand what is required for successful transition to a new concept
  - Benefits driven transition not likely to work!

6

## **Timing**

Our team predicts major opportunity in 5-7 years

- workforce (retirement; contract re-negotiation)
- slot controls end
- AIR21 reauthorization
- serious capacity problems  
(major hubs, RJ fleet, air taxis)

Strong political leadership is necessary  
Must engage the public

7

## **CONCEPTS**

- The Bifurcated System
  - High Density Network
  - "Low Density" System
- Autonomous IMC Operations
- Other Concepts
- Airport Capacity

8

## **Bifurcated System**

**High Density Network - Highly Structured - Efficient Flow**  
**Low Density Space - Weakly Structured**

- We envision a split of the NAS into 2 separate networks.
- The high density network connects the high demand and congestion nodes and will grow over time as demand rises.
- Hub and spoke may be less dominant, but will stay because of its inherent efficiency
- External and perhaps intertwined with the highly congested hub network will be low density regions. There would be transition points between the 2 networks.
- By splitting the networks it should be possible to better optimize for each operating group.

9

## **High Density Network**

- Different elements of system have to be “impedance matched”
- Has to include airport terminal and landside
- Robustness of total system is important
- Must be based on complete system analysis and design

10



## Key Airport System Flows

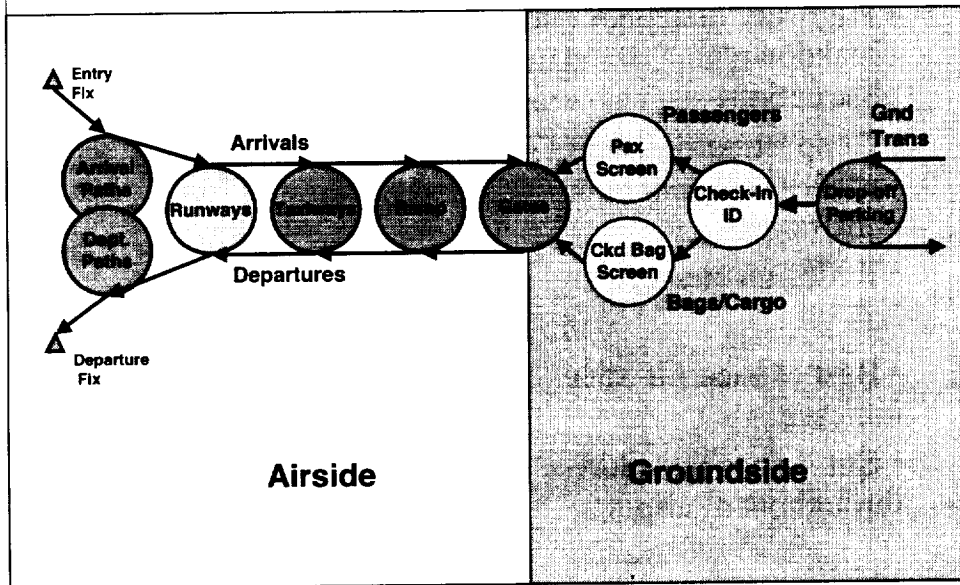

## The Tube Concept

- Between High Congestion Airports
- Highly Structured Routing for Efficiency, limited flexibility similar to TRACON flows but extend throughout network
- Maximum utilization of key resources
- Inner Loop Control goes to aircraft (RTA, In-Trail Separation, Pair-wise Maneuvering) to increase predictability and capacity
- Ground controls sequence, scheduling and structure

Power of tube is to create an abstraction that allows the controller to deal with many aircraft

12

## **The Tube Concept (cont'd)**

- Highway metaphor (std routes, on-off ramps, breakdown lane, standard detours around obstructions such as weather)
- Congestion limits and perhaps congestion pricing justifies stringent equipment and operating constraints
- Redesign airspace and procedures around network
  
- Best chance for early capacity and predictability increase
- But – does not address need for increased throughput at airports

13

## **Tube Concept - *Transition***

- Establish Leadership
- Get political and public support
- Get Workforce Buy-in Early
- Identify Issues, Opportunities, Inhibitors/Opposition
- Demonstrate in Experimental Corridors in High Value Target Markets
  - ORD-NYC
  - LA-SFO
  - Washington-New York-Boston
- Limited corridors, simple on/off ramps, break-down lanes
- Pair wise self separation (station keeping) for closer spacing
- Keep technology and procedures simple
- Give preference to demo participants

14

## **Tube Concept - *Research***

- **Select experimental corridors**
- **Model and design of tubes and procedures**
  - Entry, exit, merge, passing etc
  - Role of controllers
- **Develop pair-wise self separation protocols**
- **Develop non-normal procedures**
- **Understand interaction with flow management**
- **Develop interface with rest of system**
- **Redesign airspace**
- **Identify equipment requirements**
- **Prove interoperability with other tools**
- **Prepare for demo (real time sim, NASA flight demo, industry demo)**

15

## **Highly Interactive Dynamic Planner**

- Long term goal to achieve optimum use of capacity constrained system
- Dynamic air-ground negotiation of trajectories
- Aircraft would fly 4D routes, as a minimum in terminal regions
- Aircraft responsible for separation
- Could evolve from tube concept

### ***Many research issues***

- role of people
- dealing with major anomalies
- achieving system stability

- tight 4D planning may over-constrain the problem
- making system safe
- transition
- public acceptance etc etc

16

## **Market Based System**

- Major Hub Airports will Allocate Slots by Public Auctions:
  - Strategic, near term and spot auctions
  - May price runway occupancy
  - Peak runway loading will be reduced to government established safety and capacity optimized schedules
  - Aircraft size will be driven by a combination of airline profits and maximum enplanement opportunities
- Policy will determine how “national resource” will be used
- System will change behavior and find a new equilibrium

17

## **The Regional Airport System**

Objective – increase capacity of high demand urban regions, especially where primary airport expansion is limited

- In near term, use of “alternate” airports will grow to accommodate regional airlines, air taxi, fractionals, etc.
- In longer term, these airports could be managed as a single asset
- With appropriate multi-modal connectivity, some percentage of traffic could be dynamically assigned to different airports
- Terminal area ATM will have to be designed for best use

18

## **Autonomous IMC Operations**

### **Class Q – below 17,000 ft**

By 2025, no longer “low density” – we predict too many planes for ATC as we know it today

- Separation responsibility goes to aircraft
- Traffic management limited to density control
- Sequencing and interaction done by procedure and rules of road
- A ground monitoring function
- Requires an increase in safety over today’s VFR system (GA VFR safety is an order of magnitude lower than commercial)
  
- All planes must be equipped
- Restricted zones that a/c can’t fly into (avionics protection)
- Segregate from high density airspace (class A)
- Capable of dealing with wx problems – can’t fly over weather! 19

### **Class Q - *Transition***

- Having a clear Transition Path will be critical (Capstone and Safe Flight 21 models not adequate)
- Potential for controller delegation to part of fleet
- Potential for small, but typical “trial” regions
- Mandate equipment to accelerate transition
  
- Bifurcated System Vision
  - we expect Class Q airspace to grow to higher altitudes (i.e. lower density airspace surrounding the high density system)

20

## **Class Q - Research**

- What are airspace density limits?
  - for safety?
  - for communications?
- What else is needed to make system stable?
- What are failure modes and how do you handle them?
- What is ground/satellite infrastructure?
- What kind of ground "ATM" function is needed?
  - for security monitoring
  - infrastructure monitoring
  - for search and rescue
  - what else?
- How do you co-exist with rest of ATC system?
- How do you use ASAS? Wx?
- etc etc

21

## **Autonomous "SATS" Airports**

"Higher IMC rates at non-towered airports"

### **Research Issues**

- Feasibility?
- Hourly rate (10-15)?
- Avionics requirement?
- Ground based infrastructure?
- How do take advantage of WAAS?
- Need for ground-based system for control?
- Unequipped aircraft?
- Interface to ATC system (does ATC deliver aircraft to a "metering fix"?)
- Pilot qualifications and training?

22

## **Continue Current ATM Paradigm**

### **“muddling along”**

- Can't afford cost of doing same old things  
(will lead to a a system that can't get close to meeting demand.)
  - Economy will adapt!
  - But won't get economic benefits of aviation (steak and lobster will be hard to get in Kansas City)
  - Non-part 121 will slowly be driven out of transportation business.
- More ATM by dispatchers is likely
- Demand management

23

### **“muddling along” (cont'd)**

- Research Focus:
  - WAAS enhancements (new TERPs etc.)
  - better information flow
  - common situational awareness
  - moving CDM to tactical level
  - separation stds given knowledge of intent
  - best use of ADS-B use in existing environment
  - self sep in IMC approaches
  - redesign of high volume terminal airspace  
(maybe on big terminal area in east coast)
  - mixed equipage constraints
  - rethinking first come first serve
  - on-going OR to adapt to changes

24

## **Airports** – work still in progress

25

## **Crosscutting Research (very preliminary list)**

- What are elements of a successful transition?
- Understanding system behavior/dynamics
- Human factors  
(roles/responsibilities; situational awareness, etc.)
- Controller selection and training
- Separation standards
- Ways to reduce capacity variability  
(ex – security, wake vortex, Wx, airport arrival rate)
- How do you deal with major anomalies – when there's a change to a lot of flight paths? What are conditions required to keep system stable?
- CDTI uses – people and equipment

26



**Thank You!**

27

**Tube Concept**  
**Interleaved Structured and Unstructured Airspace**

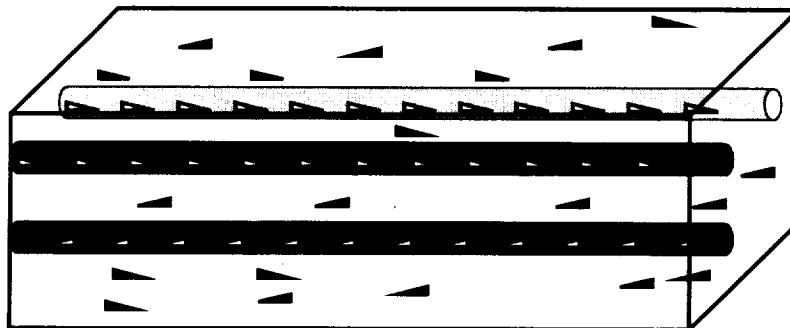

28

## Tube Concept On-Ramp Off-Ramp

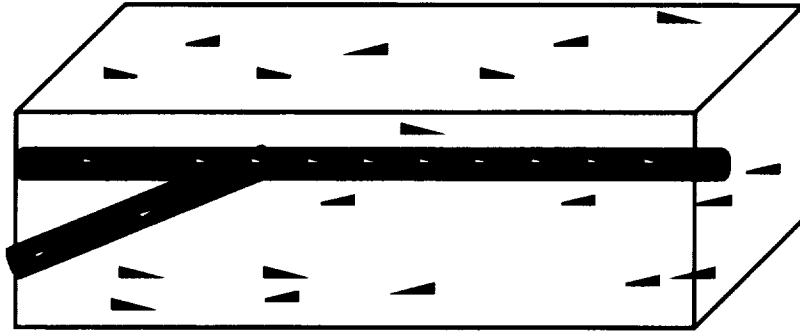

29

## Tube Concept On-Ramp Off-Ramp

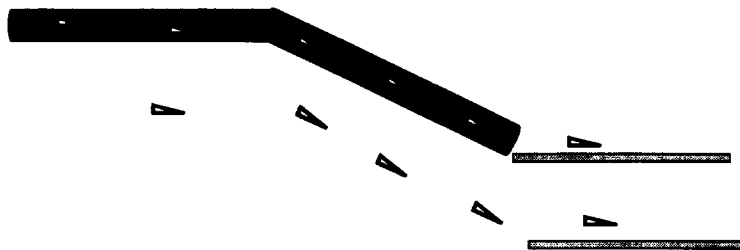

30

## Tube Concept Interleaved Structured and Unstructured Airspace

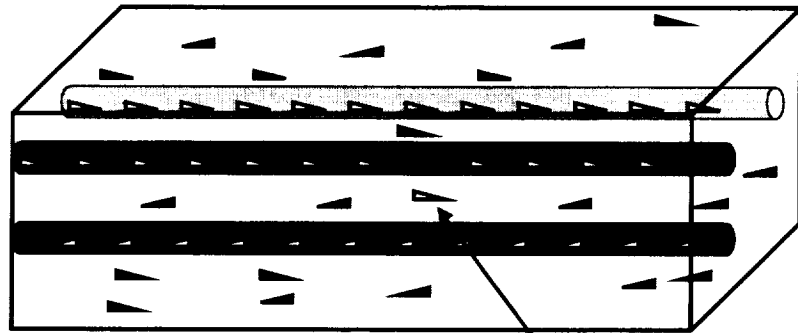

Problem Aircraft Exits Tube into Unstructured Airspace (Breakdown Lane) and Diverts to Backup Airport

31

## Strategy

The problem: How to build an *evolutionary* system that can meet the needs of a *fuzzy future*.

Step 1 - create a VISION

Step 2 - develop a *robust* set of concepts  
"if you don't know where you're going, any road will get you there"

Step 3 - perform "concept research"

Step 4 - develop high level architecture for the concept(s) - (zoning laws and building codes)

*In parallel - develop CNS/ATM technologies to fully develop the concepts and details of the "waypoints"*

Step 5 - develop a roadmap (transition path) for evolution to this future system

Step 6 - define operational and technology requirements and user consensus for initial waypoints

Step 7 - over time, update vision, concepts, and roadmap and repeat step 6 for next waypoints

- A ROBUST concept accommodates range of most likely future worlds
- Committing to ROADMAP a step at a time keeps options open
- Implementing steps along a well defined road overcomes "treatment of symptom" syndrome

32



## **VAMS TIM #1 Breakout Session #1 Technology Roadmaps**

Group 1  
Joseph Del Balzo, Facilitator  
May 22, 2002



## **Purpose of Technology Roadmap**



- ✓ **ID the technologies needed and a way to achieve them to support the development (implementation?) of a specific concept**
  - Tech Roadmap will starts as functional statement and then iterates to specific technology
  - Roadmap goes hand in hand with the Concept Development
- ✓ **ID technologies that support more than one concept**
- ✓ **ID (when needed) key decision milestones for technology choices**



## What should Technology Roadmap contain?



- v Timelines and activities needed for technology development
- v Performance goals of technology (not of the future ATM system)
- v Enabling technologies identified
- v Dynamically adapt to changing projections
- v (Probable cost for required R & D & Implementation – does not belong here.... in cost section of Concept Doc)
- v (not the socio-economic/political assumptions ... is in the Concept Document)



## Tech. Roadmaps changing per phase of the project



- v Should the format of the Technology Roadmaps change to include include different emphasis for each phase of the project -- No
- v Should the content of the Technology Roadmaps change to include include different emphasis for each phase of the project -- YES



## Where do the Transition Plans fit?



- ✓ **Technology Transition Plan is needed**
- ✓ **Is it part of the Technology Roadmap?...don't know**



## Recommendations



- ✓ **Technology Roadmap should be limited to the technology development required for each of the Concepts (and include milestones?)**
- ✓ **Other items in Del's "Tech Roadmap Characteristics" to be put into some supporting document**



**VAMS TIM #1  
Breakout Session #1  
Technology Roadmaps**

Group 2  
Kevin Corker, Facilitator  
May 22, 2002



**What is purpose of Technology Roadmap  
Tool for decision-makers? Why do we need it?**



**Technology Roadmap may not be the right term  
Capability & Function Map**

**Roadmap include Political and Policy**

**Roadmap include Roles and Responsibilities  
Roadmap distinguished from Program Plan**



## Road Map Should Contain?



- v **Why should it contain What ? Gets to purpose**
  - **Affect/guide policy**
  - **Iteratively be updated and form changed by Phase**
  - **Contain Critical Decision Points**
    - **NASA and Contractor Teams**
    - **Investment strategy**
  - **Consider Blending Process**
  - **Consider risk/fall back process in complex and non linear systems**
  - **Contain costs (in the aggregate)**
  - **Insertion, Extraction and Transition process**
  - **Technology Level of Capability not new development**
  - **Basic Research issues**
  - **Be different than the program plan**



## Road Map to Program Map

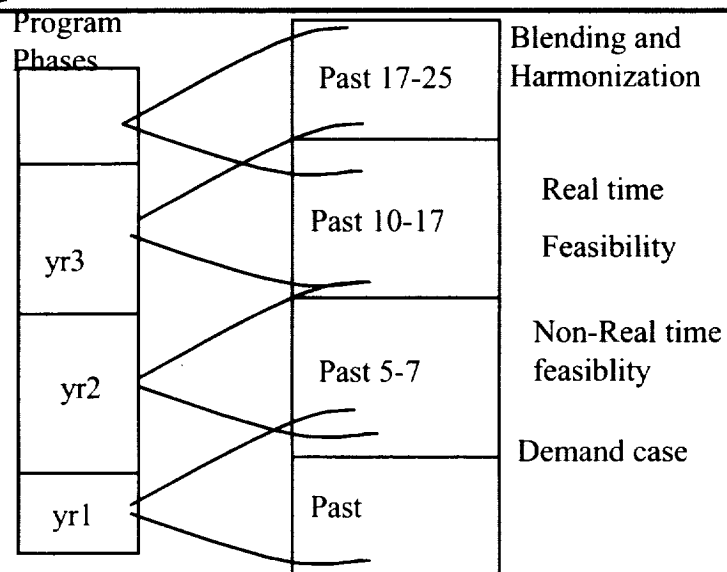





## Basic Research Issues AS critical design points



- v **Acoustic**
- v **Socio-political (demand and need drivers)**
- v **Environmental**
- v **Vortex – penetration, avoidance**
- v **Human Factors**
- v **Weather (Hazardous condition identification, prediction)**
- v **Large scale chaotic systems**
- v **Human Factors**



## Issues



- v **Issues with Roadmap**
- v **Timing – now is too early**
- v **RM is different than concept program plan**
- v **What is linkage to SEA to guide roadmaps**
- v **What is proprietary status of RM – share the light.**
- v **Multi-Modal**



# **VAMS TIM #1 Breakout Session #1 Technology Roadmaps**

Group 3  
Earl Van Landingham, Facilitator  
May 22, 2002



## **Key points**



- v **1) Need “concept roadmap” of which one part is technology, but includes socio-economic issues, legal considerations, etc**
- v **2) Expect roadmaps to mature (evolve) based on increasing fidelity of costs and benefits and other facets of concept**
- v **3) Technology Element of Roadmap**
  - **Key technology to be organized by common functional architecture and identified by time frame and performance objectives.**
- v **Summary**
  - **Need to address subject at next TIM**



## Other ideas



- v 1) **Expect to have multiple path roadmap – Need functional architecture of what we are trying to achieve**
- v 2) **Are we talking about new technology or better ways of piecing together technology? Want successful implementation of technology. Roadmap are requirements driven (Functional needs and performance needs)**
- v 3) **Do we need to know how much capacity gained by a particular concept before generating detailed roadmap?**

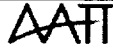

ADVANCED AIR TRANSPORTATION TECHNOLOGIES

VAMS TIM

May 22, 2002



## **Advanced Air Transportation Technologies (AATT) Project: Distributed Air-Ground Traffic Management**

Richard Mogford, Steve Green, Mark Ballin  
AATT Project



ADVANCED AIR TRANSPORTATION TECHNOLOGIES

VAMS TIM

May 22, 2002



### **AATT Project Focus Areas**

- **Develop en route and terminal decision support tools (DSTs) for FAA Free Flight Phases 1 and 2**
  - Enhance capabilities of present air traffic system
  - Deliver decision support tools to the FAA
- **Distributed Air-Ground Traffic Management (DAG-TM) Research**
  - Free Flight concept exploration
  - Evaluate feasibility of making major changes to current system and procedures
  - Deliver tested concepts to the FAA

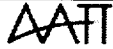

### DAG-TM Definition

- DAG-TM is the Free Flight part of AATT
- In DAG-TM flight crews, air traffic service providers, and aeronautical operational control dispatchers use distributed decision making to:
  - Enable user preferences/flexibility
  - Increase system capacity
  - Meet air traffic management requirements
- NASA is investigating the feasibility of DAG-TM concepts during the next four years
  - Using NASA Ames and Langley resources
  - Contractor support
- Will deliver tested concepts to the FAA

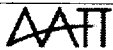

### The DAG-TM Philosophy

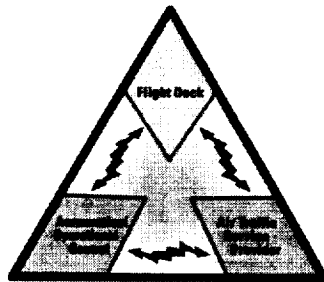

**Better Air Traffic Management through Distributed:  
Information - Decision Making - Responsibility**



### DAG-TM is a Gate-to-Gate Concept

- A matrix of gate-to-gate problems were defined by Ames, Langley, and Glenn researchers
- One or two DAG-TM-based concept element (CE) solutions were formulated to solve each problem



*Concept elements are possible modes of operation within the scope of the RTCA Task Force 3 concept*

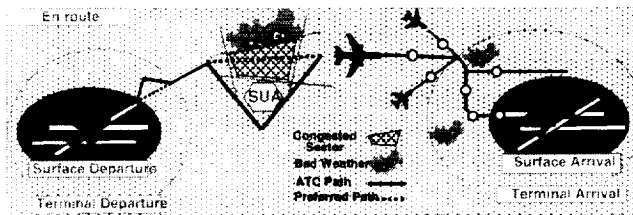

*The DAG-TM concept is comprised of 15 Concept Elements...*

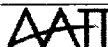

### Concept Elements

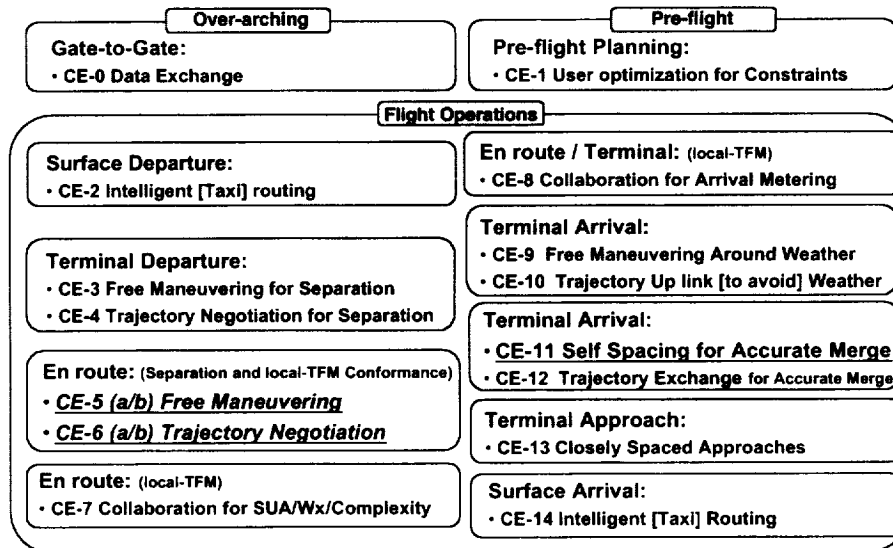

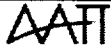

### CE-5:

#### Free Maneuvering for User-Preferred Separation Assurance and Local Traffic Flow Management (TFM) Conformance

##### Problem:

- Air Traffic Service Provider (ATSP) cannot accommodate trajectory change requests due to workload
- ATSP-issued clearances often cause excessive deviations from user preferred trajectories (UPTs) for separation assurance or are otherwise not optimal for users

##### Solution:

- Air: Cockpit Display of Traffic Information (CDTI)-equipped aircraft maneuver freely for separation assurance
- Ground: ATSP monitors separation (with ground-based DSTs) and provides separation assurance for non-equipped aircraft

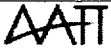

### Today's System

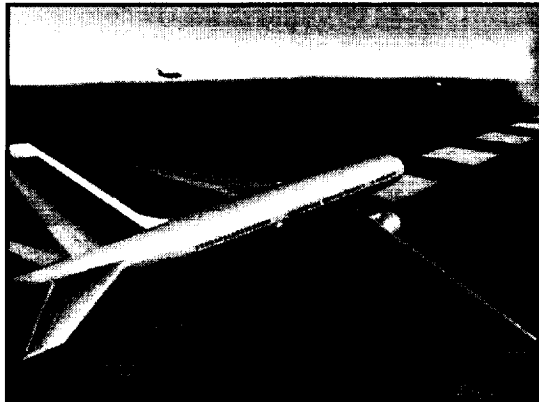

## CE-5 Concept

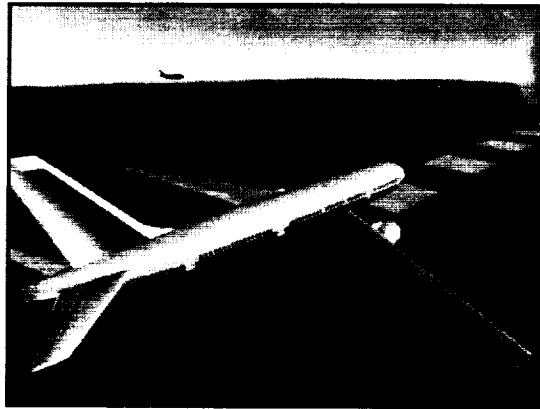

## CE-6: En Route (& Transition) Trajectory Negotiation for User-preferred Separation and Local-TFM Conformance

### Problem:

- ATSP workload limits throughput and accommodation of UPTs
- ATSP-issued clearances often cause excessive deviations for separation assurance or are otherwise not preferred by users

### Solution:

- User and ATSP negotiate for user-preferred trajectory changes:
  - User formulates UPT (based on constraints) and transmits to the ATSP
  - ATSP evaluates UPT for approval and amends constraints as needed
- CTAS-datalink-flight deck integration to facilitate:
  - Reduced datalink/CTAS input workload
  - Calibration of Flight Management System and CTAS
  - Trajectory-based clearances and improved flight conformance





## CE-6 Concept

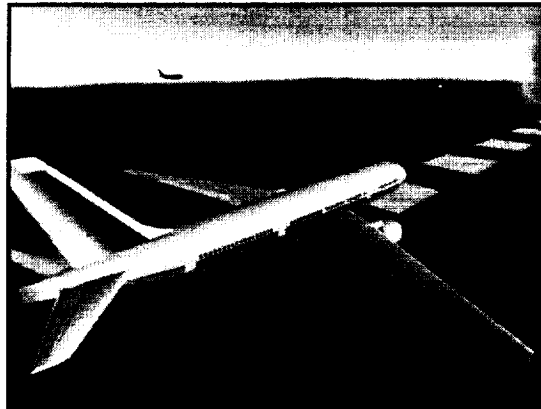

## CE-11: Self-Spacing for Merging and In-Trail Separation

### Problem:

- Excessive spacing buffers on final approach reduce arrival throughput and airport capacity
- Reduced visibility may limit airport acceptance rate

### Solution:

- CDTI-equipped aircraft are cleared to maintain separation relative to a leading aircraft:
  - Flight has deck displays and guidance for:
    - Maneuvering
    - Self-merging and spacing
    - Fine tuning of fixed-time spacing
  - ATSP has displays and procedures for shared separation responsibility

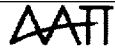

ADVANCED AIR TRANSPORTATION TECHNOLOGIES



VAMS TIM

May 22, 2002

## Today's System

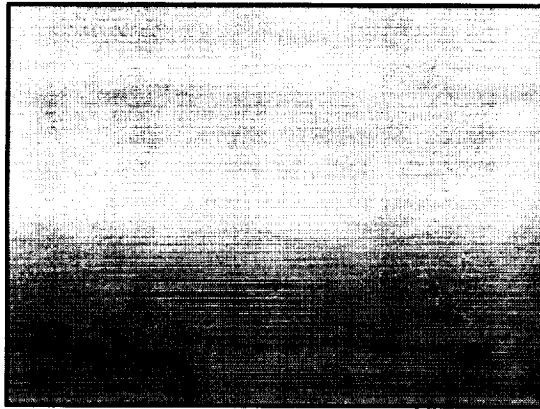

ADVANCED AIR TRANSPORTATION TECHNOLOGIES



VAMS TIM

May 22, 2002

## CE-11 Concept

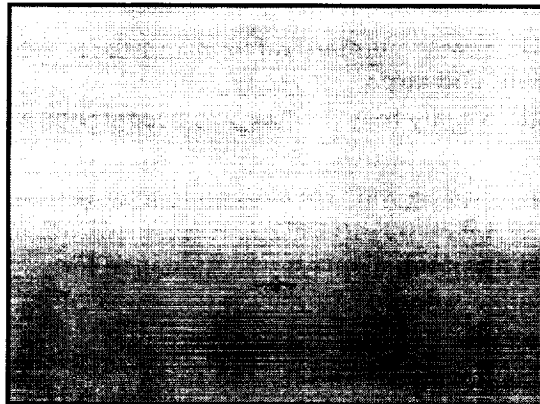

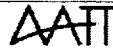

## DAG-TM Benefits

- CE-5
  - Self-management supports scalability of system
- CE-5 & 6
  - Increased user flexibility / efficiency within the presence of conflicting traffic and dynamic en route constraints
  - Shift/reduction in ATSP workload
  - Reduced excess separation buffers
  - Reduced voice communications
- CE-11
  - Reduced voice communications
  - Reduced controller workload for maintaining traffic separation
  - Increased arrival throughput

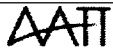

## NASA DAG Research

- NASA Ames, Langley, and Glenn collaborating on DAG work
  - Ames focusing on air traffic control (ATC) or ground DST and procedures development
  - Langley responsible for flight deck DST and procedures research
  - Glenn researching communications infrastructure
- Initially pursuing parallel research
- Leading to air/ground integration studies to assess the feasibility of each concept
- Benefits data will also be collected in controlled experiments



## Current NASA Ames Research

- Focusing on ATC component of DAG-TM CEs-5, 6, and 11
- Goal is to demonstrate initial feasibility of CEs
- Basing research on Concept Descriptions
- Filling out and evolving the concepts as research progresses
- Continuously involving operational people and stakeholders
- Incrementally building laboratory capabilities to address CEs
- Adding to complexity each year
- Following details are in process and subject to change



## Ames Research Concept

- The following scenarios are being used to test CEs-5, 6, and 11
- The Basic Scenario is being augmented this year with additional traffic, complexity, weather, and procedures
- Demonstrations held in September 2001 and January 2002
- Next demonstration in June 2002
- Two week experiment in September 2002 to initiate evaluation of benefits and performance
- Goal is to complete the research by the end of 2004

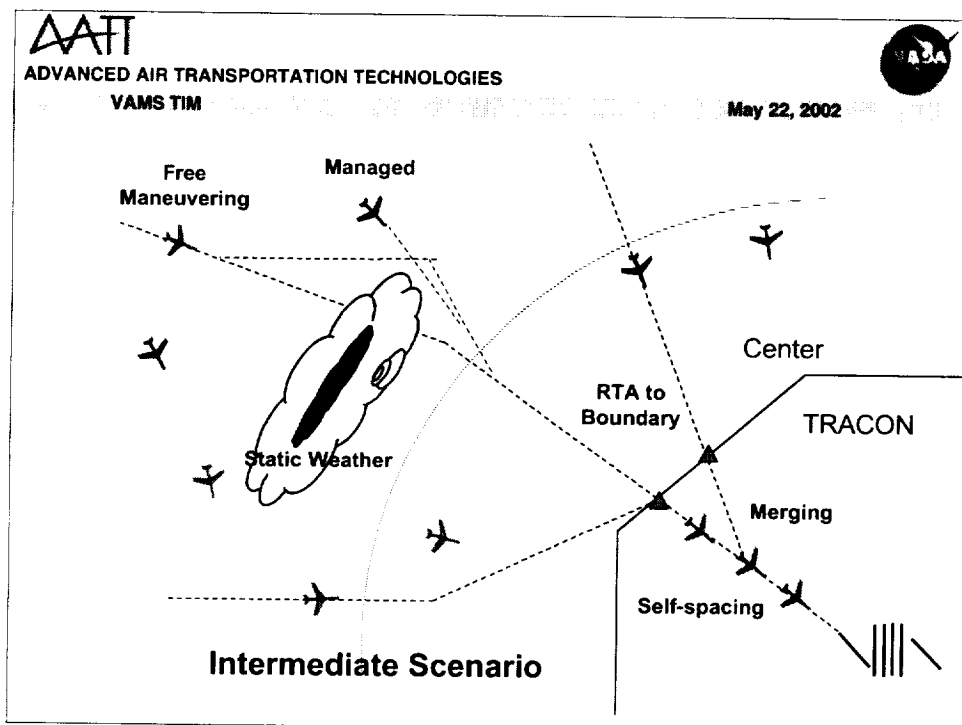
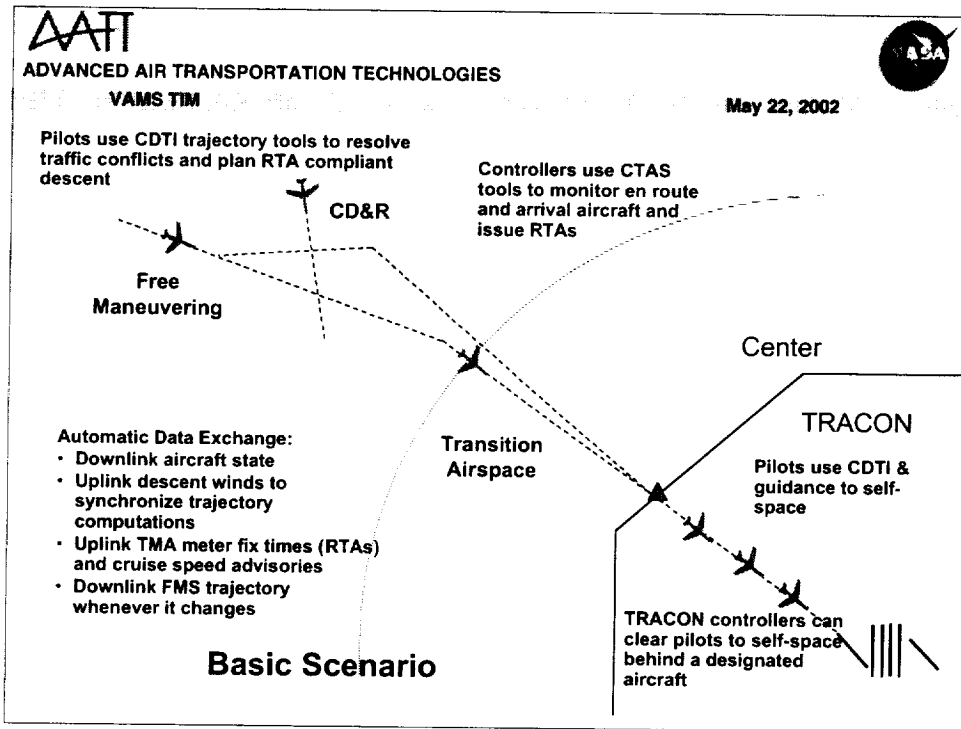

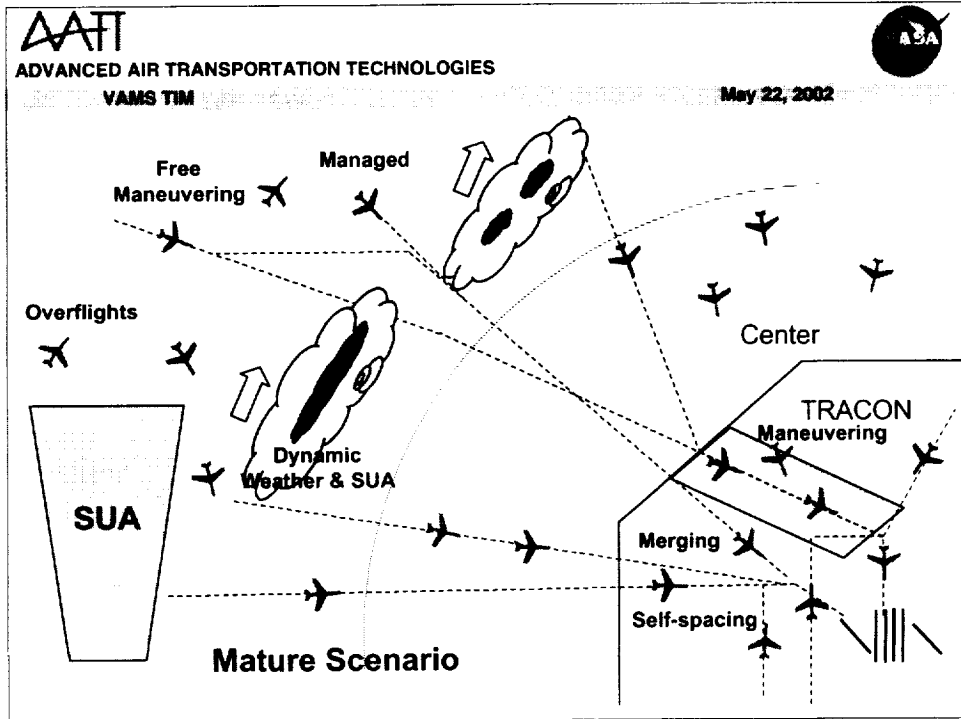

**AAATI**  
 ADVANCED AIR TRANSPORTATION TECHNOLOGIES  
 VAMS TIM  
 May 22, 2002

### Roles and Responsibilities: General Rules

**Only One Entity is Responsible for Separation**

- ATC has the sole authority to cancel self-separation
- Pilot can request the cancellation of free-flight

**En Route Free Flight – Flight Crew Responsible**

- Flight crew (upon acceptance) is responsible for separation assurance
- Flight crew can request ATC assistance for conflict resolution, flow control, and traffic management considerations

**Transition Phase – Flight Deck Responsible**

- ATC will provide Required Time of Arrival (RTA) advisory for meter fix
- Flight crew is responsible for separation and meeting RTA

**TRACON Boundary – ATC Responsible**

- Controller is responsible for separation
- Flight crew can be cleared to maneuver, merge, and maintain in-trail spacing
- Controller can revoke clearance at any time

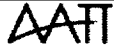

ADVANCED AIR TRANSPORTATION TECHNOLOGIES

VAMS TIM

May 22, 2002



## Ames Research Facilities

- Flight simulator
- Airspace Operations Lab
- Cockpit Display of Traffic Information

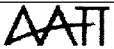

ADVANCED AIR TRANSPORTATION TECHNOLOGIES

VAMS TIM

May 22, 2002



## Crew-Vehicle Simulation Research Facility

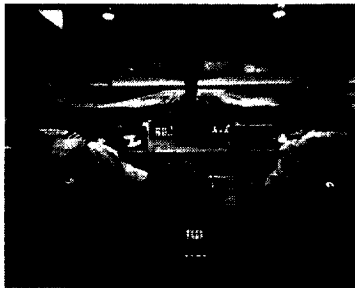

Advanced Cab



### Airspace Operations Lab (AOL): Air/ground Simulation Capability for Human-System Research

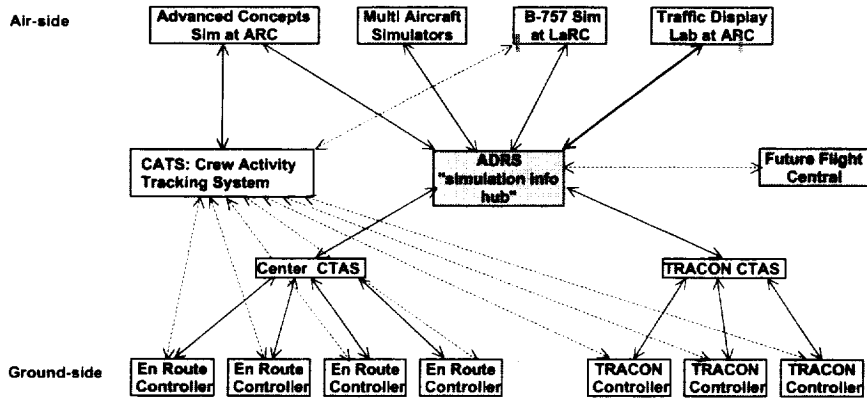

### AOL Workstations





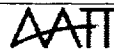

ADVANCED AIR TRANSPORTATION TECHNOLOGIES



VAMS TIM

May 22, 2002

### AOL Controller Display



ADVANCED AIR TRANSPORTATION TECHNOLOGIES



VAMS TIM

May 22, 2002

### CDTI

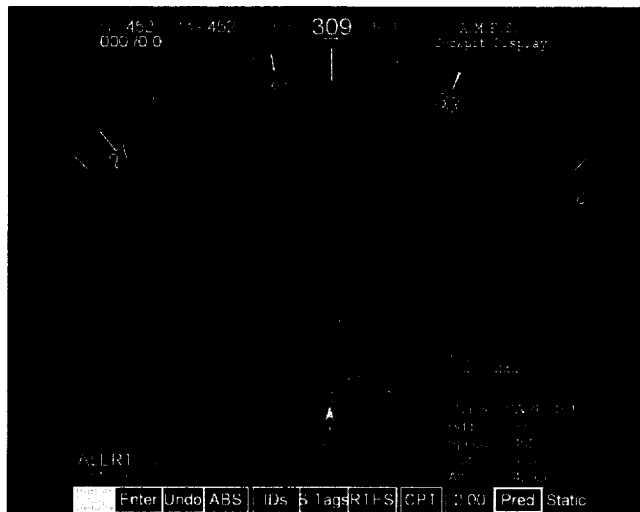

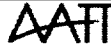

## NASA Langley DAG-TM Research

- **Developing flight deck tools and procedures for CE-5 and CE-11**
- **Conducted two recent experiments:**
  - **Airborne Use of Traffic Intent Information (AUTRII), focusing on quality of intent information**
  - **Advanced Terminal Area Approach Spacing (ATAAS), terminal arrival self spacing study**
- **Continuing with airborne DST development to support DAG concept element feasibility research**



## Airborne Use of Traffic Intent Information (AUTRII)

- **Evaluated pilot capability to perform airborne self-separation in presence of flow constraints**
- **Investigated *advisability* of exchanging of intent information between autonomous airborne operators**
- **Evaluated utility of initial airborne decision support and CDTI functions**
- **Evaluated pilot acceptance of role expansion to include separation responsibility**

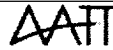

## Comparison of Two Operational Modes

- **Tactical Mode**
  - Based on exchange of *state* information only
  - Near-term conflict detection (5 minutes)
  - Maneuvers implemented manually through Flight Control Panel
- **Strategic Mode**
  - Took advantage of Flight Management System (FMS) guidance and performance database
  - Incorporated *state* and *intent* information in conflict detection
  - Longer-term conflict detection (nominal 20+ min.)
  - Maneuvers implemented manually or through FMS guidance

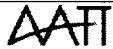

CDTI developed for ATRII combines features from NASA Ames, NLR, and NASA Langley:

- Resolution advisories
- Conflict alerting symbology
- Conflict prevention “no-go” bands on heading, speed, and vertical speed scales
- Required time of arrival
- Predictors / flight plans
- Autonomous vs. managed aircraft
- Tail tag altitude - absolute / relative
- Altitude filter
- Climb / descent symbology
- Area hazard display





## AUTRII Summary

- **Initial Conclusions**
  - Pilots met constraints in both strategic and tactical modes
  - Operational complexity did not affect pilot performance
  - Pilots preferred strategic mode (with state & intent information)
  - Display features were effective
- **Additional Data Recorded for Analysis**
  - Complete trajectories as flown
  - Pilot actions (maneuvers, display manipulations)
  - Workload measures (objective, subjective)
- **Plans for Continued Research**
  - Display evolution: vertical CD&R, weather conflicts, dark screen design
  - Descent CD&R with crossing restrictions



## ATAAS Simulation Study Objectives

- **Pilot evaluation (acceptability) of:**
  - Approach spacing tasks (including charts, procedures and use of ATAAS system)
  - ATAAS user interface
- **Pilot assessment of workload with different levels of automation**
- **Evaluation of algorithm performance when implemented on “real-world” equipment**

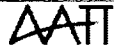

## ATAAS DST

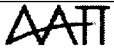
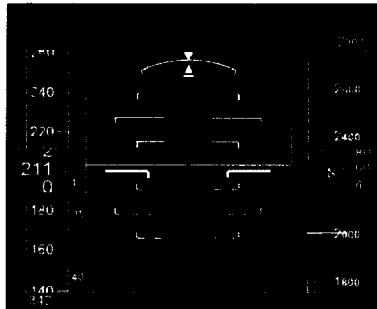

## Summary of Preliminary ATASS Results

- Algorithm performance
  - Spacing interval within one second of target when ATAAS speed guidance coupled with FMS
  - Spacing interval within 5 seconds when pilots followed speed commands with manual throttles or MCP
  - Standard deviation 1.3 to 1.7 seconds for the different control modes

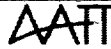

### Preliminary Post-Run Subjective Ratings

- Pilots rated workload for ATAAS approach comparable to standard approach procedures

(1=much lower, 4=the same, 7=much higher):

	Physical	Mental	Overall
Mean	3.8	3.9	4.0
Std. Dev.	1.2	1.2	1.1

- Pilots rated head-down time acceptable

(1=not at all acceptable, 4=borderline, 7=very acceptable):

	Downwind	Base	Final
Mean	5.8	6.0	6.2
Std. Dev.	1.5	1.2	0.9

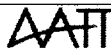

### NASA Langley Research Facilities

- Air Traffic Operations Laboratory
- Flight Simulators
- B-757 Aircraft

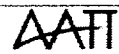
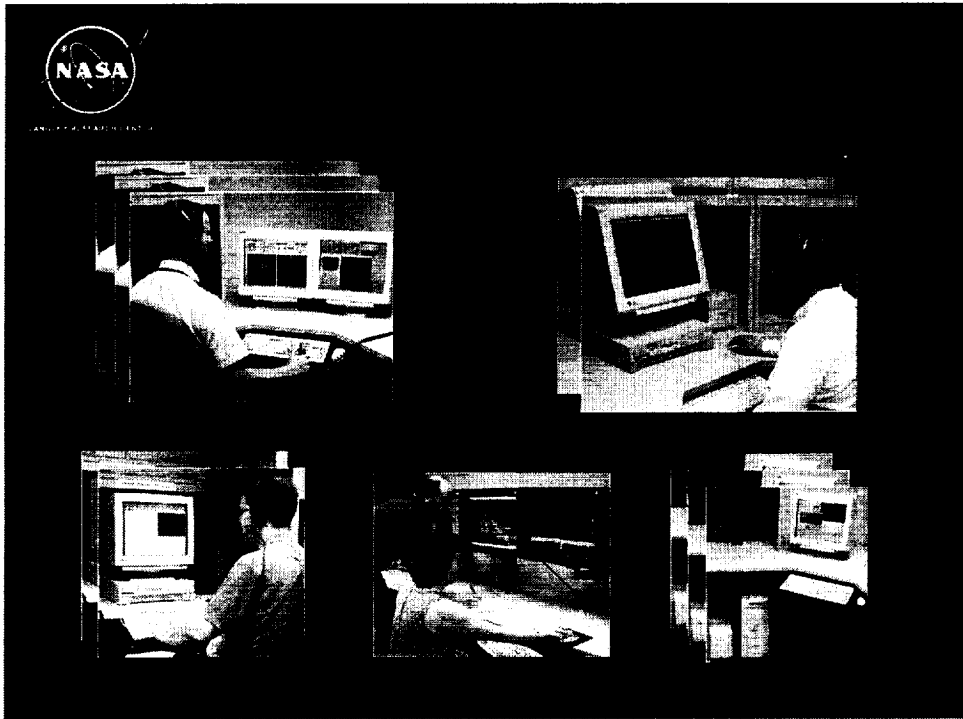

ADVANCED AIR TRANSPORTATION TECHNOLOGIES

VAMS TIM

May 22, 2002



### LaRC Flight Deck Simulators

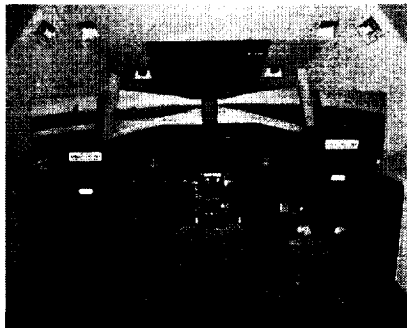

*Research Flight Deck*



*Integration Flight Deck*

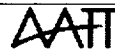

ADVANCED AIR TRANSPORTATION TECHNOLOGIES



VAMS TIM

May 22, 2002

## Langley B757 Test Aircraft



ADVANCED AIR TRANSPORTATION TECHNOLOGIES



VAMS TIM

May 22, 2002

The End



- Please clarify the VAMS Program goals and constraints regarding a common ground of concepts and implementation.
- Since we have opened the door to changing ATC procedures, when will we open the door to discussing changes to the AOC procedures (e.g., schedules)?

- *Comment:* The maximum capacity (and throughput) operational point is not necessarily the cost optimal operating point in the system.
- *Comment:* SEA and VAST need to understand concept evaluation requirements sooner rather than later.
- *Comment:* The VAMS TIM introduction mentioned concepts without implementation, but several works have already or plan field testing or implementation.



- Can we get the demographics study data and projections from SATS so we can better understand demand in the future (also FAA)...
- What is the long-term plan to manage and disseminate concept updates to the supporting SEA and VAST teams?



- *Comment:* Need multiple copies of handout book electronically. (Hard to read book).
  - will take old version first; get new version later.
- *Comment:* Related to the printed slides -- please make them larger.
  - I don't need the notes space
  - margins could be much smallerAs is most slides are unreadable.



**VAMS TIM #1  
Breakout Session #2  
Scenarios and Metrics**

Group 1  
Joseph Del Balzo, Facilitator  
May 23, 2002

1



***Scenarios and Metrics  
Breakout Group #1***



- 1. What should we consider our baseline scenarios and metrics?**
- 2. What are the special considerations for real-time and non-real-time scenarios?**
- 3. What are the special considerations for real-time and non-real-time metrics?**
- 4. What mixes of aircraft capability need to be represented in the scenarios?**
- 5. What CNS capabilities need to be represented in the scenarios?**

2



## 1. What should we consider our baseline scenarios and metrics?



- v Same as baseline year for 2x and 3x goals (1997)
  - OEP 2010?
- v Kind of metrics (high level)
  - Cargo passengers and operations
  - Passenger miles per unit of time
  - Number of operations
  - Average delay
  - Economic value (more value in direct flight, quality)
  - Operational costs (Fuel burn 20% of costs)
  - Safety
  - Environment
    - Noise print
    - Pollution
  - Trip time
    - Gate-to-gate
    - Door-to-door
  - Activity metrics

3



## 2. What are the special considerations for real-time and non-real-time scenarios?



- v Depends on the question you are trying to answer
  - What are the set of questions VAMS needs to answer?
- v Is there a difference in the scenarios?
  - Different scale
  - Different objectives
  - Different set of inputs
    - Sometimes yes, sometimes no
  - Real-time – human performance
  - Non-real-time – overall performance
- v Do we need different scenarios?
  - Fast-time can be more abstract
  - Different level of detail
  - Different fidelity
  - Different granularity
- v When real-time when non-real-time?
- v Real-time is not necessarily human-in-loop
  - Shadow mode testing

4



### 3. What are the special considerations for real-time and non-real-time metrics?



- v **Why are the metrics different?**
  - Two kinds of simulations measuring different quantities
  - Depends on question, objectives, level-of-detail and scope
  - Some can't be measured in both
  - Instruments used to make measurements are different
  - Cost and availability of resources (time)
  - Repeatability
- v **Examples of real-time metrics**
  - Response time
  - Workload
  - User acceptance
  - Aircraft separation
- v **Examples of non-real-time metrics**
  - Same as real-time except for what can not be measured
  - High level system parameters
  - Operational costs
  - Flow capacity

5



### 4. What mixes of aircraft capability need to be represented in the scenarios?



- v **Yes, all concepts need to address all aircraft relevant to that domain over a range of capabilities**
  - General and specific
- v **Aircraft capability**
  - Performance
  - Aircraft characteristics
  - Equipage
  - 4D
- v **Equipage capability**
  - TCAS
- v **Depends on the question and is defined by the scenario**
  - Wake vortex
- v **Concepts cover all aircraft**
  - Runway independent (Tilt rotor)
  - Large capacity aircraft (797)
  - UAV
- v **Emphasis on IFR**

6



## 5. What CNS capabilities need to be represented in the scenarios?



- v Yes, all concepts need to address all CNS relevant to that domain over a range of capabilities
- v How you represent them depends on the question
- v Concept specific
- v NAS architecture expected by 2020
- v Primary/backup
  - GPS failure
- v Ground
  - Weather
- v Air
  - Weather
  - Flight deck capabilities are a subset of the last question
- v Space
- v 4D intent?

7



## Three—Two Most Important Points



- v Choice of scenarios and metrics depends on the question
- v Clearly define the questions for VAMS (individual concepts)
  - Needs to be done before development of scenario and definition of metrics
  - Choice of simulation
  - Objectives
  - Scope
  - Fidelity

8



## VAMS TIM #1 Breakout Session #2 Scenarios and Metrics

Group 2  
Kevin Corker, Facilitator  
May 23, 2002

9



*SEA Break Out Report Out: Mindful of a Distinction Between  
Non-real and Real time Simulation Requirements*



- √ **Human Variability, NAS Scale response**
  - Concept maturity, Equipment Specificity
- √ **Q1 # of A/C in sim & Q2 # of A/C for Metrics**
- √ **Traffic Demand Model depends on OPCON's influence on business case (FT, RT)**
  - Simulation Scope
  - Airspace
  - NAS
  - Selectable
- √ **Passenger seat miles**
- √ **Operations**
  - through put Cargo, Business Jets, military, General Aviation
- √ **Complexity factor (1x, 2x, 3x) to be considered**

10



**Q3: How long do the scenarios need to be to reflect realism for our concepts**



- FT: One day ( 20 – 26 hours)
  - v Multiple days with different effects
  - v Day of the week
  - v Resolution of scenario data (milliseconds or minutes) - Depends
  - v Metrics by flight
  - v By some dependent or course time metric
- RT: Scenario or OPCON dependent
  - v NAS wide vs Site Specific
  - v 10 minutes - 2 hours, 8 hours
  - v Fatigue studies
  - v Transition period
  - v Flight Deck
  - v ATM } Differential event rate for each
  - v AOC
  - v If local event, single concept – guideline is 10 minutes
  - v If Pulse event guideline is 2X bandwidth of pulse
  - v If NAS wide issues guideline is 4 - 8 hours
  - v (longer for fatigue and strain evaluations)



**Q4: How do we try to insure buy-in from the stakeholders regarding the validity of our scenarios and metrics**



- v Demand Models: Airlines
  - v Roles and Responsibilities: Practitioners
  - v Who are the stakeholders? Buy in by whom?
- Stakeholder community
- v Current (Small incremental)
    - Super users
    - Future users
- 
- v Product introduction
  - v Is it worth caring?
  - v CADREs





**Q4: What are the “challenge” events that are relevant for the scenarios**



- v Weather
- v Failure Modes
- v System Shutdown
- v Military Operations
- v Security
- v Demand Load (holiday travel)
- v Airspace Sectional Loss
- v Information Infrastructure
  - v Data Integrity and Robustness
- v Equipment dependent failures
  
- v Collision Risk Models
  - v Formation Flying
  - v Tight Coupling
  
- v When and how much challenge modes in OPCON test
  - v -> Validation Plan

13



Current = 1997 levels  
 Moderate = (2x current)  
 High = (3x current)

Level of Scenario	Environment	Fast Time	Real Time
Baseline	NAS	Current	Current or less
	SPECIFIC	Current	Current or less
Moderate Increase	NAS		
	SPECIFIC		
High	NAS		
	SPECIFIC		

14



## **VAMS TIM #1 Breakout Session #2 Scenarios and Metrics**

Group 3  
Earl Van Landingham, Facilitator  
May 23, 2002

15



## **Summary of Breakout 2, Group 3 Session**



- ∨ **Difficulty starting in the “middle of the movie”**
- ∨ **We assumed we were addressing only capacity metrics in our answers (we know there are others)**
- ∨ **A concerted effort was made to address all 5 (nos. 11 - 15 in Sandy’s list) questions put to them**
- ∨ **A “challenge event” was interpreted to be a perturbation that has to be included in the scenarios in the execution of the simulation of the concept**
- ∨ **In question 13, technical challenges were assumed to be framework issues (not events) that need to be considered in the development of the scenarios, vs. challenges**

16



## Summary, cont'd



- v **Re: question 14, a number of specific recommendations were provided that must be considered in testing the concepts, however some open issues were also identified (e.g., Incompatible concept/system architecture issues)**
- v **The consensus of the group was that its necessary to precisely define the entry and exit conditions of the domains.**

17



## Agenda



- v **11. What are the "challenge" events that are relevant for the these metrics (e.g., choke points, weather)?**
- v **12. What are the measures that need to be addressed in the scenarios? (These should consider economic, safety, security, environment, and human performance factors)**
- v **13. What are the technical challenges in scenario development?**
- v **14. How do we insure the appropriate testing of the concepts that include only one domain v. those that are gate-to-gate?**
- v **15. Since we will have multiple scenarios, how to we insure some comparability between them so we can test some single domain v. gate-to-gate concepts fairly?**

18



## Group 3, Number 11



- √ **What are the “challenge” events that are relevant for the capacity metrics (e.g., choke points, weather)?**
- √ **Important capacity metric events:**
  - **Weather**
    - inaccurate forecasts
    - deicing conditions
    - convective
    - changes to ceiling/visibility
    - changing wind conditions, strong gusts
  - **Schedules**
    - demand exceeding capacity

19



## Group 3, Number 11, cont'd



- **Outages (scheduled and unscheduled)**
  - facility
  - radars
  - runways
- **Human error**
- **Terrorist events**
- **Resource loading**
- **Noise/other environmental issues**
- **Aircraft mix, unequipped aircraft**
- **SUA or other airspace closures**
- **Runways**
- **Wake Vortices**
- **Separation**
- **Labor/unions**

20



## Group 3, Number 12



- v **What are the measures that need to be addressed in the scenarios?**  
(These should consider economic, safety, security, environment, and human performance factors)
- v **Measures**
  - Delay (ave, peak, etc.)
    - airborne delay
    - ground delay
    - allocation of delay
    - cancellations
  - Passenger throughput
  - Aircraft throughput
    - Ave, peak
  - Cost and cost allocation

21



## Group 3, Number 12, cont'd



- Equity
- Safety metrics
  - conflict, conflict alert
  - workload
  - weather exposure
- Access
- Unused capacity
- Cargo throughput
- System stability
- Predictability
  - edict compliance

22



## Group 3, Number 12, cont'd



- Environment
  - noise, pollution
- Passenger satisfaction
- Staffing
- Efficiency
  - workload
  - comm loading
- Political constraints, public mandates
- Sector density

23



## Group 3, Number 13



- v What are the technical challenges in scenario development?
- v Challenges for scenario development
  - schedules
  - demand
  - fleet mix
  - weather conditions
  - representative set
    - consensus
    - coverage
  - observability of phenomena
  - appropriate complexity/fidelity

24



## Group 3, Number 13, cont'd



- capture of variability in procedures
  - changes in roles, responsibilities
- relevance
- accurate reflection of airline's business case
- non normal operations
- human factors representation
- clear statement of scenario objective

25



## Group 3, Number 14



- v How do we insure the appropriate testing of the concepts that include only one domain v. those that are gate-to-gate?
- v Testing concepts
  - allow for variability
  - arrival of common domain definition, architecture, interface definition
  - appropriate integration of concepts
  - definition of boundary conditions and constraints
  - single domain impact on gate to gate scenario
  - concept invariant metrics for comparison of different architectural premises
- v Open Issues
  - how to handle incompatible concept/system architectural issues?
  - how do we know we've tested enough
    - how do we know we've tested the "right" things

26



## Group 3, Number 15



- ∨ **Since we will have multiple scenarios, how do we insure some comparability between them so we can test some single domain v. gate-to-gate concepts fairly?**
- ∨ **Scenario comparability issues**
  - **Metrics need a common framework to evaluate scenarios (and concepts)**
    - **Configuration management**
    - **Information necessary to verify scenarios is required**
  - **Assume following are true**
    - **scenarios facilitate the blending process**
    - **scenarios are for validation**
    - **scenarios are for evaluation**



# Technical Interchange Meeting Guidelines Breakout

Rob Fong  
VAMS Project  
May 22, 2002  
Ames Research Center

## Overview

- VAMS concept developers are required to describe their concepts in a common framework
  - Guidelines
  - GFI Model of ATM Functions Model
  - Operational Needs Statement Model
- Purpose of the guidelines:
  - to aid in the discussion of the concepts
  - to aid in the eventual blending of the concepts
  - to facilitate the modeling and simulations of concepts using VAST



## Questions to Consider

- Is the concept guideline necessary and sufficient to achieve the project goals?
- Can we achieve greater clarity on the descriptions of the guideline elements?
- Does the concept grading guidelines and procedures provide the necessary feedback to the concept development process? What clarifications are necessary? What changes might provide better feedback?

## Questions to Consider

- Can the GFI model of ATM functions be improved to account for major paradigm shifts in the operation of the ATM? Is it sufficient for the current crop of concepts?



# **VAMS TIM #1 Breakout Session #3 Guidelines**

Group 1  
Joseph Del Balzo, Facilitator  
May 23, 2002



## **Guidelines Questions to Consider**



- 1. Can we achieve greater clarity on the descriptions of the guideline elements?**
- 2. Are the concept guidelines sufficient and necessary to meet project goals?**



**1. Can we achieve greater clarity on the descriptions of the guideline elements?**



- v **Yes, but we suggest a change in the order**
  - **Area 1**
    - **Issues and operating domain (concept specific)**
    - **Quantitative goals**
  - **Area 2**
    - **Core ideas**
    - **Assumptions**
  - **Area 3**
    - **Functions**
    - **Performance**
    - **Human factors**
      - **Roles and responsibilities of humans and machines**
      - **User interfaces**
    - **System integrity and redundancy**

May 23, 2002 - VAMS

Guidelines - Breakout Group #1

3



**1. Can we achieve greater clarity on the descriptions of the guideline elements? (Continued)**



- v **Yes, but we suggest a change in the order (Continued)**
  - **Area 4**
    - **Architecture**
    - **Technology requirements**
    - **Challenges**
    - **Transition plan**
      - **Roadmaps**
  - **Area 5 – NAS Operational Risks**
    - **Security**
    - **Safety**
  - **Area 6**
    - **Benefits/Metrics**
    - **Cost/Metrics**
    - **Conceptual competitors**

May 23, 2002 - VAMS

Guidelines - Breakout Group #1

4



## **2. Are the concept guidelines sufficient and necessary to meet project goals?**



- √ **Project goals:**
  - **Develop a blended unified concept at end of phase four**
- √ **Guidelines may be adequate**
  - **Not enough information to trade off parameters**
  - **Concepts address different aspects of NAS**
  - **Individual concepts may employ different scenarios and/or metrics**
  - **Mapping concepts to GFI helps but will not ensure blending**
  - **Difficult to fit concepts to GFI top level model**

May 23, 2002 - VAMS

Guidelines - Breakout Group #1

5



## **Concept Grading Guidelines and Procedures**



- 1. Does the concept grading guidelines and procedures provide the necessary feedback to the concept development process?**
- 2. What clarifications are necessary?**

May 23, 2002 - VAMS

Guidelines - Breakout Group #1

6



**1. Does the concept grading guidelines and procedures provide the necessary feedback to the concept development process?**



**Yes**



**2. What clarifications are necessary?**



**Nothin'**



- 1. Can the GFI model of ATM functions be improved to account for major paradigm shifts in the operation of the ATM?**
- 2. Is the GFI model sufficient to blend, model and analyze and assess the current collection of concepts? What more is needed?**



- 1. *Can the GFI model of ATM functions be improved to account for major paradigm shifts in the operation of the ATM?***

- v Cannot answer until after we know what the paradigm shifts are going to occur**





**2. Is the GFI model sufficient to blend, model and analyze  
and assess the current collection of concepts?  
What more is needed?**



- v **No**
  - Not domain specific
  - Concepts do not always map cleanly/clearly into it
  - Need lower level models (May be more difficult to map)
  - Already busy
  - Does not describe the operational concepts behind concept
  - Does not help present/explain/describe concept
  - After the concept is developed, you could organize it this way
    - Helps simulation but does not help define concept
  - Will not help blend
- v **More is needed**
  - After year one we will have a better idea how to schematically communicate ideas in a common framework

May 23, 2002 - VAMS

Guidelines - Breakout Group #1

11



**Three Most Important Points**



- v **Better outline of operational guidelines  
(reordered)**
- v **Cannot determine if concept description  
per guidelines is adequate for blending  
until after year one**
- v **After year one we will have a better idea  
how to schematically communicate  
ideas in a common framework**

May 23, 2002 - VAMS

Guidelines - Breakout Group #1

12



## **VAMS TIM #1 Breakout Session #3 Guidelines**

Group 2  
Kevin Corker, Facilitator  
May 23, 2002



**Can the GFI model of ATM functions be improved to account for major paradigm shifts in the operation of the ATM?**



### **LACKS:**

- ✓ **Airports as a dedicated aggregate**
- ✓ **Domains of transportation system**
- ✓ **Utility increase with intermodal considerations (Transportation System – Air, ground, quantum)**
- ✓ **Passenger/Payload missing from model**
- ✓ **Higher Level of Abstraction for Information Function**
- ✓ **Allocation**
- ✓ **Quantification**
- ✓ **Demand Function**



### OPCON Compatibility by function (high level)

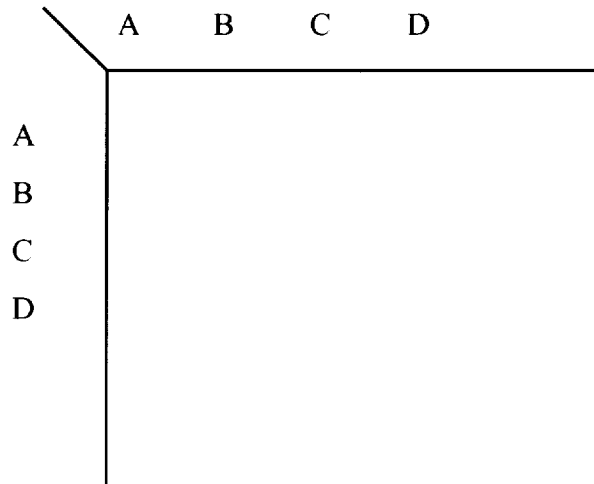

### OPCON Compatibility by function (Low level)

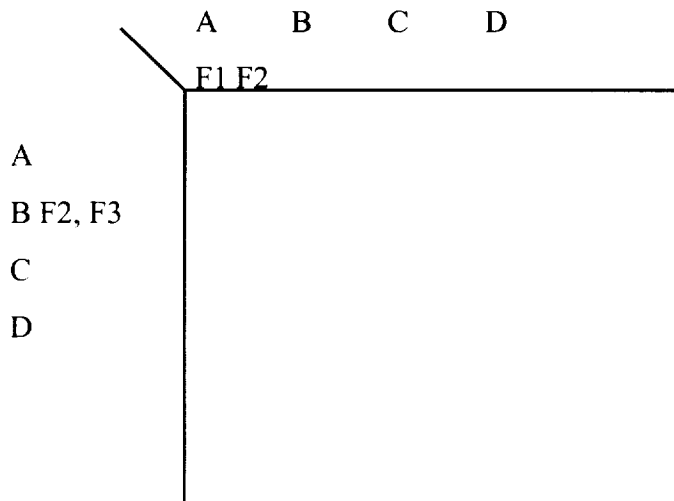



Is the GFI model sufficient to blend, model and analyze  
and assess the current collection of concepts?  
What more is needed?



- v **Yes, but needs further decomposition**

**Matrix/Vector Compatibility within each function**

**Differentiate tools from OPCONs to support cross  
OPCON evaluation**



Does the concept grading guidelines and procedures provide the  
necessary feedback to the concept development process?  
What needs to be clarified?



**Set of standards for grading needed to level the playing field**

- v **Combination of criteria to assessment**
  - WHAT IS THE PROCESS, WHAT FORM IS THE FUNCTION,
  - Is there weighting ?

**Needs clarification**

- v **Practical**
- v **Definable**
- v **Self- Diagnostic**
- v **Constructible**
- v **Documented**
- v **Revolutionary**
- v **Accurate**
- v **Compatible**
- v **Model-able**



## Eval Criteria (cont.)



- v **Should not be on list as applicable to an OPCON**
- v **Constructible**
- v **Compatible (with what ???)**
- v **Accuracy**



## Is the concept guideline necessary and sufficient to achieve the project goals?



- v **Lacks explicitly defined compatibility link**
- v **Goodness may subsume costs & benefits**



## **VAMS TIM #1 Breakout Session #3 Guidelines**

Group 3  
Earl Van Landingham, Facilitator  
May 23, 2002



## **Group 3 Agenda, 6 Questions in 3 Categories**



√ **Guidelines:**

- Can we achieve greater clarity on the descriptions of the guideline elements
- Are the concept guidelines sufficient and necessary to meet project goals?

√ **Concept Grading Guidelines and Procedures:**

- Does the concept grading guidelines and procedures provide the necessary feedback to the concept development process?
- What clarifications are necessary?

√ **GFI Model of ATM Functions:**

- Can the GFI model of ATM functions be improved to account for major paradigm shifts in the operation of the ATM?
- Is the GFI model sufficient to blend, model and analyze and assess the current collection of concepts? What more is needed?



## Guidelines



- v **Can we achieve greater clarity on the descriptions of the guideline elements**
  - Probably
  - Functions in element (area) 2 for the top-level description isn't followed through in the detail area (element 3)
  - GFI functional model too constraining
  - Need better set of definitions (VAMS Terminology)
    - Sector overload, capacity, throughput, demand, delay, etc.
    - In element (area) 6, Conceptual Competitors is another term that needs clarification
      - is this like the price of fuel going so high or some breakthrough in telecommuting lowering the demand for flying?
      - What is NASA's intent for the information on the "conceptual competitors"?

May 23, 2002 - VAMS

Guidelines - Breakout Group #1

23



## Guidelines



- v **Are the concept guidelines sufficient and necessary to meet project goals?**
  - Yes, they're necessary. For now, they're sufficient, but this needs to be reviewed as project evolves.
  - Need editing of guideline elements for priority
    - Group feels that the importance of political, legal aspects should be higher
    - Area 3 "Human Factors" should be "Human Performance"
    - Area 4 "Architecture" should be lower
    - Area 6 "Conceptual Competitors" should probably be lower. Maybe this should be Area 1, "Issues"
    - Prioritization should be a "living" attribute through life of program

May 23, 2002 - VAMS

Guidelines - Breakout Group #1

24



## Concept Grading Guidelines and Procedures



- v **Does the concept grading guidelines and procedures provide the necessary feedback to the concept development process?**
  - Maybe, with the clarifications, below
- v **What clarifications are necessary?**
  - We assume that these are the evaluation criteria on p3 of handouts
    - Need more explicit mapping of concept guidelines to the evaluation criteria
    - Need definition of criteria



## GFI Model of ATM Functions



- v **Can the GFI model of ATM functions be improved to account for major paradigm shifts in the operation of the ATM?**
  - Yes
  - Seems disconnected from VAST architecture
    - Should we drive deeper in GFI model or VAST architecture?
    - Need better understanding of VAST architecture
    - Is there a plan for convergence?
  - Model needs to accommodate drawing of domain boundaries
- v **Is the GFI model sufficient to blend, model and analyze and assess the current collection of concepts? What more is needed?**
  - Need a hierarchically decomposed model with more details
  - Blending needs other things, too.
    - Common scenario definitions
    - Comparison of assumptions
    - Analysis of incompatibilities, unions, intersections, and synergisms



# **Airspace Systems Program**

## **Socio-Economic and Demand Forecasting**

**John A. Cavolowsky**  
Assistant Director  
Airspace Systems Program

March 23, 2002

1

### **Objective**

- ◆ The NASA Aeronautics research program has increased its emphasis on ATM technologies in response to heightened national needs. (VAMS)
- ◆ NASA is considering programs to develop technologies for an advanced NAS.
- ◆ However, it is necessary to have a solid understanding of the broader economic environment in which those technologies will operate.
- ◆ A more complete understanding of the potential environments in which NASA research will operate enables solutions that are robust under a wide variety of conditions.

2

## Problem Definition

- ◆ In order to develop a research program that will provide demonstrable benefits to taxpayers, travelers, and industry, the Airspace Systems (AS) program needs to understand how national economic conditions, demographic trends, and other factors affect the Nation's need for transportation, and air transportation in particular.
- ◆ This includes the traditional factors (such as price, population, GDP, and demographics - as well as new security concerns) and how they will affect the need for NASA sponsored research.

3

## Study Approach

- ◆ The focus of this study will be to develop an understanding of the role of transportation in general and air transportation in particular within the U.S. economy, the major determinants of the demand for air transportation, and how an intermodal perspective may affect our understanding of air travel demand.
- ◆ The principal mechanism for developing this understanding will be the definition of a set of operational-level scenarios that depict the potential future environment for the global air transportation system. These scenarios will include economic conditions, security considerations, airport and airspace capacity, and the global political environment.
- ◆ More detailed descriptions of the impacts of these operational-level scenarios will be developed, in terms of their effects on air travel demand volume and its distribution.

4

## Supporting Organizations

- ◆ LMI
- ◆ GRA
- ◆ Volpe National Transportation Systems Center
- ◆ Affiliated consultants and universities

*Currently engaged in a 6-month effort*

5

## Develop Transportation Scenarios

***The Future is Uncertain.  
Technology lead times can be long.  
Conditions are likely to change.***

- ◆ Identify driving forces
- ◆ Determine their potential variation
- ◆ Create scenarios spanning the variables
- ◆ Examine the resulting scenarios and select a subset for detailed study
- ◆ Study system trends for the selected scenarios, evaluate costs, and assess risk factors

***Limited resources must be allocated to areas that are most likely to achieve success in scenarios with the greatest probability of being realized.***

6

## Limits and Uncertainties

- ◆ **Focus on a limited number (4 to 6) of highly plausible operational scenarios rather than attempt to address every possible scenario.**
  - When selecting the scenarios for detailed study, care will be given to generate a variety of orthogonal scenario variables.
- ◆ **Forecasting the future becomes increasingly hard as the time horizon is extended.**
  - Consequently, we will focus on a 20 year forecast (i.e. 2022)

7

## Three Part Effort

- ◆ **Describe** the current state of knowledge on the relationship between transportation and the economy and how that affects the NASA airspace systems research program.
- ◆ **Review** the previous scenarios to include those developed for NASA by the National Research Council ("Scenario-Based Strategic Planning for NASA's Aeronautics Enterprise"), and revise, update, and expand them as required to reflect current and future conditions.
- ◆ **Develop** a set of demand forecasts, incorporating both aggregate travel volumes and its distribution among airport-pairs and air vehicles, for each of the defined scenarios. Develop a schedule of commercial and GA flights for each of the scenarios.

8

## Activity One

- ◆ **Conduct literature search of past studies:**
  - **Generate insights into the interdependence of the broad economic environment, the role of transportation, and NASA's airspace systems research**
- ◆ **Examine usage of air transportation by sectors of the economy:**
  - **Identify sectors that are largest users of passenger and cargo air transportation**
  - **Identify sectors that are particularly dependent on air transportation in terms of input costs**

9

## Air Transport and the Economy

- ◆ **Catalog and assess existing models:**
  - **ASAC Air Carrier Investments Model (ACIM)**
  - **ASAC Air Carrier Cost-Benefit Model (CBM)**
  - **National Aeronautics Cost-Benefit Analysis Model (NACBA)**
  - **Population and employment demographic models**
  - **Mode choice models**
  - **Economic impact models**
  - **others**
- ◆ **Identify strengths and weaknesses of economic models and their measures:**
  - **Measures that appeal to technical audiences (e.g. CBO, GAO, OMB, etc.)**
  - **Measures for lay audiences**

10

## Activity Two

- ◆ Review external aviation forecasts
- ◆ Develop market segments of interest
- ◆ Identify demand drivers
- ◆ Identify supply issues
- ◆ Align demand with scenarios
- ◆ Input to Activity 3

11

## Review External Aviation Market Forecasts

*What are the smart people saying?*

- ◆ Boeing
- ◆ Airbus
- ◆ FAA
- ◆ IATA
- ◆ ICAO-FESG (Finance and Economic Sub-Group)
- ◆ Others

*Forecasts ranging in scope from 10 to 50 years*

12

## Aircraft Market Segments

- ◆ **Regional**
  - GA
  - Rotary
  - Turbo Prop
  - RJ
- ◆ **Mainline**
  - 100, 150, 200, 300, 400+ seat
  - Conventional subsonic
  - High speed subsonic
- ◆ **All cargo**
- ◆ **other**

13

## Demand Drivers

- ◆ **Economic growth**
- ◆ **Full price of travel:**
  - Access and travel times
  - Access and travel costs
  - Access and travel schedule availability
  - Relative attractiveness of competing modes

14

## Supply Issues

- ◆ Congestion/delay
- ◆ Security/risk perceptions
- ◆ Security time and money costs
- ◆ Fuel costs
- ◆ Air navigation service/airport charges (high fixed cost)

15

## Align Demand to Scenarios

- ◆ Travel market segments:
  - Domestic/international
  - Business/vacation/visit friends and relatives
  - Cargo/passenger
  - Scheduled/on-demand
  - others
- ◆ Scenario issues
  - Passenger growth
  - Cargo growth
  - Environmental limits
  - Fuel price shocks
  - World tensions
  - others

16



## Activity 3: Axes of Interest

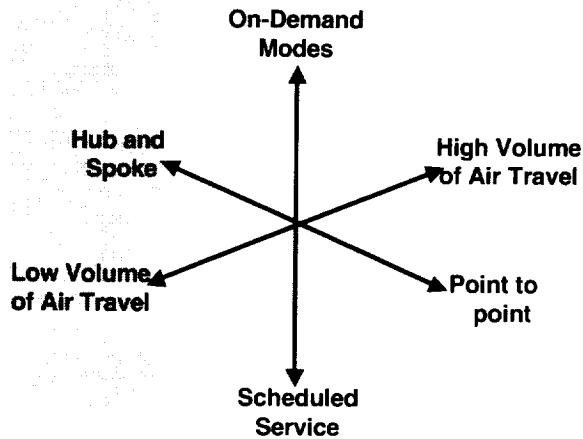

### Parameter Definitions

- ◆ Volume of Air Travel is a function of overall health of economy, demographic trends, security issues, and relative attractiveness of competing surface modes.
- ◆ Scheduled versus On-Demand attribute measures the degree to which scheduled air carriers satisfy air travel demand versus GA, SATS, etc.
- ◆ Hub and Spoke versus Point to Point attribute measures the degree to which passengers travel directly from their true origin to their true destination.

17

## Traffic Schedule Inputs

- ◆ **Commercial traffic:**
  - Time-of-day patterns for both airports and O&D markets and the simulated airline operation strategies for schedule generation
- ◆ **GA:**
  - Based on SATS modeling work
  - Terminal operation forecast, distance profile, and the gravity model for the O&D demand
- ◆ **Cargo**
  - TBD

18

## Outputs from Activity Three

- ◆ **A set of airport demand forecasts for each of the scenarios defined under activity two:**
  - Commercial flights by airport-pair
  - GA flights by airport-pair
  - Cargo flights by airport-pair

19

## Follow-on Activities

- ◆ **Identify institutional factors and societal concerns affecting changes in the aviation system**
- ◆ **Identify inhibitors to system improvements**

20

- **Planning on August 27-29, 2002**
- **Technical Presentations and discussions on developing VAST capabilities**
- **Airspace Concept Evaluation System**
  - Build 1 Requirements
- **Real-Time Human-In-The-Loop System**
  - Preliminary Design
  - Validation Experiment Description
- **Human and Team Modeling**
  - Approach to Human Performance Modeling
- **CNS Modeling**
  - Approach to CNS Modeling and Assessments
- **Scenarios and Metrics**
  - Common Scenario Set

This page intentionally left blank.

This page intentionally left blank.

**REPORT DOCUMENTATION PAGE**

Form Approved  
OMB No. 0704-0188

The public reporting burden for this collection of information is estimated to average 1 hour per response, including the time for reviewing instructions, searching existing data sources, gathering and maintaining the data needed, and completing and reviewing the collection of information. Send comments regarding this burden estimate or any other aspect of this collection of information, including suggestions for reducing this burden, to Department of Defense, Washington Headquarters Services, Directorate for Information Operations and Reports (0704-0188), 1215 Jefferson Davis Highway, Suite 1204, Arlington, VA 22202-4302. Respondents should be aware that notwithstanding any other provision of law, no person shall be subject to any penalty for failing to comply with a collection of information if it does not display a currently valid OMB control number.

**PLEASE DO NOT RETURN YOUR FORM TO THE ABOVE ADDRESS.**

<b>1. REPORT DATE (DD-MM-YYYY)</b> 31-07-2002			<b>2. REPORT TYPE</b> Conference Publication		<b>3. DATES COVERED (From - To)</b> May 21-23, 2002	
<b>4. TITLE AND SUBTITLE</b> Virtual Airspace Modeling and Simulation Project First Technical Interchange Meeting					<b>5a. CONTRACT NUMBER</b>	
					<b>5b. GRANT NUMBER</b>	
					<b>5c. PROGRAM ELEMENT NUMBER</b>	
<b>6. AUTHOR(S)</b> Prepared by Computer Science Corporation (Recording Secretaries: Robert Beard, Richard Kersten, Robert Kille, Paul Rigterink, and Henry Sielski) Edited by Melinda Gratteau, Raytheon ITSS					<b>5d. PROJECT NUMBER</b> WBS 4.0	
					<b>5e. TASK NUMBER</b> TIM-1	
					<b>5f. WORK UNIT NUMBER</b> RTOP 727-04	
<b>7. PERFORMING ORGANIZATION NAME(S) AND ADDRESS(ES)</b> Ames Research Center, MS 210-8, Moffett Field, CA 94035-1000; Computer Science Corporation, 550 Weddell Drive, Suite 7, Sunnyvale, CA 94089; Raytheon ITSS, NASA Ames Research Center, MS 210-8, Moffett Field, CA 94035-1000					<b>8. PERFORMING ORGANIZATION REPORT NUMBER</b>  A-0208373	
<b>9. SPONSORING/MONITORING AGENCY NAME(S) AND ADDRESS(ES)</b> National Aeronautics and Space Administration Washington, DC 20546-0001					<b>10. SPONSORING/MONITOR'S ACRONYM(S)</b>	
					<b>11. SPONSORING/MONITORING REPORT NUMBER</b> NASA/CP--2002-211845	
<b>12. DISTRIBUTION/AVAILABILITY STATEMENT</b> Unclassified -- Unlimited Subject Category 03 Distribution: Standard Availability: NASA CASI (301) 621-0390						
<b>13. SUPPLEMENTARY NOTES</b> Points of Contact: Robert K. Fong, (650) 604-3779 or Harry N. Swenson, (650) 604-5469, Mail Stop and 210-8, Ames Research Center, Moffett Field, CA 94035-1000						
<b>14. ABSTRACT</b> A three-day NASA Virtual Airspace and Modeling Project (VAMS) Technical Interchange Meeting (TIM) was held at the NASA Ames Research Center in Mountain View, CA, on May 21 through May 23, 2002. The purpose of this meeting was to share initial concept information sponsored by the VAMS Project. An overall goal of the VAMS Project is to develop validated, blended, robust and transition-able air transportation system concepts over the next five years that will achieve NASA's long-term Enterprise Aviation Capacity goals. This document describes the presentations at the TIM, their related questions and answers, and presents the TIM recommendations.						
<b>15. SUBJECT TERMS</b> Air traffic management, Air traffic control, Capacity						
<b>16. SECURITY CLASSIFICATION OF:</b>			<b>17. LIMITATION OF ABSTRACT</b>	<b>18. NUMBER OF PAGES</b>	<b>19a. NAME OF RESPONSIBLE PERSON</b>	
<b>a. REPORT</b>	<b>b. ABSTRACT</b>	<b>c. THIS PAGE</b>			<b>19b. TELEPHONE NUMBER (Include area code)</b>	
Unclassified	Unclassified			335		



