

NASA/TM—2003-212484



# Atomic Oxygen Effects on Spacecraft Materials

Bruce A. Banks, Sharon K.R. Miller, and Kim K. de Groh  
Glenn Research Center, Cleveland, Ohio

Rikako Demko  
Cleveland State University, Cleveland, Ohio

## The NASA STI Program Office . . . in Profile

Since its founding, NASA has been dedicated to the advancement of aeronautics and space science. The NASA Scientific and Technical Information (STI) Program Office plays a key part in helping NASA maintain this important role.

The NASA STI Program Office is operated by Langley Research Center, the Lead Center for NASA's scientific and technical information. The NASA STI Program Office provides access to the NASA STI Database, the largest collection of aeronautical and space science STI in the world. The Program Office is also NASA's institutional mechanism for disseminating the results of its research and development activities. These results are published by NASA in the NASA STI Report Series, which includes the following report types:

- **TECHNICAL PUBLICATION.** Reports of completed research or a major significant phase of research that present the results of NASA programs and include extensive data or theoretical analysis. Includes compilations of significant scientific and technical data and information deemed to be of continuing reference value. NASA's counterpart of peer-reviewed formal professional papers but has less stringent limitations on manuscript length and extent of graphic presentations.
- **TECHNICAL MEMORANDUM.** Scientific and technical findings that are preliminary or of specialized interest, e.g., quick release reports, working papers, and bibliographies that contain minimal annotation. Does not contain extensive analysis.
- **CONTRACTOR REPORT.** Scientific and technical findings by NASA-sponsored contractors and grantees.

- **CONFERENCE PUBLICATION.** Collected papers from scientific and technical conferences, symposia, seminars, or other meetings sponsored or cosponsored by NASA.
- **SPECIAL PUBLICATION.** Scientific, technical, or historical information from NASA programs, projects, and missions, often concerned with subjects having substantial public interest.
- **TECHNICAL TRANSLATION.** English-language translations of foreign scientific and technical material pertinent to NASA's mission.

Specialized services that complement the STI Program Office's diverse offerings include creating custom thesauri, building customized databases, organizing and publishing research results . . . even providing videos.

For more information about the NASA STI Program Office, see the following:

- Access the NASA STI Program Home Page at <http://www.sti.nasa.gov>
- E-mail your question via the Internet to [help@sti.nasa.gov](mailto:help@sti.nasa.gov)
- Fax your question to the NASA Access Help Desk at 301-621-0134
- Telephone the NASA Access Help Desk at 301-621-0390
- Write to:  
NASA Access Help Desk  
NASA Center for Aerospace Information  
7121 Standard Drive  
Hanover, MD 21076

NASA/TM—2003-212484



# Atomic Oxygen Effects on Spacecraft Materials

Bruce A. Banks, Sharon K.R. Miller, and Kim K. de Groh  
Glenn Research Center, Cleveland, Ohio

Rikako Demko  
Cleveland State University, Cleveland, Ohio

Prepared for the  
Ninth International Symposium on Materials in a Space Environment  
cosponsored by the European Space Agency (ESA), Centre National d'Etudes Spatiales (CNES),  
and the Office National d'Etudes et de Recherches Aérospatiales (ONERA)  
Noordwijk, The Netherlands, June 16–20, 2003

National Aeronautics and  
Space Administration

Glenn Research Center

---

June 2003

Available from

NASA Center for Aerospace Information  
7121 Standard Drive  
Hanover, MD 21076

National Technical Information Service  
5285 Port Royal Road  
Springfield, VA 22100

Available electronically at <http://gltrs.grc.nasa.gov>

# ATOMIC OXYGEN EFFECTS ON SPACECRAFT MATERIALS

Bruce A. Banks,<sup>1</sup> Sharon K. R. Miller,<sup>1</sup> Kim K. de Groh,<sup>1</sup> and Rikako Demko<sup>2</sup>

<sup>1</sup>NASA Glenn Research Center, 21000 Brookpark Road, Cleveland, Ohio 44135, USA  
E-mail: Bruce.A.Banks@nasa.gov, Sharon.K.Miller@nasa.gov, Kim.K.deGroh@nasa.gov

<sup>2</sup>Cleveland State University, Cleveland, Ohio 44115–2440, USA  
E-mail: Rikako.Demko@grc.nasa.gov

## ABSTRACT

Low Earth orbital (LEO) atomic oxygen cannot only erode the external surfaces of polymers on spacecraft, but can cause degradation of surfaces internal to components on the spacecraft where openings to the space environment exist. Although atomic oxygen attack on internal or interior surfaces may not have direct exposure to the LEO atomic oxygen flux, scattered impingement can have serious degradation effects where sensitive interior surfaces are present. The effects of atomic oxygen erosion of polymers interior to an aperture on a spacecraft is simulated using Monte Carlo computational techniques. A 2-dimensional model is used to provide quantitative indications of the attenuation of atomic oxygen flux as a function of distance into a parallel walled cavity. The degree of erosion relative is compared between the various interior locations and the external surface of an LEO spacecraft.

## 1. INTRODUCTION

The effects of atomic oxygen on the external surfaces of low Earth orbital (LEO) spacecraft have long been a significant problem that can have dire consequences on the durability of spacecraft. As a result, considerable efforts have been undertaken to prevent or minimize materials degradation due to direct atomic oxygen attack [1–4]. Most of these efforts have focused on the effects of LEO atomic oxygen on the external surfaces of spacecraft. Such atomic oxygen interactions can also cause degradation of interior surfaces when openings in components on the spacecraft exterior exist that allow the entry of atomic oxygen into regions that may not have direct atomic oxygen attack but rather scattered attack. Such openings can exist because of spacecraft venting, microwave cavities, and apertures for: earth viewing, sun sensors or star trackers. Sensitive surfaces, materials or components that are connected or slightly exposed to the outside environment by means of tubes, ducts or other openings that can allow atomic oxygen to reach them in a scattered and attenuated manner and still cause oxidation. For example, the interior surfaces in open microwave cavities that are

coated with silver for high surface electrical conductivity purposes could be oxidized, over time, as a result of scattered atomic oxygen entrance into the cavities. The silver oxidation would compromise the performance of the microwave cavity. To be able to know the degree of degradation, with time, of the performance of such a microwave cavity, one needs to be able to understand the reduction in effectiveness of the atomic oxygen reaction with depth into the cavity and use that information along with known rates of oxidation at higher fluxes to project oxidation rates deep within a cavity.

Prediction of the attenuation of the oxidizing effects of the atomic oxygen flux can be reasonably achieved through the use of Monte Carlo computational modeling. A two-dimensional Monte Carlo model has been developed which has been used for such predictions [5–7]. The model allows the atomic oxygen arrival direction, Maxwell Boltzman temperature, and ram energy to be varied along with the interaction parameters of degree of recombination upon impact with polymer or non-reactive surfaces, initial reaction probability, reaction probability dependence upon energy and angle-of-attack, degree of specularly of scattering of reactive and non-reactive surfaces, and degree of thermal accommodation upon impact with reactive and non-reactive surfaces to be varied to allow the model to produce atomic oxygen erosion geometries that replicate actual experimental results from space. This paper uses a 2-dimensional Monte Carlo model to provide quantitative indications of the degree of attenuation of atomic oxygen reaction as a function of distance into a parallel walled cavity. The relative erosion caused by atomic oxygen is compared between the various interior locations and locations at the external surface of an LEO spacecraft to allow spacecraft designers an indication of the level of threat sensitive interior surfaces may see for various geometries. Although the Monte Carlo model is 2-dimensional, it can also be used to provide qualitative information concerning spacecraft openings that are 3-dimensional by offering reasonable insight as to the nature of attenuation of damage that occurs within an LEO spacecraft.

## 2. PROCEDURE

A Monte Carlo computational model was used in which a crack opening to the LEO atomic oxygen environment exists. It allows the atomic oxygen to be entered into the cavities (or in trenches for case of the two dimensional model) at an arbitrary angle-of-attack. Its reaction, scattering, recombination processes and erosion effects are predicted using interaction parameters whose values have been set to cause the predicted undercutting erosion patterns at crack defect sites in polymers to match those witnessed on actual space exposed samples on the Long Duration Exposure Facility (LDEF). The relative erosion was calculated as the ratio of Monte Carlo atoms that react with Kapton H at a specific location within the crack defect relative to the number of atoms that would react if Kapton H was placed at the top surface of the defect. The relative erosion was used to measure the effects of atomic oxygen flux attenuation rather than counting atom arrival to avoid errors associated with scattered atoms that are partially accommodated and have reduced probability of reaction. The relative erosion was measured by counting and computing the ratio of the number of Monte Carlo atoms that react at the two locations. Because the Monte Carlo modeling process is random and statistical variations in results occur, typically 20 or more runs were averaged to plot each data point.

## 3. RESULTS AND DISCUSSION

### 3.1 Computational Modeling Comparison with Space Results

The Monte Carlo atomic oxygen interaction parameters were optimized to allow the model to replicate the shape of an undercut cavity from a sample of 0.125 mm thick Kapton H which had a crack in a vacuum-deposited aluminumized (1000 Angstroms thick) coating on the space exposed surface as shown in Fig. 1. The sample had been exposed on LDEF to an atomic oxygen fluence of  $7.15 \times 10^{21}$  atoms/cm<sup>2</sup> arriving at an angle of 38.1° from normal incidence. Photographs taken as retrieved from LDEF (Fig. 1(a)), after chemical removal of the aluminum coating (Fig. 1(b)) and at a tilted condition to view the depth of the undercutting (Fig. 1(c)) indicated that the crack geometry used to determine the atomic oxygen interaction parameters had a crack width of 0.939 microns, a top surface undercut cavity width of 5.26 microns and a vertical depth of 27.7 microns. Table 1 lists the resulting atomic oxygen interaction parameters that produced an atomic oxygen undercut cavity that most closely replicated the actual in-space LDEF results shown in Fig. 1(a) to 1(c). The Table 1 atomic oxygen interaction parameters were then used

for all the computational modeling in this paper. Insight as to the ability of the Monte Carlo computational model to replicate results of actual LEO exposure of materials can be seen by comparison of the scanning electron microscope photograph of LDEF space results shown in Fig. 1(c) with the Monte Carlo modeling (using the parameters of Table 1) at a crack defect site in a thin film (1000 Angstrom) aluminum coating protective coating on Kapton H polyimide. As can be seen in the upper left portion of the undercut cavity, for both the flight results and Monte Carlo model, there is evidence of localized additional erosion due to atomic oxygen that is scattered from the right edge of the protective coating at the top of the crack. To produce the profile shown in Fig. 1(b), a total of 181,124 model atoms were impinged upon the crack in the protective coating. Each Monte Carlo cell was a square measuring 0.1 micron on each side.

### 3.2 Attenuation of Atomic Oxygen Erosion within 2-Dimensional Openings in a Spacecraft

The relative erosion within a 2-dimensional opening or cavity in a spacecraft depends upon the ratio of width of the opening to the distance down into the opening. For non-normal atomic oxygen incidence, the atomic oxygen flux incident upon each of the cavity walls will not be equal near the space exposed end of the cavity and will depend upon the angle-of-attack which is measured as the angle between the arrival direction and the normal to the space exposed surface. For, the case of atomic oxygen arriving at a 45° angle-of-attack, the relative erosion depends upon whether the surface in question is on the direct or indirect impingement side of the cavity. Figure 2 shows a plot of the atomic oxygen erosion on the sides of a cavity relative to the top surface of the cavity as a function of distance down into the cavity for the geometry shown in Fig. 1(a). The model assumes non-reactive wall materials with the interaction characteristics of SiO<sub>2</sub> (except in the test area which is assumed to be Kapton) and no bottom to the cavity. As one can see, the erosive effects are reduced by over two orders of magnitude for depths of over 10 cavity-widths. This reduction in erosion rate is due to a combination of attrition of the number of atomic oxygen atoms that arrive deep in to the cavity (due to wall recombination and scattering out the entrance) as well as their reduction in probability of reaction due to thermal accommodation as they change from 4.5 eV in impact energy to a small fraction of one electron volt with thermal accommodation.

There are also large differences in relative erosion near the surface depending upon which side of the cavity is receiving direct impingement at the entrance. With increasing depth, the erosion differences between the two sides diminish, as one would expect. For the side

of the cavity that only receives indirect atomic oxygen attack, the relative erosion actually increases for a short distance into the cavity because the flux of scattered atoms that arrives from the opposing wall increases for a short distance as one moves down into the cavity.

Figure 3 shows the atomic oxygen erosion on the sides of a cavity relative to the top surface of the cavity as a function of angle-of-attack for the fixed distance of five defect-widths down into the cavity. As can be seen at angles of attack near zero, a large flux enters the cavity as expected but differences in relative erosion between the sides at high angles of attack are not as great as would be expected near the surface of the cavity. This is due to the divergence of the incoming atomic oxygen due to the assumed 1000 K Maxwell Boltzman thermal distribution and the variation in impact angles due to orbital inclination consequences.

If one has sweeping atomic oxygen attack such as would occur in an LEO spacecraft component that is solar tracking, then only the depth into the cavity plays a role because both cavity walls will receive the same average flux. Figure 4 shows the attenuation in relative erosion as a function of depth-to-width ratio of the cavity.

If one examines the erosion rate of a Kapton bottom of a well relative to the erosion that would occur at the top surface of the defect, then the angle-of-attack, the depth to width ratio of the well and the atomic oxygen interactive properties of the side walls play a role in the bottom erosion rate. Figure 5 shows the relative rate of erosion of a Kapton bottom of a closed end cavity as a function of cavity depth-to-width ratio for a 45° angle-of-attack. The sides of the cavity are assumed to be non-reactive to atomic oxygen with the interaction characteristics of SiO<sub>2</sub>. As can be seen and as one would expect, a large depth to width cavity results in great attenuation in erosion somewhat similar to that of the sides of the cavity as shown in Fig. 2. However, for shallow cavities the erosion at the bottom is actually 60% greater than at the top surface for 45° angle-of-attack due to reflection and slight trapping of the arriving atomic oxygen.

Figure 6 shows the dependence of the relative erosion at the bottom of the cavity as a function of cavity depth-to-width ratio for sweeping atomic oxygen attack and assuming SiO<sub>2</sub> walls. The results are somewhat similar to the 45° angle-of-attack case but with reduced attenuation with depth because there is always some direct atomic oxygen attack at the bottom for near normal incidence.

The effect of angle-of-attack on relative erosion of the bottom can be seen in Fig. 7 where the bottom is fixed

at 10 cavity widths and the sides are assumed to be SiO<sub>2</sub>. As can be seen for near zero angle-of-attack most of the atomic oxygen flux impinges upon the bottom with the exception of divergent losses due to the hot 1000 K Maxwell-Boltzman distribution which is further broadened by orbital inclination.

One could ask if the erosion of a surface within a cavity is reduced if the cavity is large as opposed to small, so that the test surface represents a smaller fraction of the available area for atomic oxygen to react with. A second consideration would be whether to make the cavity surfaces (excluding the test surface) of a reactive or non-reactive material. Figure 8 shows the relative reactivity of the test surface at the bottom (five crack-widths deep) of a cavity as a function of cavity width-to-depth ratio for either Kapton H or SiO<sub>2</sub> surfaces (with the exception of the test surface) for 45° angle-of-attack. As can be seen, the use of reactive surfaces tends to consume scattered atomic oxygen causing a reduced erosion of the test surface at the bottom of the cavity. However, making the cavity wide actually increases erosion on the test surface for 45° angle-of-attack. It is thought that the portion of atomic oxygen that has either specular or diffuse reflection without reaction from the side walls is the contributing cause for this increase. Thus, making the cavity wide for either reactive or non-reactive walls is counter productive to reducing atomic oxygen erosion at the bottom of a cavity.

The results for sweeping atomic oxygen attack, as illustrated in Fig. 9, are slightly different because there is a brief atomic oxygen arrival configuration that will allow direct attack on the test surface. The brief configuration of direct impingement of atomic oxygen on the test surface tends to increase the overall relative erosion such that there is no width-to-depth ratio that produces great attenuation.

#### 4. CONCLUSIONS

A 2-dimensional Monte Carlo computational model was used with interaction parameters chosen to yield computational predictions that replicate observed in-space results from a sample of aluminized Kapton that had a crack in its protective coating. The computational predictions provide reasonable agreement with the observed in-space results. The atomic oxygen erosion on the walls of a 2-dimensional cavity was found to attenuate relative to the top surface of a cavity by over two orders of magnitude for depths into the cavity that are equal to ten cavity widths. Wall erosion near the surface of a cavity depends on which wall is receiving direct atomic oxygen attack. However, deep in the cavity little difference is present.

Sweeping atomic oxygen attack causes greater erosion deep in cavities due to brief periods of direct atomic oxygen attack. A wide cavity causes more erosion of a Kapton surface at its bottom than a narrow cavity for the same width opening whether or not the cavity is lined with reactive (Kapton) or non-reactive (SiO<sub>2</sub>) walls.

## 5. REFERENCES

1. Banks, B.A., Mirtich, M.J., Rutledge, S.K., and Swec, D.M., "Sputtered Coatings for Protection of Spacecraft Polymers," presented at the 11th ICMC Conference, San Diego, California, April 9–13, 1984; published in *Thin Solid Films*, 127, 1985.
2. Banks, B.A., Rutledge, S.K., Gebauer, L., and LaMoreaux, C., "SiO<sub>x</sub> Coatings for Atomic Oxygen Protection of Polyimide Kapton in Low Earth Orbit," AIAA 92–2151, presented at the Coatings Technologies for Aerospace Systems Specialist Conference, Dallas, Texas, April 16–17, 1992.
3. Banks, B.A.; Rutledge, S.K. and Cales, M., "Performance Characterization of EUREKA Retroreflectors with Fluoropolymer Filled SiO<sub>x</sub> Protective Coatings," Proceedings of the Third LDEF Post-Retrieval Symposium, NASA Langley Research Center, Williamsburg, VA, November 8–12, 1993.
4. Forkapa, M.J., Banks, B.A., Rutledge, S.K., Stidham, C.R., Ma, D., and Sechkar, E., "Atomic Oxygen Durability Testing of an International Space Station Solar Array Validation Coupon, presented at the Third International Space Conference, Toronto, Canada, April 25–26, 1996.
5. Banks, B.A., Auer, B.M., Rutledge, S.K., Gebauer, L., and Sechkar, E.A., "Monte Carlo Modeling of Atomic Oxygen Interaction with Protected Polymers for Projection of Materials Durability in Low Earth Orbit," Proceedings of the MRS 1992 Spring Meeting, San Francisco, California, April 27–May 1, 1992.
6. Banks, B.A. and Stueber, T.J., "Monte Carlo Computational Techniques for Prediction of Atomic Oxygen Erosion of Materials," presented at the NATO Advanced Research Workshop on Computer Modeling of Electronic and Atomic Processes in Solids, Wroclaw, Poland, May 20–23, 1996, published in *Computer Modeling of Electronic and Atomic Processes in Solids*, Proceedings of the NATO Workshop, edited by R.C. Tennyson and A.E. Kiv, Kluwer Academic Publishing, 1997.

7. B. Banks, T. Stueber, and M. Norris, "Monte Carlo Computational Modeling of the Energy Dependence of Atomic Oxygen Undercutting of Protected Polymers," NASA/TM—98-207423, Fourth International Space Conference, ICPMSE-4, Toronto, Canada, April 23–24, 1998.
8. Banks, B.A. and Rutledge, S.K., "Low Earth Orbital Atomic Oxygen Simulation for Materials Durability Evaluation," Proceedings of the 4th European Symposium on Spacecraft Materials in Space Environment, Toulouse, FRANCE, September 6–9, 1988.

Table 1. Computational Model Parameters and Reference Values for LEO Atomic Oxygen Interaction with Kapton®

Atomic oxygen initial impact reaction probability	0.09
Activation energy, E <sub>A</sub> , in eV for energy dependent reaction probability	0.26
Atomic oxygen probability angle of impact dependence exponent, n, in (cosθ) <sup>n</sup> angular dependence where θ is the angle between the arrival direction and the local surface normal	0.5
Probability of atomic oxygen recombination upon impact with protective coating	0.25
Probability of atomic oxygen recombination upon impact with polymer	0.35
Fractional energy loss upon impact with polymer	0.45
Fractional energy loss upon impact with protective coating	0.28
Degree of specularity as opposed to diffuse scattering of atomic oxygen upon non-reactive impact with protective coating where 1 = fully specular and 0 = fully diffuse scattering	0.45
Degree of specularity as opposed to diffuse scattering of atomic oxygen upon non-reactive impact with polymer where 1 = fully specular and 0 = fully diffuse scattering	0.035
Temperature for thermally accommodated atomic oxygen atoms, K	300
Limit of how many bounces the atomic oxygen atoms are allowed to make before an estimate of the probability of reaction is assigned	25
Thermally accommodated energy/actual atom energy for atoms assumed to be thermally accommodated	0.89
Initial atomic oxygen energy, eV	4.5
Thermospheric atomic oxygen temperature, K	1000
Atomic oxygen arrival plane relative to Earth for a Maxwell-Boltzmann atomic oxygen temperature distribution and an orbital inclination of 28.5°	Horizontal



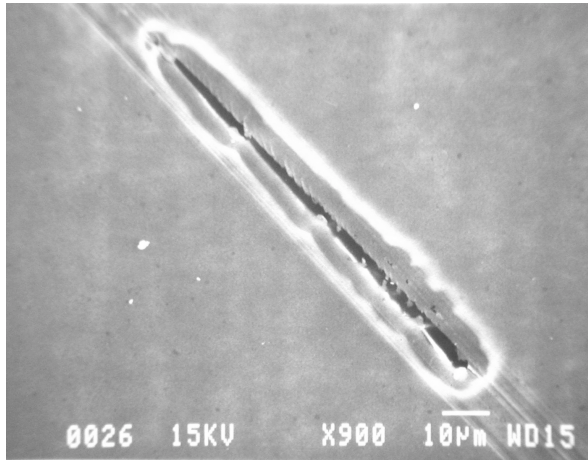

(a) Scanning electron photograph of crack in vacuum deposited aluminum coating on Kapton as retrieved from LDEF.

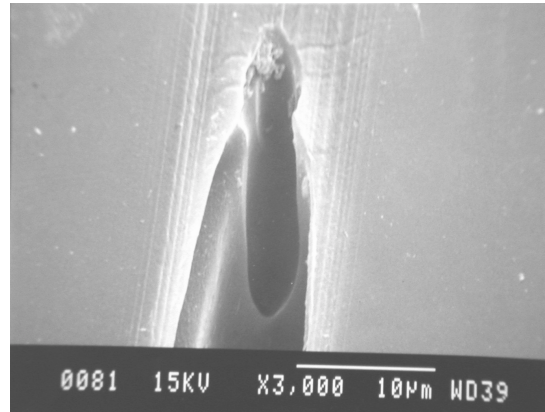

(c) Scanning electron photograph taken with surface tilted to observe the shape of the undercut cavity after removal of protective aluminum coating from the Kapton.

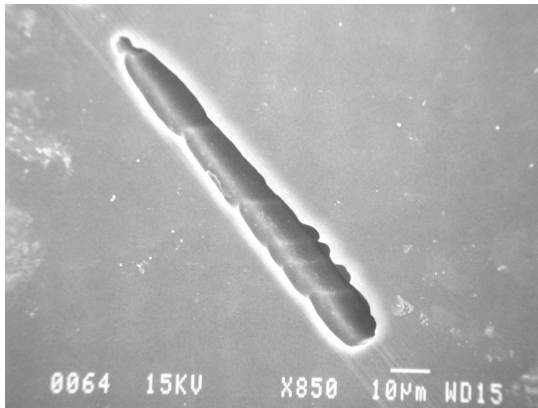

(b) Scanning electron photograph of undercut crack after removal of protective aluminum coating on Kapton.



(d) Monte Carlo model.

Figure 1. Comparison section views of LDEF space results and Monte Carlo modeling predictions (using the parameters of Table 1) at a crack defect site in aluminized Kapton.

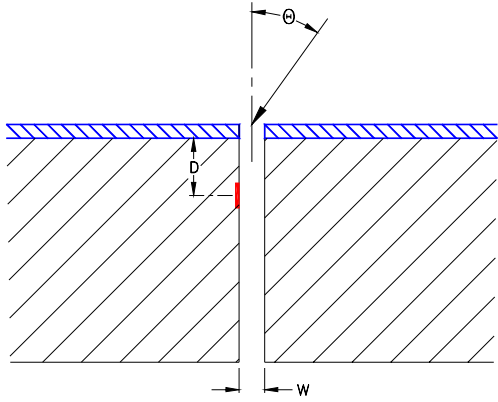

(a) Geometry of cavity for Figures 2 to 4.

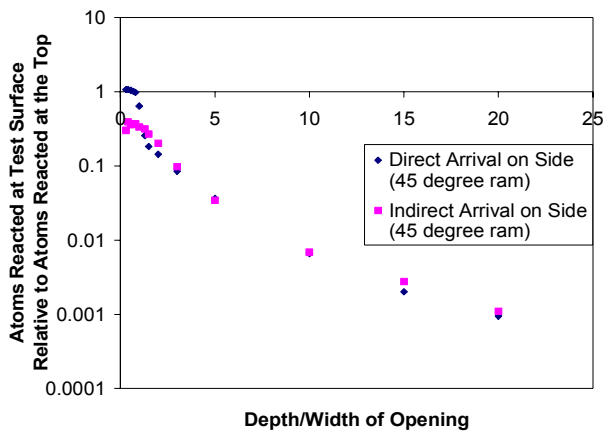

(b) Monte Carlo predictions.

Figure 2. Atomic oxygen erosion on the sides of a cavity relative to the top surface of the cavity as a function of depth/width ratio,  $D/W$ .

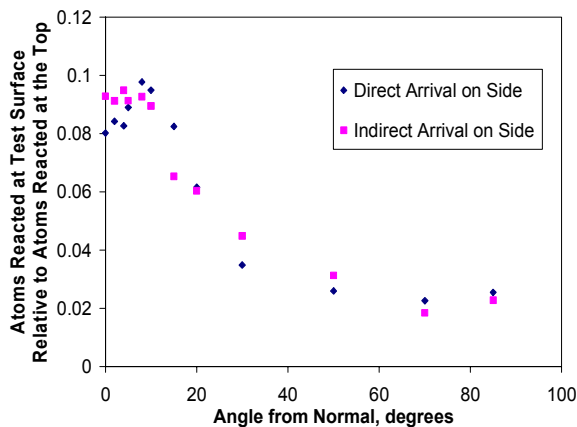

Figure 3. Atomic oxygen erosion on the sides of a cavity relative to the top surface of the cavity as a function of angle-of-attack for a distance of ten defect widths ( $D = 5W$ ) down into the cavity.

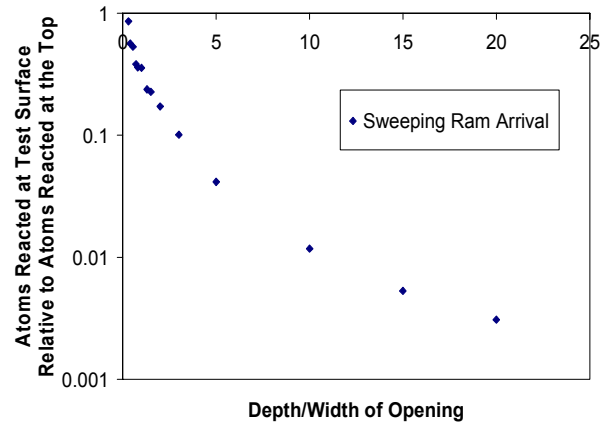
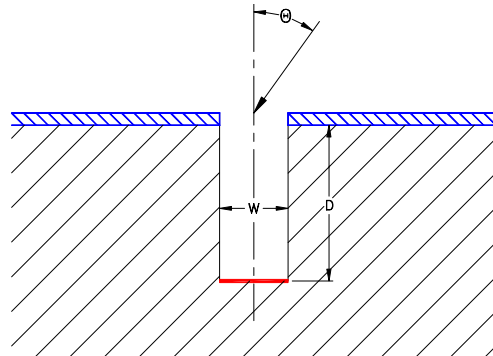
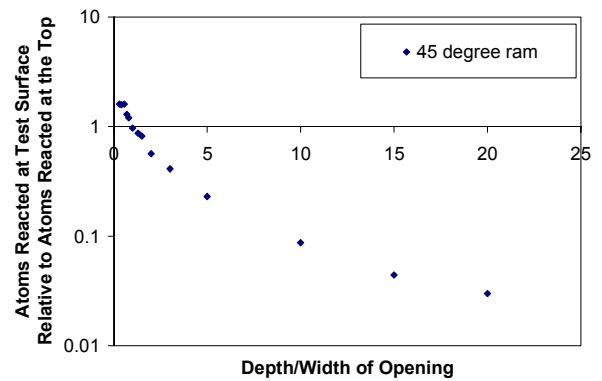

Figure 4. Attenuation in relative erosion of the cavity walls as a function of depth/width ratio,  $D/W$ , of the cavity for sweeping atomic oxygen attack.



(a) Geometry of cavity for Figures 5 to 7.



(b) Monte Carlo predictions.

Figure 5. Relative rate of erosion of a Kapton bottom of a closed-end cavity as a function of cavity depth/width ratio,  $D/W$ , for a  $45^\circ$  angle-of-attack.

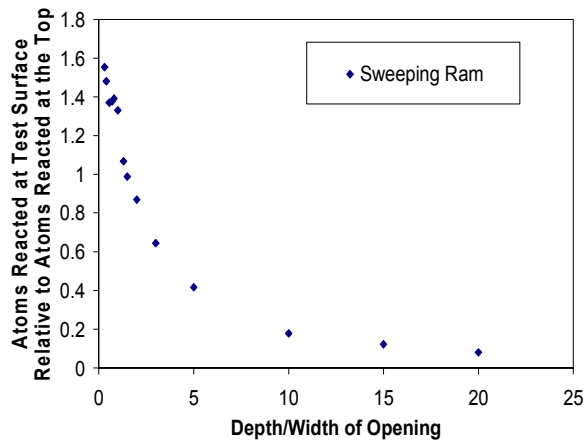

Figure 6. Dependence of relative erosion bottom of a cavity as a function of cavity depth/width ratio,  $D/W$ , for sweeping atomic oxygen attack.

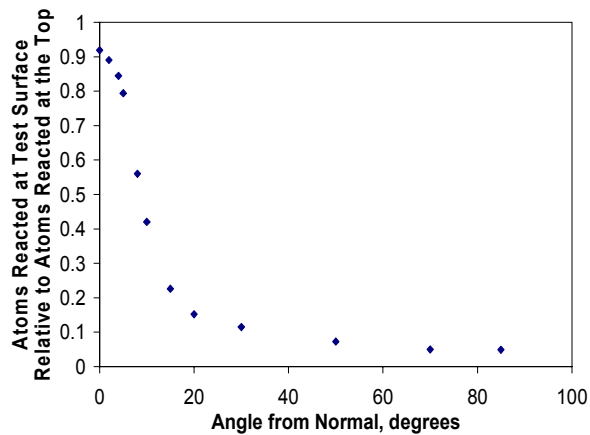
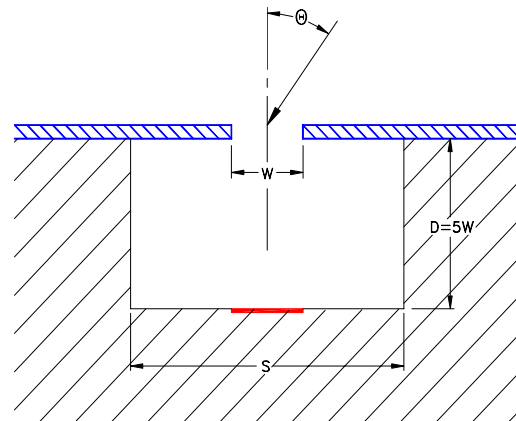
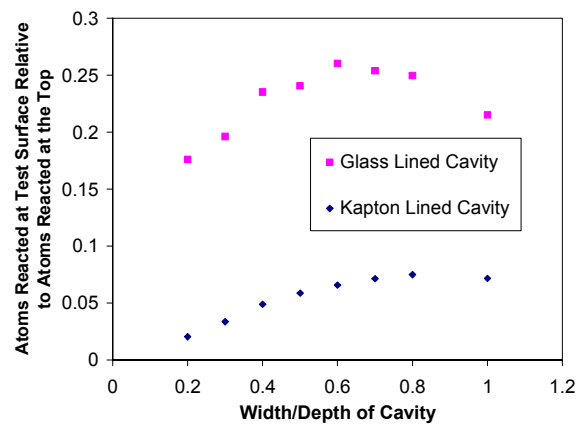

Figure 7. Influence of angle-of-attack on the relative erosion of the bottom of a cavity where the bottom is fixed at 10 cavity widths ( $D = 10 W$ ) deep.



(a) Geometry of cavity for Figures 8 and 9.



(b) Monte Carlo predictions.

Figure 8. Relative erosion of a test surface at the bottom (five crack-widths deep) of a cavity as a function of cavity width-to-depth,  $S/D$ , ratio for either Kapton H or  $\text{SiO}_2$  surfaces (with the exception of the test surface) for  $45^\circ$  angle-of-attack.

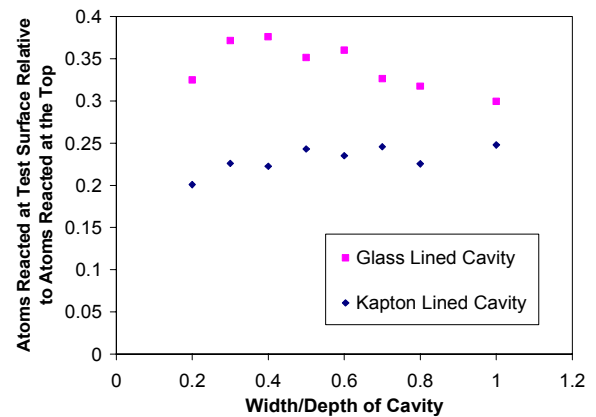

Figure 9. Relative reactivity of a test surface at the bottom (five crack-widths deep) of a cavity as a function of cavity width/depth ratio,  $S/D$ , for either Kapton H or  $\text{SiO}_2$  surfaces (with the exception of the test surface) for sweeping atomic oxygen attack.

**REPORT DOCUMENTATION PAGE**Form Approved  
OMB No. 0704-0188

Public reporting burden for this collection of information is estimated to average 1 hour per response, including the time for reviewing instructions, searching existing data sources, gathering and maintaining the data needed, and completing and reviewing the collection of information. Send comments regarding this burden estimate or any other aspect of this collection of information, including suggestions for reducing this burden, to Washington Headquarters Services, Directorate for Information Operations and Reports, 1215 Jefferson Davis Highway, Suite 1204, Arlington, VA 22202-4302, and to the Office of Management and Budget, Paperwork Reduction Project (0704-0188), Washington, DC 20503.

<b>1. AGENCY USE ONLY (Leave blank)</b>		<b>2. REPORT DATE</b> June 2003	<b>3. REPORT TYPE AND DATES COVERED</b> Technical Memorandum	
<b>4. TITLE AND SUBTITLE</b>  Atomic Oxygen Effects on Spacecraft Materials			<b>5. FUNDING NUMBERS</b>  WBS-22-755-60-05	
<b>6. AUTHOR(S)</b>  Bruce A. Banks, Sharon K.R. Miller, Kim K. de Groh, and Rikako Demko				
<b>7. PERFORMING ORGANIZATION NAME(S) AND ADDRESS(ES)</b>  National Aeronautics and Space Administration John H. Glenn Research Center at Lewis Field Cleveland, Ohio 44135-3191			<b>8. PERFORMING ORGANIZATION REPORT NUMBER</b>  E-14026	
<b>9. SPONSORING/MONITORING AGENCY NAME(S) AND ADDRESS(ES)</b>  National Aeronautics and Space Administration Washington, DC 20546-0001			<b>10. SPONSORING/MONITORING AGENCY REPORT NUMBER</b>  NASA TM-2003-212484	
<b>11. SUPPLEMENTARY NOTES</b> Prepared for the Ninth International Symposium on Materials in a Space Environment cosponsored by the European Space Agency (ESA), Centre National d'Etudes Spatiales (CNES), and the Office National d'Etudes et de Recherches Aérospatiales (ONERA), Noordwijk, The Netherlands, June 16-20, 2003. Bruce A. Banks, Sharon K.R. Miller, and Kim K. de Groh, NASA Glenn Research Center; Rikako Demko, Cleveland State University, Cleveland, Ohio 44115. Responsible person, Bruce A. Banks, organization code 5480, 216-433-2308.				
<b>12a. DISTRIBUTION/AVAILABILITY STATEMENT</b>  Unclassified - Unlimited Subject Category: 72  Available electronically at <a href="http://gltrs.grc.nasa.gov">http://gltrs.grc.nasa.gov</a> This publication is available from the NASA Center for AeroSpace Information, 301-621-0390.			<b>12b. DISTRIBUTION CODE</b>	
<b>13. ABSTRACT (Maximum 200 words)</b>  Low Earth orbital (LEO) atomic oxygen cannot only erode the external surfaces of polymers on spacecraft, but can cause degradation of surfaces internal to components on the spacecraft where openings to the space environment exist. Although atomic oxygen attack on internal or interior surfaces may not have direct exposure to the LEO atomic oxygen flux, scattered impingement can have serious degradation effects where sensitive interior surfaces are present. The effects of atomic oxygen erosion of polymers interior to an aperture on a spacecraft is simulated using Monte Carlo computational techniques. A 2-dimensional model is used to provide quantitative indications of the attenuation of atomic oxygen flux as a function of distance into a parallel walled cavity. The degree of erosion relative is compared between the various interior locations and the external surface of an LEO spacecraft.				
<b>14. SUBJECT TERMS</b>  Atomic oxygen; Low earth orbital			<b>15. NUMBER OF PAGES</b> 13	
			<b>16. PRICE CODE</b>	
<b>17. SECURITY CLASSIFICATION OF REPORT</b> Unclassified	<b>18. SECURITY CLASSIFICATION OF THIS PAGE</b> Unclassified	<b>19. SECURITY CLASSIFICATION OF ABSTRACT</b> Unclassified	<b>20. LIMITATION OF ABSTRACT</b>	