

NACA TM 1486

7985

NATIONAL ADVISORY COMMITTEE FOR AERONAUTICS

TECHNICAL MEMORANDUM 1486

STATISTICAL STUDY OF TURBULENCE - SPECTRAL FUNCTIONS
AND CORRELATION COEFFICIENTS

By Francois N. Frenkiel

Translation of "Étude statistique de la turbulence. Fonctions spectrales
et coefficients de corrélation." Office National D'Études et de
Recherches Aéronautiques (O. N. E. R. A.),
Rapport Technique No. 34, 1948.



Washington

July 1958

AFMDC
TECHNICAL LIBRARY
AF 2811

014468



TECH LIBRARY KAFB, NM



 TECHNICAL MEMORANDUM 1436

 STATISTICAL STUDY OF TURBULENCE - SPECTRAL FUNCTIONS
 AND CORRELATION COEFFICIENTS*

By Francois N. Frenkiel

INTRODUCTION

In reading the publications on turbulence of different authors, one often runs the risk of confusing the various correlation coefficients and turbulence spectra. We have made a point of defining, by appropriate concepts, the differences which exist between these functions. Besides, we introduce in the symbols a few new characteristics of turbulence. In the first chapter, we study some relations between the correlation coefficients and the different turbulence spectra. Certain relations are given by means of demonstrations which could be called intuitive rather than mathematical. In this way we demonstrate that the correlation coefficients between the simultaneous turbulent velocities at two points are identical, whether studied in Lagrange's or in Euler's system. We then consider new spectra of turbulence, obtained by study of the simultaneous velocities along a straight line of given direction. We determine some relations between these spectra and the correlation coefficients. Examining the relation between the spectrum of the turbulence measured at a fixed point and the longitudinal-correlation curve given by G. I. Taylor, we find that this equation is exact only when the coefficient

$$-\frac{L_x}{U} \sqrt{\frac{d^2 R_m(0)}{dh^2}}$$

is very small.

We find that, in a flow of homogeneous and isotropic turbulence, the transverse correlation length is equal to half the longitudinal correlation length, and we obtain several useful relations with the other characteristics of turbulence. Next, we introduce nondimensional parameters which greatly simplify the calculations. In the second chapter we view a few experimental results and study the method of representing them by empirical equations.

*"Étude statistique de la turbulence. Fonctions spectrales et coefficients de corrélation." Office National D'Études et de Recherches Aéronautiques (O.N.E.R.A.), Rapport Technique No. 34, 1948. (The publication of this report, completed in 1942, was delayed by circumstances related to the war.)

The following chapters, which form the main part of this study, provide all the possible representation of correlation and of spectrum curves; we compare with them the few measurements already made and intend to compare with them the new measurements which we hope to perform in the future. We consider therefore this part as a preface to a later report. The large number of curves will facilitate the choice of equations which will best represent the experimental points once the test results will be available.

For the representation of a correlation curve by a function, one might consider the general interpolation methods which permit, for instance, giving an approximate representation of the experimental curve by a geometrical or trigonometrical polynomial. Nevertheless, this crude method is not favorable because it disregards the typical appearance (bell-shaped curve) of the measured correlation coefficients. Several experimenters have insisted on the importance of the function $R(r) = \exp(-Kr)$ for representation of the experimental values. We have learned lately that there exist certain theoretical reasons for admitting this particular form. In fact, Professor J. Kampé de Fériet notified us at his return from his recent voyage to the United States that J. L. Doob (ref. 1) has demonstrated, with the assumption that the velocity of a particle is a function satisfying the following properties, that:

1. The stochastic process is homogeneous in time
2. This process is a Markoff¹ process
3. The law of probability of $u(t_1), u(t_2)$ is a Gauss law with two variables.

If all these conditions are realized, the correlation coefficient between the two velocities of the same particle at the instants t and $t + h$ is of the form $R(h) = \exp(-K|h|)$.

This form of the correlation curve which had already been proposed by H. L. Dryden also represents relatively satisfactorily the experimental points of the tests made recently by A. A. Kalinske (ref. 2). Thus we shall begin our representation with the study of this function. But since these conditions are not rigorously realized, it is of interest to use the functions $\exp(-K|h|)\varphi(h)$ where $\varphi(h)$ is a geometrical or trigonometrical polynomial.

Nevertheless, since the bell-shaped curve brings to mind the classical function of Gauss, we shall study this function, too. The more so,

¹That is, if one considers the instants $t_1 < t_2 < t_{n-1} < t_n$ for the given values of $u(t_1), u(t_2), u(t_{n-1})$, the distribution of $u(t_n)$ depends only on $u(t_{n-1})$:

as one sees - when one represents the second-order moment of the experimental correlation curve as a function of the first-order moment - that (fig. 6) the experimental points are dispersed between the points corresponding to the functions of the form $\exp(-K|r|)$ and $\exp(-Kr^2)$. We studied the functions $\exp(-Kr^n)$ with $1 \leq n \leq 2$, but after having made a few tests with these curves we stopped using them because they proved to be rather impractical. A fifth chapter is devoted to several applications of a series of Hermite polynomials for representing the correlation law or the spectrum according to the proposition of J. Kampé de Fériet.

We represented in numerous figures the correlation curves and the turbulence spectra which correspond to the selected functions. Several applications are made with use of the results of turbulence measurements in water and in air.

Thus one will note the good representation of a transverse correlation curve measured at the National Bureau of Standards (fig. 19) by the equation of the form

$$R_y(y) = \exp(-K_1 y) \cos(K_2 y)$$

Two other curves measured in this same laboratory (figs. 23 and 24), and also a longitudinal correlation curve of A. A. Hall (fig. 25) are very well represented by the equation $R(r) = [A + (1 - A)\cos(K_2 r)] \exp(-K_1 |r|)$. Other results (figs. 32 and 33) are represented by the function $R(r) = [1 + Ar] \exp(-K_1 |r|)$ or (figs. 37 to 42) by $R(r) = [1 + A_1 r + A_2 r^2] \exp(-K_1 |r|)$. Interesting results are given by the function $R(r) = A \exp(-K_1 |r|) + (1 - A)\exp(-K_2 |r|)$.

The functions derived from Gauss' function do not give as interesting results; still, we have been able to represent a few measurements (figs. 74 to 78) quite satisfactorily by the functions of the form $R(r) = A \exp(-K_1 r^2) + (1 - A)\exp(-K_2 r^2)$, and a correlation curve of E. G. Richardson (fig. 60) is rather well represented by a Gauss curve.

Once the correlation curve is represented by a function, it is easy to calculate the different statistical characteristics of turbulence by making use of this function. One can thus determine, for a flow of homogeneous and isotropic turbulence, the transverse correlation curve from the longitudinal correlation curve or vice versa. If the two curves have been measured in one and the same flow, it will be easy to verify whether an isotropy of turbulence exists in it. We made several comparisons

of this type. One will note particularly the rather remarkable results given in figures 33 and 57 where the experimental points are perfectly represented by the correlation functions calculated for a flow of isotropic turbulence.

Finally, we represented the spectrum of turbulence measured at the National Physical Laboratory (fig. 93) by a curve corresponding to a correlation function of the form $R_t(h) = A \exp(-K_1 h^2) + (1 - A) \exp(-K_2 h^2)$ which represents the experimental points better than the curve $R_t(h) = \exp(-K_1 |h|)$ used by H. L. Dryden.

The possibility of a rapid calculation of the spectral function, once the form of the correlation curve has been determined, is highly important since a graphical calculation based on the experimental correlation curve is extremely troublesome.

Since the work for this report has been done in 1941 and the report has been edited in 1942, we could not take into account the results found by various investigators with which we have only recently become acquainted.

SYMBOLS

1. General Symbols for Homogeneous Turbulence

<u>Oxyz</u>	reference axes fixed in space. If there exists a mean velocity, the axis <u>Ox</u> is parallel to this velocity (system of Euler).
Oxyz	reference axes fixed with respect to the center of a particle. If there exists a mean velocity, the axis <u>Ox</u> is parallel to this velocity (system of Lagrange).
t	time
h	time interval
c	cyclic frequency (equal to frequency times 2π)
$\psi(x, y, z, t)$	value of a scalar quantity at an instant <u>t</u> and at a point <u>x, y, z</u>
$\overline{\psi(x, y, z, t)}$	mean component of the quantity ψ taken with respect to the time, independently of the physical procedure employed

$\psi'(x,y,z,t)$ turbulent component of the quantity ψ

$$\overline{\psi(x,y,z,t)} = \overline{\psi(x,y,z,t)} + \overline{\psi'(x,y,z,t)}$$

$$\overline{\psi(x,y,z,t)} = \lim_{T \rightarrow \infty} \frac{1}{2T} \int_{-T}^{+T} \psi(x,y,z,s) ds$$

$$\overline{\psi'(x,y,z,t)} = 0$$

$$\lim_{T \rightarrow \infty} \frac{1}{2T} \int_{-T}^{+T} \psi(x,y,z,s) ds = \phi(x,y,z)$$

If $\phi(x,y,z) = \text{constant}$, the turbulence is homogeneous. One may assume equality between the time space averages.

$$\lim_{T \rightarrow \infty} \frac{1}{2T} \int_{-T}^{+T} \psi(x,y,z,s) ds = \lim_{x \rightarrow \infty} \frac{1}{2x} \int_{-x}^{+x} \psi(s,y,z,t) ds$$

$$= \lim_{y \rightarrow \infty} \frac{1}{2y} \int_{-y}^{+y} \psi(x,s,z,t) ds$$

$$= \lim_{z \rightarrow \infty} \frac{1}{2z} \int_{-z}^{+z} \psi(x,y,s,t) ds$$

$$\overline{[\psi'(x,y,z,t)]^2}$$

mean square

$$\sqrt{\overline{[\psi'(x,y,z,t)]^2}}$$

standard deviation

$$R_K^\psi = R_{KE}^\psi = \frac{\overline{\psi'(x_1, y_1, z_1, t_1) \psi'(x_2, y_2, z_2, t_2)}}{\sqrt{[\overline{\psi'(x_1, y_1, z_1, t_1)}]^2} \sqrt{[\overline{\psi'(x_2, y_2, z_2, t_2)}]^2}} \quad \text{correlation coefficient}$$

(in the Euler system) between two fluctuation components of a scalar quantity $\psi'(x_1, y_1, z_1, t_1)$ and $\psi'(x_2, y_2, z_2, t_2)$. The subscript k depends on the relation which exists between these two quantities. For instance

$$R_X^\psi(X) = R_{XE}^\psi(X) = \frac{\overline{\psi'(0, y, z, t) \psi'(x, y, z, t)}}{\sqrt{[\overline{\psi'(0, y, z, t)}]^2} \sqrt{[\overline{\psi'(x, y, z, t)}]^2}}$$

$$L_K^\psi = L_{KE}^\psi = \int_0^\infty R_{KE}^\psi(s) ds \quad \text{correlation length in Euler's system}$$

$$f_K^\psi(\omega) = f_{KE}^\psi(\omega) \quad \text{spectrum of turbulence in Euler's system. Represents the contribution of the oscillations of cyclic frequency } \omega \text{ to the mean square}$$

$$\overline{[\psi'(x, y, z, t)]^2}$$

This spectrum may be obtained by harmonic analysis of the curve which gives $\psi'(x, y, z, t)$ as a function of one of the coordinates. The subscript k depends on the curve from which the spectrum derives.

$$\int_0^\infty f_K^\psi(s) ds = 1$$

$$R_{KL}^\psi = \frac{\overline{\psi'(X_1, Y_1, Z_1, t_1) \psi'(X_2, Y_2, Z_2, t_2)}}{\sqrt{[\overline{\psi'(X_1, Y_1, Z_1, t_1)}]^2} \sqrt{[\overline{\psi'(X_2, Y_2, Z_2, t_2)}]^2}} \quad \text{in the Lagrange system}$$

between two fluctuation components of a scalar quantity $\psi'(X_1, Y_1, Z_1, t_1)$ and $\psi'(X_2, Y_2, Z_2, t_2)$. The subscript k depends on the relation existing between these two quantities.

$L_{KL}^{\psi} = \int_0^{\infty} R_{KL}^{\psi}(s) ds$ correlation length in Lagrange's system

$f_{KL}^{\psi}(\omega)$ spectrum of turbulence in Lagrange's system. Represents the contribution of the oscillations of cyclic frequency ω to the mean square

$$\overline{[\psi'(X,Y,Z,t)]^2}$$

This spectrum may be obtained by harmonic analysis of the curve which gives $\psi'(X,Y,Z,t)$ as a function of one of the coordinates. The subscript k depends on the curve from which the spectrum

derives. $\int_0^{\infty} f_{KL}^{\psi}(s) ds = 1$

2. Symbols for the Study of the Statistical Relations

Between the Parallel Velocities

- V instantaneous velocity
- u, v, w components of the instantaneous velocity
- $\left. \begin{array}{l} \bar{u} = U \\ \bar{v} = 0 \\ \bar{w} = 0 \end{array} \right\}$ mean velocity of the flow
- V' turbulent velocity
- $\left. \begin{array}{l} u' = u - \bar{u} \\ v' = v \\ w' = w \end{array} \right\}$ components of the turbulent velocity
- Δ direction of a straight line
- r measured distance in the direction Δ
- $\left. \begin{array}{l} v_{L} \\ v_{T} \end{array} \right\}$ components of the turbulent velocity parallel and perpendicular to the direction Δ

R correlation coefficient (see table I)

$f(\omega)$ spectrum of turbulence (see table I)

$\left. \begin{array}{l} r_0 \\ x_0 \\ y_0 \end{array} \right\}$ coordinate at which the correlation coefficients between the simultaneous velocities $R_{\Delta}(r)$, $R_x(x)$ or $R_y(y)$ become zero for the first time (fig. 2)

$$L_{\Delta}^{(ap)} = \int_0^{r_0} R_{\Delta}(s) ds$$

$$L_x^{(ap)} = \int_0^{x_0} R_x(s) ds$$

$$L_y^{(ap)} = \int_0^{y_0} R_y(s) ds$$

"apparent" correlation length represented by the area bounded by the positive part of the correlation curve measured up to the first point for which $R = 0$ (fig. 2(a))

$$x_{\Delta} = \frac{L_{\Delta}^{(ap)}}{L_{\Delta}}$$

$$x_x = \frac{L_x^{(ap)}}{L_x}$$

$$x_y = \frac{L_y^{(ap)}}{L_y}$$

ratio of "apparent" correlation length and true correlation length

$$[\overline{\omega^2}]_x = \int_0^{\infty} s^2 f_x(s) ds$$

$$[\overline{\omega^2}]_y = \int_0^{\infty} s^2 f_y(s) ds$$

$$[\overline{\omega^2}]_t = \int_0^{\infty} s^2 f_t(s) ds$$

dispersion of a turbulence spectrum

H

$$\left. \begin{array}{l} \sqrt{[\omega^2]_x} \\ \sqrt{[\omega^2]_y} \\ \sqrt{[\omega^2]_t} \end{array} \right\}$$

standard deviation of a spectrum of turbulence

λ length representing the size of the smallest eddies responsible for the energy dissipation, in the study of the simultaneous turbulent velocities, in Euler's system

λ_t time corresponding to the dimension of the smallest eddies responsible for the energy dissipation in the study of the turbulent velocity at a fixed point as a function of the time in Euler's system

Nondimensional symbols

$$\left. \begin{array}{l} \rho^L, \rho^T, \rho, \rho^V \\ \xi, \xi^V \\ \eta, \eta^V \\ \tau, \tau_m, \tau_L, \tau^V, \tau_m^V, \tau_L^V \end{array} \right\}$$

dimensionless variables obtained by dividing r , y , z , or h by the corresponding correlation length (see table I)

$$\underline{R}\left(\frac{s}{L}\right) = R(s)$$

correlation coefficient given as a function of a dimensionless variable (see table I)

Ω quantity representing the cyclic frequency in dimensionless symbols (see table I)

$\varphi(\Omega)$ turbulence spectrum in dimensionless symbols (see table I)

$$\left. \begin{array}{l} \rho_0 = \frac{r_0}{L_\Delta} \\ \xi_0 = \frac{x_0}{L_x} \\ \eta_0 = \frac{y_0}{L_y} \end{array} \right\}$$

coordinate for which the correlation coefficients $B_\Delta(r)$, $B_x(x)$, or $B_y(y)$ become zero (fig. 2(b))

$$\left. \begin{aligned} \rho^{(ap)} &= \frac{r}{L_{\Delta}^{(ap)}} \\ \xi^{(ap)} &= \frac{x}{L_x^{(ap)}} \\ \eta^{(ap)} &= \frac{y}{L_y^{(ap)}} \end{aligned} \right\}$$

length r , x , or y referred to the apparent correlation length $L_{\Delta}^{(ap)}$, $L_x^{(ap)}$, $L_y^{(ap)}$ (fig. 2)

$$\left. \begin{aligned} \rho_0^{(ap)} &= \frac{r_0}{L_{\Delta}^{(ap)}} \\ \xi_0^{(ap)} &= \frac{x_0}{L_x^{(ap)}} \\ \eta_0^{(ap)} &= \frac{y_0}{L_y^{(ap)}} \end{aligned} \right\}$$

coordinate for which the correlation coefficients R_{Δ} , R_x , or R_y given as functions of $\rho^{(ap)}$, $\xi^{(ap)}$, $\eta^{(ap)}$ become zero for the first time

$$[R_{\Delta}]_{\min}$$

minimum value of the correlation coefficient $R_{\Delta}(\rho)$

$$\rho_{\min}$$

value of ρ to which the minimum correlation coefficient corresponds when the correlation curve represents R as a function of ρ

$$[\rho^{(ap)}]_{R_{\min}}$$

value of $\rho^{(ap)}$ to which the minimum correlation coefficient corresponds when the correlation curve represents R as a function of $\rho^{(ap)}$

$$[\Phi_{\Delta}]_{\max}$$

maximum value of the spectral function $\Phi_{\Delta}(\Omega_{\Delta})$

$$[\Omega_{\Delta}]_{\Phi \max}$$

value of Ω_{Δ} for which the spectral function $\Phi_{\Delta}(\Omega_{\Delta})$ is maximum

$$\left[\overline{\Omega^2} \right]_2 = \int_0^\infty s^2 \varphi_2(s) ds$$
 dispersion of the spectrum $\varphi_2(\Omega_1)$. The subscript "1" corresponds to that of Ω_1 as a function of which the spectrum is represented, and "2" to the subscript of φ_2

$$L_\Delta^{(K)} = \int_0^\infty s^K R_\Delta(s) ds$$
 moment of order K of the area bounded by the correlation curve $R_\Delta(\rho)$

$$\left[L_\Delta^{(K)} \right]^{(ap)} = \frac{1}{\chi_\Delta^K + 1} \int_0^{\rho_0} s^K R_\Delta(s) ds$$
 moment of order K of the area bounded by the "apparent" correlation curve (up to the first value $R_\Delta(\rho) = 0$)

$$E_\Delta^{(K)} = \int_0^\infty s^K \varphi(s) ds$$
 moment of order K of the area bounded by the spectral curve $\varphi_\Delta(\Omega_\Delta)$

$$\left. \begin{aligned} l_x &= \frac{\lambda}{L_x} \\ l_y &= \frac{\lambda}{L_y} \\ l_t &= \frac{\lambda}{L_t} \end{aligned} \right\}$$
 coefficient representing the dimension of the smallest eddies responsible for the energy dissipation by turbulent viscosity

3. Miscellaneous Symbols

μ coefficient of viscosity of a fluid

Φ energy dissipated by turbulent viscosity per unit volume

K constant integer

n variable integer

s integration variable

$\left. \begin{array}{l} c \\ m \\ A \\ B \\ \alpha \\ \beta \end{array} \right\}$ coefficients used for representing the equations of the correlation curves

e base of the Napierian logarithms

$\log(a)$ logarithm with the base e

$\exp(a) = e^a$ symbol used for simplifying writing the equations

$\operatorname{erf}(a) = \frac{2}{\sqrt{\pi}} \int_0^a \exp(-s^2) ds$ numerical function the value of which is to be found in the tables

$H_{2n}(a) = \frac{(-1)^n (2n)!}{2^n n!} \left[1 - 2 \frac{n}{2!} a^2 + 2^2 \frac{n(n-1)}{4!} a^4 - \dots \right]$ Hermite polynomials

CHAPTER I

THEORETICAL CONSIDERATIONS

1. Correlation Coefficients

The study of the turbulent motion in a fluid flow requires knowledge of the amount of displacement velocities of the macroscopic particles by groups of molecules the velocity fluctuations of which present a similar appearance. One of the most important characteristics of a turbulent motion is the correlation coefficient which allows numerical definition of the similarity of the fluctuations in velocity and better visualization of the size of the macroscopic particles.

The mathematical definition of a correlation coefficient between two scalar functions of time ψ'_1 and ψ'_2 is given by the expression

$$\frac{\overline{\psi'_1(t) \psi'_2(t+h)}}{\sqrt{[\overline{\psi'_1(t)}]^2} \sqrt{[\overline{\psi'_2(t+h)}]^2}} \quad (1)$$

in which h is a time interval which may be equal to zero when the correlation between two simultaneous functions $\psi'_1(t)$, $\psi'_2(t)$ is being studied. The bars represent time averages obtained from measurements made at different instants; all other conditions are equal, though. Thus

$$\overline{\psi'_1(t)} = \lim_{T \rightarrow \infty} \frac{1}{2T} \int_{-T}^{+T} \psi'_1(s) ds$$

and

$$\overline{\psi'_1(t) \psi'_2(t+h)} = \lim_{T \rightarrow \infty} \frac{1}{2T} \int_{-T}^{+T} \psi'_1(s) \psi'_2(s+h) ds$$

In this memorandum we study only the homogeneous turbulence for which

$$\lim_{T \rightarrow \infty} \frac{1}{2T} \int_{-T}^{+T} \psi(x,y,z,s) ds = \varphi(x,y,z) = C^{te}$$

In order to simplify the study still more, we assume that the time averages are equal to the space averages, whether these latter are taken

in the entire flow domain or only along an infinite straight line of arbitrary direction. One will have for the axes Ox and Oy , in particular, the relation

$$\begin{aligned} \overline{\psi'(x,y,z,t)} &= \lim_{T \rightarrow \infty} \frac{1}{2T} \int_{-T}^{+T} \psi'(x,y,z,s) ds \\ &= \lim_{x \rightarrow \infty} \frac{1}{2x} \int_{-x}^{+x} \psi'(s,y,z,t) ds \\ &= \lim_{y \rightarrow \infty} \frac{1}{2y} \int_{-y}^{+y} \psi'(x,s,z,t) ds \end{aligned} \quad (2)$$

Thus the averages which occur in the definition of the correlation coefficient may be taken in still another manner: by repeating the measurement of $\psi'_1 \psi'_2$ at different points of the flow, all other conditions, though, being equal.

The turbulence is considered from the point of view of Euler if one studies the velocities at the flow points without concerning oneself about the particles which are situated at these points at the instant of the measurement. The turbulence is studied from the view point of Lagrange if one follows the particles in their motions and notes their velocities without concern for the location where they are placed.

(a) System of Euler.- Assume two particles A and B (fig. 3) the centers of gravity of which are, at the instant t , at the points P and Q, placed on a straight line of direction Δ , at a distance r . The mean velocity of the flow is $\bar{u} = U$, and the turbulent velocities of these particles $V'_A(t)$ and $V'_B(t)$ are equal to what we call abbreviatedly velocities at the points P and Q: $V'_P(t)$ and $V'_Q(t)$. After a time interval $t_1 - t$ the particles will have left the points P and Q, after having described trajectories which depend on the joint effect of the mean velocity and of the turbulent velocities of the two particles. At the instant t_1 two other particles C and D are to be found at the points P and Q. The velocities of the particles A and B are $V'_A(t_1)$ and $V'_B(t_1)$ and are different from the velocities at the points P and Q: $V'_P(t_1) = V'_C(t_1)$ and $V'_Q(t_1) = V'_D(t_1)$. At the instant t_2 , the particles C and D, in turn, will also have left the points P and Q, and will be replaced by two other particles: E and F.

In order to obtain in Euler's system a correlation coefficient between two simultaneous turbulent velocities, one studies the velocities at the points P and Q without considering the particles situated then at these points. This coefficient is given by the expression

$$\frac{\overline{V'_P(t)V'_Q(t)}}{\sqrt{[\overline{V'^2_P(t)}]}\sqrt{[\overline{V'^2_Q(t)}]}}$$

In order to obtain the averages which occur in this expression, one recommences the measurements at different instants. In the average $\overline{V'_P(t)V'_Q(t)}$ one will thus take into account the products $V'_P(t)V'_Q(t)$, $V'_P(t_1)V'_Q(t_1)$, $V'_P(t_2)V'_Q(t_2)$, etc.

Since the time averages are supposed to be equal to the space averages, one can obtain this correlation coefficient by another method. One makes all measurements at the same instant t and calculates the products of the turbulent velocities at numerous pairs of points placed on straight lines parallel to Δ , at distances r , such as $V'_P(t)V'_Q(t)$, $V'_R(t)V'_S(t)$, etc. These products will serve to determine the average $\overline{V'_P(t)V'_Q(t)}$. One may consider the velocities of the points situated on the same straight line as the points P and Q, or on an entirely different straight line.

Assume $V'^L_{\Delta,P}$ and $V'^L_{\Delta,Q}$ to be the components of simultaneous turbulent velocities in the direction of Δ and $V'^T_{\Delta,P}$, $V'^T_{\Delta,Q}$ the components perpendicular to Δ , located in the same plane. One will have two correlation coefficients in this Euler system (fig. 1(a)).

$$R^L_{\Delta}(r) = \frac{\overline{V'^L_{\Delta,P} V'^L_{\Delta,Q}}}{\sqrt{[\overline{V'^L_{\Delta,P}}]^2} \sqrt{[\overline{V'^L_{\Delta,Q}}]^2}} \quad R^T_{\Delta}(r) = \frac{\overline{V'^T_{\Delta,P} V'^T_{\Delta,Q}}}{\sqrt{[\overline{V'^T_{\Delta,P}}]^2} \sqrt{[\overline{V'^T_{\Delta,Q}}]^2}} \quad (3)$$

The correlation coefficients between the parallel and the perpendicular turbulent-velocity components at the points P and Q (fig. 1(b)) are given by

$$R^u_{\Delta}(r) = R_{\Delta}(r) = \frac{\overline{u'_{\Delta,P} u'_{\Delta,Q}}}{\sqrt{[\overline{u'_{\Delta,P}}]^2} \sqrt{[\overline{u'_{\Delta,Q}}]^2}} \quad R^v_{\Delta}(r) = \frac{\overline{v'_{\Delta,P} v'_{\Delta,Q}}}{\sqrt{[\overline{v'_{\Delta,P}}]^2} \sqrt{[\overline{v'_{\Delta,Q}}]^2}}$$

We call $R_{\Delta}(r)$ abbreviatedly: the correlation coefficient in the direction Δ .

If Δ coincides, in the relations (3), with the x axis, parallel to the direction of the mean velocity (fig. 1(c)), one will write

$$R_{\Delta}^L(r) = R_x^u(x) = R_x(x) \quad \text{and} \quad R_{\Delta}^T(r) = R_x^v(x) \quad (3')$$

$R_x(x)$ is the coefficient of longitudinal correlation between the longitudinal turbulent velocities, and we shall call it abbreviatedly: longitudinal-correlation coefficient. $R_x^v(x)$ is the longitudinal-correlation coefficient between the transverse turbulent velocities.

When Δ coincides with the y -axis perpendicular to the direction of the mean velocity, one has

$$R_{\Delta}^T(r) = R_y^u(y) = R_y(y) \quad \text{and} \quad R_{\Delta}^L(r) = R_y^v(y) \quad (3'')$$

where $R_y(y)$ is the transverse-correlation coefficient between the longitudinal turbulent velocities - we shall call it transverse-correlation coefficient - and $R_y^v(y)$ represents the coefficient of transverse correlation between the transverse velocities.

One may define, in Euler's system, a correlation coefficient between the turbulent velocities at the same point but at two instants t and $t + h$. This coefficient is given by the expression

$$\frac{\overline{V'_p(t)V'_p(t+h)}}{\sqrt{[\overline{V'_p(t)}]^2} \sqrt{[\overline{V'_p(t+h)}]^2}}$$

One obtains the averages by varying the initial instant t . In the average $\overline{V'_p(t)V'_p(t+h)}$ one will thus take into account the products $V'_p(t)V'_p(t+h)$, $V'_p(t_1)V'_p(t_1+h)$. Applying equation (2), one may form the means by measuring the velocities at two instants t and $t+h$ only, but taking the measurements for an infinite number of points. In this case the products $\overline{V'_p(t)V'_p(t+h)}$, $\overline{V'_q(t)V'_q(t+h)}$, etc. would occur in the calculation of $\overline{V'_p(t)V'_p(t+h)}$.

Studying the correlation between the components of the turbulent velocities parallel to the direction of the mean velocity, we shall have

$$R_t(h) = \frac{\overline{u'(x,y,z,t) u'(x,y,z,t+h)}}{\sqrt{[u'(x,y,z,t)]^2} \sqrt{[u'(x,y,z,t+h)]^2}} \quad (4)$$

which we shall call abbreviatedly: correlation coefficient at a fixed point. For the components perpendicular to the direction of the mean velocity, one will have the coefficient $R_t^V(h)$.

The correlation coefficient (4) has been studied by taking a point fixed with respect to space. One may also determine a correlation coefficient for a point being displaced with the mean velocity of the flow, and one will have

$$R_m(h) = \frac{\overline{u'(x,y,z,t) u'(x+Uh,y,z,t+h)}}{\sqrt{[u'(x,y,z,t)]^2} \sqrt{[u'(x+Uh,y,z,t+h)]^2}} \quad (5)$$

This coefficient, as also the correlation coefficient $R_m^V(h)$ between the transverse components, appertains to a pseudo-Eulerian system.

(b) System of Lagrange.— Let us now study the correlation coefficients of Lagrange's system. Assume $O\Delta_1\Delta_2\Delta_3$ to be the coordinate axes the origin of which is constantly located at the center of gravity of the particle A and which are situated so that the axis $O\Delta_1$ is always parallel to the direction Δ . The correlation coefficient of the Lagrange system between the simultaneous turbulent velocities of two particles placed on a straight line in the direction Δ , at a distance r , will be

$$\frac{\overline{V'_A(0,0,0,t) V'(\alpha r, \beta r, \gamma r, t)}}{\sqrt{[V'_A(0,0,0,t)]^2} \sqrt{[V'(\alpha r, \beta r, \gamma r, t)]^2}}$$

where α , β , γ are the direction cosines of the straight line Δ .

In the average $\overline{V'_\Delta(0,0,0,t) V'(\alpha r, \beta r, \gamma r, t)}$ products like $V'_A(t) V'_B(t)$, $V'_A(t_1) V'_G(t_1)$, $V'_A(t_1) V'_H(t_1)$, etc. will occur. With the assumption that the averages with respect to time are equal to the averages one would obtain if one made an infinite number of measurements at the same instant t ,

which amounts to supposing the existence of an ergodic principle, one may obtain $\overline{V'_A(0,0,0,t)V'(\alpha r,\beta r,\gamma r,t)}$ in another manner: one takes the averages of the products of turbulent velocities of pairs of particles placed, at the instant t , on straight lines of direction Δ and at distances r so that, for instance, $V'_A(t)V'_B(t)$, $V'_K(t)V'_L(t)$, etc. One now has the equalities $V'_A(t)V'_B(t) = V'_P(t)V'_Q(t)$ and $V'_K(t)V'_L(t) = V'_R(t)V'_S(t)$. Consequently, the correlation coefficient between the simultaneous turbulent velocities of the particles placed on a straight line in the direction Δ and at distances r is obtained in the same manner as the correlation coefficient between the simultaneous turbulent velocities at the points placed on a straight line of the same direction and situated at the same distance. When the turbulence is homogeneous, the correlation coefficients between the simultaneous turbulent velocities for a given direction and distance are the same, whether the study is made in Euler's or in Lagrange's system.

$$R_{\Delta,E}(r) = R_{\Delta,L}(r) \quad (6)$$

The correlation coefficient between the turbulent velocities of the same particle is given by the expression

$$\frac{\overline{V'_A(t)V'_A(t+h)}}{\sqrt{[\overline{V'_A(t)}]^2} \sqrt{[\overline{V'_A(t+h)}]^2}}$$

where the average is taken by varying the initial instant t . Therefore, the products $V'_A(t)V'_A(t+h)$, $V'_A(t_1)V'_A(t_1+h)$, among others, will occur in $\overline{V'_A(t)V'_A(t+h)}$. This correlation coefficient may be obtained also by studying the turbulent velocities of an infinite number of particles at two instants t and $t+h$ only. The average $\overline{V'_A(t)V'_A(t+h)}$ will then be calculated with the products $V'_A(t)V'_A(t+h)$, $V'_B(t)V'_B(t+h)$, etc. Thus, if one has the equality $V'_A(t)V'_A(t+h) = V'_P(t)V'_P(t+h)$, one will, on the other hand, have in general the inequality $V'_B(t)V'_B(t+h) \neq V'_Q(t)V'_Q(t+h)$. Consequently, the correlation coefficient between the turbulent velocities at a fixed point (system of Euler) and the correlation coefficient between the turbulent velocities of the same particle (system of Lagrange) for the same time interval are not necessarily equal when the turbulence is homogeneous.

The correlation coefficient between the components (parallel to the direction of the mean velocity) of the turbulent velocities of the same particle A, at two instants t and $t + h$, will be equal to

$$R_{tL}^u(h) = R_{tL}^u(h) = \frac{\overline{u'_A(t)u'_A(t+h)}}{\sqrt{[u'_A(t)]^2} \sqrt{[u'_A(t+h)]^2}} \quad (7)$$

and we shall call it abbreviatedly correlation coefficient in the Lagrange system. The analogous correlation coefficient between the components perpendicular to the direction of the mean velocity will be designated by $R_{tL}^v(h)$.

(c) Homogeneous and isotropic turbulence.- In the preceding section we have assumed that the turbulence is homogeneous, that is, that a translation of the axes does not produce a change in the value of the averages. If one assumes furthermore that the turbulence is isotropic, a rotation of the axes will not have any effect, either, on the value of the averages. Hence there result the equalities

$$R_x^v = R_y^v \quad R_y^v = R_x^v \quad (8)$$

2. Spectra of Turbulence

The turbulent energy of a fluid medium may be considered as the sum of the energy of simple harmonic vibrations of different frequencies. The character of the turbulence will be completely defined if one knows the total turbulent energy and the proportion of energy corresponding to every frequency, that is to say, the spectrum of turbulence. If, in the study of a flow, the observer displaces himself with the mean velocity of the flow, it is easier to study the spectrum as the energy distribution as a function of the wave length. Every turbulent medium may have spectra peculiar to it which will not be similar to the spectra of another medium except for the particular cases where for instance the causes which produce the turbulence are similar.

One can see an analogy between the spectrum of turbulence and the spectrum of light. It must however be noted that, in the case of turbulence, the spectrum may be subject to a transformation which does not directly depend on external causes but which is due to the production of the small eddies initiated by the large ones. The spontaneous decrease in intensity of the longitudinal turbulence downstream of a grid is one of the consequences of this phenomenon.

In order to explain what the different spectra which we shall introduce in this study are representing, we shall assume availability of a measuring apparatus capable of recording the components of the turbulent velocity at every instant and simultaneously for several particles. Let one recording represent the values of the longitudinal components of the instantaneous velocities of the particles which are at a given instant situated on a straight line parallel to the direction of the mean velocity. The longitudinal spectrum of turbulence may be determined by making a harmonic analysis of such a recording. Instead of studying the distribution of the simultaneous velocities along an infinite straight line, one can take several recordings for straight lines of a length which is sufficient to make the correlation corresponding to this length negligible. For each recording, one makes a harmonic analysis and then determines the mean distribution of the longitudinal turbulent energy (proportional to $\overline{u'^2}$) which corresponds to this spectrum. Thus, the longitudinal spectrum of turbulence $f_x(\omega)$ will be obtained. By recording the longitudinal components along the straight lines located in a plane perpendicular to the direction of the mean velocity, one obtains the transverse spectrum of turbulence $f_y(\omega)$.

If one makes the harmonic analysis of a recording which represents the longitudinal component of the turbulent velocity at a fixed point as a function of the time, one obtains the spectrum of G. I. Taylor $f_t(\omega)$. These three spectra correspond to Euler's viewpoint.

The recording which gives the longitudinal component of the turbulent velocity at a point which is displaced with the mean velocity of the flow, leads to a spectrum of a pseudo-Eulerian system which we call "spectrum following the mean motion $f_m(\omega)$."

Finally, one obtains a spectrum in the Lagrange system by taking as a basis a recording which gives the fluctuations of the longitudinal component of the turbulent velocity of a particle. This spectrum will be called spectrum of J. Kampé de Fériet $f_{tL}(\omega)$.

In an analogous manner, one may obtain spectra which give the distribution of the transverse turbulent energy (proportional to $\overline{v'^2}$) by starting from the recordings which represent the fluctuations of the transverse component of the turbulent velocities. Thus, one will have the spectra which will be designated by

$$f_x^v(\omega) \quad f_y^v(\omega) \quad f_t^v(\omega) \quad f_m^v(\omega) \quad f_{tL}^v(\omega)$$

To our knowledge, the only direct measurements of spectra made so far are measurements of spectra of G. I. Taylor.

If the turbulence is homogeneous and isotropic, there correspond to the equations (8) the relations

$$f_x(\omega) = f_y^v(\omega) \quad f_y(\omega) = f_x^v(\omega) \quad (9)$$

3. Relations Between the Spectra of Turbulence and the Correlation Coefficients

In reference 5, G. I. Taylor studies the relation existing between the spectrum of turbulence measured at a fixed point and the correlation between the simultaneous longitudinal velocities at two points situated on a straight line parallel to the direction of the mean velocity (longitudinal correlation).

Assuming that the turbulent velocity is very small relative to the mean velocity (ref. 7 - equation (7)), he finds that the spectrum and the correlation are determined from one another by Fourier transform, according to the equations

$$f_t(\omega) = \frac{2}{\pi U} \int_0^{\infty} \cos\left(\frac{\omega s}{U}\right) R_x(s) ds \quad (10)$$

$$R_x(x) = \int_0^{\infty} \cos\left(\frac{s x}{U}\right) f_t(s) ds \quad (11)$$

Taylor's calculation may be applied for determining the relation between the longitudinal spectrum and the longitudinal correlation, but in this case it is not necessary to make a hypothesis concerning the magnitude of the turbulent velocity. We obtain thus equations analogous to those of Taylor

$$f_x(\omega) = \frac{2}{\pi U} \int_0^{\infty} \cos\left(\frac{\omega s}{U}\right) R_x(s) ds \quad (12)$$

$$R_x(x) = \int_0^{\infty} \cos\left(\frac{s x}{U}\right) f_x(s) ds \quad (13)$$

Likewise, one may write for the transverse spectrum and the transverse correlation the equations

$$f_y(\omega) = \frac{2}{\pi U} \int_0^{\infty} \cos\left(\frac{\omega s}{U}\right) R_y(s) ds \quad (14)$$

$$R_y(y) = \int_0^{\infty} \cos\left(\frac{sy}{U}\right) f_y(s) ds \quad (15)$$

Study of the turbulent velocities at a fixed point in space will lead to the equations

$$f_t(\omega) = \frac{2}{\pi} \int_0^{\infty} \cos(\omega s) R_t(s) ds \quad (16)$$

$$R_t(h) = \int_0^{\infty} \cos(sh) f_t(s) ds \quad (17)$$

which give the relation between the spectrum of G. I. Taylor and the correlation at the fixed point.

Comparing the experimental spectrum $f_t(\omega)$ with the one obtained by application of equation (10) to the correlation curve $R_x(x)$ (ref. 7 - fig. 1), and inversely, making the comparison between the correlation curve and the one given by equation (11) starting from the spectrum (ref. 7 - fig. 2), Taylor has found that the points calculated by Fourier transform are very satisfactorily located with respect to the curves. Applying (10) and (12), we find

$$f_t(\omega) = f_x(\omega) \quad (18)$$

and (11) and (17) give

$$R_t(h) = R_x(hU) \quad (19)$$

This comparison does not verify in general the exactness of the equations (10) and (11) as one might be tempted to believe, but only the fact that in this particular case the spectrum measured at a fixed point and the longitudinal spectrum are identical.

A. A. Kalinske and E. R. van Driest have made measurements of correlation coefficients between the transverse turbulent velocities in water (ref. 14). Comparing the correlation curve between the simultaneous velocities $R_x^V(hU)$ with the curve for a point fixed in space $R_t^V(h)$, they find that the two curves diverge more and more when h (or x) increases (fig. 4).

This is easily understandable. Thus we consider a turbulent flow of the mean velocity U . Assume two points P and Q located on a straight line parallel to the mean motion, separated by a distance x , with Q downstream of P . The correlation coefficient between the parallel components of simultaneous turbulent velocities at these two points is $R_x(x)$. We assume now that P is displaced with the mean flow. After a time interval $h = \frac{x}{U}$, the point P will be at Q . Let $R_m(h)$ be the correlation coefficient between the parallel components of the turbulent velocity at a point which is displaced with the mean velocity. The correlation at a point fixed in space (here the point Q) depends on these two correlations. If $R_m(h) = 1$, the two coefficients $R_t(h)$ and $R_x(hU)$ are equal. Since the correlation $R_m(h)$ diminishes in general when h increases, the coefficients $R_t(h)$ and $R_x(hU)$ will differ the more, the larger h will be.

The correlation curve $R_m(h)$ obtained by E. G. Richardson (ref. 16) following the mean flow of the water does not correspond, either, to the curve $R_x(x)$ (fig. 5). Although for this experiment no correlation curve at a fixed point is available, one may say with certainty that - like in the tests of Kalinske and van Driest - an important difference will exist between $R_t(h)$ and $R_x(hU)$ because $R_m(h)$ decreases appreciably even for small values of h .

For these two series of experiments made in water (refs. 15 and 16), one will thus have the inequalities

$$R_x^V(hU) \neq R_t^V(h) \quad R_x(hU) \neq R_t(h)$$

unless h is very small.

Consequently, the equations (18) and (19) which are verified for the tests studied by G. I. Taylor (ref. 7) will not be verified for these two test series. The equations (10) and (11) are therefore not exact in these cases.

One may assume that the two curves $R_x(hU)$ and $R_t(h)$ are identical when the correlation following the mean flow $R_m(h)$ remains very large up to values of $h = \frac{x}{U}$ to which corresponds a negligible correlation between the simultaneous velocities. This amounts to imposing three conditions:

(a) $R_m(h)$ must decrease very slowly, that is, the radius of curvature at the peak of the curve representing this coefficient must be very large, and the second derivative at the origin $\frac{d^2R_m(0)}{dh^2}$ must have a small absolute value.

(b) When x increases, $R_x(x)$ must become rapidly negligible so that to small values of this coefficient still correspond coefficients $R_m(h)$ of the order of unity. For the correlation curves, the negative part of which is negligible, this may be expressed by requiring that the correlation length $L_x = \int_0^\infty R_x(s)ds$ be very small.

(c) Finally, it is necessary that small values of h correspond to large values of x or, in other words, that the mean velocity is high.

Thus one will have the general condition that the coefficient

$$-\frac{L_x}{U} \sqrt{\frac{d^2R_m(0)}{dh^2}} \quad (20)$$

must be very small. The value of this coefficient could serve as a criterion of whether the equations (10) and (11) may be legitimately employed.

In the case of the tests studied in the references 5 and 12, no curves $R_m(h)$ are at disposal, and the value of (20) cannot be calculated. In contrast, it is possible to compare the values of the ratio $\frac{L_x}{U}$ which in the tests studied by Taylor varies between 0.022 and 0.005 second and is in Kalinske's and van Driest's experiments equal to 0.118 second.

Because the number of tests made is insufficient, one can only say, in an entirely arbitrary manner, that Taylor's equations may be considered exact when the ratio $\frac{L_x}{U}$ is of the order of 0.005 second, and one must expect that they will not be verified if this ratio is much larger.

Studying the turbulence from Lagrange's viewpoint, J. Kampé de Fériet has obtained (ref. 3) the relations

$$f_{tL}(\omega) = \frac{2}{\pi} \int_0^{\infty} \cos(\omega s) R_{tL}(s) ds \quad (21)$$

$$R_{tL}(h) = \int_0^{\infty} \cos(sh) f_{tL}(s) ds \quad (22)$$

which determine the correlation between the longitudinal turbulent velocities of the same particle at two instants t and $t + h$, with the initial instant t being variable.

4. Equations Capable of Representing the Laws of Correlation and the Spectral Functions

It is not possible to determine a general law for the spectral function. However, it is convenient to represent the spectral function in the form of a simple equation which evidently can be only an empirical expression. Instead of representing the spectrum by an equation, one may represent the correlation curve which can be more easily determined experimentally than the spectrum.

For representing the correlation law, the National Bureau of Standards has suggested (ref. 11) use of the relation

$$R_y(y) = \exp\left(-\frac{|y|}{L_y}\right) \quad (23)$$

J. Kampé de Fériet studies (ref. 3) a certain number of spectral functions which lead, for the correlation law among others, to the law of Gauss

$$R_{tL}(h) = \exp\left(-\frac{\pi}{4} \frac{h^2}{L_{tL}}\right) \quad (24)$$

and to a law similar to the one given in the reference 11.

$$R_{tL}(h) = \exp\left(-\frac{|h|}{L_{tL}}\right) \quad (25)$$

These laws are such that the correlation coefficient remains constantly positive. However, several experimenters obtained negative coefficients by measuring the correlation between the turbulent velocities at two points relatively far apart. This form of the correlation law is an indication of important changes in the general character of the phenomena due to turbulence, and more particularly in the turbulent diffusion. Therefore it will be useful to dispose of the correlation curves which yield negative correlation coefficients.

The correlation function $R_t(h)$ and the spectral function $f_t(\omega)$ are connected by the equation

$$R_t(h) = \int_0^{\infty} \cos(sh) f_t(s) ds \quad (17)$$

But there exists a very important difference between these two functions. Actually, it is necessary and sufficient that a function, in order to be capable of representing a spectrum, satisfies the conditions

$$f_t(\omega) \geq 0 \quad (26)$$

$$\int_0^{\infty} f_t(s) ds = 1 \quad (27)$$

In contrast, it is difficult to recognize whether $R_t(h)$ is a correlation function, that is to say, whether it is the Fourier transform of a positive function. These functions form the class of "positive definite" functions which have been the object of numerous studies, in particular of the fundamental report of S. Bochner (ref. 12). Since the criterion formed by the necessary and sufficient conditions which S. Bochner presents is not easily manageable, we are, in general, content with an examination whether the functions we intend to select satisfy the following four conditions which are necessary but not sufficient

$$-1 \leq R_t(h) \leq +1 \quad (28)$$

$$\int_0^{\infty} R_t(s) ds > 0 \quad (29)$$

$$\lim_{h \rightarrow 0} R_t(h) = 1 \quad (30)$$

$$\lim_{h \rightarrow \infty} R_t(h) = 0 \quad (31)$$

One may, moreover, require that the first derivative of the correlation function be zero for $h = 0$ which - with equation (30) taken into account - will give

$$\frac{d^2 R(0)}{dh^2} < 0 \quad (32)$$

This inequality is not verified for the functions studied in chapter III.

After having assumed a function for representing the law of correlation, one can calculate the spectral function by making a Fourier transform.

In order to determine directly the equation which can represent the spectral function, one will, beside the equations (26) and (27), also set up the conditions

$$\lim_{\omega \rightarrow 0} f_t(\omega) = \frac{2}{\pi} \int_0^{\infty} R_t(s) ds \quad (33)$$

$$\lim_{\omega \rightarrow \infty} f_t(\omega) = 0 \quad (34)$$

For each of the functions suggested for representing a correlation curve or a spectral curve, the coefficients will be limited in such a manner that these conditions will be verified.

All conditions given for the correlation law $R_t(h)$ and for the spectrum $f_t(\omega)$ can be applied also to the other spectra and correlation laws. In this case, one must replace, in the equations (26) to (34), the expressions h , $R_t(h)$, $f_t(\omega)$ by $\frac{x}{U}$, $R_x(x)$, $Uf_x(\omega)$ or by $\frac{y}{U}$, $R_y(y)$, $Uf_y(\omega)$ if the correlation between the simultaneous longitudinal turbulent velocities is studied, by h , $R_m(h)$, $f_m(\omega)$ if the turbulence along the mean flow is studied, and by h , R_{tL} , $f_{tL}(\omega)$ if the turbulence is examined from the viewpoint of Lagrange, by studying the fluctuations of velocity following the particles.

5. Theoretical Equations in a Flow of Homogeneous
and Isotropic Turbulence

Th. Kármán has demonstrated (ref. 10) that one has in a flow of homogeneous and isotropic turbulence

$$R_{\Delta}^T(r) = R_{\Delta}^L(r) + \frac{1}{2} r \frac{dR_{\Delta}^L(r)}{dr} \quad (35)$$

Applying the equations (3') and (5''), one finds

$$R_y(y) = R_x(y) + \frac{1}{2} y \frac{dR_x(y)}{dy} \quad (36)$$

where $R_x(y)$ represents the correlation law $R_x(x)$ in which the x has been replaced by y . This equation gives the relation between the longitudinal and the transverse correlation for the longitudinal turbulent velocities.

Application of the equations (3') and (3'') yields for the correlations between the transverse turbulent velocities the relation

$$R_x^V(x) = R_y^V(x) + \frac{1}{2} x \frac{dR_y^V(x)}{dx} \quad (36')$$

Integrating the differential equation with the second member (36) and calculating the integration constant by means of the condition (31), one finds the longitudinal correlation as a function of the transverse correlation

$$R_x(x) = \frac{2}{x^2} \int_0^x s R_y(s) ds \quad (37)$$

The tensor equation of Kármán (ref. 10, equation (1)) permits calculation of the correlation R_{Δ} between the longitudinal turbulent velocities at two points placed on a straight line of arbitrary direction Δ , as functions of the correlations R_x and R_y . One obtains

$$R_{\Delta}(\sqrt{x^2 + y^2}) = \frac{x^2}{x^2 + y^2} R_x(\sqrt{x^2 + y^2}) + \frac{y^2}{x^2 + y^2} R_y(\sqrt{x^2 + y^2}) \quad (38)$$

One may represent R_{Δ} as a function of the longitudinal correlation or of the transverse correlation alone, by applying the equations (36) or (37).

Equation (13) gives

$$xR_x(x) = \int_0^{\infty} \cos\left(\frac{sx}{U}\right) f_x(s) d(sx) = \int_0^{\infty} \cos\left(\frac{s}{u}\right) f_x\left(\frac{s}{x}\right) ds$$

and, taking the condition (30) into account, one obtains

$$\lim_{x \rightarrow \infty} xR_x(x) = 0$$

As a result, one finds by integrating the two members of equation (36) the very important relation²

$$L_y = \frac{1}{2} L_x \quad (39)$$

In a flow of homogeneous and isotropic turbulence the length of the transverse correlation equals half the length of the longitudinal correlation.

In the same manner one obtains by integrating the equation (36')

$$L_x^v = \frac{1}{2} L_y^v \quad (39')$$

Replacing $R_y(s)$ in equation (14) by its value given in (36), and taking (12) into account, one finds the equation

$$f_y(\omega) = \frac{1}{2} f_x(\omega) - \frac{1}{2} \omega \frac{df_x(\omega)}{d\omega} \quad (40)$$

which gives the transverse spectrum as a function of the longitudinal spectrum for the longitudinal turbulent velocities, and applying now the equations (9), one obtains the relation between the spectra which give the distribution of the transverse turbulent energy

$$f_x^v(\omega) = \frac{1}{2} f_y^v(\omega) - \frac{1}{2} \omega \frac{df_y^v(\omega)}{d\omega} \quad (40')$$

²This report was ready for publication when we learned from the memorandum of K. Wiegardt in the Luftfahrtforschung of February 28, 1941, that this relation had already been demonstrated.

Integrating the differential equation with the second member (40) and determining the constant by the equation (33), one finds the longitudinal spectrum of turbulence, the expression

$$f_x(\omega) = 2\omega \int_{\omega}^{\infty} \frac{f_y(s)}{s^2} ds \quad (41)$$

As G. I. Taylor has shown (ref. 6), the mean energy dissipated by turbulent viscosity in the unit volume of a flow of homogeneous and isotropic turbulence is equal to

$$\bar{\phi} = 15 \frac{\overline{\mu u'^2}}{\lambda^2}$$

where λ is a length representing the dimension of the smallest eddies responsible for the dissipation. This length is linked to $R_y(y)$ by the relation

$$\frac{1}{\lambda^2} = \lim_{y \rightarrow 0} \left[\frac{1 - R_y(y)}{y^2} \right]$$

When a parabola which passes through its peak is superimposed on the transverse-correlation curve, λ is the abscissa of the point of intersection of the parabola with the y-axis.

One may also write (ref. 10) the relation

$$\frac{1}{\lambda^2} = -\frac{d^2 R_x(0)}{dx^2} = -\frac{1}{2} \frac{d^2 R_y(0)}{dy^2} \quad (42)$$

which shows that λ is equal to the radius of curvature at the peak of the longitudinal-correlation curve. In order to obtain a finite dissipated energy, the second derivative must be zero at the peak of the correlation curve.

We call the "dispersion of a curve with respect to an axis" the quotient of the second-order moment of the area bounded by that curve and the area itself. The standard deviation is equal to the square root of the dispersion. Since the area bounded by the spectral curve is equal to unity, one will have for the dispersion of the longitudinal turbulence spectrum the expression

$$\left[\overline{\omega^2} \right]_x = \int_0^{\infty} s^2 f_x(s) ds$$

and since, on the other hand (ref. 3, p. 172)

$$\frac{1}{U^2} \int_0^{\infty} s^2 f_x(s) ds = - \frac{d^2 R_x(0)}{dx^2}$$

one finds, applying equation (42), that the dimension λ is equal to the ratio of the mean velocity and the standard deviation of the longitudinal spectrum

$$\lambda = \frac{U}{\sqrt{[\omega^2]_x}} \quad (43)$$

The dimension of the smallest eddies responsible for the dissipation, referred to the longitudinal-correlation length, may be given as a function of the spectrum alone by the relation

$$\frac{\lambda}{L_x} = \frac{2}{\pi} \frac{1}{\sqrt{[\omega^2]_x} \lim_{\omega \rightarrow 0} f_x(\omega)} \quad (43')$$

Making the same calculation for the transverse spectrum, one finds the dimension λ as a function of the standard deviation of that spectrum

$$\lambda = \sqrt{2} \frac{U}{\sqrt{[\omega^2]_y}} \quad (44)$$

The equations (43) and (44) give the relation

$$[\omega^2]_y = 2 [\omega^2]_x \quad (45)$$

The dispersion of the transverse spectrum is twice the dispersion of the longitudinal spectrum when the turbulence is homogeneous and isotropic.

When one studies the correlation between the longitudinal velocities at a fixed point, one can define a quantity which is analogous to the dimension λ and is given by

$$\frac{1}{\lambda_t^2} = - \frac{d^2 R_t(0)}{dh^2} \quad (46)$$

The time λ_t is equal to the inverse standard deviation of the spectrum of G. I. Taylor

$$\lambda_t = \frac{1}{\sqrt{[\omega^2]_t}} \quad (47)$$

and referring this time to the correlation time L_t , one finds

$$\frac{\lambda_t}{L_t} = \frac{2}{\pi} \frac{1}{\sqrt{[\omega^2]_t} \lim_{\omega \rightarrow 0} f_t(\omega)} \quad (47')$$

6. Nondimensional Notations

In order to simplify the calculations and the notations, we employ, in what follows, dimensionless coefficients. We put in Euler's system

$$\rho = \frac{r}{L_\Delta} \quad \xi = \frac{r}{L_x} \quad \eta = \frac{r}{L_y} \quad \tau = \frac{h}{L_t}$$

and

$$\Omega_\Delta = \frac{\omega L_\Delta}{U} \quad \Omega_x = \frac{\omega L_x}{U} \quad \Omega_y = \frac{\omega L_y}{U} \quad \Omega_t = \omega L_t$$

The correlation coefficients between the simultaneous turbulent velocities are

$$R_\Delta(\rho) = R_\Delta(r) \quad R_x(\xi) = R_x(x) \quad R_y(\eta) = R_y(y) \quad R_t(\tau) = R_t(h)$$

and the spectral functions

$$\Phi_\Delta(\Omega_\Delta) = \frac{U f_\Delta(\omega)}{L_\Delta} \quad \Phi_x(\Omega_x) = \frac{U f_x(\omega)}{L_x} \quad \Phi_y(\Omega_y) = \frac{U f_y(\omega)}{L_y} \quad \Phi_t(\Omega_t) = \frac{f_t(\omega)}{L_t}$$

The dimension of the smallest eddies responsible for the dissipation can be referred to the longitudinal-correlation length or to the transverse-correlation length

$$l_{\Delta} = \frac{\lambda}{L_{\Delta}} \quad l_x = \frac{\lambda}{L_x} \quad l_y = \frac{\lambda}{L_y} \quad l_t = \frac{\lambda_t}{L_t}$$

In Lagrange's system one puts

$$\tau_L = \frac{h}{L_{tL}} \quad \text{and} \quad \Omega_{tL} = \omega L_{tL}$$

The correlation coefficient between the turbulent velocities of the same particle at two instants t and $t + h$ is

$$R_{tL}(\tau) = R_{tL}(h)$$

and the spectrum of J. Kampé de Fériet

$$\Phi_{tL}(\Omega_{tL}) = \frac{f_{tL}(\omega)}{L_{tL}}$$

The conditions which must be imposed so that the function represents a correlation law, are written with these notations

$$-1 \leq R_{\Delta}(\rho) \leq +1 \quad (48)$$

$$\int_0^{\infty} R_{\Delta}(s) ds = 1 \quad (49)$$

$$\lim_{\rho \rightarrow 0} R_{\Delta}(\rho) = 1 \quad (50)$$

$$\lim_{\rho \rightarrow 0} \Phi_{\Delta}(\rho) = 0 \quad (51)$$

$$\Phi_{\Delta}(\Omega_{\Delta}) \geq 0 \quad (52)$$

To obtain a finite dissipated energy, it is necessary that

$$\frac{d^2 \underline{R}_\Delta(0)}{d\rho^2} < 0 \quad (53)$$

We study, however, in chapter III, correlation laws which do not verify this last inequality as is also the case for the law given by the equation (23). We assume in these cases that the curve is approached in the region where the values of ρ are very small, that is, at the vertex of the correlation curve and that it must be rounded off there to make the first derivative zero.

In order to determine directly a function suitable for representing the spectrum, one will pose, aside from (52), the conditions

$$\int_0^\infty \varphi_\Delta(s) ds = 1 \quad (54)$$

$$\lim_{\Omega \rightarrow 0} \varphi_\Delta(\Omega_\Delta) = \frac{2}{\pi} \quad (55)$$

$$\lim_{\Omega \rightarrow \infty} \varphi_\Delta(\Omega_\Delta) = 0 \quad (56)$$

The equations (12) to (15) which determine the relation between the spectrum and the correlation law will be written with the new notations

$$\varphi_\Delta(\Omega_\Delta) = \frac{2}{\pi} \int_0^\infty \cos(\Omega_\Delta s) \underline{R}_\Delta(s) ds \quad (57)$$

$$\underline{R}_\Delta(\rho) = \int_0^\infty \cos(s\rho) \varphi_\Delta(s) ds \quad (58)$$

For a study of the longitudinal spectrum and correlation it suffices to replace ρ and Δ in the equations (48) to (58) by ξ and x ; for study of spectrum and transverse correlation, these expressions are replaced by η and y .

In the study of the homogeneous and isotropic turbulence of a flow, one may apply the equation (39) which gives

$$\eta = 2\xi \quad (59)$$

The law of transverse correlation is given as a function of the law of longitudinal correlation by the relation corresponding to (36) which is written

$$R_y(\eta) = R_x\left(\frac{1}{2}\eta\right) + \frac{1}{2}\eta \frac{dR_x\left(\frac{1}{2}\eta\right)}{d\eta} \quad (60)$$

and to the equation (37) there corresponds

$$R_x(\xi) = \frac{2}{\xi^2} \int_0^\xi s R_y(s) ds \quad (61)$$

The equation (42) gives

$$\frac{1}{l_x^2} = -\frac{d^2 R_x(0)}{d\xi^2} \quad \text{and} \quad \frac{1}{l_y^2} = -\frac{1}{2} \frac{d^2 R_y(0)}{d\eta^2} \quad (62)$$

When the turbulence is isotropic, one has $\Omega_y = 1/2\Omega_x$; consequently, the equations (40) and (41) become

$$\Phi_y(\Omega_y) = \Phi_x(2\Omega_y) - \Omega_y \frac{d\Phi_x(2\Omega_y)}{d\Omega_y} \quad (63)$$

$$\Phi_x(\Omega_x) = \frac{1}{2} \Omega_x \int_{1/2 \Omega_x}^\infty \frac{\Phi_y(s)}{s^2} ds \quad (64)$$

and represent the relation between the longitudinal spectrum and the transverse spectrum.

The equation (45) which gives the relation between the dispersions of the two spectra, will become

$$\left[\overline{\Omega_y^2}\right]_y = \frac{1}{2} \left[\overline{\Omega_x^2}\right]_x \quad (65)$$

Thus, representing the spectra in dimensionless coordinates, one finds that in a flow of homogeneous and isotropic turbulence the dispersion of the transverse spectrum equals half the dispersion of the longitudinal spectrum. Equation (65) represents the relation between the dispersions of the two spectra when the longitudinal spectrum is represented as a function of Ω_x and the transverse spectrum as a function of Ω_y . If one represents the two spectra as functions of the same variable, of Ω_x , for instance, one will have the relation

$$\left[\overline{\Omega_x^2} \right]_y = 2 \left[\overline{\Omega_x^2} \right]_x \quad (65')$$

To the equation (43) there corresponds the very simple relation

$$l_x = \frac{1}{\sqrt{\left[\overline{\Omega_x^2} \right]_x}} \quad (66)$$

which shows that the dimension of the smallest eddies referred to the longitudinal-correlation length is equal to the inverse standard deviation of the longitudinal spectrum.

If one studies the turbulence by following the particles in their motion, one determines the conditions which must be satisfied by the equations capable of representing the correlation law and the spectral function by replacing in the equations (48) to (56) ρ and Δ by τ_L and t_L . The equations (21) and (22) of J. Kampe de Fériet will be written

$$\Phi_{tL}(\Omega_{tL}) = \frac{2}{\pi} \int_0^\infty \cos(\Omega_{tL}s) R_{tL}(s) ds \quad (67)$$

$$R_{tL}(\tau_L) = \int_0^\infty \cos(s\tau_L) \Phi_{tL}(s) ds \quad (68)$$

and will have the same form as the equations (57) and (58).

CHAPTER II

METHODS USED FOR REPRESENTING THE EXPERIMENTAL CORRELATION

CURVES OR SPECTRA BY ONE EQUATION

7. Usefulness of the Representation of the Correlation

Curve and of the Spectrum by One Equation

Representation of the correlation curve by one simple equation may be very useful. Thus it is easy - when the law of longitudinal correlation between the components of simultaneous velocities is known - to calculate the law of transverse correlation for a flow of homogeneous and isotropic turbulence with the equation (60). Inversely, if the law of transverse correlation is given, one finds, with equation (61), the longitudinal correlation. The dimension λ (or l) of the smallest eddies responsible for the dissipation of energy by turbulent viscosity can be determined by (62) for all functions which have a second derivative at the origin. The greatest service the correlation equation renders is in permitting the calculation of the spectral function with the equation (57) without graphical integrations which are very time-consuming and have little accuracy.

One may use the equations representing the correlation curve for study of the diffusion phenomena and for calculation of the measurement correction with a hot wire of nonnegligible length as well as for the correction of measurements with uncompensated hot wires. Moreover, it is desirable to be able to represent the turbulence spectra or the correlation curves by equations of the same general form the coefficients of which permit a comparison between different turbulent flows.

If the spectrum is represented by an equation, the correlation law can be calculated with the equation (58). This correlation law may then be employed for other calculations.

8. Apparent Correlation Length

When one has a certain number of experimental points at disposal and wants to determine the correlation law most convenient for representation of the test results, one will if possible begin with the calculation of the correlation length by planimetric measurement of the area bounded by the curve which best represents these points. When the correlation curve is such that negative correlation coefficients exist, that is to say, when it intersects the r -axis, or when this form is considered

possible, it will then be necessary to measure the coefficients $R_{\Delta}(r)$ up to values of r sufficiently large to allow determination of L_{Δ} with sufficient accuracy. It will frequently be useful to employ, for the study of such correlation laws, what is called the "apparent" correlation length

$$L_{\Delta}^{(ap)} = \int_0^{r_0} R_{\Delta}(s) ds$$

where r_0 represents the smallest value of r for which the correlation curve intersects the axis of r (fig. 2).

Using the dimensionless coefficients, one will have

$$\chi_{\Delta} = \frac{L_{\Delta}^{(ap)}}{L_{\Delta}} = \int_0^{\rho_0} R_{\Delta}(s) ds \quad (69)$$

where ρ_0 represents the smallest value of ρ for which $R_{\Delta}(\rho)$ becomes zero. Putting

$$\rho^{(ap)} = \frac{r}{L_{\Delta}^{(ap)}} \quad \xi^{(ap)} = \frac{r}{L_{\Delta} x} \quad \eta^{(ap)} = \frac{r}{L_{\Delta} y}$$

one will have

$$\frac{\rho^{(ap)}}{\rho} = \frac{1}{\chi_{\Delta}} \quad \frac{\xi^{(ap)}}{\xi} = \frac{1}{\chi_x} \quad \frac{\eta^{(ap)}}{\eta} = \frac{1}{\chi_y} \quad (70)$$

For all correlation laws which do not give negative correlation coefficients, one will have

$$L_{\Delta}^{(ap)} = L_{\Delta} \quad \text{and} \quad \chi_{\Delta} = 1$$

9. Representation of the Experimental Results by One Equation

(a) In the following chapters we give a large number of curves which represent correlation laws of different forms. For determining the most convenient one, one will begin by constructing the experimental curve representing B as a function of ξ , η , or τ , according to the case; we will draw it to the same scale as the curves given in the present report. Superimposing on these curves the experimental curve (drawn on tracing paper), one will see quickly which one is the equation which may best represent the experimental results.

After having chosen the form of the equation, one can employ three methods for calculating its coefficients.

(α) By interpolation or by trial and error

(β) By taking as a basis the area bounded by the experimental curve, and the moments of different order of this area

(γ) When the correlation curve is represented by a polynomial, one can determine the coefficients by fixing beforehand the number of points of the experimental curve through which one will have the calculated curve pass. One will then determine the coefficients by calculating the coefficients of the polynomial.

In order to apply the method* (b), one has to calculate a certain number of moments of the area bounded by the correlation curve. Assume

$$\underline{L}_{\Delta}^{(K)} = \int_0^{\infty} s^K R_{\Delta}(s) ds \quad (71)$$

to be the moment of the order k . One will have, in particular for the area bounded by the curve

$$\underline{L}_{\Delta}^{(0)} = \int_0^{\infty} R_{\Delta}(s) ds = 1$$

the moment of the first order will be

$$\underline{L}_{\Delta}^{(1)} = \int_0^{\infty} s R_{\Delta}(s) ds$$

and the moment of the second order

$$\underline{L}_{\Delta}^{(2)} = \int_0^{\infty} s^2 R_{\Delta}(s) ds$$

After having selected the law which represents $R_{\Delta}(\rho)$, one finds by integration the equations which give $\underline{L}_{\Delta}^{(K)}$. On the other hand, one determines graphically or with a planimeter³ moments for the experimental

³Certain planimeters (for instance, the apparatus of Koradi) measure in a single operation the area, the static moment, and the moment of inertia.

Using such a device, one finds simultaneously $\underline{L}_{\Delta}^{(0)}$, $\underline{L}_{\Delta}^{(1)}$, and $\underline{L}_{\Delta}^{(2)}$.

curve. Thus one obtains $(K + 1)$ equations which permit calculation of the coefficients of the correlation law. Since the number of moments used is never infinite and since the correlation curve resulting from this calculation can frequently be different from the experimental curve, both giving the same values of $\frac{L^K}{\Delta}$, it is always necessary to verify the result.

When the correlation curve intersects the axis and one does not have at disposal measuring results up to sufficiently large values of ρ , it may be useful to employ moments of the "apparent" surface of the correlation curve

$$\left[\frac{L^K}{\Delta} \right]^{(ap)} = \frac{1}{X^{K+1}} \int_0^{\rho_0} s^K R_{\Delta}(s) ds \quad (72)$$

one will have, in particular

$$\left[\frac{L^0}{\Delta} \right]^{(ap)} = L_{\Delta}$$

(b) Measurement of the spectrum furnishes an experimental curve $f(\omega)$ as a function of ω . If the correlation length is known, the function $\varphi(\Omega)$ is easily determined. In the opposite case one can calculate it if one assumes the form of the correlation law. For this purpose one traces $f(\omega)$ as a function of ω using logarithmic coordinates, and one superimposes this curve on the curves corresponding to the selected correlation law, with consideration of the relation $\omega f(\omega) = \Omega \varphi(\Omega)$. Thus, one finds the relation between ω and Ω and hence the correlation length, and one obtains at the same time the coefficients of the correlation law, and consequently also the equation of the spectral curve.

The methods employed for representing the correlation curve by an equation may serve for finding directly the equation which can represent the spectrum. In this case one will have for the moment of the order K the expression

$$\underline{F}^K = \int_0^{\infty} s^K \varphi(s) ds \quad (73)$$

and in particular

$$\underline{F}^{(0)} = \int_0^{\infty} \varphi(s) ds = 1 \quad \underline{F}^{(2)} = \int_0^{\infty} s^2 \varphi(s) ds = \overline{\Omega^2}$$

10. Experimental Results

In table III we give a list of the experimental results on measurement of the correlation coefficients and of the turbulence spectra which will serve us in what follows for comparison with the correlation laws and with the spectral functions. Every experimental curve has a name (several letters followed by a number), and we shall indicate it in the future simply by this name. The largest number of experiments furnishes the longitudinal-correlation coefficients R_x and transverse-correlation coefficients R_y . The curves KD.1a, KD.1b give the correlation coefficients R_x^V and R_y^V between the components of the turbulent velocities perpendicular to the direction of the mean velocity. The experiment NPL.2 gives the correlation curve R_{tL}^V taken from Lagrange's viewpoint, that is, considering the transverse turbulent velocities of the same particle at two different instants. This correlation curve has not been obtained by direct measurements but by performing a calculation starting from the turbulent-diffusion tests (ref. 6, p. 473). The experiment EGR.1c furnishes the correlation R_m between the longitudinal turbulent velocities at a point which is displaced with the mean velocity of the flow. KD.1c gives the correlation R_t^V between the transverse turbulent velocities at a point fixed in space (with respect to the hydrodynamic center).

The spectra have been determined by making experiments at a point fixed in space, and concern the energy distribution of the longitudinal turbulence. Thus, one does not have at disposal either a longitudinal turbulence spectrum $f_x(\omega)$ or a spectrum $f_{tL}(\omega)$ of J. Kampé de Fériet.

In table IV we give the values of the apparent correlation length $L^{(ap)}$ and of the true correlation length L . The latter is given only for the experiments where the correlation curve intersects the abscissa axis. For the experiments NBS.2 to NBS.6, for which measurements have been made with positive and negative distances y , we calculated the correlation length by taking the average of the lengths measured for the two parts of the curve. In the same table we present also the moments of the first and of the second order of the "apparent" surface of the correlation curve. We did not calculate these moments for the experiments H.1a, 2a, 3a, 4a for which their determination with sufficient accuracy would be difficult.

Figure 6 represents $[L^{(2)}]^{(ap)}$ as a function of $[L^{(1)}]^{(ap)}$ for the correlation curves R_x and R_y . On this figure only the experimental points related to the wind-tunnel tests are given. It is found that these points can be represented rather satisfactorily by a straight line.

The points which correspond to the laws of the form $R_{\Delta}(\rho) = \exp(-|\rho|)$ and $R_{\Delta}(\rho) = \exp\left(-\frac{\pi}{4} \rho^2\right)$ are placed rather close to that straight line. It is useful to remember that in all tests made in the wind tunnels the turbulence is measured downstream of the grid.

Assuming for the experiments for which one does not find a value of the apparent correlation length $L^{(ap)} = L$, one is able to give the ratio of the longitudinal correlation length and the transverse correlation length and to verify the equation (39). These ratios are given in table V. For the experiments KD.1a, 1b we give $\frac{L_y^V}{L_x^V}$ the experimental value of which may be compared to the one given by equation (39').

In a flow of homogeneous and isotropic turbulence the values of these ratios must be equal to 2. When one studies the experimental results obtained downstream of a grid and demonstrates by the relation existing between longitudinal and transverse correlation that the turbulence is homogeneous and isotropic, one has to understand that this property is approximate and concerns only the region in which the tests have been made. One states, in fact, that the intensity of the longitudinal turbulence decreases when the distance from the grid increases.

CHAPTER III

THE CORRELATION LAWS WHICH DERIVE FROM $R_{\Delta}(\rho) = \exp(-|\rho|)$

We study in this chapter the correlation laws of the form

$$R_{\Delta}(\rho) = \left[A_0 + \sum_{n=1}^{n=K} A_n \cos(m_n c \rho) \right] \exp(-c|\rho|) \quad (74)$$

$$R_{\Delta}(\rho) = \left[1 + \sum_{n=1}^{n=K} A_n c^n |\rho|^n \right] \exp(-c|\rho|) \quad (75)$$

$$R_{\Delta}(\rho) = \sum_{n=1}^{n=K} A_n \exp(-c_n |\rho|) \quad (76)$$

For these laws, the condition $\frac{dR_{\Delta}(0)}{d\rho} = 0$ is verified only in exceptional cases; the dissipation energy is therefore generally not finite. These laws are nevertheless of interest because they are relatively simple and can frequently represent satisfactorily the experimental correlation curves. Although it is not possible to apply them to the calculation of the value of l (or of λ), they can nevertheless serve for determining the spectrum of turbulence and for the application of Th. von Karman's law in a flow of homogeneous and isotropic turbulence.

Since the aim of this study is to permit the selection of an uncomplicated equation for representation of the experimental curve, we shall examine only the simplest examples of these laws.

11. Law $R_{\Delta}(\rho) = \exp(-|\rho|)$

If one makes in the equations (74), (75) $K = 0$ and in equation (76) $K = 1$, one finds the simplest example of these laws

$$R_{\Delta}(\rho) = \exp(-|\rho|) \quad (77)$$

The use of this equation for representing the transverse correlation curve has already been proposed by the National Bureau of Standards as we have recalled in the first chapter. H. L. Dryden also has utilized it,

by analogy, for representing the longitudinal correlation, and has deduced from it the spectral function (ref. 12).

Making the Fourier transform according to (57), one finds for the spectrum of the turbulence following a straight line in the direction Δ the expression

$$\varphi_{\Delta}(\Omega_{\Delta}) = \frac{2}{\pi} \frac{1}{1 + \Omega_{\Delta}^2} \quad (78)$$

(a) Assume the longitudinal-correlation law corresponding to (77) be

$$\underline{R}_x(\xi) = \exp(-|\xi|) \quad (79)$$

In a flow of homogeneous and isotropic turbulence, one may apply the equation (60) for determining the transverse-correlation curve which will be

$$\underline{R}_y(\eta) = \left(1 - \frac{1}{4}|\eta|\right) \exp\left(-\frac{1}{2}|\eta|\right) \quad (80)$$

and which one can represent as a function of ξ , applying (59) by

$$\underline{R}_y(\xi) = \left(1 - \frac{1}{2}|\xi|\right) \exp(-|\xi|) \quad (80')$$

The correlation curve $\underline{R}_y(\eta)$ intersects the abscissa axis for the value $\eta_0 = 4$ and becomes negative for the values larger than η , passing through the minimum: $[\underline{R}_y(\eta)]_{\min} = -0.5 \exp(-3) = -0.0249$ for $\eta = 6$. Figure 7 represents the curves: $\underline{R}_x(\xi)$, $\underline{R}_y(\eta)$, and $\underline{R}_y(\xi)$.

One can give the correlation law also with the apparent correlation length as a basis. One will obtain $\chi_x = 1$ and applying equation (69) one finds: $\chi_y = 1 + \exp(-2) = 1.1353$. Taking (70) into account, one can trace \underline{R}_y as a function of $\eta^{(ap)}$. The curve which represents the longitudinal spectrum corresponding to (78)

$$\varphi_x(\Omega) = \frac{2}{\pi} \frac{1}{1 + \Omega^2} \quad (81)$$

is given in figure 8.

(b) Assuming the transverse-correlation law

$$\underline{R}_y(\eta) = \exp(-|\eta|) \quad (82)$$

one finds, in a flow of homogeneous and isotropic turbulence, the longitudinal-correlation law

$$\underline{R}_x(\xi) = \frac{1}{2\xi^2} \left[1 - (1 + 2|\xi|) \exp(-2|\xi|) \right] \quad (83)$$

which can be expressed as a function of η by the relation

$$\underline{R}_x(\eta) = \frac{2}{\eta^2} \left[1 - (1 + |\eta|) \exp(-|\eta|) \right] \quad (83')$$

The curves represented by the three last equations are given in figure 9. To the transverse-correlation law (82) there corresponds the transverse spectrum analogous to (78). In a flow of homogeneous and isotropic turbulence, one finds the longitudinal spectrum by applying equation (64). One obtains

$$\varphi_x(\Omega) = \frac{2}{\pi} \frac{\Omega}{2} \left[\frac{2}{\pi} \arctan\left(\frac{\Omega}{2}\right) - 1 \right] \quad (84)$$

The two longitudinal spectra (81) and (82) are compared in figure 8. Let us note that, by assuming the correlation law (82), one does not obtain the spectrum (81) employed by H. L. Dryden (ref. 12), but the spectrum represented by the equation (84) (when the turbulence is homogeneous and isotropic). Besides, the two spectra do not differ greatly.

(c) Comparing the transverse-correlation law (82) with the results of the experiment NBS.1, one finds (fig. 10) that the experimental points are relatively represented by the theoretical curve. A similar comparison made for the experiment NBS.7 gives a still better result (fig. 11). With the transverse-correlation law known, one can give the longitudinal correlation, for homogeneous and isotropic turbulence; it will here be determined by the relation (83). The theoretical curve and the experimental points (NBS.7a) have been drawn in the figure, for the longitudinal correlation $\underline{R}_x(\eta)$, and since the points are not placed on the curve, one can say immediately that the turbulence of the flow in which the experiments NBS.7 have been made is not homogeneous and isotropic.

12. Law

$$\underline{R}_{\Delta}(\rho) = \left[A_0 + \sum_{n=1}^{n=K} A_n \cos(m_n c \rho) \right] \exp(-c|\rho|)$$

The equation (74) may be represented in a slightly different form by replacing m_n which has an arbitrary value by integers n . One then obtains the law

$$\underline{R}_{\Delta}(\rho) = \left[\sum_{n=0}^{n=K} A_n \cos(nc\rho) \right] \exp(-c|\rho|) \quad (85)$$

which comprises a Fourier series. An application of this series will, besides, be difficult because it will require, in general, employment of a rather large number of terms. We study here only the simplest laws which have the form of the equation (74), and in the first place, the one which one obtains when $A_0 = 0$ and $K = 1$.

(a) Law $\underline{R}_{\Delta}(\rho) = \exp(-c|\rho|)\cos(m\rho)$. - To the correlation law of the form

$$\underline{R}_{\Delta}(\rho) = \exp(-c|\rho|)\cos(m\rho) \quad (86)$$

there corresponds the spectral function

$$\Phi_{\Delta}(\Omega) = \frac{c}{\pi} \left[\frac{1}{c^2 + (mc + \Omega)^2} + \frac{1}{c^2 + (mc - \Omega)^2} \right] \quad (87)$$

Integrating the equation (86) from zero to infinity, one finds

$$c = \frac{1}{m^2 + 1}$$

The spectral function is always positive. Since the equations (86) and (87) depend only on the absolute value of m , one can admit that m is always positive.

The correlation curves (fig. 12) have the form of a damped sine, the damping of which decreases with increasing m . When one has obtained an experimental correlation curve of this type, one might have difficulties in measuring its correlation length with sufficient precision and then to represent it as a function of ρ , in order to compare the experimental curve with the theoretical curves. It will be much easier to make the comparison on the basis of the apparent correlation length. The value ρ_0

for which the correlation curves intersect the ρ -axis is given by

$\rho_0 = \frac{\pi}{2mc}$. Applying equation (69), one finds the ratio of the apparent correlation length and the true correlation length which depends only on the value of the coefficient m

$$x_{\Delta} = m \exp\left(-\frac{\pi}{2m}\right) + 1$$

and which is represented in figure 15. Figure 13 gives the correlation curves as functions of $\rho^{(ap)}$. The abscissas of the intersection points of these curves with the axis of the $\rho^{(ap)}$ are represented as functions of m in figure 15. Figure 16 gives the abscissa $[\rho^{(ap)}]_{R_{\min}}$ of the minimum of the correlation coefficient as a function of m , likewise the value of this minimum

$$[\rho^{(ap)}]_{R_{\min}} = \frac{1}{X} \rho_{R_{\min}} = \frac{1}{X} \frac{1}{mc} \arctan\left(-\frac{1}{m} + \pi\right)$$

$$[R_{\Delta}(\rho)]_{\min} = \frac{m}{m^2 + 1} \exp\left[-\frac{1}{m} \arctan\left(-\frac{1}{m} + \pi\right)\right]$$

The spectral curves are represented in figure 14. These curves pass through maxima, the values of which increase with m . Figure 17 gives the value of $[\Omega_{\Delta}]_{\varphi_{\max}}$ to which corresponds the maximum of the spectral function and which one calculates by applying the relation

$$[\Omega_{\Delta}]_{\varphi_{\max}}^2 = \frac{2m\sqrt{m^2 + 1} - (m^2 + 1)}{(m^2 + 1)^2}$$

and also the value of $[\varphi_{\Delta}(\Omega_{\Delta})]_{\max}$ which one obtains by applying this relation to (87). Since Ω_{Δ} is always positive, the maximum of the spectral function corresponds to $\Omega_{\Delta} = 0$, for all values of m smaller than $\sqrt{1/3}$.

As has been said in the second chapter, the coefficients of the equation representing the correlation curve may be found by calculating the moments of different orders for the experimental curve and by comparing

them with the moments of the theoretical curve. In the actual case only one coefficient is to be determined. Also, it is sufficient to know the moment of the first order. When one represents the correlation law as a function of ρ , one finds $\frac{L}{\Delta}^{(1)} = 1 - m^2$, and by giving the curve as a function of $\rho^{(ap)}$ one obtains, applying equation (72)

$$\left[\frac{L}{\Delta}^{(1)} \right]^{(ap)} = \frac{1}{\chi^2} \left\{ \left[\frac{\pi}{2} (1 + m^2) + 2m \right] \exp\left(-\frac{\pi}{2m}\right) + (1 - m^2) \right\}$$

These two moments are given as functions of the coefficient m in figure 18.

(α) When one has, in a flow of homogeneous and isotropic turbulence, a longitudinal-correlation law of the form

$$R_x(\xi) = \exp(-c|\xi|) \cos(mc\xi) \quad (88)$$

where

$$c = \frac{1}{m^2 + 1}$$

one finds for the transverse correlation, applying the equation (60):

$$R_y(\eta) = \left[\left(1 - \frac{1}{4} c |\eta| \right) \cos\left(\frac{1}{2} mc\eta\right) - \frac{1}{4} mc |\eta| \sin\left(\frac{1}{2} mc |\eta|\right) \right] \exp\left(-\frac{1}{2} c |\eta|\right) \quad (89)$$

One can express this correlation as a function of ξ , by applying to this last equation the relation (59).

(β) When the transverse-correlation law in a flow of homogeneous and isotropic turbulence is

$$R_y(\eta) = \exp(-c|\eta|) \cos(mc\eta) \quad (90)$$

one finds with equation (61) for the longitudinal correlation

$$R_x(\xi) = \frac{1}{\xi^2} \left\{ \left[m(|\xi| + 1) \sin(2mc|\xi|) - \frac{1}{2} (2|\xi| + 1 - m^2) \cos(2mc\xi) \right] \exp(-2c|\xi|) + \frac{1}{2} (1 - m^2) \right\} \quad (91)$$

(γ) Since the points of the experiment NBS.8 are placed along a curve the shape of which recalls the curves represented in figure 13, we try to represent them by such a curve. For obtaining the coefficient m , one

takes $\left[\frac{L(1)}{L} \right]^{(ap)}$ in table IV and one finds in figure 18 $m = 0.45$. Transferring this value into equation (90), we find the correlation curve which is given as a function of $\rho^{(ap)}$ in figure 19 and which represents the experimental points quite satisfactorily.

(b) Law $R_{\Delta}(\rho) = [A_0 + A_1 \cos(m\rho)] \exp(-c|\rho|)$. - When one makes in equation (74) $K = 1$, one obtains the correlation law of the form

$$R_{\Delta}(\rho) = [A_0 + A_1 \cos(m\rho)] \exp(-c|\rho|) \quad (92)$$

The spectral function which is calculated with the equation (57) will be

$$\varphi_{\Delta}(\Omega_{\Delta}) = \frac{c}{\pi} \left\{ \frac{2A_0}{c^2 + \Omega^2} + \frac{A_1}{c^2 + (\Omega + mc)^2} + \frac{A_1}{c^2 + (\Omega - mc)^2} \right\} \quad (93)$$

For determining the coefficients of these equations, one must apply the conditions (48) and (55), and one obtains

$$A_1 = 1 - A_0 \quad \text{and} \quad c = \frac{A_0 m^2 + 1}{m^2 + 1}$$

which permits to give (92) and (93) as functions of only two coefficients. The coefficients A_0 and m cannot be arbitrary, and their values are fixed by the inequation

$$-\frac{1}{m^2} < A_0 \leq \frac{(5m^2 + 8) + \sqrt{16m^4 + 80m^2 + 64}}{9m^2}$$

The ratio of the apparent correlation length and the true correlation length is calculated with the equation (69), and one finds the relation

$$X = 1 - \frac{1}{A_0 m^2 + 1} \left[A_0 m^2 + m \frac{A_0 - 1}{\sqrt{(A_0 - 1)^2}} \sqrt{1 - 2A_0} \right] \exp(-c|\rho_0|)$$

where

$$|\rho_0| = \frac{1}{mc} \arccos \left(\frac{A_0}{A_0 - 1} \right)$$

As a consequence, the correlation curve intersects the ρ -axis only when $A_0 < 0.5$.

The correlation curve is monotonous in the interval

$$\frac{(m^2 + 1) - \sqrt{m^2 + 1}}{m^2} < A_0 < \frac{(m^2 + 1) + \sqrt{m^2 + 1}}{m^2}$$

and outside of this interval the abscissas of the maxima and the minima are given by

$$\left| \rho \frac{dR}{d\rho} = 0 \right| = \frac{1}{mc} \left[\arcsin \left(\frac{A_0}{A_0 - 1} \frac{1}{\sqrt{m^2 + 1}} \right) - \arcsin \left(\frac{1}{\sqrt{m^2 + 1}} \right) \right]$$

We give in figure 20 the value of A_0 as a function of m verifying the conditions (48) to (52). The admissible values of the coefficients A_0 and m are divided into three types:

First, the coefficients for which $\frac{dR_{\Delta}}{d\rho} \leq 0$, that is, for which the correlation curve does not present either minimum or maximum, with the curve descending continuously from 1 to 0

Second, the coefficients for which $0 \leq R_{\Delta} \leq 1$ but for which $\frac{dR_{\Delta}}{d\rho}$ can become negative so that the correlation then presents positive maxima and minima

Third, the coefficients A_0 , m for which $-1 \leq R_{\Delta} \leq 1$ which gives correlation coefficients presenting positive maxima and negative minima.

Figure 21 represents the correlation laws as functions of $\rho(ap)$ for a few values of A_0 and of m , and figure 22 gives the corresponding spectral functions. One finds again in these figures the curves already given previously since one obtains the law (77) when $A_0 = 1$, and has the equation (86) for $A_0 = 0$.

These curves permit representing the experimental results by superimposing the theoretical curves on points traced as functions of $\rho(ap)$. For trying to determine the coefficients A_0 and m , using the surface moments of the curve, it would be necessary to give the moments of the first and of the second order.

(α) When the longitudinal-correlation law is of the form

$$R_x(\xi) = [A_0 + A_1 \cos(mc|\xi|)] \exp(-c|\xi|) \quad (94)$$

one finds for the transverse correlation, in a flow of homogeneous and isotropic turbulence, the expression

$$\begin{aligned} R_y(\eta) = & \left[A_0 \left(1 - \frac{1}{4} c |\eta| \right) + A_1 \left(1 - \frac{1}{4} c |\eta| \right) \cos \left(\frac{1}{2} mc \eta \right) - \right. \\ & \left. \frac{1}{4} A_1 mc |\eta| \sin \left(\frac{1}{2} mc |\eta| \right) \right] \exp \left(-\frac{1}{2} c |\eta| \right) \end{aligned} \quad (95)$$

which can be given as a function ξ by

$$R_y(\xi) = \left(1 - \frac{1}{2} c |\xi| \right) R_x(\xi) - \frac{1}{2} A_1 mc |\xi| \exp(-c|\xi|) \sin(mc|\xi|) \quad (95')$$

(β) To the transverse-correlation law

$$R_y(\eta) = [A_0 + A_1 \cos(mc\eta)] \exp(-mc|\eta|) \quad (96)$$

there corresponds the longitudinal correlation

$$\begin{aligned} R_x(\xi) = & \frac{1}{2\xi^2} A_1 m^2 + \frac{1}{\xi^2} \left\{ A_1 (m|\xi| + 1) \sin(2mc|\xi|) - \right. \\ & \left. \frac{1}{2} (2|\xi| + 1 - m^2) \cos(2mc|\xi|) - A_0 \left(\frac{1}{2} + |\xi| \right) \right\} \exp(-2c|\xi|) \end{aligned} \quad (97)$$

which one can express as a function of η by applying the relation $\eta = 2\xi$.

(γ) Superimposing on the experimental points of the experiment NBS.1 the curves of the figure 21, one finds that one obtains a good representation when the coefficient $m = 0.5$ and when A_0 lies between 2 and 4. We determined by trial and error that the best result corresponded to $A_0 = 2.75$. Figure 23 shows that the theoretical curve represents the experimental results for this test perfectly.

Figure 24 gives the points of the experiment NBS.5 represented by the curve $m = 0.5$, $A_0 = 2$.

In figure 25 we represent the experiment H.4a by the longitudinal-correlation curve $m = 1.5$, $A_0 = 0.6$. This curve presents maxima and

minima for large values of ξ as could be predicted on the basis of figure 20. Equation (95') permits calculation of the corresponding transverse-correlation curve which represents very well the points of the experiment H.4b for the values of ξ smaller than 1.2. One may therefore assume that the flow for which the experiments H.4 have been made approximates rather closely a flow of homogeneous and isotropic turbulence.

$$13. \text{ Law } R_{\Delta}(\rho) = \left[1 + \sum_{n=1}^{n=K} A_n c^n (|\rho|)^n \right] \exp(-c|\rho|).$$

$$\text{(a) Law.- } R_{\Delta}(\rho) = \left[1 + A_1 c |\rho| \right] \exp(-c|\rho|)$$

When one makes in equation (75) $K = 1$, one finds the correlation law of the form

$$R_{\Delta}(\rho) = \left[1 + A_1 c |\rho| \right] \exp(-c|\rho|) \quad (98)$$

The corresponding spectral function is

$$\varphi_{\Delta}(\Omega) = 2 \frac{c}{\pi} \left[\frac{1}{c^2 + \Omega^2} + A_1 \frac{c^2 - \Omega^2}{(c^2 + \Omega^2)^2} \right] \quad (99)$$

By integrating the equation (98) from zero to infinity, one finds

$$c = 1 + A_1$$

and prescribing the conditions (48) to (52), one calculates that the coefficient A_1 can lie between the limits

$$-1 < A_1 \leq 1$$

The abscissa of the intersection point of the correlation curve and the ρ -axis is given by

$$|\rho_0| = -\frac{1}{A_1(1 + A_1)}$$

This shows that the curve intersects the axis only for $A_1 < 0$. One finds finally for the ratio of the apparent correlation length and of the true correlation length the expression

$$x_{\Delta} = 1 - \frac{A_1}{1 + A_1} \exp\left(\frac{1}{A_1}\right)$$

The figures 26 and 27 represent the correlation law and the spectral function for several values of the coefficient A_1 . When one uses coefficients of a value very close to -1, one must write them with a sufficient number of decimals because then the value of A_1 has a very great effect on the shape of the curves.

The minimum correlation coefficient is given by the relation

$$\left[R_{\Delta}(\rho) \right]_{\min} = A_1 \exp\left(\frac{1 - A_1}{A_1}\right)$$

and corresponds to the abscissa

$$\rho R_{\min} = \frac{A_1 - 1}{A_1(1 + A_1)}$$

These equations are valid only for $A_1 < 0$. The value $[\Omega]_{\varphi_{\max}}$ which determines the position of the maximum of the spectral function may be calculated with the use of the equation

$$\left[\Omega_{\Delta} \right]_{\varphi_{\max}}^2 = \frac{1 + 3A_1}{A_1 - 1} (1 + A_1)^2$$

which permits determination of $[\varphi_{\Delta}(\Omega_{\Delta})]_{\max}$ by application of equation (99). This maximum lies on the φ -axis for all values of $A_1 > -\frac{1}{3}$.

In order to calculate the coefficient A_1 by the method of moments, it suffices to know the moment of the first order which one finds by means of the equation (71)

$$\frac{L}{\Delta}^{(1)} = \frac{1 + 2A_1}{(1 + A_1)^2}$$

This method will be applicable only when $\frac{L}{\Delta}^{(1)} < 1$. The moment of first order for the positive surface is obtained with equation (72) and is equal to

$$\left[\frac{L}{\Delta}^{(1)} \right]^{(ap)} = \frac{1}{x_0^2} \frac{1}{(1 + A_1)^2} \left\{ 1 + 2A_1 + (1 - 2A_1) \exp\left(\frac{1}{A_1}\right) \right\}$$

The figures 28 to 31 represent the different characteristics of the correlation curves (98) and of the spectra corresponding to them.

Let the longitudinal-correlation law be of the form

$$R_x(\xi) = (1 + A_1 c|\xi|) \exp(-c|\xi|) \quad (100)$$

to which there corresponds in a flow of homogeneous and isotropic turbulence the transverse-correlation law

$$R_y(\eta) = \left[1 + \frac{1}{4}(3A_1 - 1)c|\eta| - \frac{1}{8}A_1 c^2\eta^2 \right] \exp\left(-\frac{1}{2}c|\eta|\right) \quad (101)$$

which has the form of the laws given by equation (75).

To the transverse-correlation law

$$R_y(\eta) = (1 + A_1 c|\eta|) \exp(-c|\eta|) \quad (102)$$

there corresponds in a flow of homogeneous and isotropic turbulence the longitudinal correlation

$$R_x(\xi) = \frac{1}{2c^2\xi^2} \left\{ 1 + 2A_1 - \left[(1 + 2A_1)(1 + 2c|\xi|) + 4A_1 c^2\xi^2 \right] \exp(-2c|\xi|) \right\} \quad (103)$$

In order to represent the points of the experiment NBS.9 (fig. 32) by a law of this form, one may first try to apply the method of moments.

Taking the value of $\left[\underline{L}(1) \right]^{(ap)} = 0.847$, given in table IV, as a basis, one finds the coefficient A_1 in figure 31. For obtaining the moment of first order having this value, one may take either $A_1 = 0.6$ or $A_1 = -0.5$. Superimposing on the points the figure 26, one finds that for the two coefficients the curves represent the experimental points rather satisfactorily. One sees, however, that a better result is obtained with the coefficient $A_1 = -0.25$ (fig. 32). Besides, it will happen quite frequently that one obtains better results by trial and error than by the method of moments.

For the experiment H.4b, $\left[\underline{L}(1) \right]^{(ap)} = 0.762$, hence, figure 31 gives $A_1 = 0.95$. One sees that the transverse correlation curve corresponding to this coefficient represents very well the experimental points (fig. 33). The longitudinal-correlation curve given by the equation (103) likewise represents very well the results of the experiment H.4a. As a result, the

flow for which these experiments have been made may be considered as homogeneous and isotropic. Figure 33 may be compared with figure 25 which also represents the experiments H.4. In the first figure we represented the measurements of the transverse correlation by an equation and deduced from it the longitudinal correlation by assuming a flow of homogeneous and isotropic turbulence. Regarding the second, we selected first the equation which represents the longitudinal-correlation curve and performed then the calculation for the transverse correlation.

$$(b) \text{ Law.} - \underline{R_{\Delta}(\rho) = [1 + A_1 c |\rho| + A_2 c^2 \rho^2] \exp(-c |\rho|)}.$$

By making in equation (75) $K = 2$, one obtains the correlation law of the form

$$R_{\Delta}(\rho) = [1 + A_1 c |\rho| + A_2 c^2 \rho^2] \exp(-c |\rho|) \quad (104)$$

The spectral function which corresponds to this correlation law is written

$$\Phi_{\Delta}(\Omega_{\Delta}) = \frac{2}{\pi} \frac{c}{c^2 + \Omega^2} \left\{ 1 + A_1 \frac{c^2 - \Omega^2}{c^2 + \Omega^2} + 2A_2 \frac{c^2(c^2 - 3\Omega^2)}{(c^2 + \Omega^2)^2} \right\} \quad (105)$$

Integrating equation (104), one obtains

$$c = 1 + A_1 + 2A_2$$

and applying the conditions (48) to (52) one finds the limits for the coefficients of these equations

$$-(1 + 2A_2) < A_1 \leq 1 \quad -1 < A_2 \leq \frac{(4 - A_1) + \sqrt{(4 - A_1)^2 - 9A_1^2}}{9}$$

The abscissa of the intersection point of the correlation curve with the ρ -axis will be

$$|\rho_0| = \frac{1}{c} \frac{-A_1 \pm \sqrt{A_1^2 - 4A_2}}{2A_2}$$

and the ratio of the apparent correlation length and the true correlation length is equal to

$$x_{\Delta} = 1 - [1 + (A_1 + 2A_2)\rho_0 + A_2 c \rho_0^2] \exp(-|c|\rho_0)$$

Making the derivative of (104) equal to zero, one finds the abscissa of the point for which the correlation coefficient is minimum or maximum

$$\left| \frac{\rho_{\Delta R}}{d\rho} = 0 \right| = \frac{1}{c} \frac{2A_2 - A_1 \pm \sqrt{(A_1 - 2A_2)^2 - 4A_2(1 - A_1)}}{2A_2}$$

and which gives with the equation (104) the value of this coefficient.

The above relationships permit tracing of figure 34 in which we have indicated the limits within which the coefficients A_1 , A_2 may vary without causing the equation (104) to cease representing a correlation law. We have, moreover, defined the domain in which one finds monotonous correlation curves, furthermore the domain where the correlation curve presents a negative minimum and finally the values of the coefficients for which the curve presents a positive maximum (without counting $R_{\Delta}(0) = 1$ which is not a maximum).

The figures 35 and 36 give the correlation curves and the spectral functions for several values of the coefficients A_1 and A_2 . One finds in these figures the curves presented already previously for the equation (98) which is a particular case of the correlation law now being studied.

When one knows the value of the moments of the first and second order, one can calculate the coefficients by solving the equations

$$\underline{L}^{(2)} c^3 - 6\underline{L}^{(1)} c^2 + 6c - 2 = 0$$

$$A_1 = - \left[\underline{L}^{(1)} c^2 - 3c + 2 \right] \quad A_2 = \frac{1}{2} (c - A_1 - 1)$$

We have stated that the method of trial and error gives very good results and is much faster than the method of moments.

When in a flow of homogeneous and isotropic turbulence the longitudinal correlation law is

$$\underline{R}_x(\xi) = \left[1 + A_1 c |\xi| + A_2 c^2 \xi^2 \right] \exp(-c |\xi|) \quad (106)$$

one finds, with application of von Karman's law, for the transverse correlation the expression

$$\underline{R}_y(\eta) = \left[1 + \frac{1}{4} (3A_1 - 1) c |\eta| + \frac{1}{8} (4A_2 - A_1) c^2 \eta^2 - \frac{1}{16} A_2 c^3 |\eta|^3 \right] \exp\left(-\frac{1}{2} c |\eta|\right) \quad (107)$$

This equation likewise has the form of the law (75), but with $K = 3$.

When, inversely, the transverse-correlation law is of the form

$$R_y(\eta) = \left[1 + A_1 c |\eta| + A_2 c^2 |\eta|^2 \right] \exp(-c |\eta|) \quad (108)$$

one obtains in a flow of homogeneous and isotropic turbulence the longitudinal correlation

$$R_x(\xi) = \frac{1}{2c^2 \xi^2} \left\{ (1 + 2A_1 + 6A_2) \left[1 - (1 + 2c) |\xi| \right] \exp(-2c |\xi|) - \right. \\ \left. \left[4(A_1 + 3A_2) c^2 \xi^2 + 8A_2 c^3 |\xi|^3 \right] \exp(-2c |\xi|) \right\} \quad (109)$$

The figures 37 to 42 show the results of several experiments and the curves which represent them. These curves have been obtained by trial and error. The results of the experiment NBS.2 are represented by the transverse correlation law (108) with coefficients $A_1 = 0$ and $A_2 = 0.1$. As shown in figure 34, the curve intersects the abscissa axis passing through a minimum. Consequently, we have drawn this curve as a function of $\eta^{(ap)}$ (fig. 37).

The experiment KD.1c (fig. 38) concerns the correlation between the transverse velocities at the fixed point, and the experimental points may be represented by a law analogous to (104), of the form

$$R_p^v(\tau_1) = \left[1 + A_1 c |\tau_1| + A_2 c^2 \tau^2 \right] \exp(-c |\tau_1|)$$

or

$$\tau_1 = \frac{h}{L_p^v} \quad \text{and} \quad L_p^v = \int_0^\infty R_p^v(s) ds$$

with the coefficients $A_1 = -0.5$, $A_2 = 0.3$. One sees in figure 34 that the correlation curve does not intersect the abscissa axis and that it is monotonous.

The results of the experiment NBS.1 have already been represented very well by the law (96), in figure 23. One can represent them as well by the correlation law (108), as shown in figure 39.

The measurements of the transverse correlation EGR.lb are represented in figure 40, by the curve of the equation (108) with the coefficients $A_1 = 1$ and $A_2 = 0.5$. This curve intersects the abscissa axis, and one represents it as a function of $\eta^{(ap)}$. In a flow of homogeneous and isotropic turbulence, there corresponds to the transverse-correlation law (108) the longitudinal-correlation law (109) which one has also represented as a function of $\eta^{(ap)}$, taking into account the relation

$$\eta^{(ap)} = 2 \frac{z}{x}$$

The experimental points of the experiment EGR.la are not very well represented by this last law although some points are placed on the curve R_x . The experiments EGR.l have therefore been made in a flow, the turbulence of which is not fully homogeneous and isotropic but reasonably close to that state.

The experiments KD.la and KD.lb give the longitudinal and transverse correlations between the simultaneous transverse velocities. In figure 41 we represented the correlation curve R_y^v (experiment KD.lb) as a function of $\eta^v = \frac{p}{L_y}$. If the flow in which these experiments were made were homogeneous and isotropic,

$$R_y^v = R_x \quad R_x^v = R_y$$

would correspond to the equations (5) which would permit application of the equation (107) for calculation of the correlation curve R_x^v . Since the experimental points KD.la deviate from this curve, the flow is not homogeneous and isotropic.

Representing the results of the experiment H.2a by the longitudinal-correlation law (106) (fig. 42), one finds the transverse correlation for the homogeneous and isotropic turbulence, and one sees that the points of the experiment H.2b do not correspond to the curve R_y .

$$14. \text{ Law } R_{\Delta}(\rho) = \sum_{n=1}^{n=K} A_n \exp(-c_n |\rho|)$$

The number of arbitrary constants one will have for the laws of this form is $2(K - 1)$. When $K = 1$, one has again equation (77) for which there is no arbitrary constant. We study here only the correlation law with $K = 2$.

(a) Law $R_{\Delta}(\rho) = A \exp(-c|\rho|) + B \exp(-\beta c|\rho|)$. - Assuming in equation (76) $K = 2$, $A_1 = A$, $A_2 = B$, $c_1 = c$, and $c_2 = \beta c$, one obtains the correlation law of the form

$$R_{\Delta}(\rho) = A \exp(-c|\rho|) + B \exp(-\beta c|\rho|) \quad (110)$$

to which corresponds the spectral function

$$\varphi_{\Delta}(\Omega_{\Delta}) = \frac{2c}{\pi} \left[A \frac{1}{c^2 + \Omega_{\Delta}^2} + B\beta \frac{1}{\beta^2 c^2 + \Omega_{\Delta}^2} \right] \quad (111)$$

Integrating equation (110) and applying the condition (50), one finds

$$c = A + \frac{B}{\beta} \quad B = 1 - A$$

which permits expression (110) and (111) as functions of two constants A and β .

The coefficient β may be larger or smaller than unity, but one will obtain exactly the same results by replacing this coefficient by its inverse. Assuming that $0 < \beta \leq 1$, one finds for A the limits:

$$-\frac{\beta}{1 - \beta} < A \leq \frac{1}{1 - \beta}.$$

The abscissa of the intersection point of the correlation curve with the ρ -axis will be

$$|\rho_0| = \frac{1}{c(1 - \beta)} \log \left(\frac{A}{A - 1} \right)$$

and since it must be positive, the curve intersects the axis only for $A > 1$. The ratio of the apparent-correlation length to the true-correlation length is

$$\chi_{\Delta} = \frac{1}{c} \left\{ A \left[1 - \left(\frac{A - 1}{A} \right)^{\frac{1}{1 - \beta}} \right] + \frac{1 - A}{\beta} \left[1 - \left(\frac{A - 1}{A} \right)^{\frac{\beta}{1 - \beta}} \right] \right\}$$

The abscissa of the point for which the correlation coefficient is minimum, is equal to

$$|\rho_{\text{min}}| = \frac{1}{c(1 - \beta)} \log \left[\frac{A}{\beta(A - 1)} \right]$$

and the value of this minimum is of the order of

$$[\underline{R}_\Delta]_{\min} = A \left[\frac{\beta(A-1)}{A} \right]^{\frac{1}{1-\beta}} + (1-A) \left[\frac{\beta(A-1)}{A} \right]^{\frac{\beta}{1-\beta}}$$

The value of Ω_Δ for which the spectrum presents a maximum may be calculated with the equation

$$[\underline{\Omega}_\Delta]_{\varphi_{\max}}^2 = c^2 \frac{(1-\beta^2) \sqrt{-A\beta} - (A\beta^2 + B\beta)}{A + B\beta}$$

and one obtains this maximum by substituting this value into equation (111).

Figure 43 gives the limits within which A may vary as functions of β . For the present law there are no correlation curves which present a maximum as was the case for (104). There are only two types of curves: those which intersect the axis and pass through a minimum value, and those which do not intersect the axis and are monotonous. The correlation curves and the spectral curves are traced in figures 44 and 45 for several values of β and of A . The different characteristics of these curves are given in figures 46 to 51.

The moments of the two first orders are given by the relations

$$\underline{L}^{(1)} = \frac{1}{c^2} \left(A + \frac{B}{\beta^2} \right) \quad \underline{L}^{(2)} = \frac{2}{c^3} \left(A + \frac{B}{\beta^3} \right)$$

When one knows their values for an experimental correlation curve, one can then determine the coefficients of equation (110) by solving the equations

$$\left\{ \frac{1}{2} \underline{L}^{(2)} - [\underline{L}^{(1)}]^2 \right\} c^2 + \left[\underline{L}^{(1)} - \frac{1}{2} \underline{L}^{(2)} \right] c + [\underline{L}^{(1)} - 1] = 0$$

$$\beta = \frac{1-c}{c - c^2 \underline{L}^{(1)}} \quad A = \frac{\beta c - 1}{\beta - 1}$$

The moments of the "apparent" surface of the correlation curve are given by the equations

$$[\underline{L}^{(1)}]^{(ap)} = \frac{1}{c^2 \chi^2} \left\{ A [1 - (a+1)b] + \frac{B}{\beta^2} [1 - (a\beta + 1)b\beta] \right\}$$

$$\left[\underline{L}^{(2)} \right]^{(ap)} = \frac{1}{c^3 \chi^3} \left\{ A \left[2 - (a^2 + 2a + 2)b \right] + \frac{B}{\beta^3} \left[2 - (a^2 \beta^2 + 2a\beta + 2)b\beta \right] \right\}$$

or

$$a = \frac{1}{1 - \beta} \log \left(\frac{A}{A - 1} \right) \quad \text{and} \quad b = \left(\frac{A - 1}{A} \right)^{\frac{1}{1 - \beta}}$$

Figure 52 gives the moment of the first order $\left[\underline{L}^{(1)} \right]^{(ap)}$ as a function of A for several values of β . Figure 53 represents $\left[\underline{L}^{(2)} \right]^{(ap)}$ as a function of $\left[\underline{L}^{(1)} \right]^{(ap)}$. The curves corresponding to the different values of β coincide in this figure when $A > 1$. Thus, when $A > 1$ and when the correlation curves intersect the abscissa axis, one can determine several correlation laws which give the same moments of the two first orders.

Assume the longitudinal-correlation law to be of the form

$$\underline{R}_x(\xi) = A \exp(-c|\xi|) + B \exp(-\beta c|\xi|) \quad (112)$$

In a flow of homogeneous and isotropic turbulence, there corresponds to this law the transverse correlation given by the equation

$$\underline{R}_y(\eta) = A \left(1 - \frac{1}{4} c|\eta| \right) \exp\left(-\frac{1}{2} c|\eta|\right) + B \left(1 - \frac{1}{4} \beta c|\eta| \right) \exp\left(-\frac{1}{2} \beta c|\eta|\right) \quad (113)$$

When one has in a flow of homogeneous and isotropic turbulence the transverse-correlation law

$$\underline{R}_y(\eta) = A \exp(-c|\eta|) + B \exp(-\beta c|\eta|) \quad (114)$$

the longitudinal correlation is equal to

$$\underline{R}_x(\xi) = \frac{1}{2c^2 \xi^2} \left\{ A \left[1 - (2c|\xi| + 1) \exp(-2c|\xi|) \right] + \frac{B}{\beta^2} \left[1 - (2\beta c|\xi| + 1) \exp(-2\beta c|\xi|) \right] \right\} \quad (115)$$

One finds in table II, for the experiment NBS.3, the moments $[\underline{L}(1)]^{(ap)} = 0.894$ and $[\underline{L}(2)]^{(ap)} = 1.561$. To these coordinates there corresponds in figure 53 the coefficient $\beta = 0.25$ with $A < 1$. Tracing then in figure 52 a horizontal, the ordinate of which is 0.894, one finds at the point of its intersection with the curve $\beta = 0.25$ a coefficient A which is approximately 0.25. The correlation curve corresponding to these coefficients actually represents the experimental points very satisfactorily (fig. 54).

In the same manner one obtains for the experiment NPL.3 for which $[\underline{L}(1)]^{(ap)} = 0.752$ and $[\underline{L}(2)]^{(ap)} = 0.976$, the coefficients $\beta = 0.8$ and $A = -3$. The correlation curve which corresponds to these coefficients is traced in figure 55.

This method is not successful for the experiments H.1a and NPL.1a for which we shall determine the coefficients by trial and error. For the first time, we represent the points by the law (112) with the coefficients $\beta = 0.25$ and $A = 0.50$ (fig. 56). Drawing the curve which corresponds to equation (113), one sees that the points of the experiment H.1b are not to be found on this curve; this shows that the flow in which these tests have been performed is not homogeneous and isotropic.

The results of the experiment NPL.1a are represented by the longitudinal-correlation law (112) with the coefficients $\beta = 0.25$ and $A = 0.25$ (fig. 57). The points of the experiment NPL.1b are placed very exactly on the curve which corresponds to the law (113). Hence the result that the flow in which these tests have been performed is homogeneous and isotropic.

CHAPTER IV

THE CORRELATION LAWS WHICH ARE DERIVED FROM $R_{\Delta}(\rho) = \exp\left(-\frac{\pi}{4} \rho^2\right)$

In this chapter we shall study the correlation laws of the form

$$R_{\Delta}(\rho) = \left[A_0 + \sum_{n=1}^{n=K} A_n \cos(m_n \rho) \right] \exp(-c^2 \rho^2) \quad (116)$$

$$R_{\Delta}(\rho) = \sum_{n=1}^{n=K} A_n \exp(-c_n^2 \rho^2) \quad (117)$$

Since for these laws $\frac{dR_{\Delta}(0)}{d\rho} = 0$, it will be possible to determine by calculation the value of l (or of λ). As equation (66) shows, the relative dimension of the smallest eddies l_x is equal to the inverse of the standard deviation of the longitudinal spectrum.

$$15. \text{ Law } R_{\Delta}(\rho) = \exp\left(-\frac{\pi}{4} \rho^2\right)$$

When one makes in equation (116) $K = 0$ and in equation (117) $K = 1$, one obtains Gauss' curve

$$R_{\Delta}(\rho) = \exp\left(-\frac{\pi}{4} \rho^2\right) \quad (118)$$

Applying equation (57), one finds for the spectrum the relation

$$\Phi_{\Delta}(\Omega_{\Delta}) = \frac{2}{\pi} \exp\left(-\frac{\Omega_{\Delta}^2}{\pi}\right) \quad (119)$$

which represents a curve of the same form as the correlation curve. This curve is given in figure 61 (for $m = 0$).

(a) When the longitudinal-correlation law is represented by the equation

$$R_x(\xi) = \exp\left(-\frac{\pi}{4} \xi^2\right) \quad (120)$$

one has, in a flow of homogeneous and isotropic turbulence, for the transverse correlation the expression

$$\underline{R}_y(\eta) = \left(1 - \frac{\pi}{16} \eta^2\right) \exp\left(-\frac{\pi}{16} \eta^2\right) \quad (121)$$

The curves representing these two equations are represented in figure 58. The curve which corresponds to (121) intersects the axis at the point $\eta_0 = \frac{4}{\sqrt{\pi}}$ whence: $\chi_y = \text{erf}(1) + \frac{2}{\sqrt{\pi}} \exp(-1) = 1.2581$. The abscissa of the point where the transverse correlation is minimum is equal to:

$$\eta_{\underline{R}_{\min}} = \sqrt{\frac{32}{\pi}} = 3.1915 \quad \text{and the value of this minimum is:}$$

$$\underline{R}_{\min} = -\exp(-2) = -0.1353. \quad \text{Applying equation (62), one finds: } l_x = \sqrt{\frac{2}{\pi}}.$$

(b) In a flow of homogeneous and isotropic turbulence where the transverse-correlation law is written

$$\underline{R}_y(\eta) = \exp\left(-\frac{\pi}{4} \eta^2\right) \quad (122)$$

one finds for the longitudinal correlation the expression

$$\underline{R}_x(\xi) = \frac{1}{2} \left[1 - \exp(-\pi \xi^2) \right] \quad (123)$$

The curves which correspond to these two equations are given in figure 59. For the dimension of the smallest eddies, the value $l_y = 2\sqrt{\frac{1}{\pi}}$ corresponds to this law.

(c) The experiment EGR.lb can be relatively well represented by the curve (12), as figure 60 shows. The points of the experiment EGR.la are placed rather close to the curve which corresponds to the equation (123). As a result, the flow rather approximates a flow of homogeneous and isotropic turbulence. This has already been seen when the test points of the experiment EGR.lb were represented by the equation (108) (see fig. 40); whereas it had not been possible to calculate, for that last law, the value of l_y algebraically, one obtains now immediately

$$l_y = \sqrt{\frac{1}{\pi}}.$$

$$16. \text{ Law } R_{\Delta}(\rho) = \left[A_0 + \sum_{n=1}^{n=K} A_n \cos(m_n c \rho) \right] \exp(-c^2 \rho^2)$$

In studying these laws with $K = 0$ and $K = 1$, we did not find an application for the experiments given in table I. We present, nevertheless, a few curves for $K = 0$ as well as the equations for $K = 1$.

(a) Law $R_{\Delta}(\rho) = \exp(-c^2 \rho^2) \cos(m c \rho)$.— When one makes $K = 0$ in the equation (116), one obtains the correlation law

$$R_{\Delta}(\rho) = \exp(-c^2 \rho^2) \cos(m c \rho) \quad (124)$$

to which corresponds the spectral function

$$\Phi_{\Delta}(\Omega_{\Delta}) = \frac{1}{\sqrt{\pi} c} \exp\left(-\frac{\Omega_{\Delta}^2}{4c^2} - \frac{m^2}{4}\right) \text{ch}\left(\frac{m}{2c} \Omega\right) \quad (125)$$

Integrating the equation (124) from zero to infinity, one obtains

$$c = \frac{\sqrt{\pi}}{2} \exp\left(-\frac{m^2}{4}\right)$$

Applying the conditions (48) to (53), one finds that the coefficient m may be arbitrary. One assumes, consequently, that m is always positive.

The abscissa of the intersection point of the correlation curve and the ρ -axis is given by $|\rho| = \frac{\pi}{2mc}$, and one finds the ratio of the apparent correlation length and the true correlation length by integrating (124) from zero to ρ_0

$$x_{\Delta} = 1 + \sum_{n=1}^{n=\infty} \left(-\frac{\pi^2}{4}\right)^n \sum_{n_1=0}^{n_1=n} \frac{1}{(n_1)! [2(n - n_1)]!} \left(\frac{1}{m^2}\right)^{n_1}$$

In order to calculate this coefficient, it is easier to draw the correlation curves as functions of ρ and to determine $L^{(ap)}$ by planimetry the area bounded by the curve up to its first point of intersection with the abscissa axis.

The correlation curves and the spectral curves are represented in figures 61 and 62.

(b) Law $\underline{R}_\Delta(\rho) = [A_0 + A_1 \cos(mc\rho)] \exp(-c^2\rho^2)$. - To the correlation law

$$\underline{R}_\Delta(\rho) = [A_0 + A_1 \cos(mc\rho)] \exp(-c^2\rho^2) \quad (126)$$

corresponds the spectral function

$$\varphi_\Delta(\Omega_\Delta) = \frac{1}{\sqrt{\pi}c} \left[A_0 + A_1 \exp\left(-\frac{m^2}{4}\right) \operatorname{ch}\left(\frac{m}{2c} \Omega_\Delta\right) \right] \exp\left(-\frac{\Omega_\Delta^2}{4c^2}\right) \quad (127)$$

Integrating the equation (126) one calculates the value of the coefficient c which is

$$c = \frac{\sqrt{\pi}}{2} \left\{ A_0 \left[1 - \exp\left(-\frac{m^2}{4}\right) \right] + \exp\left(-\frac{m^2}{4}\right) \right\}$$

Applying the conditions (48) to (53) one finds that the coefficient A_0 may vary within the limits

$$0 < A_0 \leq \frac{2}{m^2} + 1$$

The abscissa of the intersection point of the correlation curve and the ρ -axis is given by the relation

$$|\rho_0| = \frac{1}{mc} \arccos\left(\frac{A_0}{A_0 - 1}\right)$$

which shows that this curve intersects the axis when $A_0 < \frac{1}{2}$.

$$17. \text{ Law } \underline{R}_\Delta(\rho) = \sum_{n=1}^{n=K} A_n \exp(-c_n \rho^2)$$

We shall study for these laws the particular case where $K = 2$ with the assumptions $A_1 = A$, $A_2 = B$, $c_1 = c$, $c_2 = \beta c$.

(a) Law $\underline{R}_\Delta(\rho) = A \exp(-c^2\rho^2) + B \exp(-\beta^2 c^2\rho^2)$. - To the correlation law

$$\underline{R}_\Delta(\rho) = A \exp(-c^2\rho^2) + B \exp(-\beta^2 c^2\rho^2) \quad (128)$$

corresponds the spectrum

$$\Phi_{\Delta}(\Omega_{\Delta}) = \frac{1}{\sqrt{\pi c}} \left[A \exp\left(-\frac{\Omega_{\Delta}^2}{4c^2}\right) + \frac{B}{\beta} \exp\left(-\frac{\Omega_{\Delta}^2}{4\beta^2 c^2}\right) \right] \quad (129)$$

Integrating the equation (128), one finds

$$c = \frac{\sqrt{\pi}}{2\beta} [A(\beta - 1) + 1] \quad B = 1 - A$$

and applying the conditions (48) to (53), one obtains the limits within which the coefficient A may vary

$$0 < A \leq \frac{1}{1 - \beta}$$

The different characteristics of the correlation curves are given by the relationships

$$\rho_0^2 = \frac{1}{c^2(1 - \beta^2)} \log\left(\frac{A}{A - 1}\right)$$

$$\chi_{\Delta} = \frac{\sqrt{\pi}}{2c} \left[A \operatorname{erf}(c\rho_0) + \frac{B}{\beta} \operatorname{erf}(\beta c\rho_0) \right]$$

$$\rho_{B_{\min}}^2 = \frac{1}{c^2(1 - \beta^2)} \log\left[\frac{A}{\beta^2(A - 1)}\right]$$

$$R_{\min} = A \exp\left\{-\frac{1}{1 - \beta^2} \log\left[\frac{A}{\beta^2(A - 1)}\right]\right\} + B \exp\left\{-\frac{\beta^2}{1 - \beta^2} \log\left[\frac{A}{\beta^2(A - 1)}\right]\right\}$$

The figure 63 shows the values of the coefficients A and β which one can assume for the correlation law (128). The curve intersects the axis when $A > 1$ while passing through a minimum value; it is positive and monotonous for $0 < A < 1$.

Figures 64 and 65 give the correlation curves and the spectral curves for some values of A and of β . Figures 66 to 69 give the characteristics of the correlation curves, referred to the apparent correlation length.

The moments of the true area bounded by the correlation curve are

$$\underline{L}^{(1)} = \frac{1}{2c^2} \left[A + \frac{B}{\beta^2} \right] \quad \underline{L}^{(2)} = \frac{\sqrt{\pi}}{4c^3} \left[A + \frac{B}{\beta^3} \right]$$

and for the "apparent" surface one has

$$\left[\underline{L}^{(1)} \right]^{(ap)} = \frac{1}{2c^2 \chi^2} \left\{ A \left[1 - \left(\frac{A-1}{A} \right)^{\frac{1}{1-\beta^2}} \right] + \frac{B}{\beta^2} \left[1 - \left(\frac{A-1}{A} \right)^{\frac{\beta^2}{1-\beta^2}} \right] \right\}$$

$$\left[\underline{L}^{(2)} \right]^{(ap)} = \frac{1}{2c^3 \chi^3} \left\{ \frac{\sqrt{\pi}}{2} \left[A \operatorname{erf}(c\rho_0) + \frac{B}{2\beta^3} \operatorname{erf}(\beta c\rho_0) \right] - \right. \\ \left. c\rho_0 \left[A \exp(-c^2\beta^2) + \frac{B}{\beta^2} \exp(-\beta^2 c^2 \rho_0^2) \right] \right\}$$

The moment $\left[\underline{L}^{(1)} \right]^{(ap)}$ is given as a function of A and of β in figure 70, $\left[\underline{L}^{(2)} \right]^{(ap)}$ is given as a function of $\left[\underline{L}^{(1)} \right]^{(ap)}$ in figure 71. For $A > 1$, one has one and the same curve for all values of β .

When the correlation curve does not cut the abscissa axis, one can also determine the coefficients by calculation, by solving the equations

$$c = \frac{1}{2 \left[\pi \left(\underline{L}^{(1)} \right)^2 - 2 \underline{L}^{(2)} \right]} \left\{ \sqrt{\pi} \left[\underline{L}^{(1)} - \underline{L}^{(2)} \right] - \right. \\ \left. \sqrt{\pi \left[\underline{L}^{(1)} - \underline{L}^{(2)} \right]^2 - 4 \left[\pi \left(\underline{L}^{(1)} \right)^2 - 2 \underline{L}^{(2)} \right]^2 \left[1 - \frac{1}{2} \pi \underline{L}^{(1)} \right]} \right\}$$

$$\beta = \frac{1 - \frac{\sqrt{\pi}}{2c}}{\sqrt{\pi} c \underline{L}^{(1)} - 1} \quad A = \frac{1 - \frac{2c}{\sqrt{\pi}} \beta}{1 - \beta}$$

Let the longitudinal correlation law be of the form

$$\underline{R}_x(\xi) = A \exp(-c^2 \xi^2) + B \exp(-\beta^2 c^2 \xi^2) \quad (130)$$

In a flow of homogeneous and isotropic turbulence the transverse correlation which corresponds to this law will be

$$\underline{R}_y(\eta) = A \left(1 - \frac{1}{4} c^2 \eta^2\right) \exp\left(-\frac{1}{4} c^2 \eta^2\right) + B \left(1 - \frac{1}{4} \beta^2 c^2 \eta^2\right) \exp\left(-\frac{1}{4} \beta^2 c^2 \eta^2\right) \quad (131)$$

and the relative length of the smallest eddies which is calculated by application of the equation (62) is given by the relation

$$l_x^2 = \frac{1}{2c^2(A + B\beta^2)} \quad (132)$$

This length is represented as a function of A and of β in figure 72.

When the transverse-correlation law is

$$\underline{R}_y(\eta) = A \exp(-c^2 \eta^2) + B \exp(-\beta^2 c^2 \eta^2) \quad (133)$$

one then finds in a flow of homogeneous and isotropic turbulence

$$\underline{R}_x(\xi) = \frac{1}{4c^2 \xi^2} \left\{ A \left[1 - \exp(-4c^2 \xi^2)\right] \frac{B}{\beta^2} \left[1 - \exp(-4\beta^2 c^2 \xi^2)\right] \right\} \quad (134)$$

and equation (62) gives

$$l_y^2 = \frac{1}{c^2(A + B\beta^2)} \quad (135)$$

The relative length l_y is given as a function of A and of β in figure 73.

To the experiment H.2b correspond the moments $[\underline{L}(1)]^{(ap)} = 0.893$ and $[\underline{L}(2)]^{(ap)} = 1.410$. The point drawn with its coordinates in figure 71 is placed rather close to the curve $\beta = 0.25$. Then one traces a horizontal line with the ordinate 0.893 in figure 70 and finds that it intersects the curve $\beta = 0.25$ at two abscissa points $A = 0.55$ and $A = 0.88$. In figure 71, the experimental point lies near to the part of the curve $\beta = 0.25$ closest to the axis $[\underline{L}(1)]^{(ap)}$. Therefore one must in figure 70 take account of the intersection point with the branch

of the curve closest to the same axis. One thus obtains the two coefficients $\beta = 0.25$, $A = 0.55$. The experiment is represented by a point which gives a negative correlation coefficient. In order to have a law which represents a correlation curve which passes through negative values, it would be necessary that $A > 1$. So one sees that the point which corresponds to the moments of the experimental curve is very far distant from the curve $A > 1$ (solidly drawn in fig. 71). Thus it will not be possible to find coefficients for the equation (113) in such a manner that the curve represents the points of the experiment H.2b and intersects the abscissa axis.

The transverse-correlation curve calculated with the coefficients $A = 0.55$, $\beta = 0.25$ and the experimental points H.2b are drawn in figure 74.

Comparing the points of the experiment H.2a with the curve R_x calculated with the equation (134), one sees that the turbulence is not homogeneous and isotropic. This has, besides, already been seen in figure 42. The relative dimension l_y can be determined by the equation (135) or by the figure 73 as soon as one assumes the turbulence to be isotropic. In this case one would obtain $l_y = 0.632$.

The moments corresponding to the experiment H.4b are $[L(1)]^{(ap)} = 0.762$ and $[L(2)]^{(ap)} = 1.000$. One finds the coefficients $\beta = 0.25$ and $A = 0.3$ in the same manner as for the preceding experiment. The transverse-correlation curve corresponding to these coefficients represents in effect satisfactorily the experiment H.4b, and the longitudinal-correlation curve calculated by means of the equation (134) overlaps with the points of the experiment H.4b; this shows that the turbulence of the flow in which these tests have been made may be considered homogeneous and isotropic. One finds as the ratio of the dimension of the smallest eddies and of the longitudinal-correlation length $l_y = 0.621$.

Superimposing the points of the experiment NBS.9 on the curves of the figure 64, one finds very quickly that they can be represented by the equation (133) with the coefficients $\beta = 0.25$, $A = 0.5$ (fig. 76). One obtains easily, by calculation or on the basis of figure 73, the value $l_y = 0.619$.

Likewise, the results of the experiment NPL.3 are represented by the equation (133) with the coefficients $\beta = 0.5$ and $A = 0.5$ (fig. 77). One finds, for these coefficients, $l_y = 0.952$.

CHAPTER V

THE CORRELATION LAWS DEVELOPED IN A SERIES
OF HERMITE POLYNOMIALS

In reference 5, J. Kampé de Fériet represents the correlation curve by an equation which involves an expansion in a series of Hermite polynomials.⁴ With the notations we are using in the present report, the correlation law is written

$$R_{\Delta}(\rho) = \left[1 + \sum_{n=1}^{n=k} B_n H_{2n}(\sqrt{2c\rho}) \right] \exp(c^2\rho^2) \quad (136)$$

where

$$H_{2n}(s) = \frac{(-1)^n}{2^n} \frac{2n!}{n!} \left[1 - \frac{2n}{2!} s^2 + 2^2 \frac{n(n-1)}{4!} s^4 - \dots (-1)^n 2^{2n} \frac{n!}{(2n)!} s^{2n} \right]$$

and for the first polynomials one will have

$$H_2(s) = s^2 - 1 \quad H_6(s) = s^6 - 15s^4 + 45s^2 - 15$$

$$H_4(s) = s^4 - 6s^2 + 3 \quad H_8(s) = s^8 - 28s^6 + 210s^4 - 420s^2 + 105$$

To the correlation law (136) corresponds the spectral function

$$\varphi_{\Delta}(\Omega_{\Delta}) = \frac{1}{\sqrt{\pi c}} \left[1 + \sum_{n=1}^{n=k} (-1)^n B_n \left(\frac{\Omega_{\Delta}^2}{2c^2} \right)^n \right] \exp(-c^2\rho^2) \quad (137)$$

which involves an expansion in a power series.

$$18. \text{ Law } \left[1 + \sum_{n=1}^{n=K} A_n c^{2n} \rho^{2n} \right] \exp(-c^2\rho^2)$$

It would be much more convenient to employ an equation for representation of the correlation curves in which the development in a series of Hermite polynomials is replaced by a power series

⁴The study of the Hermite polynomials has been carried out by J. Kampé de Fériet (ref. 18).

$$R_{-\Delta}(\rho) = \left[1 + \sum_{n=1}^{n=k} A_n c^{2n} \rho^{2n} \right] \exp(-c^2 \rho^2) \quad (138)$$

The relationship between the coefficients of these two equations has been given by J. Kampé de Fériet and is written

$$A_n = \frac{1}{n!} \sum_{n_1=0}^{n_1=\frac{k-n}{2}} \frac{1}{2n_1!} \frac{(n+2n_1)!}{n_1!} B_{n+2n_1} \quad (139)$$

$$B_n = \frac{1}{n!} \sum_{n_1=0}^{n_1=\frac{k-n}{2}} (-1)^{n_1} \frac{1}{2n_1!} \frac{(n+2n_1)!}{n_1!} A_{n+2n_1}$$

Applying equations (57) to (138), one finds the spectral function

$$(\varphi_{\Delta} \Omega_{\Delta}) = \frac{1}{\sqrt{\pi}c} \left[1 + \sum_{n=1}^{n=k} (-1)^n \frac{1}{2^n} A_n H_{2n} \left(\frac{\Omega_{\Delta}}{\sqrt{2}c} \right) \right] \exp \left(- \frac{\Omega^2}{4c^2} \right) \quad (140)$$

which comprises a series of Hermite polynomials.

Integrating the equation (138) from zero to infinity, one obtains

$$c = \frac{\sqrt{\pi}}{2} \left[1 + \sum_{n=1}^{n=k} \frac{1.3 \dots (2n-1)}{2^n} A_n \right] \quad (141)$$

The inequality (53) leads to the general condition for all laws of the form (138)

$$A_1 < 1$$

In the equation (140) the coefficients, the indices of which are even numbers, are preceded by a negative sign. In order to confirm the condition (52), it is necessary that $A_K > 0$ when K is even and that $A_K < 0$ when K is odd. In the study of equation (138) one sees that in this last case the correlation curve $R_{-\Delta}(\rho)$ will intersect the ρ -axis. For determination of the other conditions which must be set up in order to make the equation (138) really a correlation law, one must first know the value of K and then apply the equation (52).

The simplest law of the form given by (138) is obtained when $K = 0$. One then has Gauss' curve which has already been studied, equation (118).

(a) When in a flow of homogeneous and isotropic turbulence the longitudinal-correlation law is of the form

$$\underline{R}_x(\xi) = \left[1 + \sum_{n=1}^{n=k} A_n c^{2n} \xi^{2n} \right] \exp(-c^2 \xi^2) \quad (142)$$

one finds, with application of equation (60), the transverse-correlation law

$$\underline{R}_y(\eta) = \left\{ 1 + \frac{1}{4}(2A_1 - 1)c^2 \eta^2 + \sum_{n=1}^{n=k} \frac{1}{2^{2n}} \frac{1}{2^{2n}} [(n+1)A_n A_{n-1}] c^{2n} \eta^{2n} \right\} \exp\left(-\frac{1}{4} c^2 \eta^2\right) \quad (143)$$

which is a law of a form similar to (142) but with other coefficients.

The equation (62) gives for the dimension of the smallest eddies responsible for the energy dissipation by turbulent viscosity the relationship

$$l_x = \frac{1}{c\sqrt{2(1 - A_1)}} \quad (144)$$

(b) To the transverse-correlation law of the form

$$\underline{R}_y(\eta) = \left[1 + \sum_{n=1}^{n=k} A_n c^{2n} \eta^{2n} \right] \exp(-c^2 \eta^2) \quad (145)$$

corresponds in a flow of homogeneous and isotropic turbulence the longitudinal correlation

$$\underline{R}_x(\xi) = \frac{1}{4c^2 \xi^2} \left\{ 1 - \exp(-4c^2 \xi^2) + \sum_{n=1}^{n=k} n! A_n \left[1 - \sum_{n_1=0}^{n_1=n} \frac{(4c^2 \xi^2)^{n_1}}{n_1!} \exp(-4c^2 \xi^2) \right] \right\} \quad (146)$$

and the equation (62) gives

$$l_y = \frac{1}{c\sqrt{1 - A_1}} \quad (147)$$

$$19. \text{ Law } R_{\Delta}(\rho) = [1 + A_1 c^2 \rho^2] \exp(-c^2 \rho^2)$$

When in equation (138) $K = 1$, one obtains the correlation law

$$R_{\Delta}(\rho) = [1 + A_1 c^2 \rho^2] \exp(-c^2 \rho^2) \quad (148)$$

to which corresponds the spectral function

$$\Phi_{\Delta}(\Omega_{\Delta}) = \frac{1}{\sqrt{\pi}c} \left[1 + \frac{1}{2} - \frac{1}{4} A_1 \frac{\Omega_{\Delta}^2}{c^2} \right] \exp\left(-\frac{\Omega_{\Delta}^2}{4c^2}\right) \quad (149)$$

and where

$$c = \frac{\sqrt{\pi}}{2} \left[1 + \frac{1}{2} A_1 \right]$$

We have already shown that the condition $A_1 < 1$ must be verified whatever the value of K may be. On the other hand, in the actual case, with K being odd, it is necessary that $A_K = A_1 < 0$. Finally, the inequality (52), applied to the spectral function (149), gives $A_1 > -2$ whence there results the condition

$$-2 < A_1 \leq 0$$

The correlation curve always intersects the ρ -axis. The various characteristics of this curve as well as those of the spectral curve are given by the relationships

$$\rho_0^2 = -\frac{1}{A_1 c^2} \quad x_{\Delta} = \text{erf}(c\rho_0) - \frac{1}{2} A_1 \rho_0 \exp(-c^2 \rho_0^2)$$

$$\rho_{R \min}^2 = \frac{1}{c} \sqrt{\frac{A_1 - 1}{A_1}} \quad R_{\min} = A_1 \exp\left(\frac{1 - A_1}{A_1}\right)$$

$$[\Omega_{\Delta}]_{\Phi_{\max}} = 2c^2 \left[3 + \frac{2}{A_1} \right] \quad [\Phi_{\Delta}(\Omega_{\Delta})]_{\max} = -\frac{A_2}{\sqrt{\pi}c} \exp\left(-\frac{1}{A_1} - \frac{3}{2}\right)$$

$$\underline{L}_{\Delta}^{(1)} = \frac{1}{2c^2} (1 + A_1)$$

$$\left[\underline{L}_{\Delta}^{(1)} \right]^{(ap)} = \frac{1}{2c^2 \chi_{\Delta}^2} \left[1 + A_1 - \left(1 + A_1 + A_1 c^2 \rho_0^2 \right) \right] \exp \left(-c^2 \rho_0^2 \right)$$

The figures 78 and 79 represent the correlation curves and the spectral curves for some values of A , and the figures 80 to 83 give the values of the expressions calculated above.

(a) To the longitudinal-correlation law

$$\underline{R}_x(\xi) = \left[1 + A_1 c^2 \xi^2 \right] \exp \left(-c^2 \xi^2 \right) \quad (150)$$

there corresponds in a flow of homogeneous and isotropic turbulence the transverse-correlation law

$$\underline{R}_y(\eta) = \left[1 + \frac{1}{4}(2A_1 - 1)c^2 \eta^2 \right] \exp \left(-\frac{1}{4} c^2 \eta^2 \right) \quad (151)$$

(b) When in a flow of homogeneous and isotropic turbulence, the transverse-correlation law is of the form

$$\underline{R}_y(\eta) = \left[1 + A_1 c^2 \eta^2 \right] \exp \left(-c^2 \eta^2 \right) \quad (152)$$

the longitudinal-correlation law is

$$\underline{R}_x(\xi) = \frac{1}{4c^2 \xi^2} \left\{ 1 + A_1 - \left[1 + A_1 + 4A_1 c^2 \xi^2 \right] \exp \left(-c^2 \xi^2 \right) \right\} \quad (153)$$

$$20. \text{ Law } \underline{R}_{\Delta}(\rho) = \left[1 + A_1 c^2 \rho^2 + A_2 c^4 \rho^4 \right] \exp \left(-c^2 \rho^2 \right)$$

When in the equation (138) $K = 2$, one obtains the correlation law

$$\underline{R}_{\Delta}(\rho) = \left[1 + A_1 c^2 \rho^2 + A_2 c^4 \rho^4 \right] \exp \left(-c^2 \rho^2 \right) \quad (154)$$

to which corresponds the spectral function

$$\Phi_{\Delta}(\Omega_{\Delta}) = \frac{1}{\sqrt{\pi}c} \left[1 + \frac{1}{2} A_1 + \frac{3}{4} A_2 - (A_1 + 3A_2) \frac{\Omega^2}{4c^2} + A^2 \frac{\Omega^4}{16c^4} \right] \quad (155)$$

and where

$$c = \frac{\sqrt{\pi}}{2} \left[1 + \frac{1}{2} A_1 + \frac{3}{4} A_2 \right]$$

The different characteristics of these curves are given by the relationships

$$\rho_0^2 = \frac{-A_1 \pm \sqrt{A_1^2 - 4A_2}}{2c^2 A_2}$$

$$X_{\Delta} = \operatorname{erf}(c\rho_0) - \frac{1}{2} \left[(A_1 + \frac{3}{2} A_2 + A_1 c^2 \rho_0^2) \rho_0 \exp(-c^2 \rho_0^2) \right]$$

$$\rho^2 \frac{dR}{d\rho} = 0 = \frac{2A_2 - A_1 \pm \sqrt{(2A_2 - A_1)^2 - 4A_2(1 - A_2)}}{2A_2 c^2}$$

$$\Omega_{\rho_{\max}}^2 = \frac{2c^2}{A_2} \left[(A_1 + 5A_2) \pm \sqrt{(A_1 + 5A_2)^2 - A_2(4 + 6A_1 + 15A_2)} \right]$$

Applying the conditions (26) to (34), one finds for the coefficients A_1 , A_2 the limits indicated in figure 84. The figures 85 and 86 give the correlation curves and the spectral curves, and the figures 87 to 90 represent the values of some characteristics of these curves.

CHAPTER VI

TURBULENCE SPECTRA

21. Equations Suitable for Representing a Turbulence Spectrum

We have shown in the first two chapters what the conditions are which must be imposed on an equation so that it can represent a turbulence spectrum. In the following three chapters we have given the spectral functions which correspond to a certain number of correlation laws. One can evidently perform the opposite operation by first assuming the equation of the spectrum and then calculating the correlation law. The simplest equations one can propose for representation of the spectra are

$$\varphi = A \exp(-B\Omega^2) \qquad \varphi = \frac{A}{1 + B\Omega^2} \qquad \varphi = A \exp(-B|\Omega|)$$

See equations (78) and (118). Writing them for the G. I. Taylor spectra, one will have

$$\varphi_0(\Omega_t) = \frac{2}{\pi} \exp\left(-\frac{1}{\pi} \Omega_t^2\right) \qquad (156)$$

and

$$\varphi_t(\Omega_t) = \frac{2}{\pi} \frac{1}{1 + \Omega_t^2} \qquad (157)$$

Imposing the conditions (52) and (54) to (56), one finds for the third

$$\varphi_t(\Omega_t) = \frac{2}{\pi} \exp\left(-\frac{2}{\pi} |\Omega_t|\right) \qquad (158)$$

and the corresponding correlation law is written

$$\underline{R}_t(\tau) = \frac{1}{1 + \frac{\pi^2}{4} \tau^2} \qquad (159)$$

In figure 91 we compare these three spectral curves, and in figure 92 the correlation curves which correspond to them.

22. Experimental Spectra

For representing an experimental spectrum by an equation, one may employ the same methods as for the correlation laws. Notably, one may search for this equation by trial and error after having superimposed the experimental points on the spectral curves drawn in the numerous figures given in this report.

When the correlation length is not known and the experiment, consequently, does not give the curve $\varphi_t(\Omega_t)$ but only $f_t(\omega)$, one plots, in this case, on logarithmic coordinates $Uf(\omega)$ as a function of $\frac{\omega}{U}$ and then superimposes it on the curves $\varphi_t(\Omega_t)$, noting that

$$Uf_t(\omega)\frac{\omega}{U} = \varphi_t(\Omega_t)\Omega_t$$

Figure 93 represents the results of the experiment NPL.4a as well as the spectral curve corresponding to the equation (129) where $A = 0.6$ and $\beta = 0.15$. It should be noted that, in representing the correlation curve (128) corresponding to this spectrum, one will obtain a curve which does not represent the points of the experiment NPL.1b. Thus, it is possible to show that the verification of the G. I. Taylor equations of which we have spoken in chapter I, section 3 is not exact. This indicates how difficult it is to make verifications of this type.

CHAPTER VII

CONCLUSIONS

1. There is much confusion regarding the numerous correlation coefficients and spectra studied by the various authors. We hope to have shown the difference between these diverse factors by the use of appropriate notations. These notations may seem relatively complicated but we are of the opinion that one must not shy away from a complicated notation which may make the ideas clearer.

2. By studying homogeneous turbulence for which, moreover, the time averages of the turbulent velocity are equal to the space averages, we show that the correlation coefficients between the simultaneous turbulent velocities at two points placed along a straight line of given direction and a given distance apart are the same whether the study is carried out in the Euler or in the Lagrange system.

3. We introduce in this report what we call the longitudinal spectrum of turbulence which is obtained by harmonic analysis of the curve representing the components of the simultaneous turbulent velocities u' along a straight line parallel to the direction of the mean velocity. The transverse spectrum is obtained by study of the simultaneous u' along a straight line perpendicular to the direction of the main velocity.

4. In the study of the equations of G. I. Taylor which establish the correlation between the simultaneous u' and the spectrum measured at the fixed point (ref. 7), we show that there exists a coefficient the value of which may serve as a criterion for the legitimacy of employing these equations. This coefficient

$$-\frac{L_x}{U} \sqrt{\frac{d^2 R_m(0)}{dh^2}}$$

must be very small; only then the G. I. Taylor equations can be considered exact.

5. We give several important equations derived from Kármán's law for a flow of homogeneous and isotropic turbulence.

6. The representation of the correlation laws and the spectra by empirical equations may be of very great service. We made a very large number of applications to the experimental results, especially regarding the correlation curve. When the equation which represents the longitudinal-correlation curve is given, one may easily obtain the transverse-correlation

curve by applying Kármán's law, and if one has the experimental points for the two curves, one can verify whether the flow in which these tests have been made is homogeneous and isotropic. On the other hand, one can rapidly calculate the turbulence spectrum by making a Fourier transform. By the same method, on the basis of the transverse-correlation law or of the spectrum, one can study other characteristics of the turbulence.

7. The functions of the form

$$\underline{R}_{\Delta}(r) = \exp(-K|r|)\varphi(r)$$

are generally more satisfactory for representation of the correlation curves than the functions

$$\underline{R}_{\Delta}(r) = \exp(-K^2r^2)\varphi(r)$$

One succeeds in a very good representation of several results, employing only two arbitrary coefficients in these functions.

8. The application of Hermite polynomials (ref. 5) to the representation of experimental correlation curves seems to be rather difficult since it is necessary for the representation of an experimental curve to choose more than two arbitrary factors.

Translated by Mary L. Mahler
National Advisory Committee
for Aeronautics

REFERENCES

1. Doob, J. L.: The Brownian Movement and Stochastic Equation. *Annals of Mathematics*, vol. 43, no.2, April 1942, pp. 352-369.
2. Kalinske, A. A.: The Role of Turbulence in River Hydraulics. *Proceedings of the Second Hydraulics Conference*, pp. 266-279.
3. De Fériet, J. Kampé: Les fonctions aléatoires stationnaires et la théorie statistique de la turbulence homogène. *Annales de la Société Scientifique*, tome LIX, série 1, 1939, p. 145.
4. De Fériet, J. Kampé: The Spectrum of Turbulence. *Journal of the Aeronautical Sciences*, vol. 7, 1940, p. 518.
5. De Fériet, J. Kampé: Cours de turbulence professé à L'Institut de Mécanique des Fluides de Lille, en 1941 (non encore publié).
- [6. Taylor, G. I.: Statistical Theory of Turbulence. *Proc. Roy. Soc. (London)*, Ser. A, vol. 151, no. 873, Sept. 2, 1935, pp. 421-478.]¹
- [7.]¹ Taylor, G. I.: The Spectrum of Turbulence. *Proceedings of The Royal Society of London*, ser. A, no. 919, vol. 164, 1938, p. 476.
8. Taylor, G. I.: Some Recent Developments in the Study of Turbulence. *Fifth International Congress for Applied Mechanics, Cambridge (U.S.A.)*, 1938, p. 294.
9. Hall, A. A.: Measurements of the Intensity and Scale of Turbulence. *Aer. Res. Com. R. & M. No. 1842*, 1938.
10. Kármán, Th.: The Fundamentals of the Statistical Theory of Turbulence. *Journal of the Aeronautical Sciences*, vol. 4, 1937, p. 131.
11. Dryden, H. L., Schubauer, G. B., Mock, W. C., and Skramstad, H. K.: Measurements of Intensity and Scale of Wind-Tunnel Turbulence. *NACA Tech. Rep. No. 581*, 1937.
12. Bochner, S.: *Vorlesungen über Fourierische Integrale*. Leipzig, 1932.
13. Dryden, H. L.: Turbulence Investigations at the National Bureau of Standards. *Fifth International Congress for Applied Mechanics, Cambridge (U.S.A.)*, 1938, p. 362.

¹NACA Reviewer's note: In the original French document, no reference 7 was listed, although subsequent references were correctly numbered. A study of the text indicates that the report listed as reference 6 should have been reference 7. Apparently the paper intended for reference 6 is that inserted here in brackets.

14. Motzfeld, H.: Frequenzanalyse turbulenter Schwankungen. Ztschr. f. angew. Math. und Mech., Band 18, Heft 6, 1938, p. 362.
15. Kalinske, A. A., and van Driest, E. R.: Application of Statistical Theory of Turbulence to Hydraulic Problems. Fifth International Congress for Applied Mechanics. Cambridge (U.S.A.), 1938, p. 416.
16. Richardson, E. G.: The Measurement of Correlation in Fluid Motions. Fifth International Congress for Applied Mechanics, Cambridge (U.S.A.), 1938, p. 382.
17. Simmons, L. F. G., and Salter, C.: An Experimental Determination of the Spectrum of Turbulence. Proceedings of the Royal Society of London, ser. A, no. 920, vol. 165, 1938, p. 73.
18. Appel, P., and De Fériet, J. Kampé: Fonctions Hypergéométriques et hypersphériques. Polynomes d'Hermite. Ed. Gauthier-Villars.

TABLE I
TABLE OF THE PRINCIPAL SYMBOLS RELATED TO CORRELATION AND TO THE SPECTRA

Study of turbulence is made by examining the variation of the turbulent-velocity components	Variable quantity	Correlation coefficient		Correlation length	Turbulence spectrum		Variable quantity	Dimensionless symbols		
		Notations	Designation		Symbol	Designation		Correlation coefficient	Representative of frequency	Turbulence spectrum
Parallel to the direction A, measured at the same instant at the points of a straight line of the same direction (system of Euler)	r	$R_A^r(x)$	Figure 1(a)	$L_A^r = \int_0^\infty R_A^r(x) dx$	$f_A^r(\omega)$		$\rho^r = \frac{r}{L_A}$	$R_A^r(\rho^r) = R_A^r(x)$	$\rho_A^r = \frac{\omega L_A}{2\pi}$	$\phi_A^r(\rho_A^r) = \frac{f_A^r(\omega)}{L_A}$
Perpendicular to the direction A, measured at the same instant at the points of a straight line perpendicular to that direction (system of Euler)	r	$R_A^r(x)$	Figure 1(a)	$L_A^r = \int_0^\infty R_A^r(x) dx$	$f_A^r(\omega)$		$\rho^r = \frac{r}{L_A}$	$R_A^r(\rho^r) = R_A^r(x)$	$\rho_A^r = \frac{\omega L_A}{2\pi}$	$\phi_A^r(\rho_A^r) = \frac{f_A^r(\omega)}{L_A}$
Parallel to the direction of the mean velocity, measured at the same instant at the points of a straight line of direction A (system of Euler)	x	$R_A(x) = R_A^x(x)$	Correlation coefficient following direction A (fig. 1(b))	$L_A = \int_0^\infty R_A(x) dx$	$f_A(\omega) = f_A^x(\omega)$	Spectrum of the turbulence in the direction A	$\rho = \frac{x}{L_A}$	$R_A(\rho) = R_A(x)$	$\rho_A = \frac{\omega L_A}{2\pi}$	$\phi_A(\rho_A) = \frac{f_A(\omega)}{L_A}$
Parallel to the direction of the mean velocity, measured at the same instant at the points of a straight line of the same direction (system of Euler)	x	$R_x(x) = R_x^x(x)$	Longitudinal correlation coefficient (fig. 1(c))	$L_x = \int_0^\infty R_x(x) dx$	$f_x(\omega) = f_x^x(\omega)$	Longitudinal turbulence spectrum	$\rho = \frac{x}{L_x}$	$R_x(\rho) = R_x(x)$	$\rho_x = \frac{\omega L_x}{2\pi}$	$\phi_x(\rho_x) = \frac{f_x(\omega)}{L_x}$
Parallel to the direction of the mean velocity, measured at the same instant at the points of a straight line perpendicular to that direction (system of Euler)	y	$R_y(y) = R_y^y(y)$	Transverse correlation coefficient (fig. 1(d))	$L_y = \int_0^\infty R_y(y) dy$	$f_y(\omega) = f_y^y(\omega)$	Transverse turbulence spectrum	$\rho = \frac{y}{L_y}$	$R_y(\rho) = R_y(y)$	$\rho_y = \frac{\omega L_y}{2\pi}$	$\phi_y(\rho_y) = \frac{f_y(\omega)}{L_y}$
Parallel to the direction of the mean velocity, measured at the same point fixed with respect to space, as a function of the time (system of Euler)	h	$R_t(h) = R_t^h(h)$	Correlation coefficient at the fixed point	$L_t = \int_0^\infty R_t(h) dh$	$f_t(\omega) = f_t^h(\omega)$	Spectrum of O. K. Taylor	$\tau = \frac{h}{L_t}$	$R_t(\tau) = R_t(h)$	$\rho_t = \omega L_t$	$\phi_t(\rho_t) = \frac{f_t(\omega)}{L_t}$
Parallel to the direction of the mean velocity, measured at a point being displaced with this velocity, as a function of the time (pseudo-Eulerian system)	h	$R_p(h) = R_p^h(h)$	Correlation coefficient according to the mean motion	$L_p = \int_0^\infty R_p(h) dh$	$f_p(\omega) = f_p^h(\omega)$	Spectrum of the turbulence in the mean motion	$\tau_p = \frac{h}{L_p}$	$R_p(\tau_p) = R_p(h)$	$\rho_p = \omega L_p$	$\phi_p(\rho_p) = \frac{f_p(\omega)}{L_p}$
Parallel to the direction of the mean velocity of the same particle as a function of the time (system of Lagrange)	h	$R_{LZ}(h) = R_{LZ}^h(h)$	Correlation coefficient of the Lagrange system	$L_{LZ} = \int_0^\infty R_{LZ}(h) dh$	$f_{LZ}(\omega) = f_{LZ}^h(\omega)$	Spectrum of J. Kampé de Fériet	$\tau_L = \frac{h}{L_{LZ}}$	$R_{LZ}(\tau_L) = R_{LZ}(h)$	$\rho_{LZ} = \omega L_{LZ}$	$\phi_{LZ}(\rho_{LZ}) = \frac{f_{LZ}(\omega)}{L_{LZ}}$
Perpendicular to the direction of the mean velocity, measured at the same instant at the points of a straight line of the direction A (system of Euler)	r	$R_A^r(x)$	Figure 1(b)	$L_A^r = \int_0^\infty R_A^r(x) dx$	$f_A^r(\omega)$		$\rho^r = \frac{r}{L_A}$	$R_A^r(\rho^r) = R_A^r(x)$	$\rho_A^r = \frac{\omega L_A}{2\pi}$	$\phi_A^r(\rho_A^r) = \frac{f_A^r(\omega)}{L_A}$
Perpendicular to the direction of the mean velocity measured at the same instant at the points of a straight line of the same direction (system of Euler)	x	$R_A^r(x)$	Figure 1(c)	$L_A^r = \int_0^\infty R_A^r(x) dx$	$f_A^r(\omega)$		$\rho^r = \frac{r}{L_A}$	$R_A^r(\rho^r) = R_A^r(x)$	$\rho_A^r = \frac{\omega L_A}{2\pi}$	$\phi_A^r(\rho_A^r) = \frac{f_A^r(\omega)}{L_A}$
Perpendicular to the direction of the mean velocity, measured at the same instant at the points of a straight line perpendicular to that direction (system of Euler)	y	$R_A^r(y)$	Figure 1(d)	$L_A^r = \int_0^\infty R_A^r(y) dy$	$f_A^r(\omega)$		$\rho^r = \frac{r}{L_A}$	$R_A^r(\rho^r) = R_A^r(y)$	$\rho_A^r = \frac{\omega L_A}{2\pi}$	$\phi_A^r(\rho_A^r) = \frac{f_A^r(\omega)}{L_A}$
Perpendicular to the direction of the mean velocity, measured at the same point fixed with respect to space as a function of the time (system of Euler)	h	$R_A^r(h)$		$L_A^r = \int_0^\infty R_A^r(h) dh$	$f_A^r(\omega)$		$\tau^r = \frac{h}{L_A}$	$R_A^r(\tau^r) = R_A^r(h)$	$\rho_A^r = \omega L_A$	$\phi_A^r(\rho_A^r) = \frac{f_A^r(\omega)}{L_A}$
Perpendicular to the direction of the mean velocity, measured at a point being displaced with this velocity as a function of the time (pseudo-Eulerian system)	h	$R_A^r(h)$		$L_A^r = \int_0^\infty R_A^r(h) dh$	$f_A^r(\omega)$		$\tau^r = \frac{h}{L_A}$	$R_A^r(\tau^r) = R_A^r(h)$	$\rho_A^r = \omega L_A$	$\phi_A^r(\rho_A^r) = \frac{f_A^r(\omega)}{L_A}$
Perpendicular to the direction of the mean velocity of the same particle, as a function of the time (system of Lagrange)	h	$R_A^r(h)$		$L_A^r = \int_0^\infty R_A^r(h) dh$	$f_A^r(\omega)$		$\tau^r = \frac{h}{L_A}$	$R_A^r(\tau^r) = R_A^r(h)$	$\rho_A^r = \omega L_A$	$\phi_A^r(\rho_A^r) = \frac{f_A^r(\omega)}{L_A}$

TABLE II
COMPARATIVE TABLE FOR SYMBOLS RELATING TO THE CORRELATION AND TO
THE SPECTRA USED BY DIFFERENT AUTHORS

The present report		J. Kampé de Fériet	G. I. Taylor	A. A. Hall	Th. Kármán and H. G. Dryden	H. Motzfeld	A. A. Kalinske and E. R. van Driest
	Dimensionless symbols	Refs. 3, 4, 5	Refs. 6, 7, 8	Ref. 9	Refs. 10, 11, 13	Ref. 14	Ref. 15
$R_{\Delta}^L(x)$	$R_{\Delta}^L(\rho^L)$				R_1		
$R_{\Delta}^H(x)$	$R_{\Delta}^H(\rho^H)$				R_2		
$R_x(X)$	$R_x(\xi)$		$R_x(R_1)$	R_1	R_x, R_2		
$R_y(y)$	$R_y(\eta)$		$R_y(R_2)$	R_2	R, R_t		
$R_{tL}(h)$	$R_{tL}(\tau_L)$	$R(h)$					
$R_x^V(x)$	$R_x^V(\xi^V)$						R_x
$R_y^V(y)$	$R_y^V(\eta^V)$						R_y
$R_t^V(h)$	$R_t^V(\tau^V)$						R'_t
$R_{tL}^V(h)$	$R_{tL}^V(\tau_L^V)$		R_t, R_t				R_t
L_x			L_1		L_x		
L_y			L_2, l_2		L		
L_x^V							L_2
ω	$\frac{\Omega_t}{L_t}$ $\frac{\Omega_{tL}}{L_{tL}}$	ω			$2\pi n$	ω	$K = 2\pi n$
$f_t(\omega)$	$L_t \Phi_t(\Omega_t)$				$\frac{1}{2\pi} F(n)$	$f(\omega)$	
$f_{tL}(\omega)$	$L_{tL} \Phi_{tL}(\Omega_{tL})$	$f(\omega)$					$\frac{1}{2\pi} F_n$

TABLE III

Name	Measuring results	Grid mesh in cm	Distance from the measuring point to the grid in mesh lengths	Mean velocity, cm/s	Remarks	References					
Correlation curves											
NBS.1	$R_y(y)$	12.70	40		One will use the experimental points without applying the correction taking into account the length of the hot wire	Ref. 11, fig. 21					
NBS.2	$R_y(y)$.65	40	1,220		Ref. 11, fig. 5					
NBS.3	$R_y(y)$	1.27	40	1,220		Ref. 11, fig. 5					
NBS.4	$R_y(y)$	2.54	40	1,220		Ref. 11, fig. 5					
NBS.5	$R_y(y)$	8.25	40	1,220		Ref. 11, fig. 5					
NBS.6	$R_y(y)$	12.70	40	1,220		Ref. 11, fig. 5					
NBS.7a	$R_x(x)$	2.54	40	1,220		One will use the experimental points without applying the correction taking into account the length of the hot wire	Ref. 11, fig. 28				
NBS.7b	$R_y(y)$										
NBS.8	$R_y(y)$.65					Ref. 11, fig. 25				
NBS.9	$R_y(y)$	2.54					Ref. 11, fig. 25				
NBS.10	$R_y(y)$	12.70									
H.1a	$R_x(x)$	1.27	32	610			One will use the experimental points without applying the correction taking into account the length of the hot wire	Ref. 9, fig. 17			
H.1b	$R_y(y)$										
H.2a	$R_x(x)$	1.27	57.5	610	One will use the experimental points without applying the correction taking into account the length of the hot wire			Ref. 9, fig. 17			
H.2b	$R_y(y)$										
H.3a	$R_x(x)$.65	28	610				One will use the experimental points without applying the correction taking into account the length of the hot wire	Ref. 9, fig. 12		
H.3b	$R_y(y)$										
H.4a	$R_x(x)$.65	85	610					One will use the experimental points without applying the correction taking into account the length of the hot wire	Ref. 9, fig. 12	
H.4b	$R_y(y)$										
NPL.1a	$R_x(x)$	7.62	27.5			One will use the experimental points without applying the correction taking into account the length of the hot wire				Ref. 7, fig. 4	
NPL.1b	$R_y(y)$										
NPL.2	$R_{TL}(h)$	2.29	25.5	610						Curve calculated by means of diffusion measurements	Ref. 6, p. 474
NPL.3	$R_y(y)$	2.29		765							Ref. 6, fig. 1
EGR.1a	$R_x(x)$.95	24				One will use the experimental points without applying the correction taking into account the length of the hot wire			Ref. 16, fig. 3	
EGR.1b	$R_y(y)$										
EGR.1c	$R_m(h)$										
KD.1a	$R_y^v(x)$			19.8	One will use the experimental points without applying the correction taking into account the length of the hot wire					Ref. 15, fig. 3, 5	
KD.1b	$R_y^v(y)$										
KD.1c	$R_t^v(h)$										
Turbulence spectra											
NBS.11	$f_t(m)$	2.54	40					Experiments near the wall	Ref. 12, fig. 1		
NBS.12	$f_t(m)$	2.54	160			Ref. 12, fig. 2					
NBS.4a	$f_t(m)$			457		Experiments near the wall			Ref. 17, table II		
NPL.4b	$f_t(m)$			610							
NPL.4c	$f_t(m)$	7.62	27.5	762							
NPL.4d	$f_t(m)$			915							
NPL.4e	$f_t(m)$			1,067							
M.1	$f_t(m)$			100							

TABLE IV

	$L^{(ap)}$	L	$[\underline{L}^{(1)}]^{(ap)}$	$[\underline{L}^{(2)}]^{(ap)}$		$L^{(ap)}$	L	$[\underline{L}^{(1)}]^{(ap)}$	$[\underline{L}^{(2)}]^{(ap)}$
NBS.1	2.72 cm		1.039	1.907	H.2a	1.800 cm			
NBS.2	0.251 cm	0.245 cm	0.909	1.242	H.2b	0.783 cm	0.770 cm	0.893	1.410
NBS.3	0.520 cm		0.894	1.561	H.3a	0.635 cm			
NBS.4	0.795 cm		0.794	1.194	H.3b	0.340 cm	0.334 cm	0.911	1.527
NBS.5	1.995 cm	1.945 cm	0.952	1.563	H.4a	0.980 cm			
NBS.6	2.845 cm		1.032	1.889	H.4b	0.558 cm		0.762	1.000
NBS.7a	0.945 cm		0.960	1.774	NPL.1a	2.74 cm		1.125	2.350
NBS.7b	0.682 cm		0.957	1.598	NPL.1b	1.55 cm	1.43 cm	0.967	1.718
NBS.8	0.240 cm		0.863	1.634	NPL.2	0.0044 s		1.157	2.687
NBS.9	0.768 cm		0.847	1.314	NPL.3	0.445 cm		0.752	0.976
NBS.10	0.82 cm		1.008	1.832	KD.1a	2.34 cm		0.986	0.905
H.1a	1.338 cm				KD.1b	2.90 cm		1.048	1.068
H.1b	0.634 cm	0.634 cm	0.928	1.587	KD.1c	0.208 s		1.250	2.895
					EGR.1b	4*		0.678	1.378

*In reference 16 the author has not given the measuring units.

TABLE V

Exp.	NBS.7	H.1	H.2	H.3	H.4	NPL.1
L_x/L_y	1.39	2.11	2.34	1.90	1.76	1.92

Exp.	KD.1
L_y^V/L_x^V	1.24

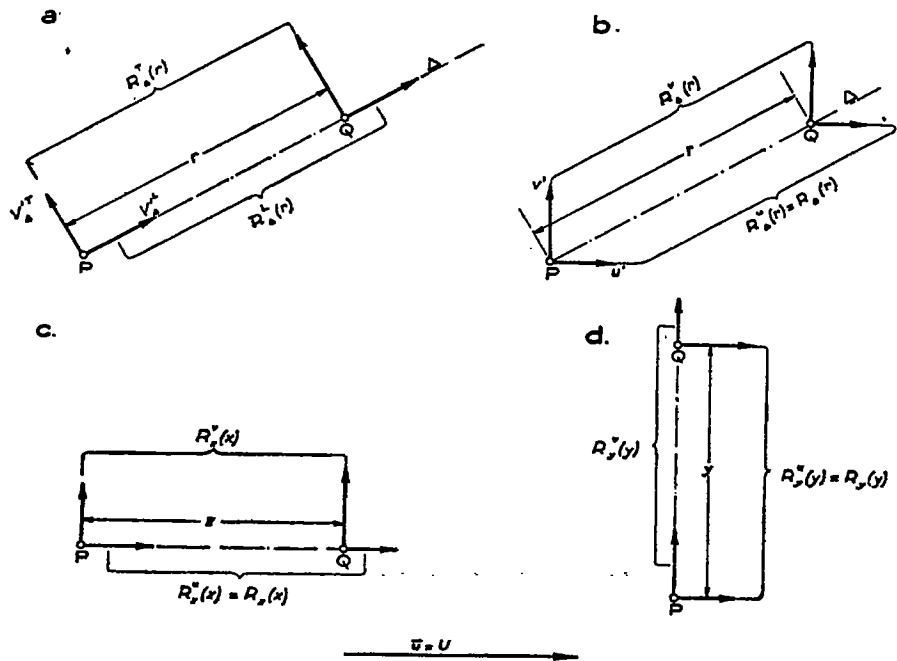

Figure 1.

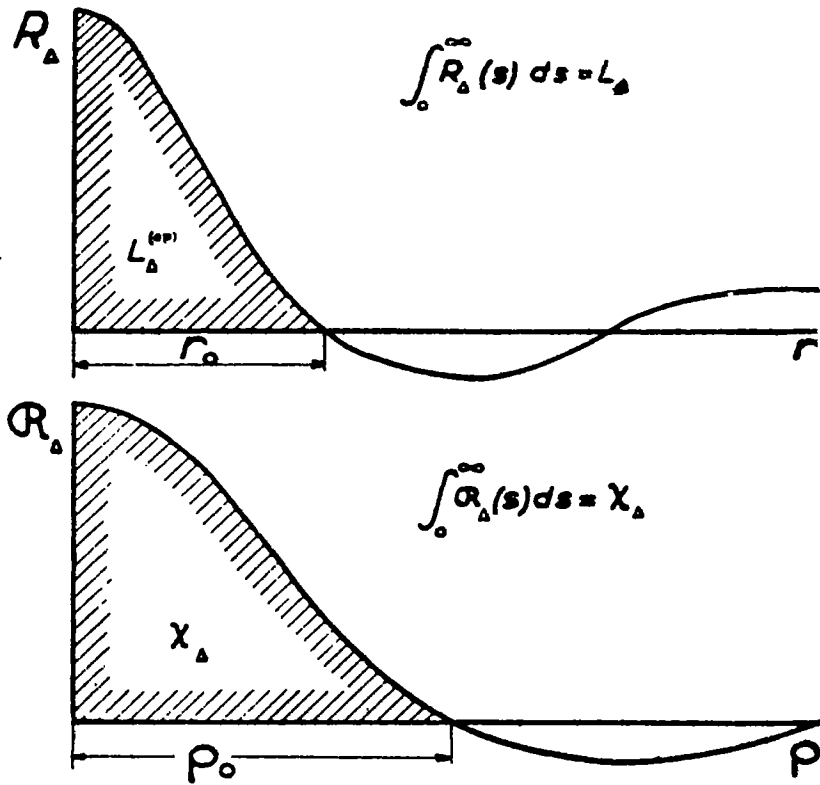

Figure 2.

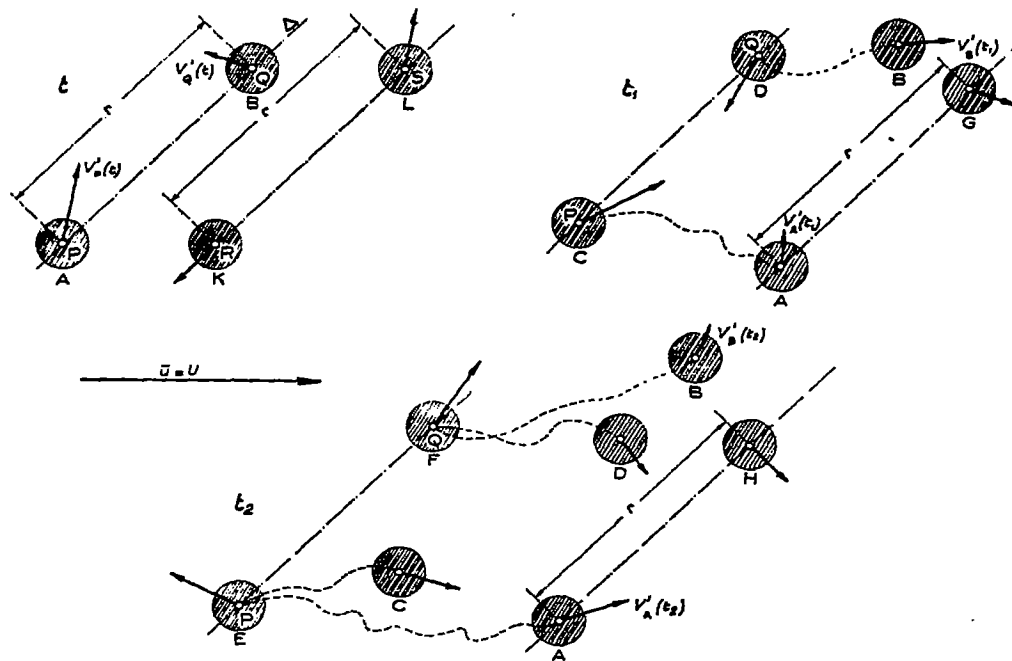

Figure 3.

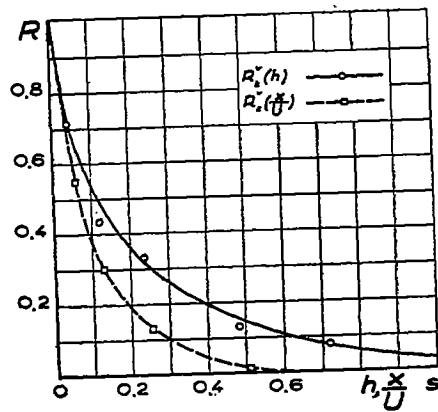

Figure 4.

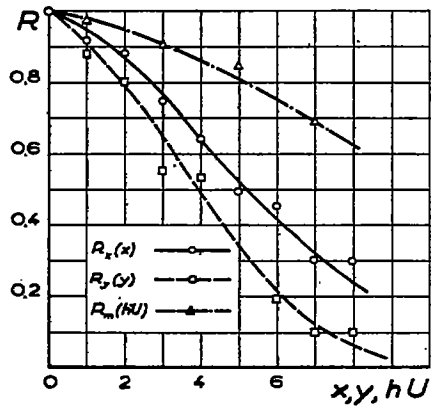

Figure 5.

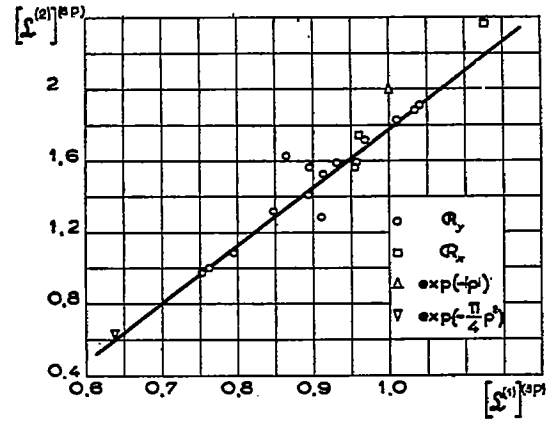

Figure 6.

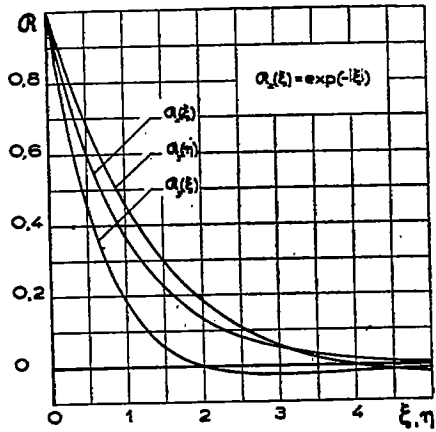

Figure 7.

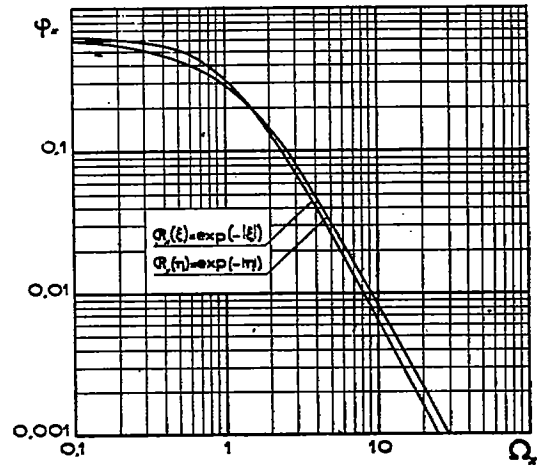

Figure 8.

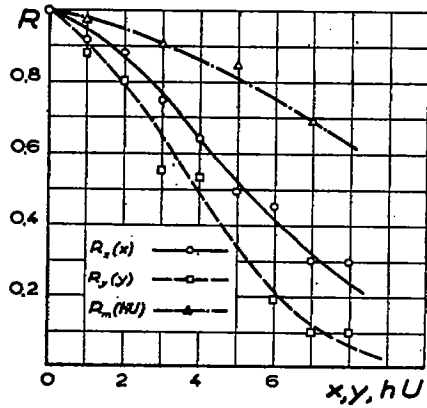

Figure 5.

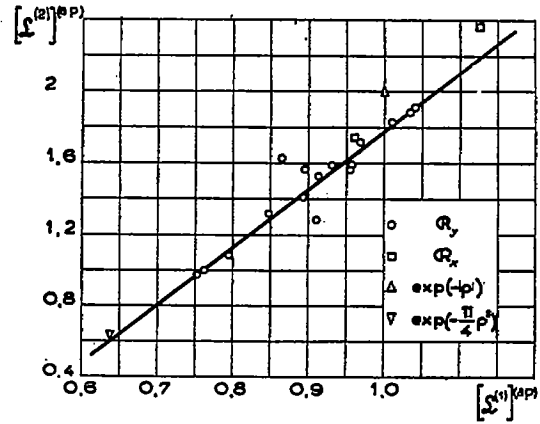

Figure 6.

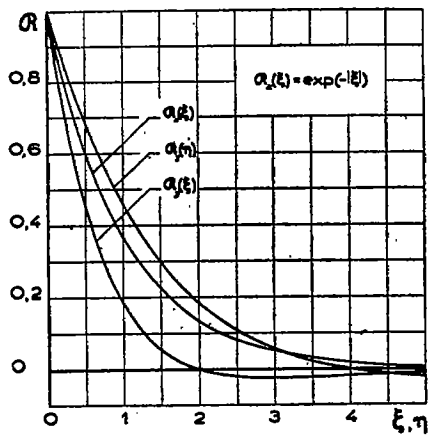

Figure 7.

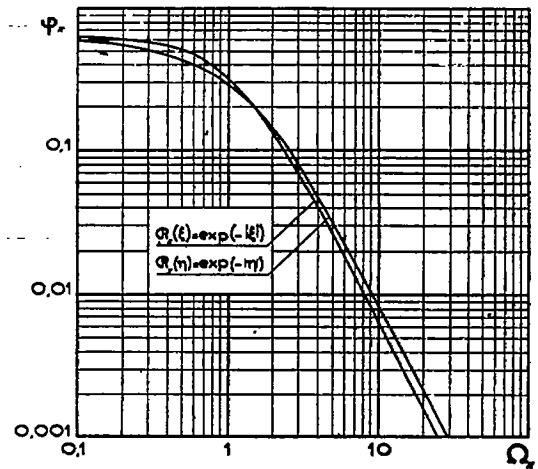

Figure 8.

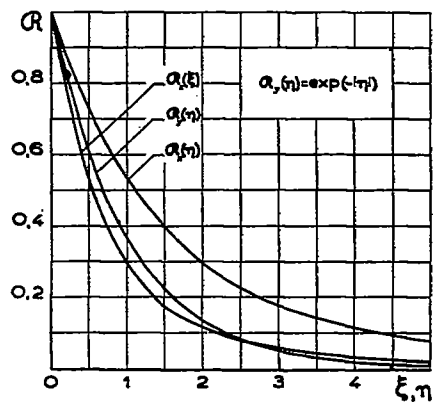

Figure 9.

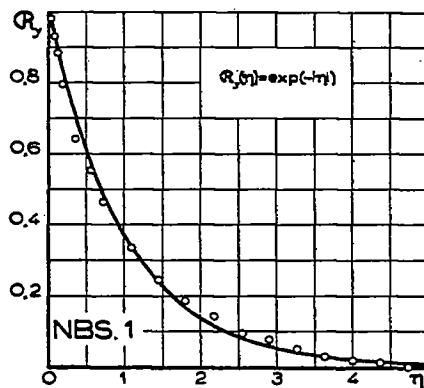

Figure 10.

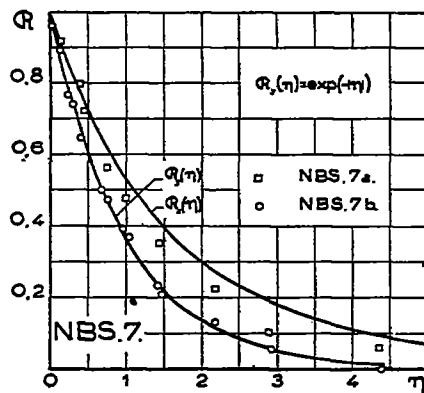

Figure 11.

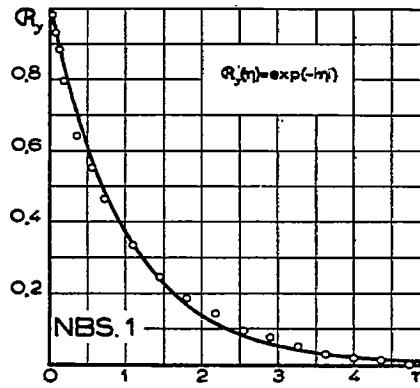
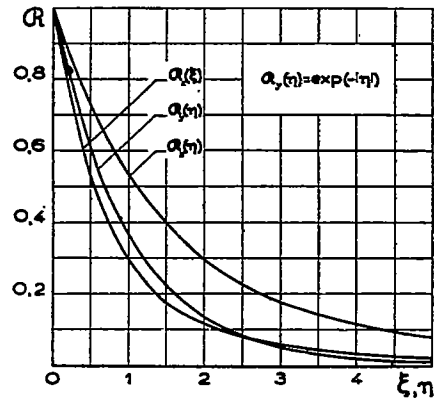

Figure 10.

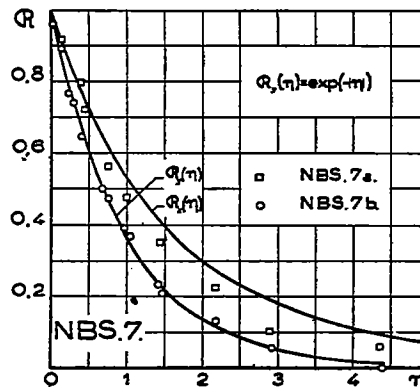

Figure 11.

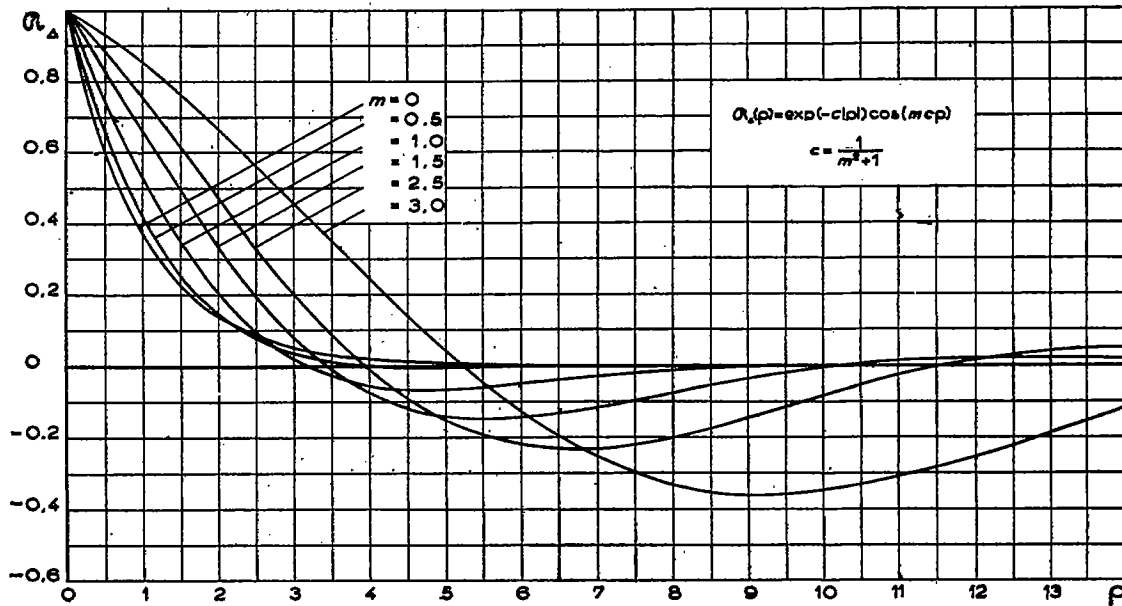

Figure 12.

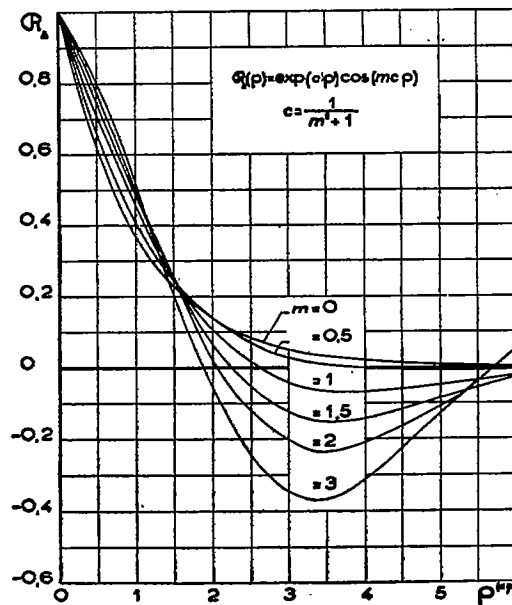

Figure 13.

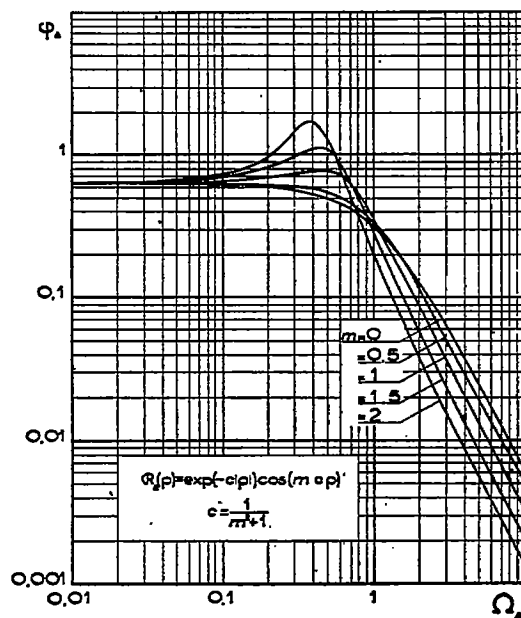

Figure 14.

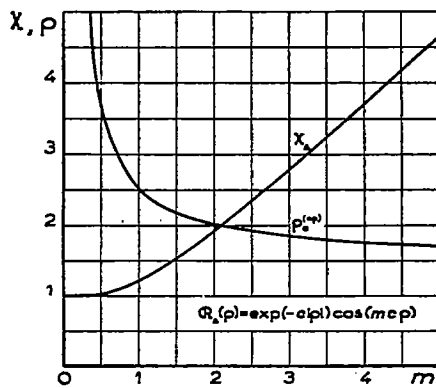

Figure 15.

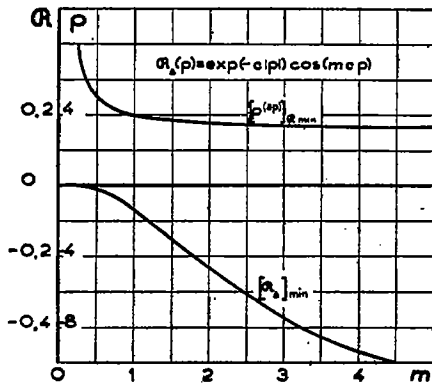

Figure 16.

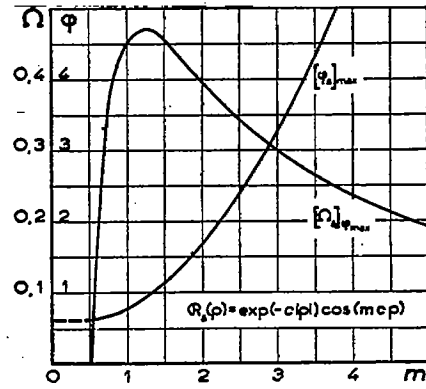

Figure 17.

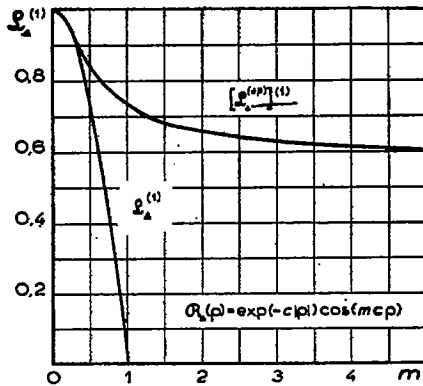

Figure 18.

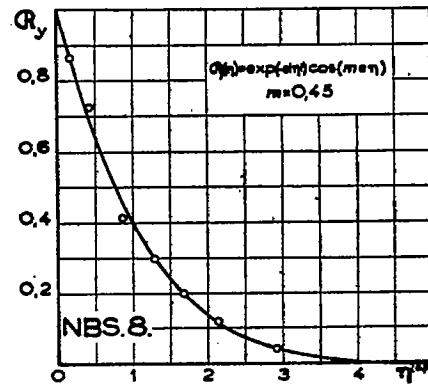

Figure 19.

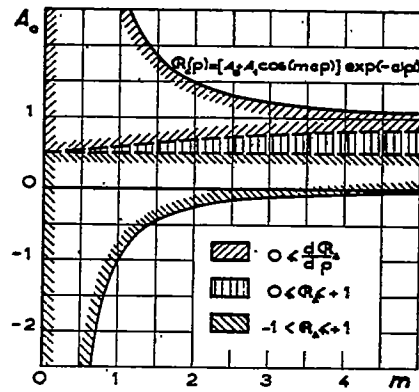

Figure 20.

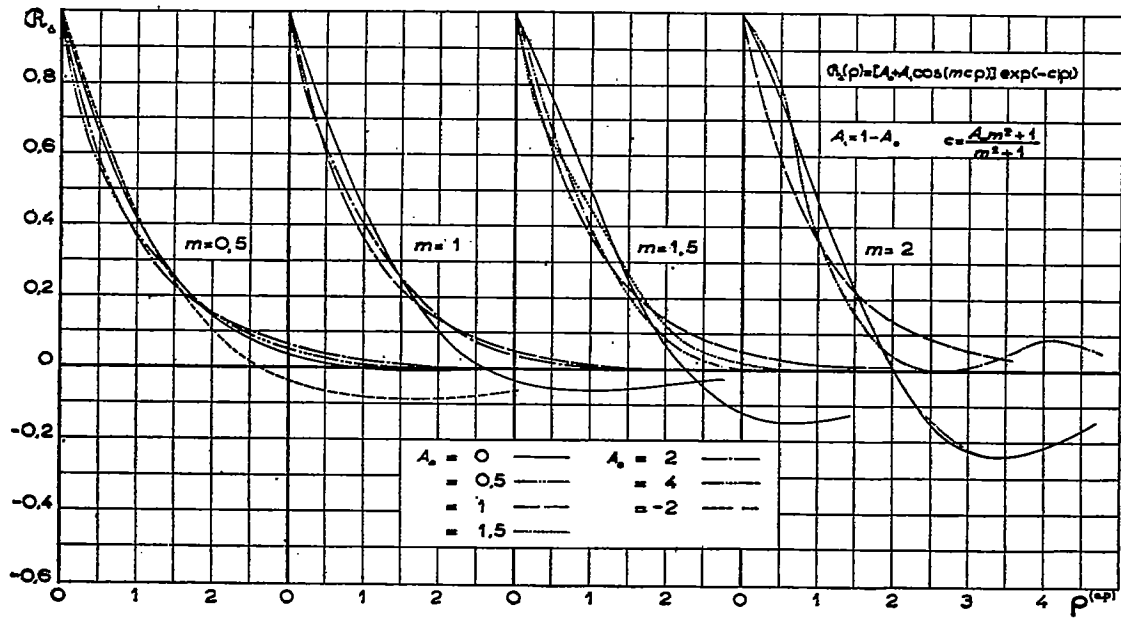

Figure 21.

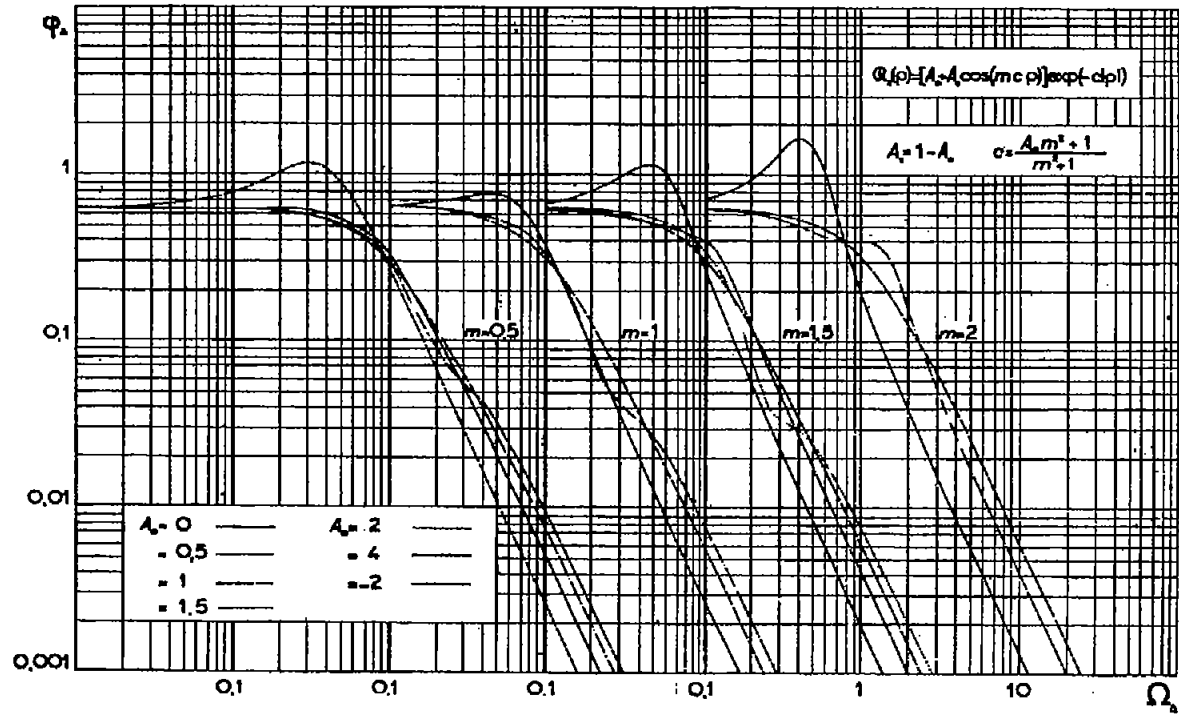

FIG. 22

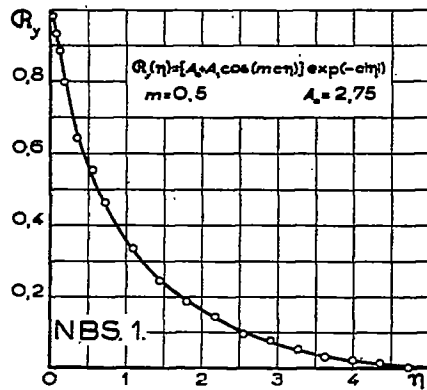

Figure 23.

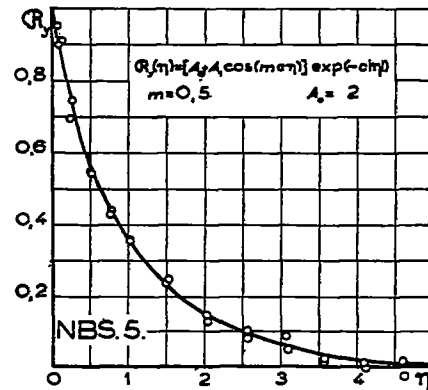

Figure 24.

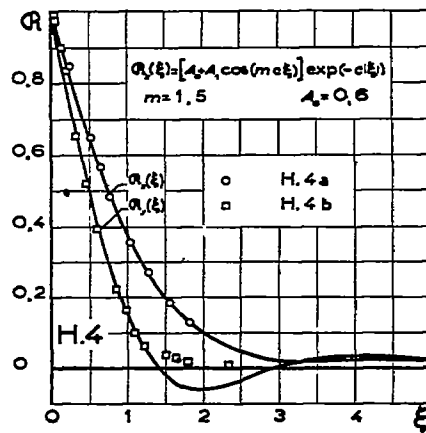

Figure 25.

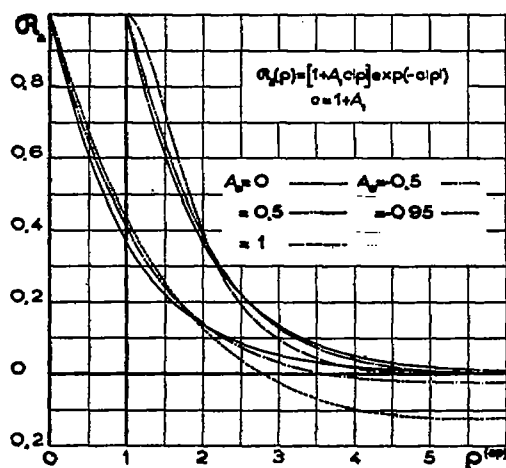

Figure 26.

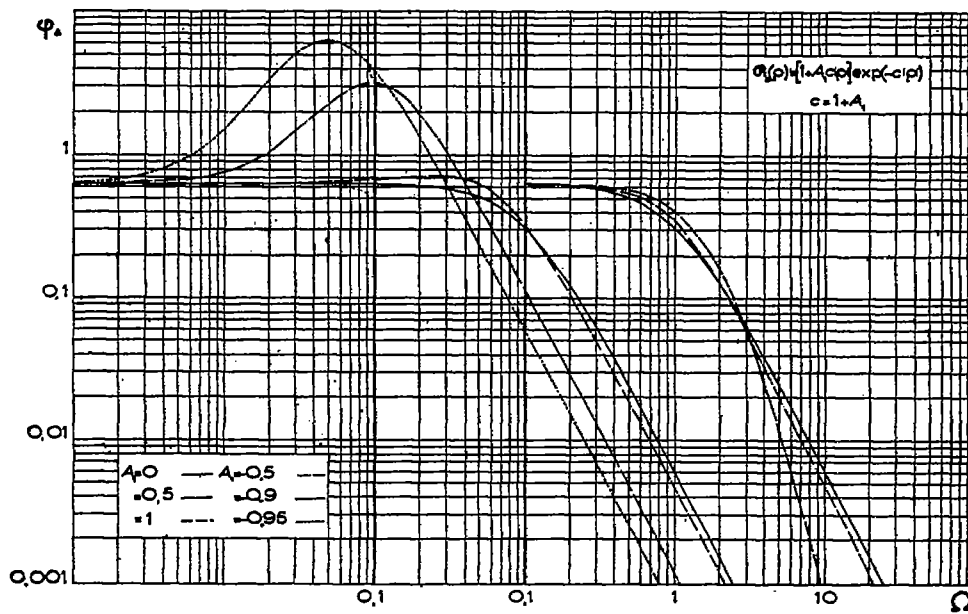

Figure 27.

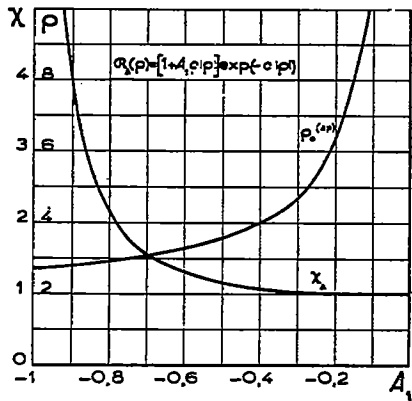

Figure 28.

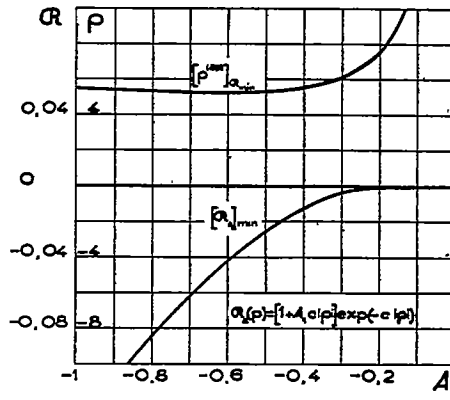

Figure 29.

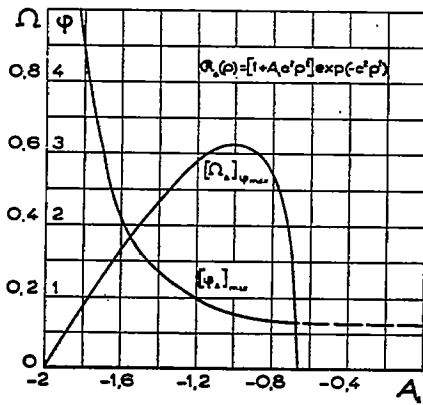

Figure 30.

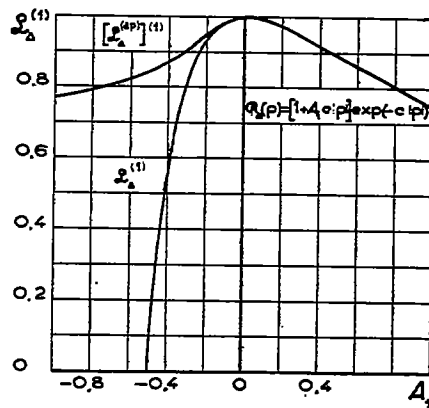

Figure 31.

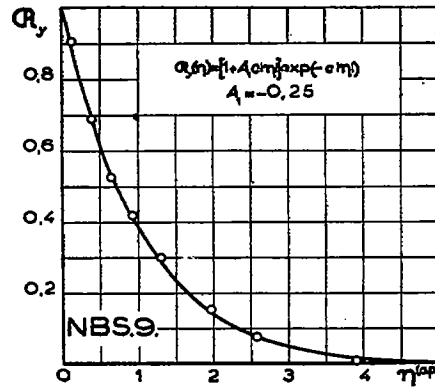

Figure 32.

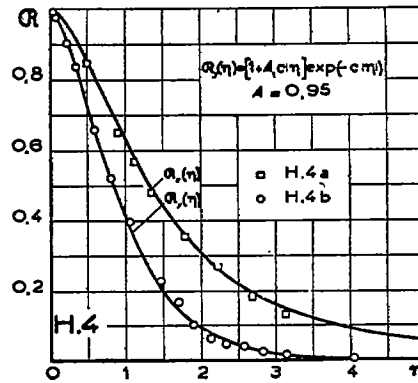

Figure 33.

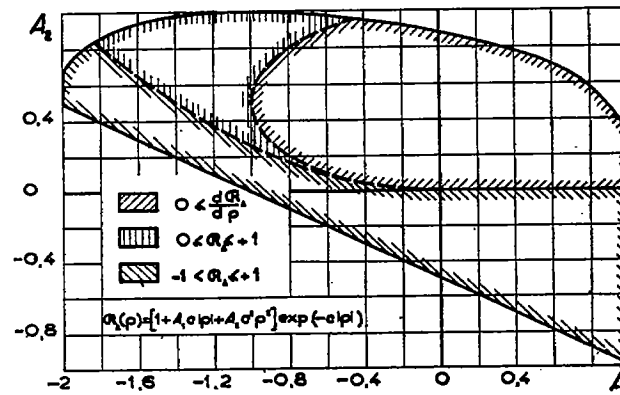

Figure 34.

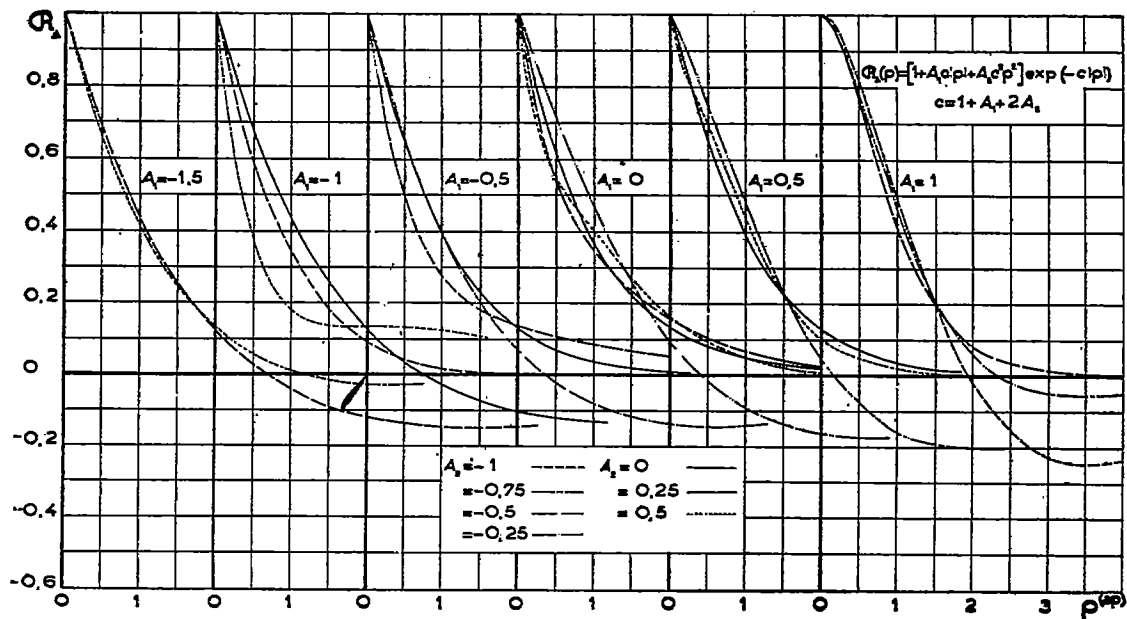

Figure 35.

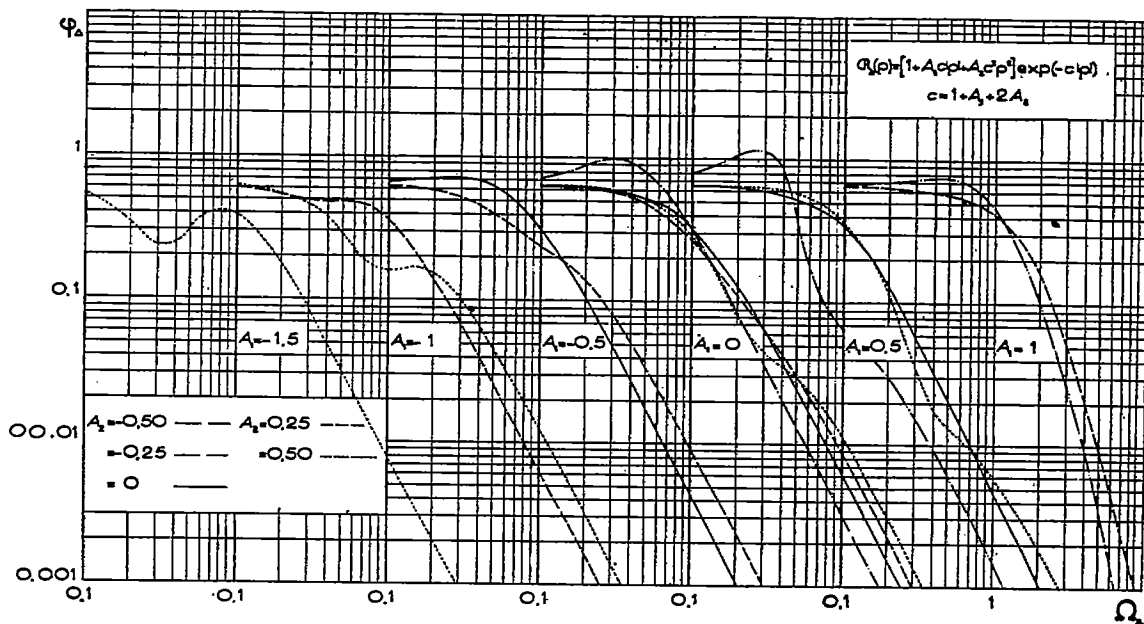

Figure 36.

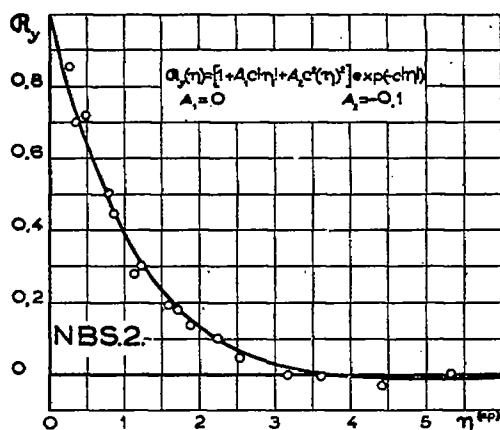

Figure 37.

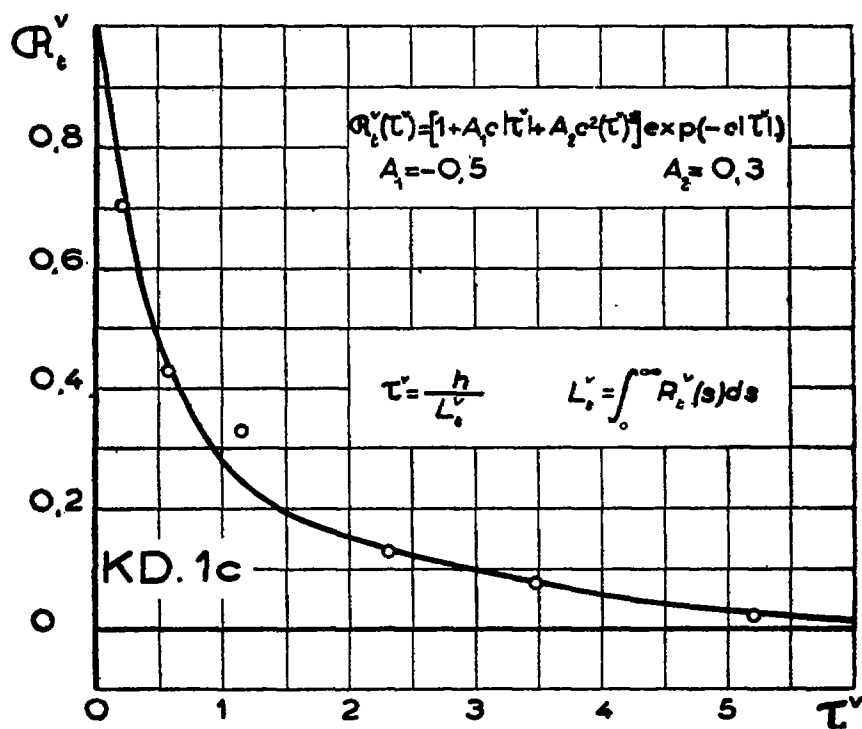

Figure 38.

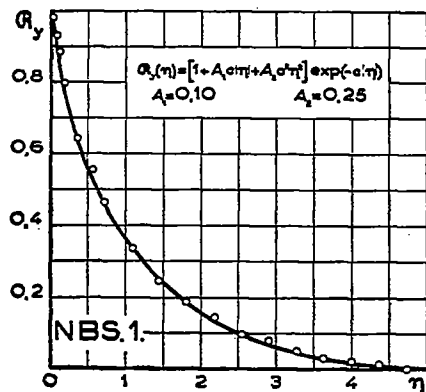

Figure 39.

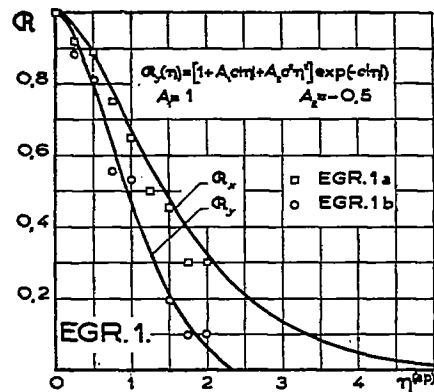

Figure 40.

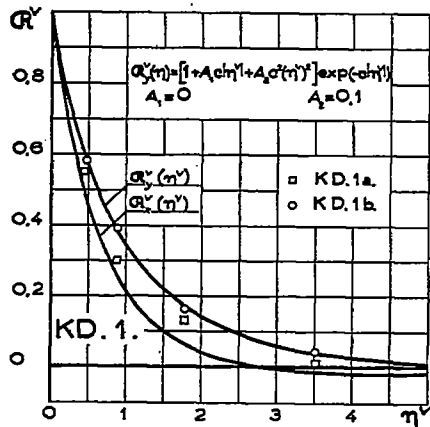

Figure 41.

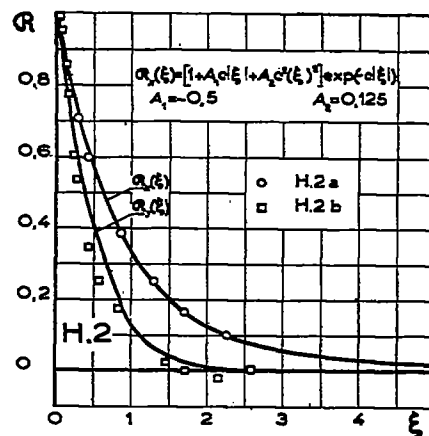

Figure 42.

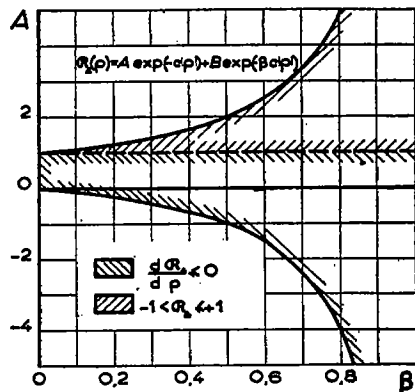

Figure 43.

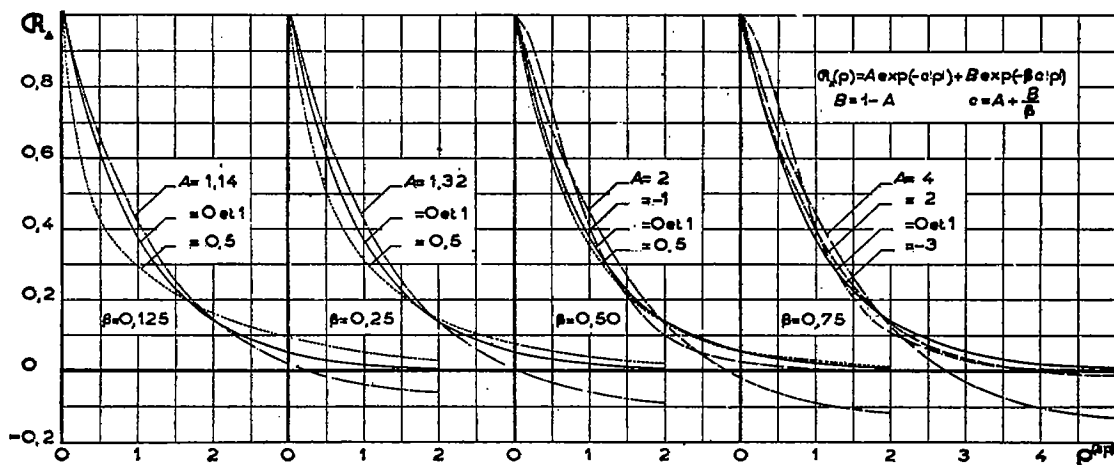

Figure 44.

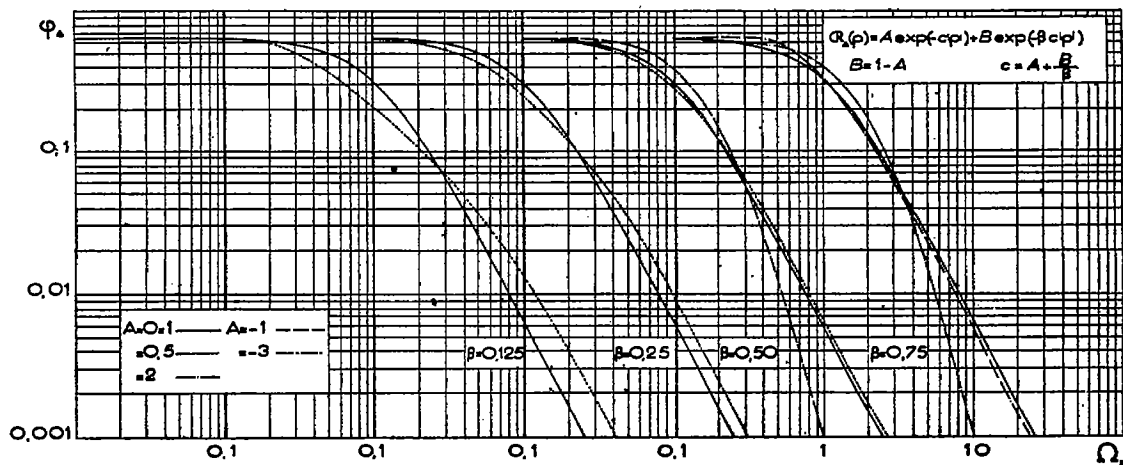

Figure 45.

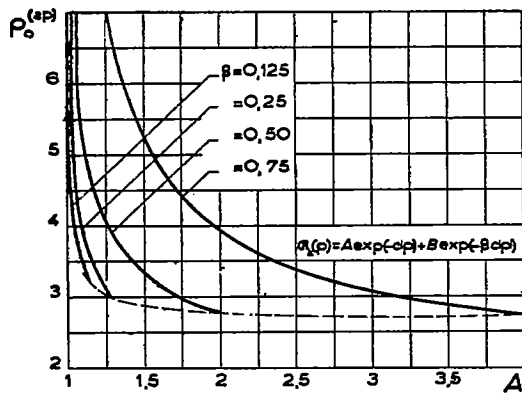

Figure 46.

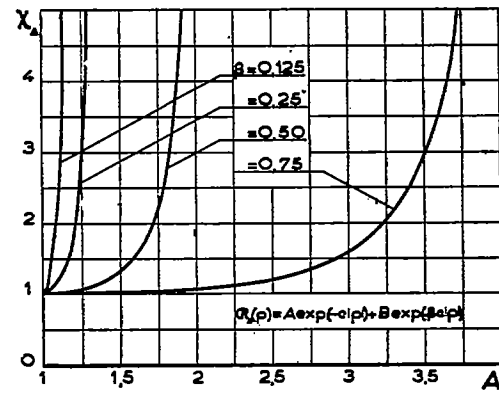

Figure 47.

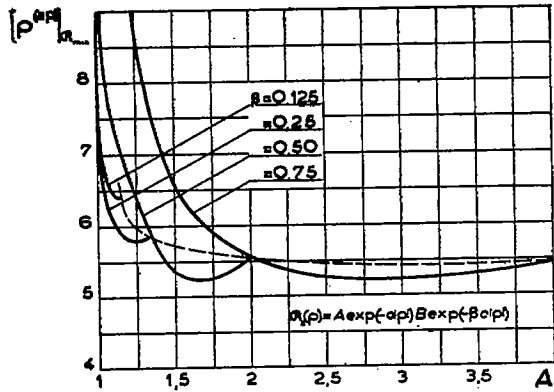

Figure 48.

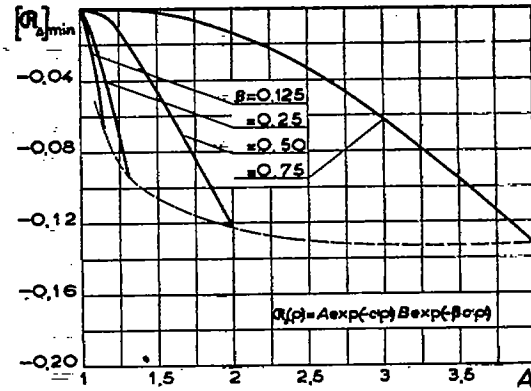

Figure 49.

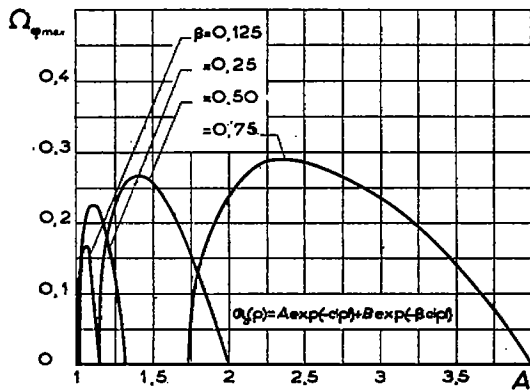

Figure 50.

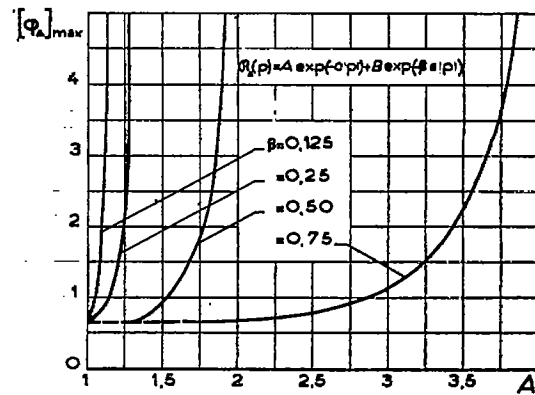

Figure 51.

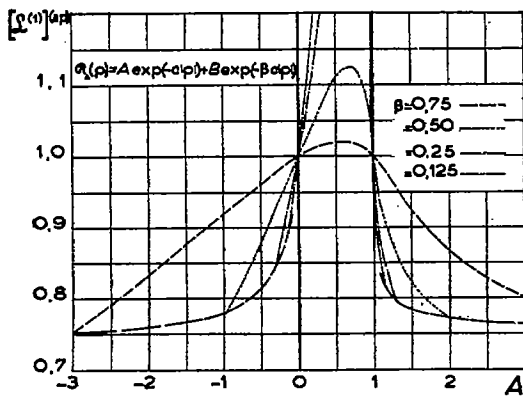

Figure 52.

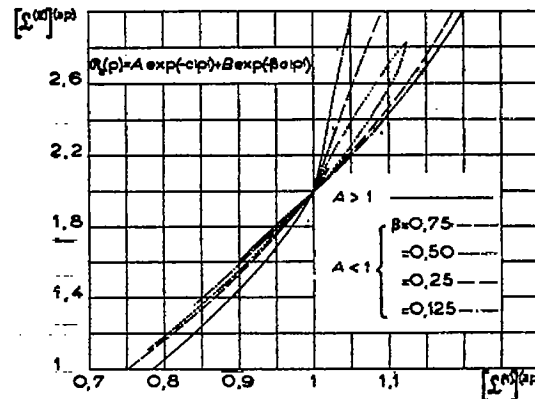

Figure 53.

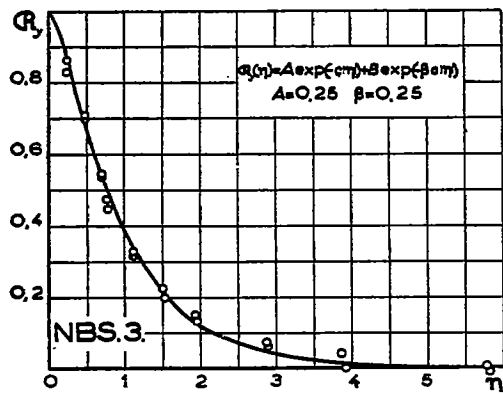

Figure 54.

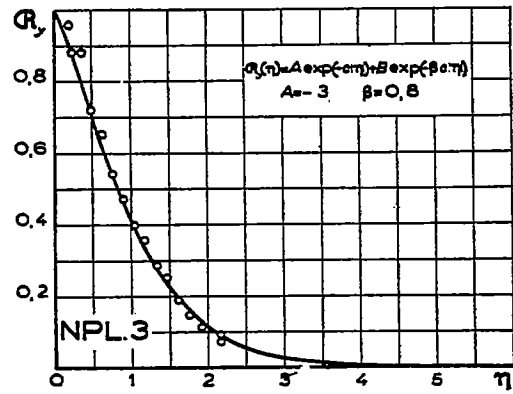

Figure 55.

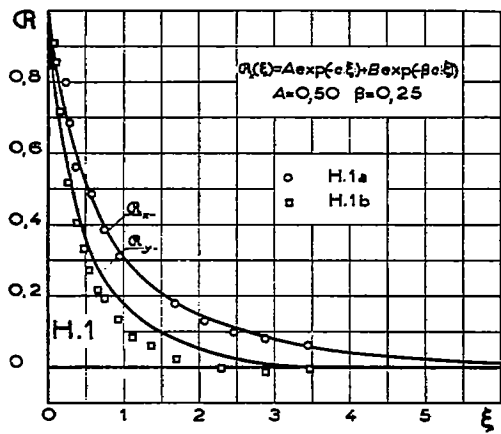

Figure 56.

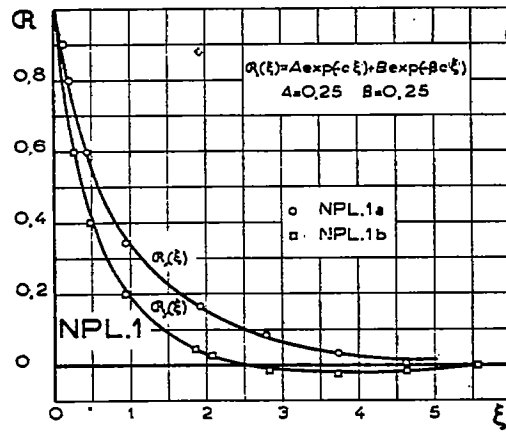

Figure 57.

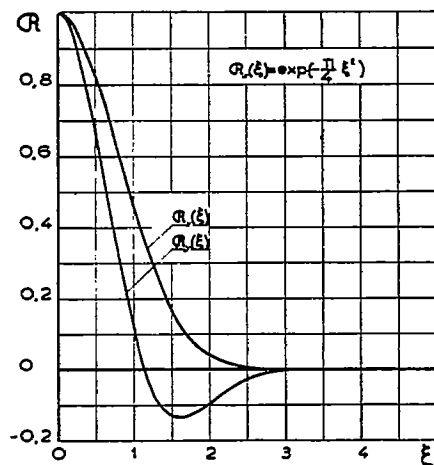

Figure 58.

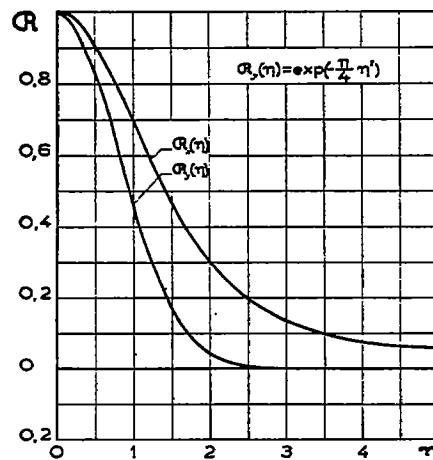

Figure 59.

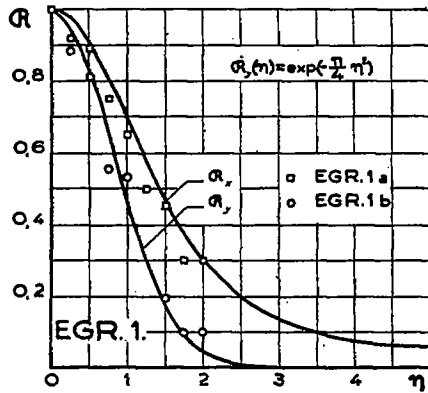

Figure 60.

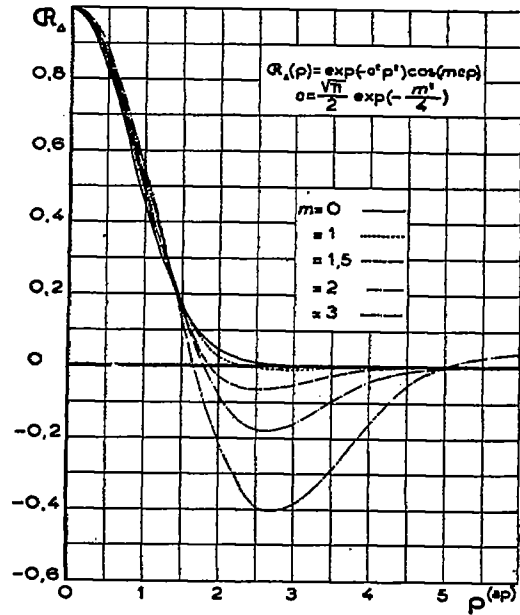

Figure 61.

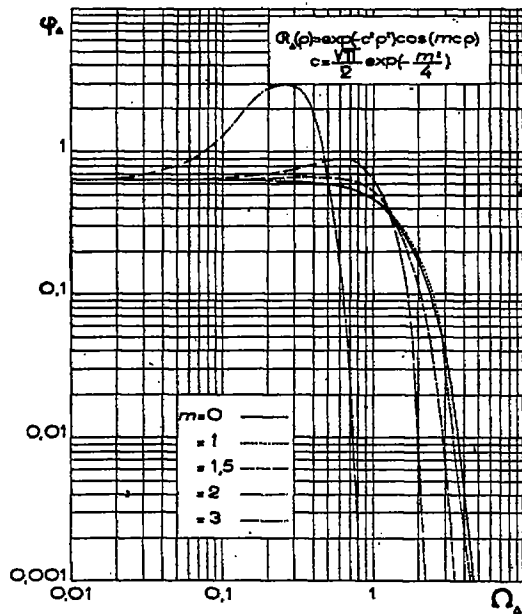

Figure 62.

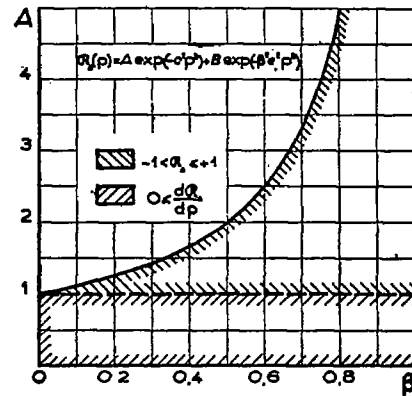

Figure 63.

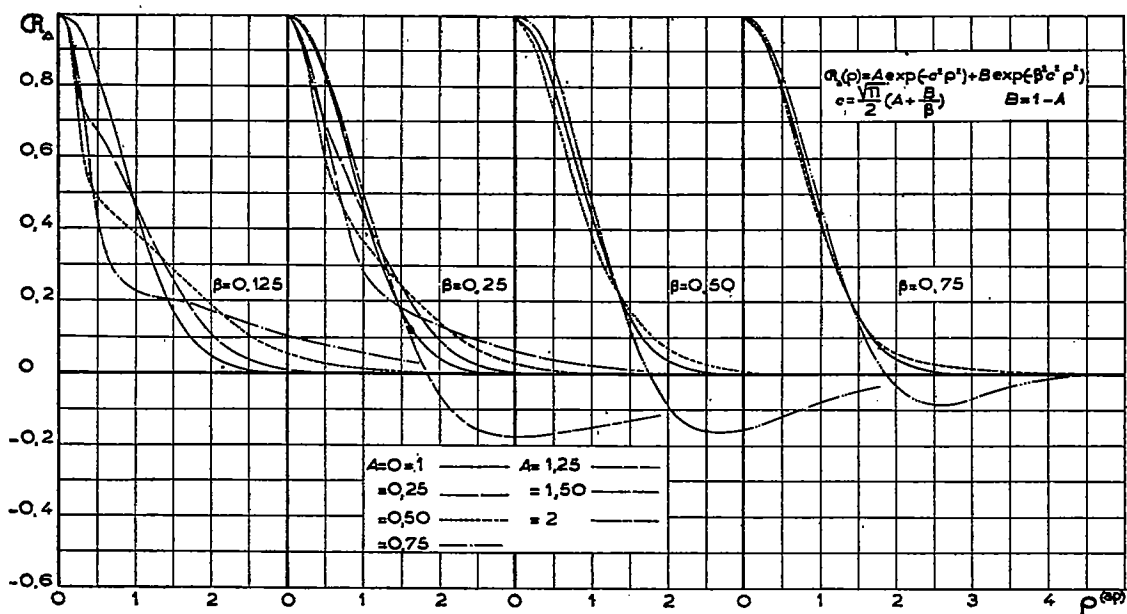

Figure 64.

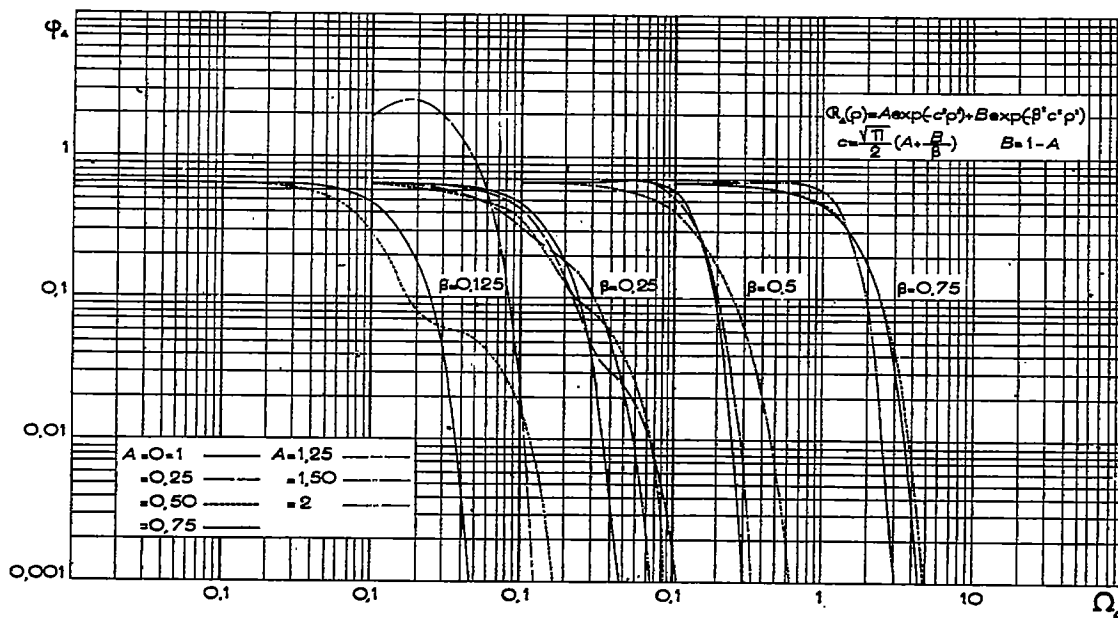

Figure 65.

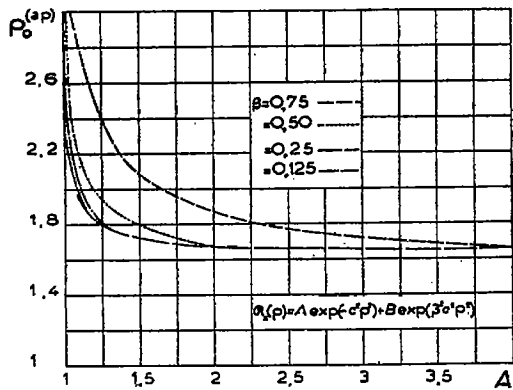

Figure 66.

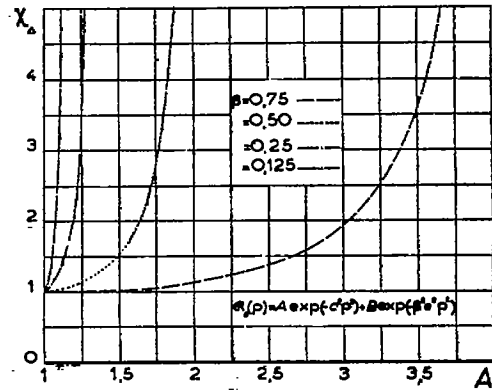

Figure 67.

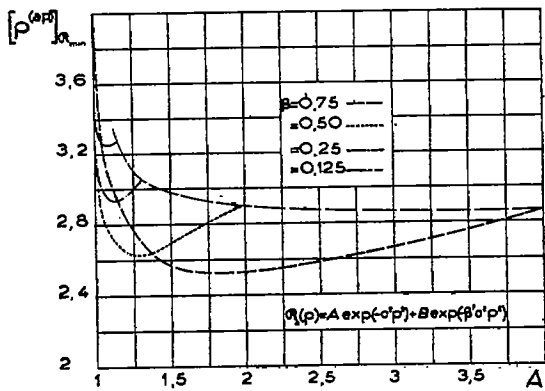

Figure 68.

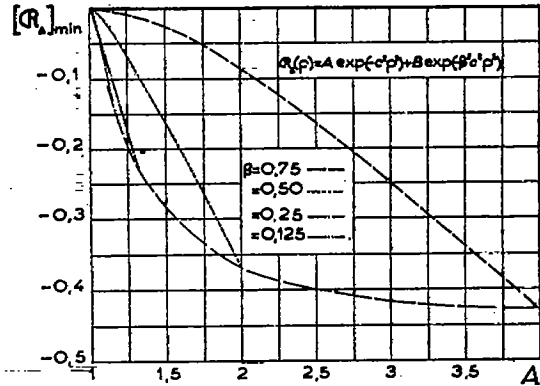

Figure 69.

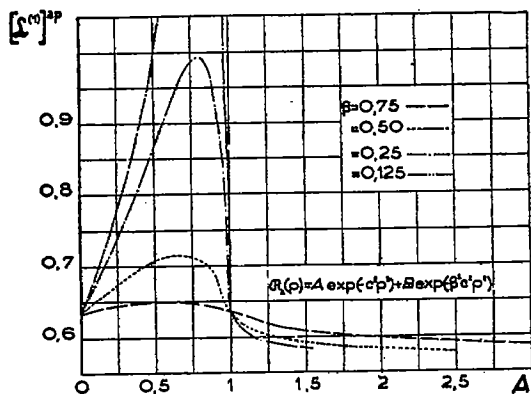

Figure 70.

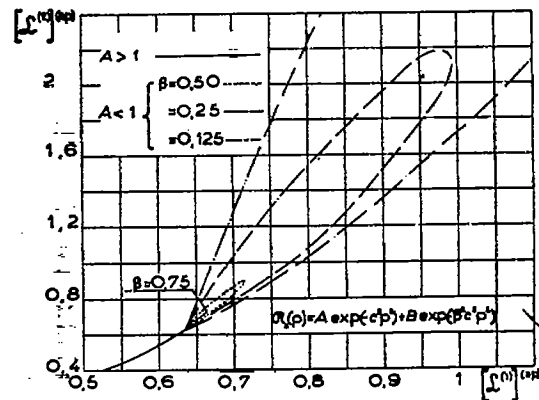

Figure 71.

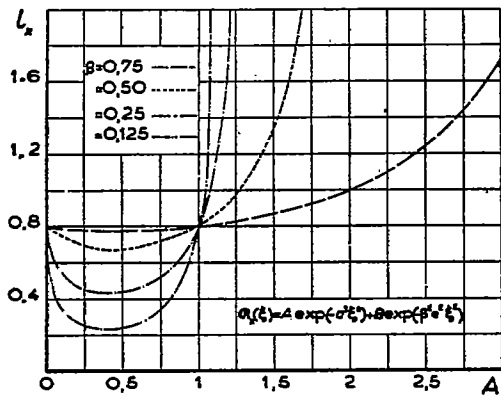

Figure 72.

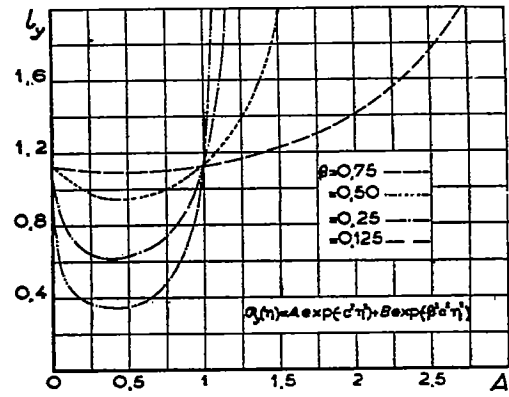

Figure 73.

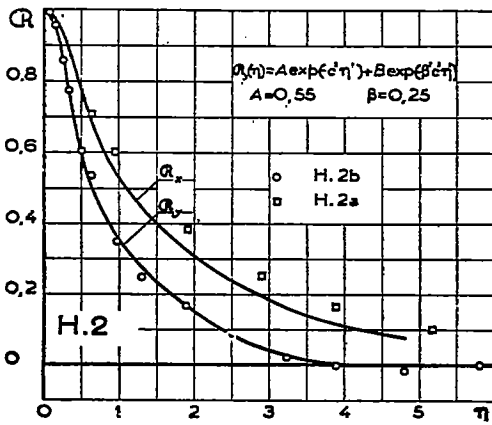

Figure 74.

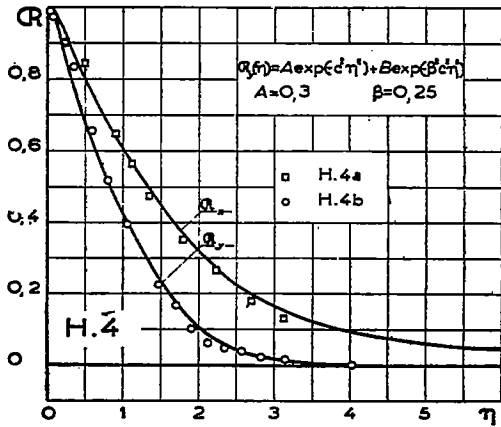

Figure 75.

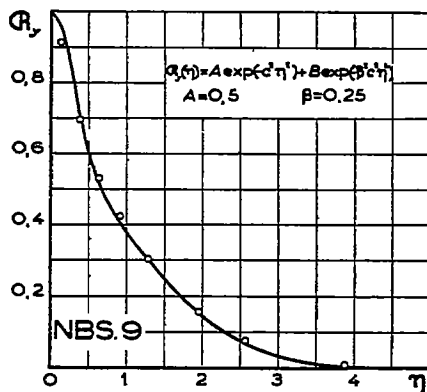

Figure 76.

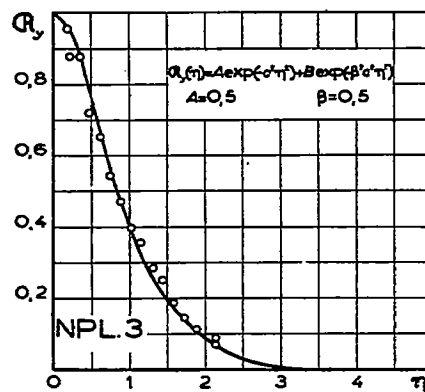

Figure 77.

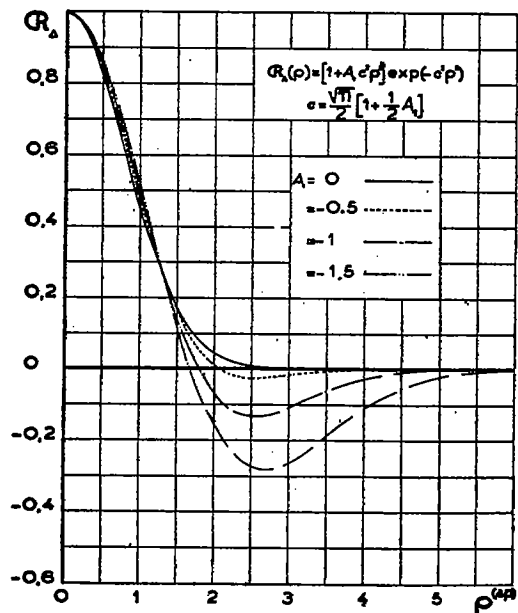

Figure 78.

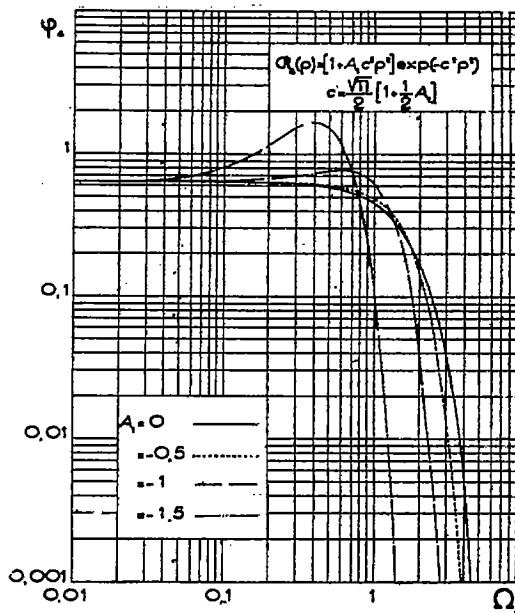

Figure 79.

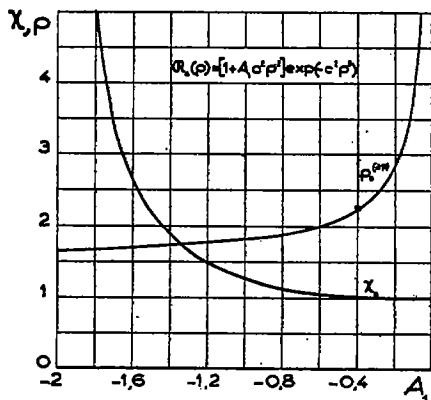

Figure 80.

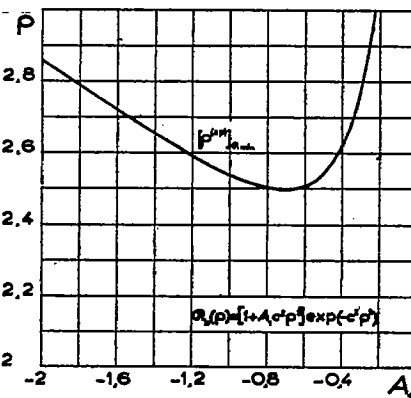

Figure 81.

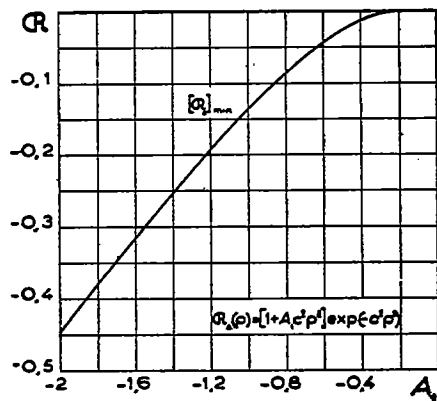

Figure 82.

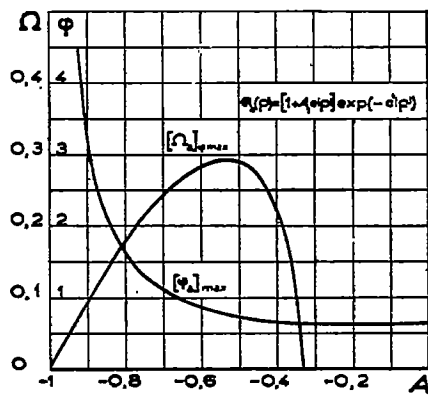

Figure 83.

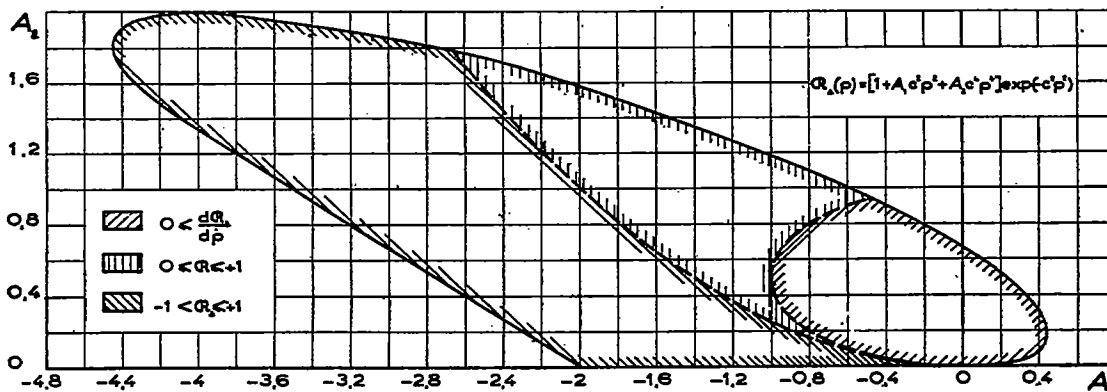

Figure 84.

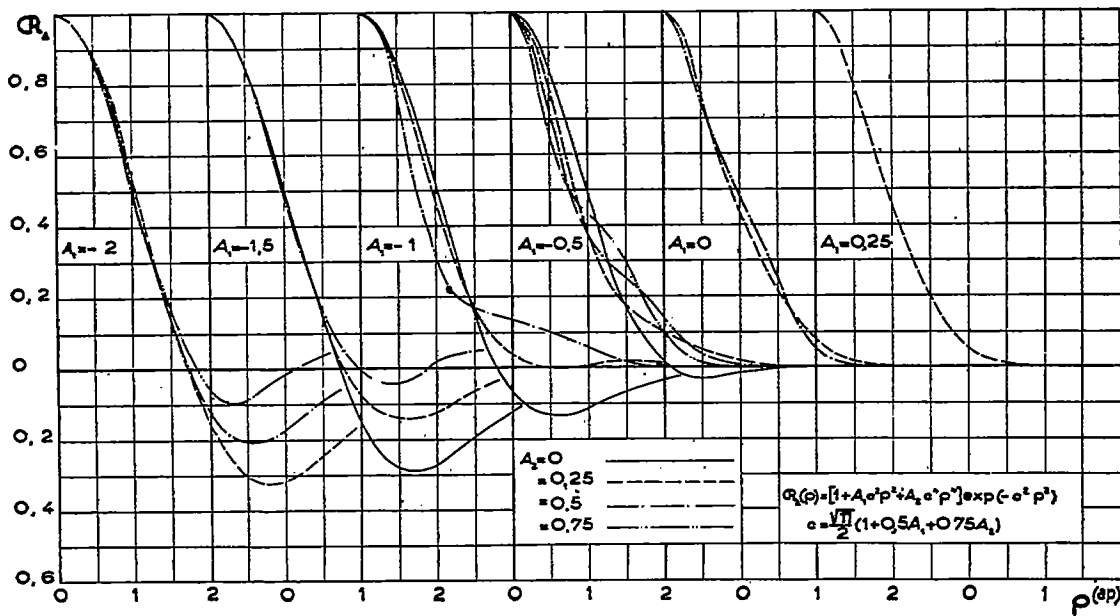

Figure 85.

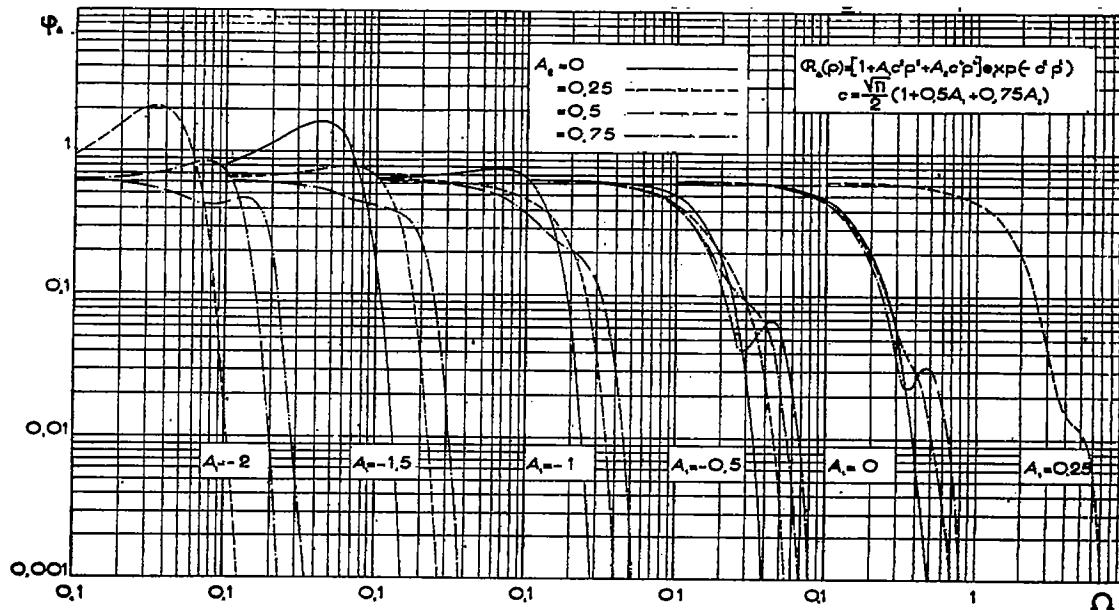

Figure 86.

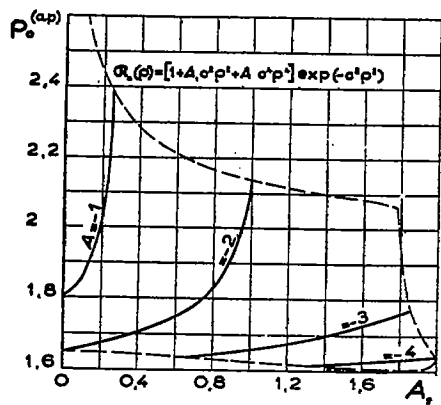

Figure 87.

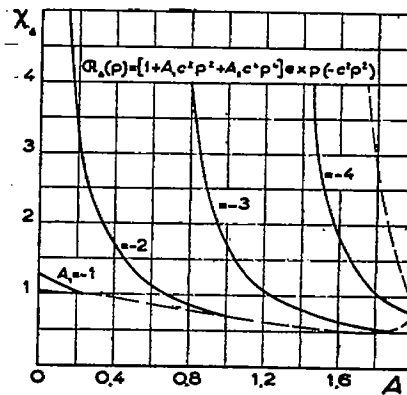

Figure 88.

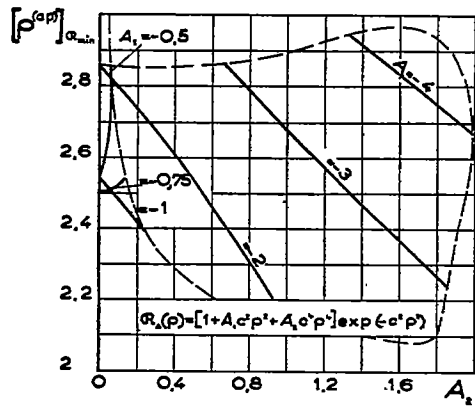

Figure 89.

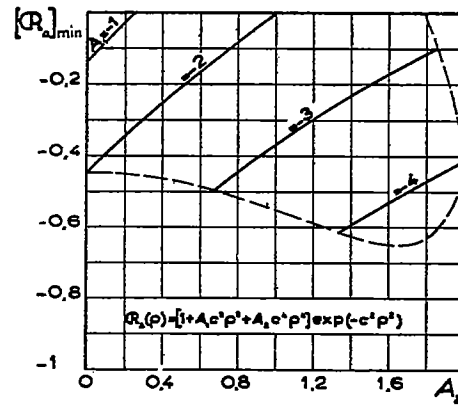

Figure 90.

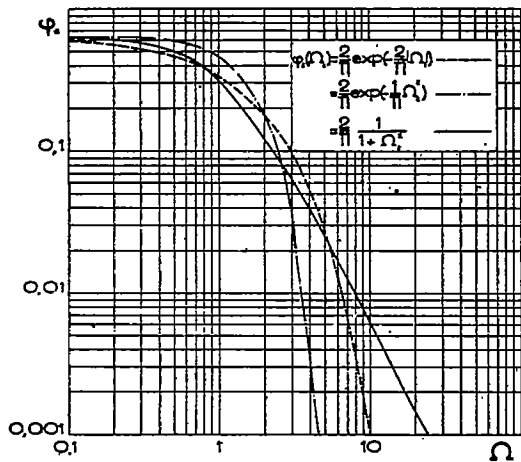

Figure 91.

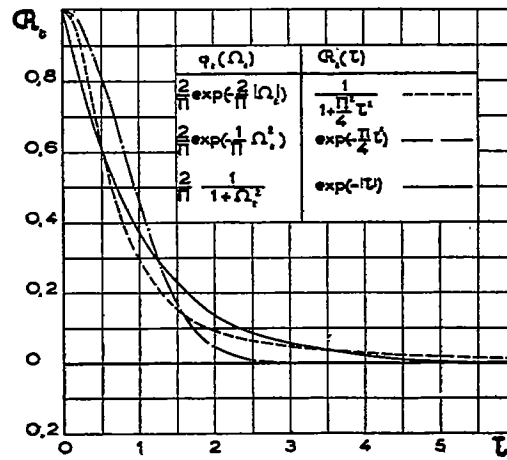

Figure 92.

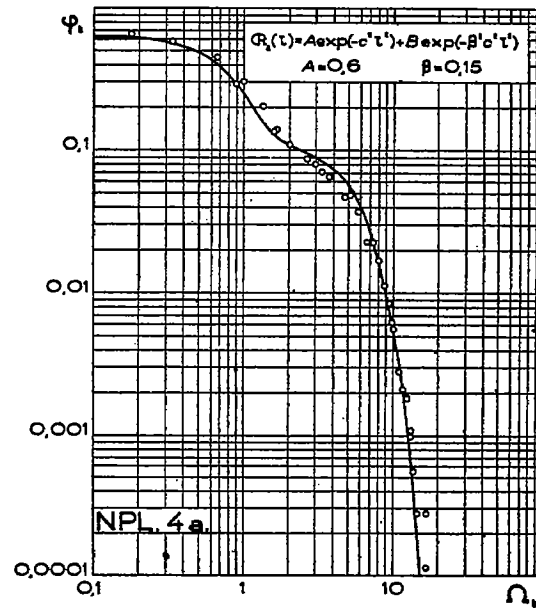

Figure 93.