

NASA/TM-2003-212042

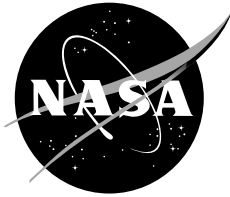

Evaluation of Two Unique Side Stick Controllers in a Fixed-Base Flight Simulator

*Jann Mayer and Timothy H. Cox
NASA Dryden Flight Research Center
Edwards, California*

December 2003

The NASA STI Program Office...in Profile

Since its founding, NASA has been dedicated to the advancement of aeronautics and space science. The NASA Scientific and Technical Information (STI) Program Office plays a key part in helping NASA maintain this important role.

The NASA STI Program Office is operated by Langley Research Center, the lead center for NASA's scientific and technical information. The NASA STI Program Office provides access to the NASA STI Database, the largest collection of aeronautical and space science STI in the world. The Program Office is also NASA's institutional mechanism for disseminating the results of its research and development activities. These results are published by NASA in the NASA STI Report Series, which includes the following report types:

- **TECHNICAL PUBLICATION.** Reports of completed research or a major significant phase of research that present the results of NASA programs and include extensive data or theoretical analysis. Includes compilations of significant scientific and technical data and information deemed to be of continuing reference value. NASA's counterpart of peer-reviewed formal professional papers but has less stringent limitations on manuscript length and extent of graphic presentations.
- **TECHNICAL MEMORANDUM.** Scientific and technical findings that are preliminary or of specialized interest, e.g., quick release reports, working papers, and bibliographies that contain minimal annotation. Does not contain extensive analysis.
- **CONTRACTOR REPORT.** Scientific and technical findings by NASA-sponsored contractors and grantees.
- **CONFERENCE PUBLICATION.** Collected papers from scientific and technical conferences, symposia, seminars, or other meetings sponsored or cosponsored by NASA.
- **SPECIAL PUBLICATION.** Scientific, technical, or historical information from NASA programs, projects, and mission, often concerned with subjects having substantial public interest.
- **TECHNICAL TRANSLATION.** English-language translations of foreign scientific and technical material pertinent to NASA's mission.

Specialized services that complement the STI Program Office's diverse offerings include creating custom thesauri, building customized databases, organizing and publishing research results...even providing videos.

For more information about the NASA STI Program Office, see the following:

- Access the NASA STI Program Home Page at <http://www.sti.nasa.gov>
- E-mail your question via the Internet to help@sti.nasa.gov
- Fax your question to the NASA Access Help Desk at (301) 621-0134
- Telephone the NASA Access Help Desk at (301) 621-0390
- Write to:
NASA Access Help Desk
NASA Center for AeroSpace Information
7121 Standard Drive
Hanover, MD 21076-1320

NASA/TM-2003-212042

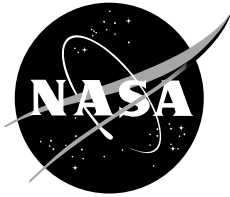

Evaluation of Two Unique Side Stick Controllers in a Fixed-Base Flight Simulator

*Jann Mayer and Timothy H. Cox
NASA Dryden Flight Research Center
Edwards, California*

National Aeronautics and
Space Administration

Dryden Flight Research Center
Edwards, California 93523-0273

December 2003

NOTICE

Use of trade names or names of manufacturers in this document does not constitute an official endorsement of such products or manufacturers, either expressed or implied, by the National Aeronautics and Space Administration.

Available from the following:

NASA Center for AeroSpace Information (CASI)
7121 Standard Drive
Hanover, MD 21076-1320
(301) 621-0390

National Technical Information Service (NTIS)
5285 Port Royal Road
Springfield, VA 22161-2171
(703) 487-4650

CONTENTS

	<u>Page</u>
ABSTRACT	1
NOMENCLATURE	1
INTRODUCTION	2
SYSTEM DESCRIPTION	3
Simulator	3
Evaluation Side Sticks	4
EVALUATIONS	8
Task Descriptions	8
Pilot History	12
Test Procedures	13
RESULTS AND DISCUSSION	16
Pilot Technique	22
Ergonomics	34
Rating Scatter	39
CONCLUDING REMARKS	45
REFERENCES	46

TABLES

	<u>Page</u>
Table 1. Motion characteristics of the side sticks	5
Table 2. Performance definitions for the target acquisition task	9
Table 3. Performance definitions for the target tracking task	10
Table 4. Performance definitions for the offset landing task	11
Table 5. Experience levels of the evaluation pilots	13
Table 6. Target acquisition task performance	19
Table 7. Target tracking task performance	20
Table 8. Offset landing task performance	20
Table 9. Summary of pilot comments	21
Table 10. Side stick damping and natural frequencies	28
Table 11. Target acquisition task performance criteria	43
Table 12. Target tracking task performance criteria	43
Table 13. Offset landing task performance criteria	44

FIGURES

	<u>Page</u>
Figure 1. Side stick mounted in simulator cockpit	4
Figure 2. X-Theta X stick	5
Figure 3. X-Theta Z stick	5
Figure 4. Stick force and displacement characteristics.	6
Figure 5. Armrest with elbow cup	6
Figure 6. X-Theta X stick, elbow cup, and mounting bracket	6
Figure 7. Side stick electrical connections	8
Figure 8. Target acquisition task.	9
Figure 9. Target tracking task.	10
Figure 10. Offset landing task initial conditions.	11
Figure 11. Offset landing task correction to centerline.	12
Figure 12. Pilot comment card	14
Figure 13. Cooper-Harper Rating scale (ref. 11)	14
Figure 14. Pilot induced oscillation scale (ref. 12).	15
Figure 15. Target acquisition task Cooper-Harper Ratings	16
Figure 16. Target tracking task Cooper-Harper Ratings.	17
Figure 17. Offset landing task Cooper-Harper Ratings	17
Figure 18. Target acquisition task pilot induced oscillation ratings.	18
Figure 19. Target tracking task pilot induced oscillation ratings	18
Figure 20. Offset landing task pilot induced oscillation ratings.	19
Figure 21. Comparison of pilot techniques with X-Theta Z stick, target acquisition task	22
Figure 22. Target acquisition task workload, low gain pilots highlighted	23
Figure 23. Target acquisition task command rate, low gain pilots highlighted	24
Figure 24. Target acquisition task Cooper-Harper Ratings, low gain pilots highlighted	25
Figure 25. Target tracking task Cooper-Harper Ratings, low gain pilots highlighted	25
Figure 26. Offset landing task Cooper-Harper Ratings, low gain pilots highlighted	26
Figure 27. Target acquisition task pilot induced oscillation ratings, low gain pilots highlighted	26
Figure 28. Target tracking task pilot induced oscillation ratings, low gain pilots highlighted.	27
Figure 29. Offset landing task pilot induced oscillation ratings, low gain pilots highlighted	27
Figure 30. Oscillation at natural frequency of X-Theta Z stick	28
Figure 31. Target acquisition task pitch command, high gain pilot (No. 1).	30
Figure 32. Target acquisition task roll command, high gain pilot (No. 1)	31
Figure 33. Target acquisition task pitch command, low gain pilot (No. 3)	32
Figure 34. Target acquisition task roll command, low gain pilot (No. 3).	33

Figure 35. Target tracking task command searching, X-Theta X stick (pilot 5) 35
Figure 36. Pitch wandering with X-Theta X stick (pilot 3) 37
Figure 37. Command coordination, target tracking task. 38
Figure 38. Longitudinal handling qualities. 40
Figure 39. Steady-state roll response to 1-in. roll command 42

This page left blank intentionally.

ABSTRACT

A handling qualities analysis has been performed on two unique side stick controllers in a fixed-base F-18 flight simulator. Each stick, which uses a larger range of motion than is common for similar controllers, has a moving elbow cup that accommodates movement of the entire arm for control. The sticks are compared to the standard center stick in several typical fighter aircraft tasks. Several trends are visible in the time histories, pilot ratings, and pilot comments. The aggressive pilots preferred the center stick, because the side sticks are underdamped, causing overshoots and oscillations when large motions are executed. The less aggressive pilots preferred the side sticks, because of the smooth motion and low breakout forces. The aggressive pilots collectively gave the worst ratings, probably because of increased sensitivity of the simulator (compared to the actual F-18 aircraft), which can cause pilot-induced oscillations when aggressive inputs are made. Overall, the elbow cup is not a positive feature, because using the entire arm for control inhibits precision. Pilots had difficulty measuring their performance, particularly during the offset landing task, and tended to overestimate.

NOMENCLATURE

A/D	analog-to-digital
CAP	control anticipation parameter
CHR	Cooper-Harper Rating
<i>DEP</i>	pitch command, in.
<i>g</i>	gravitational acceleration, 32.2 ft/sec ²
HUD	head-up display
K_q	pitch rate gain
LOES	low order equivalent system
LVDT	linear variable differential transformer
L_α	dimensional coefficient of lift resulting from angle of attack change, 1/sec
n_α	load factor resulting from angle of attack change, g/rad
NASA	National Aeronautics and Space Administration
p_{ss}	steady-state roll rate, deg/sec
PIO	pilot induced oscillation
PPB	Pilot Panel Box
<i>q</i>	pitch rate, rad/sec
s	Laplace operator
SSEB	Side Stick Electronics Box
T_{q_2}	pitch rate numerator zero
<i>v</i>	aircraft velocity, ft/sec
ζ	damping ratio

ζ_{sp}	pitch short period damping ratio
τ	pitch short period time constant, sec
ω_n	natural frequency, rad/sec
ω_{sp}	pitch short period natural frequency, rad/sec

INTRODUCTION

Aircraft have been predominantly designed with two types of pilot interfaces: yokes and center sticks. The yoke, common on transport aircraft, has a large mass, which impedes rapid maneuvering and often visually obstructs a portion of the instrument panel. Most fighter aircraft use center sticks. Although the center stick solves the two main disadvantages of the yoke, a few problems still exist. The stick can be fatiguing as a result of the large motion range. Furthermore, coupling problems can occur when the pilot attempts to make inputs to a single axis.

The development of fly-by-wire flight control systems introduced the possibility of force-sensing, small-displacement sticks, both center and side mounted. A number of studies have examined alternatives to yokes and center sticks (refs. 1, 2) and many of these studies have focused on side stick controllers.

The prototype F-16 aircraft (General Dynamics Corporation, Ft. Worth, Texas) used a nonmoving side stick, which was problematic, because it did not indicate when the maximum command had been reached (ref. 3). The production F-16 aircraft uses a force-sensing stick with limited displacement (approximately 1/8 in.). This limited amount of motion significantly improved the handling qualities (ref. 4). Another fly-by-wire aircraft of the same era, the F-18 (The Boeing Company, St. Louis, Missouri), uses a conventional center stick with a large range of motion. Although this stick is not mechanically connected to the control surfaces (with the exception of a pitch reversion mode), it operates much like a conventional center stick and is well liked by pilots.

Other motion characteristics have been tested with both types of controllers (refs. 5, 6, 7) but additional research is required to determine the optimal characteristics. For example, a large-displacement side stick is a concept that has not received much testing. Greater motion (± 1 in. displacements or more) might make the stick feel more familiar and natural to a pilot who is accustomed to conventional center sticks. This type of stick would offer the same benefits as those of limited-displacement side sticks, such as a reduced cockpit space requirement and improved control panel visibility. A large-displacement side stick also has the potential of acceptance by more pilots.

In addition to location and displacement characteristics, different types of motion might be designed into a side stick. The locations of the pivot axes for pitch and roll control affect how the pilot's arm will move and alter the overall feel of the stick. Experiments have been conducted on three-axis controllers, where pitch, roll, and yaw commands are generated with the same device. Reference 8 discusses the potential benefits of different configurations, such as reductions in both fatigue and bioharmonic interference effects.

Two large-displacement side sticks with unique motion types were designed and constructed by Dynamic Controls, Inc. (DCI) (Dayton, Ohio), for testing purposes (ref. 9). Both sticks were similarly

constructed, but each was built to explore different types of motion. One stick uses a translational motion for roll control, and the other uses a more conventional rotation. Both sticks use a translational motion for pitch control and have similar force-displacement gradients. Unlike most other side sticks, the DCI sticks require movement of the entire arm. Both side sticks have a translating and rotating armrest to support the elbow and accommodate required arm motions. This arrangement was designed to provide more comfort than that of small-displacement side sticks, which require only wrist motions. These sticks were designed to be decoupled, allowing the pilot to input pitch and roll commands independent of each other.

Some tests of the two side sticks had been conducted in an F-16 simulator (ref. 10), but additional evaluations were desired to obtain a greater range of data. To predict how the sticks would function in a fighter aircraft, evaluations were performed in a NASA Dryden Flight Research Center (Edwards, California) fixed-base F-18 flight simulator. The experiment compared the two side sticks to each other and compared both side sticks to the standard F-18 center stick.

Seven research pilots each flew three evaluation maneuvers using the three sticks. These maneuvers were typical fighter aircraft handling quality evaluation tasks: target acquisition, target tracking, and offset landing. To isolate the stick characteristics, the first two maneuvers were designed to avoid the use of the throttles for precise velocity control, and the rudder pedals were not used for any task. These maneuvering techniques allowed the pilots to focus on the sticks without other influences.

This report presents an analysis of the time histories, pilot ratings, and pilot comments collected in the evaluation. Time histories of the stick position provide insight on the effects of the sticks on pilot technique. Trends noted in the time histories are reflected in the Cooper-Harper Ratings (CHRs) and pilot induced oscillation (PIO) ratings, and the recorded pilot comments provide explanations. The influence of pilot technique on stick preference, specifically the correlation between pilot aggressiveness and stick preference, are discussed. The two motion types and use of the armrest are evaluated based on pilot comments regarding the ergonomics of the sticks. In addition, scatter observed in the CHRs and PIO ratings is discussed.

SYSTEM DESCRIPTION

This section discusses the equipment used in the evaluation. The simulator and evaluation side sticks are described in detail.

Simulator

The side sticks were installed in a NASA Dryden fixed-base flight simulator with a generic two-seat (side-by-side) cockpit. The simulator was programmed to represent an F-18 aircraft using standard F-18 simulation code. Although the simulator cockpit layout was not representative of that in an actual F-18 aircraft, the simulator behaved identically to a dedicated F-18 simulator. This simulator was chosen instead of a dedicated F-18 simulator, because it was more convenient. Because the right seat center stick had been removed, the center stick evaluations were conducted from the left seat, and the side stick evaluations were conducted from the right seat. The center stick was programmed with the same stick characteristics as those in an actual F-18 aircraft. Figure 1 shows one of the side sticks mounted for use from the right seat. Although rudder pedals were present on both sides of the simulator, no rudder inputs were used in any of the evaluations.



Figure 1. Side stick mounted in simulator cockpit.

The simulation, a six-degree-of-freedom, nonlinear simulation (ref. 10), was used for engineering evaluation rather than for training. Although the visual displays were not highly detailed, they were adequate for pilot evaluations. The software was modified to provide an interface with the side stick hardware and establish tasks for the pilots to fly.

A 5- by 7-ft projection screen gave the pilot an out-the-window forward view and head-up display (HUD). The HUD provided heading, altitude, vertical speed, airspeed, Mach number, angle of attack, and load factor displays. Bars indicating flightpath and aircraft orientation were also displayed, as was a representation of the velocity vector. A simple ground texture and sky gave the pilot good visual reference of attitude. Although simulator cockpit displays can be configured with flight instrumentation, the HUD was adequate for this analysis, and no instrument panel was used. A computer terminal next to the simulator was used to initialize and monitor the tasks.

Evaluation Side Sticks

Each evaluation side stick was designed with unique motion characteristics. The first stick, known as X-Theta X, translates forward and aft for pitch control (fig. 2). Roll control is accomplished by rotating the stick side to side about a longitudinal axis of the aircraft at the base of the stick. The second stick, known as X-Theta Z, is less conventional (fig. 3). Pitch motion is identical to that of the X-Theta X stick; however, roll control is accomplished by a rotation about the vertical axis located near the pilot's elbow. As a result, a yaw motion of the pilot's hand produces roll commands. Both sticks require full arm motion, with little or no bending of the wrist.

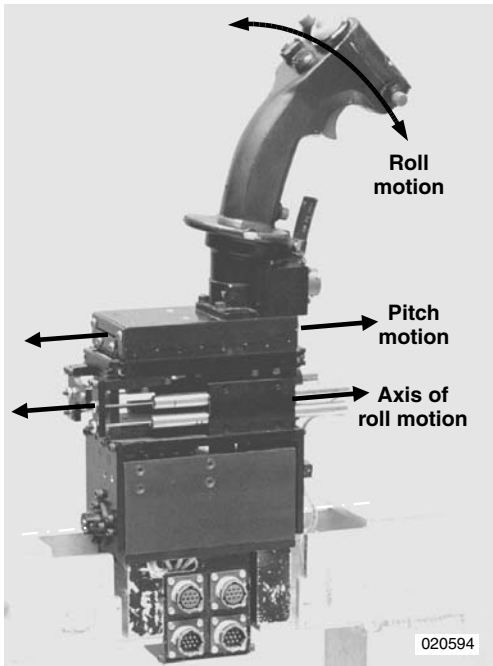

Figure 2. X-Theta X stick.

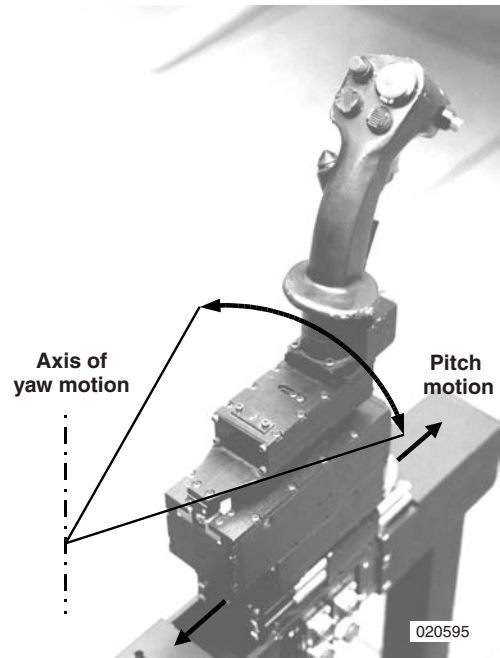
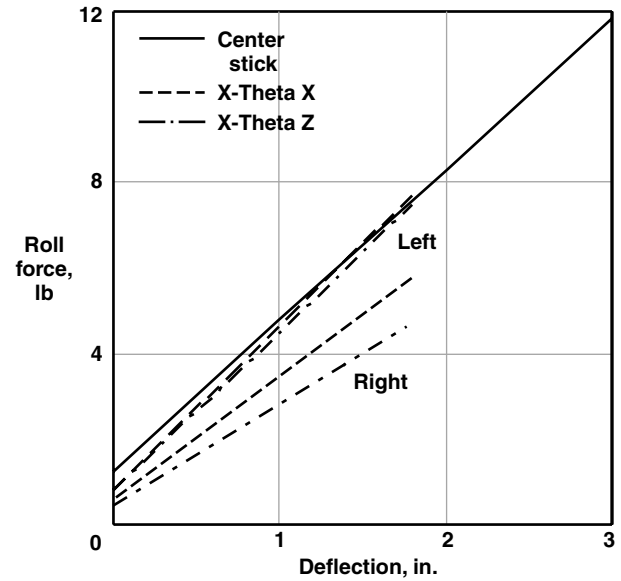
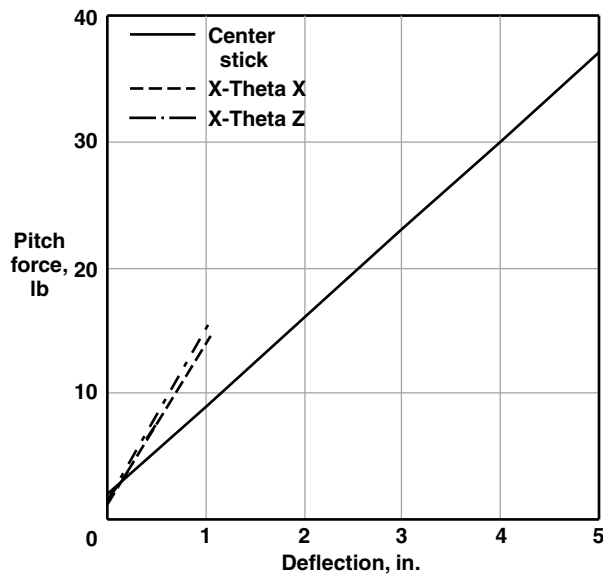

Figure 3. X-Theta Z stick.

Table 1 and figure 4 summarize the force and displacement characteristics of the sticks. Of particular note, these side sticks have stiffer gradients for left roll commands than for right to accommodate the differences in strength among the various arm muscles used for roll control. Because the arm is less able to push away from the body than pull towards it, the gradients were configured to provide a constant feel in roll, offering an ergonomic advantage.

Table 1. Motion characteristics of the side sticks.

		Deflection (in.)	Maximum force (lb)	Breakout force (lb)
X-Theta X stick	Pitch, fore and aft	1.0	14	1.4
	Roll, left	1.9	8	0.8
	Roll, right	1.9	6	0.6
X-Theta Z stick	Pitch, fore and aft	1.1	17	1.7
	Roll, left	1.9	8	0.8
	Roll, right	1.9	5	0.5
Center Stick	Pitch, fore	2.5	20	2.0
	Pitch, aft	5.0	37	2.0
	Roll, left and right	3.0	12	1.3



020596

Figure 4. Stick force and displacement characteristics.

Each side stick uses a common armrest (fig. 5) to eliminate fatigue caused by supporting the forearm over long periods of time. The armrest features a padded elbow cup that slides fore and aft and rotates about a vertical axis. The fore and aft translational motion is spring centered and has air dampers to reduce oscillations. The elbow cup rotates freely, with no centering springs or damping. No capability exists to record position information from the armrest. Figure 6 shows the X-Theta X stick and the elbow cup attached to the mounting bracket.

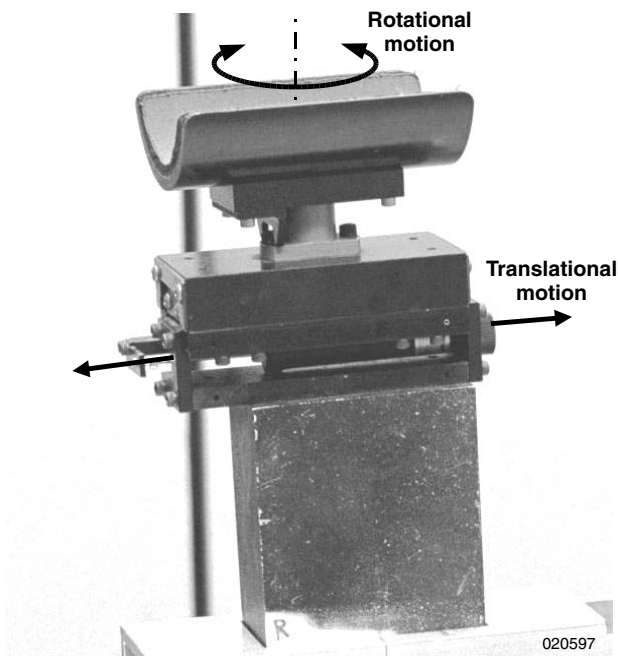

Figure 5. Armrest with elbow cup.

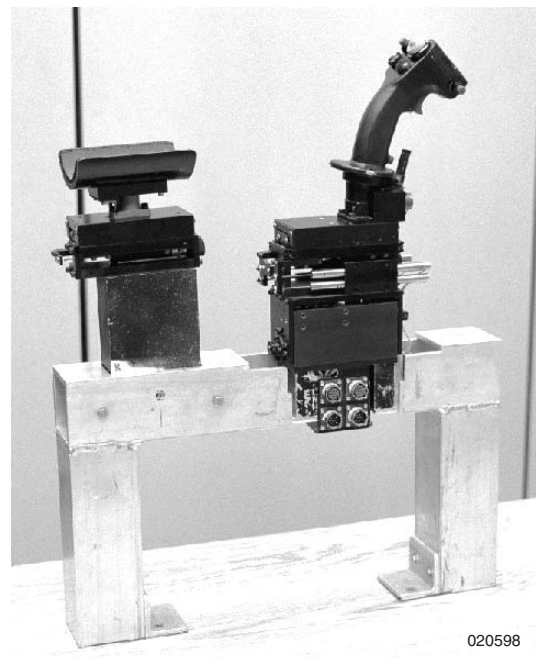

Figure 6. X-Theta X stick, elbow cup, and mounting bracket.

Position sensing in the side sticks is accomplished by linear variable differential transformer (LVDT) motion transducers. Both stick prototypes were designed to be flight quality hardware (ref. 9); therefore, four transducers for each axis were installed. Despite the differences in geometry, the two sticks use identical LVDTs and provide the same electrical output, so only one set of electronics is required for both sticks.

Figure 7 illustrates how the side sticks were connected to the simulator. The side sticks were connected to the Side Stick Electronics Box (SSEB), which provides the LVDTs with excitation voltages and converts the LVDT measurements into a usable output. The SSEB has four redundant analog cards, each reading one pitch and one roll channel from the side stick. The cards are separated electronically and physically to ensure that failures are isolated to individual cards, and voting circuitry removes signals from failed channels. Gain shaping and failure detection can also be handled by the cards, but in this analysis, failure detection was ignored and gain shaping was handled by the simulator software.

The SSEB was connected to the Pilot Panel Box (PPB), which contains a power supply providing 28 Vdc from 115 Vac, 60 Hz power. Failure warning lights indicate malfunctions on any channel. The PPB provides analog output signals through eight coaxial connectors, one for each pitch and roll channel. All four sets of outputs provide the signal that the SSEB determines is correct. The PPB is able to do self tests on the functionality of the error-checking electronics; however, the error detection and redundancy were not used in this evaluation.

The two side sticks are identical in terms of physical and electrical connections. The PPB analog output is passed to the simulation through an analog-to-digital (A/D) converter. Minor modifications to the software were needed for control input to be accepted in this form. Control stick gains were selected to provide the maximum F-18 command when the sticks are at maximum deflection, giving them the same authority as that of the standard center stick. Slight differences in the maximum output voltages of the two sticks necessitated two sets of gains to provide the same maximum command with all three sticks.

The side sticks were mounted along the right wall of the simulator cockpit. Like most side sticks, they were designed for right-hand use. Only minor modifications were required to mount the sticks for use from the right seat. An aluminum bracket was fabricated to hold the sticks and elbow rest in the desired location. Some of the cockpit lining was removed to provide clearance for the sticks. The stick location was tested to determine the most comfortable location, without interfering with the cockpit walls and seat. The elbow rest was secured in the manufacturer's recommended location, 13 in. behind the center of the stick.

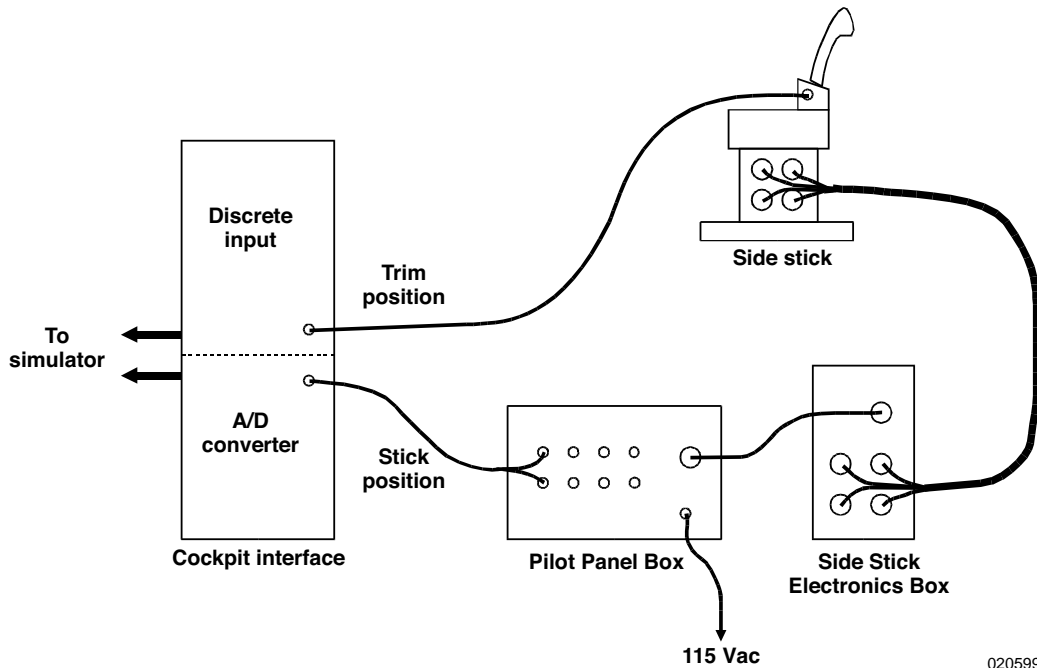

Figure 7. Side stick electrical connections.

EVALUATIONS

This section describes the evaluations of the side sticks. The evaluation tasks, pilot history, and test procedures are discussed in detail.

Task Descriptions

Three tasks were used in the evaluations: target acquisition, target tracking, and offset landing. These tasks were representative of fighter aircraft maneuvers and subjected the pilot and aircraft to a range of demands and conditions. The target acquisition and target tracking tasks were up-and-away tasks in which the pilot maneuvered relative to another aircraft. The offset landing task demanded aggressive maneuvering at low altitude and airspeed.

In the target acquisition task, the simulator provided a visual target at the same altitude, heading, and airspeed as the tracking aircraft, 1000 ft in front and 100 ft to one side. The target maintained straight and level flight while the pilot maneuvered behind, placing the target inside a piper on the HUD. Figure 8 shows the pilot's view at the start of the maneuver. Two concentric piper circles were provided with radii of 10 and 20 mil. When the target was inside the piper circle(s), the circles would turn from green to red to indicate the acquisition. After the target had been held in the piper for ten sec, it would offset to the other side, at which time the pilot had to reacquire it. Table 2 lists the performance definitions for this task. The time criterion was included to ensure an aggressive maneuver.

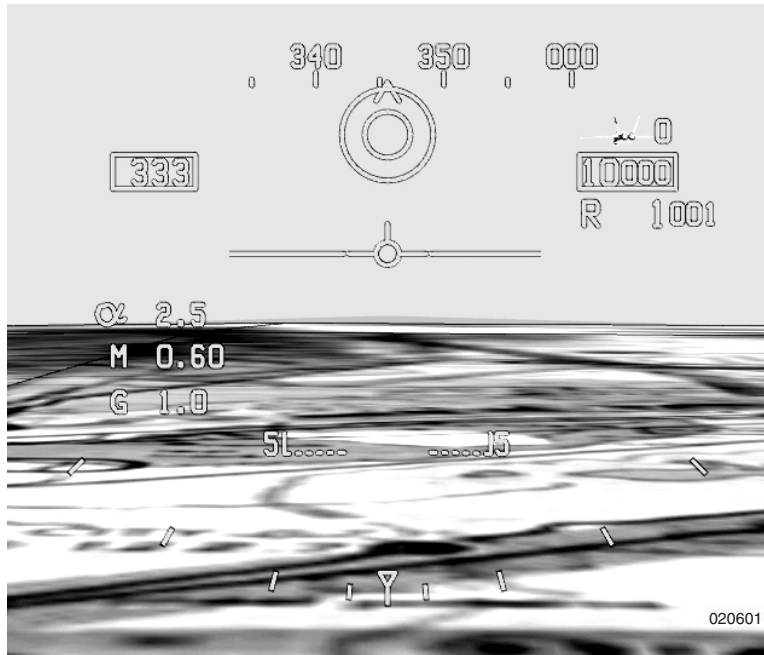

Figure 8. Target acquisition task.

Table 2. Performance definitions for the target acquisition task.

Desired Performance	Adequate Performance
No pilot induced oscillation	No pilot induced oscillation
Acquire target within 8 sec	Acquire target within 10 sec
Keep target within the inner circle with two or less overshoots	Keep target within the outer circle with three or less overshoots

The target tracking task required that the pilot follow a maneuvering target (fig. 9). The target was provided at the same altitude, heading, and airspeed as the tracking aircraft, 1000 ft in front. When the task started, the target immediately rolled into a 3-g turn, which it held for 45 sec. At this point, the target began a reversal and entered a 3-g turn in the opposite direction. Constant altitude was maintained for the duration of the task. As in the first task, the HUD included a pipper that turned from green to red when the target was inside the pipper circle(s). Table 3 shows performance definitions for this task.

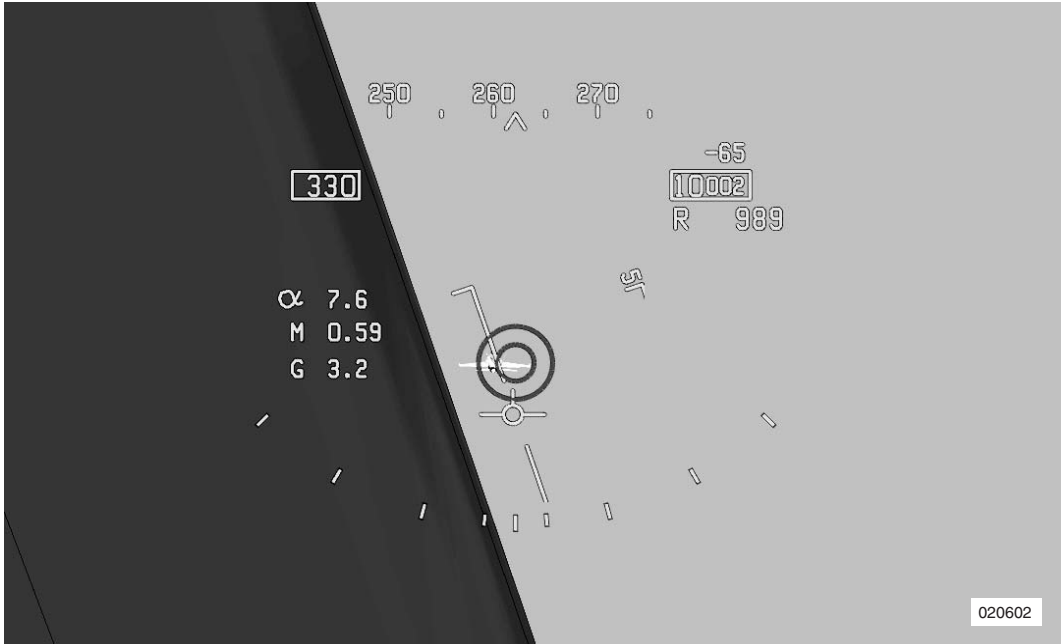

Figure 9. Target tracking task.

Table 3. Performance definitions for the target tracking task.

Desired Performance	Adequate Performance
No pilot induced oscillation	No pilot induced oscillation
Keep target within the inner circle with two or less overshoots	Keep target within the outer circle with two or less overshoots

The final task, offset landing, began on a 3-mile final approach with the aircraft in the landing configuration, offset 500 ft from the runway centerline (fig. 10). The pilot maintained this offset while following the glide slope until the HUD pipper flashed at a preset distance from the aim point. At this distance, which varied between 4500 and 5500 ft, the pilot was to capture the runway centerline and land on the aim point drawn on the runway. The aim point consisted of two boxes centered on the threshold, representing desired and adequate performance. Table 4 defines additional performance criteria. As figure 11 illustrates, this task forced aggressive maneuvering at low altitude and airspeed.

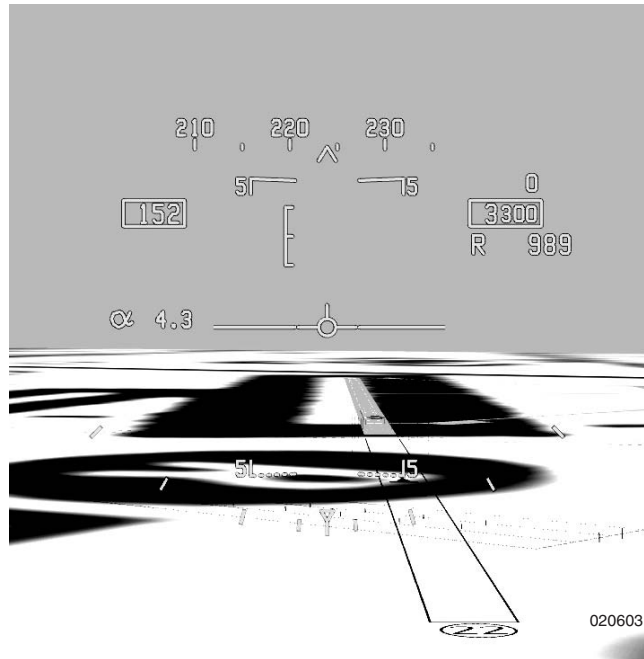

Figure 10. Offset landing task initial conditions.

Table 4. Performance definitions for the offset landing task.

Desired Performance	Adequate Performance
No pilot induced oscillation	No pilot induced oscillation
Touchdown within 25 ft of centerline	Touchdown within 50 ft of centerline
Touchdown within ± 250 ft of aim point	Touchdown between 250 ft before and 750 ft after aim point
Approach airspeed maintained within -5 knots	Approach airspeed maintained within +10 knots, -5 knots
Touchdown airspeed within -3 knots	Touchdown airspeed within -5 knots
Sink rate less than 3 ft/sec	Sink rate less than 9 ft/sec

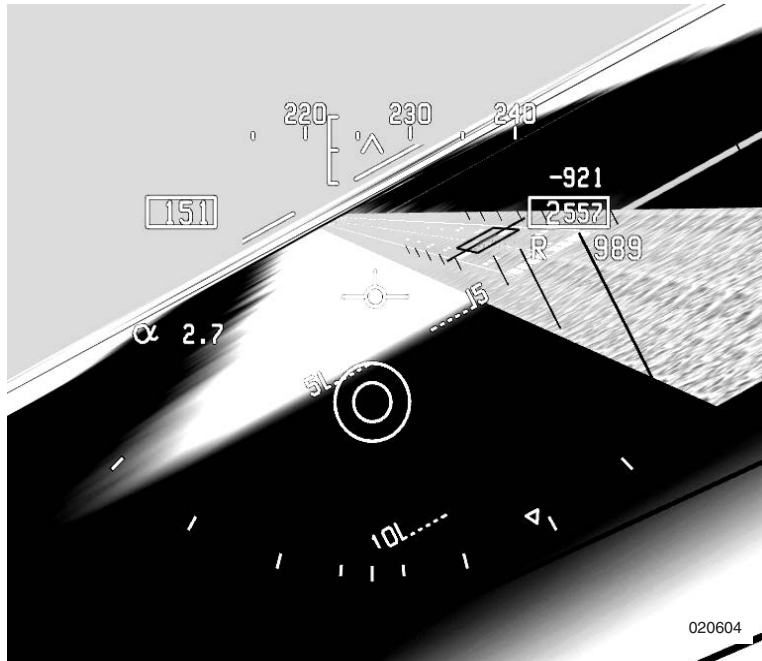

Figure 11. Offset landing task correction to centerline.

Initial work with the simulator revealed difficulties with precise airspeed control. Holding the target range constant was nearly impossible during the target acquisition and tracking tasks. This difficulty was caused by throttle characteristics, in both the simulation and hardware. The solution was to vary the speed of the target aircraft to maintain the desired range. The airspeed of the target was simply set equal to the airspeed of the tracking aircraft at every time step in the acquisition task, because both aircraft follow relatively straight paths. The tracking task required a correction to account for differences in the flightpaths of the two aircraft, and the ground track of the target was continually calculated to maintain 3 g at the current airspeed. The pilot was then able to concentrate on the handling qualities of the control stick rather than the throttle, although maintaining approximately the initial airspeed was still necessary. No modifications were needed for the offset landing task, because maintaining a fixed velocity was easier than maintaining a velocity relative to that of the target.

Pilot History

Seven NASA Dryden research pilots, all with extensive experience in fighter aircraft including the F-18, evaluated the side sticks. Table 5 summarizes their experience levels. Of particular note is that two of the pilots had a significant amount of time using the side stick in the F-16 aircraft. Most of the pilots had previously flown other side sticks in test aircraft for short periods. Pilot 4 was the only pilot with no prior side stick experience.

Table 5. Experience levels of the evaluation pilots.

Pilot No.	Total Time (hours)	Flight Test Time (hours)	F-16 time (hours)
1	6,800	1,500	350
2	3,600	1,100	5
3	8,700	4,000	10
4	7,000	100	-
5	15,500	10,000	3
6	5,000	1,000	5
7	4,900	1,000	2,000

Test Procedures

The pilots were asked to evaluate the two side sticks and the center stick. The center stick evaluation served as the baseline. Each pilot first flew all three tasks using the center stick. The three tasks were then flown using one side stick, and flown again using the other side stick. Although the center stick was always evaluated first, the order of the side stick evaluations was varied to reduce learning curve effects that might occur as a result of the pilot's adaptation to a side stick, particularly with the pitch motion. After evaluating the first side stick, the pilot might become adjusted to that motion and have less difficulty with the second side stick. Alternating the order cancelled this learning effect. The pilots were allowed to practice each task immediately before the evaluation run, helping them become familiar with the tasks and different sticks.

After familiarization with the simulator and tasks, the pilots flew the tasks for the evaluation. The pilots were encouraged to provide any comments that came to mind during the evaluation, and these comments were recorded. A debriefing, conducted after each task, collected detailed subjective evaluations about the feel of the sticks and the ability of the pilots to make the desired inputs. Figure 12 shows the comment card used to gather pilot comments on aspects of the evaluation. The CHRs (ref. 11) (fig. 13) and PIO ratings (ref. 12) (fig. 14) were also taken, and each pilot was asked to identify the stick that was most desirable overall. The simulator recorded a full range of data including aircraft and target states and control inputs.

Task 1: Target acquisition	Task 2: Target tracking	Task 3: Landing from an offset approach
<i>Please comment on the following areas:</i>	<i>Please comment on the following areas:</i>	<i>Please comment on the following areas:</i>
1. Simulator/display issues 2. Stick forces (roll/pitch) 3. Stick motion (roll/pitch) 4. Control harmony 5. Control precision (roll/pitch) 6. Initial and final response to an input (roll/pitch) 7. Ability to make large and small inputs (roll/pitch) 8. General controllability 9. CHR (pitch/roll) 10. PIO rating (pitch/roll) 11. Fatigue 12. Good/bad features	1. Simulator/display issues 2. Stick forces (roll/pitch) 3. Stick motion (roll/pitch) 4. Control harmony 5. Control precision (roll/pitch) 6. Initial and final response to an input (roll/pitch) 7. Ability to make large and small inputs (roll/pitch) 8. General controllability 9. CHR (pitch/roll) 10. PIO rating (pitch/roll) 11. Fatigue 12. Good/bad features	1. Simulator/display issues 2. Stick forces (roll/pitch) 3. Stick motion (roll/pitch) 4. Control harmony 5. Control precision (roll/pitch) 6. Initial and final response to an input (roll/pitch) 7. Ability to make large and small inputs (roll/pitch) 8. Ability to control velocity and sink rate 9. Ability to hit aim point 10. General controllability 11. CHR (pitch/roll) 12. PIO rating (pitch/roll) 13. Fatigue

020605

Figure 12. Pilot comment card.

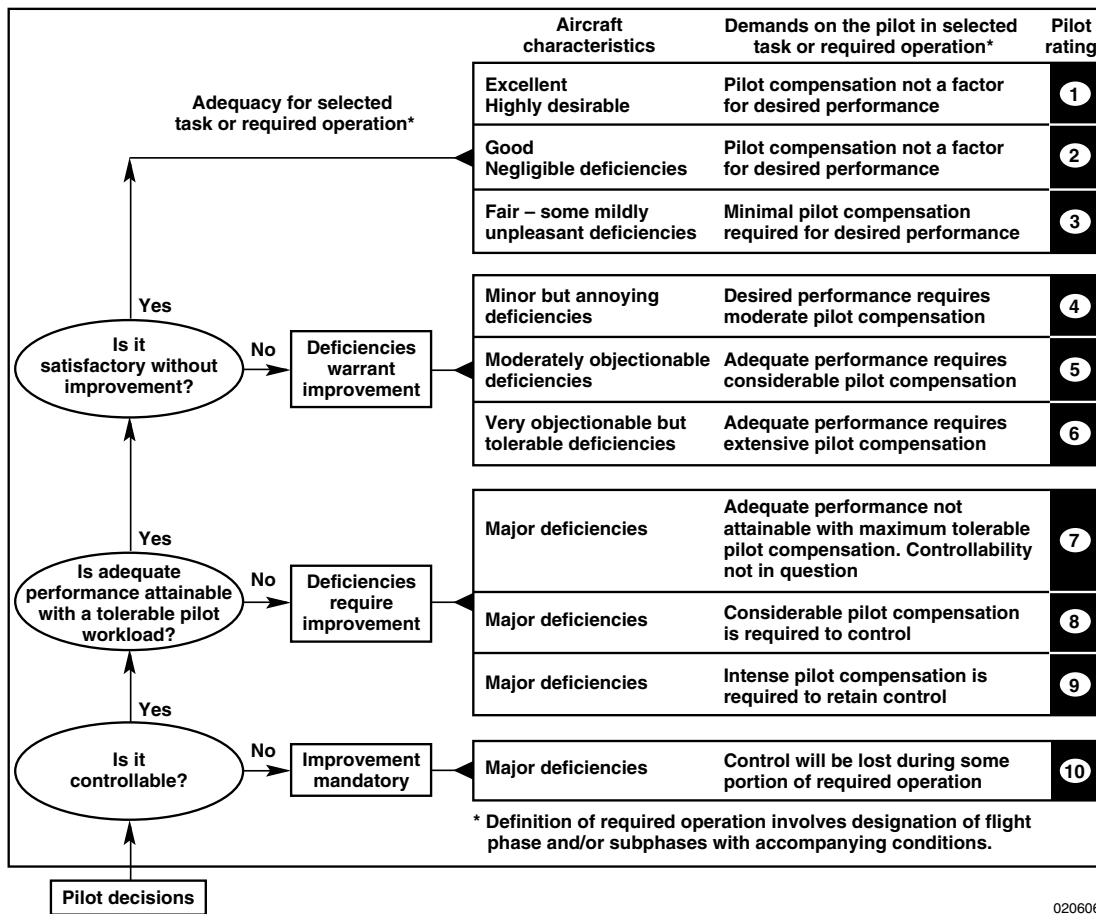

020606

Figure 13. Cooper-Harper Rating scale (ref. 11).

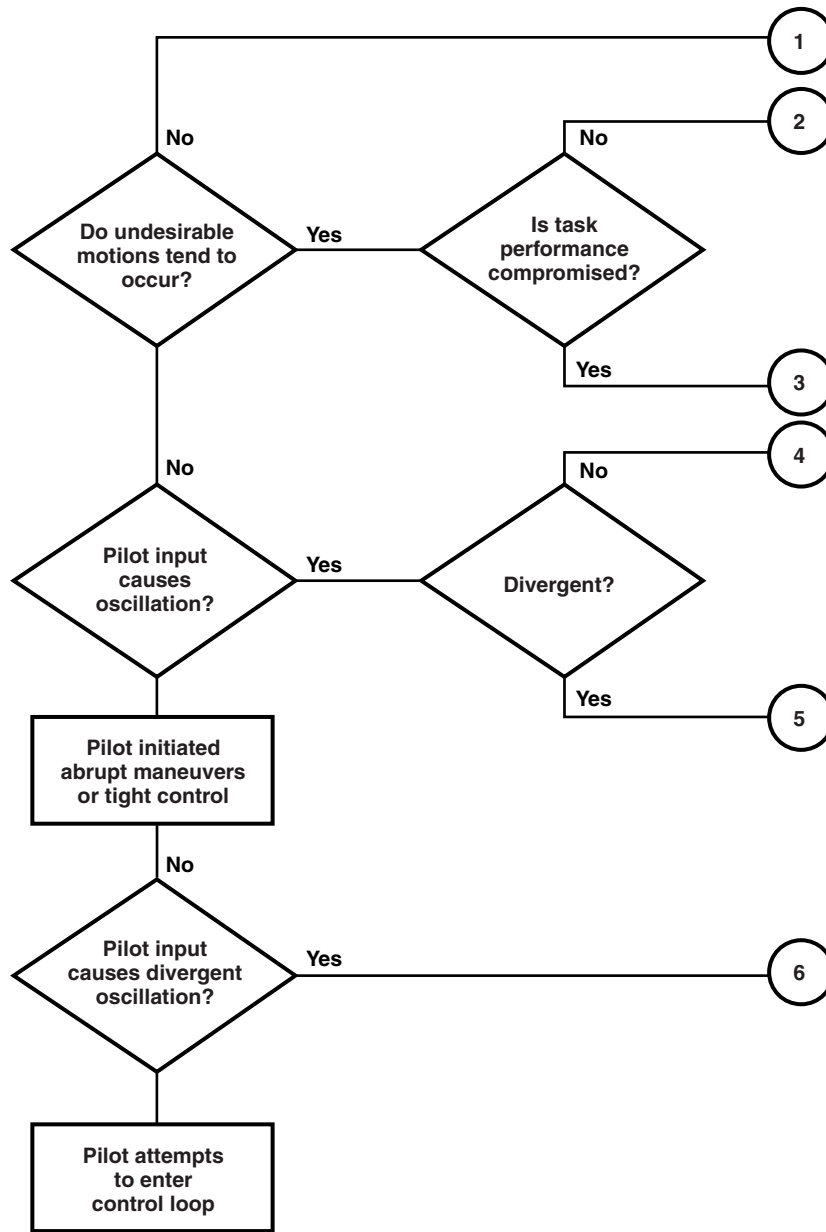

020607

Figure 14. Pilot induced oscillation scale (ref. 12).

RESULTS AND DISCUSSION

The analysis of the evaluation results focused on explaining pilot preferences. Analysis was performed on the different piloting techniques in an attempt to determine the reasons for their preferences. Comments on the ergonomics of the unique stick designs were of particular interest. Pilots were asked to separate their ratings into pitch and roll components to help evaluate the different types of motions of the two side sticks. Averages were calculated for each stick and task combination to provide a comparison of individual pilots. Both forms of ratings (CHR and PIO) are intended to quantify subjective opinions and are not linear scales; therefore, mathematical operations generally are not valid. Averaging for comparison purposes, however, is acceptable provided the averages are not directly used to draw conclusions.

Figures 15, 16, and 17 present the CHRs by task. Figures 18, 19, and 20 show the PIO ratings. Significant scatter occurred with all stick ratings in all of the tasks. Although some scatter is inevitable with any subjective rating, the significant scatter of these ratings warranted further examination. Explanations for the rating scatter are discussed at the end of this section. Tables 6, 7, and 8 compare each pilot's actual performance with the level of performance indicated by the CHRs. The differences between these performance ratings are also discussed at the end of this section. Table 9 presents a summary of pilot comments.

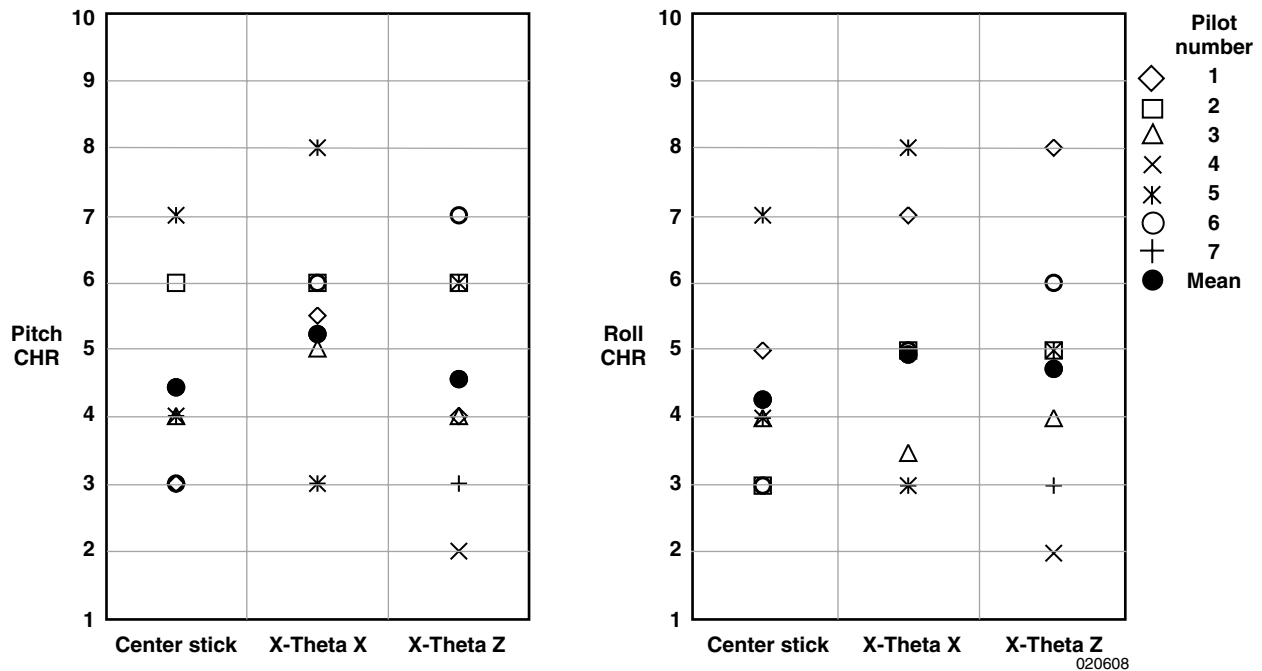

Figure 15. Target acquisition task Cooper-Harper Ratings.

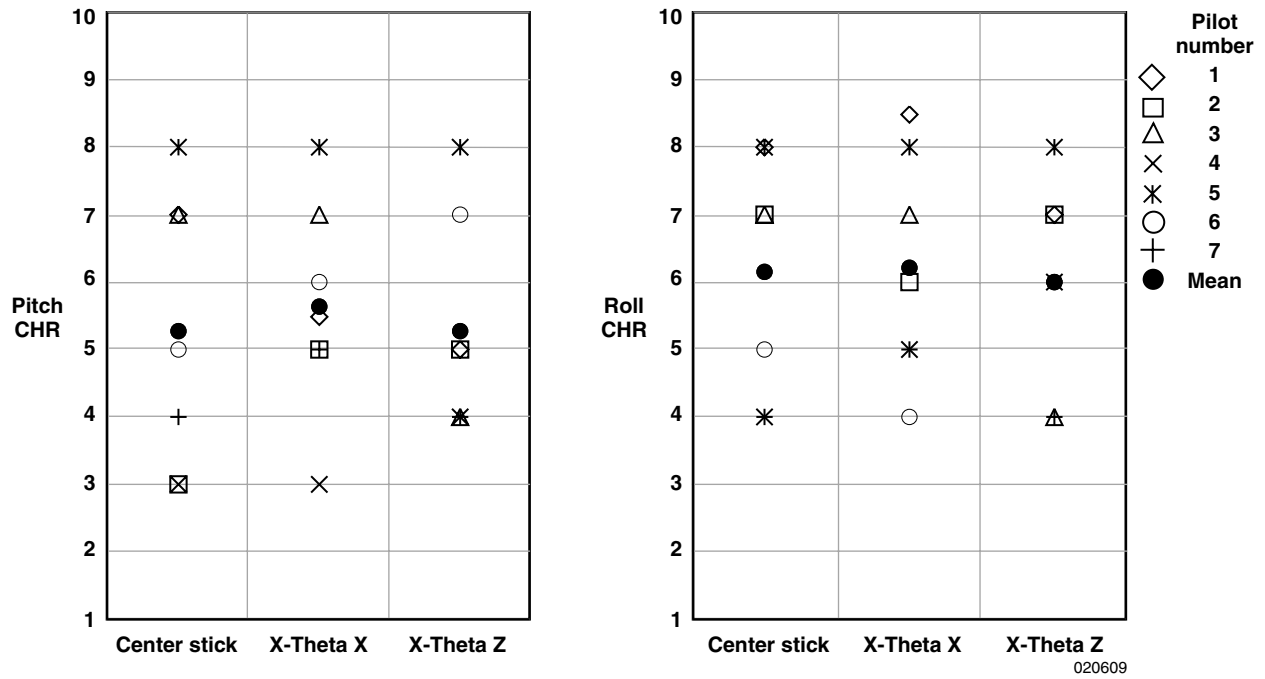

Figure 16. Target tracking task Cooper-Harper Ratings.

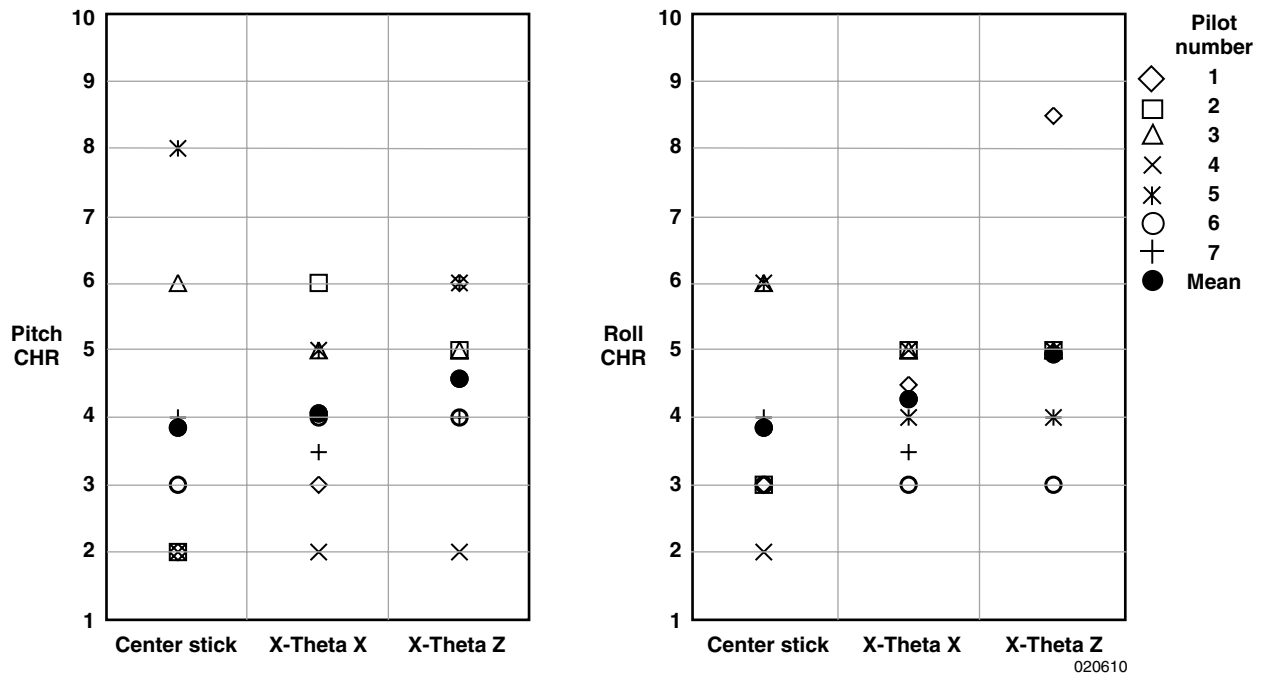

Figure 17. Offset landing task Cooper-Harper Ratings.

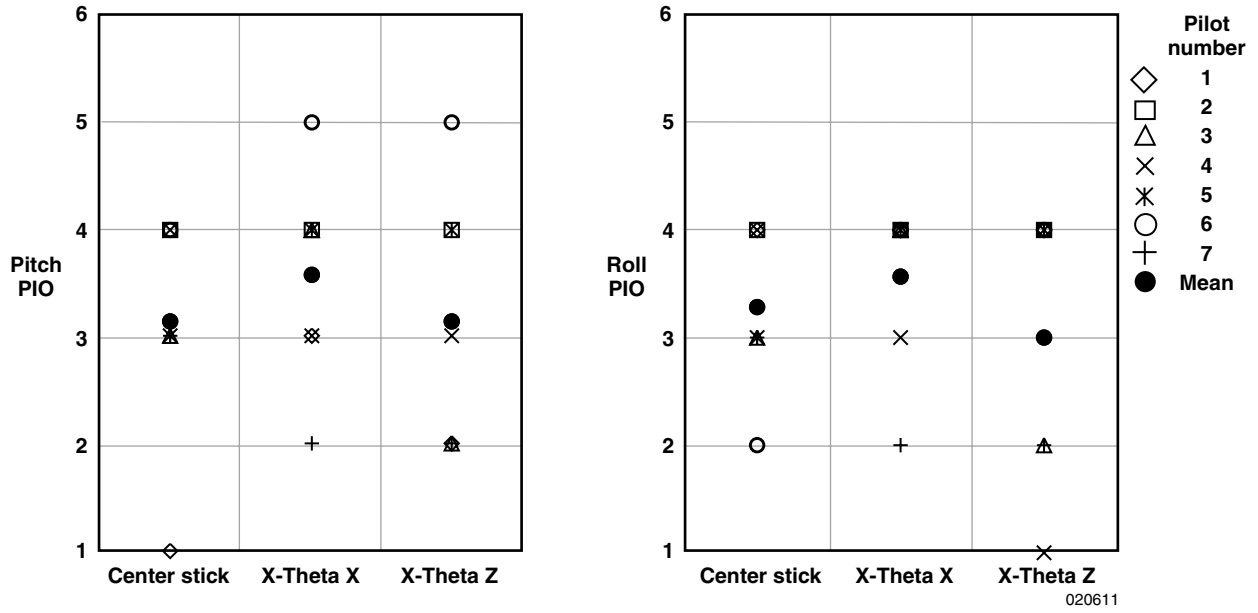

Figure 18. Target acquisition task pilot induced oscillation ratings.

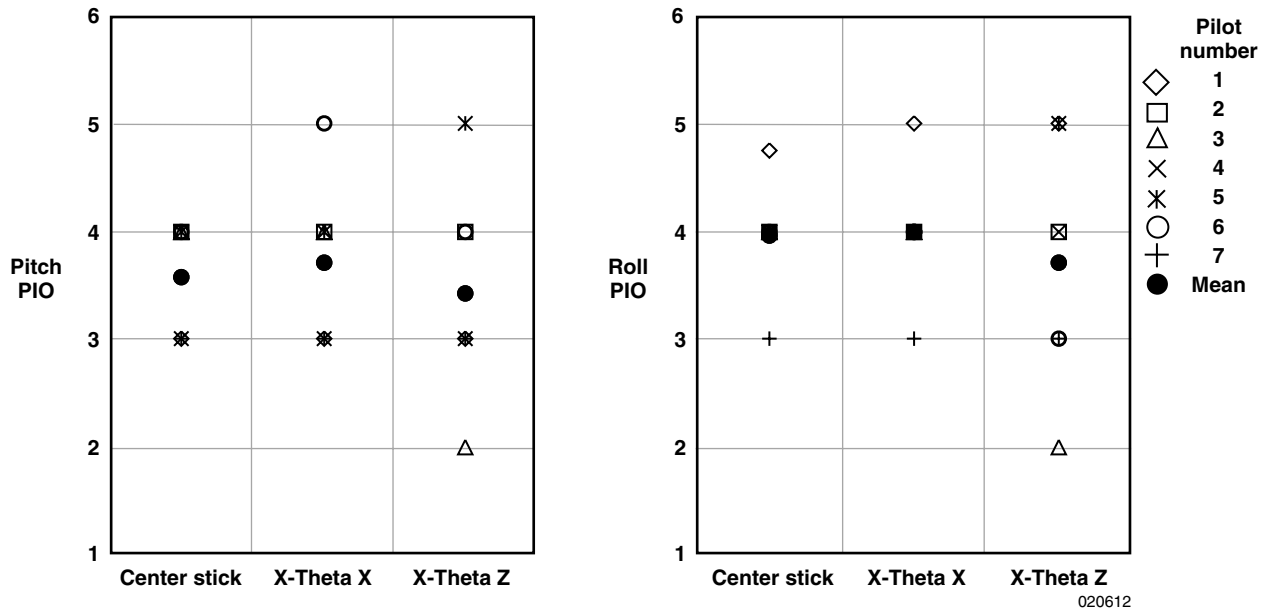

Figure 19. Target tracking task pilot induced oscillation ratings.

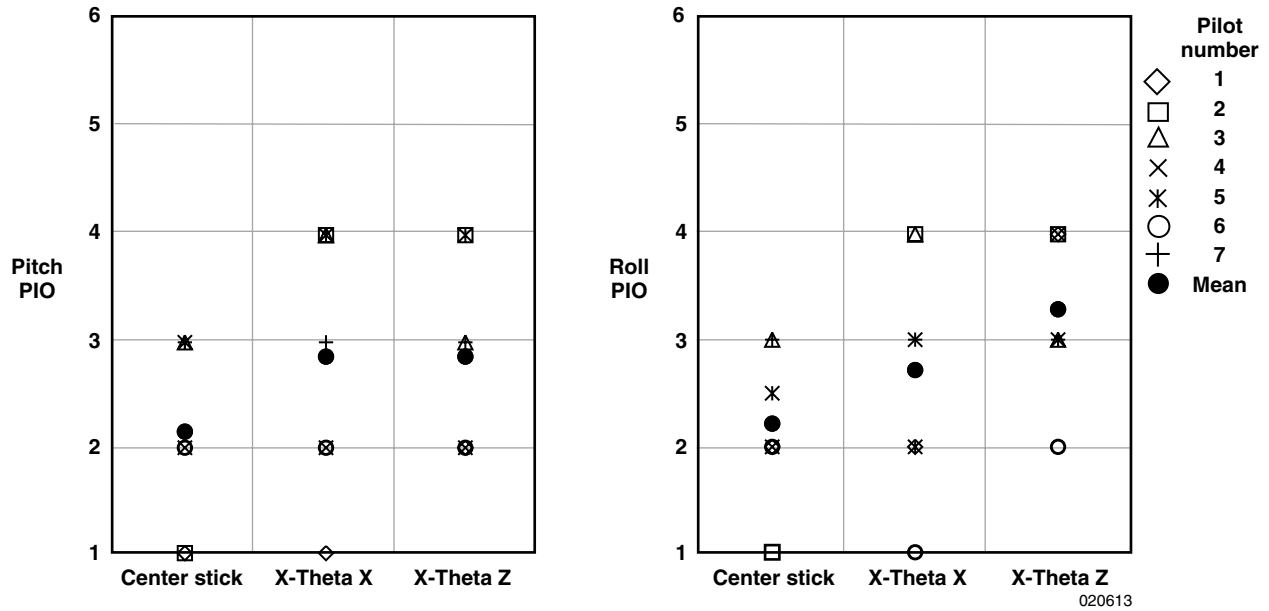

Figure 20. Offset landing task pilot induced oscillation ratings.

Table 6. Target acquisition task performance.

(D=Desired, A=Adequate, I=Inadequate. Numbers indicate how many attempts resulted in each performance level.)

Center Stick	Pilot 1	Pilot 2	Pilot 3	Pilot 4	Pilot 5	Pilot 6	Pilot 7
Actual Performance	-	-	7 D	3 D	3 D	-	-
	-	-	1 A	2 A	1 A	2 A	-
	2 I	4 I	2 I	-	2 I	2 I	2 I
CHR Performance	A	A	D	D	I	D	D
X-Theta X Stick	Pilot 1	Pilot 2	Pilot 3	Pilot 4	Pilot 5	Pilot 6	Pilot 7
Actual Performance	-	-	1 D	2 D	No data	-	1 D
	-	-	2 A	1 A		-	-
	2 I	2 I	6 I	2 I		2 I	1 I
CHR Performance	I	A	A	D	I	A	D
X-Theta Z Stick	Pilot 1	Pilot 2	Pilot 3	Pilot 4	Pilot 5	Pilot 6	Pilot 7
Actual Performance	-	-	2 D	1 D	2 D	-	-
	-	2 A	-	1 A	-	-	1 A
	2 I	2 I	3 I	3 I	2 I	1 I	2 I
CHR Performance	I	A	D	D	A	I	D

Table 7. Target tracking task performance.

(D=Desired, A=Adequate, I=Inadequate. Numbers indicate how many attempts resulted in each performance level.)

Center Stick	Pilot 1	Pilot 2	Pilot 3	Pilot 4	Pilot 5	Pilot 6	Pilot 7
Actual Performance	–	–	–	–	–	–	–
	–	–	–	–	–	–	–
	4 I	4 I	4 I	4 I	3 I	2 I	4 I
CHR Performance	I	I	I	D	I	A	D
X-Theta X Stick	Pilot 1	Pilot 2	Pilot 3	Pilot 4	Pilot 5	Pilot 6	Pilot 7
Actual Performance	–	–	–	–	–	–	–
	–	–	–	–	–	–	–
	3 I	3 I	4 I	4 I	5 I	4 I	2 I
CHR Performance	I	A	I	A	I	A	A
X-Theta Z Stick	Pilot 1	Pilot 2	Pilot 3	Pilot 4	Pilot 5	Pilot 6	Pilot 7
Actual Performance	–	No	1 D	–	–	–	–
	–	data	2 A	–	–	–	–
	3 I		2 I	4 I	3 I	4 I	4 I
CHR Performance	I	I	D	A	I	I	D

Table 8. Offset landing task performance.

(D=Desired, A=Adequate, I=Inadequate. Numbers indicate how many attempts resulted in each performance level.)

Center Stick	Pilot 1	Pilot 2	Pilot 3	Pilot 4	Pilot 5	Pilot 6	Pilot 7
Actual Performance	–	–	–	–	–	–	–
	–	–	–	–	–	–	–
	3 I	3 I	3 I	3 I	4 I	3 I	3 I
CHR Performance	D	D	A	D	I	D	D
X-Theta X Stick	Pilot 1	Pilot 2	Pilot 3	Pilot 4	Pilot 5	Pilot 6	Pilot 7
Actual Performance	–	–	–	–	–	–	–
	–	–	–	–	–	1 A	–
	3 I	3 I	4 I	3 I	3 I	2 I	3 I
CHR Performance	D	A	A	A	A	A	A
X-Theta Z Stick	Pilot 1	Pilot 2	Pilot 3	Pilot 4	Pilot 5	Pilot 6	Pilot 7
Actual Performance	–	–	–	–	–	–	–
	–	–	–	–	–	–	–
	3 I	3 I	3 I	3 I	3 I	2 I	3 I
CHR Performance	I	A	A	D	A	D	D

Table 9. Summary of pilot comments.

Good	<input type="checkbox"/>
Bad	<input checked="" type="checkbox"/>
No comment	<input type="checkbox"/>

Target Acquisition Task

Pilot	Center Stick							X-Theta X Stick							X-Theta Z Stick						
	1	2	3	4	5	6	7	1	2	3	4	5	6	7	1	2	3	4	5	6	7
Forces	■	■	■	□	■	■		■	□	■	□	□	□	□	□	□	□	■	■	□	
Motion	□	■	■					■		■	■		■	■	■		■	□	□	■	■
Harmony	□			□	□	□	□				□	□	■			□		□		□	
Precision	□	■	■	□		■		■		■	□	□		■		■	□		■		
Response			□	■		■	□	■		■	■	■		■			□	□	■		■
Small Inputs	■	□	■				□		□	■	■		□		□	□	□		□		
Large Inputs	□		□				□			□			■	■	■	□			■		
Controllability			□	□	□	■	□	■	□	□		■		■		□	□	■	■	□	
Fatigue	■		□		■	□	□		□	□	□	□	□			□	□	□	□	□	

Target Tracking Task

Pilot	Center Stick							X-Theta X Stick							X-Theta Z Stick						
	1	2	3	4	5	6	7	1	2	3	4	5	6	7	1	2	3	4	5	6	7
Forces	■		■	■		■	□	■		■	■	□		■	■	□	□	□	□	□	■
Motion	□		□	□						□	□		■			□	□	■		■	
Harmony	□		■				■	■		■			■	□	□	□		■			
Precision	■			■		■	■	■			■	■	■	■		■	■	■	■	■	
Response		■	■		■	■	■	■	□	■	■	■				□		■		□	
Small Inputs			■			□	□			■	■	■				■	■	■	■	□	
Large Inputs			□			■	□	■			□	■	■	■				■	■	■	
Controllability	■	■	■	□	■	■	□	■	□				□	□	□	■	■		□		
Fatigue	■		■	□	■	■	□	■		□	■	■	□	□	□	□	□		□		

Offset Landing Task

Pilot	Center Stick							X-Theta X Stick							X-Theta Z Stick						
	1	2	3	4	5	6	7	1	2	3	4	5	6	7	1	2	3	4	5	6	7
Forces	□		■	□	■			□	□	■	□			■	■		■	□	■	■	
Motion	□			□			□	□	□	■	□		□	■	■					□	■
Harmony	□			□				■		■		□	■			□					
Precision	□		■	□							■	□	□	□	■	■	■				
Response		■	■	□		■	■			■						■	□	□		■	
Small Inputs			■	□		□		■		■	■	□					□			□	
Large Inputs			□			■	■	■	■					■	■						
Controllability	□			□		□	□	□		■	□	□		■	■		□	■			
Fatigue	□		□	□		□	□	□		□	□	□	■			□	□	□	□	□	

The pilots did not unanimously favor one stick over the others. Four of the pilots (Nos. 1, 2, 5, and 6) preferred the center stick. These pilots commented that the side sticks were too sensitive but thought that the X-Theta X stick was slightly better than the X-Theta Z stick. Two of the pilots (Nos. 3 and 4) preferred the X-Theta Z stick, and the center stick was their second choice. The remaining pilot (No. 7) felt that the side sticks would be advantageous in some situations and disadvantageous in others. Much of the analysis focused on these differences of opinion.

Pilot Technique

During the evaluations, some pilots (“high gain” pilots) flew in a very aggressive manner and made frequent large and sudden inputs. Other pilots (“low gain” pilots) used small and smooth inputs, flying the airplane in a much gentler manner. Figure 21 shows the time histories of two pilots, one high gain and one low gain. Both time histories show the roll command for the target acquisition task using the X-Theta Z stick. The difference in pilot technique is apparent. Pilot 1 repeatedly alternated between large left and right commands, and pilot 4 used small commands with smooth transitions. After each large command, pilot 1 had several oscillations. Pilot 4 experienced significantly fewer problems of this nature. The potential link between pilot aggressiveness and stick preference was closely examined.

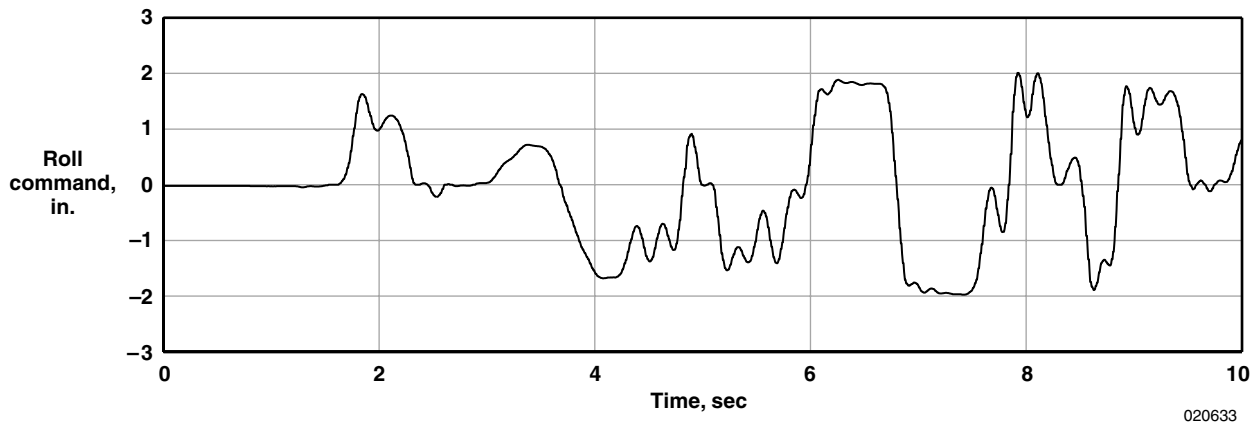

(a) High gain pilot (No. 1).

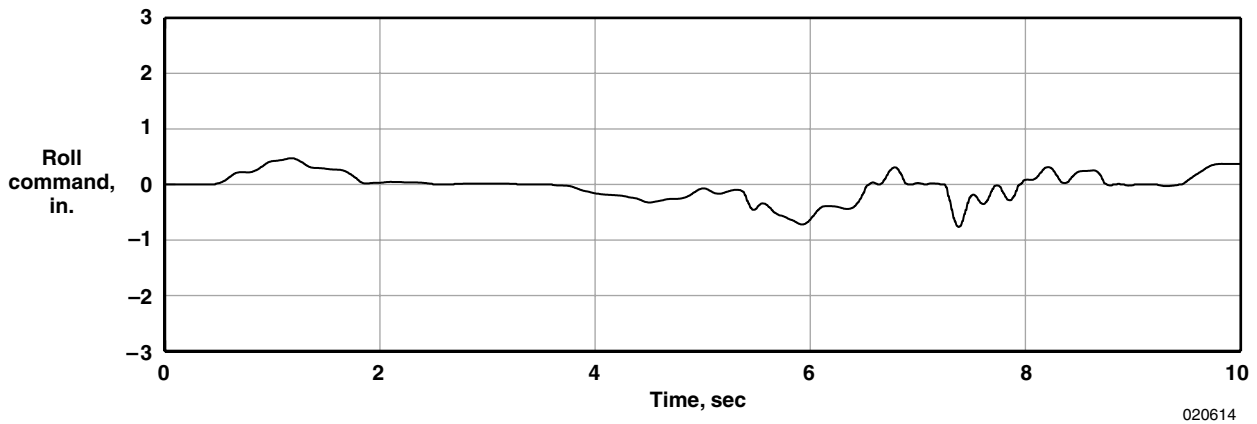

(b) Low gain pilot (No. 4).

Figure 21. Comparison of pilot techniques with X-Theta Z stick, target acquisition task.

No set method exists for quantifying aggressiveness, but a reasonable estimate was obtained by measuring both workload and command rate for each stick and task. Workload was estimated by calculating the standard deviation of the time history of stick position, resulting in a measure of the amplitude of the average command input. Command rate was calculated by dividing the total distance the stick moved by the duration of the maneuver. Both of these parameters were separated into pitch and roll components to isolate the effects of the motion type on each.

These calculations were based on the command that was sent to the flight control algorithms rather than on the actual stick position. This procedure normalized the three sticks to a common motion range and allowed direct comparisons. The actual deflections of the side sticks were significantly smaller than those of the center stick, although the pilot might have sent larger commands into the flight control system with the side stick. Making precise corrections with the side sticks, therefore, might be more difficult. For the center stick, the command was equal to the deflection, so both the workload and command rate were measures of both deflection and command.

The analysis of workloads and command rates confirmed that the pilots who preferred the center stick tended to be high gain pilots with high command rates and workloads. Those pilots who preferred the X-Theta Z stick were low gain pilots who made smaller inputs. Figure 22 shows the workload, and figure 23 shows the command rate, for the target acquisition task, separated into pitch and roll axes. The three pilots who either preferred the side sticks or were divided (low gain pilots) are highlighted with connecting lines. Their workloads and command rates were generally below average for all three sticks. Trends for the target tracking and offset landing tasks were similar. Most pilots made larger commands with the side sticks than with the center stick; however, the difference in command size between the side and center sticks was smaller for the low gain pilots who made smaller commands overall.

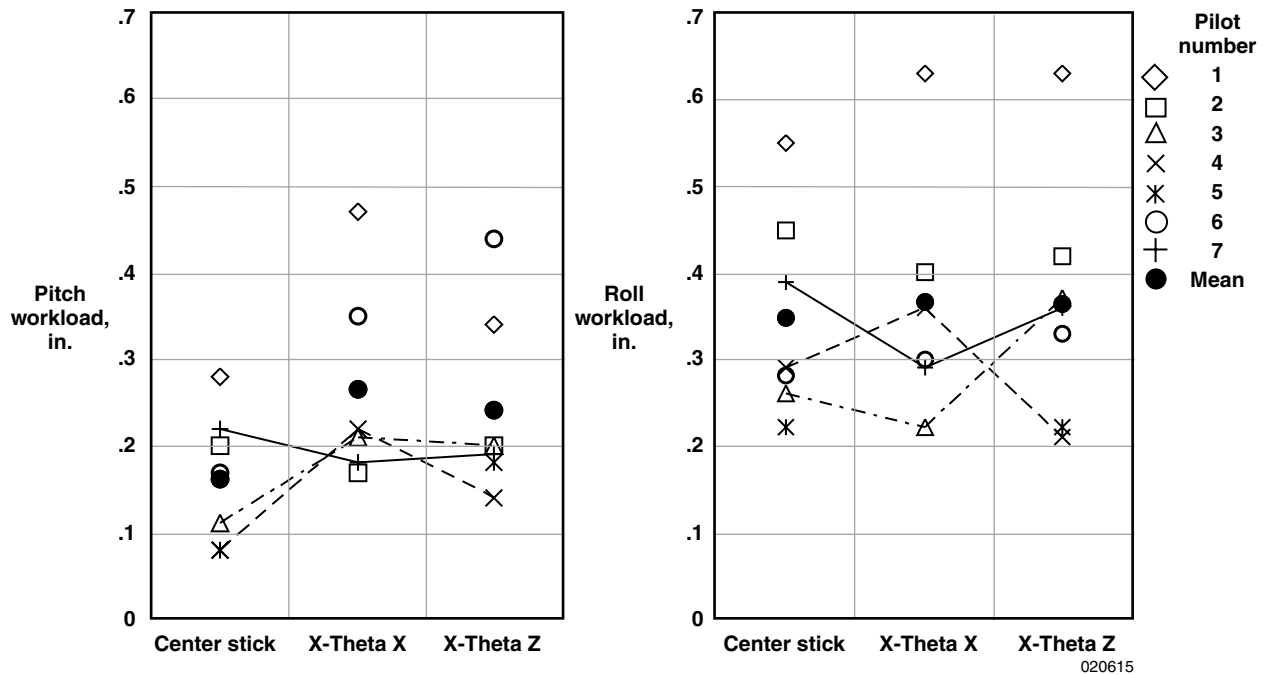

Figure 22. Target acquisition task workload, low gain pilots highlighted.

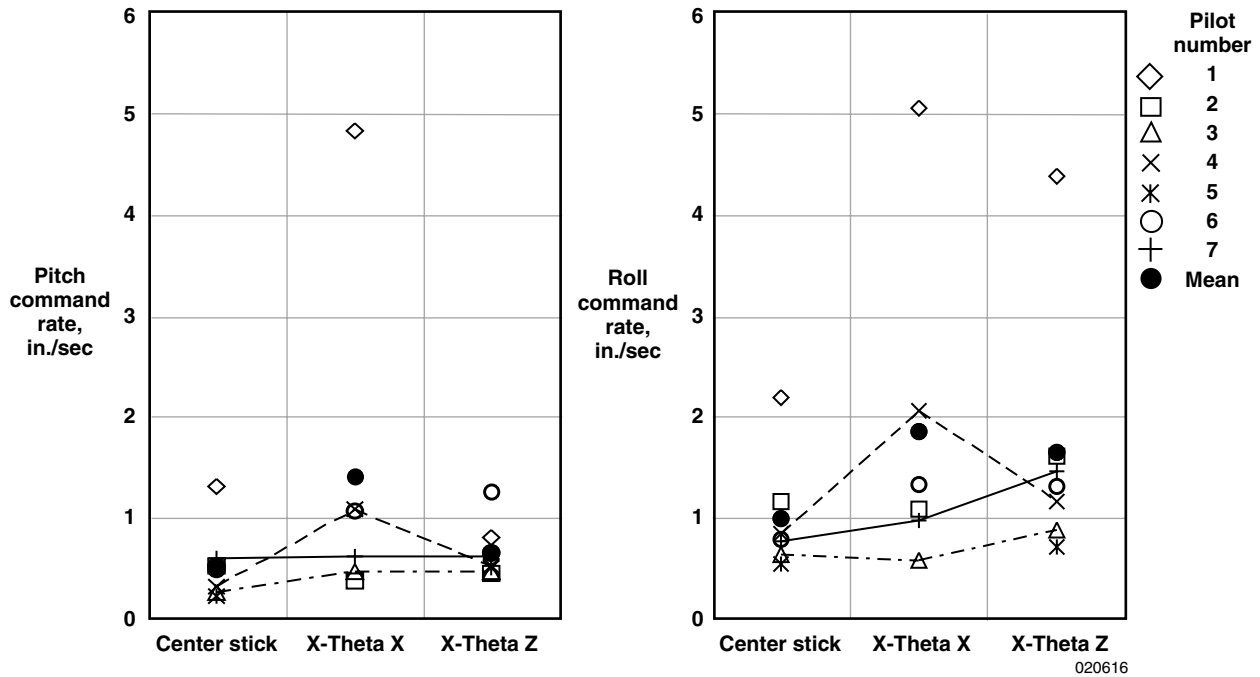

Figure 23. Target acquisition task command rate, low gain pilots highlighted.

Similar trends are visible in the pilot ratings. Figures 24, 25, and 26 present the CHRs, and figures 27, 28, and 29 present the PIO ratings, for the three evaluation tasks, with the low gain pilots highlighted. The low gain pilots generally gave lower-than-average ratings, which indicates they had fewer problems with the aircraft itself than the other pilots had. These pilots' X-Theta Z stick ratings are lower than their center stick ratings, reflecting their stated preference for the X-Theta Z stick. The high gain pilots' center stick ratings are better than their side stick ratings. Their high PIO ratings indicate serious problems using the side sticks. The landing task was much less demanding and did not follow the trends of the other tasks.

Mechanical issues with the sticks significantly influenced pilot preferences. As shown in table 10, both side sticks are seriously underdamped in both axes. When pilots attempted to quickly make large inputs, the insufficient damping caused numerous overshoots. Oscillation at the stick natural frequency is visible in time histories of stick position, such as the time history of pilot 1 (fig. 30), and reflected in comments made by pilot 5 (X-Theta X stick, tracking task): *Forces are balanced, but precision is awful. I try to make a little movement in roll, and I'm always overshooting. It's so undamped it's not smooth, and that's part of the problem.*

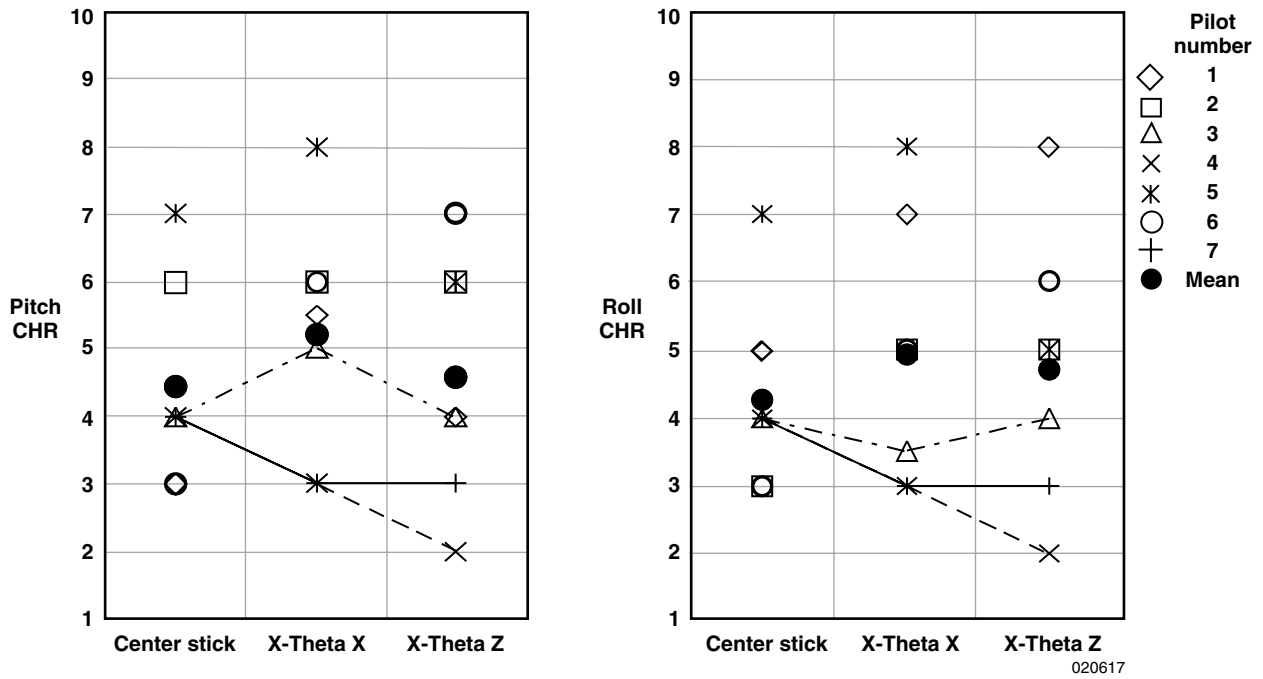

Figure 24. Target acquisition task Cooper-Harper Ratings, low gain pilots highlighted.

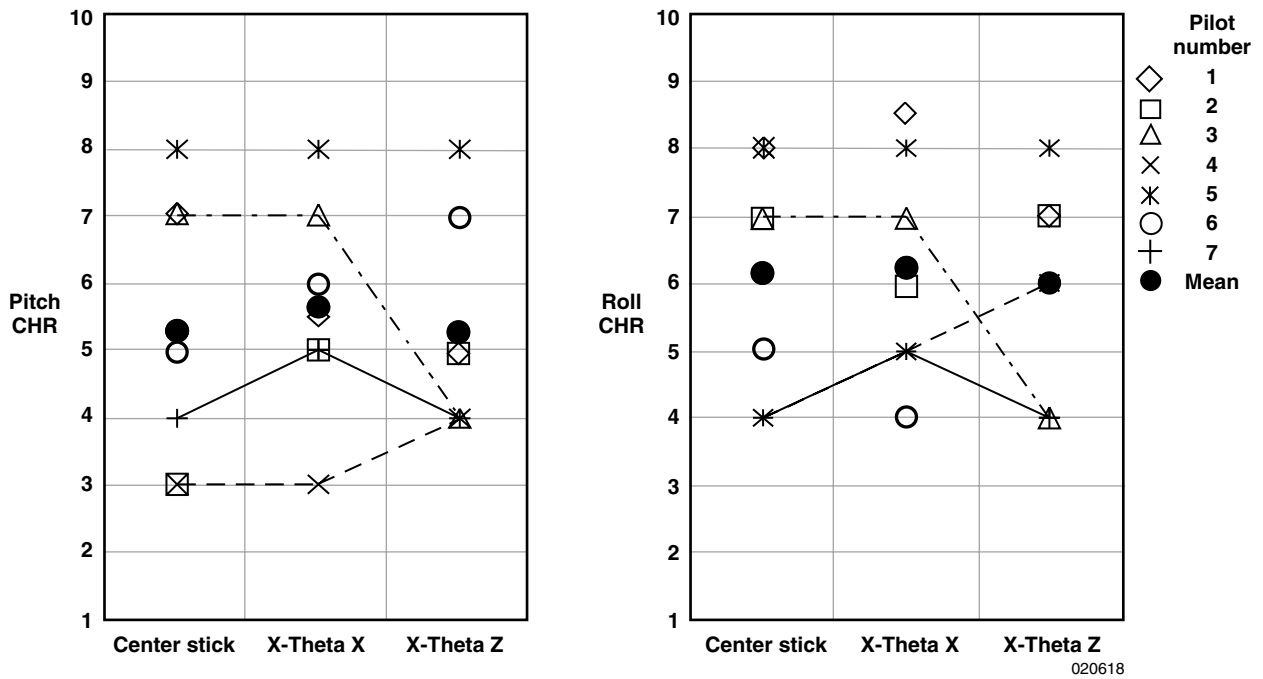

Figure 25. Target tracking task Cooper-Harper Ratings, low gain pilots highlighted.

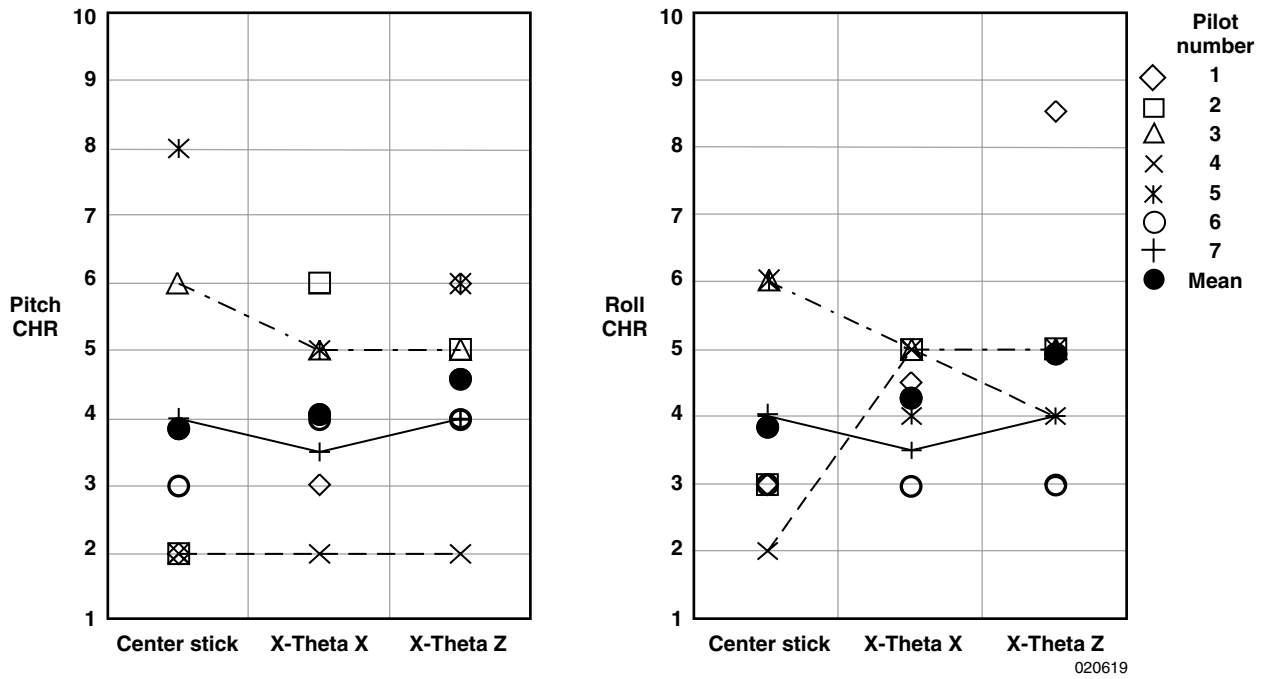

Figure 26. Offset landing task Cooper-Harper Ratings, low gain pilots highlighted.

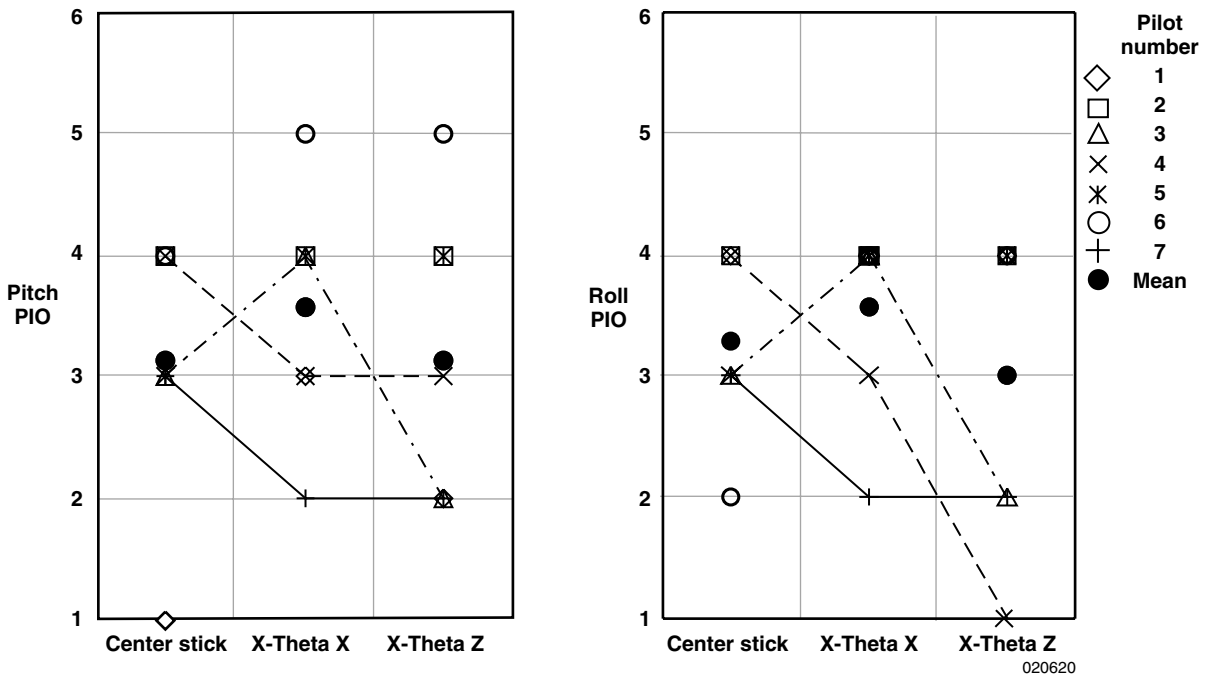

Figure 27. Target acquisition task pilot induced oscillation ratings, low gain pilots highlighted.

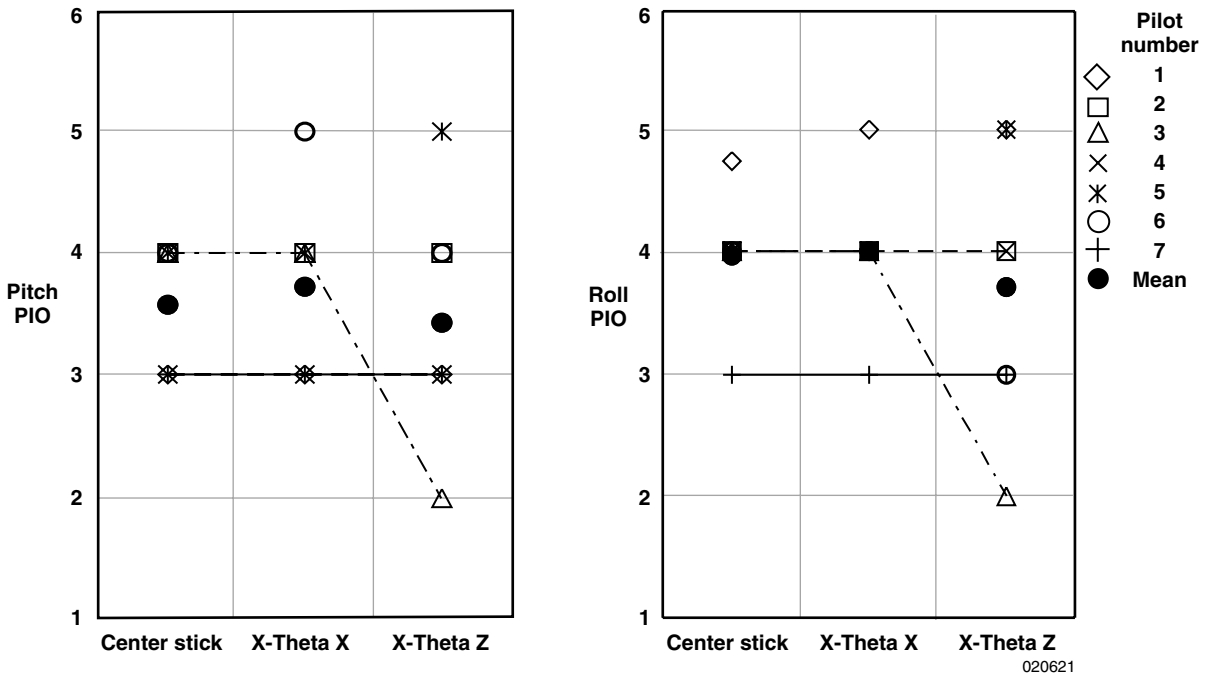

Figure 28. Target tracking task pilot induced oscillation ratings, low gain pilots highlighted.

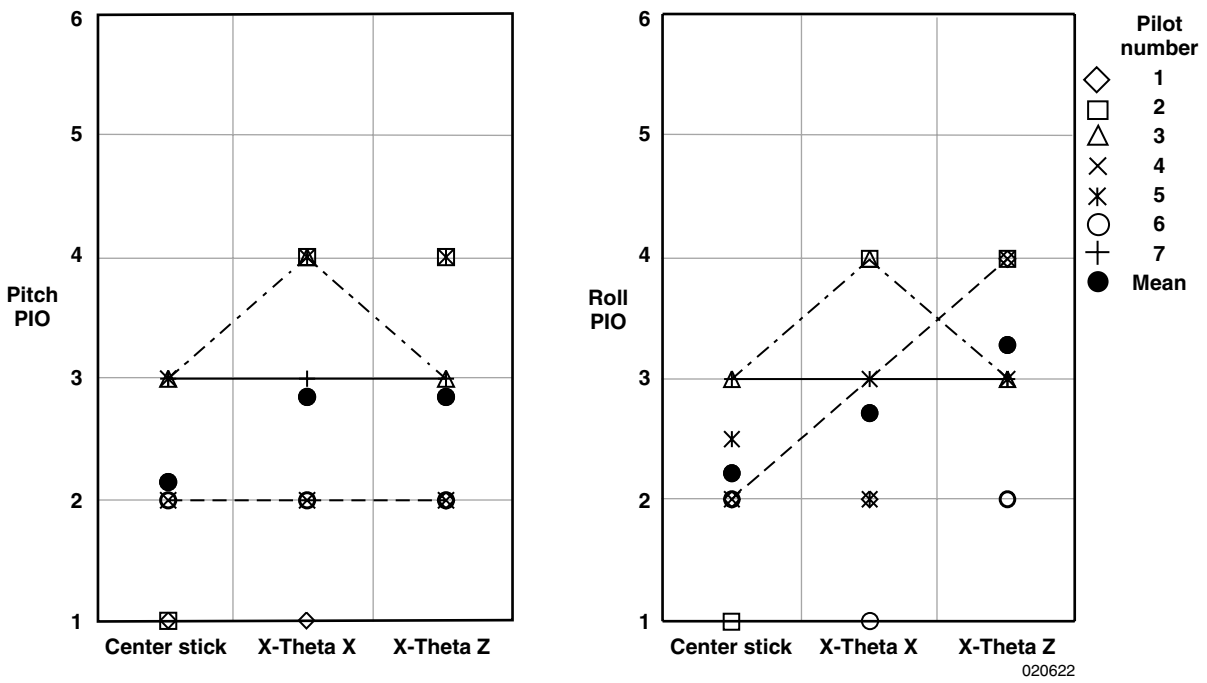

Figure 29. Offset landing task pilot induced oscillation ratings, low gain pilots highlighted.

Table 10. Side stick damping and natural frequencies.

		Natural	
		frequency, ω_n	
		rad/sec (Hz)	Damping, ζ
X-Theta X Stick	Pitch	52 (8.3)	0.052
	Roll	31 (5.0)	0.028
X-Theta Z Stick	Pitch	35 (5.6)	0.035
	Roll	33 (5.3)	0.023
Center Stick	Pitch	27 (4.3)	0.21
	Roll	48 (7.7)	0.19

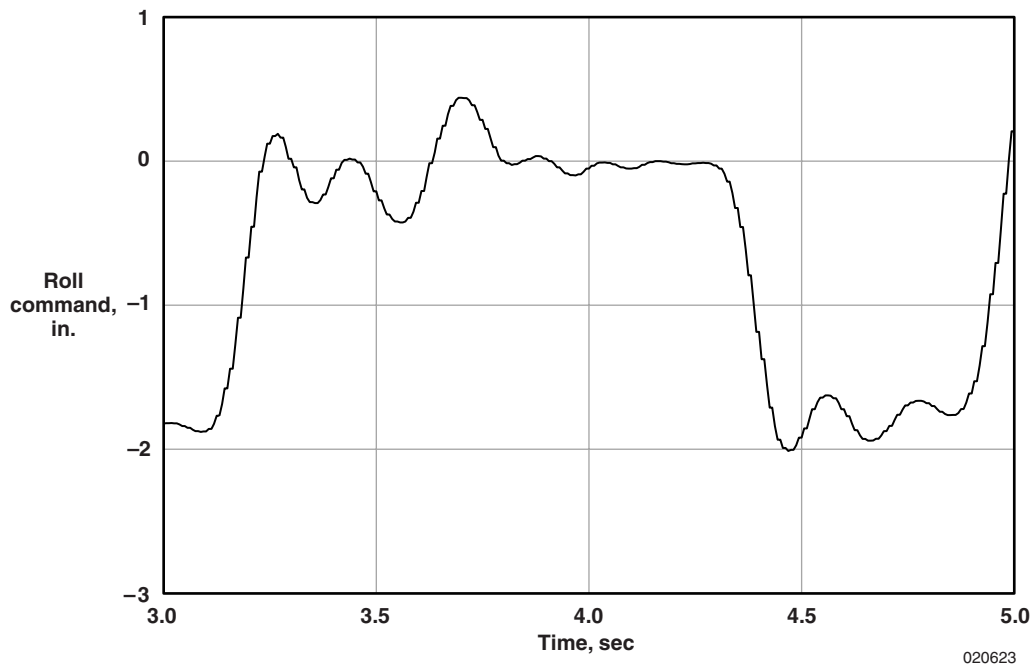

Figure 30. Oscillation at natural frequency of X-Theta Z stick.

The aggressive pilots had more trouble with the side sticks, because they tended to make frequent large inputs, causing large overshoots and oscillations. Although the sticks have adjustable air dampers, the maximum setting was minimally effective, and the evaluations were performed with no other setting. Increasing damping by approximately a factor of ten probably would have been a significant improvement. The center stick had greater damping and caused fewer problems of this nature. Less aggressive flying did not lead to as many difficulties with the side sticks, because small inputs made gradually were not likely to cause problems with overshoots or oscillation.

The low gain pilots commented more on breakout forces than the high gain pilots did, because when pilots attempt to make small and smooth inputs, breakout forces play a significant role. If the breakouts were a major component of the total force applied to the stick, the motion was observed to be jerky, and pilots had difficulty precisely making such inputs. The center stick was observed to have the highest and most objectionable breakout forces, creating difficulties with small, precise inputs. The configuration settings used for the center stick were the same as those used for the sticks in the dedicated F-18 simulators, so the difficulties might have been caused by the specific mechanism used.

The X-Theta Z stick was generally observed to have the lowest breakout forces and smoothest motion. The low breakout forces of the X-Theta Z stick allowed the low gain pilots to make small commands. Although the X-Theta X stick had similar forces, the motion was not as smooth, so it was not preferred by any of the pilots. The high gain pilots typically made inputs far beyond the breakout range and were not as adversely affected by breakout forces.

More specific trends were found by examining the time histories of all the pilots. Time histories from the target acquisition task are presented, because they exhibit trends representative of the entire evaluation. Pitch and roll commands are separated by axis to facilitate comparison of the different motion types. The plots show the commands received by the flight control algorithms.

Figure 31 presents time histories of the pitch command for a high gain pilot (pilot 1) using all three sticks. Both side sticks had larger commands than the center stick. Although oscillation is visible with both side sticks, it is at a higher frequency with the X-Theta X stick. The oscillation is especially pronounced between 11 and 14 sec into the task. The X-Theta Z stick provided slightly better pitch control than the other side stick, but the inputs from the X-Theta Z stick were much larger than those from the center stick. An oscillation is visible between 15 and 20 sec, but it is at a lower frequency than that of the X-Theta X stick. Overall, pilot 1 experienced much better pitch control with the center stick than with either side stick.

Pilot 1 also experienced much better roll control with the center stick than with either side stick (fig. 32). The pilot was able to make more small corrections with the center stick than with either side stick. Sharp inputs made with the side sticks typically resulted in overshoots and oscillation because of the insufficient damping. When the pilot attempted to hold a constant position after a large input, an oscillation of about 30 rad/sec (5 Hz) occurred. This oscillation corresponds with the natural frequency of the side sticks, illustrating the problem caused by insufficient damping.

The side sticks worked much better for the low gain pilots. Figure 33 shows the pitch commands from pilot 3. The pilot made larger inputs with the side sticks than with the center stick, but no oscillation was observed. Commands made with the side sticks were very similar to each other, indicating that any differences were not reflected in the usage. The differences were primarily in the feel of the sticks. The pilot tended to make more pulsed inputs with both side sticks than with the center stick; however, this change in technique did not appear to be a detriment to the pilot.

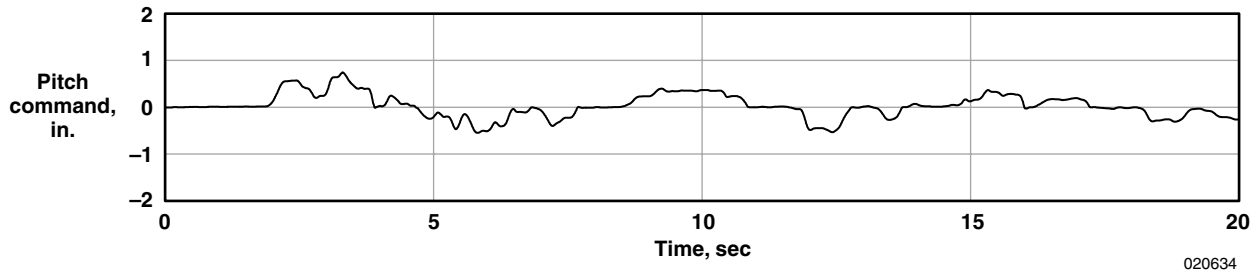

(a) Center stick.

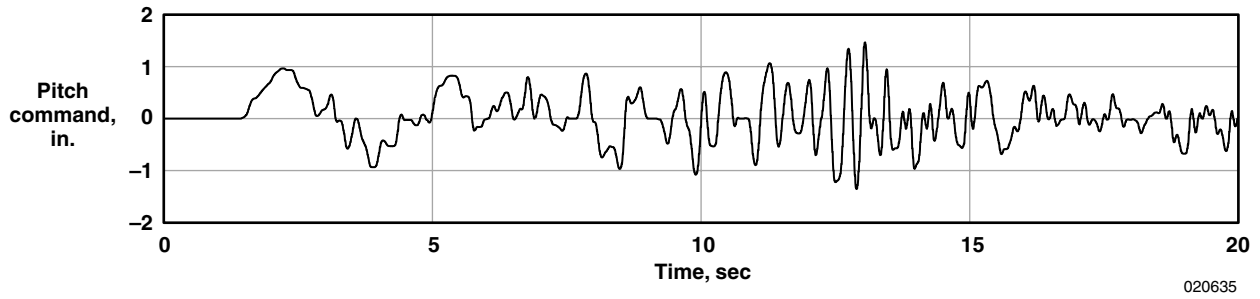

(b) X-Theta X stick.

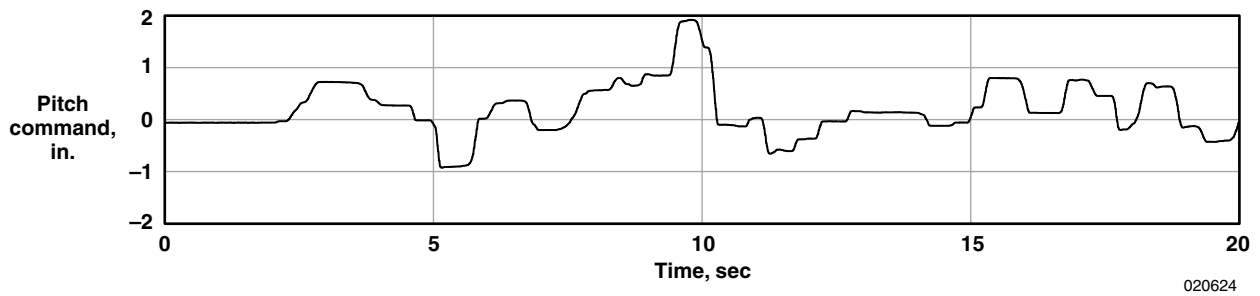

(c) X-Theta Z stick.

Figure 31. Target acquisition task pitch command, high gain pilot (No. 1).

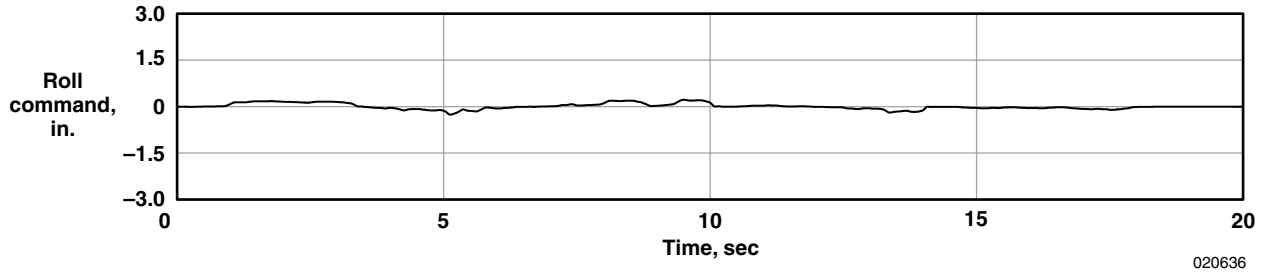

(a) Center stick.

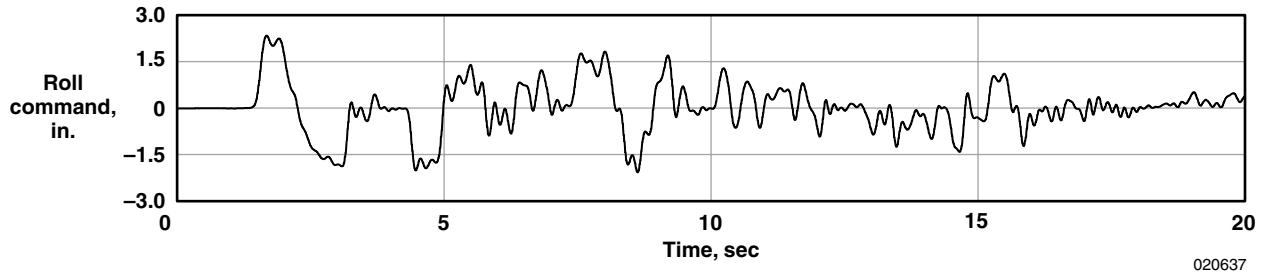

(b) X-Theta X stick.

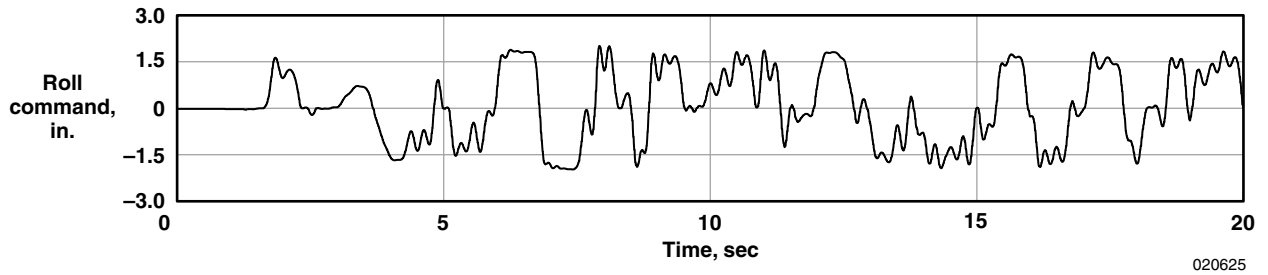

(c) X-Theta Z stick.

Figure 32. Target acquisition task roll command, high gain pilot (No. 1).

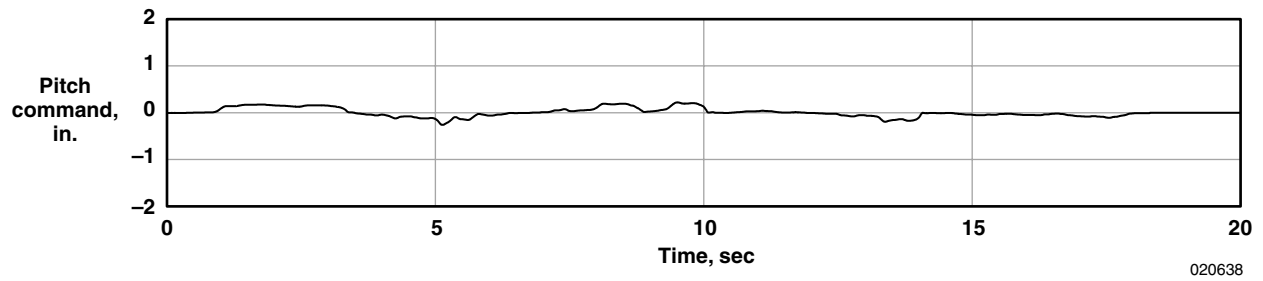

(a) Center stick.

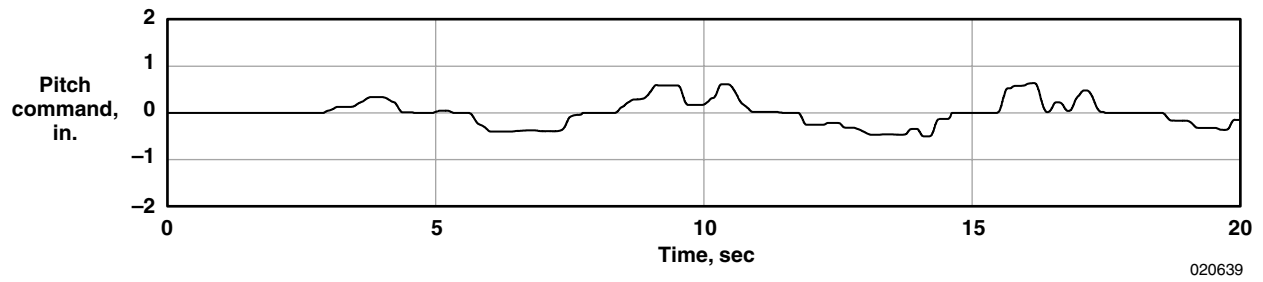

(b) X-Theta X stick.

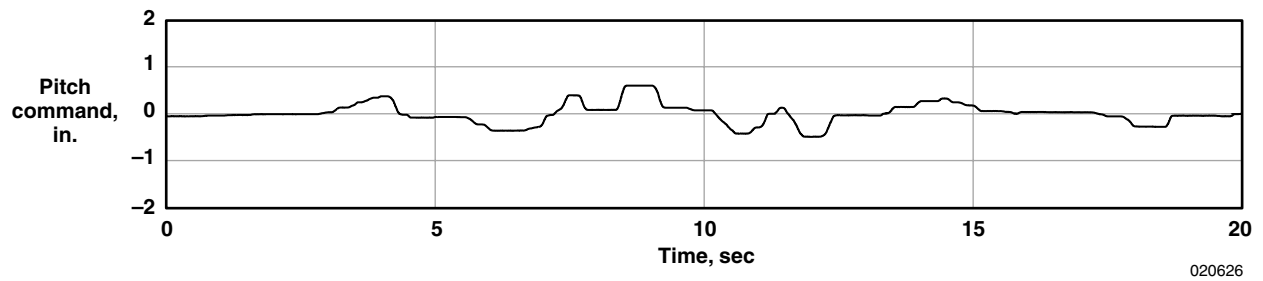

(c) X-Theta Z stick.

Figure 33. Target acquisition task pitch command, low gain pilot (No. 3).

Figure 34 presents roll commands for pilot 3. As with pilot 1, switching sticks did not have a noticeable effect on the magnitude of the commands. However, pilot 3 made smaller inputs with the side sticks than with the center stick, which is consistent with the pilot's comments that the breakout forces on the center stick were too high, interfering with small inputs. Both side sticks had lower breakout forces, but the two side sticks were not identical. With the X-Theta X stick, a small amplitude oscillation at the natural frequency of the stick was present after some inputs. Although both side sticks have very low damping and similar natural frequencies, the design might have contributed more to the dynamic problems with the X-Theta X stick than with the X-Theta Z stick.

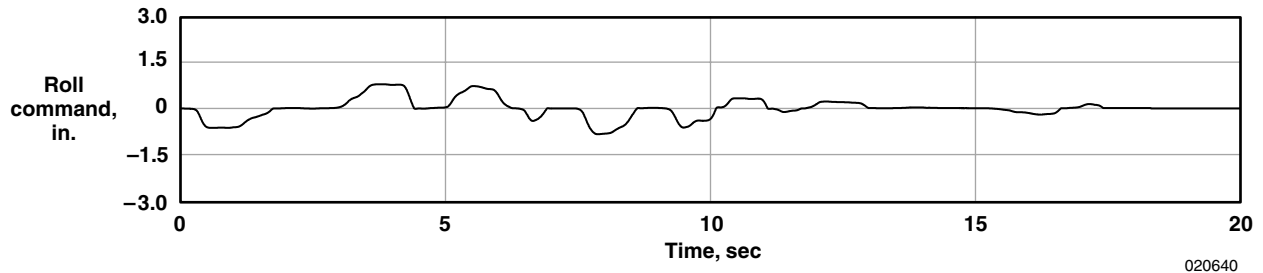

(a) Center stick.

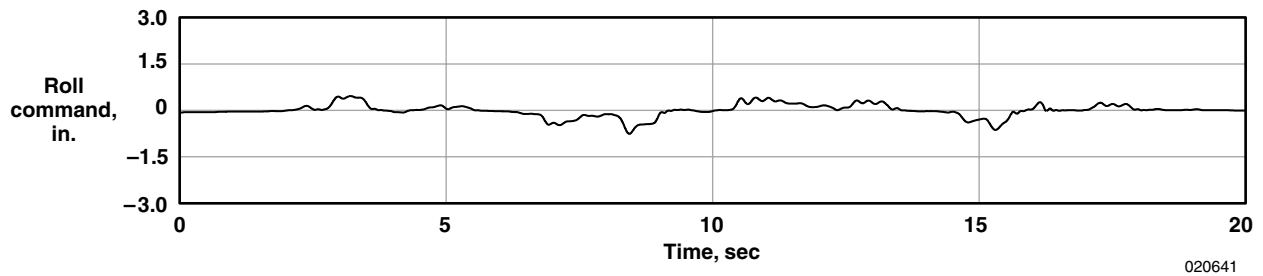

(b) X-Theta X stick.

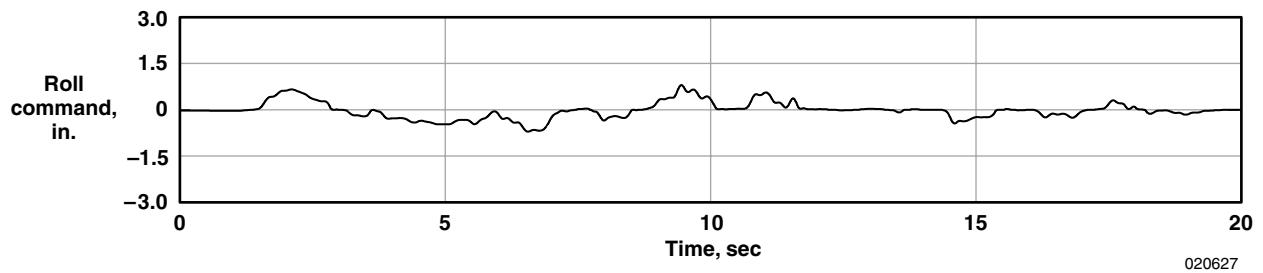

(c) X-Theta Z stick.

Figure 34. Target acquisition task roll command, low gain pilot (No. 3).

The difficulties with the side sticks were more pronounced in the current study than in the previous research. In the previous research the X-Theta Z stick was observed to give better control than the X-Theta X stick (ref. 9), although the opinion was not unanimous. No comments about insufficient damping were directly reported, but several pilots had difficulty making large inputs with the X-Theta X stick, and most pilots felt that the precision was poor. These comments are similar to those reported in the current study. In the previous study, significant variation in pilot workload existed, but the study did not show a separation between high gain and low gain pilots. The lack of a distinct separation might have been caused by the use of different simulators for the two experiments. The motion of the simulator in the previous experiment might have influenced pilot evaluations.

Ergonomics

The ergonomics of the side sticks and elbow cup were evaluated primarily through analysis of the pilot comments. Pilots were asked to comment on a range of issues relating to the sticks, including the forces, suitability of the motion, and precision of control. In addition, pilots were encouraged to make any other remarks about the sticks that they felt were relevant.

Although the pilots were asked to comment on the stick forces, none noticed the difference between the left and right roll gradients. Most pilots felt that the motion was fluid and did not notice the asymmetry. The absence of comments indicates that the design succeeded in providing uniform feel despite the differences in strength among various arm muscles used.

One purpose of the elbow cup is to accommodate the pilot in making control motions by moving the entire arm. For five of the pilots, this technique was not an improvement over using limited wrist motions. Although the fatigue experienced with the side sticks was noticeably less than that experienced with the center stick, only two pilots felt that the reduction in fatigue was sufficient to outweigh the disadvantages of using the entire arm for control. The mass of the arm increases the momentum of the system, impairing the response to rapid inputs. A small oscillation is visible after each large input in the roll command (fig. 34). These oscillations are similar in appearance to roll ratcheting, a biomechanical oscillation observed with other side stick controllers (ref. 13). Precise inputs, therefore, were more difficult to execute with the entire arm than with the wrist alone.

Furthermore, pilots commented that the shoulder is less precise than the wrist for making and sensing small commands, leading to uncertainty as to the size of the command made. This uncertainty is illustrated in figure 32(b) and described by pilot 1 (X-Theta X stick, acquisition task): *The stick tries to make my sensing device be taken away from my wrist, where it's most sensitive, and puts it in my shoulder, which is not that sensitive. Or, it causes me to have to rely on forces which is not a good tactile feedback because I can't tell how much force I'm pulling, so I'm constantly trying to figure out where that center point is so that I know where I'm at relative to the center of the stick motion. So I'm constantly hunting for that center point so I can have some feedback.*

Another disadvantage of the armrest is that it has low forces in the centering springs, which prevented the pilots from bracing their arms on the elbow cup. The cup was designed to only provide vertical support, so it was not effective when used for longitudinal support. Figure 35 illustrates the difficulty with arm bracing that the pilots experienced. Some pilots had to place a tighter grip on the stick in an attempt to brace the arm, an opposite reaction to that which was intended. Pilot 7 stated (X-Theta X stick, tracking task): *The elbow rest has very little friction associated with its fore and aft movement. The stick grip has*

relatively high movement. I'm feeling a tendency to try to stabilize the entire arm unit by gripping the stick grip harder than you have to. And I think that negatively impacts the feel of the overall system because you end up, not being required to, but gripping the stick hard to try to stabilize the whole forearm, and that ought to be looked at. Pilot 5 made similar comments (X-Theta X stick, tracking task): The worst thing is holding back stick. There's nothing to brace your arm, like on your knee, to help hold it so it's all upper arm muscle. It's not good for holding a precise deflection. This super slick armrest doesn't give you any help at all. Your arm is always searching back and forth in pitch. And roll is the same way. There's no lever point to put it there and hold it, so you're bobbling around.

In addition, the elbow cup created a false sense of motion feedback that the pilots had to filter out. Flexibility of the flesh contacting the elbow cup allowed relative motion between the elbow cup and arm. This flexibility was often felt as a lag between the movement of the elbow cup and stick when pitch commands were made. The resulting shear sensations in the arm were as apparent as the forces in the hand from the stick grip, but the shear sensations did not accurately reflect the stick position, forcing pilots to place more concentration on the stick than would otherwise be necessary. This false sense of motion was observed by pilot 1 (X-Theta X stick, acquisition task): *We have everything moving here, and no matter how you do it, at least two things are not moving at the same rate, so there is a little bit of a lag situation.*

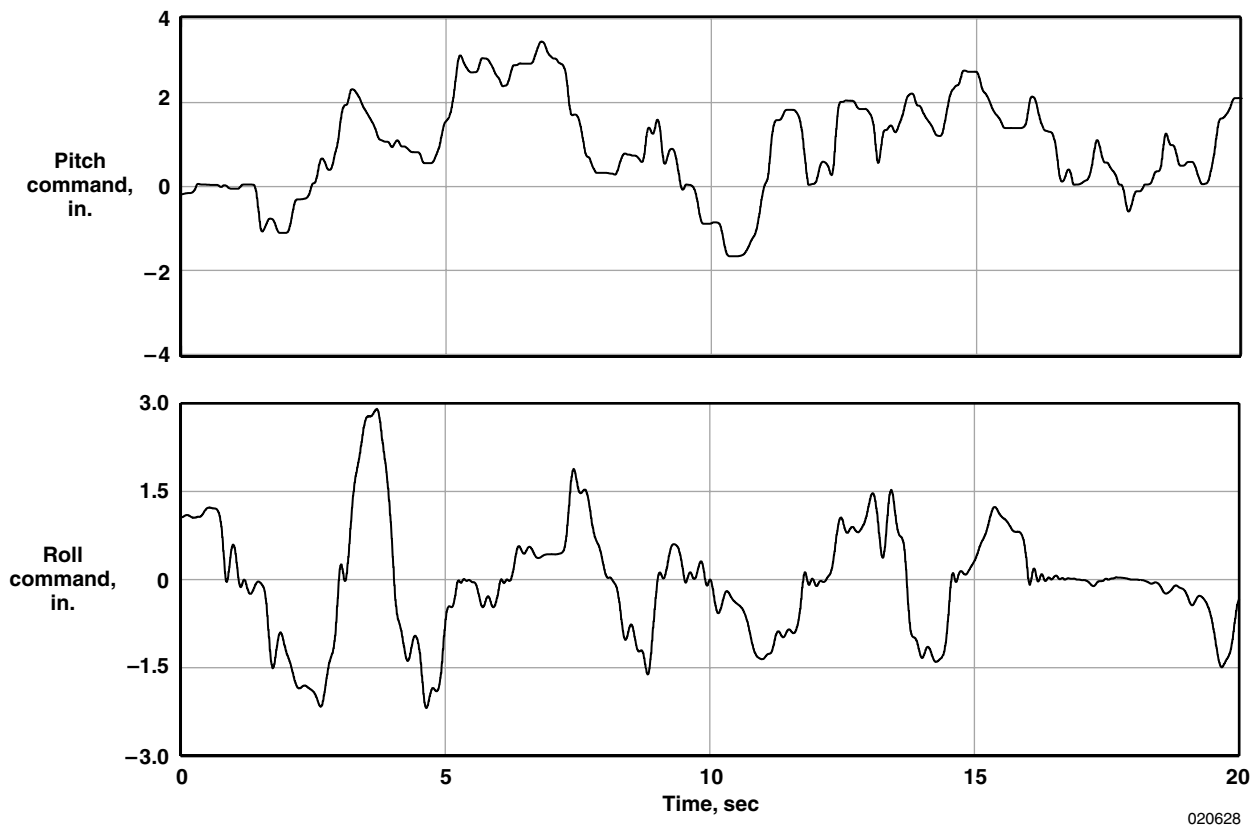

Figure 35. Target tracking task command searching, X-Theta X stick (pilot 5).

The pilots who liked the elbow cup primarily commented on the fatigue reduction. Pilot 4 remarked on the overall comfort of the system (X-Theta X stick, acquisition task): *It's a comfortable setup. I like the fact that the rest that your forearm sits into moves, so that when you move the stick, it moves with it. Better than trying to do that all with your wrist. I'm not really sure how that would work with g loading, though.* Pilot 2 noted the fatigue reduction (X-Theta X stick, landing task): *I'd rather have [the elbow cup] than to have to move my wrist, start getting carpal tunnel.*

The predominantly unfavorable opinions of the elbow cup in this experiment contrast the somewhat favorable views in the previous study (ref. 9). In the previous study, four of the eight evaluation pilots expressed favorable opinions of the elbow cup, particularly the translational motion; only one pilot commented that the motion impaired the controllability. The divergent opinions between the two experiments might have been caused by the differences between the large-amplitude motion simulator used in the previous study and the fixed-base simulator used in the current experiment.

The combination of the elbow cup and arm motion caused some pilots to experiment with different techniques. A few pilots preferred to use only the fingers and wrist for motion and leave the elbow cup completely out of the system, as illustrated in figure 36 and expressed by pilot 3 (X-Theta X stick, acquisition task): *Even when I do I'm searching in pitch. The nose is going up and down, up and down, up and down, and it's more noticeable. The roll axis seems to be a little bit more controllable. I'm not sure if it's because my arm and the whole thing is moving, and I'm not able to brace my wrist against a fixed object. I mean, I've never seen a forearm device that moves like this. So I'm making these inputs with a bigger muscle in my body than probably I need to. I can take that big muscle out of there by flying it with just my fingertips, and I seem to be a little bit better. Maybe this moveable arm rest is causing me more problems than the controls are. Once I get my whole arm moving, I'm creating more pitch searches than I think I want to.* Pilot 3 also remarked (X-Theta Z stick, landing task): *I just don't like this big motion I'm getting here. Not in my whole arm, I like to control it with the small fingers of my hand and I wasn't seeing that. I had to make bigger motions and this thing was floating back and forth like crazy here. It's objectionable.*

In a previous study of a different limited-motion control stick, pilots also commented that precise control was achieved by use of the fingers only (ref. 14). Although this technique enabled greater precision, the pilot's hand was not in the proper position to operate the toggle switches on the stick. In the current evaluation, the original intent of the elbow cup was negated by removing the pilot's arm from the system. The elbow cup as tested was not beneficial to most of the pilots; however, the concept might be more favorable if some of the shortcomings are addressed.

Pilot ratings of the two side sticks were not significantly influenced by the motion types. Most pilots were able to adapt to both motions, and some pilots did not notice the difference after an adjustment period. Pilot 3 observed (X-Theta Z stick, tracking task): *Starting, I make a little roll with the roll axis here and I'm not conscious of the fact that this [stick] is yawing instead of rolling. It's not a definite feedback to me that the stick motion, the mechanics of the motion, are not in roll. I'm feeding a roll input, and it's moving laterally, but it's not bothering me. Counter to what I would expect, it's not even entering into the thought process.* The criteria primarily influencing pilot ratings were the differences in breakout forces, damping, and overall feel of the sticks.

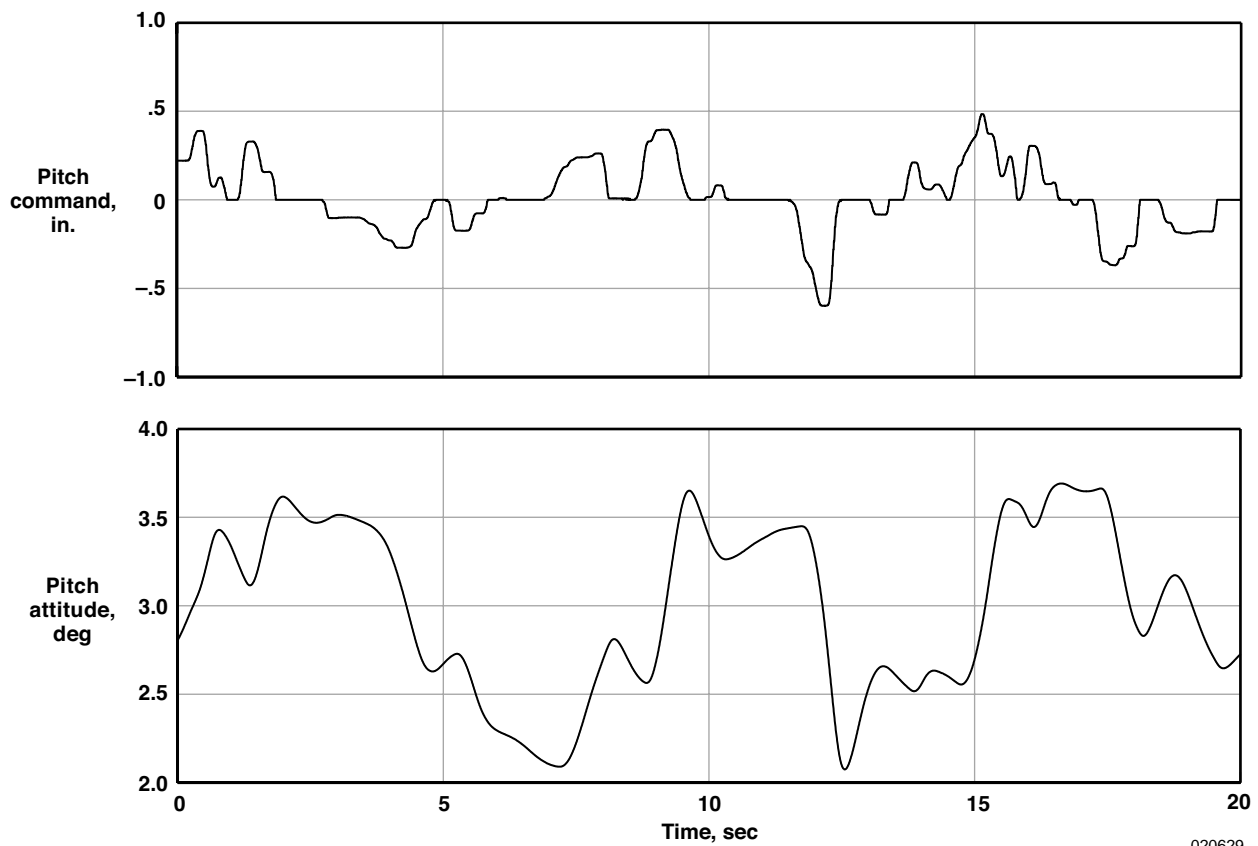

020629

Figure 36. Pitch wandering with X-Theta X stick (pilot 3).

Although the two side sticks did not feel much different from each other, the motion was noticeably different from that of the center stick. In particular, the nature of the motion was awkward for some pilots because of the muscles involved. The muscles used for pitch control were different from those used for roll control, causing difficulty for pilots to coordinate their inputs, as pilot 3 remarked (X-Theta X stick, landing task): *I was unable to harmonize my control inputs, mainly because my roll inputs are more with just the wrist or forearm, and the pitch is more with forearm and shoulder. I'm using two different sets of muscle groups to make the same small inputs. The only way I can get the harmony there is to go to just my fingers, to take my forearm out of it and my shoulder out of it. But I think the control harmony suffers because of that. The pitch has much more difficulty than the roll.* Pilot 7 commented that some coupled inputs felt unnatural (X-Theta X stick, landing task): *There is also a bit of an uncomfortable feeling when you are rolling back onto runway centerline by having to translate the arm forward as you roll inboard. This pushing-rolling kind of motion is a little bit unnatural. It might be a training issue, but I think it's aggravated by the fact that the large size is required under the current configuration to do that.*

Some pilots had difficulty sensing the position of the stick and had to separate the inputs into pitch and roll components to keep track of the stick position. Although an effective method for quantifying this coordination was not found, the effects are visible in a number of the stick traces. Figure 37 shows traces of the commands made for two cases. The oval-like curves in figure 37(a) were produced by simultaneously moving the stick in pitch and roll, indicating coordination. In figure 37(b), the cross-like nature of the data indicates that inputs were made in one axis only while the other was held constant. The cross-like characteristics were observed more often with the side sticks, consistent with pilot comments on the issue. This effect is undesirable, because it represents both an increase in compensation required by the pilot and a lack of stick harmony.

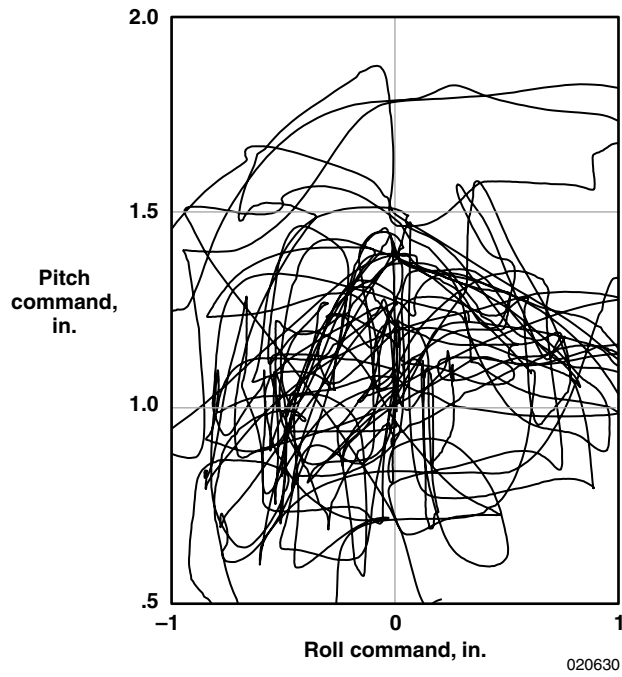

(a) Coordinated inputs (pilot 4, center stick).

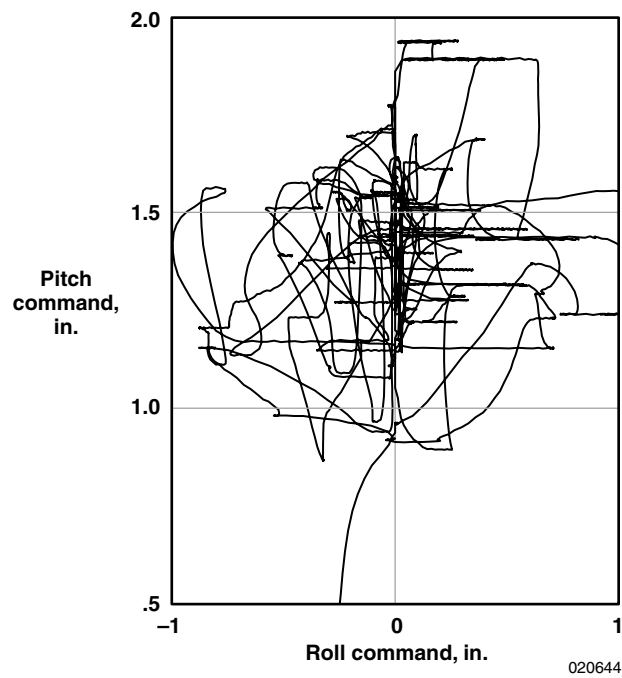

(b) Noncoordinated inputs (pilot 3, X-Theta Z stick).

Figure 37. Command coordination, target tracking task.

Rating Scatter

Several possible explanations for the rating scatter were examined. One possible explanation is the effect of airspeed variations. Some of the pilots had difficulty maintaining constant airspeed even with a fixed-range target. Airspeed variations might have altered the handling qualities of the aircraft, affecting task difficulty. For the target acquisition task, pilots who were significantly faster or slower than desired tended to give higher ratings than those who maintained the proper airspeed. No trends were present for the other tasks. The airspeed variations might have caused the degraded handling qualities, and thus lead to worse ratings. Conversely, the degraded handling qualities might have caused excessive pilot workload, and thus lead to insufficient airspeed control. Whether airspeed variations were the cause or effect of the degraded handling qualities is not known.

A brief handling qualities analysis was performed to determine the effect of airspeed on handling. Pitch response was obtained from low order equivalent system (LOES) fits of simulator frequency response data (refs. 15, 16). The aircraft was modeled by a second-order transfer function relating pitch rate, q , to pitch command, DEP :

$$q/DEP = \left[K_q (s + 1/T_{q_2}) e^{-\tau s} \right] / [s^2 + 2\zeta_{sp} \omega_{sp} s + \omega_{sp}^2]$$

The simulator supplied a sinusoidal pitch stick input of constant magnitude and increasing frequency, and the pitch rate response was recorded. Data was collected for a range of airspeeds, and an optimization program was used to determine the values of K_q , τ , ζ_{sp} , and ω_{sp} that most closely approximated the simulator data. To produce a more accurate approximation, T_{q_2} was calculated separately and supplied to the optimization routine. This parameter was calculated at each flight condition from the following equation:

$$T_{q_2} = 1/L_\alpha = n_\alpha g/v$$

where n_α is calculated from a pitch step input at each speed, v .

Figure 38 compares the control anticipation parameter (CAP) and damping ratio, ζ_{sp} , to military handling qualities requirements (ref. 17). The CAP is defined as:

$$CAP = \omega_{sp}^2 / n_\alpha$$

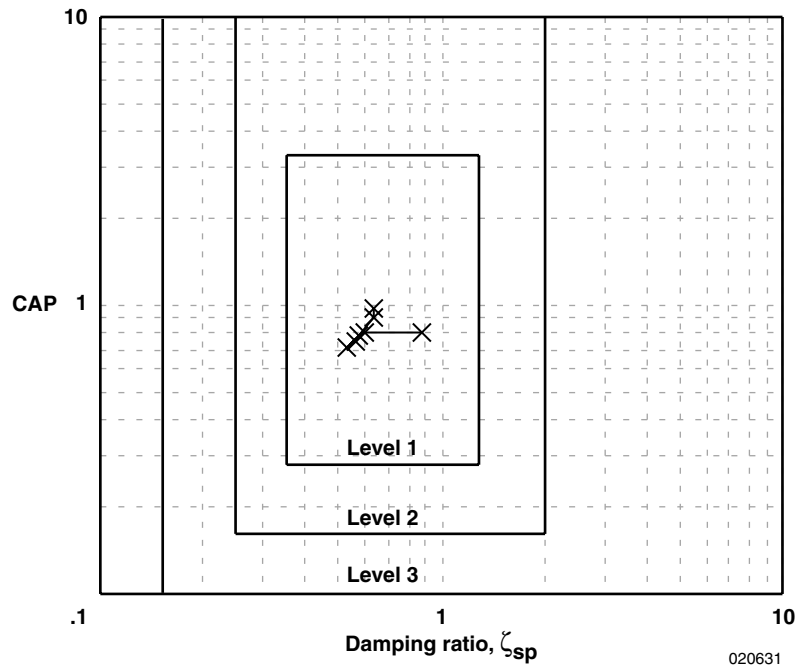

(a) Short period dynamics.

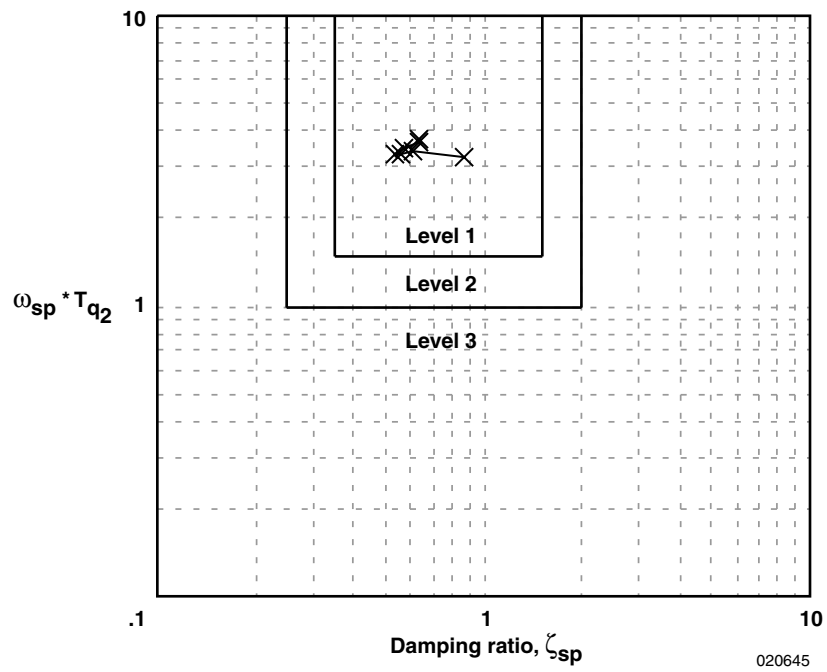

(b) Short period pitch response.

Figure 38. Longitudinal handling qualities.

For airspeeds between 250 and 475 knots (500 to 925 ft/sec), the response was well within the level 1 boundaries, indicating that pitch response should have been desirable for this range. A lateral LOES could not be obtained from the simulator. Instead, the roll response to an aileron command is presented (fig. 39). Roll sensitivity increased over the range of airspeeds; however, the increase was not drastic enough to account for the wide variation in ratings. In addition, pilots who were either fast or slow gave high ratings. If a strong correlation between airspeed and ratings existed, the lowest ratings would be at one extreme of the speed range and the highest ratings would be at the other.

As previously discussed, some rating scatter was the result of piloting technique. Figures 24 through 29 show that the ratings from the high gain pilots are typically higher than the ratings from the low gain pilots. In addition, a number of pilots complained that the simulator was more sensitive than the actual aircraft. Pilot 2 noted (center stick, tracking task): *I think the sim is quite a bit more difficult than the airplane. I didn't notice that much trouble tracking in the actual airplane.* Pilot 5 also noted (center stick, landing task): *If this is supposed to be the baseline F-18, then I don't like it nearly as much as I do the real airplane.*

Although the increased sensitivity of the simulator was noted by most pilots, the sensitivity was a significant problem only when the simulator was aggressively flown. Aggressive piloting in a sensitive aircraft generally leads to oscillations. Consequently, the more aggressive pilots in this examination had more problems with pilot induced oscillation (leading to worse ratings, both CHR and PIO) than the less aggressive pilots had.

Although the simulation used in this experiment was verified against the dedicated F-18 simulator at NASA Dryden, pilots felt that the simulator was not representative of the actual F-18 aircraft. The source of the simulator deficiencies is not known, although lags in the display and pilot interface systems might have been a factor. The increased sensitivity of the simulator resulted in a separation between the high gain and low gain pilots.

Table 11 shows the performance criteria for the target acquisition task. The numerals represent the number of attempts that resulted in each performance level for each criterion. The desired performance level for acquisition time was frequently attained. Most pilots exceeded the acceptable numbers of overshoots, however, which confirms that the pilots were having problems with oscillation. For this task, the low gain pilots generally performed better than the high gain pilots, because the low gain pilots were less likely to exceed the allowable number of overshoots. A similar pattern is visible in the target tracking task (table 12).

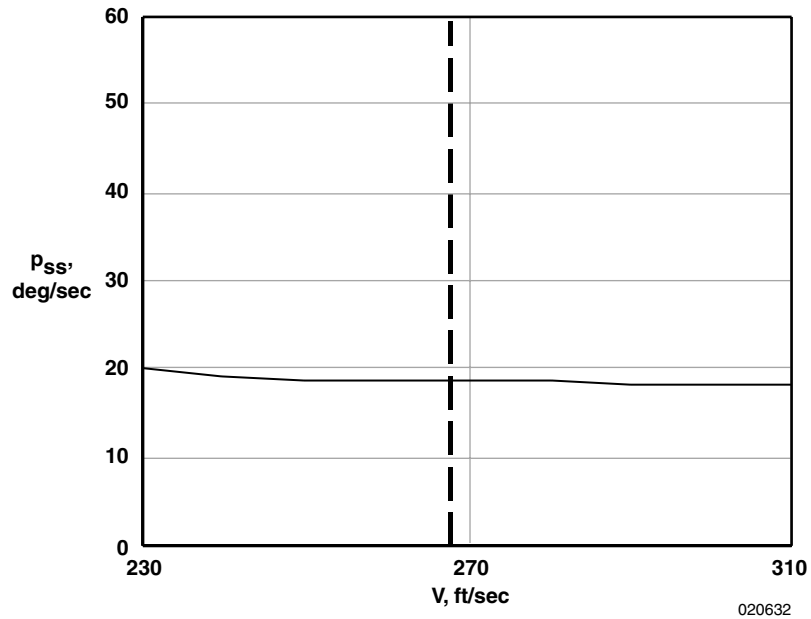

(a) Landing configuration, 3000 ft.

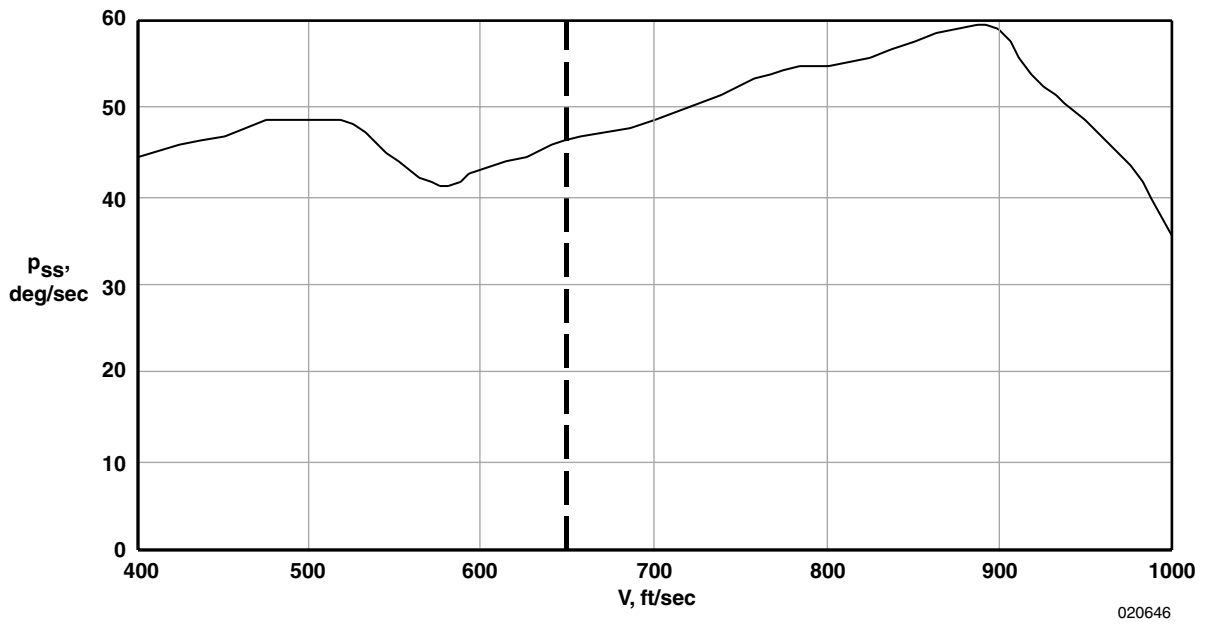

(b) Clean configuration, 10,000 ft.

Figure 39. Steady-state roll response to 1-in. roll command.

Table 11. Target acquisition task performance criteria.

	Acquisition Time			Number of Overshoots		
	Center	X-Theta X	X-Theta Z	Center	X-Theta X	X-Theta Z
Desired Performance	26	14	16	17	6	9
Adequate Performance	4	5	4	3	1	1
Inadequate Performance	3	4	4	13	16	14

Table 12. Target tracking task performance criteria.

	Fraction of Time Acquired			Number of Overshoots		
	Center	X-Theta X	X-Theta Z	Center	X-Theta X	X-Theta Z
Desired Performance	1	0	2	0	4	4
Adequate Performance	7	2	9	0	7	4
Inadequate Performance	17	23	14	25	14	17

Another possible explanation for the rating scatter is the difficulty in estimating task performance. Although the simulator recorded each pilot's performance, pilots were allowed to use their own estimations when providing CHRs. Subsequent analysis showed that pilots typically overestimated their performance when supplying ratings. The criteria were further broken down to determine the performance of each criterion.

Table 11 shows that for the acquisition task, pilots achieved desired performance on the majority of attempts with acquisition time but achieved inadequate performance on the majority of attempts with the number of overshoots. The pilots might have been more concerned with the speed at which the target was acquired and were less concerned with the number of overshoots, although the task required that the overshoots be kept to a minimum. Table 12 shows that for the tracking task, pilots achieved inadequate performance on the majority of attempts with both criteria, suggesting that the criteria were too strict. The pilots' overestimates of performance possibly resulted from the difficulty in estimating either criterion. Providing an indication to the pilot might have helped this issue.

Table 13 presents the performance criteria for the offset landing task. A strong bias towards touchdown location over airspeed and sink rate is present. Pilots were able to touch down within the desired distance from the centerline on the majority of attempts and usually achieved at least adequate performance for longitudinal distance from the aim point. Conversely, few pilots maintained the specified velocity. In particular, the sink rate was difficult to judge with the visual displays provided. Pilot 1 observed that the sink rate and touchdown point requirements can work against each other. A flare is required to meet the sink rate criterion, which can prevent precise location control. The data in table 13 suggest that pilots were most concerned with the touchdown location, even at the expense of the other requirements. Although the specified approach airspeed was reasonable for the aircraft configuration, pilots flew at airspeeds with which they were most comfortable, usually slower than the specified airspeed.

Table 13. Offset landing task performance criteria.

	Offset from Centerline			Distance from Aim Point		
	Center	X-Theta X	X-Theta Z	Center	X-Theta X	X-Theta Z
Desired Performance	21	21	20	6	8	8
Adequate Performance	1	1	0	11	9	11
Inadequate Performance	0	0	0	5	4	1
	Sink Rate			Touchdown Velocity		
Desired Performance	5	1	4	2	1	1
Adequate Performance	9	11	7	4	3	5
Inadequate Performance	8	10	9	16	18	14
	Minimum Velocity			Maximum Velocity		
Desired Performance	1	2	0	0	0	0
Adequate Performance	0	0	0	17	13	13
Inadequate Performance	21	20	20	5	9	7

Although the ratings are scattered, several trends are visible. The ratings generally correspond with each pilot's stated preference, indicating that each pilot evaluated the three sticks with constant criteria. For the acquisition and tracking tasks, the low gain pilots generally gave lower ratings for the X-Theta Z stick than for the other sticks. The center stick received the highest ratings, however, despite being preferred over the X-Theta X stick. The ratings from the high gain pilots follow the opposite trend. Trends for the landing task are less visible, suggesting that the less demanding nature of this task did not cause significant separation between the high gain and low gain pilots.

CONCLUDING REMARKS

A handling qualities evaluation compared two unique side stick controllers to a standard center stick. The side sticks are not like other side sticks in that they use large ranges and unique types of motion. A moving elbow cup is included to ensure that motions are made with the entire arm. Both sticks translate horizontally for pitch control. On the first side stick, known as X-Theta X, roll control is accomplished by rotating the stick side to side about a longitudinal axis, parallel to the aircraft length at the base of the stick, similar to the roll control in a conventional side stick. The second side stick, known as X-Theta Z, is more unusual in that roll control is accomplished by a rotation around the vertical axis located near the pilot's elbow. To determine which of these motions was optimal for a fighter aircraft, the experiment compared the two side sticks to each other, and compared both side sticks to the standard F-18 center stick.

Seven research pilots flew several fighter maneuvers using all three sticks in a NASA Dryden Flight Research Center fixed-base F-18 flight simulator. The pilots provided Cooper-Harper Ratings (CHRs), pilot induced oscillation (PIO) ratings, and comments about specific aspects of the three sticks. Overall, few pilots noticed any differences directly related to the motion types of the sticks. The primary factors influencing pilot preferences involved the construction of the sticks rather than the design. The insufficient damping in the side sticks caused difficulty for pilots who flew in an aggressive manner ("high gain" pilots), because large inputs associated with aggressive flying caused overshoots and oscillation. The high gain pilots preferred the center stick, because it responded well to large inputs.

The pilots who flew less aggressively ("low gain" pilots) preferred the side sticks because of the low breakout forces, especially those on the X-Theta Z stick, which enabled the pilots to make smoother inputs than was attainable with the center stick. Although they had some problems with oscillation, the low gain pilots usually did not move the stick quickly enough to experience major overshoots. Conversely, the high breakout forces on the center stick made smooth motions difficult to achieve.

The design of both side sticks took into account the effect of ergonomic advantage. The side sticks feature stiffer force gradients for left roll commands than for right. Because pulling the stick is naturally easier than pushing it away, the gradients were configured to provide a constant feel in roll. The gradients differ by approximately 10 percent. The pilots did not notice this asymmetry, however, indicating that the sticks countered the ergonomic advantage.

Another area of interest was the ergonomic effect of the unusual motions. Although pilots noticed a significant decrease in fatigue with the elbow cup, using the entire arm for control reduced overall precision. Some pilots were not able to brace their arms on the elbow cup because of the motion and compensated by placing a tighter grip on the stick. Many pilots felt that making precise inputs and sensing forces were more difficult with the shoulder than with the wrist or forearm, because the shoulder is less sensitive. The flexibility of the arm flesh contacting the elbow cup created a false sense of motion, further impairing precision.

A significant amount of scatter was present in the pilot ratings. The major factor for the scatter was increased simulator sensitivity when compared to the actual aircraft. The F-18 simulator was more sensitive than the actual aircraft and thus more prone to pilot induced oscillation, causing more problems for aggressive pilots. The increased sensitivity was likely caused by delays in the display and pilot interface systems and resulted in higher ratings from the high gain pilots than from the low gain pilots. Pilots also had difficulty measuring their performance on the three tasks and tended to overestimate. In particular, location, touchdown velocity, and sink rate were difficult to control with the task and visual displays provided. In spite of the scatter, the rating trends reflected the pilots' stated preferences.

Opinions of the three sticks might significantly change if the sticks and simulator were modified. With lower breakout forces, the center stick might have been more favorable to all pilots, although the high breakout forces might have been a simulator issue. A major concern with the two side sticks was the insufficient damping. Connecting the elbow cup to the side stick such that they moved together for pitch control might improve the feel of the system.

REFERENCES

1. Knowles, William B., *Primary Controller Designs for Jet Transports*, AFFDL-TR-66-203, March 1967.
2. Rhoads, Donald W., *In-Flight Evaluation of Four Cockpit Controller Configurations in a Variable Stability Airplane*, AFFDL-TR-70-95, Sept. 1970.
3. Eggers, James A. and William F. Bryant, Jr., *Flying Qualities Evaluation of the YF-16 Prototype Lightweight Fighter*, AFFTC-TR-75-15, July 1975.
4. Pape, James K. and Michael P. Garland, *F-16A/B Flying Qualities Full Scale Development Test and Evaluation*, AFFTC-TR-79-10, Sept. 1979.
5. Graves, Harry C., A. James Bailey, and David L. Mellen, *Study and Development of an Electric Side Stick Controller for Aerospace Vehicles*, ASD-TR-61-603, May 1962.
6. Black, G. Thomas and David J. Moorhouse, *Flying Qualities Design Requirements for Sidestick Controllers*, AFFDL-TR-79-3126, Oct. 1979.
7. Hall, G. Warren and Roger E. Smith, *Flight Investigation of Fighter Side-Stick Force-Deflection Characteristics*, AFFDL-TR-75-39, May 1975.
8. Wyllie, C.E., "Aircraft Side Hand Controllers – Where to From Here?" *Proceedings of the IEEE National Aerospace and Electronics Conference*, May 23–27, 1988, pp. 454–460.
9. Jenney, Dr. Gavin, Bruce Raymond, William Talley, and Xung Bui, *Investigation of Two Sidestick Flight Controllers*, SBIR Phase II Final Report under Air Force contract F33615-95-C-3610, Dec. 1998.
10. Norlin, Ken A., *Flight Simulation Software at NASA Dryden Flight Research Center*, NASA TM-104315, Oct. 1995.

11. Cooper, George E. and Robert P. Harper, Jr., *The Use of Pilot Rating in the Evaluation of Aircraft Handling Qualities*, NASA TN D-5153, April 1969.
12. Bailey, R.E. and R.E. Smith, *An In-Flight Investigation of Pilot-Induced Oscillation Suppression Filters During the Fighter Approach and Landing Task*, Calspan 6645-F-9, Oct. 1981.
13. Smith, John W. and Terry Montgomery, *Biomechanically Induced and Controller Coupled Oscillations Experienced on the F-16XL Aircraft During Rolling Maneuvers*, NASA TM-4752, July 1996.
14. Carter, John F. and P.C. Stoliker, *Flying Quality Analysis of a JAS39 Gripen Ministick Controller in an F/A-18 Aircraft*, NASA TM-2000-209024, Aug. 2000.
15. Hodgkinson, J., "Equivalent Systems Criteria for Handling Qualities of Military Aircraft," AGARD-CP-333, June 1982.
16. Stoliker, P.C., *High-Angle-of-Attack Handling Qualities Predictions and Criteria Evaluation for the X-31A*, NASA TM-4758, March 1997.
17. U.S. Air Force, *Flying Qualities of Piloted Vehicles*, MIL-STD-1797, Mar. 31, 1987.

REPORT DOCUMENTATION PAGEForm Approved
OMB No. 0704-0188

Public reporting burden for this collection of information is estimated to average 1 hour per response, including the time for reviewing instructions, searching existing data sources, gathering and maintaining the data needed, and completing and reviewing the collection of information. Send comments regarding this burden estimate or any other aspect of this collection of information, including suggestions for reducing this burden, to Washington Headquarters Services, Directorate for Information Operations and Reports, 1215 Jefferson Davis Highway, Suite 1204, Arlington, VA 22202-4302, and to the Office of Management and Budget, Paperwork Reduction Project (0704-0188), Washington, DC 20503.

1. AGENCY USE ONLY (Leave blank)		2. REPORT DATE December 2003	3. REPORT TYPE AND DATES COVERED Technical Memorandum	
4. TITLE AND SUBTITLE Evaluation of Two Unique Side Stick Controllers in a Fixed-Base Flight Simulator			5. FUNDING NUMBERS 710-55-24-E8-RR-00-DFR	
6. AUTHOR(S) Jann Mayer and Timothy H. Cox				
7. PERFORMING ORGANIZATION NAME(S) AND ADDRESS(ES) NASA Dryden Flight Research Center P.O. Box 273 Edwards, California 93523-0273			8. PERFORMING ORGANIZATION REPORT NUMBER H-2512	
9. SPONSORING/MONITORING AGENCY NAME(S) AND ADDRESS(ES) National Aeronautics and Space Administration Washington, DC 20546-0001			10. SPONSORING/MONITORING AGENCY REPORT NUMBER NASA/TM-2003-212042	
11. SUPPLEMENTARY NOTES				
12a. DISTRIBUTION/AVAILABILITY STATEMENT Unclassified—Unlimited Subject Category 08 This report is available at http://www.dfrc.nasa.gov/DTRS/			12b. DISTRIBUTION CODE	
13. ABSTRACT (Maximum 200 words) A handling qualities analysis has been performed on two unique side stick controllers in a fixed-base F-18 flight simulator. Each stick, which uses a larger range of motion than is common for similar controllers, has a moving elbow cup that accommodates movement of the entire arm for control. The sticks are compared to the standard center stick in several typical fighter aircraft tasks. Several trends are visible in the time histories, pilot ratings, and pilot comments. The aggressive pilots preferred the center stick, because the side sticks are underdamped, causing overshoots and oscillations when large motions are executed. The less aggressive pilots preferred the side sticks, because of the smooth motion and low breakout forces. The aggressive pilots collectively gave the worst ratings, probably because of increased sensitivity of the simulator (compared to the actual F-18 aircraft), which can cause pilot-induced oscillations when aggressive inputs are made. Overall, the elbow cup is not a positive feature, because using the entire arm for control inhibits precision. Pilots had difficulty measuring their performance, particularly during the offset landing task, and tended to overestimate.				
14. SUBJECT TERMS Cooper-Harper Rating, Dynamic Controls, Inc., Ergonomics, Flying qualities, Handling qualities, Side stick controller			15. NUMBER OF PAGES 56	
			16. PRICE CODE	
17. SECURITY CLASSIFICATION OF REPORT Unclassified	18. SECURITY CLASSIFICATION OF THIS PAGE Unclassified	19. SECURITY CLASSIFICATION OF ABSTRACT Unclassified	20. LIMITATION OF ABSTRACT Unlimited	