



## Physical Sciences Research POP 2003 Fluid Physics Program



Glenn Research Center

---

### Human Research Initiative (HRI)

#### INTRODUCTION:

- A code U initiative starting in the FY04 budget includes specific funding for “Phase Change” and “Multiphase Flow Research” on the ISS.
- NASA GRC developed a concept for two facilities based on funding/schedule constraints:
  - Two Phase Flow Facility (T<sup>2</sup>FFy) – assumed integrating into FIR
  - Contact Line Dynamics Experiment Facility (CLiDE) – assumed integration into MSG
- Each facility will accommodate multiple experiments conducted by NRA selected PIs with an overall goal of enabling specific NASA strategic objectives.
- May also be a significant ground-based component.

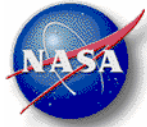

**Physical Sciences Research POP 2003**  
**Fluid Physics Program**



Glenn Research Center

**Two-Phase Flow Facility (T $\phi$ FFy)**

**OBJECTIVES:**

Develop a multi-user mini facility for conducting strategic research in the area of two-phase flow. The research will consist of experiments to conduct focused studies and provide critical data on boiling, condensation and two phase flow. Specifically, experiments will study the effects of microgravity on modes of heat transfer and flow regimes during convective boiling and the flow characteristics of two-phase flow through fluidic components and porous media.

**APPROACH:**

A forced-flow loop with multiple test sections and controlled heating and cooling will be developed for utilization in the FCF-FIR. Maximum use of facility provided capabilities will be utilized.

**BENEFITS:**

Improved understanding of heat transfer processes in multi-phase flow, which will allow for the development of lower-mass space thermal systems and advanced space power systems. Experimentation will support power generation and storage, space propulsion and life support systems.

**Project Milestone Schedule**





**Physical Sciences Research POP 2003**  
**Fluid Physics Program**



Glenn Research Center

---

## **Two-Phase Flow Facility (T $\phi$ FFy)**

### ***Flow Boiling Heat Transfer***

- Conduct focused studies on the effects of microgravity on the modes of heat transfer and the corresponding flow patterns in forced convective boiling.
- Provide data on the effects of gravity and liquid inertial forces on CHF.
- Develop advanced optical techniques to understand multiphase flow dynamics, including bubble growth and transport, liquid and vapor droplet sizing, and velocity measurements.
- Investigate techniques for CHF enhancement.

### ***Flow Through Fluidic Components***

- Conduct studies of 2-phase flow in microgravity through geometries representing fittings, accumulators, and valves.
- Investigate incidence of metastable states in flow of flashing liquid and choking in fluidic system components.

### ***Porous Media***

- Conduct focused studies on the effects of microgravity on a gas-liquid fixed Packed Bed Reactor.
- Provide critical data on the effects of gravity on the hydrodynamic properties of gas-liquid flow through porous media.



Physical Sciences Research POP 2003  
Fluid Physics Program



Glenn Research Center

Two-Phase Flow Facility (T $\phi$ FFy)

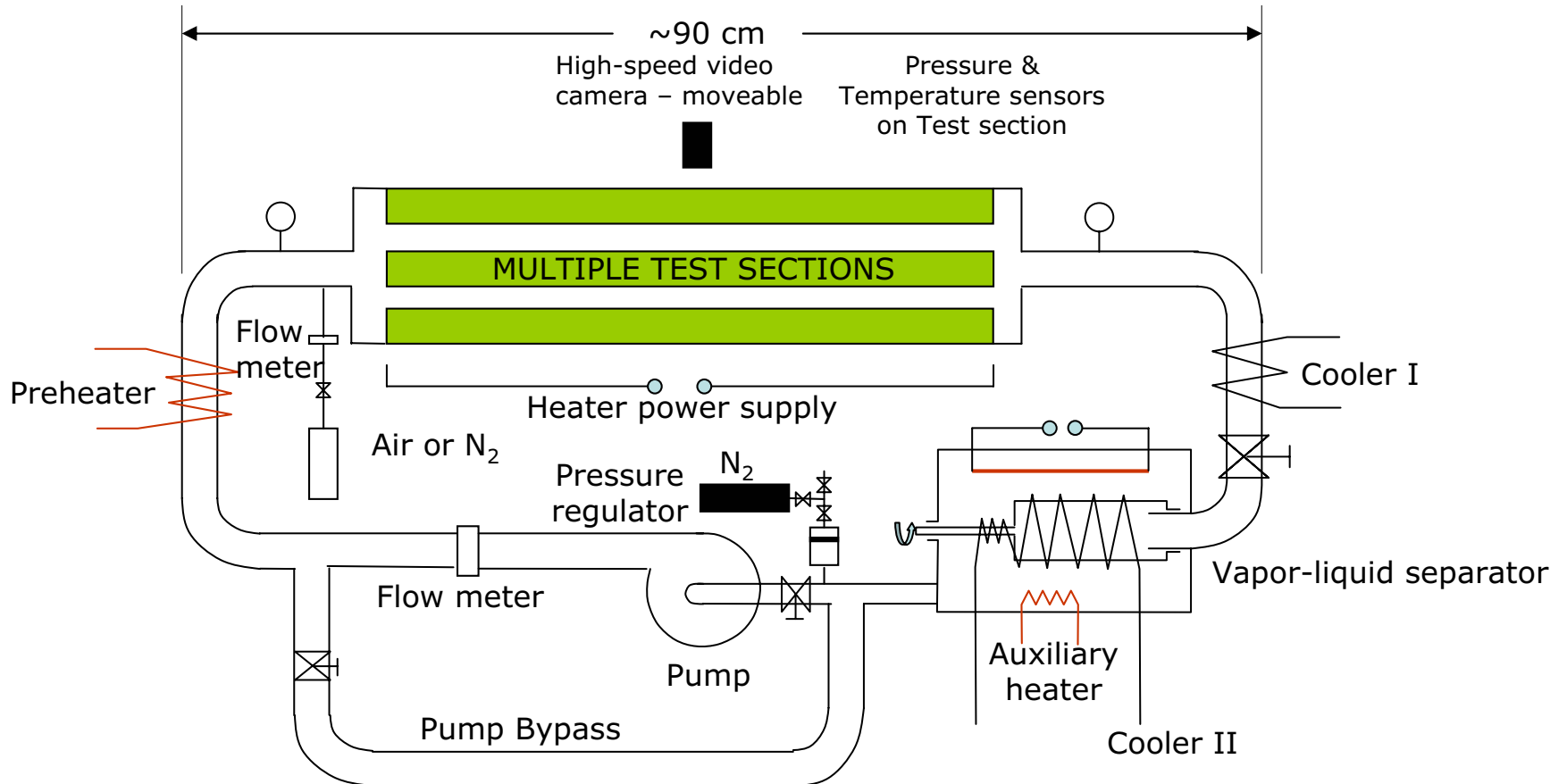

Multiple test sections to investigate various geometries and flow regimes

- Preheater and cooler for temperature control
- Pump for forced convection
- Liquid/vapor separator



**Physical Sciences Research POP 2003**  
**Fluid Physics Program**



Glenn Research Center

**Contact Line Dynamics Experiment Facility (CLiDE)**

**OBJECTIVES:**

Develop facility for conducting strategic research on the effects of contact line dynamics on the behavior of liquid-vapor systems that are controlled by capillarity.

**APPROACH:**

A circular pinning edge will be placed on the periphery of the cell. An indexing motor will move a cylindrical tube along its axis and perpendicular to the plane of the pinning edge. An axially symmetric fluid-vapor interface will form between the tube and the pinning edge. Various modes of tube motion will be possible, depending on the specific objective. The facility will be able to handle any fluid and solid surface including realistic fluids used in space fluid systems and suitably wettability-modified solid surfaces.

**BENEFITS:**

Improved understanding of the effect of contact line dynamics in microgravity will improve fluid and heat transfer models. This enhanced understanding will also lead to more efficient propellant tank, heat-pipe, and evaporator designs.

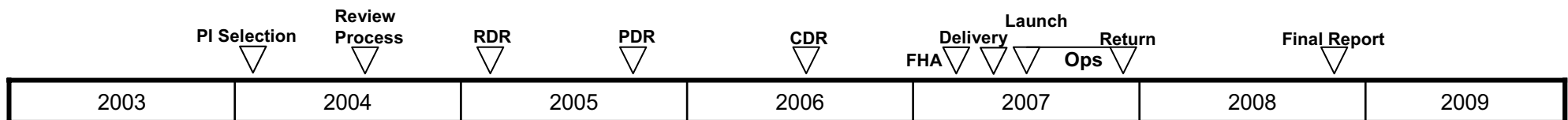



*Physical Sciences Research POP 2003*  
Fluid Physics Program



Glenn Research Center

## Contact Line Dynamics Experiment Facility (CLiDE)

- Develop an understanding on how contact line dynamics affects interface behavior in low gravity.
- Investigate the use of surface properties to control interface dynamics.
- Develop an understanding of the contact line boundary condition to be used in CFD models.

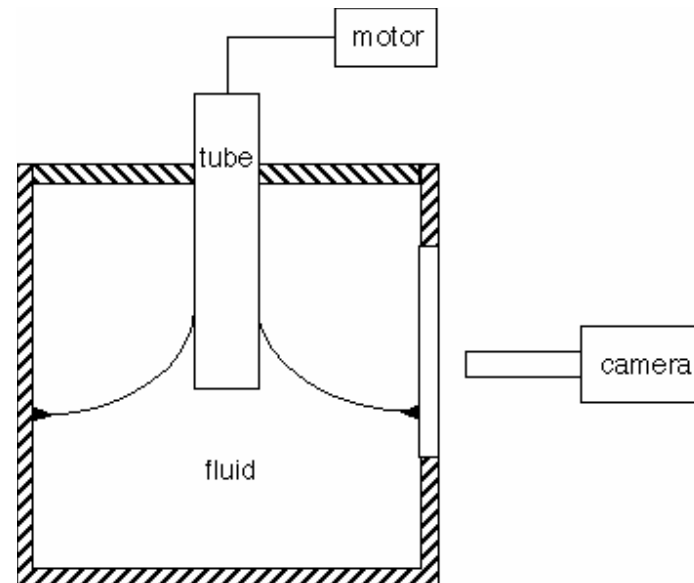
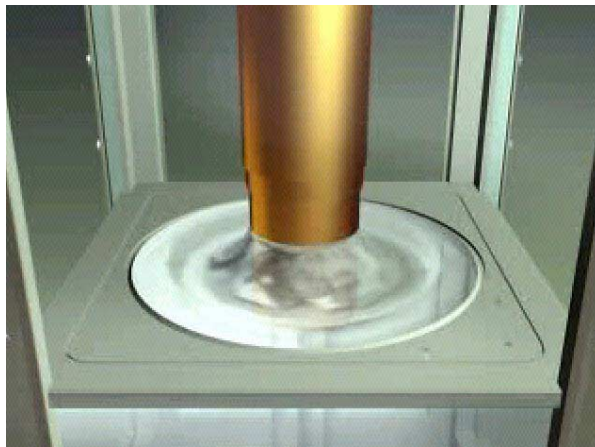



# Physical Sciences Research POP 2003 Fluid Physics Program



Glenn Research Center

## FCF Flight Segment

## Fluids and Combustion Facility



**Combustion  
Integrated  
Rack (CIR)  
ULF-2**

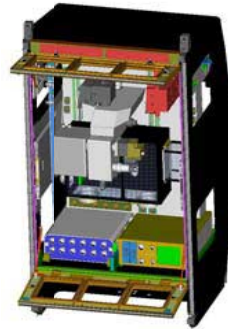

**Fluids  
Integrated  
Rack (FIR)  
UF-3**

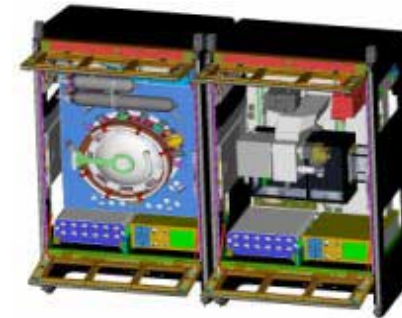

**Combustion  
Science  
Rack**

↔ data ↔

**Fluids  
Physics  
Rack**

CIR and FIR will operate independently, however the capability has been scarred to connect to available diagnostics and mass storage devices from the other rack. This capability will enable the Fluid Physics and Combustion Science disciplines to share mutually necessary hardware/software.

FCF will be able to accommodate experiments at the rate of 10 or more per year for the lifetime of the Facility.

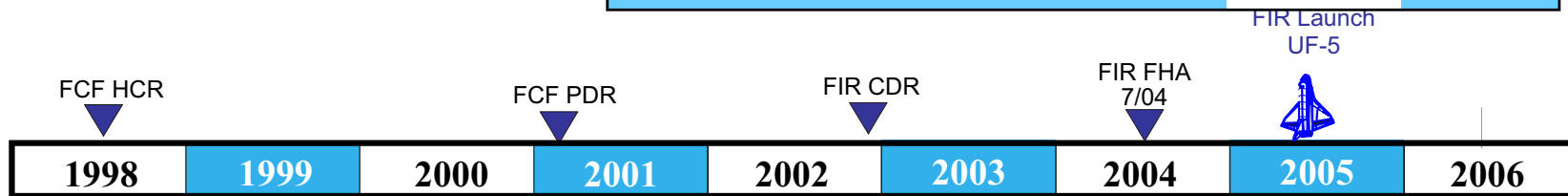

HRI - Motil





# Physical Sciences Research POP 2003 Fluid Physics Program



Glenn Research Center

*FCF Fluid Integrated Rack  
with Multi-User PI Hardware*

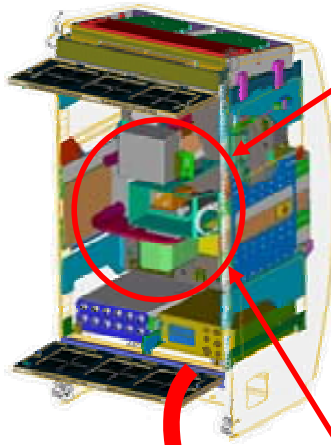

**ISS US Lab Module**

*Multi-User PI Inserts*

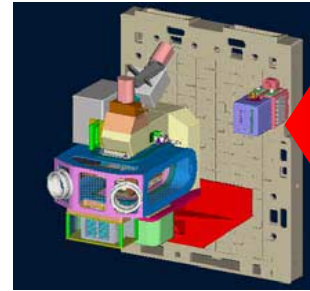

**Light Microscopy Module**

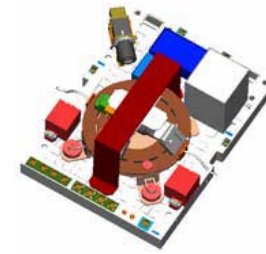

**Granular Flow Module**

*PI Specific Insert*



**Microgravity Observations  
of Bubble Interactions (MOBI)**

*Light Microscopy  
Experiments*

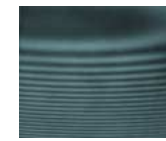

**CVB**

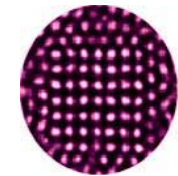

**PHaSE-2**

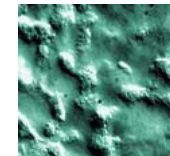

**PCS-2**

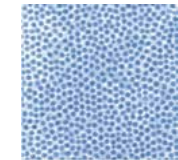

**LΦ CA**

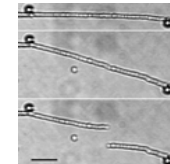

**LMM-5 / GAST**



**LMM-6 / Clark**



**Muscle tissue  
fiber strands**





## Physical Sciences Research POP 2003 Fluid Physics Program



Glenn Research Center

### FIR/Payload Integrated Configuration

The FCF FIR includes support subsystems and laboratory style diagnostics common to the specific researchers and supplements the laboratory with unique science hardware developed for each Principal Investigator (PI).

PI-specific and multi-user hardware customizes the FIR in a unique laboratory configuration to perform fluids research effectively.

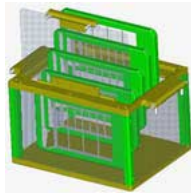

#### PI Specific Hardware (Fluids or other discipline)

- PI Sample Cell with universal Sample Tray
- Specific Diagnostics
- Specific Imaging
- Fluid Containment

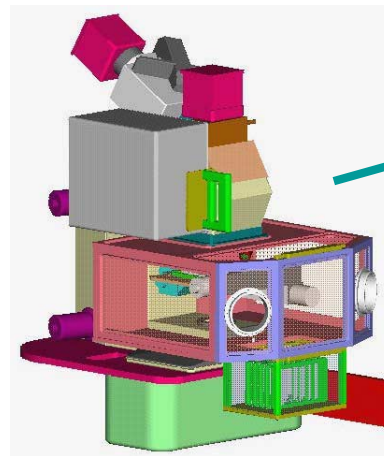

#### Multi-Use Payload Apparatus

- Test Specific Module
- Infrastructure that uniquely meets the needs of PI fluid physics experiments
- Unique Diagnostics
- Specialized Imaging
- Fluid Containment

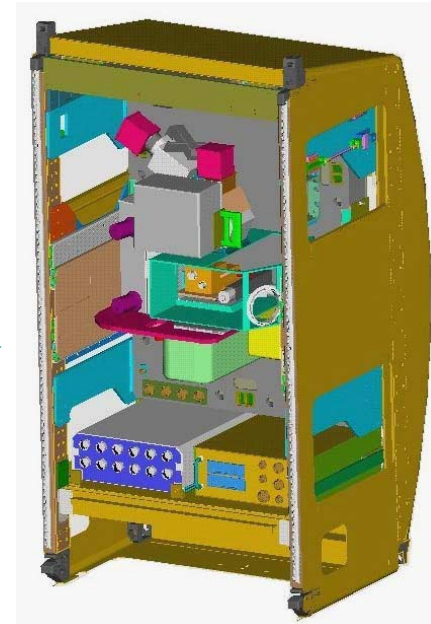

#### FCF Fluids Integrated Rack

- Power Supply
- Avionics/Control
- Common Illumination
- PI Integration Optics Bench
- Imaging and Frame Capture
- Fluid Diagnostics
- Environmental Control
- Data Processing
- Light Containment



# Physical Sciences Research POP 2003 Fluid Physics Program



Glenn Research Center

- Volume ~ 0.49 m<sup>3</sup> (1100mm x 895mm x 495mm)
- Power
  - 672 W at 28Vdc
  - 1450 W at 120Vdc
- Thermal Cooling
  - 3 kW water (MTL)
  - 500 W air (provided at 20°C to 30°C)

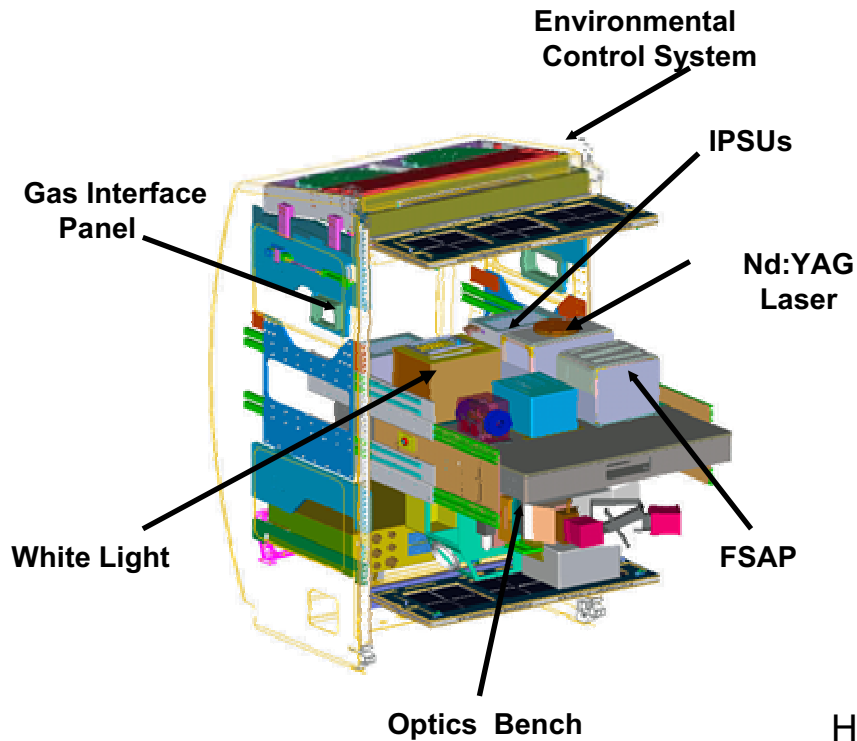
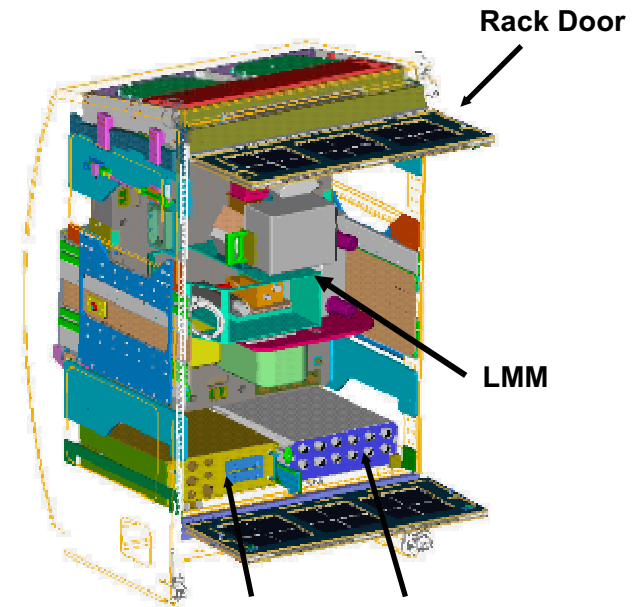

- Video
  - Analog Color Camera
  - C-IPSU - IEEE 1394 FireWire & Analog Frame Grabber Interfaces for PI provided cameras
  - C-IPSU - Image processing & storage units for real time and post processing of image data
  - Illumination
- Control & Data Acquisition
  - FSAP - Standard control and data acquisition interfaces (e.g. analog & digital I/O's, motion control, RS-422)
  - MDSU & IOP - 1.3 TB of Data Storage

HRI - Motil



## Physical Sciences Research POP 2003 Fluid Physics Program



Glenn Research Center

### •C-Image Processing and Storage Unit (C-IPSU)

#### •Function

- Stores digital image data received from a camera
- Perform automated real-time image analysis, processing and reduction
- Provide control signals to camera diagnostic control modules and to illumination packages

#### •Features

- IEEE 1394, FireWire Interface for camera control and image acquisition
- Analog video, RS-170A, input
- Analog video output from scan converter that converts digitally acquired data to an RS-170A signal
- Sync bus for synchronizing illumination sources and cameras
- Two 36 GB hard drives

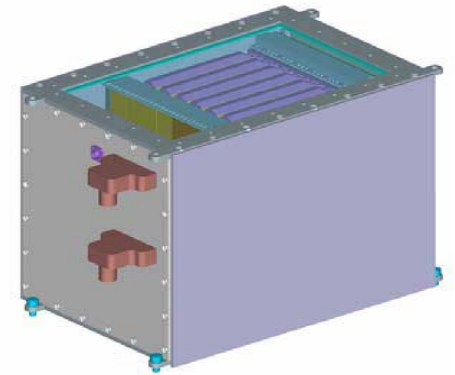

### •Fluids Science Avionics Package (FSAP)

#### •Function

- Serves as the control and data acquisition system for the payload.

#### •Features

- RS-422, 2 channels
- Analog and discrete inputs and outputs (A/D, D/A, DIO)
- Motion control, 4 channels
- Analog video frame grabber
- CAN bus control of diagnostics and PI H/W
- Hard drive storage, 72 GB

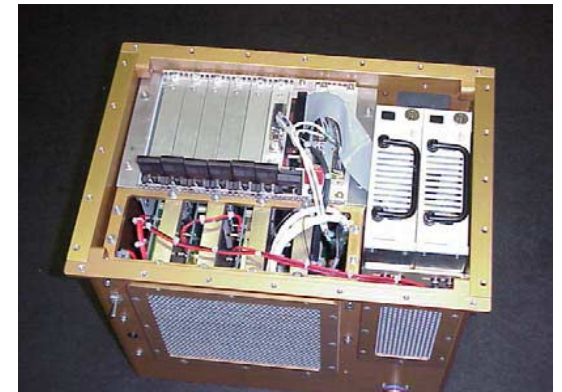

HRI - Motil

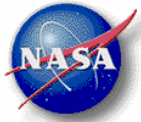

## Physical Sciences Research POP 2003 Fluid Physics Program



Glenn Research Center

### •Nd:YAG Laser

#### •Function

- Provides a laser source for various diagnostic techniques such as Particle Induced Velocimetry (PIV).

#### •Features

- 532 nm, 150mw Output power
- Analog control of laser functions
  - Laser pump On/Off
  - Diode drive current (electrical attenuation)
  - Attenuator stepper motor (mechanical attenuation)
- Bench mounted rear, fiber coupled to front of bench
- Laser output power monitoring
- Controlled by FSAP

### •White Light Package

#### •Function

- Provides uniform, broad band lighting

#### •Features

- Two independent light engines
- Easy replacement of light engine
- Adjustable intensity
- Fiber Optic Quick disconnects
- Mounted to rear of bench, quick connect/disconnect of fiber bundles
- Controlled by the FSAP

Fiber Optic Cable Spool

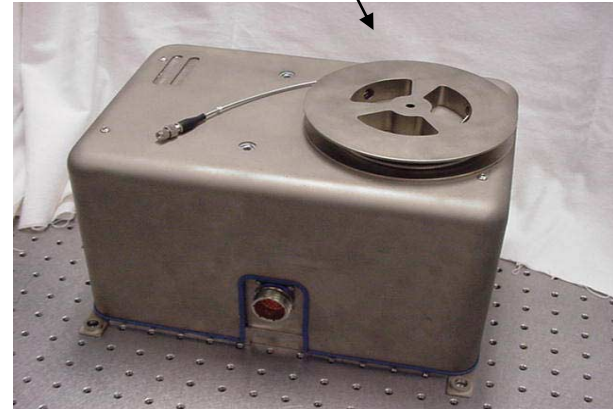



## Physical Sciences Research POP 2003 Fluid Physics Program



Glenn Research Center

### -Initial Capability

- Color Camera
  - 24 Bit, 3 chip CCD
  - 1/3 inch array, 768 X 494 pixel
  - RS 170C output (30 FPS)
  - Remote and interchangeable head allowing for in-situ calibration with controller



### •Planned Facility Upgrade

- High Resolution Camera
  - SMD camera
  - 1k X 1k, 144 mPixels
  - 15 – 30 – 60 FPS
  - 12 Bit gray scale
- High Frame-rate Camera
  - 512 X 512 array
  - Firewire, IEEE 1394
  - CMOS imager, 1000 fps @ 512 X 512 for a minimum of 4 seconds
  - Capable of 32,000 fps @ 32 x 32

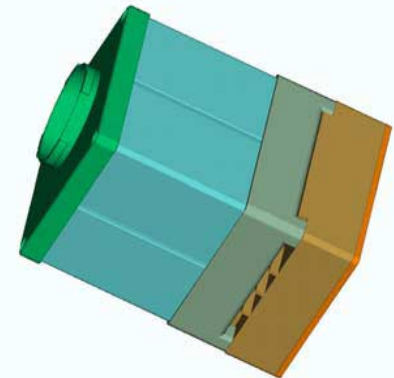



# Physical Sciences Research POP 2003 Fluid Physics Program



Glenn Research Center

## Microgravity Science Glovebox (MSG)

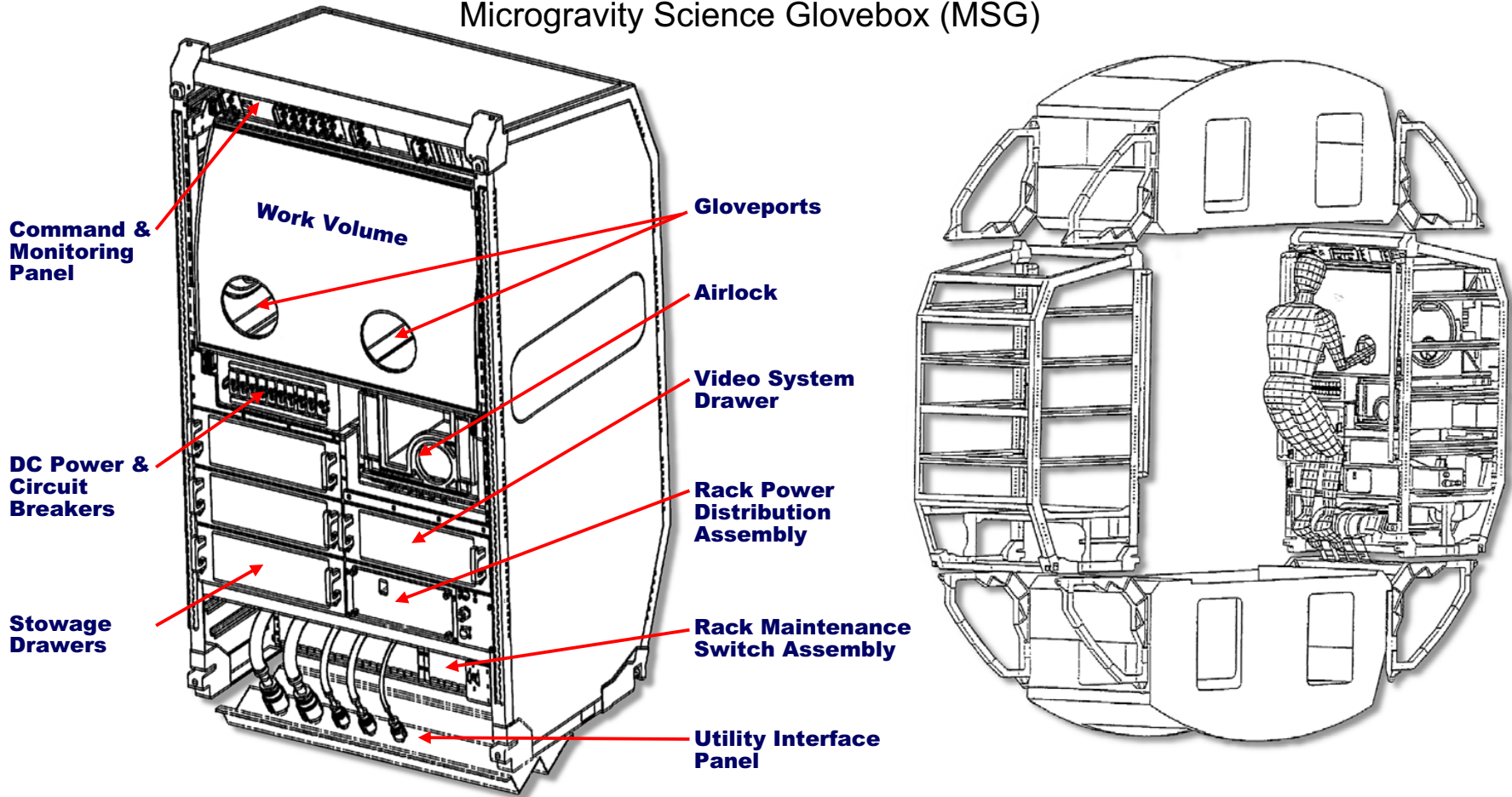

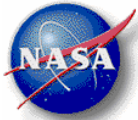

**Physical Sciences Research POP 2003**  
**Fluid Physics Program**



Glenn Research Center

**Microgravity Science Glovebox (MSG)**

<b>Work Volume</b>	255 liters, ~906 mm wide, ~637 mm high, ~500 mm deep (at the floor)
<b>Maximum size of single piece of equipment in WV</b>	406 mm diameter, 406 mm high (through side ports) 254x343x299 mm (through airlock)
<b>Power available to investigation</b>	+28V at useable 7 Amps +12V at useable 2 Amps -12V at useable 2 Amps (not independent of +12V) + 5V at useable 4 Amps 120V at useable 8.3 Amps (Maximum total power draw from all outlets is 1000W)
<b>Maximum heat dissipation</b>	1000W (800 from coldplate, 200 from air circ)
<b>General illumination</b>	1000 lux @ 200 above the WV floor
<b>Video</b>	Color and B&W cameras, dedicated recorders
<b>Data handling</b>	RS422 between investigations in WV and MSG Laptop Two MIL1553B connections between MSG and Facility Laptop (one inside, one outside WV) 8 differential analog and 8 discrete signals in WV 2 Ethernet connections inside WV
<b>Filtration</b>	HEPA/charcoal/catalyst - replaceable on orbit
<b>Other resources available</b>	Nitrogen Vacuum HRI - Motil

