

# Evaluation of Double-Vacuum-Bag Process For Composite Fabrication

T. H. Hou and B. J. Jensen

NASA Langley Research Center, Hampton, Virginia 23681

## **Abstract**

A non-autoclave vacuum bag process using atmospheric pressure alone that eliminates the need for external pressure normally supplied by an autoclave or a press is an attractive method for composite fabrication. This type of process does not require large capital expenditures for tooling and processing equipment. In the molding cycle (temperature/pressure profile) for a given composite system, the vacuum application point has to be carefully selected to achieve the final consolidated laminate net shape and resin content without excessive resin squeeze-out. The traditional single-vacuum-bag (SVB) process is best suited for molding epoxy matrix based composites because of their superior flow and the absence of reaction by-products or other volatiles. Other classes of materials, such as polyimides and phenolics, generate water during cure. In addition, these materials are commonly synthesized as oligomers using solvents to facilitate processability. Volatiles (solvents and reaction by-products) management therefore becomes a critical issue. SVB molding, without additional pressure, normally fails to yield void-free quality composites for these classes of resin systems. A double-vacuum-bag (DVB) process for volatile management was envisioned, designed and built at the NASA Langley Research Center. This experimental DVB process affords superior volatiles management compared to the traditional SVB process. Void-free composites are consistently fabricated as measured by C-scan and optical photomicroscopy for high performance polyimide and phenolic resins.

## **1. Introduction**

A cure cycle (temperature and pressure profile) for manufacturing composite laminates with a reactive resin matrix such as a poly(amide acid)/*N*-methylpyrrolidinone (NMP) resin system or a solvent containing prepreg usually consists of a two-step ramp-and-hold temperature profile as shown in Figure 1. Temperature and hold duration in each step are unique for a given composite system. The low temperature ramp-and-hold step is called the B-stage. During the B-stage, prepregs are heated

and reaction by-products such as water from the resin's chemical reactions are generated. Volatiles (i.e., solvent and reaction by-products) are free to escape because of the absence of pressure in this period. The resultant residual volatile content and residual fluidity of the matrix resin remaining inside the composite are determined by the B-stage conditions. After the B-stage period, a second temperature ramp-and-hold is followed. Pressure is applied during this high temperature ramp-and-hold period to afford laminate consolidation and to attain desired physical properties of the resin matrix and good mechanical properties for the composite. Once the consolidation pressure is applied, residual volatiles, if any, are locked in and unable to escape. In order to produce a void-free high quality laminate, the residual volatile content and processability of the resin matrix must be carefully controlled by a workable cure cycle, which is designed specifically for a given composite system.

## Cure Cycle Parameters

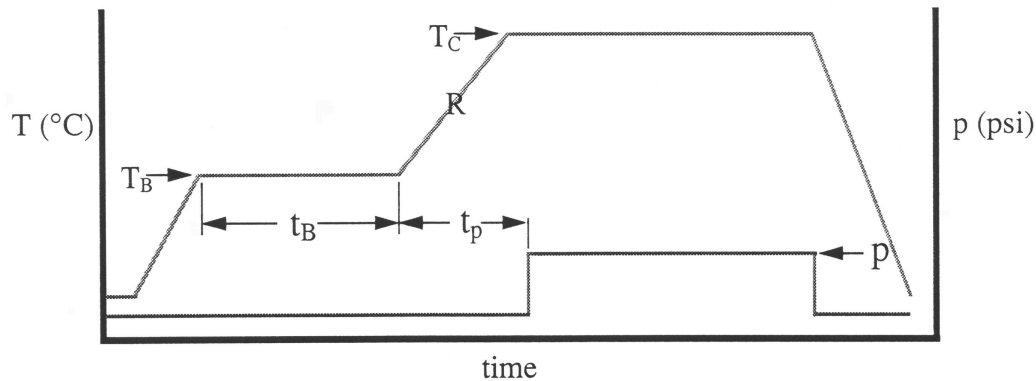

$t_B$  = B-stage time

$t_p$  = Time to pressure application

$p$  = pressure

$T_B$  = B-stage temperature

$T_C$  = Final cure temperature

$R$  = Heating rate from  $T_B$  to  $T_C$

Figure 1. Schematic drawing of a two-step cure cycle profile.

An autoclave is traditionally used in the fabrication of composite materials. It offers enhanced processing flexibility compared to other common processing equipment such as an oven or press. However, composite fabrication by autoclave is very costly in terms of capital investment, and limits the size of the parts that can be produced. To address this issue, recent NASA programs, such as the Next Generation Launch Vehicle (NGLV) program, have emphasized the development of out-of-autoclave processing techniques for high temperature resistant composites. Single-vacuum-bag (SVB) processing in an oven is an attractive alternative. SVB processing in an oven utilizes atmospheric

pressure created by the vacuum bag alone, and is cost effective for composite fabrication. In general, the SVB process is best suited for molding epoxy matrix based composites because of the absence of reaction by-products or other volatiles. However, the superior fluidity (low viscosity) of epoxy matrix may cause an excessive resin flash, which results in dry fibers and extensive void networks in the laminate [1]. Furthermore, SVB processing is often ineffective in composite molding when a reactive resin matrix with volatile by-products or solvent containing prepreg is present. The SVB assembly inherently hinders and/or retards the volatiles depletion mechanisms during fabrication because a compaction force (i.e., atmospheric pressure) is created and exerted onto the laminate during the volatile depleting B-stage period.

In the past two decades, a double vacuum bag procedure was devised at the Naval Air Warfare Center, Warminster, PA to replace SVB for aircraft composite repair applications [2-8]. The double vacuum assembly consists of a rigid enclosure over a flexible vacuum bag. Prepreg plies are exposed to a vacuum but do not experience a consolidation force. When bonding the wet lay-up repair patch of epoxy matrix, the double vacuum procedure eliminates problems of excessive flash during the B-stage period [4-8]. Very limited studies and conflicting results were noted in the applications of high temperature bismaleimide based wet lay-up repair patches. The double vacuum procedure resulted in a lower interlaminar shear strength when compared to the SVB process, presumably due to the poor wetting out of the fibers and high void content [1].

## **2. DVB Assembly and Processing Concept**

A schematic drawing to illustrate the concept of a traditional SVB in composite manufacturing is shown in Figure 2. Fiber reinforced reactive resin matrix prepregs (composite) are laid up between the caul and tool steel plates. The composite is then enclosed by a vacuum bag, which is sealed around the edges onto the tool plate. A vacuum port is built on the tool plate inside the bag. This assembly is typically installed in a forced air circulation oven and subjected to a cure cycle for composite molding.

Prior to the application of vacuum, the bag rests at an equilibrium balanced by the same atmospheric pressure (i.e., 14.7 Psi) from either side of the bag as shown in Figure 2(a). Under this circumstance, the composite is not subjected to any external compaction forces and remains bulky and loose. During the B-stage, the resin softens and becomes molten at elevated temperatures. Reaction by-products may be generated or volatile solvent is released and chemo-viscosity builds-up. In order to fully deplete the volatiles at lower temperatures, vacuum is pulled on the composite. However, because of the pressure differential, the vacuum causes the bag to collapse tightly onto the caul plate and compact the composite. At the same time, there is a thickness reduction due to softening of the resin

matrix and atmospheric pressure created by the vacuum as shown in Figure 2(b). Both the compressed fibrous architecture and increasingly viscous resin matrix inside the prepreg plies create narrower passages for volatiles to escape. In order to remedy this problem, in practice a prolonged B-stage

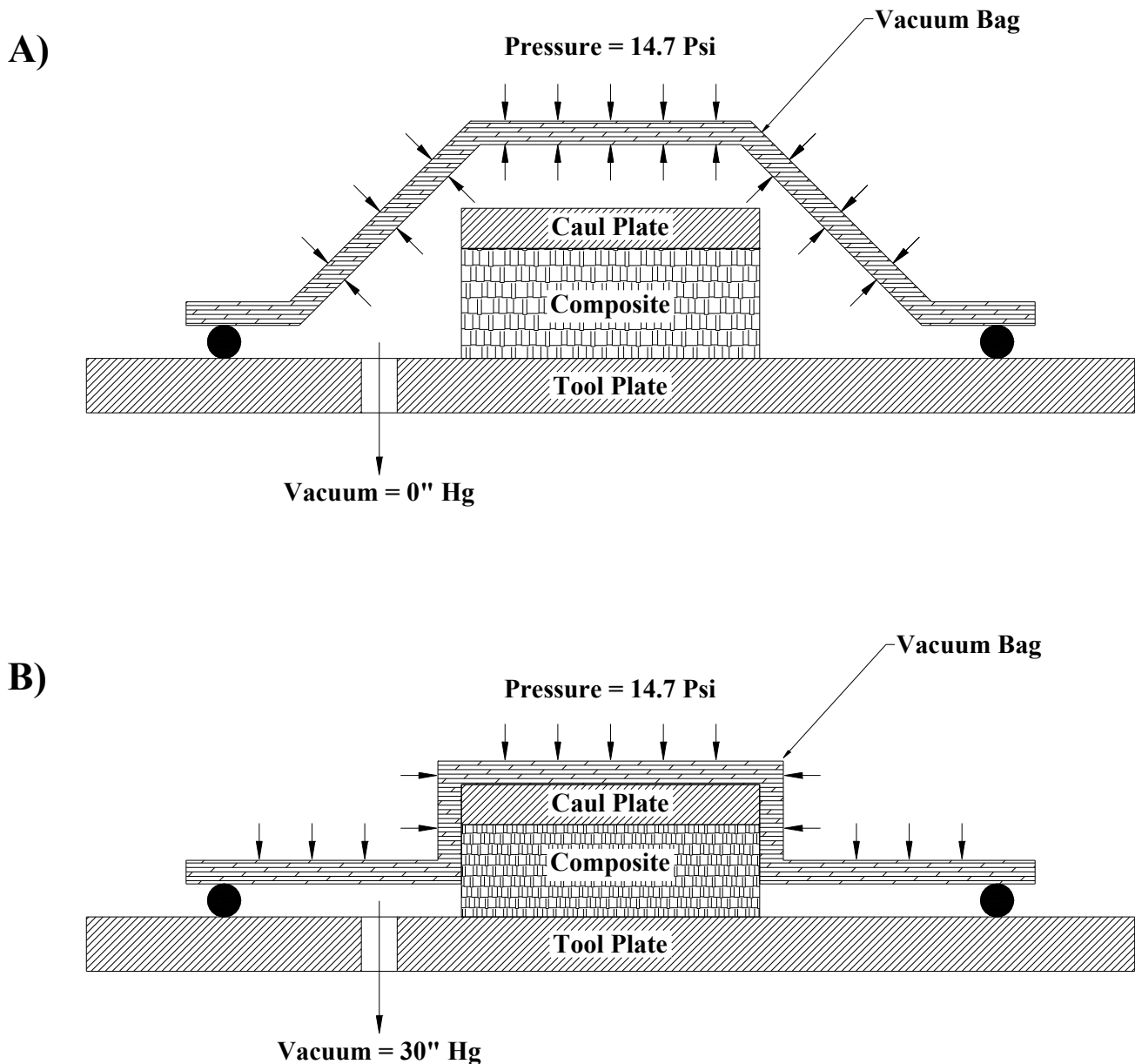

Figure 2. Oven SVB composite molding concept.

duration is often employed necessarily to achieve low residual volatile levels. However, this is not always successful due to resulting poor residual matrix fluidity rendering the composite un-processable.

The SVB assembly and process, without the application of external pressure, are simply not flexible enough for high performance composite fabrication.

A schematic drawing illustrating the concept of the DVB molding assembly for volatile management and composite manufacturing is shown in Figure 3. Fiber reinforced reactive resin matrix preregs are laid up between the caul and the tool steel plates. They are then enclosed by a vacuum bag (designated as Inner Bag), which is sealed around the edges onto the tool plate. A vacuum port is built on the tool plate inside the Inner Bag and connected to a vacuum pump as with the SVB process. A second vacuum bag (designated as Outer Bag) is then assembled in the same fashion, with a vacuum port built on the tool plate, which is located between the Inner and Outer Bags and connected to a separate vacuum pump. Before assembling the Outer Bag, a perforated tool is first installed outside the perimeter of the Inner Bag. This tool has to be stiff enough to withstand the 14.7 Psi atmospheric pressure created by the vacuum. For the high temperature (371°C curing) resin systems, a Kapton<sup>®</sup> film of 0.002” to 0.003” in thickness is used as bagging material. This DVB assembly is then placed in a heating chamber and subjected to the proper cure cycle for composite manufacturing.

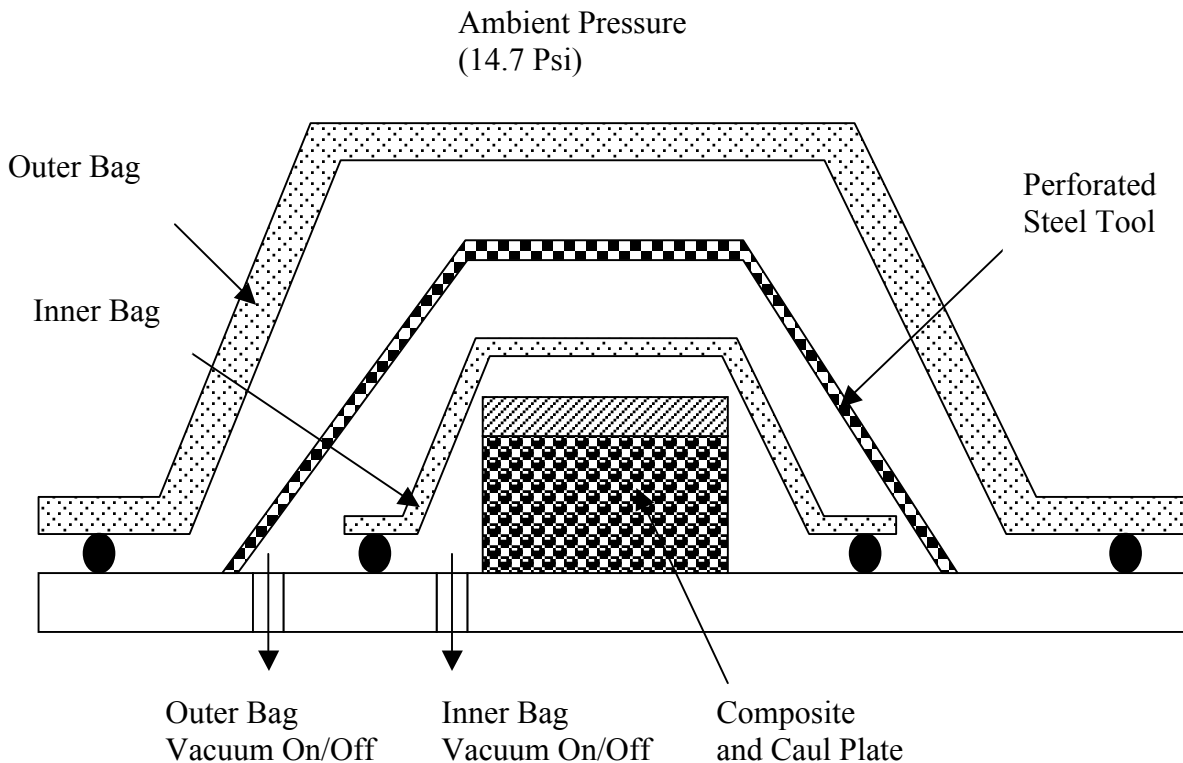

Figure 3. Schematic DVB assembly.

During the B-stage (i.e., the low temperature ramp-and-hold period), full vacuum (30” Hg) is applied to the Outer Bag, while a slightly lower vacuum level (i.e., 28” Hg) is set in the Inner Bag. The

Outer Bag is collapsed onto the stiff perforated tool due to the atmospheric pressure outside the bags. Because of the vacuum differential between the two bags, the Inner Bag is “ballooned” and presses against the perforated stiff tool leaving no compaction force, while still producing vacuum, on the composite. In the DVB arrangement, the composite lay-up assembly is not compacted by the atmospheric pressure via the Inner Bag, and remains loose. Volatiles are free to escape by the vacuum suction from the Inner Bag vacuum pump during the B-stage.

At the end of the B-stage, the Outer Bag is purged to atmosphere, while the Inner Bag vacuum is increased to 30” Hg. The Outer Bag becomes loose from the tool, and the Inner Bag collapses onto the caul plate with one atmospheric pressure. This pressure helps to consolidate the laminate during the high temperature ramp-and-hold period of the cure cycle.

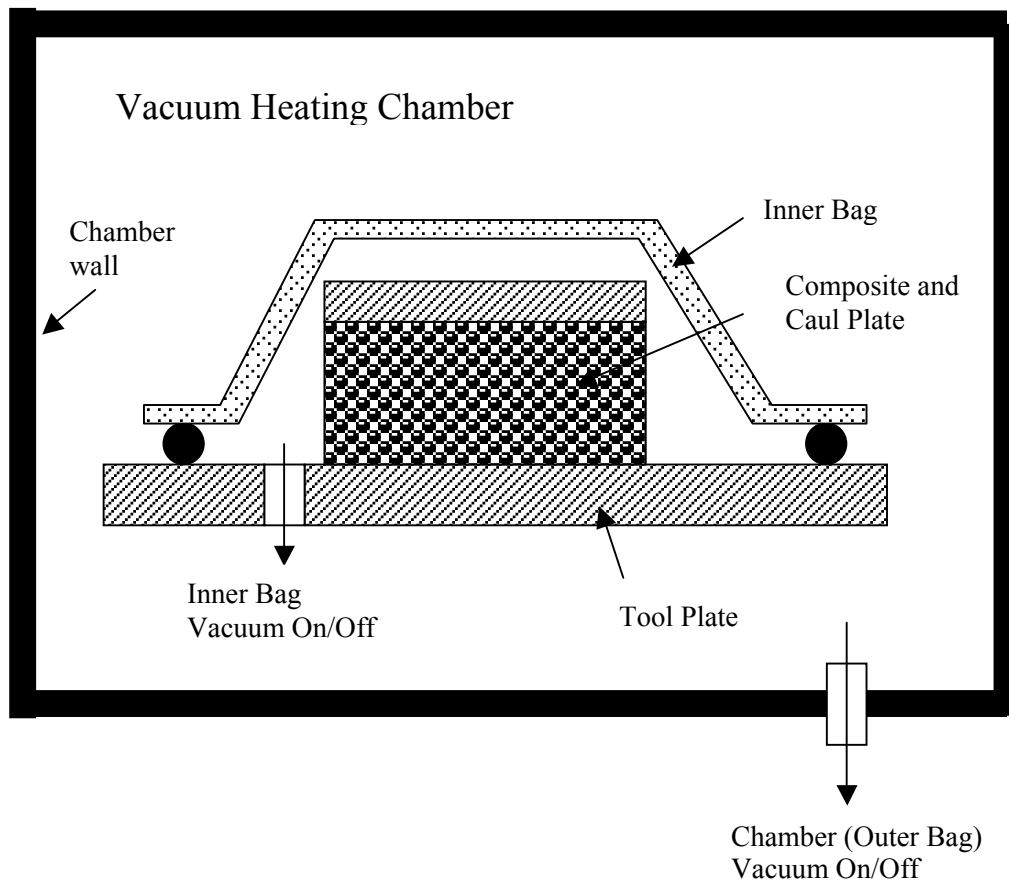

Figure 4. Oven DVB concept applied to a vacuum heating chamber.

The DVB process can be very flexible. For example, applying a partial vacuum (i.e., 25” Hg) to the Outer Bag, while pulling a full vacuum (i.e., 30” Hg) in the Inner Bag during the composite B-stage is also possible. In this case, The Outer Bag is collapsed onto the stiff perforated tool with a pressure

(less than one atmospheric pressure as created by the 25" Hg vacuum). Because of the vacuum differential between the two bags, the Inner Bag is collapsed, instead of "ballooned", and presses against the composite with a small compaction pressure (created by the vacuum differential of 5" Hg between the two bags), while still producing a 30" Hg full vacuum to assist volatile removal. Under this circumstance, the volatile depletion rate may not be hindered by the slightly compacted fibrous architecture, while the potential for Inner Bag leakage is greatly reduced.

The concepts of DVB assembly and processing described above can be easily implemented in any vacuum heating chamber such as a vacuum oven, vacuum press or autoclave as shown schematically in Figure 4. In these cases, one only needs to assemble the Inner Bag for the composite. The chamber wall serves as the Outer Bag, and the stiff perforated tool between the Bags is no longer needed. Separate vacuum ports are built for the Inner Bag and the heating chamber, respectively. For molding composites with poor matrix resin fluidity (i.e., high viscosity) at elevated temperatures, extra pressure can also be applied safely to facilitate composite consolidation after B-stage through platens (in a vacuum press) or pressurized gases (in an autoclave).

In fact, with proper tooling designs, the DVB concept for volatile management can be adapted to any composite manufacturing process, including resin transfer molding (RTM), vacuum assisted resin transfer molding (VARTM), solvent assisted resin transfer molding (SARTM) and resin film infusion (RFI) processes, in which the proper removal of volatiles is an issue. These concepts are presently being pursued at the NASA Langley Research Center.

### 3. Materials

Two fiber reinforced polymeric resin composite systems were investigated. The first, LARC□ PETI-8 (Langley Research Center Phenylethynyl Terminated Imidate-8) aromatic polyimide, is based on 3,3', 4,4'-biphenyltetracarboxylic dianhydride, a 50:50 molar ratio of 3,4'-oxydianiline and 1,3-bis(3-aminophenoxy)benzene, with 4-phenylethynylphthalic anhydride as the endcapping agent at a theoretical number average molecular weight of ~ 2,500 g/mole. Unidirectional prepregs with ~ 14% volatiles were made by coating an NMP solution of the LARC□ PETI-8 amide acid oligomers onto unsized IM7 carbon fibers. When cured at elevated temperatures, imidization reactions occur which release water as reaction by-product.

The second system, commercial 7781 E-glass/Cycom 6070 prepreg (8 harness satin fabric), was received from Cytec Engineering Materials (Anaheim, CA). This prepreg contains 3-5% volatiles. Cycom□ 6070 is a 138°C to 160°C (280°F to 320°F) curing phenolic resin. It has a service temperature up to 260°C (500°F) when stepwise post-cured up to 232°C (450°F). Cycom□ 6070 is a novolac and

releases water as a reaction by-product when curing. For both materials, volatiles (water and solvent) management is a critical issue to yield high quality, void-free laminates during composite fabrication.

#### 4. Results and Discussion

The processability of composites with reactive resin matrices involves a balance between the degree of volatile depletion and the residual fluidity remaining in the polymer [9-11]. When volatiles are not depleted adequately before the forced consolidation, voids develop yielding a laminate with inferior quality. On the other hand, excessive cure advancement in the resin results when excessive B-stage conditions (temperature and time) are employed, making the composite un-processable under moderate pressures, due to high resin viscosity. The kinetics of volatile diffusion through the liquid phase is strongly dependent upon resin chemistry, chemoviscosity, temperature and duration at the given temperature. While the reactive resin matrix continues to cure during the B-stage period, the resin fluidity continues to diminish and the composite processability suffers. In order to achieve a void-free laminate, the cure (molding) cycle must enable a sufficient extent of volatiles to be depleted through the thermal B-stage (in the absence of pressure) before consolidation. In the meantime, an appreciable degree of residual resin fluidity must remain after the B-stage allowing infiltration of resin through fiber bundles in the composite during the pressure consolidation stage initiated at the latter stage of the cycle. Such a balancing act between degree of residual volatiles and residual fluidity during composite fabrication is complex and makes the design of cure cycles very challenging.

The DVB assembly and process described above have overcome the deficiencies of the SVB by affording superb and effective volatile management during the composite B-stage period. Examples of comparisons in quality between SVB and DVB molded composite laminates are described below. In these examples, the interior of a vacuum press serves as the Outer Bag in the DVB process as previously described in Section 2.

##### 4.1 IM7/LARC<sup>®</sup> PETI-8 polyimide composite system

LARC<sup>™</sup> PETI-8 is a phenylethynyl terminated imide composite matrix material. The phenylethynyl groups on the ends of the linear polyimide react with each other upon heating to temperatures greater than  $\sim 300^{\circ}\text{C}$  ( $\sim 575^{\circ}\text{F}$ ). This resin exhibits a low viscosity, which is stable over a long period of time at temperatures between  $200^{\circ}$  to  $275^{\circ}\text{C}$ , rendering itself seemingly suitable for composite fabrication by an oven, vacuum bag processing technique. While this reaction produces no volatiles, the ring closure of the amide acid to imide, which occurs at temperatures greater than  $\sim 200^{\circ}\text{C}$



(~400°F), produces water as a by-product. Furthermore, the LARC™ PETI-8 prepreg contains volatile NMP solvent (~14% by weight) that is left during the preprepping process for handlability. For the composite process to be successful in producing a quality, void free part, it must adequately manage the water from imidization and the residual solvent left over from the preprepping process.

An identical temperature profile was used for composites molded by either the SVB or DVB process: an initial 250°C/1 hr B-stage ramp-and-hold from RT at ~3°C/min, followed by a second ramp-and-hold at the same rate to 371°C/1 hr final curing. The laminate lay-up scheme is 3" x 3" - [0]<sub>8</sub>. Vacuum pressure (i.e., 14.7 Psi created by the 30" Hg vacuum) was applied throughout the cure cycle for the SVB process. In the DVB process, full vacuum (30" Hg) is applied to the Outer Bag, while a slightly lower vacuum level (i.e., 28" Hg) is set in the Inner Bag during the B-stage period. At the end of the 250°C/1 hr B-stage, the Outer Bag was purged to atmosphere and the Inner Bag vacuum was increased to 30" Hg. The atmospheric pressure created by the Inner Bag vacuum helped to consolidate the volatile-free composite during the 371°C/1 hr ramp-and-hold period.

**(a) SVB molded laminate (100X)**

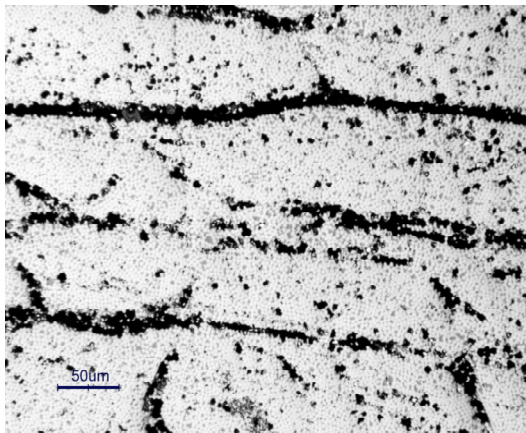

**(b) DVB molded laminate (100X)**

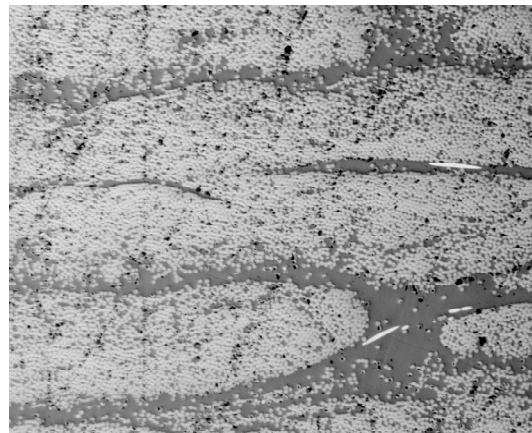

Figure 5. Optical photomicrographs of SVB and DVB molded IM7/LaRC□ PETI-8 Composite.

The cross section photomicrographs of the resultant laminates are shown in Figure 5. Excessive resin squeeze-out and high void content were observed for the SVB molded laminate. The domains between plies that are typically resin-rich, are particularly high in void content when compared to those domains within the fiber bundles (Figure 5(a)). Apparently, the oven SVB processing is ineffective and creates problems not only in maintaining the targeted resin content, but also in avoiding volatile entrapments in the final consolidated laminate parts. Much less resin flash was observed in laminates

molded by the DVB process. A photomicrograph of the resultant laminate in Figure 5(b) shows a superior void-free laminate than that fabricated by the SVB process.

When the prepreg was laid-up at RT, the composite was filled with air, especially between the prepreg plies. In the SVB process, as vacuum was pulled at RT, and while the temperature was ramped to the B-stage condition, atmospheric pressure created by the vacuum compacted the composite because of the softening of matrix resin. The compacted fibrous architecture retarded the volatile depletion rates and a significant amount of “air-filled pockets” surrounded by the molten resin were formed. These pockets were concentrated between prepreg plies. Similarly additional “volatile-filled pockets” were formed inside the fiber bundles that were matrix resin impregnated. The formation of these two types of pockets in the SVB process led to the voided network pattern observed in Figure 5(a). On the other hand, in the DVB process, there was no atmospheric pressure created by the Inner Bag vacuum, and the composite (even though under vacuum) was not compacted during the B-stage allowing passageways for the air and volatiles to escape. “Vacuum pockets” surrounded by the molten resin matrix were formed in this case both inside the fiber bundles and between the prepreg plies. These “vacuum pockets” were then easily filled by the flow of low viscosity resin at elevated temperatures when atmospheric pressure was applied, resulting to a void-free consolidation as seen in Figure 5(b).

The enhanced capability of volatile management offered by the DVB process is due to the following two attributes: 1) vacuum suction in the Inner Bag lowers the vapor pressure (and the boiling point) of the volatiles, resulting in an acceleration of the depletion rates at lower temperatures (which helps to maintain processability of the resin matrix after B-stage); and 2) the absence of compaction force during volatiles depletion period (i.e., the B-stage) relieves physical constraints of the volatiles passageways resulting in a further enhancement of volatiles depletion rates.

#### 4.2 CYTEC 7781 E-glass/Cycom<sup>®</sup> 6070 phenolic composite system

An identical temperature profile was used for this composite molded by either the SVB or DVB process: a single ramp from RT to 138°C (280°F) at ~ 3°C/min (5°F/min) with a 1 hr hold, followed by a cool down to RT. The laminate lay-up scheme is 6” x 6” - [0]<sub>8</sub>. Atmospheric pressure created by the vacuum was applied throughout the cure cycle for the SVB process. In the DVB process, a full vacuum (30” Hg) is applied to the Outer Bag, while a slightly lower vacuum level (i.e., 28” Hg) is set in the Inner Bag during the temperature ramp from RT. When the temperature reached 105°C (220°F), the Outer Bag was purged to atmosphere and the Inner Bag vacuum was increased to 30” Hg. The atmospheric pressure created by the Inner Bag vacuum helped to consolidate the composite during the remaining ramp-and-hold period.

The cross section photomicrographs of the resultant laminates are shown in Figure 6. High void contents were observed for the SVB molded laminate (Figure 6(a)). The resin-rich domains between fiber tows are particularly high in void content when compared to those domains within the tows. Apparently, the oven single-vacuum-bag process is again ineffective and creates problems in avoiding volatile entrapments in the final consolidated laminate parts. Photomicrograph of the resultant laminate fabricated by the DVB process in Figure 6(b) shows a greatly improved quality part. These results are preliminary so optimized processing conditions are expected to improve part quality further.

Mechanical properties of both composite systems will be reported in future publications.

**(a) SVB molded laminate (20X)**

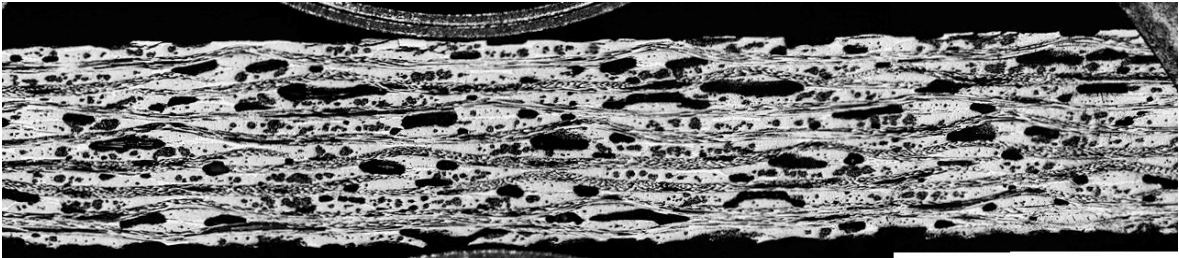

**(b) DVB molded laminate (20X)**

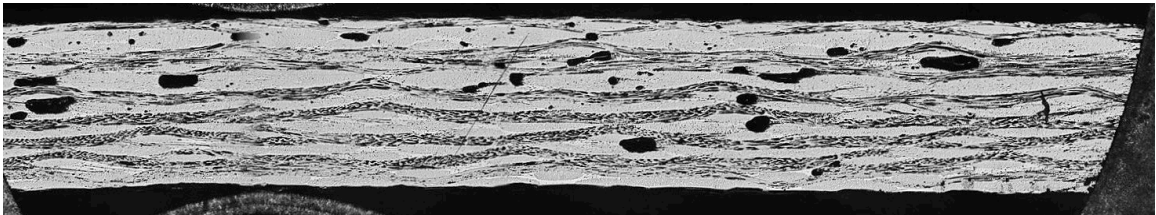

Figure 6. Optical photomicrographs of SVB and DVB molded 7781 E-glass/Cycom<sup>®</sup> 6070 phenolic composites.

## 5. Conclusions

Volatile management is a common and critical issue in the manufacturing of many high performance/temperature resistant resin matrix composites. Many classes of industrially important

engineering resin systems, such as polyimides and phenolics, generate reaction by-products (i.e., water) during curing. These by-products, together with the carrier solvents, must be effectively managed during the cure cycle in order to yield void-free quality laminate parts.

A workable, robust, effective and low cost out-of-autoclave DVB processing technique for the management of volatiles is proposed. This technique affords superior volatile management during composite manufacturing. The problems associated with oven SVB processing are essentially eliminated. High quality, low void composite laminates can be produced consistently as evidenced by the optical photomicrographs.

This DVB process for volatile management can be easily adapted to a variety of composite manufacturing processes. For resin matrices with low to moderate minimal viscosities (i.e., < 250 Poises), a vacuum-only DVB process in an oven is sufficient for void-free laminate consolidation. For resin matrices with viscosities higher than ~ 250 Poises, an autoclave or a press incorporated with the DVB process will afford additional pressure (i.e., greater than 14.7 Psi) for composite part consolidation.

The DVB process proposed herein has a broad application in composite manufacturing. It is not only adaptable to manufacturing equipment such as ovens, autoclaves and presses, but also applicable to other important composite fabrication processes such as resin film infusion (RFI), resin transfer molding (RTM) and vacuum assisted resin transfer molding (VARTM) processes. These concepts are presently being pursued at the NASA Langley Research Center.

### **Acknowledgement**

The 7781 E-glass/Cycom<sup>®</sup> 6070 prepreg provided by J. M. Bai of Cytec Engineering Materials, Anaheim, CA and the IM7/LARC<sup>®</sup> PETI-8 prepreg fabricated by R. J. Cano and R. E. Smith of NASA LARC, Hampton, VA have made the processing studies herein possible.

### **References**

1. P. A. Mehrkam and R. Cochran, "Wet Lay-up Materials for Repair of Bismaleimide Composites", 24<sup>th</sup> International SAMPE Technical Conference, T1006-T1016, October 20-22, 1992.
2. L. B. Buckley, R. E. Trabocco and E. L. Rosenzweig, "Non-autoclave Processing for Composite Material Repair", Naval Air Warfare Center, Warminster, PA, Report No. NADC-83084-60, 1983.
3. T. M. Donnellan, E. L. Rosenzweig and R. C. Cochran, Second DOD/NASA Composites Repair Technology Workshop, Vol. 2, 349-364, 1986.

4. T. M. Donnellan, E. L. Rosenzweig, R. C. Cochran and M. F. DiBerardino, Closed Proceedings of 33rd International SAMPE Symposium and Exhibition, Society of Advancement of Material and Process Engineering, Covina, CA, 1988.
5. M. F. DiBerardino, J. Dominguez and R. C. Cochran, "Bonded Field Repair Concepts Using Ambient Storable Materials", Closed Proceedings of 34<sup>th</sup> International SAMPE Symposium and Exhibition, Society of Advancement of Material and Process Engineering, Covina, CA, 75-86, 1989.
6. J. Dominguez, M. F. DiBerardino, T. D. Price and L. E. Radford, "Validation of Field Repair Concepts Using Ambient Storable Materials", Closed Proceedings of 22nd International SAMPE Technical Conference, Society of Advancement of Material and Process Engineering, Covina, CA, 31-41, 1990.
7. P. A. Mehrkam, M. F. DiBerardino, R. C. Cochran and I. S. Lim, "Low Temperature Cure Adhesive for Honeycomb and Composite Repair Applications", Proceedings of 6<sup>th</sup> International Symposium on Structural Adhesive Bonding, American Defense Preparedness Association, 192-200, May 4-7, 1992.
8. P. A. Mehrkam, R. Cochran and R. Trabocco, "Cocure of Wet Lat-up Patch and Toughened Adhesive for Composite Repair Applications", 25<sup>th</sup> International SAMPE Technical Conference, 212-221, October 26-28, 1993.
9. T. H. Hou, B. J. Jensen and P. M. Hergenrother, "Processing and Properties of IM7/PETI Composites", Journal of Composite Materials, 30, No. 1, 109-122, 1996.
10. T. H. Hou, E. J. Siochi, N. J. Johnston and T. L. St. Clair, "IM7/LARC□ -ITPI Polyimide Composites", Polymer, 35, No. 23, 4956-4969, 1994.
11. R. J. Cano, T. H. Hou, E. S. Weiser and T. L. St. Clair, "Polyimide Composites from Salt-Like Solution Precursors", High Perform. Polym., 13, 235-250, 2001.