

## Environmentally Compatible Vapor-Phase Corrosion Inhibitor for Space Shuttle Hardware

Howard L. Novak  
United Space Alliance (USA), LLC  
8550 Astronaut Blvd.  
Mail Stop: USK-864  
Cape Canaveral, FL 32920  
[novakh@usasrb.ksc.nasa.gov](mailto:novakh@usasrb.ksc.nasa.gov)  
321-867-7054

Phillip B. Hall  
NASA Marshall Space Flight Center  
Mail Stop: ED 32  
Marshall Space Flight Center, AL 35812  
[phillip.b.hall@msfc.nasa.gov](mailto:phillip.b.hall@msfc.nasa.gov)  
256-544-2525

### ABSTRACT

USA-SRB Element is responsible for the assembly and refurbishment of the non-motor components of the SRB as part of Space Shuttle. Thrust Vector Control (TVC) frames structurally support components of the TVC system located in the aft skirt of the SRB. TVC frames are exposed to the seacoast environment after refurbishment and, also, to seawater immersion after splashdown, and during tow-back to CCAFS-Hangar AF refurbishment facilities. During refurbishment operations it was found that numerous TVC frames were experiencing internal corrosion and coating failures, both from salt air and seawater intrusions. Inspectors using borescopes would visually examine the internal cavities of the complicated aluminum alloy welded tubular structure. It was very difficult for inspectors to examine cavity corners and tubing intersections and particularly, to determine the extent of the corrosion and coating anomalies. Physical access to TVC frame internal cavities for corrosion removal and coating repair was virtually impossible, and an improved method using a Liquid (water based) Vapor-phase Corrosion Inhibitor (LVCI) for preventing initiation of new corrosion, and mitigating and/or stopping existing corrosion growth was recommended in lieu of hazardous paint solvents and high VOC / solvent based corrosion inhibitors. In addition, the borescopic inspection method used to detect corrosion, and/or coating anomalies had severe limitations because of part geometry, and an improved non-destructive inspection (NDI) method using Neutron Radiography (N-Ray) was also recommended.

### INTRODUCTION

USA LLC is responsible for the assembly and refurbishment of the non-motor components of the SRB as part of the Space Shuttle system shown in Figures 1 and 2, and which is developed and managed by Marshall Space Flight Center (MSFC) in Huntsville, Alabama. Programs are underway to develop and evaluate environmentally acceptable LVCI's for use on aerospace flight hardware in order to eliminate and/or mitigate corrosion, and ultimately extend the useful service life of these unique and expensive hardware items. Figure 3 shows the location of both upper and lower TVC frames in the Aft Skirt of the SRB. SRB TVC frame material is made from 2219 Aluminum Alloy weldments that are final machined and painted internally and externally. Figures 4 and 5 show the internal cavities, Boss Port Plugs and general construction of Upper and Lower TVC Frames. Borescopic inspection has revealed corrosion in cavity surfaces of both Upper and Lower TVC Frames. Engineering requirements state that any visible corrosion is cause for rejection, and disallows the use of those discrepant frames, and there are significant numbers of TVC Frames that have been set aside because of internal corrosion. The initial objectives of this project were to verify the effectiveness of CORTEC LVCI 377 through the uses of the NASA Kennedy Space Center (KSC) Beach Exposure Corrosion Site, and the U. C. Davis / McClellan Nuclear Radiation Center (MNRC) located in Sacramento, CA. CORTEC also provided verification procedures for use of the LVCI in production at USA Florida Operations, with Refractometry, Titration and pH analysis. See USA LLC Copyright Agreement in References (2).

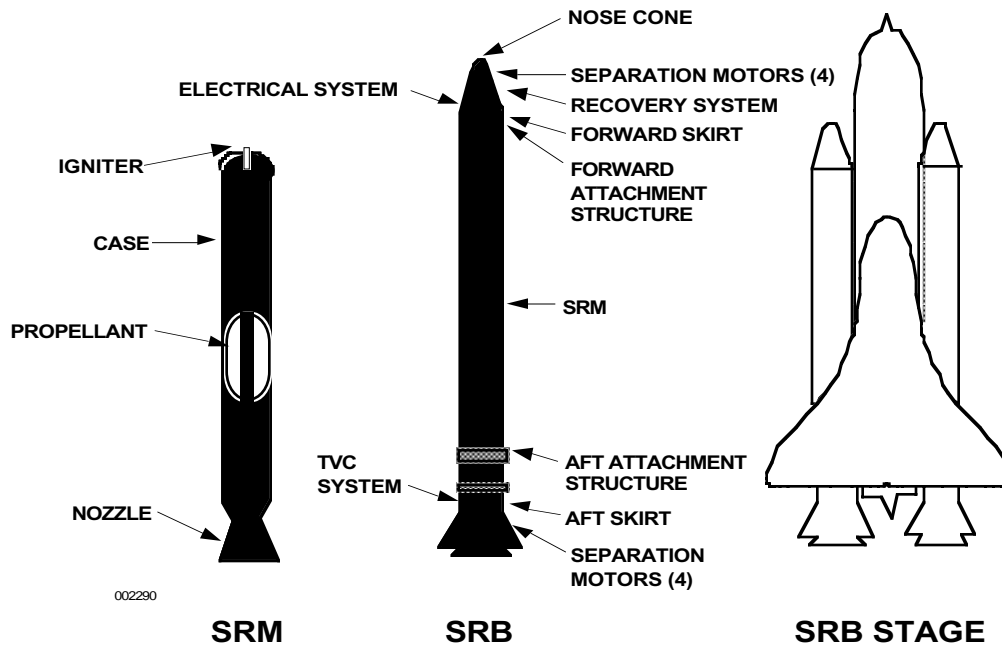

Figure 1. Space Shuttle's SRB

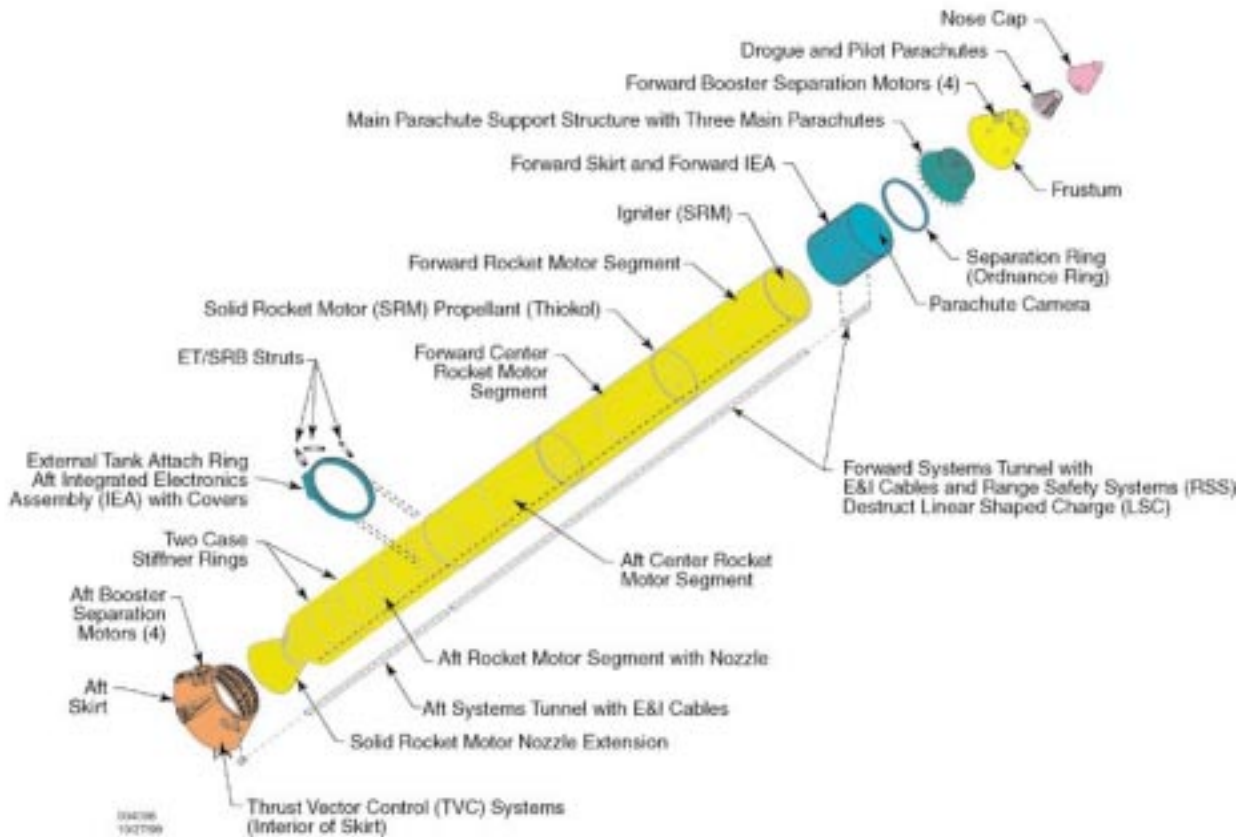

Figure 2. Solid Rocket Booster

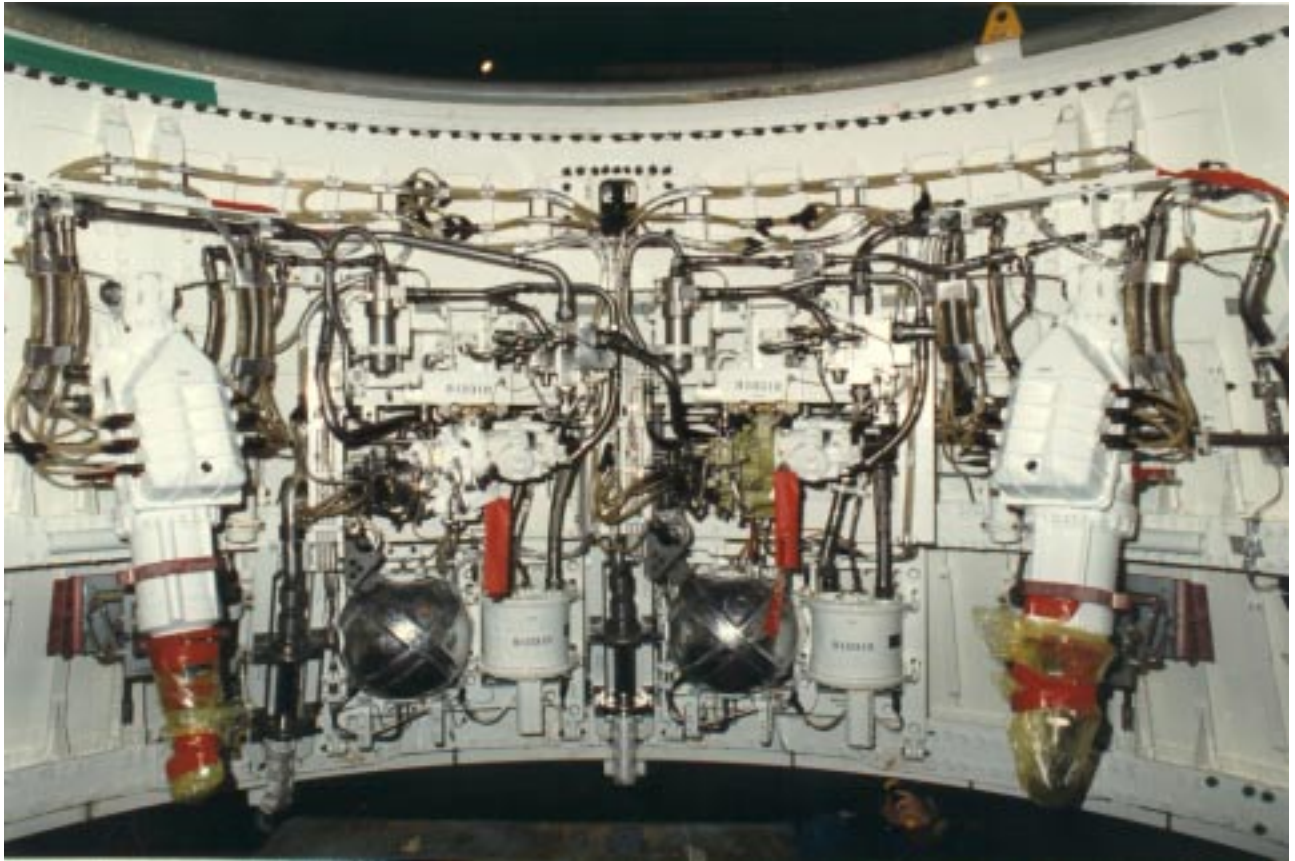

Figure 3. SRB Aft Skirt Location of TVC System

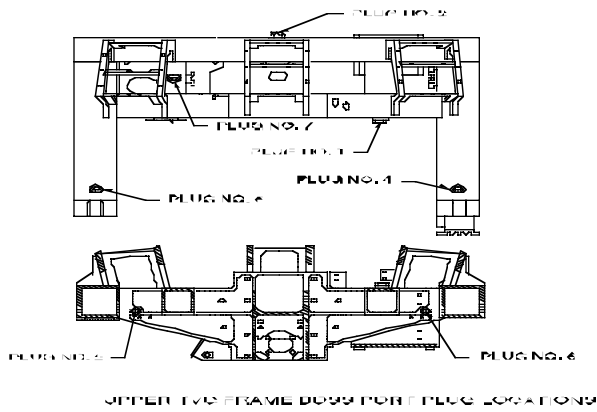

Figure 4. Sectional View of Upper TVC Frame

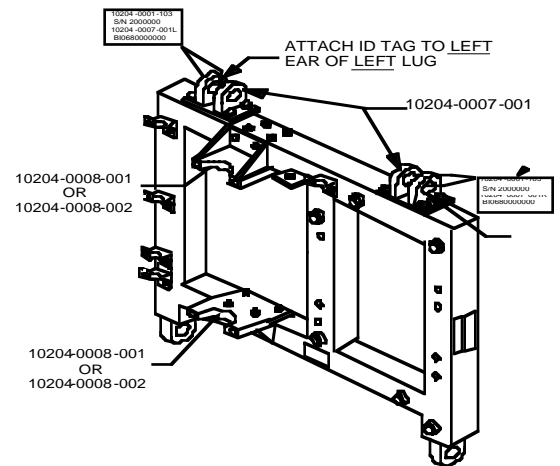

Figure 5. Construction of Lower TVC Frame

## DISCUSSION

### LVCI Evaluation

The first phase of this program involved the selection and screening of environmentally compatible, non-flammable LVCI's. CORTEC Corporation produces an excellent selection of LVCI's, and two were initially selected for evaluation. Of these two, one product (LVCI 377) evaluated for environmental compatibility, stability, flammability and corrosion protection of 2219 Aluminum Alloy was selected. A non-flight TVC Frame was sectioned and used as an environmental chamber for placing 2219 -T87 Aluminum Alloy LVCI treated test coupons at the NASA KSC Beach Exposure Corrosion Site. Figure 6 shows the diluted (1 Part LVCI to 1 Part Water) LVCI used to treat the bare aluminum test coupons. Figure 7 shows the sectioned TVC Frame with coupons installed.

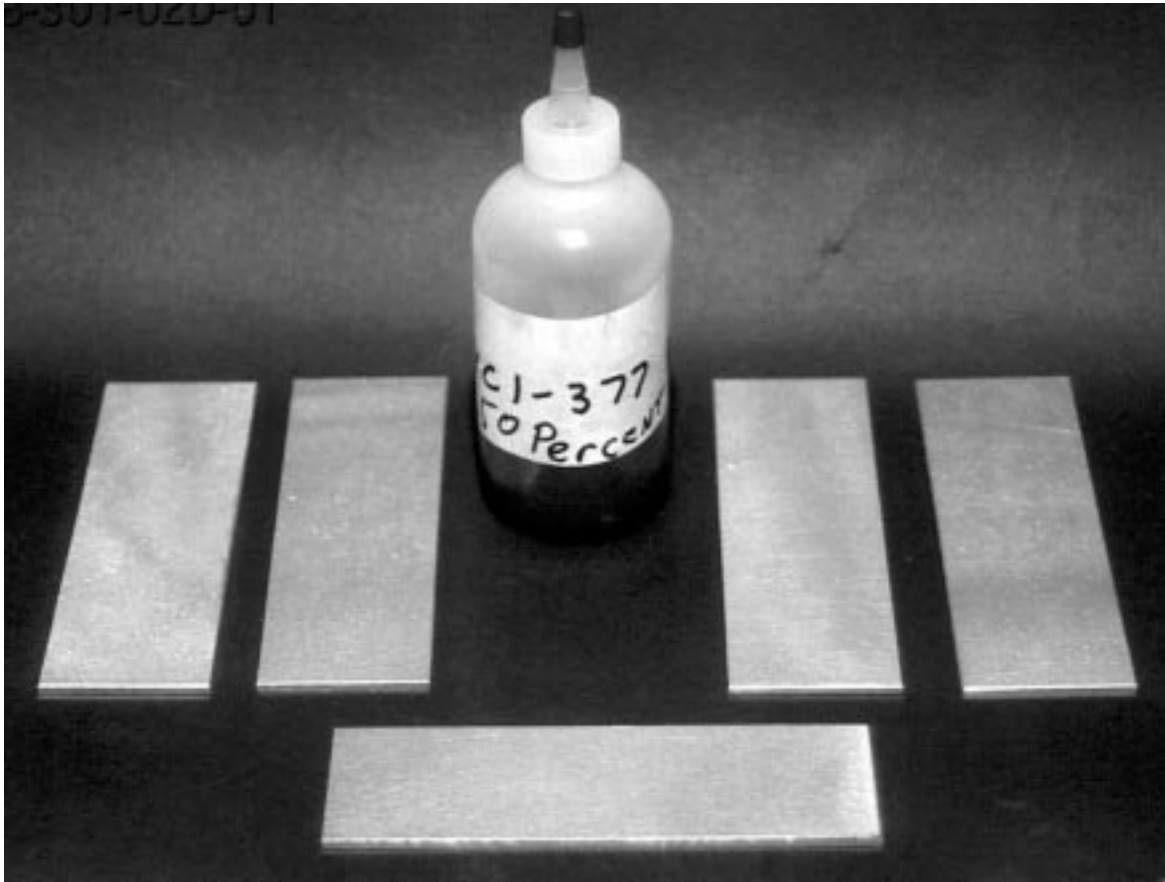
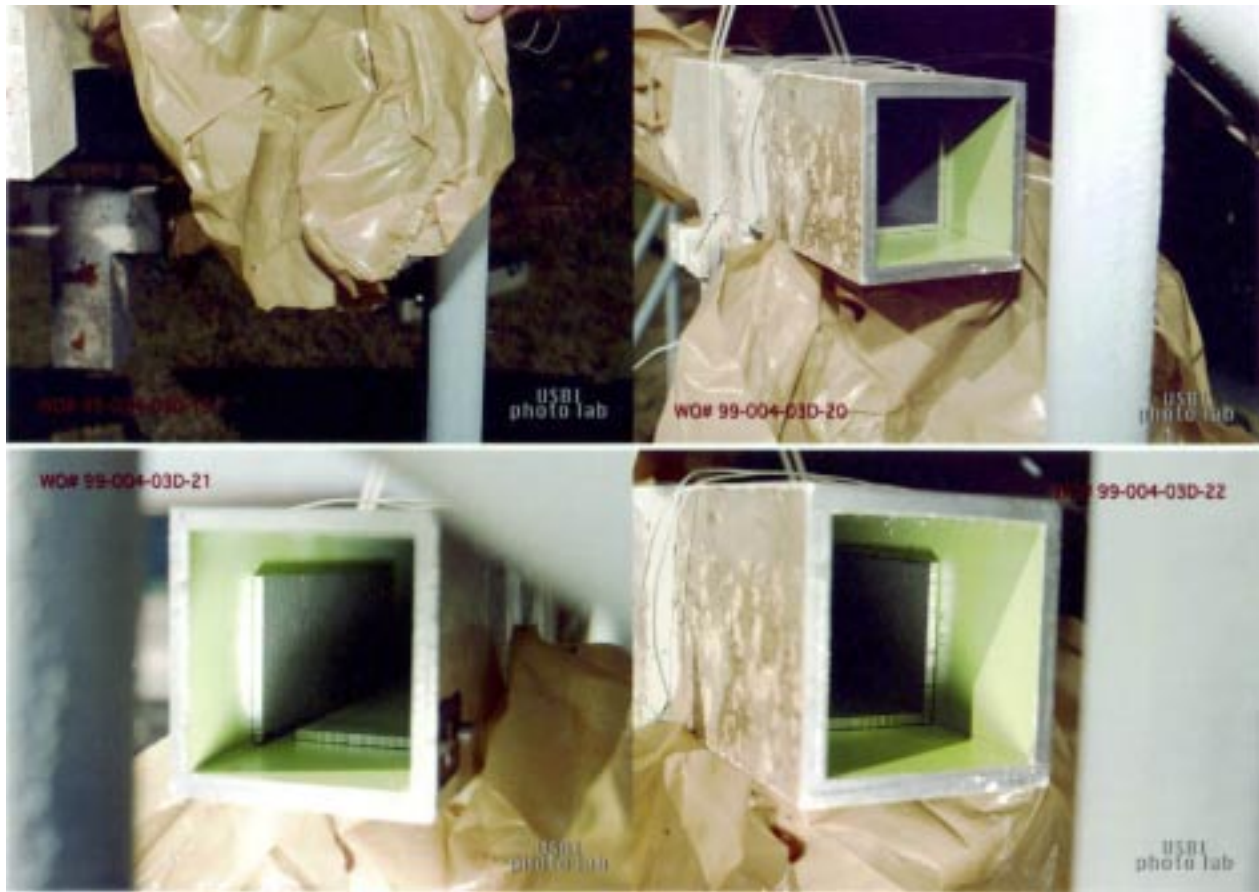

Figure 6. LVCI With Aluminum Test Coupons



**Figure 7. TVC Frames With Test Coupons at KSC Beach Exposure Corrosion Site**

Sectioned TVC Frames and inserted test coupons were set on racks, approximately 100 meters from high tide line , and facing the Atlantic ocean. The salt fog and corrosive acidic condensates from the SRB plumes make the exposure site one of the most corrosive environments in the world. Periodic inspection and digital photos were made as part of the LVCI evaluation.

The MNRC has a TRIGA Reactor that produces sufficient thermal neutrons and complementary robotic work cells that allows for corrosion evaluation and accurate positioning of critical fighter and cargo aircraft parts. USA LLC was able to contract with MNRC to evaluate internal corrosion of Non-Flight SRB TVC Frames, and hopefully establish capability for potential future evaluation of SRB flight hardware. Two (2) Upper, and two (2) Lower TVC non-flight frames were used for Neutron Radiography (N-Ray) corrosion evaluation. Initial N-Ray Baselineing was performed on untreated frames. The TVC frame cavities were then flushed with Grade A (Deionized) water, emptied, and then filled with LVCI. The LVCI was allowed to penetrate for one hour, with rotation of the frame to guarantee LVCI coverage. The LVCI was then pumped/vacuumed from the cavities, and Boss Port Plugs installed. Another series of N-Radiographs were made after the initial LVCI application. Subsequent N-Ray evaluations were made after 3 months, and then after 8 months exposure to the LVCI. MNRC was able to produce N-Radiographs using Film and also real-time with recordings on Video Tape. Figure 8 shows some typical work being done at the MNRC.

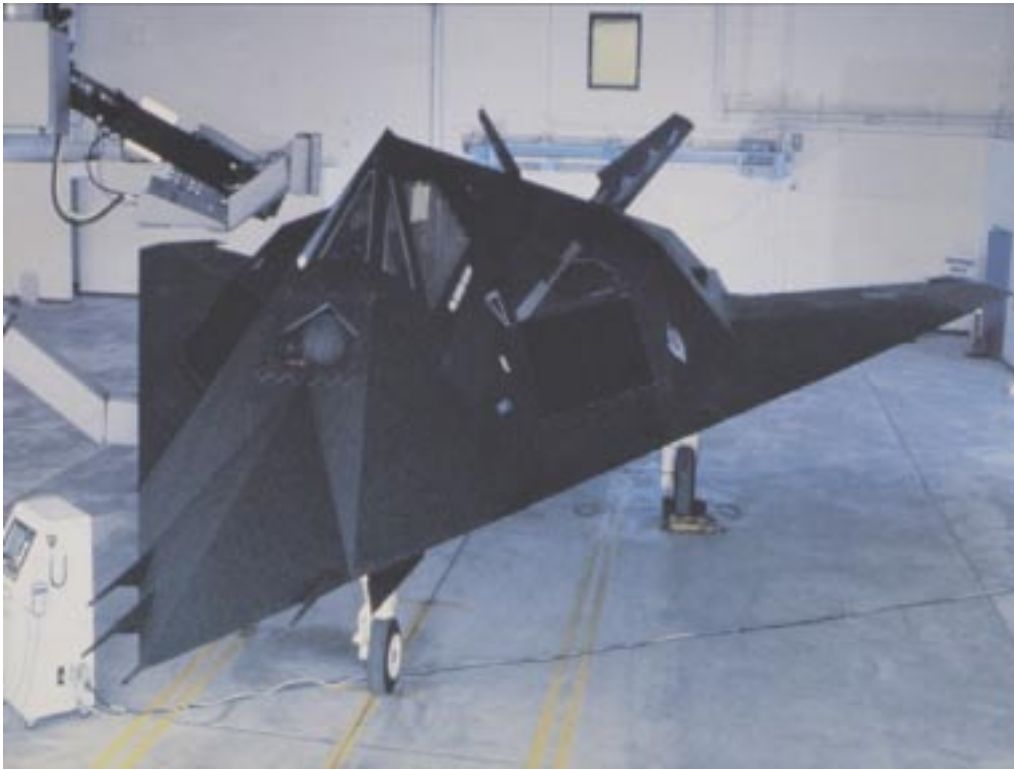

**Figure 8. Radiographic Facility at McClellan Nuclear Radiation Facility**

### **Test Results**

NASA KSC Beach Exposure Corrosion Site evaluations and documentation were made on a regular basis. TVC frames were loosely covered with a secured plastic wrap, and allowed to remain exposed for almost a year. There was virtually no corrosion on the test coupons treated with the LVCI. One TVC frame exposed to hurricane force winds after 10 months exposure lost its plastic cover, and with internal test coupons sand blasted; experienced premature corrosion immediately after. Figure 9 shows typical surface conditions of aluminum test coupons after 7 months beach exposure. It should be noted that the slight brown color intermittently seen on the test coupon's surfaces, are trace amounts of LVCI that dried to a somewhat greater film thickness. Essentially, the test coupons were corrosion free. In many cases during evaluation of the LVCI effectiveness, residual water was found inside the TVC frame cavities, with no effect on corrosion of the test coupons. It would be very difficult to duplicate the environmental exposure given to the test coupons at the NASA KSC Beach Exposure Corrosion Site. Testing was also performed using ASTM B 117 (1) Neutral Salt Fog testing procedure as well as Temperature-Humidity cycling in an environmental test chamber. None of these tests revealed the true capability of the CORTEC LVCI 377, as did the NASA KSC Beach Exposure Corrosion Site evaluations.

MNRC personnel were able to produce an excellent series of Neutron Radiographs with Type SR Film, Screen, Gd and also with Real-Time imaging captured on Video Tape. Although Real-time Radiography was less sensitive than the Film Type, it was found to be adequate for locating internal TVC Frame corrosion sites. A combination of Real-Time and Film Radiography techniques would prove to be an economical combination. Initial Baseline N-Rays of the 4 frames allowed for comparison before and after LVCI application, and then after 3 month and 8 month exposures. It was interesting to note that the LVCI acted as an amplifier of corrosion in crevices that were not visible before application of the LVCI, and during N-Ray interrogation. Figures 10 and 11 show N-Rays of Upper and Lower TVC Frames.



**Figure 9. Aluminum Test Coupons after 7 Months Beach Exposure**

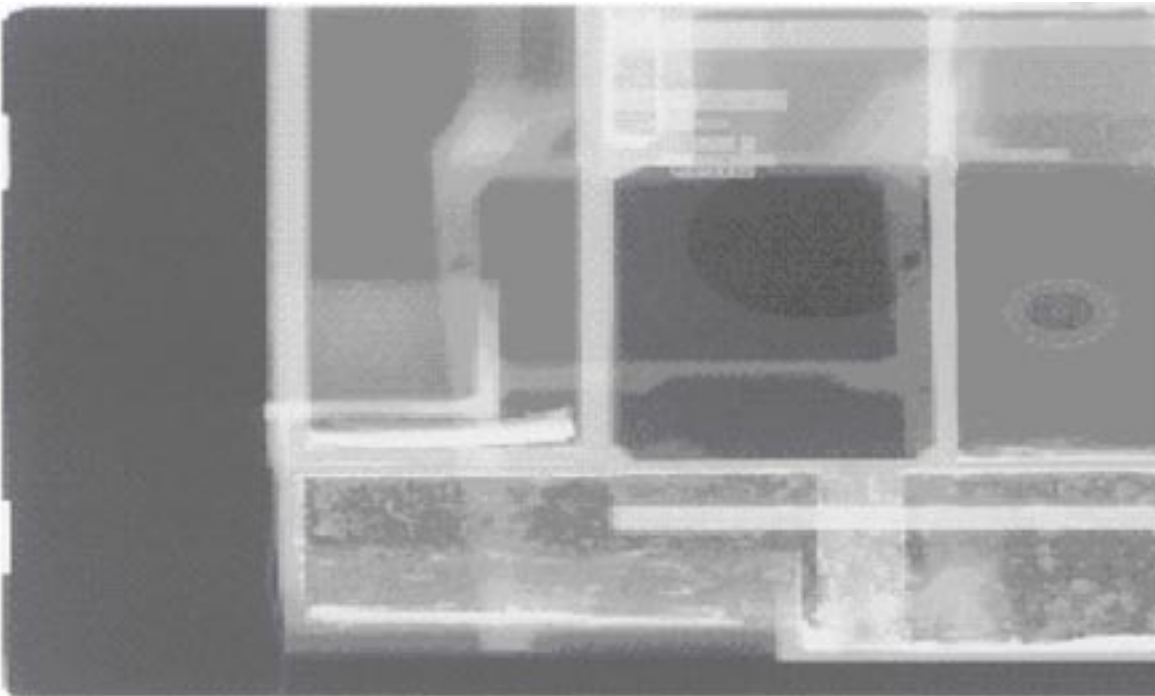

**Figure 10. Neutron Radiograph (Film) of Upper TVC Frame**

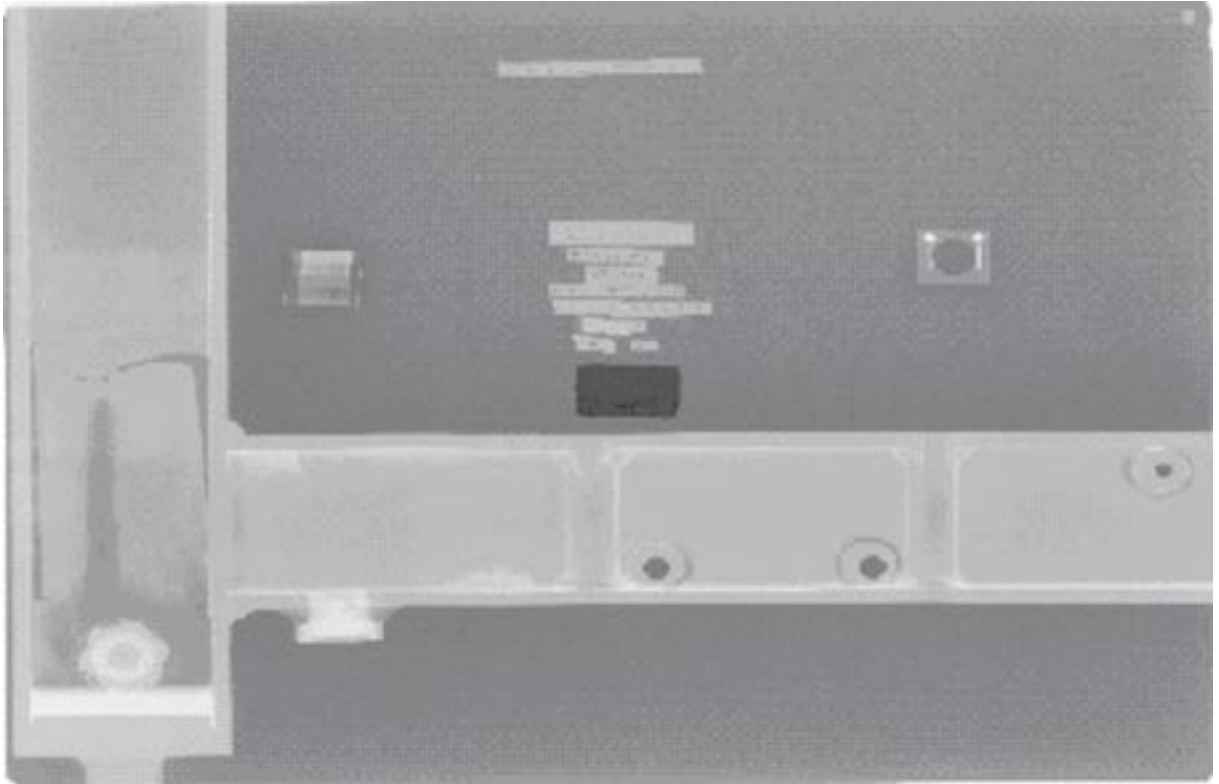

**Figure 11. Neutron Radiograph (Film) of Lower TVC Frame**



## CONCLUSION

Testing and evaluation of an environmentally compatible LVCI was successfully accomplished as a team representing MSFC Non-destructive Evaluation and Tribology Branch, KSC Corrosion Engineering Branch, U.C. Davis/MNRC Nuclear Radiation Division, CORTEC Corporation, and USA Materials & Processes Engineering, Refurbishment Engineering, and Refurbishment Operations departments. It was found that cooperation from all of the team members was exceptional throughout the project. Testing at the KSC Beach Exposure Corrosion Site, revealed the excellent stability of LVCI-377 in one of the worlds most corrosive seacoast environments. Corrosion protection of the bare 2219 aluminum alloy test coupons remained excellent throughout the 1 year exposure period. Neutron radiography performed at the MNRC facility, showed excellent compatibility of the LVCI with internal TVC Frame cavity materials, consisting of an epoxy polyamide primer and 2219 aluminum alloy welded structures. The use of N-Ray with real-time and film processes, showed internal corroded areas of TVC Frames not found with borescopic inspection, and was performed in a very efficient manner. USA Florida Operations are presently developing the documents necessary for implementing the environmentally compatible and effective LVCI on SRB TVC Frames.

## ACKNOWLEDGMENTS

The authors would like to thank the various USA Departments both in Huntsville, Alabama and Kennedy Space Center, Florida for supporting and assisting in program management, production operations, logistics and testing. Many thanks to NASA Marshall Space Flight Center Materials and Processes Laboratory Departments, NASA Kennedy Space Center Corrosion Engineering Laboratory, U. C. Davis/McClellan Nuclear Radiation Center –Nuclear Radiation Division personnel who were all supportive of this program. Additional thanks are given to the CORTEC Corporation management, scientists, engineers, and marketing groups that helped make this program a success.

## REFERENCES

- (1). Annual Book of ASTM Standards, Vol. 03.02, "Wear and Erosion; Metal Corrosion", ASTM, Philadelphia, PA 1997. (ASTM B 117)
- (2). Copyright © 2002 by United Space Alliance, LLC. Published with permission. These materials are sponsored by the National Aeronautics and Space Administration under Contract NAS9-20000. The U.S. Government retains a paid-up, nonexclusive, irrevocable worldwide license in such materials to reproduce, prepare derivative works, distribute copies to the public, and perform publicly and display publicly, by or on behalf of the U.S. Government. All other rights are reserved by the copyright owner.