

# The Application of Fiber Optic Wavelength Division Multiplexing in RF Avionics

Duc Ngo and Hung Nguyen  
Glenn Research Center, Cleveland, Ohio

Mohammed Atiquzzaman  
University of Oklahoma, Norman, Oklahoma

James J. Sluss, Jr. and Hakki H. Refai  
University of Tulsa, Tulsa, Oklahoma

## The NASA STI Program Office . . . in Profile

Since its founding, NASA has been dedicated to the advancement of aeronautics and space science. The NASA Scientific and Technical Information (STI) Program Office plays a key part in helping NASA maintain this important role.

The NASA STI Program Office is operated by Langley Research Center, the Lead Center for NASA's scientific and technical information. The NASA STI Program Office provides access to the NASA STI Database, the largest collection of aeronautical and space science STI in the world. The Program Office is also NASA's institutional mechanism for disseminating the results of its research and development activities. These results are published by NASA in the NASA STI Report Series, which includes the following report types:

- **TECHNICAL PUBLICATION.** Reports of completed research or a major significant phase of research that present the results of NASA programs and include extensive data or theoretical analysis. Includes compilations of significant scientific and technical data and information deemed to be of continuing reference value. NASA's counterpart of peer-reviewed formal professional papers but has less stringent limitations on manuscript length and extent of graphic presentations.
- **TECHNICAL MEMORANDUM.** Scientific and technical findings that are preliminary or of specialized interest, e.g., quick release reports, working papers, and bibliographies that contain minimal annotation. Does not contain extensive analysis.
- **CONTRACTOR REPORT.** Scientific and technical findings by NASA-sponsored contractors and grantees.

- **CONFERENCE PUBLICATION.** Collected papers from scientific and technical conferences, symposia, seminars, or other meetings sponsored or cosponsored by NASA.
- **SPECIAL PUBLICATION.** Scientific, technical, or historical information from NASA programs, projects, and missions, often concerned with subjects having substantial public interest.
- **TECHNICAL TRANSLATION.** English-language translations of foreign scientific and technical material pertinent to NASA's mission.

Specialized services that complement the STI Program Office's diverse offerings include creating custom thesauri, building customized databases, organizing and publishing research results . . . even providing videos.

For more information about the NASA STI Program Office, see the following:

- Access the NASA STI Program Home Page at <http://www.sti.nasa.gov>
- E-mail your question via the Internet to [help@sti.nasa.gov](mailto:help@sti.nasa.gov)
- Fax your question to the NASA Access Help Desk at 301-621-0134
- Telephone the NASA Access Help Desk at 301-621-0390
- Write to:  
NASA Access Help Desk  
NASA Center for AeroSpace Information  
7121 Standard Drive  
Hanover, MD 21076



# The Application of Fiber Optic Wavelength Division Multiplexing in RF Avionics

Duc Ngo and Hung Nguyen  
Glenn Research Center, Cleveland, Ohio

Mohammed Atiquzzaman  
University of Oklahoma, Norman, Oklahoma

James J. Sluss, Jr. and Hakki H. Refai  
University of Tulsa, Tulsa, Oklahoma

Prepared for the  
23rd Digital Avionics Systems Conference  
cosponsored by the Mitre Center for Advanced Aviation Systems Development  
and NASA Glenn Research Center  
Salt Lake City, Utah, October 24–28, 2004

National Aeronautics and  
Space Administration

Glenn Research Center

## Acknowledgments

The project was funded by NASA Grant no. NCC3-1069. The authors acknowledge and greatly appreciate the support of NASA Glenn Research Center for funding this project.

This report is a formal draft or working paper, intended to solicit comments and ideas from a technical peer group.

This report contains preliminary findings, subject to revision as analysis proceeds.

Available from

NASA Center for Aerospace Information  
7121 Standard Drive  
Hanover, MD 21076

National Technical Information Service  
5285 Port Royal Road  
Springfield, VA 22100

Available electronically at <http://gltrs.grc.nasa.gov>

# The Application of Fiber Optic Wavelength Division Multiplexing in RF Avionics

Duc Ngo and Hung Nguyen  
National Aeronautics and Space Administration  
Glenn Research Center  
Cleveland, Ohio 44135

Mohammed Atiquzzaman  
University of Oklahoma  
School of Computer Science  
Norman, Oklahoma 73019

James J. Sluss, Jr., and Hakki H. Refai  
University of Tulsa  
School of Electrical and Computer Engineering  
Tulsa, Oklahoma 74135

## Abstract

This paper demonstrates a successful application of wavelength division multiplexing (WDM) to the avionics environment to support analog RF signal transmission. We investigate the simultaneous transmission of four RF signals (channels) over a single optical fiber. These four analog channels are sequentially multiplexed and demultiplexed at different points along a fiber optic backbone to more closely emulate the conditions found onboard aircraft. We present data from measurements of signal-to-noise ratio (SNR), transmission response (loss and gain), group delay that defines phase distortion, and dynamic range that defines nonlinear distortion. The data indicate that WDM is well-suited for avionics applications.

## Introduction

Optical fiber offers many advantages over coaxial cable for the transmission of RF signals in avionics applications. Optical fiber exhibits considerably less loss, can support signals requiring much higher bandwidth, is immune to electromagnetic interference (EMI), and offers significant size and weight savings when compared to coaxial cable. Recently, the availability of the Internet onboard commercial aircraft adds increased credence to ambitions of delivering new information services during flight [1]. The onboard implementation of Voice-over-IP (VoIP), high-definition television (HDTV), and radio frequency (RF) signals used to transport cellular signals, as shown in

figure 1, is a driving force behind investigations into the use of fiber optic wavelength division multiplexing (WDM) technology to support high bandwidth communications backbone requirements. WDM is a technique that allows multiple signals with different modulation formats and bandwidths to be combined and transmitted over a single optical fiber. Traditionally, WDM has been used by the telecommunications industry to increase the digital information carrying capacity of optical fibers. In this paper, a WDM network supporting four analog RF channels has been demonstrated as a successful application that meets the demands of the avionics environment.

The objective of this paper is to characterize four end-to-end communication channels established when modulated analog RF signals are transmitted over single fiber using a WDM network. We expect that the promising and novel results presented in this paper will stimulate further research in this emerging area.

The rest of this paper is organized as follows. Next section describes our experimental setup to transmit four channels of RF modulated signals over a WDM network. We report the experimental results from our experiment in the third section, which includes measurements of signal-to-noise ratio (SNR), transmission response, group delay, and dynamic range for the transmission of four channels with different wavelengths over the WDM network. Concluding remarks are given in the last section.

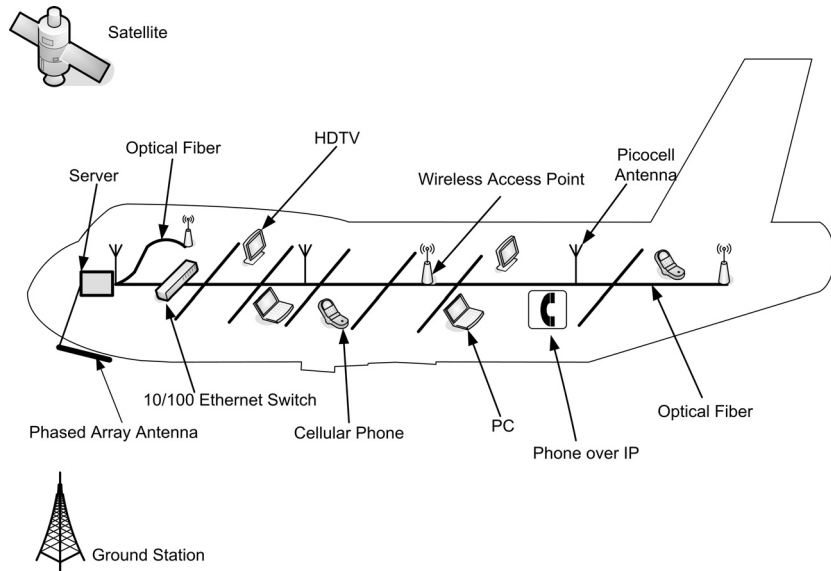

Figure 1.—Prospective services onboard of a commercial aircraft in the near future.

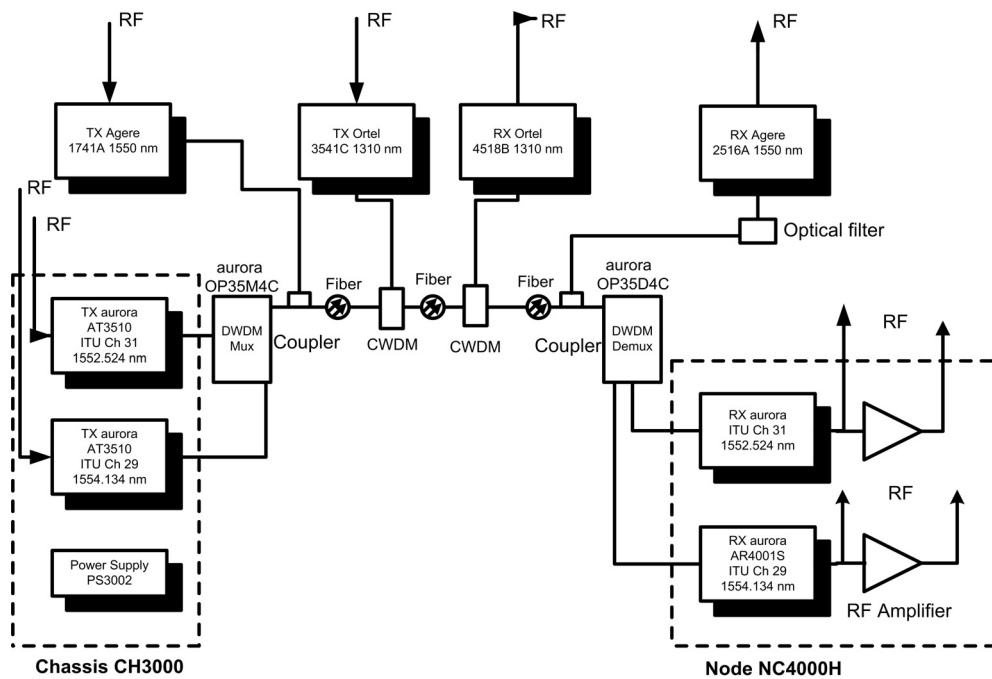

Figure 2.—WDM network provides four analog communication channels.

## Experimental Setup

Figure 2 illustrates the experimental setup for all measurements that are explained in the following section. Four wavelengths were used to demonstrate this avionics application 1552.524 nm, 1554.134 nm,

1550 nm, and 1310 nm, named Ch31, Ch29, Ch1550, and Ch1310, respectively.

Examining the communication link of Ch29, an Aurora AT3510 analog laser transmitter, with an ITU grid compliant output wavelength of 1552.524 nm, was fiber-coupled to an Aurora OP35M4C multiplexer

connected to an Aurora OP31M2D optical combiner that multiplexes 1310 nm with 1550 nm wavelengths.

A coil of optical fiber, 20 m in length, delivers the optical signal between the multiplexer and the combiner. Passing 3 m of optical fiber after the combiner, an Aurora OP31D2D optical splitter is connected. Another coil of optical fiber, 20 m in length, connects the 1310/1550 splitter with the OP35D4Cdemultiplexer. Finally, an Aurora AR4001S receiver translates the received optical signal into a RF signal that passes through an Aurora OA4444T-42 RF amplifier linked to the receiver output to provide RF signal gain. The RF frequency range of operation for the Aurora transmitter and receiver is from 46 MHz to 870 MHz. Similarly, the signal of Ch31 travels the same path as shown in the layout.

Ch1310 is coupled via an Aurora combiner to several meters of optical fiber and leaves the network through an Aurora splitter. Ch1510 was coupled via a 50/50 coupler to tens of meters and splits out of the main backbone using another 50/50 coupler and tunable bandpass fiber optic filter.

The extended distances for each link of the four channels, Ch29, Ch31, Ch1310, and Ch1550, are 47 m, 47 m, 9 m, and 41 m, respectively.

## Experimental Results

In this section, we report results obtained from our experimental setup described in the previous section. The results include: signal-to-noise ratio (SNR) measurements, transmission response measurements, group delay measurements, and dynamic range measurements. These measurements completely characterize the performance of four communication channels using four different wavelengths over a single optical fiber.

### SNR Measurements

Figure 3 shows the experimental setup for SNR measurements for all channels.

SNR provides a well-known measure of the transmission performance for each of the four communication channels in the WDM network. The major sources of noise in an optical communication link are relatively intensity noise (RIN) generated by the analog laser transmitter, shot noise generated by the photodiode in the analog receiver, and thermal noise generated by the circuitry. SNR measurements for the four channels of the WDM communication link are

shown in figures 4 through 7 from which we can list the following observations:

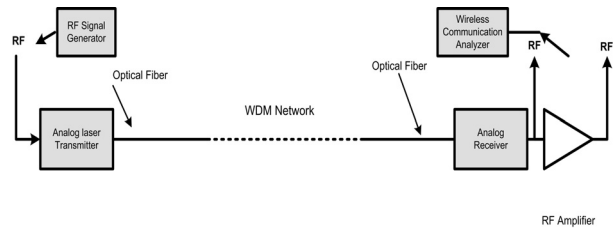

Figure 3.—The Experimental Setup for Measuring Signal-to-Noise Ratio (SNR).

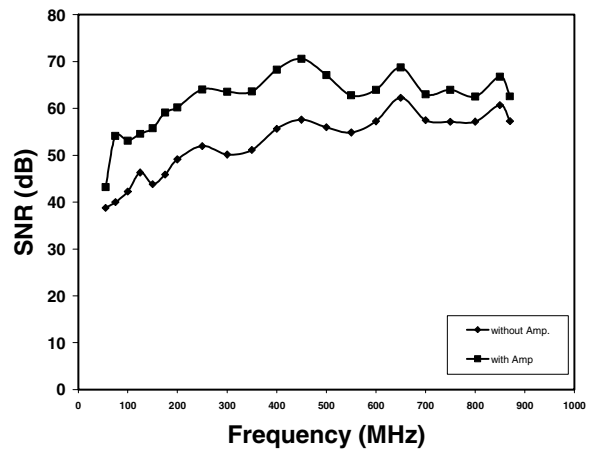

Figure 4.—Results of SNR Measurements for Ch29.

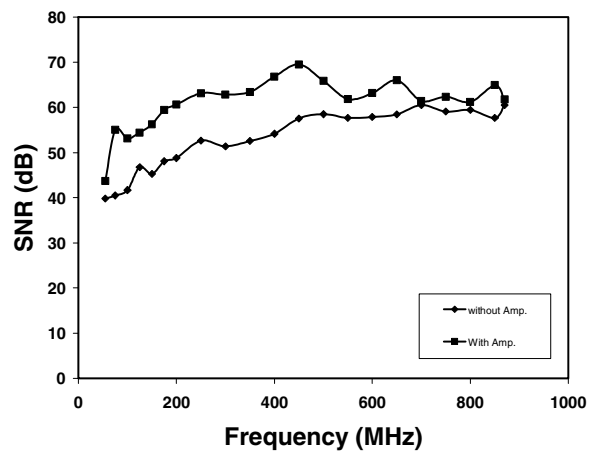

Figure 5.—Results of SNR Measurements for Ch31.

- Figure 4 shows that SNR for Ch29 without the RF amplifier varied between 38.77 dB and 60.69 dB over the frequency range 55-900 MHz while SNR with the RF amplifier varied between 43 dB and 68.69 dB over the same frequency range.
- Figure 5 shows that SNR for Ch31 without the RF amplifier varied between 39.81dB and 60.53 dB over the frequency range 55-900 MHz while SNR with the RF amplifier varied between 43.71 dB and 69.51 dB over the same frequency range.
- Figure 6 shows that SNR for Ch1310 varied between 4.36 dB and 30.08dB over the frequency range 100-4300 MHz.
- Figure 7 shows that SNR for Ch1510 varied between 2.62 dB and 22.98 dB over the frequency range 100-4300 MHz. Ch1550 uses bare analog transmitter and receiver, which they missed the peripheral circuitry that provide the stability and cooling.

Compared with results of other measurements conducted on analog fiber optic links reported in [2, 3], Ch29 and Ch31 have better SNR and Ch1310 and Ch1550 have acceptable SNR.

### Transmission Response Measurements

RF transmission response measurements provide the relative gain, or loss, in a communication link. Any signal attenuation or amplification in the communication link will manifest itself in the transmission response measurements. The vector network analyzer plots the result measurement trace using

$$Transmission(dB) = 10 \log \left( \frac{P_{trans}}{P_{inc}} \right)$$

where  $P_{trans}$  is the RF power measured at the output of the analog receiver and  $P_{inc}$  is the RF power measured at the input to the analog laser transmitter, as shown in figure 8.

Results of the transmission response for Channels 29 and 31, with and without the RF amplifier connected, are shown in figures 9 and 10. We observe that:

- Transmission response (gain) for Ch29 without the RF amplifier varied around 2dB and with the RF amplifier varied around 16 dB over the frequency range of 55-900 MHz.

- Transmission response (gain) for Ch31 without the RF amplifier is approximately 4 dB and with the RF amplifier is approximately 16 dB over the frequency range 55-900 MHz.

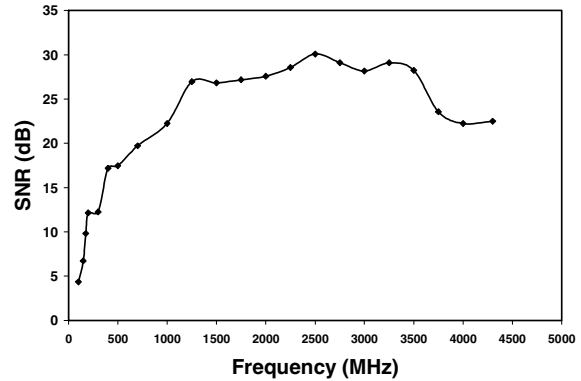

Figure 6.—Results of SNR Measurements for Ch1310.

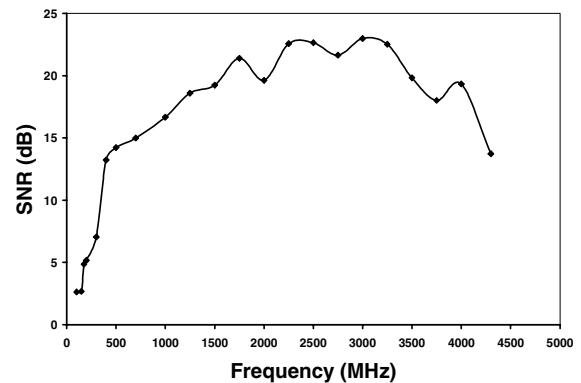

Figure 7.—Results of SNR Measurements for Ch1550.

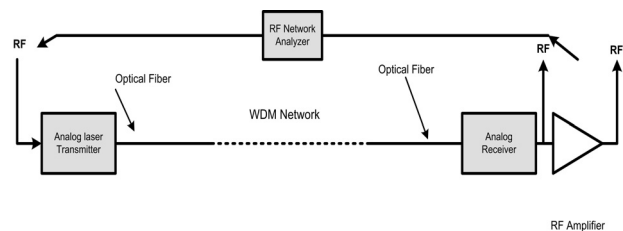

Figure 8.—The Experimental Setup for Measuring Transmission Response.



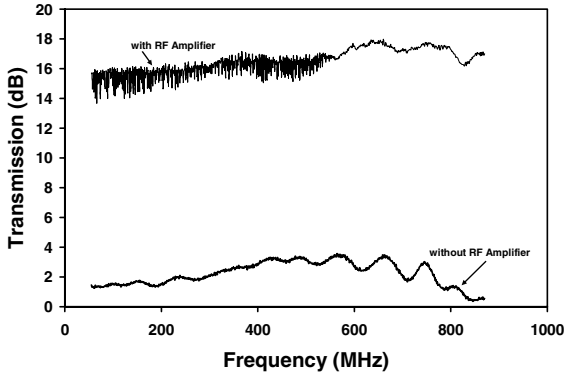

Figure 9.—Results of Transmission Response Measurements for Ch29.

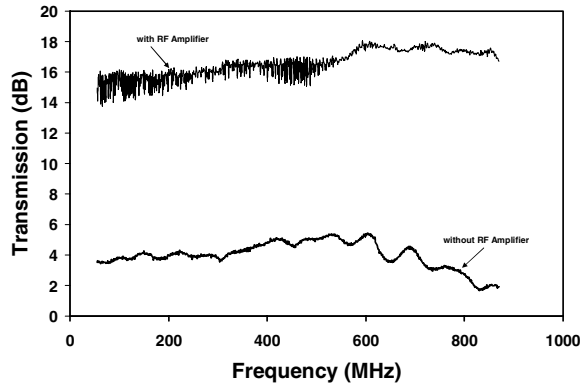

Figure 10.—Results of Transmission Response Measurements for Ch31.

Results of the transmission response for channels 1310 and 1550 are shown in figures 11 and 12. It can be seen that:

- The transmission response (loss) for channel 1310 is approximately -35 dB over the frequency range 0-1300 MHz.
- The transmission response (loss) for channel 1550 is approximately -60 dB over the frequency range 0-1300 MHz.

These measurements compare favorably with the -20 to -50 dB loss reported for a single analog fiber optic communication link [4], except for Ch1550 which needs an amplification stage. The RF amplifier provides sufficient gain to overcome the losses resulting from the coupling and splitting of the WDM equipment over the communication link, thus allowing the optical signal to travel farther distances.

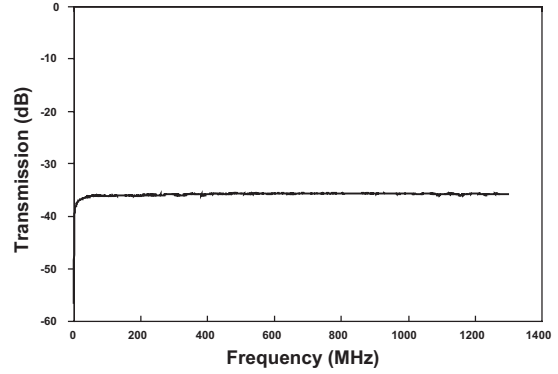

Figure 11.—Results of Transmission Response Measurements for Ch1310.

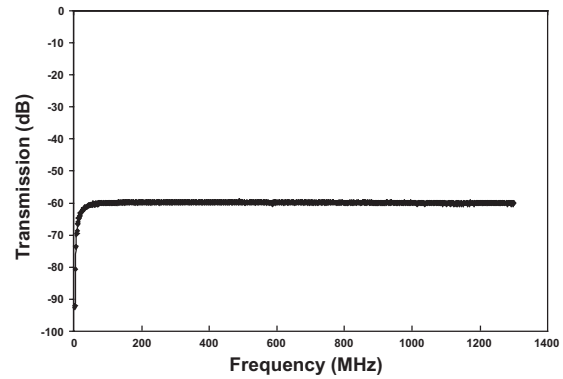

Figure 12.—Results of Transmission Response Measurements for Ch1550.

### Group Delay Measurements

Group delay is measure of the propagating delay that the signal experiences when traveling throughout a communication link. Variable group delay over the operating frequency range can produce a phase shift in the signal. To ensure that a communication link does not introduce a phase shift to the propagating signal, it is important to verify that the group delay is stable over the operating frequency range. The experimental setup used to measure the group delay is shown in figure 8.

Results of group delay measurements for all channels are:

- Group delays for Ch29, without and with RF amplifier, are approximately 304 ns and 313 ns, respectively. These measured group delays were approximately constant over the frequency range 55-870 MHz, which indicates that the communication link is free of phase distortion.

- Group delays for Ch31, without and with RF amplifier, are approximately 300 ns and 315 ns, respectively. These values for group delay were constant over the operating frequency range 55-870 MHz, which again indicates that the communication link is free of phase distortion.
- Group delay for Ch1310 is approximately 101 ns and constant over the frequency range 50-1300 MHz.
- Group delay for Ch1550 is approximately 218.5 ns and constant over the frequency range 50-1300 MHz, except over specified frequencies 590 MHz and 780 MHz, which leads to a small phase distortion over at some frequencies.

### Dynamic range measurements

Major causes of distortion in an optical communication link are due to the nonlinear devices incorporated into the analog transmitter and receiver, particularly the analog modulators [5]. Dynamic range measurements provide the range of the RF input power over which no distortion occurs due to harmonics.

Two principle methods to measure the dynamic range are [5, 6]:

1. Supply a single RF sinusoid signal  $f$  through the optical communication link and measure the resulting second- and third-order harmonic distortions at  $2f$  and  $3f$ , respectively.
2. Supply two equal amplitude sinusoidal RF signals that are close in frequency spacing

through the optical communication link and measure the second-order intermodulation distortion at  $f_2 + f_1$  or  $f_2 - f_1$  and the 3<sup>rd</sup> order intermodulation distortion at  $2f_1 - f_2$ ,  $2f_2 - f_1$ ,  $2f_1 + f_2$ , or  $2f_2 + f_1$ . Narrowband communication links allow the following frequencies  $2f_1 - f_2$  and  $2f_2 - f_1$  third-order intermodulation (3IM) distortion to pass and eliminate the rest.

The second method, the more practical way, was used to measure the dynamic range for Ch29 and Ch31, as shown in figure 13.

Two equal power sinusoidal RF signals at closely spaced frequencies  $f_1 = 499 \text{ MHz}$ ,  $f_2 = 501 \text{ MHz}$  were multiplexed using a RF multiplexer. Injecting the composite RF signal into Ch29 and Ch31, the 3IM signal power was measured at frequencies  $2f_1 - f_2 = 497 \text{ MHz}$ , and  $2f_2 - f_1 = 503 \text{ MHz}$ . Repeating the same measurements while increasing the input power for both sinusoidal signals will allow the 3IM trend to be plotted. Measuring the output power of the fundamental frequency  $f = 500 \text{ MHz}$  while increasing the input power over the same range of power leads the fundamental output trend to be plotted, thus the plotted line intersects the 3IM line.

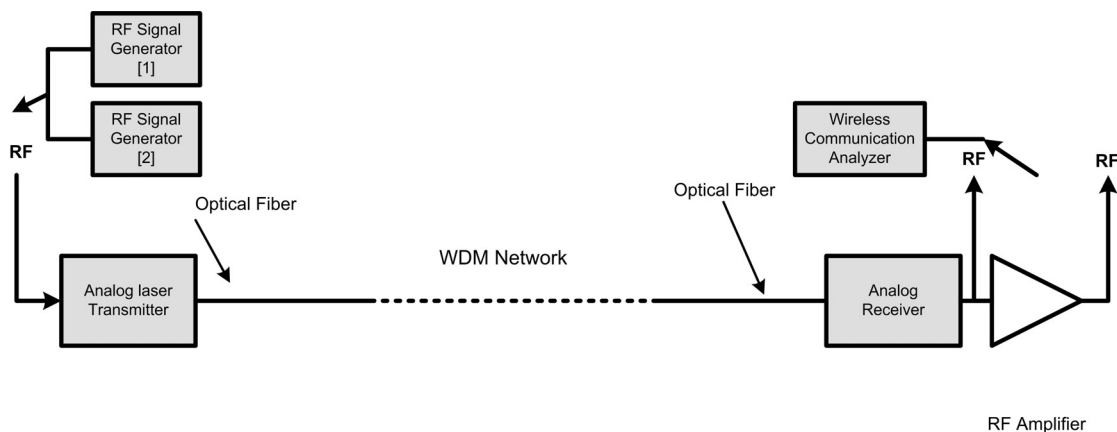

Figure 13.—The Experimental Setup for Measuring the Dynamic Range.

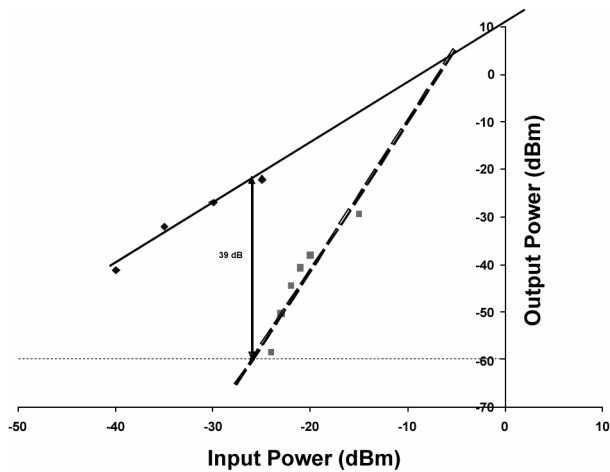

Figure 14.—Dynamic range for Ch29.

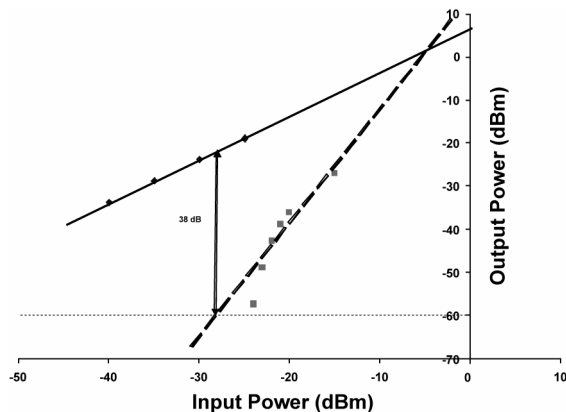

Figure 15.—Dynamic Range for Ch31.

The third-order intermodulation free dynamic range for Ch29 is 39 dB, as shown in figure 14.

Also, the third-order intermodulation free dynamic range for Ch31 is 38 dB, as shown in figure 15. Compared with previously reported results for single optical fiber links [3, 7], the third-order intermodulation free dynamic ranges measured over the WDM link are acceptable. Dynamic range has been measured just for Ch29 and Ch31.

## Conclusion

This paper reported and depicted the results of an investigation into the use of wavelength division multiplexing (WDM) technology to simultaneously transport four different channels of analog RF signal transmissions onboard an aircraft. The overall system analyses of signal-to-noise ratio (SNR), transmission response, group delay, and dynamic range that were carried out during the investigation were promising and indicated that the WDM suitability for avionics applications. With the recent publicity of Internet availability during commercial air flights, WDM technology can be used to simultaneously transmit Voice-over-IP, IP-Television, and RF signals on a single fiber.

## References

- [1] Dipert, B., December, 2003, Fly with the Internet at your seat, EDN Magazine, pp. 41-47.
- [2] Slaveski, F., Sluss, J., Jr., Atiquzzaman, M., Nguyen, H., and Ngo, D., (2003), Optical Fiber Wavelength Division Multiplexing, IEEE Aerospace and Electronic Systems Magazine.
- [3] Stephens, William E., and Thomas R. Joseph, March 1987, System Characteristics of Direct Modulated and Externally Modulated RF Fiber-Optic Link, IEEE Journal of Lightwave Technology, Vol. LT-5, No. 3, pp. 380-387.
- [4] Cox III, Charles H., Gary E. Betts, Leonard M. Johnson, May 1990, An Analytic and Experimental Comparison of Direct and External Modulation in Analog Fiber-Optic Links, IEEE Transactions on Microwave Theory and Techniques, Vol. 38, No. 5, pp. 501-509.
- [5] Cox, III, Charles H., 2004, Analog Optical Links Theory Practice, Cambridge, Chapter 6.
- [6] Chang, William S.C., 2002, RF photonic technology in optical fiber links, Cambridge, Chapter 1.
- [7] Cox, C., III., Ackerman, E., Helkey, R., and Betts, G.E., August 1997, Direct-Detection Analog Optical Links, IEEE Transactions on Microwave Theory and Techniques, Vol. 45, No. 8.

# REPORT DOCUMENTATION PAGE

*Form Approved*  
*OMB No. 0704-0188*

Public reporting burden for this collection of information is estimated to average 1 hour per response, including the time for reviewing instructions, searching existing data sources, gathering and maintaining the data needed, and completing and reviewing the collection of information. Send comments regarding this burden estimate or any other aspect of this collection of information, including suggestions for reducing this burden, to Washington Headquarters Services, Directorate for Information Operations and Reports, 1215 Jefferson Davis Highway, Suite 1204, Arlington, VA 22202-4302, and to the Office of Management and Budget, Paperwork Reduction Project (0704-0188), Washington, DC 20503.

<b>1. AGENCY USE ONLY</b> <i>(Leave blank)</i>	<b>2. REPORT DATE</b> November 2004	<b>3. REPORT TYPE AND DATES COVERED</b> Technical Memorandum	
<b>4. TITLE AND SUBTITLE</b>  The Application of Fiber Optic Wavelength Division Multiplexing in RF Avionics		<b>5. FUNDING NUMBERS</b>  WBS-22-727-01-05	
<b>6. AUTHOR(S)</b>  Duc Ngo, Hung Nguyen, Mohammed Atiqzaman, James J. Sluss, Jr., and Hakki H. Refai			
<b>7. PERFORMING ORGANIZATION NAME(S) AND ADDRESS(ES)</b>  National Aeronautics and Space Administration John H. Glenn Research Center at Lewis Field Cleveland, Ohio 44135-3191		<b>8. PERFORMING ORGANIZATION REPORT NUMBER</b>  E-14838	
<b>9. SPONSORING/MONITORING AGENCY NAME(S) AND ADDRESS(ES)</b>  National Aeronautics and Space Administration Washington, DC 20546-0001		<b>10. SPONSORING/MONITORING AGENCY REPORT NUMBER</b>  NASA TM-2004-213377	
<b>11. SUPPLEMENTARY NOTES</b> Prepared for the 23rd Digital Avionics Systems Conference cosponsored by the Mitre Center for Advanced Aviation Systems Development and NASA Glenn Research Center, Salt Lake City, Utah, October 24-28, 2004. Duc Ngo and Hung Nguyen, NASA Glenn Research Center; Mohammed Atiqzaman, University of Oklahoma, School of Computer Science, Norman, Oklahoma 73019; James J. Sluss, Jr., and Hakki H. Refai, University of Tulsa, School of Electrical and Computer Engineering, Tulsa, Oklahoma 74135. Responsible person, Duc Ngo, organization code 5640, 216-433-8651.			
<b>12a. DISTRIBUTION/AVAILABILITY STATEMENT</b>  Unclassified - Unlimited Subject Categories: 85 and 17 Available electronically at <a href="http://gltrs.grc.nasa.gov">http://gltrs.grc.nasa.gov</a> This publication is available from the NASA Center for AeroSpace Information, 301-621-0390.		<b>12b. DISTRIBUTION CODE</b>	
<b>13. ABSTRACT</b> <i>(Maximum 200 words)</i>  This paper demonstrates a successful application of wavelength division multiplexing (WDM) to the avionics environment to support analog RF signal transmission. We investigate the simultaneous transmission of four RF signals (channels) over a single optical fiber. These four analog channels are sequentially multiplexed and demultiplexed at different points along a fiber optic backbone to more closely emulate the conditions found onboard aircraft. We present data from measurements of signal-to-noise ratio (SNR), transmission response (loss and gain), group delay that defines phase distortion, and dynamic range that defines nonlinear distortion. The data indicate that WDM is well-suited for avionics applications.			
<b>14. SUBJECT TERMS</b>  Wavelength division multiplexing; Fiber optic; Optical backbone; Transmitter/receiver		<b>15. NUMBER OF PAGES</b> 13	
		<b>16. PRICE CODE</b>	
<b>17. SECURITY CLASSIFICATION OF REPORT</b> Unclassified	<b>18. SECURITY CLASSIFICATION OF THIS PAGE</b> Unclassified	<b>19. SECURITY CLASSIFICATION OF ABSTRACT</b> Unclassified	<b>20. LIMITATION OF ABSTRACT</b>



