

EMU Shoulder Injury Tiger Team Report

*David R. Williams, MD
Canadian Space Agency
Saint Hubert, Québec*

*Brian J. Johnson
NASA Lyndon B. Johnson Space Center
Houston, Texas*



The NASA STI Program Office ... in Profile

Since its founding, NASA has been dedicated to the advancement of aeronautics and space science. The NASA Scientific and Technical Information (STI) Program Office plays a key part in helping NASA maintain this important role.

The NASA STI Program Office is operated by Langley Research Center, the lead center for NASA's scientific and technical information. The NASA STI Program Office provides access to the NASA STI Database, the largest collection of aeronautical and space science STI in the world. The Program Office is also NASA's institutional mechanism for disseminating the results of its research and development activities. These results are published by NASA in the NASA STI Report Series, which includes the following report types:

- **TECHNICAL PUBLICATION.** Reports of completed research or a major significant phase of research that present the results of NASA programs and include extensive data or theoretical analysis. Includes compilations of significant scientific and technical data and information deemed to be of continuing reference value. NASA counterpart of peer-reviewed formal professional papers, but having less stringent limitations on manuscript length and extent of graphic presentations.
- **TECHNICAL MEMORANDUM.** Scientific and technical findings that are preliminary or of specialized interest, e.g., quick release reports, working papers, and bibliographies that contain minimal annotation. Does not contain extensive analysis.
- **CONTRACTOR REPORT.** Scientific and technical findings by NASA-sponsored contractors and grantees.

- **CONFERENCE PUBLICATION.** Collected papers from scientific and technical conferences, symposia, seminars, or other meetings sponsored or co-sponsored by NASA.
- **SPECIAL PUBLICATION.** Scientific, technical, or historical information from NASA programs, projects, and missions, often concerned with subjects having substantial public interest.
- **TECHNICAL TRANSLATION.** English-language translations of foreign scientific and technical material pertinent to NASA's mission.

Specialized services that complement the STI Program Office's diverse offerings include creating custom thesauri, building customized databases, organizing and publishing research results ... even providing videos.

For more information about the NASA STI Program Office, see the following:

- Access the NASA STI Program Home Page at <http://www.sti.nasa.gov>
- E-mail your question via the Internet to help@sti.nasa.gov
- Fax your question to the NASA STI Help Desk at (301) 621-0134
- Telephone the NASA STI Help Desk at (301) 621-0390
- Write to:
NASA STI Help Desk
NASA Center for AeroSpace Information
7121 Standard Drive
Hanover, MD 21076-1320

NASA/TM—2003–212058

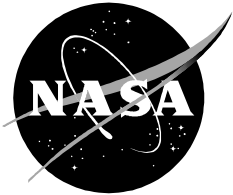

EMU Shoulder Injury Tiger Team Report

*David R. Williams, MD
Canadian Space Agency
Saint Hubert, Québec*

*Brian J. Johnson
NASA Lyndon B. Johnson Space Center
Houston, Texas*

National Aeronautics and
Space Administration

Lyndon B. Johnson Space Center
Houston, Texas 77058

September 2003

Available from:

NASA Center for AeroSpace Information
7121 Standard Drive
Hanover, MD 21076-1320
301-621-0390

National Technical Information Service
5285 Port Royal Road
Springfield, VA 22161
703-605-6000

This report is also available in electronic form at <http://techreports.larc.nasa.gov/cgi-bin/NTRS>

Preface

The number and complexity of extravehicular activities (EVAs) required for the completion and maintenance of the International Space Station (ISS) is unprecedented. It is not surprising that training to perform these space walks presents a risk of overuse musculoskeletal injuries. The goal of this tiger team was to identify the different factors contributing to the risk of EVA training-related shoulder injury and to make recommendations that would either significantly reduce or eliminate those risks.

During the tiger team review, it became evident that training in the extravehicular mobility unit may also result in other types of injuries, including fingernail delamination, elbow pain, knee pain, foot pain, and nerve compression leading to transient loss of sensation in certain areas of the upper or lower extremity. A multi-directorate team to detect, evaluate and respond to the medical issues associated with EVA training should be implemented immediately and given the appropriate resources and authority to reduce the risk of injury to crew during training to a level as low as reasonably achievable.

The Co-Chairs of the tiger team would like to thank all of the team members for their outstanding effort. In addition, we would like to thank the dedicated personnel of the Space and Life Sciences Directorate, the Mission Operations Directorate, the Flight Crew Operations Directorate, the EVA Office, the Engineering Directorate, ILC Dover, United Space Alliance, and Hamilton Sundstrand for their support with this activity. The invaluable contributions of orthopaedic consultants Dr. Kyle Dickson, Dr. Steve Viegas, Dr. Walter Lowe, and Dr. David Lintner are greatly appreciated. We would also like to thank Dr. E.G. McFarland, Department of Orthopaedic Surgery, Johns Hopkins University, for permission to use figures from the Sports Medicine Outpatient Guides in this document.

Brian J. Johnson
EVA Office
Mail Code XA
Johnson Space Center

David R. Williams MD FCFP FRCP
Astronaut Office
Mail Code CB
Johnson Space Center

September 2003

EMU Injury Tiger Team - Organization

Membership

Co-Chair CB/Dave Williams
 Co-Chair XA/Brian Johnson

Functional Representatives

Mission Operations	DX/Mary Fitts
Crew Systems	EC/Joe Kosmo
Space Suit Assembly Subsystem	EC5/Scott Cupples
Astronaut Office	CB/Rex Walheim
Human Factors (ABF)	SF3/Sudhakar Rajulu and Luis Gonzalez
Flight Crew Engineering	USA/FCE/Don Campbell, Lou Carfagno and Chris Trevino
Flight Medicine	SD2/Joe Dervay, Rick McCluskey
Occupational Health/NBL	SD/Chuck Ross and Sam Strauss
Astronaut Strengthening, Conditioning, and Rehabilitation Team	SD/Jamie Chauvin, Beth Shepherd, and Corey Twine

Major Accomplishments

December 2002	Creation of Tiger Team
January 2003	Completion of Astronaut Survey
	Evaluation of Shoulder Harness
	Laser Anthropometric Scanning
	Completion of DX Survey
March 2003	Consultation with Orthopedic Surgeons
April 2003	Evaluation of Ultrasound to Image Rotator Cuff
May 2003	EMU Fit Checks
	Ultrasound Evaluation of Rotator Cuff Impingement in EMU

Acronym List

ASCAN	astronaut candidate
ASCR	astronaut strength, conditioning, and rehabilitation trainer/team
EMR	electronic medical record
EMU	extravehicular mobility unit
ESP	external storage platform
EVA	extravehicular activity
FCE	flight crew equipment
FMC	Flight Medicine Clinic
HST	Hubble Space Telescope
HUT	hard upper torso
ISS	International Space Station
LCVG	liquid cooling and ventilation garment
MORD	medical operations requirements document
NBL	Neutral Buoyancy Laboratory
NSTS	NASA space transportation system
PGT	pistol grip tool
S/ADs	specification and analysis documents
SEMU	short extravehicular mobility unit
SETS	Shuttle equipment tracking system
SLAP	superior labrum anterior posterior
SOAP	subjective, objective, assessment and plan
USA	United Space Alliance
WETF	Weightless Environment Training Facility

Contents

	page
Executive Summary	1
Section 1 Findings and Recommendations	4
1.1 Survey of EVA Training-Related Shoulder Injuries.....	4
1.1.1 Prevalence	4
1.1.1.1 Findings	4
1.1.1.2 Recommendations	4
1.2 Conditioning/Rehabilitation Medicine	4
1.2.1 Prevention – ASCR Supervision and EVA Workouts	4
1.2.1.1 Findings	4
1.2.1.2 Recommendations	5
1.2.2 Diagnosis and Treatment	6
1.2.2.1 Findings	6
1.2.2.2 Recommendations	6
1.2.3 Injury Reporting.....	7
1.2.3.1 Findings	7
1.2.3.2 Recommendations	7
1.3 Anthropometrics, Biomechanics and Suit Design/Fit.....	8
1.3.1 Suit Fit – Measurements	8
1.3.1.1 Findings	8
1.3.1.2 Recommendations	9
1.3.2 Suit Fit – Sizing.....	9
1.3.2.1 Findings	9
1.3.2.2 Recommendations	10
1.3.3 Suit Design – Scye openings and Body Seal Closures	10
1.3.3.1 Findings	10
1.3.3.2 Recommendations	11
1.3.4 Suit Fit – Padding and Harnesses.....	12
1.3.4.1 Findings	12
1.3.4.2 Recommendations	12
1.4 EVA – ASCAN, Skills and Mission Training	13
1.4.1 EVA Training.....	13
1.4.1.1 Findings	13
1.4.1.2 Recommendations	13
1.4.2 EVA Tools	14
1.4.2.1 Findings	14
1.4.2.2 Recommendations	14
1.5 EMU Injury Survey/Postdive Symptom Reporting.....	15
1.5.1 Symptom Reporting	15
1.5.1.1 Findings	15
1.5.1.2 Recommendations	15

Contents

(continued)

	page
Section 2 EMU Training-Related Shoulder Injuries: Epidemiology	16
2.1 Shoulder Injury Survey	16
2.2 Shoulder Injury Survey Results	17
Section 3 Classification of EVA Training Shoulder Injuries.....	24
3.1 Anatomy of the Shoulder Joint	24
3.1.1 Scapulothoracic Motion	26
3.1.2 The Rotator Cuff Muscles.....	27
3.1.3 Rotator Cuff Impingement.....	27
3.1.4 Early Diagnosis of Rotator Cuff Injuries	28
3.1.5 Tears of the Superior Labrum.....	29
3.2 Classification of EVA Training-Related Shoulder Injuries	30
3.2.1 Minor Shoulder Injuries	30
3.2.1.1 Anterior Shoulder and Chest Irritation	30
3.2.1.2 Superior Shoulder Pain	31
3.2.1.3 Posterior Shoulder and Back Irritation	32
3.2.2 Major Shoulder Injuries	32
3.2.2.1 Proposed Mechanism of Major EVA Training-Related Major Shoulder Injuries	32
3.3 Medical Effects of Inverted Body Positions During EVA Training.....	38
Section 4 Conditioning Programs to Prevent EVA Training Shoulder Injuries	40
4.1 ASCR Role and Supervision.....	40
4.2 EVA Workouts.....	41
4.3 Astronaut Participation	41
Section 5 Suit Modification to Prevent Shoulder Injuries	43
5.1 Anthropometric/Biomechanical Design of Shoulder Joint to Prevent Injury	43
5.2 Advanced Suit Design Considerations.....	47
Section 6 Suit Fit to Prevent EVA Training Shoulder Injuries.....	48
6.1 Optimizing Suit Fit to Prevent Shoulder Injuries	48
6.1.1 Background.....	48
6.2 Shoulder Padding and Load Alleviation	50
6.2.1 Background.....	50
6.2.2 Current Pad Configuration.....	50
6.2.3 EMU Shoulder Harness	52
6.2.4 Evaluations of Various Padding and Load Relief Combinations	52
6.3 Laser Scanning.....	53
6.3.1 Unsuiting Laser Scans	54
6.3.2 Suited Laser Scans	55
6.3.3 Merging of Wire Drawing of XL Planar HUT and Laser Scan	55
6.3.4 Laser Quantification of Shoulder Movement	56
6.3.5 Pressure-Mapping Systems.....	58

Contents

(continued)

	page
6.3.6 Laser Scanning Conclusions	58
Section 7 Task Modification to Prevent EVA Training Shoulder Injuries	59
7.1 Definition of EMU Work Envelope.....	59
7.2 ASCAN Training and EVA Skills	59
7.3 EVA Training (Documentation and Sequence)	59
7.4 Suit Familiarization in the NBL.....	60
7.5 Training in Inverted Orientation or Areas With Poor Accessibility	60
7.6 Frequency of Training in the NBL.....	62
7.7 Diver Assistance in the NBL	63
7.8 Use of Heavy Tools	63
7.8.1 Pistol Grip Tool.....	64
7.8.2 Torque Multiplier.....	64
7.8.3 Three-Point and Centerline Latch Tools.....	64
7.9 Development Runs	64
Section 8 Tool Modification to Prevent Shoulder Injuries	66
8.1 Optimizing Neutral Buoyancy of High-Fidelity Tools	66
Section 9 Surveillance Monitoring for Astronaut Injuries.....	68
9.1 NBL Postdive Survey	68
9.2 Integrated Medical Monitoring.....	68
9.3 Reporting Astronaut Medical Injuries.....	69
Section 10 Conclusions.....	70
Section 11 References.....	72
Appendix A, Shoulder Injury Tiger Team Subgroup Tasks:	75
Appendix B, Debrief Comments (Williams) on Shoulder Harness NBL Development Run January 17, 2003	78
Appendix C, Debrief Comments on Shoulder Harness NBL Development Run April 7, 2003	81
Appendix D, Mission Operations Directorate Survey Results	89
Appendix E, Crew Consensus Memo	90

Tables

Table 2-1 Survey Participant Demographic Data	17
Table 2-2 Conditioning Data.....	18
Table 2-3 Previous Shoulder and Neck Injuries.....	19
Table 2-4 Shoulder Pain and Neck Pain EVA Crew.....	20
Table 2-5 Shoulder Injury Data.....	21

Contents

(continued)

	page
Table 2-6 Possible Causal Mechanisms	22
Table 8-1 Tools Considered Likely to Cause Injury	66
 Figures	
Figure 2-1 EMU suit donning procedure	23
Figure 3-1 The relationship of the upper arm to the shoulder blade is shown.....	24
Figure 3-2 Subject demonstrating suited shoulder movements	25
Figure 3-3 Scapulothoracic motion of the shoulder joint.....	26
Figure 3-4 Muscles of the rotator cuff	27
Figure 3-5 Rotator cuff.....	27
Figure 3-6 Rotator cuff impingement	28
Figure 3-7 Rotator cuff tear.....	28
Figure 3-8 Area associated with painful arc syndrome.....	28
Figure 3-9 Anterior shoulder irritation immediately after an NBL run	31
Figure 3-10 Superior shoulder irritation within 24 hours after an NBL run.....	31
Figure 3-11 Posterior shoulder/back irritation immediately after an NBL run.....	32
Figure 3-12 Shoulder clearance between scye bearing joint and the LCVG	33
Figure 3-13 Restricted scapulothoracic motion	34
Figure 3-14 Lateral position of scye bearing joint	34
Figure 3-15 Vertical position of scye bearing joint	34
Figure 3-16 EMU HUT measurements	35
Figure 3-17 EMU Planar HUT inter-scye measurements	35
Figure 3-18 Position of scye bearing joint in XL vs. L HUT	37
Figure 3-19 Scye bearing joint restricting shoulder movement	38
Figure 6-1 Fit check in a donning stand.....	49
Figure 6-2 -335/-336 shoulder pad.....	51
Figure 6-3 -338 padding.....	51
Figure 6-4 Combination of -335/-336 and -338 padding.....	51
Figure 6-5 View of shoulder harness from top	52
Figure 6-6 Shoulder position at 0, 30, 60, 90, 120, and 150 degrees of shoulder abduction in unsuited subject.....	55
Figure 6-7 Shoulder geometry for 0, 45, 90, and 135 degrees of shoulder joint abduction while subject is wearing LCVG.....	55
Figure 6-8 Wire drawing of XL Planar HUT merged with laser scan of unsuited subject.....	56
Figure 6-9 Displacement of acromion, mid-clavicle and base of neck from laser scan data	57
Figure 6-10 Displacement of acromion process taken from laser scans.....	57
Figure 7-1 EVA work envelope	61
Figure 7-2 Ratio of NBL training for ISS missions	62

Executive Summary

The shoulder injury tiger team was created in December 2002 to evaluate the possible relationship between shoulder injuries and extravehicular activity (EVA) training in the Neutral Buoyancy Lab (NBL) at the Sonny Carter Training Facility. Since 1999, concerns have been expressed about the risk of shoulder injury associated with EVA training at the NBL, particularly in inverted body positions (McMonigal, 1999). Since July 2002, physicians at the NBL and the astronaut strength and rehabilitation coaches (ASCRs) have shared a growing concern about the risk of EVA training-related injuries (McCluskey, 2002). At the request of Dave Williams, then Director of the Space and Life Sciences Directorate, a meeting was held in August 2002 to review the data and concerns expressed by ASCRs. It was evident that the relationship between training in the extravehicular mobility unit (EMU) and shoulder injury was unclear, although speculation had begun about possible mechanisms of injury during EVA training. The attendees concurred that determining the prevalence of shoulder injuries in astronauts training for EVA and the possible mechanisms of injury were immediate priorities. This led to the development of a detailed survey of the astronaut office that was started in fall 2002 and was completed in January 2003.

By December 2002, it became clear that a tiger team would be required to fully understand all of the issues associated with this problem. Dave Williams and Allen Flynt, then Manager of the EVA Office, met and concluded that a comprehensive study by a tiger team representing the Flight Crew Operations Directorate (CA), Space and Life Sciences Directorate (SA), the Mission Operations Directorate (MOD), the EVA Office (XA), and the Engineering Directorate (EA) was warranted (Flynt, 2002).

An EMU Shoulder Injury Survey was developed and administered by Dave Williams to 42 astronauts and astronaut candidates. Twenty-two of these astronauts had participated in EVA training. The results of the survey document the suspected relationship between EVA training and the risk of developing shoulder injuries. While limited by sample size and the retrospective nature of the survey, the subjective reports and objective findings of shoulder injuries encountered during EVA training suggest a causal relationship between EVA training at the NBL and the observed injuries.

The tiger team developed a classification for EVA training-related shoulder injuries: minor (self-limited conditions requiring minimal medical intervention) or major (significant shoulder injuries requiring medical intervention or surgical correction). The primary factors contributing to minor injuries are:

- performing tasks in inverted body positions
- frequent NBL runs
- suboptimal suit fit
- lack of appropriate padding or load alleviation

Major shoulder injuries reflect the development of shoulder overuse syndromes from:

- limitations to normal shoulder mobility in the EMU Planar HUT
- inverted body positions
- performing overhead tasks
- repetitive motion
- heavy tools
- frequent NBL runs

In addition to the primary causes of shoulder injuries, this team also identified several secondary causes including problems with process and internal communication. These include poor communication between several of the organizations represented by this tiger team, inadequate documentation of proper requirements, constraints and caution notes as well as antiquated procedures for suit sizing, and training deficiencies.

It is now clear that the current design of the EMU Planar hard upper torso (HUT) shoulder joint increases the risk of shoulder injuries when performing overhead tasks, particularly those requiring inverted body positions. The possible mechanism of injury has been identified based upon tiger team assessments of the biomechanics of EMU shoulder joint movement and consultation with orthopedic surgeons. Due to the multi-factorial nature of the EVA training-related minor and major shoulder injuries, the findings and recommendations of the tiger team are wide-ranging in scope and complexity. Numerous findings and recommendations in this report have been made to prevent shoulder injuries and facilitate the early detection and treatment of injuries before they develop into overuse syndromes or shoulder tears requiring surgical therapy. In many cases, recommendations were implemented during the tiger team review to decrease the likelihood of shoulder injuries developing in the astronauts currently participating in EVA training.

The short- and long-term health consequences of shoulder injury to astronauts in training as well as the potential mission impact associated with surgical intervention in assigned EVA crew indicate that this is a critical problem that must be mitigated. Recommendations have been assigned to the relevant JSC Directorates and given suggested implementation dates. It is the expectation of this tiger team that each Directorate will review and implement these recommendations as discrete actions within their respective organization. The EVA Office will ultimately track the final resolution of all recommendations provided in this document.

Key elements in the risk mitigation of shoulder injuries associated with EVA training include accelerated development of the next-generation space suit or redesign of the EMU shoulder joint, reduction in high-risk NBL activities, optimization of suit fit, and continued emphasis on physical conditioning. Since a quick fix to the EMU design is not feasible and this is not the only issue associated with the continued use of the current EMU, prioritized funding should be allocated immediately to support the development of the next generation of space suit.

These development activities should incorporate the design of new suit soft goods, including upper torso, an area of immediate priority due to the frequency, severity, and diversity of injury associated with the current suit. In parallel or following the development of the new suit soft goods, the next-generation life support systems should be built. Following its development, the XL Planar HUT was rated unacceptable (U2) for permanent long-term use in an Astronaut Office Crew Consensus Review based on concerns about reach, access, and risk of injury (CB-00-061, 2000). While some of the recommendations in this report may reduce the interim risk of shoulder injury, a new suit design program must be implemented immediately to have a new suit available for ISS EVA within the next five years to reduce the likelihood of further injury to EVA astronauts.

Laser anthropometric studies of male and female astronauts, biomechanical analysis of shoulder joint motion in both genders, and use of computer-aided drafting (CAD) models of shoulder joint motion and EMU shoulder joint design should all be incorporated into the development of the next-generation space suit. Provision of the next-generation EMU will not entirely eliminate the risk of injury associated with EVA training. Sustained emphasis on avoiding inverted body orientations, developing neutrally buoyant high-fidelity tools, working within the design envelope of the EMU, and crew conditioning are also critical in reducing the risk of injury.

Section 1 Findings and Recommendations

1.1 Survey of EVA Training-Related Shoulder Injuries

1.1.1 Prevalence

1.1.1.1 Findings

- a. Twenty-two of the surveyed astronauts are participating or have participated in EVA training. This group averaged 43 years of age, is predominantly right-handed, and has an average height of 71 inches. Ninety-five percent of the group described themselves as athletic, either as a noncompetitive athlete, competitive athlete, or professional/national-level athlete.
- b. Sixty-four percent (14/22) of the surveyed EVA astronauts had experienced some degree of shoulder pain that they attributed to EVA training in the EMU.
- c. Fourteen percent (2/14) of the surveyed EVA astronauts with shoulder pain had injuries that required surgical treatment. Neither of these individuals had preexisting shoulder injuries.
- d. Thirteen percent (3/22) of the surveyed EVA astronauts are female and one reported minor shoulder pain training in the EMU.
- e. Forty-five percent (10/22) of the group had preexisting remote shoulder injuries, which had been treated surgically in two cases.
- f. The survey of EVA training-related shoulder injuries did not include all astronauts in EVA training.
- g. During the interviews with EVA astronauts, it became evident that training in the EMU may also result other types of injuries, including fingernail delamination, elbow pain, knee pain, foot pain, and peripheral nerve compression leading to transient loss of sensation in certain areas of the upper or lower extremity.

1.1.1.2 Recommendations

- a. A retrospective study of all types of injuries associated with EVA training should be conducted. SA / J. Davis – ECD 12/30/03

1.2 Conditioning/Rehabilitation Medicine

1.2.1 Prevention – ASCR Supervision and EVA Workouts

1.2.1.1 Findings

- a. All surveyed astronauts in EVA training reported exercising more than 3 to 4 times per week, with thirty-two percent of the group (7/22) exercising more than 5 times per week. They all participate in weight training, with twenty-five percent (5/20) having started weight training to prepare for EVA.

- b. ISS and Space Shuttle Program (SSP) medical operations requirements documents (MORDs) (SSP5260 Rev. B and SSP 13956) state that conditioning programs will be available to all spaceflight crewmembers and shall be scheduled in three periods of two hours per week. Crew participation is not monitored.
- c. Seventy percent (14/20) of surveyed EVA astronauts have ASCRs supervise their workouts and sixty percent have a specific EVA workout.
- d. Athletic workouts supervised by athletic trainers result in fewer training-related injuries and better outcomes than unsupervised athletic training.
- e. Forty-five percent (10/22) of surveyed EVA astronauts had preexisting shoulder injuries before EVA training.
- f. Thirty percent (3/10) of the astronauts with preexisting shoulder injuries reported that they were made worse by training in the NBL.
- g. Seventy-seven percent (17/22) of surveyed EVA astronauts perform rotator cuff strengthening exercises.
- h. Sixty-five percent (13/20) of surveyed EVA astronauts described their flexibility as average and 15 percent (3/20) as poor. Personal reports from some experienced EVA crew suggest they benefit from stretching prior to suit ingress.

1.2.1.2 Recommendations

- a. Ensure implementation of ISS and SSP MORD requirements for spaceflight crew physical conditioning. SA / J. Davis - Immediate
- b. Develop NASA requirements for scheduling EVA crew physical training for three periods of two hours per week for all phases of EVA training. SA / J. Davis – ECD 9/30/03
- c. Supplement requirements for scheduling crew physical training that are currently documented in the MORD with NASA requirements for spaceflight crew conditioning and document them at JSC. SD / J. Davis – ECD 9/30/03
- d. Astronauts in any phase of EVA training are expected to attend scheduled fitness assessments and physical training sessions. CB management should reassess the policy regarding astronaut compliance with scheduled training. CA / R. Cabana – ECD 9/30/03
- e. All astronauts at each stage of EVA training must have an assessment with an ASCR to develop an individualized EVA workout. Astronauts should be referred to a designated athletic trainer or a physical therapist for a functional shoulder assessment at least four weeks prior to starting astronaut candidate (ASCAN) EVA training, EVA Skills training, and Mission-Specific EVA training. SA / J. Davis – ECD 9/30/03
- f. Evaluate the shoulder flexibility of EVA crewmembers with a functional shoulder assessment and provide individualized recommendations regarding the need for flexibility exercises to minimize the risk of injury associated with HUT ingress. SA / J. Davis – ECD 9/30/03
- g. Document EVA-specific exercises (aerobic, strength, flexibility, rotator cuff) and make them available on line. SD / Completed 6/03

- h. Provide a presentation to the Astronaut Office on the benefits of ASCR-supervised athletic training and rehabilitation, with particular emphasis on conditioning strategies to reduce the risk of injury during EVA training. SA / J. Davis – ECD 9/30/03

1.2.2 Diagnosis and Treatment

1.2.2.1 Findings

- a. The NBL Physicians have begun questioning suited crew about recent orthopedic injuries during the predive physical examination.
- b. The NBL Physician conducts a postdive assessment poolside with photo-documentation of injuries as required.
- c. The NBL Physician may provide initial medical treatment if required during the postdive period. In some cases, astronauts are referred to the Flight Medicine Clinic (FMC) for follow-up and further treatment. Following referral to the FMC, the NBL Physician contacts a Flight Surgeon in the FMC to provide the relevant clinical information.
- d. The NBL Physician does not participate in the weekly “All Docs” meeting at the FMC.
- e. On occasion, astronauts self-treat NBL-related minor injuries with ice and over-the-counter medication. When symptoms are minor and respond to self-treatment, it is possible that the FMC is unaware that a problem developed or persisted after a run.
- f. When symptoms persist despite self-treatment, astronauts may visit the FMC for further diagnosis and treatment, or in some cases visit the ASCRs directly.
- g. Shoulder diagnostic ultrasound may be an effective tool for the early detection of rotator cuff tendonitis. Early use of non-invasive diagnostic tools could break the cycle of developing chronic overuse shoulder pain leading to rotator cuff tears.
- h. Either the treating ASCR or Flight Surgeon may initiate a referral for physical therapy of an injured astronaut. Flight Surgeons obtain orthopedic consults when needed and currently select consultants from a number of local experts.
- i. Consultant orthopedic surgeons may or may not have familiarity with the unique aspects of EVA training and mission operations.

1.2.2.2 Recommendations

- a. If clinically indicated, the NBL Physician and other physicians conducting medical evaluations of EVA crew prior to NBL training will perform a history and physical examination to detect unresolved shoulder symptoms/injuries. SA / J. Davis 9/30/03
- b. The NBL Physician will assess each astronaut following suited runs to evaluate possible overuse syndromes, injuries, and other medical issues in astronauts. They will arrange follow-up in the FMC for individuals if clinically indicated. SA / J. Davis 9/30/03
- c. The NBL Physician should participate in the weekly All Docs FMC Meetings to update the FMC physicians on EMU-related medical events at the NBL. SD / Completed February 2003

- d. The NBL Physician, Flight Surgeons, and ASCRs should receive additional training in the prevention, early diagnosis, and treatment of rotator cuff injuries. SA / J. Davis – ECD 9/30/03
- e. One orthopedic group with expertise in the management of overuse/athletic shoulder injuries should be selected as the primary consultant group for EVA astronauts. They should receive operational training to familiarize them with the EMU and the training environment at the NBL. SA / J. Davis – ECD 9/30/03
- f. In conjunction with orthopedic consultants, the FMC should formulate a diagnostic decision tree to provide early identification and treatment of shoulder injuries. SA / J. Davis – ECD 9/30/03
- g. A member of the ASCR team should perform a follow-up consultation with EVA crewmembers within 48 hours of performing an NBL run. SA / J. Davis – ECD 9/30/03

1.2.3 Injury Reporting

1.2.3.1 Findings

- a. The NBL Physician does not have access to the electronic medical record (EMR) used by the FMC.
- b. The EMR of a given astronaut may not contain clinical information obtained at the NBL unless entered by a Flight Surgeon in the FMC.
- c. ASCRs report at the weekly All Docs meeting on the condition of the astronauts they are treating. They have recently been given access to the EMR in the FMC for direct recording into the astronaut's medical record.
- d. The shoulder injuries associated with EVA training at the NBL have not been reported to OSHA or filed with State Worker's Compensation programs.
- e. A protocol/forum for inter-directorate communication of medical issues associated with operation of the EMU does not exist.
- f. The existing system for medical surveillance monitoring of injuries did not detect the problem of shoulder injuries sustained in astronaut EVA training.
- g. The Occupational Medicine and Test Support group are currently conducting a prospective study to identify EMU-related symptoms experienced by all astronauts training at the NBL.

1.2.3.2 Recommendations

- a. Incorporate ASCR Assessments and Interventions into the FMC EMR and provide updates to the Flight Surgeon weekly. SD / Completed 5/03
- b. Provide the NBL Physician with access to the EMR and ensure that medical assessments of astronauts at the NBL are incorporated into the EMR. SA / J. Davis – ECD 9/30/03
- c. Define and implement in the FMC a clear policy on reporting astronaut training injuries to OSHA. SD / Completed 6/03 R. McClusky

- d. Define and implement in the FMC a plan to optimize utilization of Worker's Compensation benefits and facilitate awareness of these benefits among eligible astronauts. SA / J. Davis – ECD 9/30/03
- e. The FMC should evaluate the efficacy of the existing medical surveillance system for detecting and reporting astronaut training injuries. SA / J. Davis – ECD 9/30/03
- f. Immediately implement an integrated system of recording EVA training-related symptoms and injuries. Track this information epidemiologically and report it monthly to the FMC. SA / J. Davis ECD 9/30/03
- g. Identify representatives from SA, XA, CA, and Safety & Mission Assurance (NA) to establish a team to review medical issues associated with the use of EMU hardware. This group shall establish a mechanism for disseminating information, assessing risks, and achieving consensus on medical issues associated with operation of the EMU and EMU-related hardware. Multi-directorate – XA Lead/ S. Doering with support from other directorates – ECD 9/30/03
- h. Now that a causal relationship between EVA training and specific types of shoulder injuries has been demonstrated, cases of EVA training-related shoulder injuries should be reported to OSHA. SA / J. Davis – ECD 9/30/03

1.3 Anthropometrics, Biomechanics, and Suit Design/Fit

1.3.1 Suit Fit – Measurements

1.3.1.1 Findings

- a. There is no NASA-approved sizing document levied on the EMU processing contractors. The most recent revision (now obsolete) does not include the Planar HUT or Space Suit Assembly enhancements.
- b. Errors can be introduced while manually taking anthropometric measurements.
- c. Measurements are taken by determining the distance between 'landmarks' on the body. The determination of where a landmark is can be subjective.
- d. Measurement errors, including tolerances, may occur and transcription errors can occur when recording measurements.
- e. Differences exist in the way the EMU processing organizations take measurements. Measurements are recorded in inches per procedures used by the Crew and Thermal Systems Division while they are recorded in centimeters at United Space Alliance (USA)/FCE.
- f. There are numerous controlled dimensions in the design and manufacture of the HUT, but none are directly relatable to crewmember measurements currently recorded. Standardized landmark-based measurements may not be sufficient to size the HUT for the crewmember.
- g. The descriptions of suit motions in NSTS 07700 (Figure 14.3.4.3-2, STS Space Suit Joint Mobility Range Specifications for 4.3 psig) do not match the anatomical descriptions of the same motions. These incorrect descriptions are flowed into lower-level requirements

(i.e., SVHS 7800 and the Space Suit Assembly specification and analysis documents [S/ADs]). Incorrect or inconsistent terminology can lead to confusion.

1.3.1.2 Recommendations

- a. Develop and implement a full-body laser scanning protocol for astronauts participating in EVA training. Provide data for suit sizing. SA/ J. Davis – ECD 12/30/03
- b. Revise NSTS 07700 and lower-level documents to accurately reflect medical terminology with respect to body motions. XA / S. Doering – ECD 9/30/03
- c. Develop a NASA integrated astronaut anthropometric database for sizing the EMU, the Advanced Crew Escape suit, and any other pressure or partial-pressure suit. SA / Jeff Davis – 12/30/04

1.3.2 Suit Fit – Sizing

1.3.2.1 Findings

- a. The initial suit sizing process is based on the assumption that astronauts who fit a given size Pivoted HUT will fit the same size Planar HUT. For the majority of the astronauts, this is an effective sizing technique. Some astronauts found that decreasing HUT size when transitioning from Pivoted to Planar HUT resulted in an improved fit.
- b. The existing HUT sizing process uses chest breadth, bi-deltoid breadth, chest circumference, expanded chest depth, head length, and head breadth. A computer algorithm uses this data to size a crewmember in a Pivoted HUT. The HUT sizing process does not include clinically relevant dimensions such as bi-acromial breadth and shoulder circumference. These dimensions are useful in minimizing the restriction of scapulothoracic motion by optimizing the location of the scye bearing joint.
- c. The human body changes shape over time. If a significant period has elapsed between the time a crewmember is measured and the time they are sized for a suit, their body could have changed and they could receive a poor suit fit.
- d. Current EMU sizing techniques do not account for how the human body fills individual suit components. Current sizing is based on linear measurements. Instead, it should consider both linear and volumetric measurements to optimize suit fit.
- e. There is no objective method to assess how well a given suit fit allows the crewmember to operate in the primary EMU work envelope.
- f. The suit sizing process uses a computer algorithm for initial suit sizing. After the initial suit fit check, space suit assembly sizing changes are incorporated based on suit fit comments from the crewmember.
- g. The suit sizing algorithm, which was developed for the Pivoted HUT two decades ago, does not include all relevant measurements for fitting the crew and does not reflect the sizing requirements for the Planar HUT.
- h. Optimum 1 G suit fit does not necessarily correlate with optimum 0-G suit fit. In microgravity, a 5 – 7 cm elongation of the spinal column occurs. Fluid shifts and changes in body position within the suit also occur on orbit.

- i. The Planar HUT is the current flight-certified configuration of the EMU. To optimize suit fit to reduce the risk of shoulder injury, some astronauts prefer the option of training in the Pivoted HUT—a non-flight-certified configuration.

1.3.2.2 Recommendations

- a. Develop new suit sizing constraints, requirements, and processes based upon the findings in this document and other issues identified within the EMU program (i.e. boot fit, 0-G growth). The new sizing process shall determine the need for additional anthropometric measurements for both genders. XA / S. Doering – ECD 12/30/03
- b. Reinstitute the EMU Sizing Document and update it to reflect the latest configuration of space suit assembly hardware, suit sizing requirements and utilization of laser scanning. This document shall be Class 1 controlled by NASA. XA / S. Doering – ECD 3/31/04
- c. Review and change accordingly the suit-sizing algorithm to reflect latest configuration and constraints. This algorithm should access the laser-scan database to obtain anthropometric measurements and utilize the latest documented sizing constraints and requirements. Documentation of this algorithm shall be a deliverable to NASA. XA / S. Doering – ECD 3/31/04
- d. Develop a fit check procedure that includes an objective assessment of functional mobility in the primary work envelope as defined in NSTS 07700, Vol. XIV, Appendix 7. XA / S. Doering – ECD 12/30/03
- e. Assess updating the primary work envelope as defined in NSTS 07700, Vol. XIV, Appendix 7 based on latest current suit fit and population. XA / S. Doering – ECD 12/30/03
- f. Conduct additional studies to accurately characterize spinal elongation in 0 G. Formally assess other factors affecting suit fit in microgravity. SA / J. Davis – 9/30/03
- g. Due to significant individual variability, conduct a detailed test objective [DTO] to obtain spaceflight-adapted measurements of spinal elongation, expanded chest circumference, and other relevant measurements. SA / J. Davis – ECD Long Term
- h. Develop appropriate processes and constraints for utilization of non-flight-configuration EMU hardware in NBL training. XA/ S. Doering - ECD 9/30/03

1.3.3 Suit Design - Scye openings and Body Seal Closures

1.3.3.1 Findings

- a. The sizing requirements for the basic design of the Pivoted HUT included five sizes (XS, S, M, L, & XL) to fit the 5th to 95th percentile anthropometric standards (American male and female). Ultimately, only four sizes were built (XS was dropped).
- b. The position and orientation of the Pivoted HUT scye openings was optimized, based on fit checks of the existing astronaut corps, to accommodate the largest segment of the population possible.
- c. To prevent four Criticality 1 potential failures and eliminate two limited life items in the Pivoted HUT a redesign of the HUT was initiated.

- d. During the development of the Planar HUT, the bellows and gimbal features of the Pivoted HUT were deleted to eliminate the Criticality 1 failure modes. This reduced the shoulder mobility and don/doff envelope of the HUT slightly. To recover the lost mobility and to maximize the don/doff envelope, the position and orientation of the scye openings were further optimized.
- e. The Planar HUT development program was originally planned to replace the four Pivoted configurations with four Planar configurations. Due to budget constraints, only two HUT sizes (M & L) were built. The XL HUT was developed after the planar program was well into production when the budget and a need for accommodating a larger anthropometric range of astronauts were identified.
- f. The Planar HUT design uses a standardized body seal closure and scye bearing size that are common to the medium, large, and extra large HUTs. The size of these components restricts don/doff and mobility envelopes, and can increase the risk of shoulder injuries in some crewmembers.
- g. The Planar HUT shoulder design restricts the normal scapulothoracic motion of the shoulder joint, resulting in rotator cuff impingement in certain arm positions.
- h. The Planar HUT increases the internal rotation of the crewmember's shoulder joint more than the Pivoted HUT, possibly destabilizing the shoulder and limiting the range of motion in certain arm positions.
- i. Development, certification, and retrofit/replacement of the current fleet of Planar HUTs would cost between \$5-\$15M, depending on complexity of changes and would take between 4-5 years to implement.
- j. The risk of EVA training-related shoulder injury can be reduced but not eliminated by redesigning the Planar HUT shoulder joint. Eliminating the risk of shoulder injury requires an integrated approach combining suit redesign with optimized tools, tasks, and crew conditioning.

1.3.3.2 Recommendations

- a. NASA management should review the need to reduce the risk of EVA training-related injury by funding the development of the next-generation EMU concurrent with other Agency priorities for the next-generation space suit. XA / S. Doering – ECD 12/30/03.
- b. Laser anthropometric studies of male and female astronauts, biomechanical analysis of shoulder joint motion in both genders, use of CAD models of shoulder joint motion and EMU shoulder joint design should all be incorporated into the development of the next-generation space suit. XA / S. Doering – Long Term Action
- c. Anthropometric, biomechanical, and suit fit data as well as the lessons learned by suit engineers, NBL physicians, ASCRs, and astronauts should be incorporated into the next-generation space suit. XA / S. Doering – Long Term Action
- d. Biomechanical engineers, kinesiologists, and orthopedic specialists should participate during the design phase of future suit designs to best optimize the suit fit from an ergonomic perspective. XA / S. Doering – Long Term Action

- e. Future suit designs need to consider alternate concepts for donning and doffing the suit, such as a rear-entry used in the Orlan, Mark III, and H-suits. XA / S. Doering – Long Term Action

1.3.4 Suit Fit - Padding and Harnesses

1.3.4.1 Findings

- a. Use of padding and harness configurations within the suit have not been consistent among crewmembers over time. Crewmembers are not adequately educated on different padding configurations available. They have not been aware of the option to use the harness within the HUT for the last 14-15 years. A formal review of padding design was not performed with the introduction of Planar HUTs.
- b. Inexperience with the shoulder harness for the last 14-15 years during NBL training means that astronauts, suit engineers, and technicians are unfamiliar with this hardware.
- c. Testing the shoulder harness and various shoulder pad configurations suggests that the combination of the two can be effective in reducing the loading of the scye bearing joint on the crewmember's shoulders. No single combination of the shoulder harness and liquid cooling and ventilation garment (LCVG) pads will work for all astronauts. Selection of load alleviating devices and padding configurations must be based upon crew preference. Use of these items does not appear to significantly impair mobility in the suit and ultimately affect training.

1.3.4.2 Recommendations

- a. Update the crew options document and processes to ensure consistent identification and training for crew options. This includes the variety of LCVG pads, the shoulder harness, socks, thermal slippers, boot sizing inserts, etc. Elevate the document to JSC level (currently a USA Engineering document.) XA / S. Doering – ECD 12/30/03
- b. Conduct a formal review of pad and harness design to reassess the current design and optimize these with consideration for the Planar HUT and shoulder injury issues. XA / S. Doering – ECD for recommended changes 9/30/03, ECD for implementation of changes 12/30/03
- c. Conduct awareness training of the shoulder harness and initiate updates to the design to improve fit and load alleviation capability. XA / S. Doering – ECD 9/30/03
- d. The EVA Branch in association with the suit engineers should develop a standardized suit fit briefing reflecting the lessons learned by experienced EVA astronauts and suit engineers. This briefing should include the rationale for selecting various crew options and the operational aspects of optimizing suit fit prior to starting ASCAN and EVA skills training. This brief should be incorporated into the ASCAN and EVA skills training flow. CA / R. Cabana 9/30/03

1.4 EVA – ASCAN, Skills and Mission Training

1.4.1 EVA Training

1.4.1.1 Findings

- a. NBL lesson plans do not specify the limits on tasks requiring inverted body orientations, use of heavy tools, or the need to perform tasks in the nominal EMU work envelope.
- b. NBL lesson plans do not have specific information on the need to warn crews not to overexert themselves, and there are no defined rules for inverted operations, the use of heavy tools, or specific cautions regarding overhead operations.
- c. Current lesson objectives for initial NBL runs in ASCAN EVA training are task-focused. Providing a functional fit check and assessments of an adequate weigh out are not formal initial lesson objectives.
- d. The NBL training ratio has historically exceeded 10 to 1. The maximum number of runs typically performed by any one crewmember in a week is three.
- e. There does not appear to be a formal “look ahead” evaluation in place for identifying NBL mock-up configurations that may decrease the need for inverted operations and/or create other worksite accessibility issues. This is done by each MOD flight lead on a case-by-case basis.
- f. Certain hardware designs and tasks force crews to overextend their arms and perform duties outside of a nominal EMU work envelope.

1.4.1.2 Recommendations

- a. NBL lesson plans need to be updated to address the following: NBL/Suit mobility familiarization (first NBL run) including a functional fit check, constraints and information related to inverted operations, use of heavier tools (cautions, hold time constraints), need for diver assistance, cautions to be expressed to crew to limit general overexertion and for specific tasks that are historically difficult. DA/ J. Harpold - ECD 9/30/03
- b. ASCANs in EVA training and astronauts in EVA Skills training should be provided with lessons learned from experienced crewmembers with respect to suit fit and operations in NBL. These lessons learned should be documented (i.e. EVA Standard Operation Procedures). EVA instructor astronauts should familiarize themselves with training plans and future training plan updates. CA/ R. Cabana ECD - 12/30/03
- c. Guidelines for allowable frequency of runs any one crewmember can perform in a week (or within a meaningful time period) should be developed and documented. This action shall be coordinated with SD and XA. DA/ J. Harpold ECD - 9/30/03
- d. At NBL mock-up configuration review an assessment of the configurations and other scheduled configurations should be performed to ensure inverted operations are minimized. Update work instructions as appropriate. DA/ J. Harpold ECD - 9/30/03
- e. PDR and CDR reviews for flight hardware should incorporate specific evaluation criteria for assessing whether inverted body orientations are required for training in the NBL and if the tasks may be completed within the nominal EMU work envelope. Assessments to

work instructions, general design requirements and other policy handbooks should be performed. XA/ S. Doering – 12/30/03

- f. Criteria for allowable frequency and duration of inverted training for EVA need to be established, documented, and implemented. These criteria should include minimum rest times between inverted sessions. SA / J. Davis – 9/30/03
- g. Update documentation (i.e. crew consensus form) to ensure evaluation of task and hardware during development NBL runs will include an assessment of the crewmember's capability to perform the task within the specified work envelope. DA / J. Harpold – 9/30/03
- h. Update the appropriate policy and/or work instruction to require NBL Physicians, or their delegates, to record and monitor all planned inverted training performed during all NBL activities. Monitors shall be responsible for informing the test director when constraints established may be violated. SA / J. Davis – 9/30/03
- i. Update the appropriate policy and/or work instruction to establish test protocol rules for adhering to sustained inverted training criteria. DA / J. Harpold – 10/30/03

1.4.2 EVA Tools

1.4.2.1 Findings

- a. Frequent use of heavy tools outside of the nominal work envelope in the NBL increase the risk of shoulder injury.
- b. There are no generic requirements with respect to buoyant tool weight for use in the NBL.
- c. Weight of certain high-fidelity NBL tools and the frequency of use suggest that certain NBL tools should be lightened while retaining “look and feel” of the flight-like units.

1.4.2.2 Recommendations

- a. A reevaluation and redesign of high-fidelity tools should be pursued with the objective of reducing weight while retaining functionality and flight-like “look and feel.” XA/ S. Doering – 12/30/03
- b. Use of the heavy tools noted in this report need to be minimized and use of diver assistance to support heavy tools encouraged. DA / J. Harpold – Immediate.
- c. Future NBL training tool development (all handheld tools) should require tools to be neutrally buoyant. This should be documented in the appropriate work instructions and/or general design requirements. XA / S. Doering – 9/30/03
- d. If heavy tools must be utilized, the test subjects, crews, divers, and trainers must be more formally warned on the dangers with respect to overstressing the shoulder joint. Appropriate documentation (work instructions) for MOD instructors, test conductors and dive supervisors should be updated to provide caution statements, if they don't already exist. DA / J. Harpold – 9/30/03

1.5 EMU Injury Survey/Postdive Symptom Reporting

1.5.1 Symptom Reporting

1.5.1.1 Findings

- a. Data collected via the observational study to identify EMU suit-related symptoms experienced by all astronauts in training at the NBL has the additional benefit of providing immediate insight into issues as they develop. Feedback to the FMC will enhance awareness of the medical issues associated with EVA training.

1.5.1.2 Recommendations

- a. After conclusion of the observation study in 2004 a permanent post dive surveillance program must be maintained. SA / J. Davis – Long Term Action (prior to conclusion of post dive study)

Section 2 EMU Training-Related Shoulder Injuries: Epidemiology

2.1 Shoulder Injury Survey

The first concerns about the possible relationship between shoulder injuries and EVA training arose in June 2002 among the ASCRs who were treating a number of astronauts for musculoskeletal complaints. At the same time, Dr. Rick McCluskey conducted a review of FMC charts to determine the incidence of injuries to EVA crew during training at the NBL. He reviewed the medical records, ASCR records and waiver issuances of every astronaut who performed an EVA from STS-82 (1997) to STS-111 (2002). This included 38 EVA astronauts on 46 missions. The results (McCluskey 2002) indicated:

- Medical records in the FMC revealed entries for four astronauts consistent with NBL-related injuries, of which only two were likely attributable to NBL training.
- No cases of shoulder injuries were found documented in the medical records of EVA crew training at the NBL from 1997 to 2002.
- The ASCR records, described 16 cases of musculoskeletal complaints possibly related to NBL activities.
- Eleven of the 16 astronauts on the ASCR list were being treated for shoulder problems.

In August 2002 Dave Williams, then Director of the Space and Life Sciences Directorate requested a formal survey of the EVA astronauts to determine the nature and magnitude of the problem.

Between September and November 2002, Dr. Williams developed a series of computerized questions for astronauts in EVA training and non-EVA astronauts after his reassignment to the Astronaut Office. The survey was designed to determine the prevalence of shoulder and neck injuries in non-EVA and EVA astronauts, evaluate the relationship between EVA training and the risk of shoulder and neck injury and to determine the role of physical conditioning in preventing injury. Expedited Institutional Review Board approval for the survey was obtained from the Chair of the Board in September 2002. Beta testing of the computerized questionnaire was conducted in October. This testing revealed a number of technical and potential compliance issues with the computerized version of the survey that led to the decision to conduct two surveys. The first electronic survey was a short series of demographic and physical conditioning questions that was distributed to 20 non-EVA astronaut volunteers. Twenty-two EVA astronauts completed a longer detailed questionnaire that included the shorter version with additional questions about EVA training-related shoulder and neck injuries during a face-to-face scheduled meeting with the investigator.

Data collection and analysis was completed by January 30, 2003.

2.2 Shoulder Injury Survey Results

Data was collected from 42 volunteer astronauts of the 104-member astronaut corps during the study (Refer to Table 2-1). It was not possible to personally interview each astronaut currently in EVA training and the data presented reflects the random selection of EVA astronauts at different levels of training. Five of the 11 astronauts treated by the ASCRs for shoulder problems were included in the study. The tiger team co-chairs did not have access to information to determine whether the other six astronauts in treatment have shoulder injuries related to training at the NBL. Further epidemiologic studies to determine the prevalence of EVA training-related shoulder injuries in all EVA astronauts are warranted.

The study group was almost equally divided between the non-EVA crew and the EVA crew. The two groups are very similar in age although the EVA group tends to be slightly taller and heavier than the non-EVA group. Right hand dominance was noted in both groups. While ambidextrous astronauts are more prevalent in the EVA group, the small sample size limits the conclusions that may be drawn from this observation.

The number of female subjects in the study is small with similar numbers of female non-EVA and EVA crew. One of the female EVA astronauts reported problems with minor shoulder pain during their training.

Table 2-1 Survey Participant Demographic Data

Demographic Data	All Participants	%	Non-EVA Crew	%	EVA Crew	%
Total Number Participants	42		20	47.6%	22	52.4%
Average Age	42.1		41.1		43.0	
Average Height	70.3		69.6		71.0	
Average Weight	175.3		172.2		178.2	
Ambidextrous	3	7.1%	0	0.0%	3	13.6%
Right Handed	36	85.7%	18	90.0%	18	81.8%
Left handed	3	7.1%	2	10.0%	1	4.5%
Male	35	83.3%	16	80.0%	19	86.4%
Female	7	16.7%	4	20.0%	3	13.6%

Physical conditioning is an important determinant of reduced susceptibility to injury, particularly when trained therapists supervise physical fitness programs (Mazetti et al. 2000, George 1997, Moynes 1983, Kibler and Chandler 1994). The second section of both questionnaires sought to determine the frequency of participation in physical conditioning programs, the number of astronauts utilizing ASCRs, and the number participating in weight training and rotator cuff strengthening exercises (Refer to Table 2-2.).

It is possible that the data collected from the surveyed astronauts reflects the best-case scenario and that actual participation in conditioning programs may be less than the data indicates. The

majority of astronauts in the study group exercise more than three times per week with 30%-40% exercising five or more times per week. The majority of the surveyed astronauts participate in weight training. This is clearly a priority among EVA crew, where 100% of the surveyed astronauts reported participating in weight training. In some cases, EVA crew started weight training to help them prepare for EVA.

Although EVA crew prefer to use the ASCRs to help supervise their workouts, 30% of EVA crew and 70% of non-EVA crew do not regularly use one. It is not surprising that 95% of non-EVA astronauts do not have a specific EVA workout. It is of interest that 22% of EVA astronauts surveyed do not have a specific EVA workout.

The majority of EVA astronauts describe their flexibility as poor to average, with only 20% reporting excellent flexibility. Upper-extremity flexibility was felt to be particular important to reduce the probability of injury during HUT ingress. One experienced astronaut with a remote, non-EVA-related shoulder injury emphasized the importance of performing stretching exercises immediately prior to HUT ingress. This may be of benefit to some astronauts and present a risk to others. A functional shoulder assessment by an athletic trainer or physical therapist is required to determine the best, individualized techniques for HUT ingress and to prevent EVA astronauts with shoulder laxity from performing stretching exercises that could increase their risk of shoulder injury.

Table 2-2 Conditioning Data

Conditioning Data	All Participants	%	Non-EVA Crew	%	EVA Crew	%
Frequency of Exercise						
Do Not Exercise	0	0.0%	0	0.0%	0	0.0%
Rarely Exercise	0	0.0%	0	0.0%	0	0.0%
1-2x/wk	1	2.4%	1	5.0%	0	0.0%
3-4x/wk	26	61.9%	11	55.0%	15	68.2%
>5x/wk	15	35.7%	8	40.0%	7	31.8%
Weight Training Part of Workouts:	39	92.9%	17	85.0%	22	100.0%
Average Duration Weight Training (yrs):	11.4		11		11.7	
Workouts ASCR Supervised:	20	50.0%	6	30.0%	14	70.0%
Started Wt Training to Prepare for EVA:	7	18.9%	2	11.8%	5	25.0%
Specific EVA workout:	15	40.5%	1	5.3%	14	77.8%
Rotator Cuff Exercises:	22	52.4%	5	25.0%	17	77.3%
Poor Flexibility:	6	15.0%	3	15.0%	3	15.0%
Average Flexibility:	27	67.5%	14	70.0%	13	65.0%
Excellent Flexibility:	7	17.5%	3	15.0%	4	20.0%

The primary goal of the survey was to try to understand the correlation between shoulder injury and participating in EVA training at the NBL. When the surveyed astronauts were asked about previous diagnosed or undiagnosed shoulder injuries to determine the prevalence of preexisting shoulder injuries, 45% of all participants reported at least one previous shoulder injury (Refer to Table 2-3).

The prevalence was similar in non-EVA and EVA astronauts. Of the ten EVA astronauts with preexisting shoulder injuries, three mentioned that training in the NBL made their injuries worse. In general, astronauts with preexisting shoulder injuries had a high level of awareness about activities and movements that could aggravate their injury and a number had specific techniques they use in the NBL to reduce the probability of shoulder injury during training.

The prevalence of preexisting neck injury is less than shoulder injuries, with a trend for a slightly higher prevalence in EVA astronauts. There were no reports of previous neck injuries made worse by EVA training, nor were there any reports of neck injuries during EVA training at the NBL in the study group.

Table 2-3 Previous Shoulder and Neck Injuries

Previous Shoulder Injuries	All Participants	%	Non-EVA Crew	%	EVA Crew	%
Number With No Previous Shoulder Injuries:	23	54.8%	11	55.0%	12	54.5%
Number With Previous Shoulder Injuries:	19	45.2%	9	45.0%	10	45.5%
Previous Neck Injuries						
Number With No Previous Neck Injuries:	34	81.0%	17	85.0%	17	77.3%
Number With Previous Neck Injuries:	8	19.0%	3	15.0%	5	22.7%

Astronauts progress through several stages of EVA training, ranging from initial familiarization as ASCANs, followed by participation in the EVA Skills program to be eligible for assignment as an EVA astronaut. The majority of the EVA crew interviewed had completed ASCAN EVA training and the EVA Skills program (Refer to Table 2-4). Nine (41%) of the more experienced EVA astronauts in study group had not participated in EVA Skills training as the program was not in existence prior to their assignment to one or more EVA missions.

Both EVA skills and mission-specific EVA training, as well as participation in EVA development runs, present astronauts with a much greater physical and technical challenge than that previously experienced during ASCAN EVA training. Currently, the complex ISS and Hubble Space Telescope (HST) EVAs require a high level of technical proficiency to successfully accomplish mission objectives. Participation in these training flows and in development runs frequently challenges the EVA astronaut by requiring them to work in unusual or inverted body orientations in the NBL, often performing tasks outside the nominal EMU workspace with heavy tools.

These physical demands place the experienced EVA astronaut at increased risk of shoulder injury (Refer to Table 2-4), as the number of crew reporting shoulder pain during EVA training increased from ASCAN (0%) to contingency (11%), development runs (37%), EVA skills (45%) to mission assigned training (56%).

Table 2-4 Shoulder Pain and Neck Pain EVA Crew

	EVA Crew	%
Total Number Participants:	22	
ASCAN EVA Training In Progress:	1	4.5%
ASCAN EVA Training Completed:	21	95.5%
Shoulder Pain During ASCAN EVA Training:	0	0.0%
Neck Pain During ASCAN EVA Training:	0	0.0%
EVA Crew Participating in Contingency Training:	9	40.9%
Shoulder Pain During Contingency EVA Training:	1	11.1%
Neck Pain During Contingency EVA Training:	0	0.0%
EVA Crew Participating in Development Runs:	20	90.9%
Shoulder Pain During Development Runs:	7	36.8%
Neck Pain During Development Runs:	0	0.0%
EVA Skills Training Not Started:	2	9.1%
EVA Skills Training In Progress:	2	9.1%
EVA Skills Training Completed:	9	40.9%
EVA Skills Training Grandfathered:	9	40.9%
Shoulder Pain During EVA Skills Training:	5	45.5%
Neck Pain During EVA Skills Training:	0	0.0%
EVA Crew Participated in Mission Training:	16	72.7%
Shoulder Pain During Mission EVA Training:	9	56.3%
Neck Pain During Mission EVA Training:	0	0.0%

There were 23 episodes of shoulder pain reported in 14 of the 22 EVA astronauts (63%) at various times during their NBL training (Refer to Table 2-5). Detailed data was collected on 19 of the 23 episodes. Shoulder pain during an EVA on orbit has been reported in 2 of the astronauts who had known recent shoulder injuries prior to flight. One of these shoulder injuries was not related to EVA training and the other was most likely due to an overuse syndrome associated with EVA training.

Table 2-5 Shoulder Injury Data

Shoulder Injury Data		
Total Crew Reporting EVA Related Shoulder Injury:	14	63.6%
Episodes of Reported Pain:	23	
Shoulder Pain During ASCAN Training:	0	0.0%
ShoulderPain/Injury During EVA Skills:	5	45.5%
ShoulderPain/Injury During Development Runs:	7	38.8%
ShoulderPain/Injury Scheduled EVA Mission Training:	9	56.3%
Shoulder Pain/Injury During Mission EVA	2	18.2%
Both Shoulders Affected:	13	68.4%
Left Shoulder Affected:	0	0.0%
Right Shoulder Affected:	6	31.6%
Onset of Pain During Run:	11	57.9%
Onset of Pain Within 24 Hours of Run:	8	42.1%
Inverted Position Suspected Cause:	5	26.3%
Planar HUT Suspected Cause:	3	15.8%
Heavy Tools Suspected Cause:	1	5.3%
Multiple Factors Suspected Cause:	8	42.1%
Duration of Pain < 24 hours:	4	22.2%
Duration of Pain 24-48 hours:	6	33.3%
Duration of Pain 48 hours - 7 days:	6	33.3%
Duration of pain 7 – 14 days:	1	5.6%
Chronic Pain:	1	5.6%
Pain at Night:	10	55.6%
Average Intensity of Pain (5 Worst Pain Ever Experienced):	2	
Surgical Treatment Required:	2	14.3%
Modified LCVG Padding or Suit Fit to Prevent Pain:	8	44.4%

The typical episode of shoulder pain associated with EVA training at the NBL is described as a moderate (2/5 on pain scale) dull ache over the top of the shoulder or within the shoulder joint that started either during the NBL run or within 24 hours following the run. Both shoulders are frequently affected (68%) although the pain may be isolated to the dominant shoulder in 31% of the cases. The pain usually lasts less than a week. It is typically treated with a combination of rest, ice, massage, and non-steroidal anti-inflammatory drugs [NSAIDs] either in non-prescription or prescription strength. One individual reported chronic shoulder pain related to EVA training.

Nocturnal pain, attributable to inflammation or damage of the rotator cuff tendon or muscle, was reported in 55% of the astronauts with shoulder pain. Both astronauts requiring surgical repair of shoulder injuries from EVA training reported nocturnal pain. Approximately half of the

individuals had tried different combinations of shoulder padding or changed their suit fit in an attempt to prevent shoulder pain during EVA training.

The maximum frequency of NBL training is typically three, 6-hour runs in a 5-day workweek. This provides approximately 48 hours between runs for astronauts to physically recover and prepare for the next run. If an astronaut develops shoulder pain during or after the first run, the pain will resolve within 48 hours in 55%, with symptomatic recovery prior to the second run. Forty-five percent of the astronauts that develop shoulder pain during a run may have persistent pain 48 hours after the run. If they participate in a second run with residual symptoms, it is likely that increased injury will occur, leading to a risk of chronic overuse injury if this cycle continues.

Three of the astronauts in the study group have had surgery for shoulder injuries however only two of these are considered EVA training-related, as the third astronaut had sustained shoulder injuries in a fall. Neither of the two cases of EVA training-related shoulder injury had a previous history of shoulder injuries prior to EVA training.

It is difficult to irrefutably establish a causal relationship between the suspected causes of shoulder injury subjectively reported by EVA astronauts in the type of retrospective study that was conducted. The onset of shoulder pain during or within 24 hours of an NBL run strongly suggests a causal relationship in which some activity during the run precipitated the shoulder pain. Repeated episodes of shoulder pain during training suggest the evolution of overuse syndromes that could ultimately lead to lesions requiring surgical repair. To determine the possible contributing factors that could be causally related to shoulder pain/injury, the EVA astronauts were asked to choose from a list of potential causal factors. They were asked to add items that were not on the list where necessary, and their personal comments were documented.

Data was obtained on suspected causal mechanisms in 17 cases of EVA training-related shoulder pain (Refer to Table 2-6). In 8 of these cases, 22 multiple causes were listed in 7 different categories resulting in a total of 31 suspected causes. These are rank ordered in the table below.

Table 2-6 Possible Causal Mechanisms

	EVA Crew	%
Inverted Position Suspected Cause:	8	25.8%
Planar HUT Suspected Cause:	7	22.6%
Repetitive Motion:	6	19.4%
Heavy Tools Suspected Cause:	5	16.1%
Frequent NBL Runs:	2	6.5%
Specific Arm Position:	2	6.5%
EMU Donning:	1	3.2%

Inverted body positions were reported as the most likely suspected cause for shoulder injuries, with the design of the planar HUT shoulder joint identified as the second most likely contributor. Repetitive motion, heavy tools, frequent NBL runs, and specific arm positions (overhead) were

all felt to contribute additional risk of injury. EMU donning requires a series of upper-extremity movements that at least one astronaut felt presents a risk of injury (Refer to Figure 2-1). One of the astronauts requiring surgical repair of a rotator cuff tear specifically recalls performing a task with the heavier, high-fidelity pistol grip tool (PGT) that resulted in shoulder pain.

This data may be used to develop a set of criteria to categorize NBL tasks into those associated with a high risk of injury and those associated with a low risk. High-risk tasks are those performed inverted that are at the upper limit, or outside, the work envelope requiring overhead reach with a heavy tool, or requiring prolonged repetitive motion such as using a manual tool. Low-risk tasks are those that may be completed with an upright body orientation, within the work envelope of the suit, using neutrally buoyant tools.

The design of the planar HUT shoulder joint is another significant factor contributing to the risk of injury during EVA training. An integrated approach to mitigating the risk of shoulder injury requires a combination of reducing the number and frequency of high-risk tasks with redesigning the planar HUT shoulder joint. Achieving the goal of lowering the risk of injury associated with EVA training to a level as low as reasonably achievable requires prioritized allocation of resources to address the recommendations outlined in this document.



Figure 2-1 EMU suit donning procedure. The arms of the suit have been removed to illustrate the range of the shoulder and arm motion required for HUT ingress.

Section 3 Classification of EVA Training Shoulder Injuries

3.1 Anatomy of the Shoulder Joint

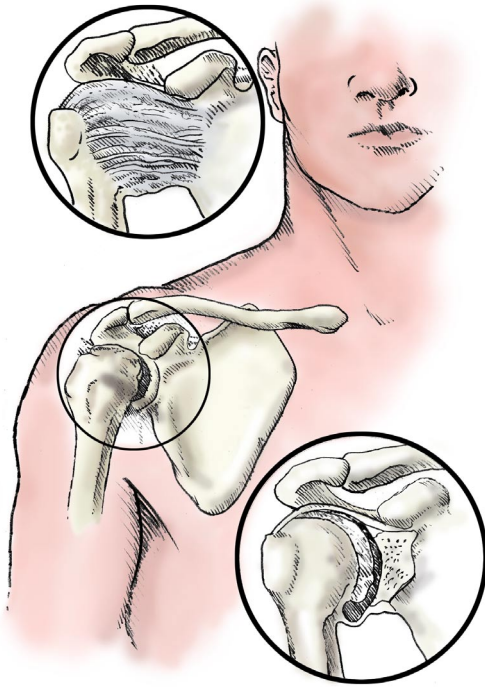

Figure 3-1 The relationship of the upper arm to the shoulder blade is shown.

The shoulder joint is a ball and socket joint created by the spherical head of the humerus (the ball) interacting with the glenoid cavity of the scapula (the socket). Unlike the hip, which is a stable joint having deep support from the acetabular (hip) socket, the shoulder is a very mobile joint with a shallow surface on the glenoid cavity. It has been likened to a basketball resting on top of a shallow plate. A cartilaginous soft rubber-like rim called the glenoid labrum deepens the shallow surface of the glenoid cavity. The labrum helps contribute to the stability of the shoulder by deepening the socket, and helps to cushion compression across the socket. The upper arm is suspended from the scapula (shoulder blade) by soft tissue, muscles, ligaments, and a joint capsule with only minimal bony support (Refer to Figure 3-1).

The stability of the shoulder joint is due to the action of a group of muscles called the rotator cuff, which hold the humeral head in contact with the glenoid cavity. These muscles work in a closely coordinated manner with other shoulder muscles to help maintain a constant distribution of force between the humeral head and the glenoid cavity throughout a wide range of motion.

A number of complex movements of the shoulder joint are possible: flexion, extension, abduction, adduction, medial (internal) rotation, lateral (external) rotation, elevation, retraction, protraction, and circumduction. Motion about the shoulder joint is the result of muscle action affecting three separate joints: the sternoclavicular, the acromioclavicular and the glenohumeral and one articulation, the scapulothoracic. The primary range of shoulder motion required to work within the envelope of the EMU is a combination of internal/external rotation, flexion/extension and abduction/adduction for the majority of EVA tasks (Refer to Figure 3-2).

Lateral and overhead motion during EVA training is of greatest interest in the context of EVA training-related shoulder injuries. Lateral movement of the arm away from the side of the body is referred to as abduction and results from the rotator cuff muscles working in a coordinated manner with the deltoid, trapezius, and serratus anterior muscles. The supraspinatus muscle, one

of the rotator cuff group, attaches the scapula (shoulder blade) to the humerus (upper arm) and is the primary muscle involved in the initiation of arm abduction through the first 20 degrees of range of motion.

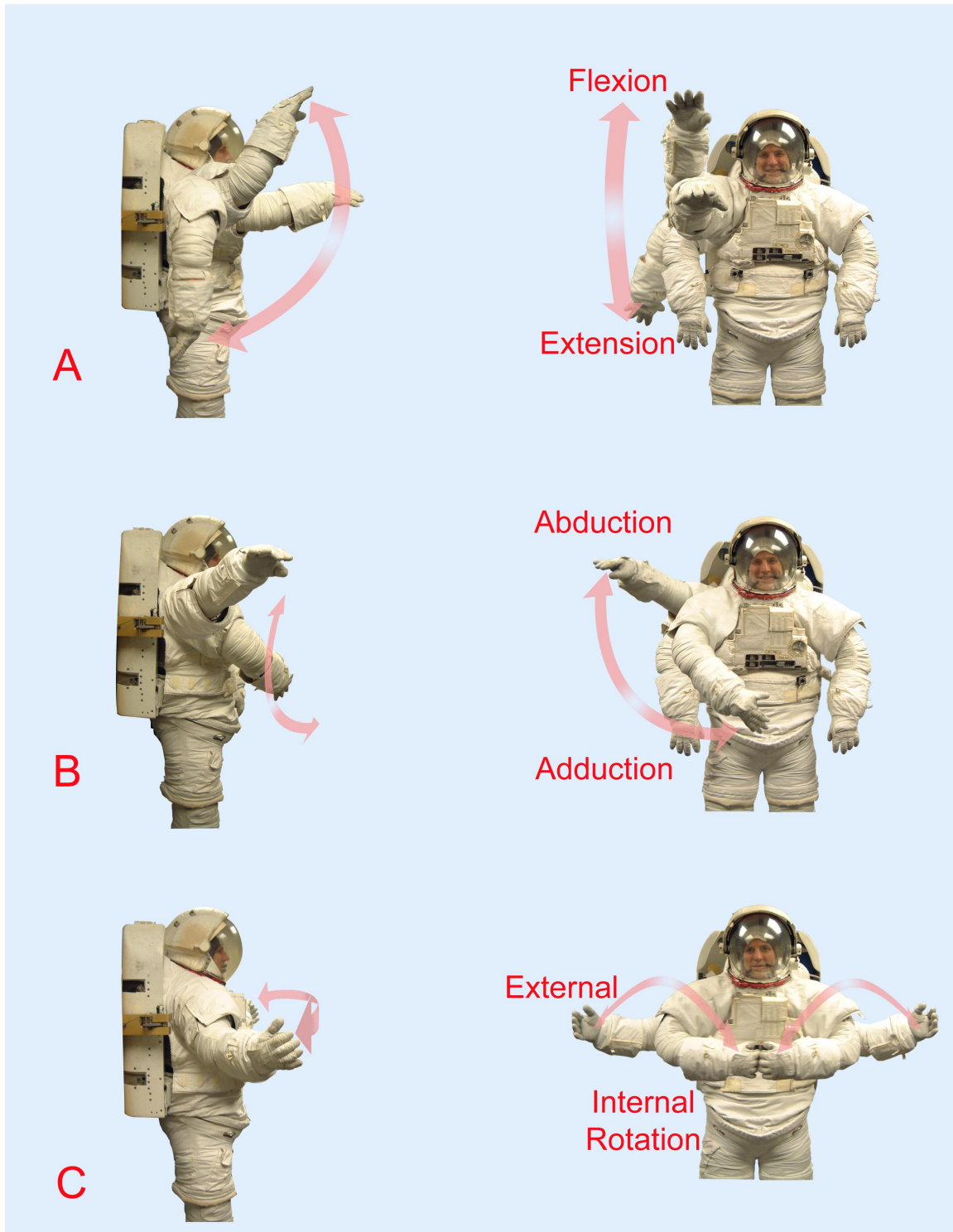

Figure 3-2 Subject demonstrating suited shoulder movements.

3.1.1 Scapulothoracic Motion

The clavicle (collarbone) supports the weight of the scapula (shoulder blade) and arm through attachments called the coracoclavicular ligaments in addition to the attachment of the clavicle to the scapula (shoulder blade) at the acromioclavicular joint. As the arm is abducted, the scapula rotates on the chest wall (scapulothoracic motion) to maintain the relationship between the glenoid cavity and the head of the humerus (upper arm) (Refer to Figure 3-3). This helps distribute force symmetrically to the glenoid cavity. Abduction of the arm is the result a combination of movement of the upper arm in the glenohumeral (shoulder) joint and rotation of the scapula on the chest wall. This rotation incorporates elevation of the clavicle (collarbone) with rotation of the scapula and is critical to normal shoulder function.

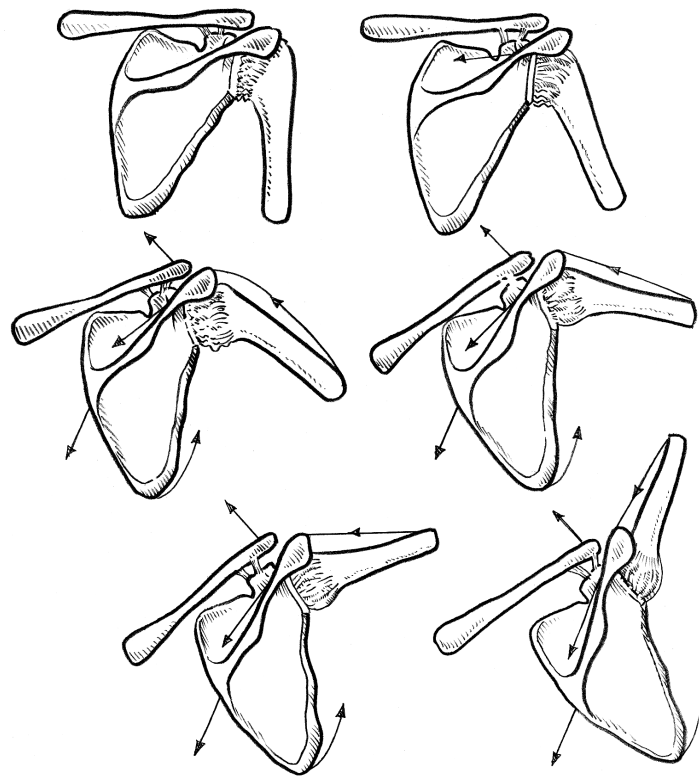

Figure 3-3 Scapulothoracic motion of the shoulder joint.

A “3 to 1 rule” has been defined to describe the relative contribution of glenohumeral to scapulothoracic motion during arm abduction. For every 3° of abduction of the arm, the glenohumeral (shoulder) joint accommodates 2° of movement and the scapula (scapulothoracic motion) rotates 1°. For instance, at 90° abduction, 60° arises from movement of shoulder joint and 30° from rotation of the scapula. Beyond 120° abduction, the greater tuberosity of the humerus contacts the bony acromion and scapular rotation alone allows further lateral movement of the arm above the head. Full abduction of the arm is possible only when the head of the humerus is externally rotated.

3.1.2 The Rotator Cuff Muscles

The supraspinatus muscle is one of four rotator cuff muscles (Refer to Figure 3-4) and is the muscle that initiates arm abduction. It has its origin on the shoulder bone (scapula) and runs in a narrow tunnel (subacromial space) beneath the bony acromion and coracoacromial arch (Refer to Figure 3-5) to attach to the humerus (upper arm). Lateral arm movements, particularly those in which the upper arm is moved laterally above shoulder height, result in narrowing of the subacromial space. This can produce friction and compression of the rotator cuff between the humeral head and the overlying acromion. A fluid-filled sac called the subacromial bursa lies between the rotator cuff muscle/tendon complex to reduce friction against the bony acromion. Rotator cuff impingement, or narrowing of the subacromial space, may occur when the arm is abducted beyond 120° and is particularly common in individuals who do repetitive heavy lifting above shoulder level.

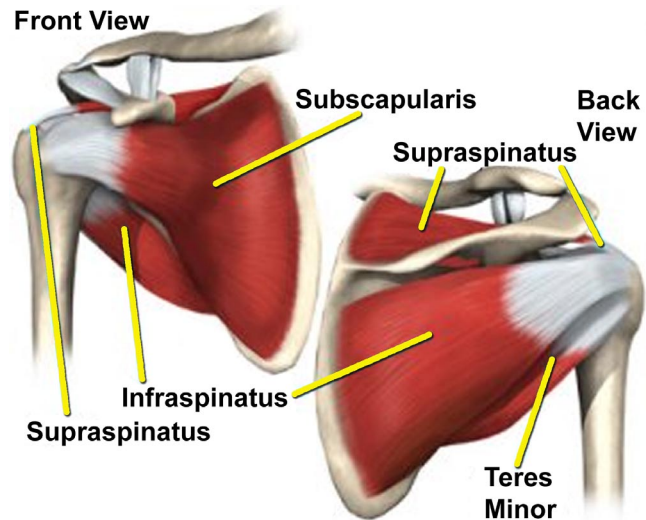

Figure 3-4 Muscles of the rotator cuff.

3.1.3 Rotator Cuff Impingement

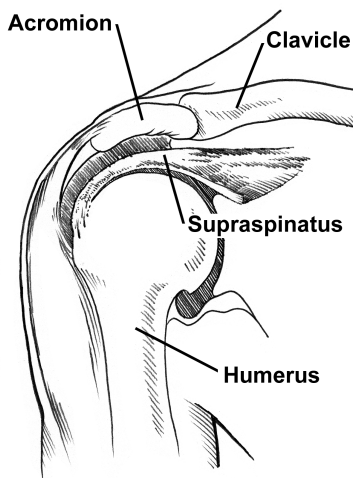

Figure 3-5 Rotator cuff.

Repetitive overhead arm motion can lead to chronic irritation of the rotator cuff tendon, resulting in shoulder pain due to tendonitis. The local irritation and compression (Refer to Figure 3-6) of the rotator cuff tendon produces an inflammatory response, leading to localized swelling. Repeated irritation can lead to inflammation of the bursa (bursitis) and deposition of calcium within the tendon, resulting in further swelling of the tendon. This phase has been referred to as the "bulge phase" and is typically associated with painful abduction and nocturnal pain. Ultimately, rotator cuff tendonitis can progress to a partial or complete tear of the tendon (Refer to Figure 3-7) following progressive weakening of the tendon associated with chronic overuse. With appropriate intervention before the stage at which rupture occurs, the entire process can resolve, resulting in a normal tendon and bursa.

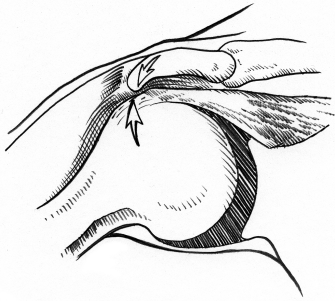

Figure 3-6 Rotator cuff impingement.

Anatomical variation in the shape of the acromion may narrow the subacromial space and predispose certain individuals to rotator cuff injury.

A number of factors predispose to rotator cuff injuries. Heavy lifting, particularly above shoulder level, and repetitive overhead activities both contribute to rotator cuff tendonitis and tears. Increasing age, particularly beyond the fifth decade, is associated with a risk of spontaneous tear due to degenerative changes that occur with time. Repetitive injury from overuse is common in younger individuals in whom athletic injuries are common as well.

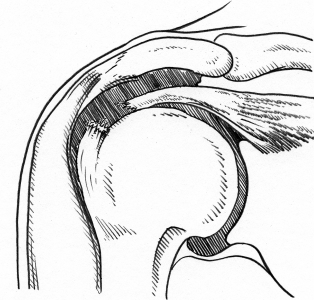

Figure 3-7 Rotator cuff tear.

3.1.4 Early Diagnosis of Rotator Cuff Injuries

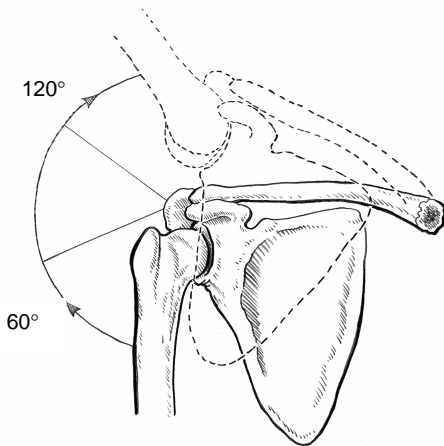

Figure 3-8 Area associated with painful arc syndrome.

Rotator cuff tendonitis is characterized by resting pain in the shoulder area that is made worse when abducting the shoulder through an arc from 60 to 120°, leading to compression of the inflamed tendon between the humeral head and the acromion. This area, called the "painful arc" (Refer to Figure 3-8), may be clinically detected by evaluating the range of arm motion. The painful arc syndrome (Kessel and Watson, 1977) has been used to describe the symptoms associated with a disorder of the subacromial region. Whether due to rotator cuff tendonitis or subacromial bursitis, there is a loss of normal motion of the tendon and a loss of the normal gliding of the bursal walls. The pain is typically worse at night when the patient sleeps with their arm above their head, supporting their head or pillow. This overhead arm position causes further impingement on the swollen tendon, resulting in pain that wakes the individual.

Repeated episodes of rotator cuff impingement cause further damage to the rotator cuff tendon that can ultimately lead to a rotator cuff tear. Thirty percent of the tendon, or more, must be torn to produce a significant reduction in shoulder strength. With larger tears of the rotator cuff, the patient cannot initiate shoulder abduction and may have a positive drop arm test.

The physical assessment of suspected shoulder injuries may be enhanced by a number of diagnostic tests including X rays, ultrasound, computed tomography (CT), and magnetic resonance imaging (MRI). X rays are generally of limited value except in cases of tendon calcification (King LJ, Healy JC and P Baird, 1999).

Roberts et al. (2001) reported that ultrasound had sensitivity and specificity rates of 80% and 100%, in the diagnosis of full-thickness rotator cuff tears and sensitivity and specificity rates of 71% and 100%, for partial-thickness tears. They conclude that the test is easy to perform and a valuable adjunct in the early diagnosis of rotator cuff injuries. CT is most helpful in the evaluation of shoulder trauma but gives limited information on the soft tissues. MRI is an accurate imaging modality for evaluating the rotator cuff and biceps tendon, allowing visualization of the soft tissues and the adjacent bony structures (King LJ, Healy JC and P Baird, 1999).

3.1.5 Tears of the Superior Labrum

The labrum has two primary functions: it deepens the socket of the glenoid cavity, providing additional stability to the shoulder joint, and it serves as a point of attachment for other ligaments and tendons.

The biceps muscle lies on the front of the arm; contraction of the biceps results in flexion of the elbow. Although the muscle is quite large, it turns into a small tendon about the size of a pencil where it attaches inside the shoulder joint. At the other end of the muscle, a large tendon attaches beyond the elbow in the forearm. The portion that attaches in the shoulder goes through a small hole in the rotator cuff tendons. Once inside the joint, the tendon partly attaches to the bone near the glenoid socket and partly to the labrum at the top of the joint. The biceps tendon can be torn where it attaches to the bone, where it attaches to the labrum, or in both locations.

Different types of tears to the labrum can occur. Shoulder dislocation can pull the labrum from its bony attachment. Repetitive overuse can lead to fraying of the edge of the labrum, a condition frequently found with aging (typically over age 40). Falls on an outstretched arm may also damage the labrum with the transmission of force resulting in compression and tearing of the fibrous labral tissue.

Another type of tear may occur where the biceps tendon attaches to the labrum. The labral tissue in front of (anterior) and in back of (posterior) the biceps attachment to the labrum may be torn, resulting in a superior labrum anterior to posterior (SLAP) tear. These injuries have been classed from grades 1 to 4, based upon increasing damage and tearing of the labral tissue. A common cause of SLAP tears is direct compression of the labrum from falling on an outstretched arm, which results in direct transmission of force to the labrum to produce the characteristic anterior/posterior tear.

MRI or CT scans have been used to diagnose certain types of tears of the labrum, but are not good tests for diagnosing SLAP tears. The best way to make the diagnosis of labrum tearing is with arthroscopy of the shoulder. Unfortunately, this is an operative procedure requiring anesthesia.

3.2 Classification of EVA Training-Related Shoulder Injuries

For the purposes of the tiger team report, we classified EVA training-related shoulder injuries into two categories: major or minor. Major shoulder injuries are defined as those requiring surgical intervention or prolonged restriction from EVA training. Minor shoulder injuries are typically benign, self-limiting conditions that may be treated with varying levels of physical therapy and medical care. The majority of shoulder injuries associated with NBL training are minor, with resolution of symptoms typically within 48 to 72 hours of an NBL run. The number of minor injuries that progress to major injuries is unknown. Persistent or repetitive minor injuries may develop into overuse syndromes, ultimately leading to a chronic injury that may require surgical intervention.

3.2.1 Minor Shoulder Injuries

Direct contact, or pressure points created by contact with the HUT shoulder scye bearing joint¹ cause the observed minor shoulder injuries. These injuries range from local skin irritation and redness to bruising of the underlying soft tissue. In many cases, these injuries may be prevented or reduced with use of shoulder padding attached to the LCVG.

Most shoulder pressure points are the result of sustained inverted training in the EMU. Three types of body orientations are possible during inverted training in the EMU. The astronaut may be pitched forward in a head-down, face-down orientation; they may be completely inverted or pitched backward in a head-down back-down orientation. The load distribution and transmission of force from the scye bearing joint to the shoulder and adjacent soft tissue varies with each body orientation.

3.2.1.1 Anterior Shoulder and Chest Irritation

Pain in the anterior aspect (front) of the shoulder and chest is typically associated with the head-down, face-down body orientation. In this position, the scye bearing joint comes in contact with soft tissue of the lateral chest wall, causing bruising of the skin and possible contusion of the underlying pectoralis major muscle. Type -335/-336 padding (Refer to page 51) is often effective in reducing or eliminating this soft tissue irritation (Refer to Figure 3-9), particularly in combination with Teflon inserts used to help distribute the load (load alleviation).

¹ The HUT shoulder scye bearing joint is the point of attachment of the EMU upper arm segment to the HUT. In inverted body positions, the weight of the suited subject is supported through contact of each shoulder with this one-inch-wide bearing surface.

3.2.1.2 Superior Shoulder Pain

Superior shoulder pain (on the top of the shoulder) (Refer to Figure 3-10) typically is associated with completely inverted body positions. The completely inverted crewmember is supporting all



Figure 3-9 Anterior shoulder irritation immediately after an NBL run.

of their body weight on both shoulders through contact with the scye bearing joints. Shoulder padding (either Type -335/-336 or Type -338) reduces the effect of local pressure. Many astronauts have used it with some benefit during training. It should be noted however, that LCVG padding was primarily designed to reduce hot spots created by local pressure points in the EMU; it was never intended as a load-alleviating device to protect the crewmember during periods of prolonged inverted operations.

A Teflon insert has been found to be very beneficial in significantly reducing the skin irritation and soft tissue bruising associated with completely inverted body orientations during training. Crew experience has shown that the combination of Teflon and shoulder padding may be used effectively for load alleviation. A shoulder harness was originally designed for load alleviation when working in inverted body positions but has not been used for many years (Refer to page 53). This harness was evaluated as part of the tiger team review² and was found to be beneficial in certain situations (See Appendix B and C).

of their body weight on both shoulders through contact with the scye bearing joints. Shoulder padding (either Type -335/-336 or Type -338) reduces the effect of local pressure. Many astronauts have used it with some benefit during training. It should be noted however, that LCVG padding was primarily designed to reduce hot spots created by local pressure points in the EMU; it was never intended as a load-alleviating device to protect the crewmember during periods of prolonged inverted operations.



Figure 3-10 Superior shoulder irritation within 24 hours after an NBL run.

² EMU Harness was evaluated by Dave Williams January 17th, 2003, in a 6-hour NBL development run and by Dave Williams and Rex Walheim in a 4-hour development run April 7th, 2003.

3.2.1.3 Posterior Shoulder and Back Irritation



Figure 3-11 Posterior shoulder/back irritation immediately after an NBL run.

Posterior (back of) shoulder and back pain is associated with the back-down head-down body orientation. Pressure points occur in the posterior/superior portion of the shoulder as well as the back of the crewmember. The LCVG ducting may create additional hot spots in this body orientation (Refer to Figure 3-11). Type -335/-336 shoulder padding can be effective in reducing the posterior/superior shoulder irritation and back padding may be used if sufficient volume exists in the HUT.

3.2.2 Major Shoulder Injuries

Major shoulder injuries are associated with significant damage to the shoulder joint musculature or tendons. In many cases, these injuries represent a progression of overuse injuries from chronic tendonitis to complete tear of the rotator cuff and/or glenoid labrum.

3.2.2.1 Proposed Mechanism of Major EVA Training-Related Major Shoulder Injuries

The functional anatomy of the shoulder and the mechanisms of both occupational and athletic shoulder injuries are well understood. When the tiger team was formed, neither the relationship between EVA training and shoulder injuries nor the mechanism of injury was understood. Following interviews with the two EVA astronauts treated surgically for rotator cuff and/or labral tears, the temporal association between EVA training and the sustained injuries was evident. This suggested a causal relationship that required the team to identify the contributing (high-risk) factors and determine the mechanisms of injury.

Inverted body positions were reported as the most likely suspected cause of the observed shoulder injuries, with the design of the planar HUT shoulder joint identified as the second most likely contributor (Refer to Table 2-6). The local effects of shoulder weight bearing associated with inverted body positions during EVA training are obvious. The mechanism of minor injury and benefit of available protective devices is evident. However, initially the relationship between inverted operations and the design of the planar HUT and the observed major injuries was not as clear.

Early suggestions evaluated by the tiger team on the potential mechanisms of major injury focused on the internally rotated position of the shoulder in the planar HUT and the direct effects of local pressure on the underlying shoulder muscles. The opening of the Planar HUT shoulder scye bearing joint is tilted and internally rotated to optimize HUT ingress and suited shoulder movement (Refer to Figure 3-16). To understand the possible relationship between the design of the shoulder

joint in the planar HUT and the observed shoulder injuries, the biomechanics of suited shoulder movement were evaluated using data from laser scans, photographs and shoulder ultrasound.



Figure 3-12 Shoulder clearance between scye bearing joint and the LCVG.

Unsuited laser scans of the upper body in different positions of arm abduction confirmed the elevation of the acromion and clavicle (collarbone) that is associated with normal scapulothoracic motion. Measurements taken from the laser scan data show 6 cm movement of the acromion and 4 cm movement of the mid-clavicle at the point of maximum abduction (150°) without an LCVG.

A suit fit check was performed with the upper arm segment removed from the HUT. This was done to measure the clearance between the scye bearing joint and the LCVG with shoulder pads (Refer to Figure 3-12). The clearance ranged from firm contact (with the subject standing completely upright in the suit, with body weight supported on the soles of the feet) to approximately 1cm (with the subject standing with bent legs and the body weight supported by the soles of the feet and contact with the crotch of the suit). Comparison between the anatomical data, the laser data, and the measurements from the fit check confirm that insufficient clearance exists between the scye bearing joint and the

shoulder to allow the normal range of scapulothoracic motion associated with shoulder abduction.

Two separate meetings were held with different orthopedic consultants^{3,4} to discuss the possible mechanism of rotator cuff injury associated with EVA training. When presented photographs from the suit fit check showing the clearance between the shoulder and the scye bearing joint, both teams of consultants felt that restriction of scapulothoracic motion (Refer to Figure 3-13) would lead to premature impingement of the rotator cuff between the humeral head and the acromion during abduction. The consensus of their expert opinion suggested that restricted scapulothoracic motion with rotator cuff impingement was likely after approximately 50° abduction in upright suited body positions. Earlier impingement in inverted body positions is likely due to the additional restriction of shoulder motion associated with the support of the body weight on both shoulders. The consultants felt that impingement would occur, after approximately 20° – 40° abduction when the body is inverted.

³ Meeting held January 27th, 2003, at USRA with Dr. Kyle Dickson, Associate Professor Traumatology, Department of Orthopaedics, Tulane University, and Dr Steve Viegas, Professor and Chief Division of Hand Surgery, Department of Orthopaedics, University of Texas Medical Branch.

⁴ Meeting held March 24, 2003, at Baylor College of Medicine with Dr. Walter Lowe, Associate Professor, Department of Orthopaedics, Baylor College of Medicine, and Dr. David Lintner, Associate Professor, Department of Orthopaedics, Baylor College of Medicine.

Analyses of the laser scan and measurement data predict restriction of scapulothoracic motion beyond 50° to 60° abduction. The laser-scan data recorded 6 cm movement of the acromial region through a 150° range of abduction with 1 cm elevation of the acromion occurring within the first 30° – 60° abduction. The observed fit check data demonstrate a maximum of approximately 1 cm clearance for the suit fit of the test subject. The laser data suggests that limitation of movement of the acromioclavicular joint and clavicle occurs within the range predicted by the orthopedic consultants. Beyond 60° abduction, suited shoulder movement

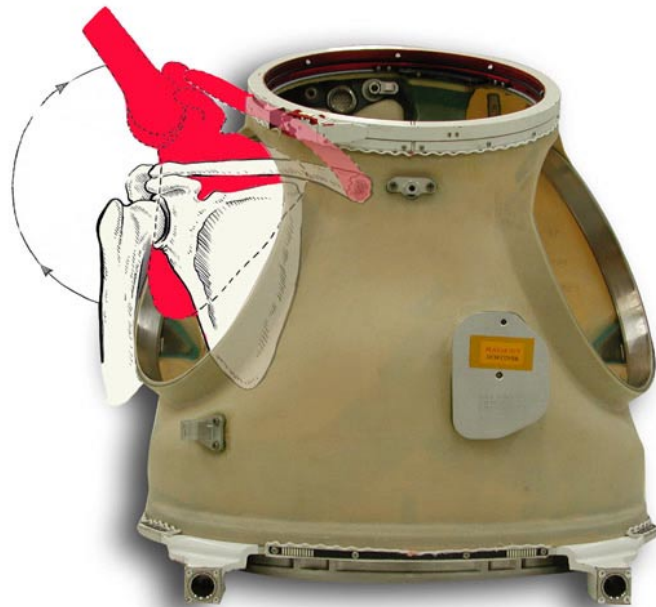

Figure 3-13 Restricted scapulothoracic motion.

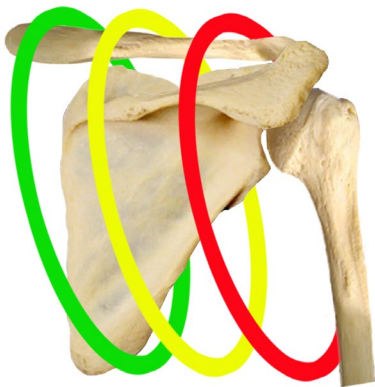

Figure 3-14 Lateral position of scye bearing joint.

will involve only glenohumeral motion, resulting in premature contact of the greater tuberosity of the humerus with the lateral edge of the acromion causing rotator cuff impingement.

The lateral position of the scye bearing joint overlying the clavicle (collarbone) may affect the degree of restriction of scapulothoracic motion. A suit fit in which the position of the scye bearing joint falls over the outer third (red) of the clavicle (collarbone) will likely result in greater restriction of scapulothoracic motion than if located over the middle third (yellow) or inner third (green) (Refer to Figure 3-14).

will involve only glenohumeral motion, resulting in premature contact of the greater tuberosity of the humerus with the lateral edge of the acromion causing rotator cuff impingement.



Figure 3-15 Vertical position of scye bearing joint.

The vertical position of the scye bearing joint will also affect the degree of restriction of scapulothoracic motion. A suit fit where there is firm contact (red) between the acromioclavicular joint (top of the shoulder) and the scye bearing joint will result in the greatest restriction of motion (Refer to Figure 3-15). Clearance of 1–2 cm between the scye bearing joint and the

acromioclavicular joint allows some scapulothoracic motion but still results in premature restriction of normal shoulder movement and is associated with a risk of rotator cuff impingement.

The clearance between the shoulder padding and the scye bearing joint will also affect the amount of restriction of scapulothoracic motion. Thicker shoulder pads will decrease the clearance between the HUT scye bearing joint and the shoulder and contribute to the restriction of shoulder range of motion. The selection of optimum shoulder pad thickness should be based upon a balance between alleviation of load and hot spots with maintenance of shoulder clearance for adequate range of motion. Astronauts that prefer firm contact between their shoulder pads and the suit shoulder joint will likely restrict arm motion more than those that have greater clearance.

The following drawing and table (Refer to Figure 3-16) illustrate the dimensional differences between the Planar and Pivoted HUTs.

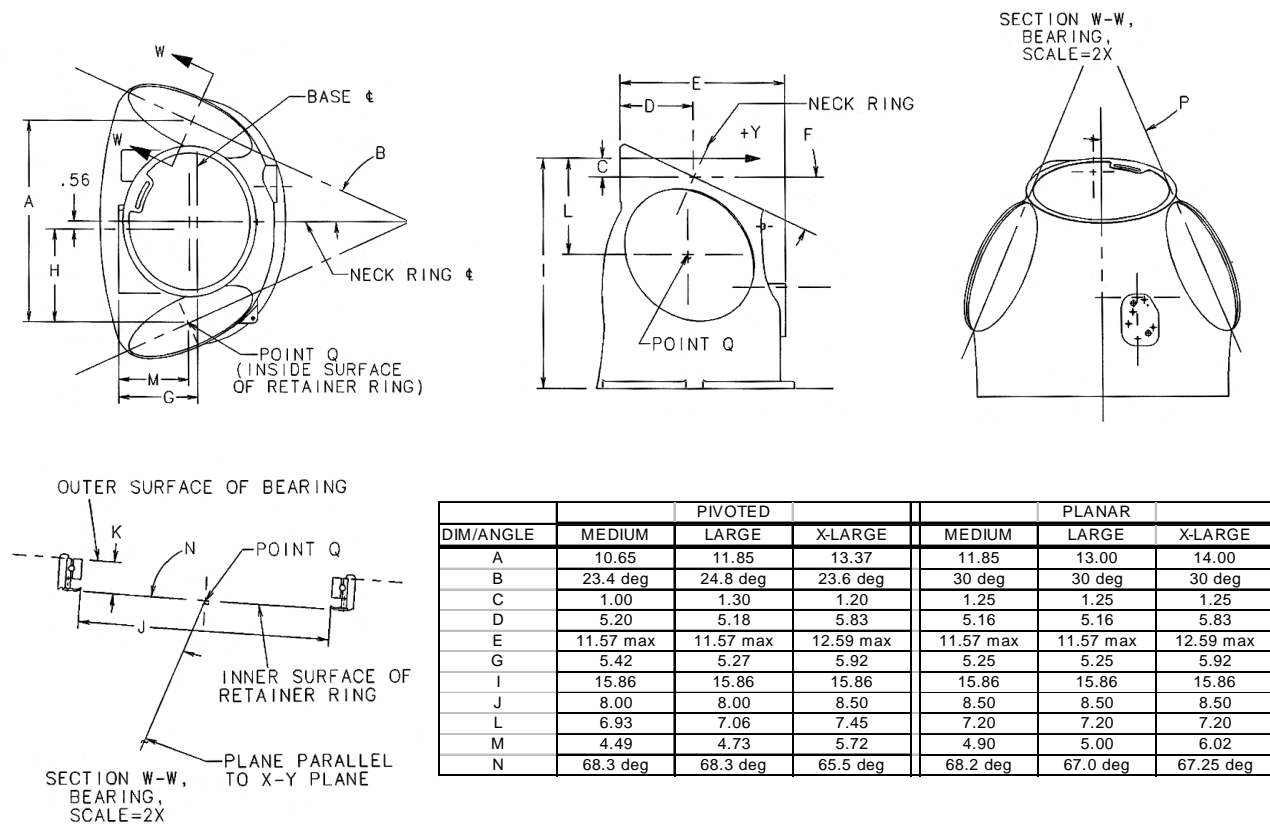

Figure 3-16 EMU HUT measurements.

The front-to-back dimensions of the HUTs as measured from the center of the water block to the center of the Display and Control Module pad are as follows:

- M – 10.25 in
- L – 10.38 in
- XL – 11.25 in

These dimensions are consistent between the pivoted and planar HUT configurations.

The following drawing and table (Refer to Figure 3-17) illustrate the inter-scye distance at different positions on the scye bearing. For example, the distance between the scye bearings at the top of the shoulder (90 degrees) for the XL HUT is 11.587 inches.

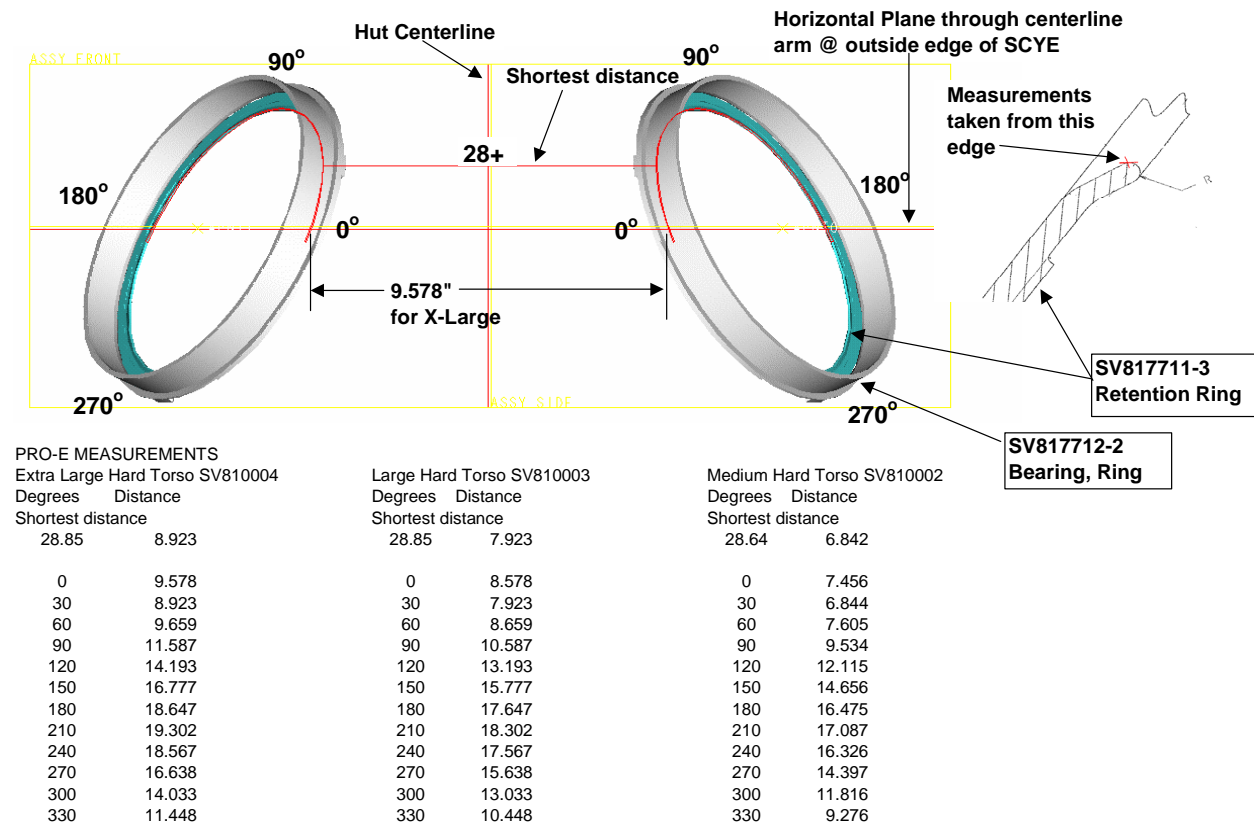

Figure 3-17 EMU Planar HUT inter-scye measurements.

The effect of varying the lateral position of the scye bearing joint (Reference dimension A, Figures 3-16 and 3-17) was evaluated during a suit fit check where the test subject (Williams) who had previously trained in an XL planar HUT assessed suit fit and shoulder range of motion in a L planar HUT. Using the anthropometric data from the laser scans, it was possible to demonstrate the difference in lateral location of the scye bearing joint for the XL and L HUTs. Figure 3-18 demonstrates that the scye bearing joint falls at the junction of the inner and middle third of the clavicle (collarbone) in the L HUT.

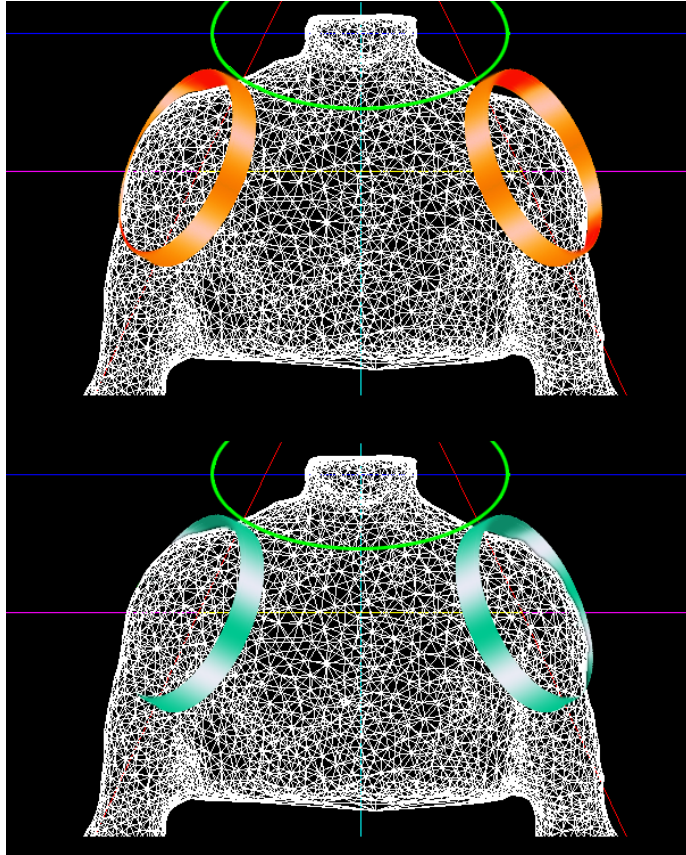

Figure 3-18 Position of scye bearing joint in XL vs. L HUT.

For the XL HUT, the scye bearing joint lies over the junction of the middle third and outer third of the clavicle for the XL HUT. Measurements of the two HUTS reveal a lateral difference of a half of an inch per side between the planes of the scye bearing joints (inter scye bearing joint distance) in the XL compared to the L Planar HUT. Subjectively, the test subject reported a greater range of shoulder motion in the L compared to the XL HUT a finding verified in a subsequent mission-specific NBL training run.

Anecdotally, some astronauts chose a smaller size when transitioning from the older Pivoted to the current Planar HUT configuration. These astronauts found that the L Planar HUT provided a suit fit comparable to that of the XL Pivoted HUT. This is likely due to the fact that the inter-scye bearing joint distance of the L Planar HUT is very similar to that of the XL Pivoted HUT (Reference dimension A, Figure 3-16).

Restriction of scapulothoracic motion may also alter the normal relationship of the humeral head to the glenoid cavity, resulting in greater force transmitted to the superior labrum as the shoulder muscles contract to continue arm abduction against the resistance of the suit, resulting in glenohumeral motion without scapulothoracic rotation. Restricted elevation of the acromion, acromioclavicular joint and clavicle by the scye bearing joint results in greater isometric loads on the trapezius muscle. Prevention of scapular rotation also results in isometric loading of the serratus anterior muscle and the middle and lower fibers of the trapezius. The contribution of such isometric loading of these muscles to EVA shoulder injury is unknown.

Both the data and consultations with orthopedic surgeons suggest that the dominant mechanism of shoulder injury associated with EVA training is the limitation of scapulothoracic motion by the shoulder joint of the planar HUT (Refer to Figure 3-19). This leads to premature impingement of the rotator cuff that may result in tendonitis, development of an overuse syndrome, and ultimately a rotator cuff tear. Alteration of the normal distribution of force between the humeral head and the glenoid cavity may increase the likelihood of labral tears through direct

compression of the superior labrum. The relative contribution of the internally rotated position of the shoulder joint in the HUT resulting in destabilization of the shoulder joint is unknown.

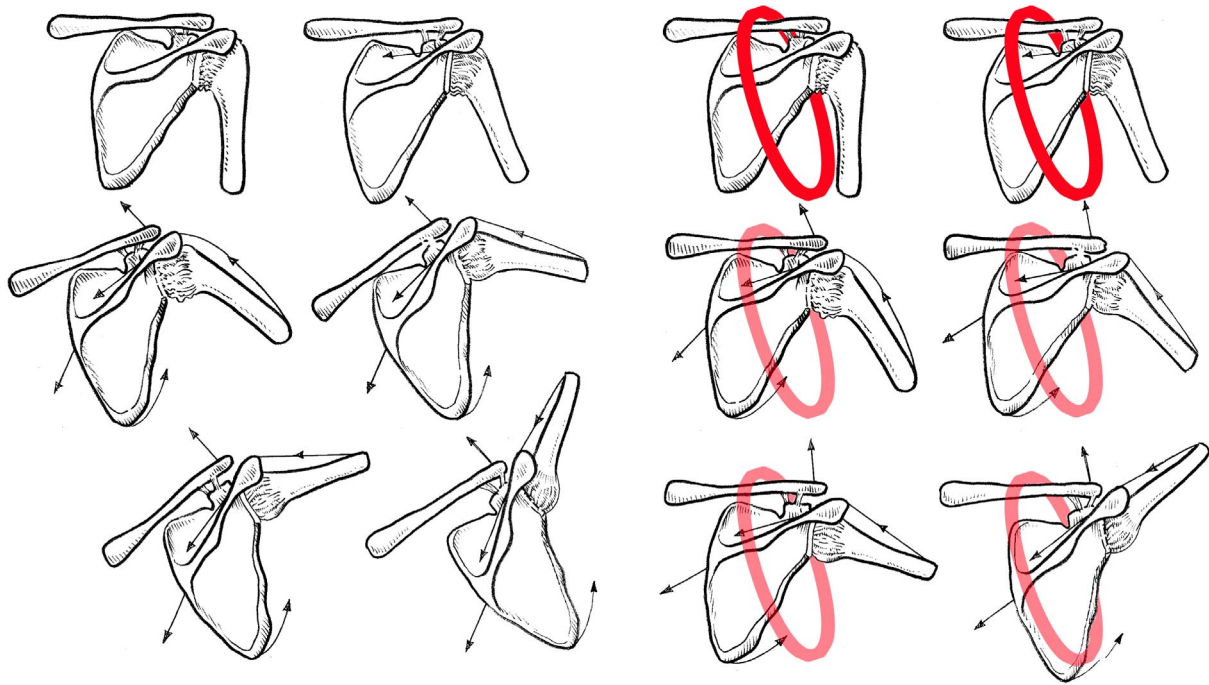

Figure 3-19 Scye bearing joint restricting shoulder movement.

Inverted body positions during EVA training contribute to both minor and major shoulder injuries. The direct loading to soft tissues associated with shoulder weight bearing leads to local irritation, bruising, and soft tissue swelling. In some cases, swelling associated with an acromioclavicular joint effusion has been noted. This typically resolves within 48–72 hours after an NBL run. Inverted body positions also clearly worsen the restriction of scapulothoracic motion that occurs when working upright in the EMU.

The data and clinical observations suggest that limiting the amount of arm abduction when working in the EMU can be beneficial in reducing the risk of injury. One of the surveyed EVA astronauts who had a history of a remote shoulder injury routinely works with his elbows close to his side while training in the NBL. He uses this technique as one of a number of strategies to reduce his risk of shoulder injuries.

3.3 Medical Effects of Inverted Body Positions During EVA Training

Inverted body positions during EVA training present a number of medical risks to the suited subject, including the increased risk of shoulder injury. These include the risk of middle ear and sinus squeeze, orthostatic intolerance, and disorientation. Subjective reports of these events were noted in interviews with some of the surveyed EVA astronauts.

The hydrostatic effect of the inverted body position leads to fluid shifts to the head and upper body. The physiological consequences of these fluid shifts vary with the body position while inverted. Complete inversion is associated with more pronounced physiological effects than either the head-down, face-down or head-down, back-down body orientation.

Fluid engorgement in the soft tissues of the head may make it more difficult for suited subjects to equalize the pressure in their middle ear and sinuses when they move vertically to different depths in the NBL after being inverted for a length of time. Transient inversion associated with air lock egress has not resulted in any of these problems. However, sustained inverted body positions to perform specific tasks can result in difficulty clearing the ears after resuming an upright body orientation. In addition to the effect of the amount of time inverted, the magnitude of this effect can vary in the same individual at different times during an NBL run and/or between different NBL runs. Frequent pauses to return to a head-up body orientation are helpful in preventing this problem. Vertical translation after a period of inverted operations should be done very slowly with vigilance to early and frequent utilization of the Valsalva maneuver to prevent ear and sinus squeeze. If divers are required to move a suited subject after performing tasks inverted, they should move the subject to different depths very slowly and with close communication with the suited subject to ensure they are clearing their ears frequently.

Lightheadedness after resuming a head-up body orientation after performing inverted tasks has been reported by some astronauts in EVA training. This typically occurs after prolonged inversion in association with rapidly resuming a head-up body orientation. Frequent pauses to return to a head-up body position are helpful in preventing this problem. Slowly transitioning from a head-down to head-up orientation and avoiding dehydration with use of the in-suit drink bag can eliminate the problem.

Some suited subjects have found working inverted contributes to a sense of disorientation. The feeling is often transient when initially transitioning to a head-down body orientation. Returning to a head-up body position resolves the problem.

During the course of the tiger team, a number of discussions covered the potential benefits of limiting inverted body positions during EVA training, particularly when the additional risk of shoulder injury associated with inverted body positions was recognized. Complete restriction of inverted operations did not seem feasible, given the operational necessity for transient inverted body positions associated with such tasks as airlock egress. Other tasks require inverted body positions to train in the NBL configuration. The EVA Office, the Space and Life Sciences Directorate, and the Astronaut Office outlined, in a letter (Doering and Davis 2003), recommendations to limit the frequency and duration of inverted operations, as well as specific strategies for risk reduction, pending further recommendations from the Space and Life Sciences Directorate. Further work is required to implement an operationally feasible set of limitations to inverted body positions during EVA training at the NBL.

Section 4 Conditioning Programs to Prevent EVA Training Shoulder Injuries

4.1 ASCR Role and Supervision

The Astronaut Strength, Conditioning and Rehabilitation (ASCR) team at JSC oversees all formal crew physical conditioning and rehabilitation activities. The role of the ASCR team with respect to EVA-specific training has evolved tremendously since they were first chartered to train EVA crews with STS-60, approximately 10 years ago. With the complexity of EVA flights like Hubble and the unique requirements associated with ISS assembly, this team has become a vital link in EVA chain.

This group is responsible for:

- Scheduling and implementing the annual fitness assessment, review the results with crew, develop recommendations to the astronaut, and document in the fitness report.
- Providing individualized physical conditioning programs based upon mission needs (EVA, long-duration, etc.) and implement changes as necessary based upon results of the annual fitness assessment or medical assessment testing.
- Implementing, monitoring, and updating programs on a timely basis for all astronauts. This includes in-flight exercise programs for long-duration crews.
- Providing one-on-one training upon request of astronaut. ASCRs must be available during scheduled exercise times for all assigned Shuttle, ISS, & EVA crews.
- Giving input to exercise guidelines for all mission phases.
- Providing input to exercise countermeasure requirements, exercise hardware requirements, and the development of on-board exercise countermeasure hardware.
- Assessing, evaluating and caring for injuries.
- Providing assessment, evaluation and appropriate rehabilitation program for long-duration crews.

The ASCR team is co-located with the Astronaut Gym (Building 260A) and the Astronaut Rehabilitation Facility (Building 29). These facilities offer a wide range of fitness and rehabilitation programs.

Through the annual fitness assessment and monitored workouts, the ASCR team provides a surveillance capability for issues like shoulder injuries. A copy of the annual fitness assessment is sent to Flight Medicine. The ASCR team attempts to schedule this evaluation about 1 month prior to the subject's annual medical exam. If an ASCR team member identifies a medical issue, it is recorded using the subjective, objective, assessment, and plan [SOAP] format. The ASCR team is part of the FMC team of astronaut health care providers. Since the ASCR team has a Licensed & Certified Athletic Trainer and other qualified personnel, they have the capability to assess, evaluate, and establish a rehabilitation program. The ASCR therapeutic information is currently documented in the EMR for each individual crewmember. Within the EMR is a

dedicated form with a “Plan” field, where the rehabilitation therapy can be documented. The capability to update the EMR in this fashion has only been available since the fall of 2002. If an injury is serious and requires further testing (X ray or MRI), the ASCR trainer will communicate directly with the crew surgeon for assigned crewmembers. Otherwise, they will contact the FMC physician on-call. Finally, an ASCR representative will typically attend the weekly All Docs meeting and provide feedback as appropriate.

4.2 EVA Workouts

For years, the ASCR team has evaluated and implemented specific EVA training methods and programs. The team is equipped with the appropriate personnel and equipment and offers flexible schedules to facilitate conditioning and rehabilitation. As of the writing of this paper, a specific EVA physical training module has been completed and will be inserted into the Astronaut Strength and Conditioning Manual. It also will be added to the ASCR web site <<http://sd.jsc.nasa.gov/astronauthealth>>. Access to this web site is controlled and can be obtained by contacting one of the ASCR personnel. The exercises listed on this web site are considered EVA-specific because they are either movement similar, metabolically specific or muscularly specific to performing an EVA. The workouts that the ASCRS provide include many of these exercises and are designed specifically for each individual according to their own fitness level and need for injury prevention/rehabilitation. For best results, the workouts are monitored by an ASCR. Athletic workouts supervised by athletic trainers result in fewer training-related injuries and better outcomes than unsupervised athletic training (Mazzetti et al. 2000, George 1997, Moynes 1983, Kibler and Chandler 1994).

4.3 Astronaut Participation

All survey astronauts in EVA training reported regularly exercising more than three to four times per week. Twenty-five percent of the survey astronauts in EVA training (5/20) exercise more than five times per week. All EVA astronauts participate in weight training although only twenty percent (4/20) started weight training to prepare for EVA. Seventy percent of surveyed EVA astronauts perform rotator cuff strengthening exercises during their workouts.

Astronauts have two options for working out. They can do their own personal workout or they may be supervised by an ASCR representative to prescribe and monitor a specialized workout. The tiger team survey data indicates that 65% of EVA astronauts report having ASCRs supervise their workouts, with 60% performing a specific EVA workout. In contrast to the survey data, it is estimated that approximately 35% of the astronaut corps utilize the on-site gym and ASCR monitored training on a regular basis (ASCR anecdotal data).

Currently no mandatory requirements exist for participation in ASCR-monitored physical training. The Shuttle MORD requirements (JSC 13956 Rev. H, Paragraph 3.2.4.1.4) state that the preflight training program for EVA crewmembers shall include a minimum of three, two-hour periods of physical training per week within 6-12 months of scheduled launch date. The ISS MORD requirements (SSP 50260 RB, Paragraph 6.1.3.1) state that the training timeline shall

accommodate a minimum of three, two-hour periods of exercise per week. Depending upon the phase of training of an EVA astronaut, scheduling these sessions may be difficult with the numerous demands for training time. These requirements are typically met for mission-assigned EVA crew from a scheduling perspective, although actual participation in physical training during these scheduled periods is not monitored or enforced. The ASCR team believes that the operational success of EVA astronauts who have participated in monitored preflight exercise programs and their positive feedback postflight will play a role in motivating other astronauts to use their services.

Section 5 Suit Modification to Prevent Shoulder Injuries

5.1 Anthropometric/Biomechanical Design of Shoulder Joint to Prevent Injury

The design of the EMU Planar HUT limits the scapulothoracic motion required for the full range of shoulder movement. HUT ingress through the horizontal-plane body seal closure requires an inward orientation of the shoulder scye openings for ease of donning and doffing. After ingress, the orientation of the scye bearing joint increases the internal rotation of the subject's shoulder joint at rest and may destabilize the shoulder joint during movement by altering the efficiency of the rotator cuff muscles. In addition, the lateral orientation and position of the HUT scye bearing joint results in impingement of the rotator cuff during overhead arm motion.

The prototype HUT featured fixed scye openings that, when coupled with the horizontal plane body seal closure, made ingressing the shoulders/upper arms of the suit very difficult. It was decided that incorporating a gimballed bellows into the shoulder joint improves donning and doffing capability. The addition of the gimballed bellows successfully resolved the donning problem, but introduced four Criticality 1 failure modes into the design (FM11, Loss of Pivot Socket; FM14, Loss of Bellows Gimbal Stop Strap; FM20, Loss of Gimbal Pivot Attachment; and FM21, Loss of Gimbal Bellows).

This HUT design was referred to as the "Pivoted" HUT. The requirement established for the pivoted HUT program was to accommodate the 5th percentile female to 95% male astronaut based upon anthropometric standards. Two anthropometric databases were used in the development of the Pivoted HUT: AMRL-TR-80-5 Anthropometry of Air Force Women (1972) and the WADC-52-321 Anthropometry of Flying Personnel (1950). Neither of these databases incorporated international anthropometric data.

Five sizes (XS, S, M, L, & XL) were developed and four sizes (S, M, L, & XL) were produced to accommodate as many astronauts as possible. The ultimate position and orientation of the scye openings were optimized, based on fit checks of the existing astronaut corps, to accommodate the largest segment of the population possible.

NASA recognized in the late 1980s that the gimbal pivot/bellows design was a vulnerable point in the suit design and initiated a redesign to eliminate it. The goal of the Planar HUT program was to eliminate the four Criticality 1 failure modes while preserving as much donning capability and shoulder mobility as possible. In addition, attempts were made to preserve the work envelope of the Pivoted HUT in the redesign.

The significant factors that led to the decision to the switch to Planar HUT were:

- The majority of the fleet of Pivoted units were due to expire in early 1995 and would need replacement.

- The high cost and long lead-time to manufacture Pivoted HUTs; not just the pivots but also the whole manufacturing process. Pivot installation and bellows attachment were a big cost driver.
- The desire to eliminate two limited life items: pivots and bellows.
- The desire to eliminate four Criticality 1 failures (FM11, Loss of Pivot Socket; FM14, Loss of Bellows Gimbal Stop Strap; FM20, Loss of Gimbal Pivot Attachment; and FM21, Loss of Gimbal Bellows).
- Data from Ames Research Center demonstrating a “proof of pivot-less concept” with AX-5 and MK III suits using Shuttle EMU arms.
- The critical failure of a shoulder joint during Weightless Environment Training Facility (WETF) training with loss of the pivot and a ruptured bellows, leading to rapid depressurization of the EMU.

The Planar HUT development program was originally intended to replace the four Pivoted configurations with four Planar configurations. The same anthropometric standards were to be used in the development of the Planar HUT. Due to budget constraints at the time (“Red Team/Blue Team” Independent Assessment) only the medium (M) and large (L) HUT sizes were developed.

The constraint limiting the EMU fleet to two sizes of HUTs shifted the initial fit requirement of 5th to 95th percentile crew size to those astronauts who fit into a M or L HUT. The Planar HUT was well into production when the budget and need for an XL HUT was identified. The XL Planar HUT was designed and built with three Planar HUT sizes currently available for fitting astronauts: M, L, and XL. The M and L Planar HUT designs have been in operation since 1997, while the XL HUT was introduced in 2000.

During development of the Planar HUT, the locations of the scye openings were optimized through a series of crewmember fit-checks to accommodate the largest number of astronauts in each size range. Trade-offs were made during the optimization process. To maximize upward and forward reach, the scye openings were canted more upward and rotated inward, compared to the original Pivoted HUT design (Refer to Figures 3-16 and 3-17).

The following are the differences between the Pivoted and Planar HUTs from a fit and performance perspective:

- The shoulder pivot joint with gimbaling scye bearing was replaced with a fixed scye bearing in the Planar HUT.
- The size of the M and L arm openings in the Pivoted HUT were increased to the XL size arm opening to improve don and doff capability of the Planar HUT and to allow greater mobility for optimum shoulder positioning and movement. When the XL Planar HUT was developed, there was no additional increase in the size of the arm opening.
- The position of the scye openings in the Planar HUT restricts downward and rearward reach.
- For the XL Planar HUT, the arms were moved as far back as possible to alleviate a common complaint from astronauts that the arm location in the prototype Planar HUT

forced them forward into a “Cro-Magnon” hunched over position. The scye opening was repositioned 3/8-inch aft.

- The design goal for Pivoted and Planar HUTs was to get the top of the scye opening as close to the neck ring flange as possible to maximize helmet visibility by allowing the astronauts to get their head as high as possible in the helmet. When the pivots were eliminated, the extra clearance for the gimbal sweep and bellows was not needed and the top of the arm opening was moved up closer to the flange.

With these changes it was readily apparent that reach and mobility in the Planar HUT was degraded in the downward (arms at sides) and aft directions and that donning/doffing was much more difficult for most crewmembers. Vendor-supplied measurements indicated that overhead reach and shoulder joint torque was not significantly different in the Planar HUT. A crew consensus meeting on the XL Planar HUT was held in May 2000. Concerns about the XL HUT were addressed in a Crew Consensus memo (CB-00-061, reference Appendix E). However, the desire to use a safer design and the need to meet ISS schedules overrode suggestions within the EVA community to go back to using the Pivoted HUTs and/or design a new HUT.

Given that a new HUT design will not be available in the near future to mitigate the risk of shoulder injury associated with the use of the Planar HUT, three potential options are available:

1. Astronauts use the Planar HUT for training and flight (current baseline).
2. Astronauts use the Planar HUT for flight and either the Pivoted or the Planar HUT for training.
3. Astronauts use both HUT designs for flight and training.

Determination of the most appropriate option should be based on a balance between the risk of shoulder joint failure in the Pivoted HUT and the risk of major shoulder injury during EVA training in a Planar HUT. A Criticality 1 failure of a Pivoted HUT shoulder joint in space is a very significant, potentially life-threatening risk. Failure of the Pivoted HUT shoulder joint in the NBL is a significant risk, albeit one that has been accepted during ISS training as the existing Pivoted HUTs are gradually phased out. A major shoulder injury requiring surgery from training in a Planar HUT is a highly significant health risk to the astronaut and a risk to mission success.

For the majority of astronauts, using a Planar HUT for training and mission EVAs may be tolerable in the short term, provided the risk of shoulder injury is mitigated. Mitigation of the risk of shoulder injury includes a combination of optimum conditioning, suit fit, avoidance of inverted operations with reduction of high-risk tasks, and provision of neutrally buoyant tools. This approach should be integrated with an overall plan for suit redesign to reduce the risk of shoulder injury to an acceptable level.

Some astronauts may not be able to train in the Planar HUT without significant risk of shoulder injury due to a combination of their size/physique and the specific constraints of the Planar HUT shoulder design. On a case-by-case basis, individuals who trained without injury in the Pivoted HUT in the past could lower their risk of injury by training in the Pivoted HUT rather than the Planar HUT. There are a number of potential problems associated with this approach. The added

cost to maintain a fleet of Class III Pivoted HUTs is significant and there is negative training associated with utilizing hardware different from flight. There is also a risk of suit shoulder joint failure using the Pivoted HUT in the NBL and the Pivoted HUT is not a direct drop in within the suit-sizing scheme. In view of these concerns, the choice of training in a Pivoted or Planar HUT should not be based solely on crew preference but should be made based upon additional suit fit and anthropometric data as well as clinical input from the Flight Surgeons.

The continued utilization of the Pivoted HUT for flight is technically feasible but creates several significant concerns. These include accepting four additional catastrophic risks, impacting the weight/volume to deliver EVA hardware to orbit, in addition to the cost to produce, refurbish, and update the current pivoted HUT configuration. ISS logistics are made more complex since a common ORU interface for EVA hardware was implemented when the program moved to the Planar HUT. The Pivoted HUT design does not contain ORU features and cannot be integrated with existing EMU life support systems. Currently, the Pivoted HUT is not a simple “drop in” to the current EMU configuration. Use of these HUTs on ISS increments would require additional suit items to be launched since these items have interfaces unique to the Pivoted HUT. Finally, there are supplier supportability issues with respect to the bellows material that would have to be overcome to ensure continued availability of this item.

The ultimate correction for the Planar HUT shoulder design is to redesign the joint to accommodate the normal acromioclavicular and scapulothoracic movement required for shoulder movement. Moving the location of the scye bearing joint inward would reduce the restriction to acromioclavicular movement. During development of the Small Planar HUT, the scye bearing joint was moved partially inward of the neck ring. This cannot be achieved on all HUT sizes because donning and doffing the suit becomes difficult, if not impossible.

Cost and schedule are significant issues in considering the viability of an option to redesign the Planar HUT shoulder joint. Based on experience with modifications to the XL HUT any “tweak” to a HUT would most likely take 4-5 years and between \$5-\$15 M depending on the changes, the ability to retrofit the existing fleet, and the number of units purchased. Given that the majority of complex ISS EVAs will occur over the next three to five years, the solution of shoulder redesign alone would not significantly mitigate the risk of training injury for ISS EVA.

Another solution would be to begin development of a new Pivoted HUT, one that does not have the same risks as the original pivoted design. The schedule and expense would be similar to or greater than the Planar HUT redesign and would only be a rough estimate, since a fleet replacement would be required. Although the HUT design should ultimately be improved, the other recommendations documented in this report should be immediately implemented to reduce risk of EVA training-related shoulder injury. It is the opinion of the Co-Chairs of the tiger team that the resources and time that would be required for redesign of the shoulder joint would be more appropriately spent on the accelerated development of the next-generation EMU. This would not only mitigate the risk of training-related shoulder injury, it would resolve a number of other problems with the current EMU and support the development of a number of different sizes of suits as well.

5.2 Advanced Suit Design Considerations

The next-generation space suit must be designed to allow proper movement and function of the shoulder joint to minimize the risk of shoulder injuries.

As with every space suit, the design goal should be to allow freedom of movement throughout the nude body range of motion. When pressurized, the suit should not compromise or restrict the user's ability to move naturally. The suit design should incorporate easy donning and doffing, and should not require the user to flex to the extremes of their range of motion. Advanced suit designs need to consider alternate entry concepts, such as a rear-entry configuration as used in both the Russian Orlan and the NASA advanced technology MK III (H-1) space suits. Future suits should also consider training environments, including 1 G, the NBL and partial-G/0-G simulators as part of the design criteria.

Traditionally, EMU design has been the realm of engineers, who have some knowledge of human factors, but are not necessarily experts in all the complexities of human anatomy, anthropometrics, and kinesiology. The future advanced space suit should involve all relevant specialists, including orthopedic physicians, in the design phase. This should help resolve many of the man-machine interface problems that EMU space suit assembly engineers have dealt with for twenty years. Suit design should emphasize keeping contact points away from the body, rather than padding the body to shield it from hot spots.

New suit designs should use the NASA Standard 3000 anthropometric standards (based upon international data) and anthropometric data for astronauts should be consolidated into one organization at JSC. Through advances in technology, the once time-consuming process of modeling the human body in three dimensions can be accomplished in a matter of minutes using a laser scanner. It is now possible to scan a wide array of subjects, build various body models from the data, and design a suit based on them in a relatively efficient manner. This technique supports the integration of three-dimensional anthropometric data with CAD models to evaluate joint designs through a wide range of movements.

Using laser-acquired three-dimensional anthropometric data, a suit-sizing algorithm can be developed for critical anthropometric measurements. While laser scanning may be a more accurate way for initially determining size and fit, future suit elements should be modular and incorporate vernier sizing features to accommodate individual variability in suit fit with subsequent subjective recommendations for small sizing adjustments.

Section 6 Suit Fit to Prevent EVA Training Shoulder Injuries

6.1 Optimizing Suit Fit to Prevent Shoulder Injuries

6.1.1 Background

Typically, the EMU processing contractor, United Space Alliance (USA) EMU Integrated Process Team, provides EVA astronauts space suit sizing services for flight and training. The sizing process begins when the astronaut is measured for anthropometric data. During this event, the Suit Technicians, under the direction of the Sizing Engineer, take body measurements to determine the size of the suit components that will be used to build the suit for the initial suit fit check. Of the approximately 120 initial anthropometric measurements that are currently taken, the Engineer uses only about 25 to size the space suit for the initial fit check. Two of the measurements are used to set up a Crewmember-Specific Coordinate System for space suit sizing “repeatability.” The remaining data is sent to the manufacturer (ILC Dover) for use in determining potential designs for future space suits. The anthropometric measurements are performed in accordance to Appendix A. of Doc. 0111-70046 Rev. G.

The data gathered at this event is a starting point for the suit iteration process. Once the anthropometric data is obtained, the Sizing Engineer enters the data into the USA Shuttle equipment tracking system database. Suit component sizing is calculated by an internal program, which was initially developed in the early 1980s by Hamilton/ILC and is a direct correlation of calculations in 0111-70046 Rev G. The HUT size calculation for this program is based on chest breadth, bi-deltoid breadth, chest circumference, expanded chest depth, head length, and head breadth. The sizing algorithm uses this data to predict the best fit for a Pivoted HUT. The Planar HUT size is then selected based on the identified Pivoted HUT size. ILC has not published a matrix relating anthropometric dimensions to Planar HUT sizes.

Next, the EVA candidate is scheduled for a 1-G suit fit check. For this fit check, a Class III SEMU (the HUT attached to a PLSS mock-up) is mounted in a donning stand, and the crewmember dons the HUT from a standing position. The donning stand allows vertical movement to adjust for each candidate’s height (Refer to Figure 6-1). At this fit check, the crewmember typically is provided with two full suits: one with a Pivoted HUT and baseline space suit assembly softgoods and one with a Planar HUT and enhanced space suit assembly softgoods. For the initial fit check, the LCVG is outfitted with a pair of –338 LCVG Pads centered approximately over the acromion. This has been a traditional initial pad configuration for the last 15-20 years.

A sample of available crew comfort options is presented to the crew at the initial suit fit check. The options are geared toward LCVG pads, vent duct configurations, drink bag configurations, valsalva devices, and Fresnel lenses. The crewmember is also provided a USA handout entitled “EMU Crew Options,” so that they will have a reference for what was presented. Typically, one Sizing Engineer and two Technicians oversee the fit check and no other experienced crewmembers are present. From time to time, one of the MOD instructors will support this

session, but this is rare. During the initial fit check, the suit engineer explains to the crewmember what to look for to obtain an optimal suit fit, and the crewmember evaluates the suits and gloves for adjustments and problems in a vertical and a horizontal position. The vertical evaluation is conducted in the EMU donning stand; the horizontal evaluation occurs with the suited crewmember on their back. The vertical and horizontal evaluations include an assessment of the crewmember's ability to access and operate DCM controls, arm length evaluation, lower torso assembly length evaluations, crotch height/waist length evaluations, glove fit comments and the identification of pressure points and issues.



Figure 6-1 Fit check in donning stand.

All results are documented in a Post-Test Summary that is distributed to the specific crewmember and the EVA community. As a part of the post-test process, USA enhanced hardware databases and Shuttle equipment tracking system databases are updated to show the sizing that was a result of the event. In addition, glove sizing sheets, pad placement sheets and crew option databases are updated. The crewmember's initial fit check is followed by a series of NBL and "Prep and Post" Events. At each event, a USA Engineer is present to obtain data, make sizing changes, and to present suggestions to solve comfort/sizing issues reported by the crewmember. The results for each event is documented in a Post-Test Summary and the USA databases, glove sizing sheets, and comfort pad selection sheets are updated, so that the appropriate suit sizing and options are provided at each subsequent event.

It is important to note that optimizing suit sizing for training will not necessarily provide an optimized fit on orbit. This is primarily due to three issues: on-orbit spinal elongation, body fluid shifts, and the absence of the 1-G influence on the body position within the suit (the body tends to center itself in the suit volume in 0 G). EMU sizing for on-orbit use typically incorporates an

additional 1” in suit length to accommodate spinal growth experienced in 0 G. Studies have confirmed an elongation of the vertebral column between 5–7 cm in simulated microgravity and on orbit (Styf et al. 1997, Hutchinson et al. 1995, Ledsome et al. 1996, Wing et al. 1991). Optimizing suit fit based primarily on NBL runs can in some cases lead to on-orbit fit problems. Similarly, the comfort pads that are used to alleviate point loading that occurs during 1-G training are not necessary for flight. Padding is traditionally provided for flight to maintain volume similarities to minimize negative training effects. An exception to that is padding used to protect from suit components that are too small.

Based on the findings of the tiger team, the suit sizing requirements and constraints documents need to be updated. These updates should be maintained at the appropriate level to retain control and configuration management. The updated sizing requirements should address the concerns about optimal shoulder sizing noted in this report. Ideally, a Planar HUT size should be selected to locate the scye bearing joint as close as possible to the inner third of the collarbone. Suit sizing should also incorporate a minimum clearance between the top of the shoulder and the HUT, if physically possible. Some astronauts prefer a “tight” fit in the shoulder of the suit, not realizing that it will decrease the mobility of their shoulder joint and increase their risk of injury. Finally, establishing new requirements and constraints to enhance shoulder mobility needs to be worked in parallel with similar constraints and requirements for 0-G growth, boot fit and other known sizing issues.

6.2 Shoulder Padding and Load Alleviation

6.2.1 Background

Padding, Teflon inserts, and harnesses in various combinations are used in the suit to relieve “hot spots,” provide load alleviation, and position the subject's upper torso in the HUT. Padding, described in detail below, is typically used to relieve pressure points. Harnesses and/or padding with Teflon inserts can be utilized to alleviate loads by spreading a point load over a larger surface area.

6.2.2 Current Pad Configuration

A variety of pads is available for use in the EMU. These pads were designed to reduce hot spots created by suit contact with the shoulders, elbows, ribs, or knees. Generally, the pads effectively protect the crewmember from interior surfaces of the suit. The pads are made from mosite, which is O₂-compatible closed-cell foam. The pads are inserted into spandex pockets that are form-fitted to each pad, and these are whip-stitched to the LCVG.

The most commonly used pads are the -335/-336 and the -338 configurations (Refer to Figures 6-2 through Figure 6-4).

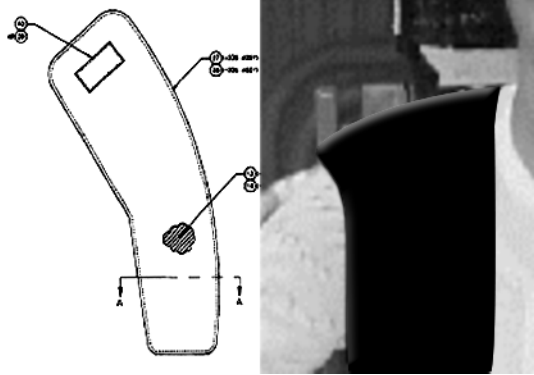

Figure 6-2 -335/-336 shoulder pad.

The -338 configuration is a 0.25"-thick pad approximately 6" long by 4" wide. A pair of these pads is stitched to the top of the shoulders and primarily serve to protect the crewmember from the HUT shell and scye bearings.

The -335/-336 configurations (they are mirror opposites of each other) are 0.25"-thick curved pads that are approximately 15" long and 5" wide. These pads protect the crewmember from the shoulder blade to the pectoral region. The primary purpose of these pads is to shield the crewmember from the scye bearings.

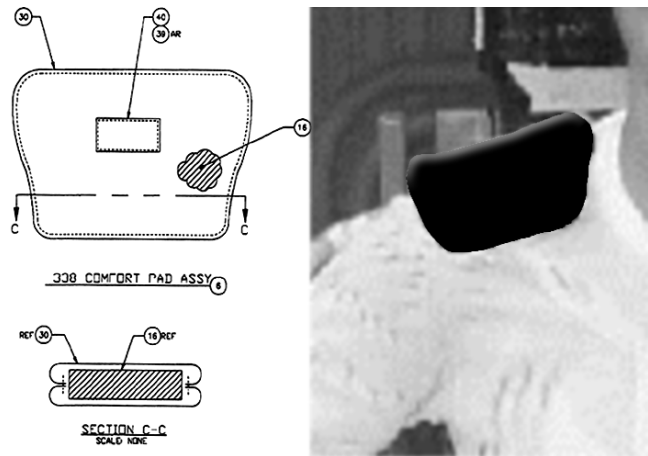

Figure 6-3 -338 padding.

Both configurations of pads have remained essentially



Figure 6-4 Combination of -335/-336 and -338 padding.

unchanged since their inception approximately 15-20 years ago. Recently, circa 1995-1997, an insert made from a Teflon sheet was developed for the -335/-336 pads. This insert is approximately 0.0625" thick and is placed in the pocket with the mosite pad on the outside. In this configuration, the potential for developing hot spots is further reduced since any point load caused by the scye bearing joint is distributed over a larger surface for the mosite pad to absorb. Teflon inserts for the -335/-336 and -338 pads have been formally developed and offered to the crew for 1-G training since 2002.

With the transition from the Pivoted to the Planar HUT, it was presumed that pressure points would be essentially the same, and no pad studies or tests were performed to evaluate potential size or configuration changes to the LCVG shoulder pads.

In addition to shoulder pads, other pads such as the crotch pad and the back pad are used to improve the crewmember's position in the suit. These pads come in various thicknesses and allow the crewmember to better position themselves in the HUT to improve visibility and/or reach.

6.2.3 EMU Shoulder Harness

Before the introduction of LCVG shoulder pads, a padded shoulder harness was installed in the HUT to isolate the crewmember from potential pressure points (Refer to Figure 6-5). The shoulder harness is a 1"-wide nylon webbing affixed to the HUT near the body seal closure. It attaches at the one, six and eleven o'clock positions on the body seal closure, and is laced to the left and right sides of the HUT neck ring. When installed in a HUT, the harness looks similar to a pair of suspenders. The harness has 0.25"-thick padding and a 0.625"-thick strip of Teflon at the shoulders to absorb the load imparted to the crewmember by the suit. The shoulder harness is a crew option that was originally certified for the Pivoted and Planar HUTs, but is rarely used.

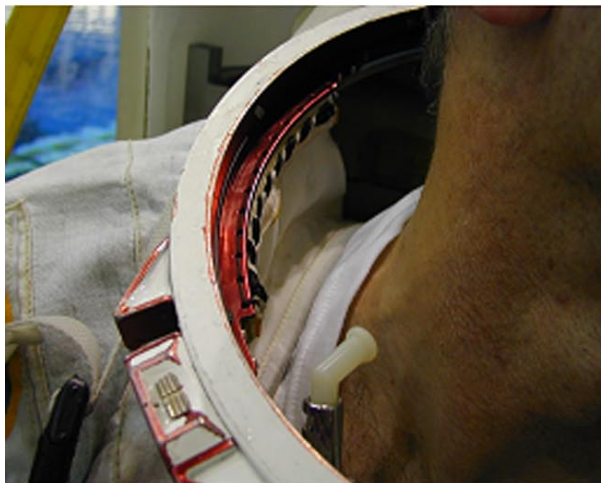
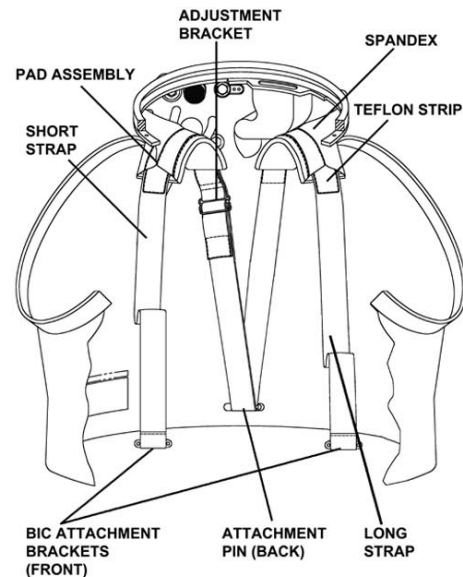
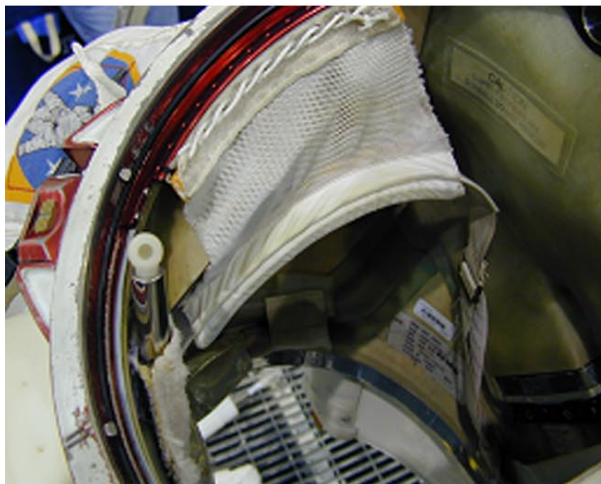

Figure 6-5 View of shoulder harness from top.

6.2.4 Evaluations of Various Padding and Load Relief Combinations

Based on discussions with EVA crewmembers, it is apparent that many of them were not aware of the variety of padding and harness options available to them. Nor were they aware of the pad combinations allowable, especially in the case of utilizing Teflon inserts and use of the EMU

harness. Many experienced crewmembers were unaware that Teflon inserts were offered and none of the current EVA astronauts were aware that the EMU harness was available. Many crewmembers typically use what was shown to them at the initial fit check for at least the first few runs in the NBL. Anecdotal data from suit sizing engineers and EVA crewmembers indicates that astronauts are most familiar with the smaller -338 pad (without Teflon), as this was the configuration provided at the initial fit check.

During the initial investigation of shoulder injuries, several NBL runs were used to evaluate the use of padding and harnesses. The focus was to determine the effectiveness of various padding and harness configurations to prevent minor shoulder injuries without degrading task performance (mobility and overall fit). The following evaluations were performed:

Date	Crewmember / Test Subject	Evaluation
1/17/03	Williams	60 minute NBL evaluation (part of 6 hour development run). Subject wore harness and no pads. (Reference Appendix B)
4/7/03	Williams / Walheim	Dedicated 4-hour NBL evaluation. Both subjects wore the harness and nominal pad configuration with no Teflon insert. (Reference Appendix C) Subjects performed several contingency and ISS assembly related tasks. Total inversion time for each subject was close to 1 hour.
5/23/03	Williams	STS-118 training inverted body position for S5 install. Subject wore harness and nominal pad configuration with no Teflon insert.
8/25/03	Williams	STS-118 training inverted body position for S5 install. Subject wore harness and nominal pad configuration with no Teflon insert.

Testing the shoulder harness and various pad configurations suggests that the combination of the two can be effective in reducing the loading of the scye bearing joint on the crewmember’s shoulders. However, no single combination of the shoulder harness and LCVG pads will work for the entire population. Use of these items does not appear to significantly impair mobility in the suit, or negatively affect training. Additionally, pads and shoulder harness modification is indicated to more effectively distribute the load without restricting donning and doffing the suit.

6.3 Laser Scanning

As part of the investigation into the problem of shoulder injuries during NBL training, the Anthropometry and Biomechanics Facility research team was tasked to provide their input into suit sizing and design. The specific tasks they were assigned to perform are listed in Appendix A.

Generally, the Anthropometry and Biomechanics Facility provided anthropometric data to help understand the issue of restricted or compensated shoulder movement for subjects wearing different elements of the EMU (LCVG and the HUT). To do so required completing the following tasks:

- Compare and contrast the differences in HUT dimensions and the crew anthropometry.
- Exemplify the benefits of laser scanning to optimize the initial suit fit.
- Calculate the forces needed inside the suit to articulate the joint bearings.
- Evaluate biomechanically the effectiveness of shoulder harness.

Due to time constraints imposed, the tiger team did not conduct calculations of the joint torques and contact forces in different suited body orientations. Although the team conducted limited studies of the EMU harness, further biomechanical analysis would be of benefit in updating the harness design.

Whole body laser scanning is a state-of-the-art technology that is used to measure three-dimensional human body dimensions. In contrast to the traditional anthropometric measurement technique (a manual measurement, which measures the dimensions one at a time, in a linear fashion), whole-body scanning allows the user not only to measure linear measurements but also to record areal and volumetric information. Since the scanning time is approximately one minute, it is possible to collect standardized linear measurements within a matter of minutes. Specific linear and volumetric measurements can be programmed so that these measurements can also be obtained for all the subjects in a standardized manner. Even though the laser scanner is designed to gather data in one standard posture, we were able to test its capability by using it to measure body dimensions in various postures. This allowed documenting the stages of shoulder movement during various abducted shoulder positions.

In summary, the following work was completed:

- Subject was laser scanned unsuited, with different levels of abduction of the right shoulder joint (0, 30, 60, 90, 120, and 150 degrees).
- Subject was laser scanned while wearing the LCVG, with different levels of abduction of the right shoulder joint (0, 45, 90, and 135 degrees).
- The laser scans were triangulated using the ‘Scan Worx’ software and imported into AutoCAD for viewing.
- Mechanical drawings of a S, M, L, and XL Planar HUT were obtained. Wire drawings of the Land XL Planar HUT were completed in AutoCAD.
- The wire drawing of the XL Planar HUT was merged with a laser scan of the subject.
- Two pressure-mapping systems were evaluated.

6.3.1 Unsuited Laser Scans

Figure 6-6 shows the laser scans for the unsuited subject. These scans were taken at 0, 30, 60, 90, 120, and 150 degrees of shoulder joint abduction. The three-dimensional volumetric reconstruction of the shoulder joint movement confirms the anatomical description normal of acromioclavicular and scapulothoracic motion associated with shoulder abduction. The laser data suggests that there is not considerable elevation of the acromioclavicular joint until more than 90° abduction is achieved.

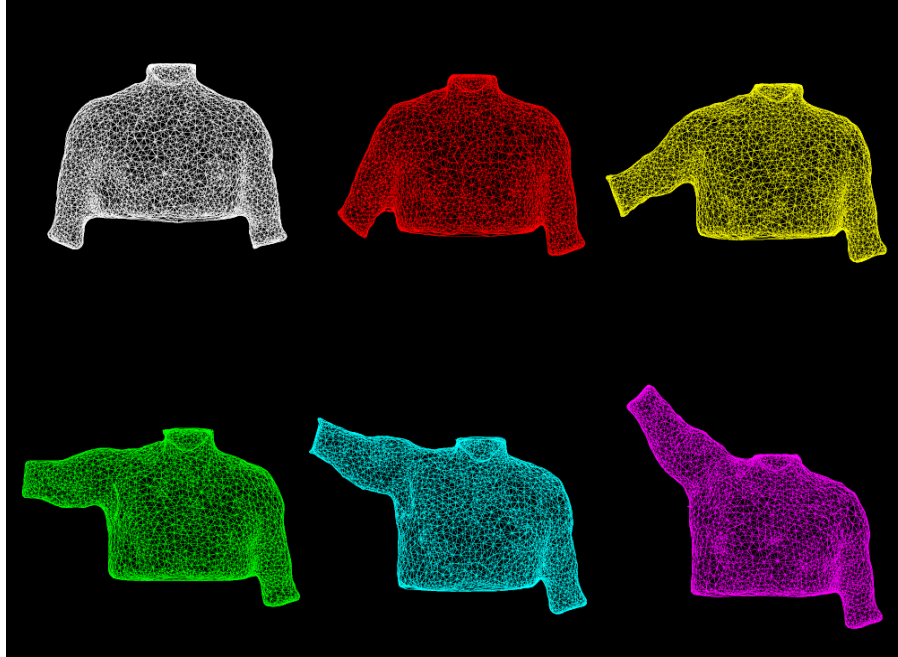

Figure 6-6 Shoulder position at 0, 30, 60, 90, 120 and 150 degrees of shoulder abduction in unsuited subject.

6.3.2 Suited Laser Scans

Figure 6-7 shows laser scans while the subject was wearing an LCVG. These scans were taken for 0°, 45°, 90°, and 135° of shoulder joint abduction. As in the case of the subject wearing the thermal insulation garment, no considerable change exists in the elevation of the acromioclavicular joint of abduction proceeds past 90°.

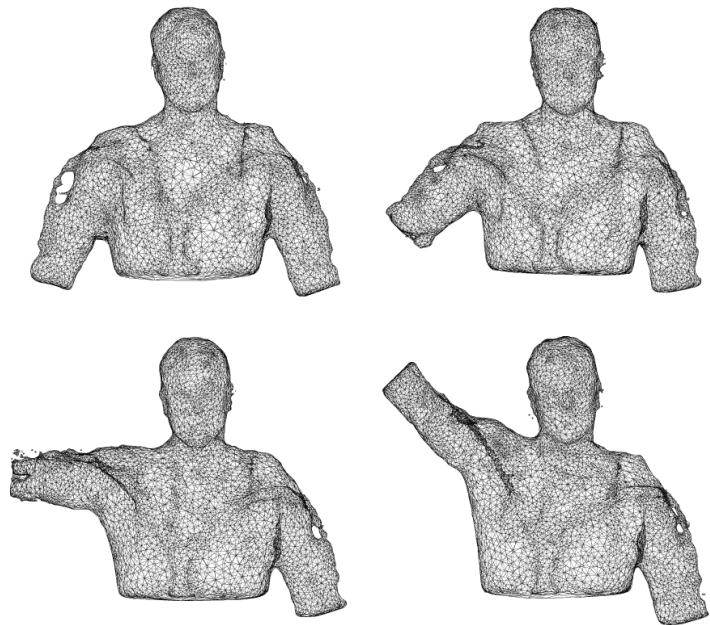

Figure 6-7 Shoulder geometry for 0, 45, 90, and 135 degrees of shoulder joint abduction while subject is wearing LCVG.

6.3.3 Merging of Wire Drawing of XL Planar HUT and Laser Scan

Figure 6-8 shows a wire drawing of the XL Planar HUT merged with a scan of the unsuited subject. The cylindrical rings on either shoulder represent the scye openings of the HUT. Using the technique of overlaying suit sizes on anthropometric data, it is possible to predict where the scye openings will begin to restrict shoulder movement for different-sized subjects.

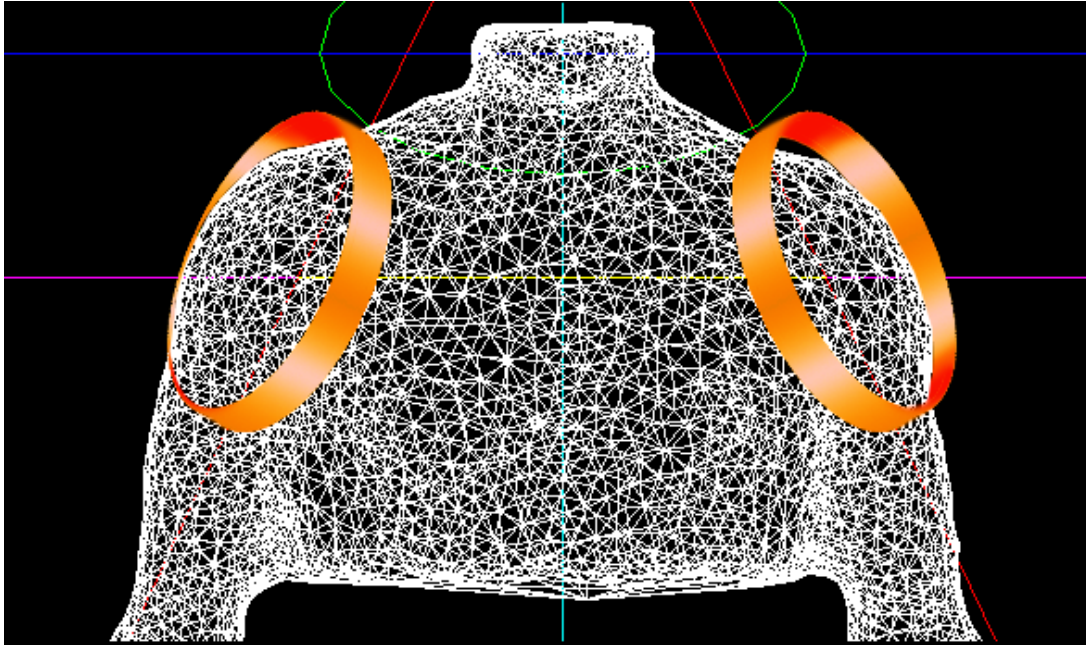

Figure 6-8 Wire drawing of XL Planar HUT merged with laser scan of unsuited subject.

6.3.4 Laser Quantification of Shoulder Movement

The position of the acromioclavicular joint and mid-clavicular region were identified and recorded in different degrees of shoulder abduction. Four cm elevation of the mid-clavicle and 6 cm elevation of the acromioclavicular joint were noted over 150° of shoulder abduction. These measurements were also repeated with a subject wearing an LCVG. The data with and without the LCVG are similar until the shoulder moves beyond 110° abduction. At that point, it appears that the LCVG folds in the area overlying the acromioclavicular joint, causing the further elevation of the LCVG. This data is of particular interest in evaluating suited shoulder movement.

The scye bearing joint of the suit is a fixed point that blocks acromioclavicular and scapulothoracic motion. For subjects with approximately 1 cm clearance between the top of the shoulder pad on the LCVG and the scye bearing joint, normal shoulder movement will occur with abduction to 30° – 50°. Beyond that point, the scye bearing joint will restrict acromioclavicular and scapulothoracic motion. Abduction beyond 110° may be associated with the possibility of LCVG folding (Refer to Figures 6-9 and 6-10), which may have an additional effect of downward displacement of the clavicle and acromioclavicular joint.

The magnitude and importance of this folding will likely depend upon individual suit fit, but serves to illustrate the complexities of suited shoulder movement. Further studies are required to determine the cumulative effect of shoulder padding on the LCVG and restricted shoulder movement in the Planar HUT.

Shoulder contour At Different Shoulder Joint Angle (Without LCVG)

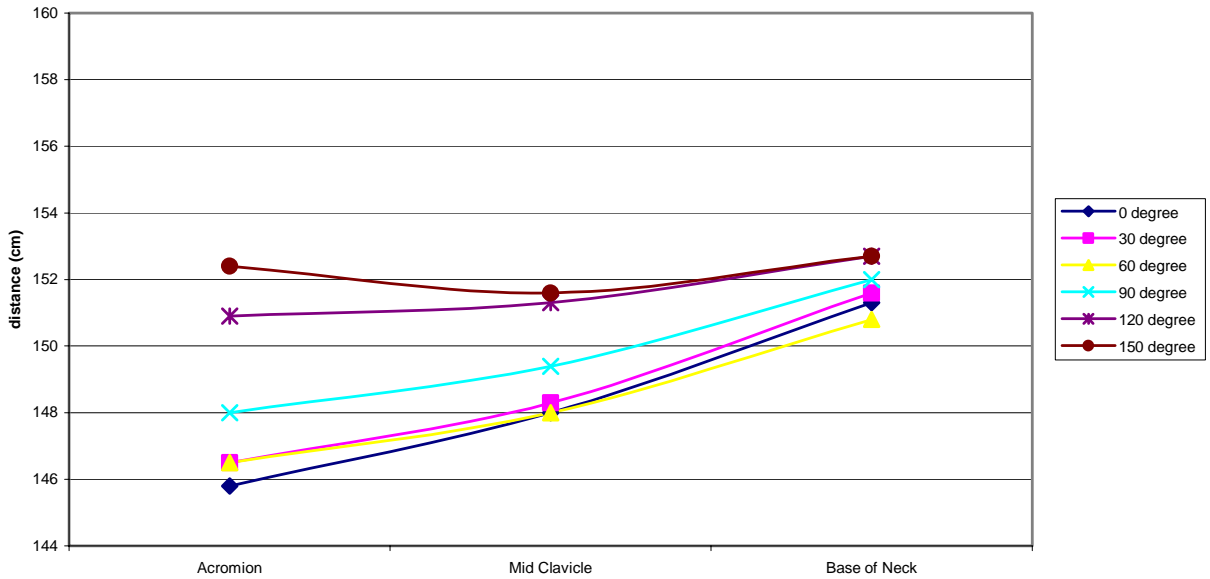

Figure 6-9 Displacement of acromion, mid-clavicle and base of neck from laser scan data.



Figure 6-10 Displacement of acromion process taken from laser scans.

6.3.5 Pressure-Mapping Systems

The tiger team evaluated two real-time pressure-mapping systems, from the XSENSOR Technology Corporation and from Vista Medical, to measure the contact pressure between the HUT scye bearing joint and the shoulder. Both companies are able to design custom sensors for the purposes of the measuring the contact pressure at the shoulder area.

6.3.6 Laser Scanning Conclusions

The following findings are noteworthy. The laser scans of the subject during incremental shoulder abduction showed very little elevation of the shoulder area as long as the abduction was less than 90°. Significant shoulder and mid clavicle displacements were noted when the subject abducted beyond 90°. The HUT restricts these movements, resulting in impingement of the rotator cuff.

This information could be useful in planning activities to be performed in the space suit. If possible, limitation of shoulder joint abduction while performing tasks in the EMU could reduce the amount of discomfort from contact with the scye openings.

As mentioned previously, the wire drawing of the XL Planar HUT merged with the laser scan of an unsuited subject shows where the scye openings restrict shoulder movement. This merging of subject scans and wire drawings of HUTs could be extremely useful in evaluating the benefits of different-sized HUTs on shoulder movement.

In conclusion, the work done with the laser scans provides significant information that can be used to understand the mechanism of shoulder discomfort/injuries and to reduce shoulder discomfort through optimal sizing. These findings have not yet been fully tested and thus, solid conclusions on the effectiveness of laser anthropometric data in reducing shoulder discomfort cannot be made at this point. Further verification would involve testing using guidelines for shoulder abduction during in-suit activities. The information coming from these tests would also be more useful if the contact pressure at the shoulder/suit interface were also measured using custom pressure mapping systems. Finally, we firmly believe that laser scanning is a more efficient tool than manual measurement of the crew, since it eliminates measurement errors by different operators. Additionally, the three-dimensional data from the scanner can be a vital tool for looking at interference issues that are not normally identifiable from the standardized manual measurement techniques.

Section 7 Task Modification to Prevent EVA Training Shoulder Injuries

7.1 Definition of EMU Work Envelope

The definition of the EMU work envelope depicted in Figure 7-1 is documented as a guideline. As such, it should be used in support of defining extravehicular worksite locations and procedures. It does not necessarily represent the maximum reach of suited crewmembers in all directions. The crewmember is capable of accessing locations outside of this envelope on a periodic basis. These include purge valves, helmet lights, SAFER controls, and EMU Display and Control Module switches and knobs. This EVA work envelope needs to be updated to ensure that it incorporates the Pivoted and Planar HUT configurations and that it reflects the different sizes of the EVA astronauts. Once updated, this envelope should be used to develop and evaluate EVA tasks, procedures and hardware. Handling tools outside of this envelope repeatedly can lead to shoulder injuries.

7.2 ASCAN Training and EVA Skills

MOD's EVA Systems Group (DX35) and EVA Task Group (DX32) train astronauts and develop EVA procedures. In response to the shoulder injury investigation, this group developed an internal survey to question flight leads and certain NBL personnel on potential issues or concerns that may relate to shoulder injury. A summary of the results is presented in matrix form in Appendix D. The survey suggests that, although each trainer has their own style, none of them have unreasonable expectations with respect to requiring intense overhead or inverted operations. There is no expectation for crews to “tough it out.” The results indicate that crews are briefed before every run to avoid overtaxing themselves physically. However, concern exists about crewmembers becoming so focused on performing tasks that they may be consciously or unconsciously ignoring signs of fatigue. DX suggests that a caution block be added to each lesson plan to ensure the flight lead and NBL representatives are consistently made aware of the potential for shoulder injury.

7.3 EVA Training (Documentation and Sequence)

A crewmember is first introduced to the EMU hardware at the Class III fit check, as described in Section 8 of this report. Up to the point of the first NBL dive, the crewmember has received astronaut candidate introductory training on suit operations from MOD personnel. The first class for a suited subject run in the NBL is defined in “EVA Qual. Ops 21027.” According to this lesson plan, the initial run is to “familiarize the student with general EVA operation required to perform a task in the [Space Shuttle] Payload Bay.” This initial run is estimated for 3 hours and involves performing the following tasks:

- Tether manipulation and safety tether routing
- PSA or TSA operations and tool management, and stowage

- MWS donning
- PLB translation techniques
- Touch and no-touch items in the PLB
- Keep-out zones
- Radiator disconnect procedure
- Winch operations
- PDU disconnect procedure
- Generic jam removal techniques and cutting demonstration
- Perform suited exercise in the water for familiarization with sudden suit pressure relief of the gloves (WETF Standard Operating Procedure T-103)*

The next set of suited NBL runs focuses on orbiter contingency tasks, and the associated lesson plans are documented in “ORB CONT 21027/31027” and “ORB CONT 22027.” Each EVA for these lesson plans is estimated to require 3.5 hours of NBL time.

7.4 Suit Familiarization in the NBL

For these runs, evaluation of suit fit and familiarization with suit operation is not a primary objective. Several subjects noted that, during their first NBL run, they immediately focused solely on the tasks to be performed and not on assessing suit fit and mobility. At the end of each run, the crewmember has the opportunity to provide comments to the suit engineer and technician poolside. It has become apparent that a portion of the initial NBL runs should be dedicated to familiarization with the NBL environment, suit fit, suit mobility, and importance of a proper weigh-out.

7.5 Training in Inverted Orientation or Areas With Poor Accessibility

Training in the NBL in an inverted position was a major concern of this tiger team. The known and possible effects of being inverted are documented elsewhere in this paper. Because of the size and complexity of the ISS mock-up in the NBL, it is not always feasible to reposition the modules for upright worksite access. For this reason, it is impossible to avoid some inverted training with the current ISS NBL configuration.

The ISS mock-ups within the NBL currently are configured in a “tuning fork” configuration, with the zenith of each mock-up facing upwards in the pool. Mock-ups can be reconfigured as necessary to enhance training, however there are trade offs that must be made. An after-hours reconfiguration shift is currently employed to reorient ISS module mock-ups. However, major reconfigurations require more time and may delay overall training. DX performs configuration reviews to assess the necessary changes. Up to now, limiting the amount of inverted training has not been a constraint. Future reviews and any major changes in the operation and management of NBL mock-up configurations must take into account the impacts of increasing the amount of training in an inverted position.

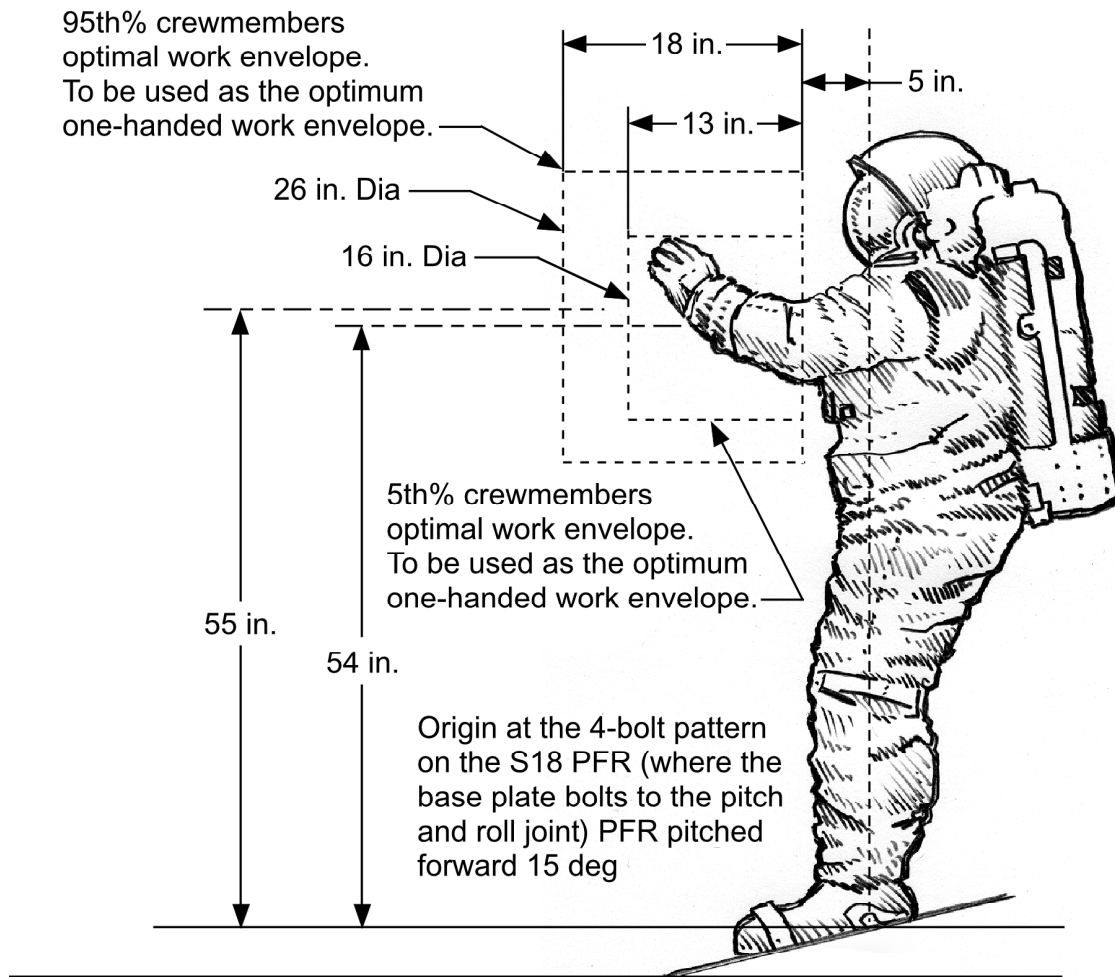

Figure 7-1 EVA work envelope.

(Reference NSTS 07700, Volume XIV; Appendix 7, p. 1.5-3; NASA-STD-3000 500)

In preparing crewmembers for ISS assembly, the amount of inverted training time has increased. DX instructors estimate that almost 50% of the possible skill worksites require access while inverted. DX flight leads believe that they limit the crew's inverted working time to approximately 10% of any given skills run. However, the amount of time an individual is allowed to remain inverted is not currently constrained or tracked. Although the NBL doctors and Flight Surgeons have no formal requirement regarding cumulative inversion time, the DX assumption for EVA candidates going through skills training is that they should be limited to 10-15 minutes of sustained inversion with at least a few minutes of rest between inverted tasks. Within the lesson plans described above, there are no notes for the trainers with respect to either concerns associated with training inverted or time limits while inverted.

During flight-specific training of EVA crewmembers, several tasks require inverted operations or have poor accessibility, requiring the crewmember to work outside the preferred EMU work

envelope. For Shuttle EVAs, this includes many Hubble repair tasks and airlock egress. For ISS-related tasks these include airlock egress, accessing work site interfaces on the zenith side of the trusses, inverted APFR ingress, and Flex Hose Rotary Coupling. As an example, for ISS flight 12A, the tasks associated with the launch locks require 30-40 minutes of inversion. In this specific case, the attachment point is on a circular ring and there is no way to rotate the NBL mock-up to avoid inverted training. These activities may be viewed as acceptable or very difficult, depending upon the crewmember involved.

7.6 Frequency of Training in the NBL

Another major factor contributing to shoulder injury is the frequency and duration of training events. The shoulder injuries identified in the survey were most likely the result of repetitive overhead motion. During the first decade of the Shuttle Program, weightless training was conducted in the WETF. The WETF was considerably smaller than the NBL. Its primary mission was to act as a simulator for EVA operations in the Shuttle payload bay. Due to its configuration, inverted operations were rarely performed. WETF operations were also shorter in duration, lasting between two and four hours. NBL operations, in contrast, last from four to six hours.

Currently the EVA community believes training ratios should be limited to a maximum of 10 to 1, while ensuring mission success. Since the beginning of ISS assembly, this training ratio has on average hovered around 11.6 (Refer to Figure 7-2).

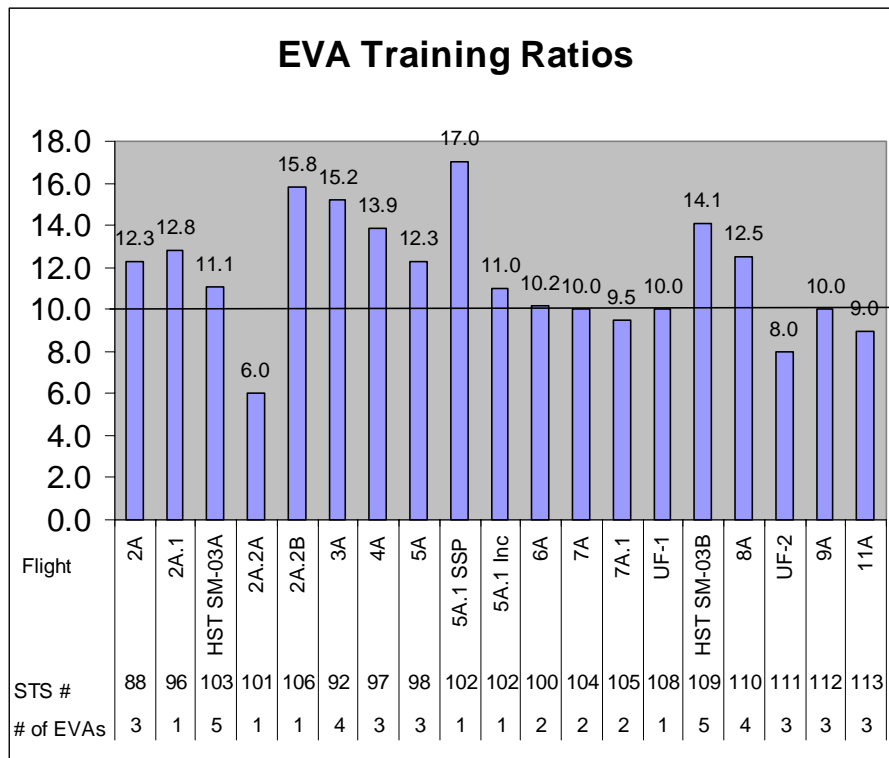

Figure 7-2 Ratio of NBL training for ISS missions.

Of course, cumulative training is not the only factor; the “density” of this training is probably a greater contributor to shoulder injuries. Typically, the maximum number of runs seen in NBL training per week is three. While the number of runs in one week may not lead to the onset of a shoulder injury, performing one to three runs per week over several weeks can lead to overuse injuries, since the body has little time to heal. One of the cases of shoulder injury severe enough to require surgical intervention occurred in an astronaut who periodically performed blocks of frequent NBL training. On separate occasions, this individual trained in the NBL 7 times in a 14-day period, 4 times in a 6-day period, 6 times in a 10-day period, 5 times in an 8-day period. On a number of other occasions, this individual performed several NBL runs in a short amount of time. In one week, he performed three NBL training runs in three days. This number of runs in such a short amount of time does not allow for adequate recovery for any minor injuries or inflammation.

Limits on the frequency of NBL training need to be established. While experienced crewmembers who participate in regular exercise programs designed to prevent injuries may be able to perform three or more NBL training runs per week, other less experienced and less fit crewmembers may not. All crewmembers who participate in upwards of three NBL training events per week should be monitored more closely.

7.7 Diver Assistance in the NBL

Another concern related to NBL training is the perception of receiving assistance from the dive teams. Several operations, especially those utilizing heavy high-fidelity tools, require periodic diver assistance. It is up to the astronaut to call out when assistance is desired, although there may be a misperception that asking for diver assistance is a poor reflection on the astronaut’s ability to complete a given task. As a result, diver assistance is not consistently requested. The NBL lesson plans (mentioned above) do not contain suggestions on when diver assistance is appropriate, although there are one or two instances describing when diver assistance is not allowed.

7.8 Use of Heavy Tools

As described above, non-neutrally buoyant tools are used in training. The heaviest of these are the Pistol Grip Tool (PGT) high-fidelity NBL trainer, the Torque Multiplier, the Centerline Latch Tool, and the 3-Point Latch Tool. The Pistol Grip high-fidelity mock-up is used extensively for Hubble and ISS assembly training. The two latch tools are used in Orbiter contingency training, which occurs early in the EVA training program during EVA Skills training. The concern is that the excessive handling of heavy tools and the body positions required when operating these tools could overstress the crewmember’s shoulder. Working with heavy NBL training tools in the prescribed work envelope is not as significant a concern. The concern is greater with the combination of tool weight and working with the arms fully extended overhead. In these positions, damage to the shoulder muscles can occur. The most obvious solution is either to eliminate the use of the high-fidelity tools or to reduce the buoyant weight of these tools without reducing their effectiveness for training. The relevant technical information relative to these tools and findings

associated with weight reduction is discussed in the next section. The requirements for these tools are based on the following:

7.8.1 Pistol Grip Tool

Many of the Hubble Space Telescope and ISS mock-ups utilize flight-like fasteners to provide realistic “feel” for the operation of installing or removing items. Astronauts carry a neutrally buoyant version of the PGT in the NBL that is identical in size to the high-fidelity tool. The high-fidelity version may be used when driving bolts or latches. The NBL high-fidelity version weighs approximately 10 pounds, is functional, and provides the same torque settings as the actual flight unit. Weight increases further with the attachment of sockets, extensions, and/or a right angle drive. Many DX and CB representatives suggest that use of this high-fidelity tool enhances training and improves overall task simulation. Because of its size and weight, the crewmember usually does not perform NBL operations with the high-fidelity PGT in his possession. A utility diver typically hands this tool to the crewmember as needed. If there are several repetitive tasks, the crewmember may hold onto this tool for several minutes at a time.

7.8.2 Torque Multiplier

This item is used in conjunction with the PGT for certain fasteners. Operationally, it is attached to the fastener first and then the PGT is inserted. From a weight-handling perspective, the Torque Multiplier is not additive to the PGT. It is, however, a heavy tool unto itself. Currently the NBL version of this tool is almost identical to the flight version except that it provides a 1-1 vs. a 5-1 torque multiplication factor.

7.8.3 Three-Point and Centerline Latch Tools

These tools are used to ensure the Orbiter cargo bay doors are sufficiently restrained, in case of a mechanical failure, to safely deorbit. These tasks are performed in confined areas that require the crewmember to lie on their back and operate outside of the primary work envelope. Both of these tools are used during Orbiter contingency training, an early segment of the EVA training syllabus, during which the crewmembers may not have sufficient experience in the suit to have determined their optimal sizing and may not understand how to best operate the mobility joints of the suit. The NBL versions of both of these two tools are very close to the flight versions. Assistance is typically required during manipulation of these tools because of weight and their functionality in the NBL. It is believed that these tools could be made more “user friendly” in the NBL environment while still maintaining functionality and fidelity (volume).

7.9 Development Runs

Development runs are NBL runs used to determine if a hardware design meets the requirements imposed on it for EVA. During these runs, suited subjects set up worksites and actuate all fasteners and tasks as if they were on orbit. A Crew Consensus Report is then developed which rates each worksite as acceptable or unacceptable requiring redesign.

To minimize the potential for shoulder injuries during development runs, mission training, and to evaluate future EVA worksites, the development Test Conductor and CB representative will utilize the worksite envelope as defined. Furthermore, the test team will not assign a rating of acceptable for any task that must be performed outside this envelope. When the hardware cannot be altered and must be used as is, the Crew Consensus Report will continue to track that worksite as unacceptable. A greater emphasis should be made when evaluating worksites that require the test subject to work in the upper area just above the work envelope. At no time should these tasks be rated as acceptable due to the extent of the loads imparted into the subject.

Section 8 Tool Modification to Prevent Shoulder Injuries

8.1 Optimizing Neutral Buoyancy of High-Fidelity Tools

Tools used by the suited subject in the NBL are typically designed to be neutrally buoyant, while maintaining flight-like dimensions. This is accomplished by making tools out of Teflon or other lightweight plastics and by utilizing foam. For some tools, higher-fidelity versions are used to enhance training. In some cases, a flight-like copy is used in the NBL because no trainer has been designed. Utilization of heavy tools in NBL/1-G training is one of the contributing factors toward shoulder injury. The DX trainers consider the following tools to be the most likely to cause injury.

Table 8-1 Tools Considered Likely to Cause Injury

Tool	Buoyant Weight	Dry Weight	Purpose	Comments
Pistol Grip Tool (PGT)	10 lb	11.75 lb	Self-powered rotary torque tool. NBL high-fidelity unit uses same torque settings and matches speed of flight unit. No switches.	Weight started at 10 lb. In Aug. 2000 the weight was increased to 12.75 to increase fidelity (Delrin bayonettes, rotary torque collar, MCW/MTW collar and switch endcap were changed to stainless steel); due to comments from crew, foam was added and bayonettes were removed to reduce weight back to 10 lb.
PGT Accessories				
6" Socket	0.5 lb	0.5 lb		
Right Angle Drive	2.3 lb	2.3 lb		
Torque Multiplier (TM)	7.2 lb	7.2 lb	Provides a 3-to-1 torque multiplication factor. This device is attached to the fastener first and then the PGT is installed.	NBL unit is constructed of stainless steel. Torque multiplication is not necessary in the NBL.
3-Point Latch Tool	7 lb	7 lb	Orbiter Contingency tool	NBL unit is constructed of stainless steel.
Centerline Latch Tool	11.5 lb	11.5 lb	Orbiter Contingency tool	NBL unit is constructed of stainless steel.

For Hubble and certain ISS flights, the PGT is used quite extensively. It is common for the PGT to be used 2-3 minutes at a time, 10-15 times in a NBL training run. In a worst-case scenario, both shoulders could be stressed with one arm stabilizing the body and the other arm stretched out using the PGT. At the same time, depending on body position, the astronaut's arms and shoulders are also working against the torque of the suit. The EMU joint torques range from 130 to 150 in-lb. In an upright position, depending on the accessories utilized and arm length of the astronaut; this would feel like holding a 14– 18-lb object with arms fully extended.

As described in the table, the high-fidelity PGT tool has fluctuated in weight based on past comments from the crew and trainers. These comments were initially made to increase the “look and feel” of the tool but resulted in a 25% weight increase. Subsequent attempts at weight reduction led to the tool not having flight-like external dimensions. The low-fidelity version of the PGT NBL trainer also does meet the external dimensions of the flight unit.

Because there appears to be a strong link between use of heavy tools and the potential for shoulder injury there should be firm constraints on the weight of the tools used in the NBL. Future NBL training tool development (all handheld tools) should be required to weigh less than 5 lb (buoyant weight) with a goal to make all NBL training equipment neutrally buoyant.

The program should immediately initiate an evaluation to reduce the weight of heavy high-fidelity tools. In addition, work instructions and/or general design requirements should document a maximum NBL tool training weight.

Section 9 Surveillance Monitoring for Astronaut Injuries

9.1 NBL Postdive Survey

Occupational Medicine and the Human Test Support Group are midway through a prospective observational study to identify and quantify EMU suit-related symptoms experienced by all astronauts in training at the NBL. The purpose of this study is to identify EMU training-related symptoms, determine incidence by location, attribute causes, and identify effective countermeasures. The study data is collected by means of a formatted postdive questionnaire. Incidence rates will be calculated, causal mechanisms analyzed, and effective countermeasures documented. The study includes symptoms experienced at all anatomic locations, including shoulder/neck symptoms. It is anticipated that data collection will continue at least until early 2004 to meet stated study goals. While this study cannot contribute to the current tiger team investigation of EMU-related shoulder injuries, when it is completed it will be a useful tool to look at recent training-related suit symptoms, provide effective countermeasures, and enable specific prevention recommendations.

The tiger team believes that the data gained via this study to identify potential EVA training-related injuries is a tremendous asset. The tiger team therefore believes that a subset of this study be continued on a permanent basis to provide postdive surveillance of potential injury cases. In addition, a process/protocol for real-time reporting of significant issues identified during the study should be implemented.

9.2 Integrated Medical Monitoring

Several opportunities exist to detect and medically intervene in the development of shoulder injuries. Every astronaut receives an annual physical examination, including an orthopedic assessment if indicated. Likewise, the NBL physicians conduct medical evaluations of all EVA crewmembers before and after each session in the water at the NBL. Each crewmember is questioned about specific symptoms, including shoulder symptoms. Symptoms may not be immediately obvious, so the initial report of shoulder symptoms or injury may be to the NBL physicians, the Strength and Conditioning specialists, or to the FMC. At the time of report, a record is entered into the EMR. Access to the EMR is available to Flight Surgeons in the FMC and the ASCRs in the Astronaut Rehabilitation Facility. Access should be extended to the NBL before the end of 2003. Until then, NBL physicians give verbal report at the weekly medical tag-up meeting. Additionally, if the injury is serious enough to require treatment beyond first aid, verbal report is made immediately to the Crew Surgeon if the astronaut is mission-assigned, or to the FMC physician on duty. All of the above parties participate in the weekly medical tag-up meeting every Monday morning, where all medical events and trends of the previous week are reviewed. It is FMC policy that all injuries that rise to the level of OSHA recording be reported to Safety per clinic procedure.

A specialist in orthopedic injuries has been identified and will be invited on site for orientation to the EMU and training activities. The specialist will work with the FMC to review the diagnosis and treatment of shoulder symptoms and injuries and conduct training sessions for the FMC physicians. These training sessions will identify specific diagnostic tests, the clinical indications for each test, appropriate medical interventions, and trigger points for further expert consultation. This specialist will be the prime consultant for all orthopedic injuries related to EMU use. The goal is to diagnose shoulder injuries at the earliest possible stage and intervene effectively to remedy the cause and prevent further injury. The FMC will continue to work closely with the NBL physicians to identify shoulder symptoms and injuries and with the Strength and Conditioning Specialists to prevent injuries and rehabilitate injured astronauts.

9.3 Reporting Astronaut Medical Injuries

It is FMC policy that all injuries that rise to the level of OSHA recording be reported to Safety per clinic procedure. Rick McCluskey presented to the FMC and the Flight Crew Operations Directorate on the criteria regarding what is OSHA reportable to the FMC. Now that a causal relationship between EVA training and certain cases of shoulder injuries (as identified in the survey) has been established, these cases will be reported per OSHA standards.

Section 10 Conclusions

It is now clear that the current design of the EMU Planar HUT shoulder joint increases the risk of shoulder injuries when performing overhead tasks, particularly those requiring inverted body positions. The possible mechanism of injury has been identified based upon tiger team assessments of the biomechanics of EMU shoulder joint movement and consultation with orthopedic surgeons. Due to the multi-factorial nature of the EVA training-related minor and major shoulder injuries, the findings and recommendations of the tiger team are wide-ranging in scope and complexity. Numerous findings and recommendations in this report have been made to prevent shoulder injuries and facilitate the early detection and treatment of injuries before they develop into overuse syndromes or shoulder tears requiring surgical therapy. In many cases, recommendations were implemented during the tiger team review to decrease the likelihood of shoulder injuries developing in the astronauts currently participating in EVA training.

The short- and long-term health consequences of shoulder injury to astronauts in training as well as the potential mission impact associated with surgical intervention in assigned EVA crew indicate that this is a critical problem that must be mitigated. Recommendations have been assigned to the relevant JSC Directorates and given suggested implementation dates. It is the expectation of this tiger team that each Directorate will review and implement these recommendations as discrete actions within their respective organization. The EVA Office will ultimately track the final resolution of all recommendations provided in this document.

Key elements in the risk mitigation of shoulder injuries associated with EVA training include accelerated development of the next-generation space suit or redesign of the EMU shoulder joint, reduction in high-risk NBL activities, optimization of suit fit, and continued emphasis on physical conditioning. Since a quick fix to the EMU design is not feasible and this is not the only issue associated with the continued use of the current EMU, prioritized funding should be allocated immediately to support the development of the next generation of space suit.

These development activities should incorporate the design of new suit soft goods, including upper torso, an area of immediate priority due to the frequency, severity, and diversity of injury associated with the current suit. In parallel or following the development of the new suit soft goods, the next-generation life support systems should be built. Following its development, the XL Planar HUT was rated unacceptable (U2) for permanent long-term use in an Astronaut Office Crew Consensus Review based on concerns about reach, access, and risk of injury (CB-00-061, 2000). While some of the recommendations in this report may reduce the interim risk of shoulder injury, a new suit design program must be implemented immediately to have a new suit available for ISS EVA within the next five years to reduce the likelihood of further injury to EVA astronauts.

Laser anthropometric studies of male and female astronauts, biomechanical analysis of shoulder joint motion in both genders, and use of CAD models of shoulder joint motion and EMU shoulder joint design should all be incorporated into the development of the next-generation

space suit. Provision of the next-generation EMU will not entirely eliminate the risk of injury associated with EVA training. Sustained emphasis on avoiding inverted body orientations, developing neutrally buoyant high-fidelity tools, working within the design envelope of the EMU, and crew conditioning are also critical in reducing the risk of injury.

Section 11 References

- CB-00-061 Crew Consensus of Extra-large (XL) Planar Hard Upper Torso (HUT), June 16th, 2000.
- Doering S, Davis J, Shoulder Team Preliminary Findings, NASA Memorandum #XA-03-078, Johnson Space Center, Houston, Texas, 2003.
- EMU Crew Options, United Space Alliance, EMU Engineering, EVA/EMU IPT 7/26/02
- Flynt, GA, Shoulder Injury Tiger Team, December 6th, 2002, #XA-02-225.
- George FJ, The athletic trainer's perspective. *Clin Sports Med.* 1997 Jul;16(3):361-74.
- Hutchinson KJ, Watenpaugh DE, Murthy G, Convertino VA, Hargens AR.
Back pain during 6 degrees head-down tilt approximates that during actual microgravity. *Aviat Space Environ Med.* 1995 Mar;66(3):256-9.
- ISS - MORD: International Space Station Medical Operations Requirements Documents (ISS MORD), SSP 50260 Rev. B, May 2003. Paragraph 6.1.3, International Space Station Program Office.
- Kessel L and Watson M, The painful arc syndrome. *J Bone Joint Surg* 59(2):166.
- Kibler WB, and Chandler TJ Sport-specific conditioning. *Am J Sports Med.* 1994 May-Jun; 22(3):424-32.
- King LJ, Healy JC, Baird P. Imaging of the rotator cuff and biceps tendon. *J R Army Med Corps* 1999 Oct; 145(3):125-31
- Ledsome JR, Lessoway V, Susak LE, Gagnon FA, Gagnon R, Wing PC.
Diurnal changes in lumbar intervertebral distance, measured using ultrasound. *Spine.* 1996 Jul 15;21(14):1671-5.
- Mazzetti SA, Kraemer WJ, Volek JS, Duncan ND, Ratamess NA, Gomez AL, Newton RU, Hakkinen K, Fleck SJ, The influence of direct supervision of resistance training on strength performance. *Med Sci Sports Exerc.* 2000 Jun;32(6):1175-84.
- McCluskey R. NASA Memo to Dr. Craig Fischer, Space and Life Sciences Directorate, Johnson Space Center 2002.
- McMonigal K., E-mail to R. Farris, Chief Neutral Buoyancy Office, October 1999.
- Moynes DR., Prevention of injury to the shoulder through exercises and therapy. *Clin Sports Med.* 1983 Jul;2(2):413-22.
- Roberts CS, Walker JA 2nd, Seligson D, Diagnostic capabilities of shoulder ultrasonography in the detection of complete and partial rotator cuff tears. *Am J Orthop* 2001 Feb; 30(2): 159-62.
- SSP - MORD: Medical Operations Requirements Document for Space Shuttle, JSC 13956 Rev. H, April 2003. Paragraph 3.2.4.1, Mission Operations Space Medicine & Crew Health Care Systems Office Space and Life Sciences Directorate.
- Styf JR, Ballard RE, Fechner K, Watenpaugh DE, Kahan NJ, Hargens AR. Height increase, neuromuscular function, and back pain during 6 degrees head-down tilt with traction. *Aviat Space Environ Med.* 1997 Jan;68(1):24-9.

SVHS7800: Extravehicular Mobility Unit Design and Performance Requirements Specification,
SVHS 7800, Rev. BK, 5/31/02

Wing PC, Tsang IK, Susak L, Gagnon F, Gagnon R, Potts JE. Back pain and spinal changes in
microgravity. Orthop Clin North Am. 1991 Apr;22(2):255-62

Appendices

Appendix A:

Shoulder Injury Tiger Team Subgroup Tasks

A. Conditioning/Rehabilitation Medicine

Membership

Jamie Chauvin (Lead), Beth Shepherd, Corey Twine, Joe Dervay

Tasks

- Review data from EMU Injury survey and postdive database to identify most frequent shoulder and neck problems related to EMU.
- Develop classification for shoulder injuries in EMU with specific attention to mechanism of injury, prevention, diagnosis, treatment and rehabilitation.
- Develop classification for neck injuries in EMU with specific attention to mechanism of injury, prevention, diagnosis, treatment and rehabilitation.
- Assess value of supervised strengthening and stretching programs in preventing shoulder injuries/overuse problems.
- Determine contributing role of previous shoulder injuries on EVA conditioning and skills/mission training.
- Review injury surveillance process in FMC.

Deliverables

- Develop EVA conditioning program (type of conditioning, strengthening, stretching and frequency of exercise)
- Make recommendation concerning mandatory participation for astronauts in all phases of EVA training and assigned crew.
- Integrate conditioning and rehabilitation into EMR.
- Make recommendations on possible improvements to the capability within the FMC to detect and track cohorts of disease/injury.

B. Anthropometrics, Biomechanics, and Suit Design/Fit

Membership

Sudhakar Rajulu (Lead), Luis Gonzalez, Don Campbell, Lou Carfagno, Chris Trevino, Joe Kosmo, Scott Cupples and Corey Twine

Tasks

- Complete anthropometric assessment of EMU shoulder joint.
- Complete laser scanning of shoulder in internally rotated position and specific degrees of abduction (measured with goniometer)
- Scan selected crew members with reported shoulder problems
- Scan planar EMU

- Create or acquire CAD model of the shoulder
- Acquire CAD model of shoulder joint in planar HUT
- Create integrated CAD model of shoulder motion in planar HUT
- Determine contribution of laser anthropometry to optimizing suit fit
- Determine force required to move any given suit joint through ROM against 4.3 PSID
- Other tasks as required to understand the anthropometrics and biomechanics of optimum shoulder joint design for an EMU
- Evaluation of the shoulder harness in reducing shoulder discomfort related to inverted ops in the EMU

Deliverables

- Recommendations on the need for immediate versus delayed redesign of the EMU shoulder joint to prevent shoulder injuries.
- Recommendations on the benefits of integrated CAD modeling in resolving suit biomechanical concerns.
- Recommendations on the need for JSC site-wide anthropometrics data collection and retrieval.
- Recommendations on the benefit of laser anthropometry to optimizing suit fit.
- Recommendations for optimum padding configuration for 1G training to prevent shoulder injuries in the suit.
- Recommendations on the use of the shoulder harness in reducing problems associated with inverted ops while training in the EMU.

C. EMU Injury Survey/Postdive Symptom Reporting

Membership

Dave Williams (Lead), Chuck Ross, Sam Strauss, Dan Fitzpatrick, Oscar Bradford (Consultant)

Tasks

- Complete CB EMU shoulder injury survey with controls.
- Perform data analysis to determine incidence, possible causal mechanisms and potential solutions to shoulder and neck injury related to EVA training.
- Integrate findings from NBL postdive survey into tiger team findings on as needed basis.
- Develop and test value of prototype secure/confidential electronic symptom/injury reporting system.

Deliverables

- Data analysis to determine incidence, possible causal mechanisms and potential solutions to shoulder and neck injury related to EVA training.

- Recommendations on need to change NBL postdive symptom/injury reporting process.

D. EVA Skills/Mission Training

Membership

Rex Walheim, Mary Fitts, Scott Cupples

Tasks

- Review relative contribution of inverted ops, heavy tools, specific tasks, EMU work envelope on the risk of shoulder and neck injury in the EMU.
- Assess impact of tuning fork configuration on amount of inverted ops in the EMU.
- Assess risk benefit relationship of inverted training in the EMU.

Deliverables

- Make recommendations on inverted ops for EVA training (may range from none, acceptable with governing rules, completely acceptable).
- Make recommendations on how training team can reduce the likelihood of injury from flight realistic training in NBL.

Appendix B:

Debrief Comments (Williams) on Shoulder Harness NBL Development Run January 17, 2003

NBL Development Task:

1. R&R S3 UTA - once with UTA stowed on CETA cart and once with UTA stowed on ESP2
2. Airlock evaluation of ingress and egress with LDU and grapple fixture
3. Access assessment to UTA from P4 interface at SARJ
4. Assessment of PFR locations on CETA cart for FRAM installation on CETA cart.

Harness Evaluation Objectives:

Per Scott Cupple's previous e-mail

1. 45 deg Head down/face down
2. 45 deg Head down/face up
3. Inverted (i.e., feet up, head down)
4. 45 deg Head down/face down/rolled 90 deg onto dominant shoulder
5. 45 deg Head down/face up/rolled 90 deg onto dominant shoulder

(The first three are what I'd call 'typical' positions, the last two are what I'd call worst-case positions.)

For each of the positions, I'd like him to evaluate the following tasks:

1. Operate ratchet and other hand tools
2. Manipulate waist tether and ERCM
3. Install/remove tools from MWS
4. Translate along a handrail
5. Ingress PFR
6. Install/remove PFR
7. Operate PGT

Harness Comments:

Donning:

I did not experience any difficulties donning the EMU with the harness in place. The harness requires positioning after ingress to make sure the LCVG and long underwear are not bunched up and causing pressure points. We had about 30 minutes to evaluate harness fit due to a delay in getting started (NBL issue) so I was able to try the ingress and fit a couple of times. The first time it felt comfortable and there was adequate clearance between my shoulders and the HUT when I supported my weight on the crotch of the suit. When I stood up and forced my weight up against the harness it stopped my shoulders from contacting the HUT and I was actually able to laterally swing my shoulders back and forth (from left to right) without contacting the HUT scye bearing joint. I did not have any padding on my LCVG and only had the very small padding (about 1/4

inch thick on the harness itself). The harness did not seem to pull me down too low in the HUT. The position of the harness was as tight as it could go with the play available in the straps.

I felt confident that the fit the position of the harness was acceptable and that we had it tight enough for the run - we anticipated it might have slackened during the run but this did not happen. I was concerned prior to the run about not having my regular shoulder padding configuration as I knew that I would be spending a fair amount of time upside down to evaluate the harness.

Evaluation During Run:

Initial Assessment:

After my weigh-out Koichi had to return to the stand and be removed from the water to evaluate a problem with his over pressurization valve in the EMU. This gave me some time to accomplish some of the test objectives at the S3 worksite. On arriving at the worksite I rolled to my left to be completely inverted and translated along face 1 for about 15 feet and returned inverted. I then rotated heads up to roll to my right into the heads down orientation and translated up face 1 to face 2 and translated in a 45 degree heads down face down orientation. I then translated heads down along the 45 degree diagonal from the zenith side of face 1 to the nadir side of face 1 to allow me to translate down to face 6 putting me in a heads down back down orientation as I translated in the nadir direction on face 6.

Assessment:

Support during inverted position:

Acceptable. The shoulder harness supported me and prevented my shoulders from significantly contacting the HUT when completely inverted. Rolling into the inverted position from either the left or the right appeared acceptable. When I was inverted I was still able to swing my shoulders laterally from left to right without significantly contacting the HUT. Translating on the 45 degree diagonal across face 1 was acceptable with no problems noted. In the face down heads down orientation I found that my weight was being partially supported by the harness and partially by contact of my anterior chest muscles (pec major) with the scye bearing joint. This was not painful, but prolonged ops in this position would probably cause local irritation/bruising of the muscle tissue. The same could be said for heads down/back down body positions (face 6). I did not experience any pain in that configuration but did feel the additional pressure of the HUT against the back of my shoulders (over the rotator cuff area). I would say that I spent about 10 minutes inverted evaluating these different positions and was pleasantly surprised at the performance of the harness. If I ever felt too low in the HUT I simply pushed up with my heels and was able to get to the desired body position without difficulty.

UTA R&R:

For the first portion of this task, I installed the UTA heads up. When we evaluated the UTA stowed on ESP2, I was the crew person on the arm removing the UTA from ESP2. I did all of the remove tasks upright and once I was holding the UTA requested that the arm operator roll me inverted for the translation over to the S3 worksite. The roll to heads down was intentionally slow (controlled by arm operator) and I could feel my weight transitioning to being supported by the harness. It took approximately 10 minutes for the arm to move me from ESP2 to the S3 worksite. Once at the S3 worksite I was rolled upright to complete the hand-off/exchange with Koichi. After the hand-off I requested that the arm operator roll me inverted again to move me

back to ESP2 and I also requested and received permission to install the UTA on ESP2 inverted. The total duration of the arm movement and installation was approximately 45 minutes during which I was completely inverted.

Assessment:

Acceptable. Rolling inverted on the end of the arm was not a problem. The harness supported my weight and I did not experience any pain or discomfort during the arm movement over to the work site. The same comments apply to the arm movement back to ESP2. During the inverted UTA install the harness supported all of my weight while I installed the UTA in the FSE, used the PGT to drive 5 bolts (18-20 turns per bolt) and attached 8 connector caps. After the connector caps I came off the arm and installed the cover for the UTA upright. There was no difficulty accomplishing any of the tasks. The harness prevented my shoulders from contacting the HUT as long as I was completely inverted and I did not experience any pain or discomfort.

Airlock Ingress/Egress Tasks:

During the LDU evaluation I entered the airlock second feet first and spent a little more time than usual inverted in the airlock due to the size of the LDU interfering with a clean ingress. The only time I felt any contact with the HUT was face down and heads down coming into the airlock and trying to get the hatch closed after ingress. For the grapple fixture I ingressed first heads up.

Assessment:

Acceptable. No additional comments to make other than those listed above.

Tasks 3 & 4 did not require inverted body position.

Overall Assessment:

I was quite surprised by the performance of the harness in supporting me while inverted. I did not find it pulled me down too low in the HUT. For completely inverted body positions it did a very good job at protecting my shoulders. For the 45 degree heads down/face down or heads down/back down body position the harness alone was not enough to protect the front and back of my shoulder from contact with the scye bearing joint. When I came out of the pool Sam Strauss met me and immediately looked at my shoulders poolside. He was surprised that he did not see any marks at all from pressure points. He took digital photos poolside and later in the locker room after a shower (always makes skin lesions look worse). I did not notice any shoulder pain or discomfort after then run. The sensation on the top of my shoulders was similar to carrying a heavy backpack for a couple of hours. After the shower I noticed some redness where the harness had contacted my shoulders. There was not tenderness to touching that area. I also had redness anteriorly over my pec major (where I could feel the scye bearing joint contacting me during the run). Later in the evening I had some local tenderness there which had resolved by Saturday morning. I did my full EVA weight workout Saturday without difficulty.

Recommended Future Activities:

1. Continue with plan to evaluate harness in building 9.
2. Further NBL runs to evaluate harness and shoulder pads (Type 2) together to see if that will prevent anterior and posterior contact with HUT.

Appendix C:

Debrief Comments on Shoulder Harness NBL Development Run April 7th, 2003

Test Objective: To evaluate whether or not the insert of the EMU shoulder harness will assist in alleviating some of the shoulder injuries that have been reported in the past during NBL EMU training.

Test Participants:

EV1- CB/Dave Williams

EV2- CB/Rex Walheim

Test Implementation: This NBL evaluation implemented a number of inverted operations in order to determine comfort level in comparison to not having the shoulder harness installed in the EMU. The following specific objectives were achieved:

-180° inverted heads down in an APFR working at a worksite within the traditional EVA worksite

-45° heads down face down in the pool in an APFR working at a worksite within the traditional EVA worksite

-45° heads down back down in the pool in an APFR working at a worksite within the traditional EVA worksite

-180° roll to heads down from a heads up position

-180° pitch to heads down from a heads up position

-45° heads down on right shoulder

-45° heads down on left shoulder

Test Stand Setup: An overhead camera was installed on the donning stand in order to view the ingress of the EMU HUT with the shoulder harness attached. These videos can be made available upon request.

Test Procedures: The following procedures were run in order to evaluate the inverted positions with the shoulder harness installed.

Setup: Test subjects will have an overhead camera in order for the taping of the suit don/doff.

Adjustments to the suit may take slightly longer than a normal NBL run due to suit fit real time the morning of this test.

Due to the nature of the shoulder harness evaluation, this test will comprise of a number of inverted operations. Care will be taken to assist the crewmember with clearing and to verify that the crewmember is able to clear at all times. Crewmembers are advised to take Sudafed/Actifed prior to this test to assist with clearing.

Medical Requirements:

- Crewmembers will not remain inverted for any longer than 15 minutes
- Crewmembers will be given a break for recovery time of 5 minutes after every period of inverted operations longer than 10 minutes
- Crewmembers will respond to the Doctors checklist associated with the harness at the following interval

TASK 1 – A/L Egress – The crew performed an egress of the A/L in the standard fashion that A/L egress is performed for all NBL runs. The crew was asked to evaluate access inside the NBL to all A/L interfaces in an effort to verify that the shoulder harness does not interfere with nominal EVA operations.

Comments – Both crewmembers were able to access the UIA panel, the depress pump, and access to hatch operations.

Translating to first worksite – While translating to worksite EV1 performed a tether swap onto S0 using the tether shuttle. He performed this in a 180° inverted heads down orientation. EV2 performed a tether swap in a heads up orientation.

Comments EV1 – acceptable weight supported by both shoulders and was able to move back and forth shoulder to shoulder with no discomfort. While in a heads down orientation noticed that head sits perfectly in center of faceplate. While in the normal heads up orientation there is only ½” clearance between chin and neck ring while standing in suit.

Comments EV2 – a little concern that the harness may be holding him down a little while working. Not sure and will evaluate as test continues.

TASK 2 – Translation (fully inverted) – Test subjects performed a translation in a 180° inverted position on Face 1 of S3. This face has two opposing diagonals that allow for transition from fully inverted to 45° on the left shoulder on one diagonal and 45° on the right shoulder on the other diagonal. The pattern was to translate vertically up in the pool on the bulkhead, 45° down the vertical placing body orientation with most of the weight on one shoulder, and then transitioning to the horizontal where weight was once again placed on both shoulders. This pattern was performed twice for both grids thereby placing weight on both shoulder, and then on the left shoulder only, back to both shoulders. The second pattern placed the weight on both shoulders, and then on the right shoulder only, back to both shoulders.

Comments EV1 – time inverted 10 minutes – While translating inverted EV1 was able to roll to right with no trouble. While moving through test area was able to feel transition taken off of right shoulder easily. Noticed more contact with HUT than when didn't have pads. While translating on the diagonal noticed that the harness is supporting.

Comments EV2 – time inverted 6 minutes – No noticeable change with or without harness installed.

TASK 3 – Worksite Evaluation MBSU (Face up back down 45°) – This worksite consist of the position of heads down slightly pitched forward about 30° with a slight pitch to left about 30°. The majority of the body weight transitioned to a point on the aft portion of the left shoulder.

Comments EV1 – time inverted 11 minutes – Even with left shoulder down weight seemed to be equally supported on both shoulders. Installed a socket on the PGT with no problem. Installing Torque Multiplier acceptable. Using PGT on bolt acceptable.

Comments EV2 – time inverted 4 minutes – Still feeling bearings in both arms. Was able to roll on his own and not noticing much difference. Installed a socket on the PGT with no problem. Installing Torque Multiplier with no noticeable difference. Using PGT on bolt with no noticeable difference.

TASK 4 – Translation (Face down 45° roll to face up 45°) – This task was performed on S0 at the bulkhead between bay 2 and bay 4 on the port side. The task is to translate parallel to the face of the truss from face 2 down face 1 to face 6. This will slowly transition the weight distribution from being imparted on the front part of the shoulder to directly heads down and the weight being distributed onto the tops of the shoulders, and finally transitioning the weight to the aft part of the shoulders.

Comments EV1 – time inverted 3 minutes – EV1 was able to feel the transition with the shift of weight from the front of the harness to the back of the harness. No contact with bearing. Seems to be more the padding taking the weight than the harness.

Comments EV2 – time inverted 4 minutes – EV2 did not notice much movement in harness while translating from face 2 to face 6.

TASK 5 – Worksite Evaluation (fully inverted) – This worksite consist of the portion of the UTA R&R using the work site interface that is at the top of the bay on S3. This creates a fully inverted APFR worksite with the work being performed directly in the traditional worksite area.

Comments EV1 – time inverted 9 minutes – While working in the inverted it felt as though the harness and the padding was taking the load. While working with the PGT noticed that the weight of the PGT helps keep the arms in the proper position inverted. This is not a good thing since increases chance for hyperextension.

Comments EV2 – time inverted 9 minutes – While working in the inverted it felt as though the padding was supporting but the harness was not supporting at all.

TASK 6 – TUS Cable Reel (Flat on back working overhead) – This worksite consist of an APFR position with back completely down in water with a worksite directly over mid chest area. This part of the test was to verify that the harness was not hindering a known good worksite.

Comments EV1 – Pressure on back pretty uniform on back in all places.

Comments EV2 – Harness may be restraining motion a little bit. EV2 is more maneuverable without harness in side HUT. EV2 is able to get the weight from one direct point on shoulder to another. Not able to do this while in harness.

TASK 7 – S0 Forward tray installation – This worksite mimics the 8A tasks of installing the S0 forward avionics umbilical. Worksite is approximately 45° heads down in an APFR on the SSRMS. Subject is installing a mass of approximately 250 lbs (not in the NBL, actually neutral) that is approximately 20 feet long. Weight is mostly distributed on front part of shoulder but with installation will vary as maneuvering to install.

Comments EV1 – time inverted 9 minutes – While performing tasks the weight is supported by harness and pads. The right shoulder seems to be taking more of the load.

Comments EV2 – time inverted 13 minutes – While performing tasks the harness and pads do not seem to be any different than when performing tasks without the harness and pads.

TASK 8 – Three-point latch tool Installation (free float working overhead)

No major comments on this task.

During this test great care was taken to watch the amount of time that inverted operations were performed. At no time were extended inverted operations allowed. Both crewmembers were monitored for shoulder pain throughout the run as well as nausea. At no time during this run did either crewmember claim to have a condition that required the run to be stopped.

Field Engineering Memo 03-013

Initiator: Scott Cupples

Test Date: April 7, 2003

Test Procedure: Shoulder Harness NBL Evaluation

Test Site: Sonny Carter Training Facility

Test Subjects (TS): Crewmembers Dave Williams and Rex Walheim

Background: Due to shoulder injuries sustained by EVA crewmembers, an investigation was initiated to determine the causes of the injuries and to develop and implement solutions. Multiple factors are suspected to be contributors, however, a primary focus is on the interaction between the crewmember and the EMU shoulder structure, specifically the Liquid Cooling and Ventilation Garment (LCVG) and the Hard Upper Torso (HUT).

Crewmember Dave Williams evaluated the HUT Shoulder Harness in lieu of LCVG pads in a previous NBL and found it to be effective in reducing shoulder pain during inverted tasks. After the test, however, he determined that the Harness alone was not sufficient to preclude bruising of his shoulder area.

Objectives: Evaluate the Shoulder Harness in addition to the pads the crewmembers normally wear on their LCVGs. The crewmembers were to accomplish a variety of EVA tasks in a heads-down or inverted posture.

Summary: Crewmembers Williams and Walheim completed the planned tasks without difficulty. Walheim did note that the Harness slightly affected his range of motion while inverted. His Harness was removed near the end of the test, and Walheim evaluated the suit using only the LCVG shoulder pads. He noted that the scye bearing pressure points on his shoulders were much more pronounced after the Harness was removed.

The results of the NBL exercise were mixed. The Shoulder Harness in combination with LCVG pads was effective in preventing shoulder bruising for Williams. His shoulders exhibited slight marking across the blades; however, the bruising was much less than that which he sustained during his first evaluation of the harness. Walheim, who used a different LCVG pad configuration from Williams, had shoulders that were red and tender after the run. He reported the harness protected his shoulders from hot spots created by the scye bearings more than his normal pad configuration, but that he was better able to reposition himself in the HUT without the Harness installed.

A combination of the Shoulder Harness and LCVG pads seems to be effective in reducing loading of the scye bearing on the crewmember's shoulders, although no single combination of the Shoulder Harness and LCVG pads will work for the entire population. More work should be done on developing the Shoulder Harness design to optimize it for use in the NBL.

Discussion:

This event and the specific tasks therein were designed to evaluate the efficacy of the HUT Shoulder Harness for inverted tasks in the NBL. Both crewmembers were requested to perform the same tasks so that each could assess the Harness.

The Shoulder Harness is a 1"-wide nylon webbing affixed to the HUT near the Body Seal Closure (BSC). It attaches at the one, six and eleven o'clock positions on the BSC, and is laced to the left and right sides of the HUT neck ring. When installed in a HUT, the Harness looks similar to a pair of suspenders. The Harness has 0.25"-thick padding at the shoulders to absorb the load imparted to the crewmember by the suit. The Shoulder Harness is a crew option that was originally certified for the Pivoted and Planar HUTs, but is rarely used.

Crewmember Williams normally wears -335/-336 configuration LCVG pads, which are 0.25"-thick Mosite foam pads and extend from behind the top of the shoulders to the front of the pectoral muscles. Recently, he has adopted the HUT Shoulder Harness and has performed four or five NBL events with it installed. For this run, he used the LCVG pads in combination with the Shoulder Harness. The Harness was installed in the HUT and adjusted to 2" from its shortest position.

Walheim normally wears the -338 configuration LCVG pads, which are approximately 0.25" x 4" x 4" Mosite foam pads and cover only the tops of the shoulders. Walheim used these pads in combination with the Shoulder Harness. This was Walheim's first event (aside from a fit check) with the Harness. Per his request, the Harness was adjusted to its shortest position, although he expressed some concern that, at this setting, the Harness would prevent him from maintaining an optimum head position in the Helmet bubble.

Neither crewmember had any difficulty donning the HUT with the Shoulder Harness installed. After donning, Walheim found that the Harness caused his crotch-to-shoulder contact in the suit to be a little more snug than usual, although he said it was not uncomfortable. The addition of the Shoulder Harness did not affect EMU weigh out.

Both crewmembers evaluated the Harness function during airlock egress. Williams commented that his weight smoothly transitioned from the pads on the front of his shoulders onto the Harness. Walheim said there was no significant sensation that his weight shifted from his LCVG pads to his Harness. This is not surprising, given that his pads were primarily located directly beneath the Harness, unlike Williams.

While inverted and translating along a truss segment or to a worksite, Williams observed that he could control his vertical orientation in the suit. He was able to move his chin about 0.5" above or below the HUT neck ring. When he was oriented at 45 degrees (heads down), he reported that the shoulder pads take the majority of his weight and that no hot spots developed. Once completely inverted, the Harness absorbed the majority of his weight.

Walheim found that while he was inverted, the harness was taking a significant percentage of the load, but he did not have as much clearance between his

shoulders and the scye bearings as Williams. He reported that the Harness was not as effective and sometimes a little constraining for him.

Williams and Walheim performed a variety of tasks (ingressing foot restraints, accessing connectors, installing bolts and foot restraints, etc.) at various worksites while inverted. Walheim reported that at times the Harness felt like it was restraining him, uncomfortably, in the suit. Williams reported that the Harness was effective, but that LCVG pads were still required to protect his chest and back from the hot spots created by the scye bearings.

At the end of the exercise, Walheim was pulled from the water and his Shoulder Harness was removed. He returned to the water and translated along a truss segment in order to evaluate the difference between the combination of Shoulder Harness/LCVG pads and the LCVG pads by themselves. He reported that there was a hot spot created by the scye bearings when the Harness was removed from the HUT. But, he said that it was easier for him to reposition himself in the suit to avoid pain when the Harness was not installed. The Harness, Walheim said, kept him in a stable position while inverted, and he was not able to significantly change his shoulder position.

After the run, even though the harness was adjusted to its shortest position, Walheim felt it didn't prevent him from maintaining a nearly optimal head position. In addition he felt that if the harness could have been adjusted to an even shorter position, it might have helped more, because it might have been able to suspend him better when inverted.

The crewmembers each spent a total of about 3.5 hours in the NBL, of which approximately an hour was spent inverted.

After the crewmembers doffed their suits, their shoulders were inspected for bruising and abrasions. Williams' shoulders, pectoral and back areas were nearly free of marks. Only slight bruising was observed on his back; it appeared to be due to the LCVG vent ducts being pressed into his back. Walheim had fairly significant bruising on his shoulders near his clavicle area. He reported in his post-test questionnaire that the Harness helped reduce the pain on top of his shoulder during and after the run, but that general shoulder discomfort was significant a few hours after the run. He surmised that the Shoulder Harness was not the cause of the delayed pain, but it did not appear to help the general pain that occurred later.

Recommendations: Based on the results of this evaluation, it does not appear that a single solution will resolve shoulder pressure points for everyone. A combination of the Shoulder Harness and some configuration of existing LCVG pads may be sufficient to preclude problems for most people.

The Shoulder Harness does provide a benefit to users while minimally affecting the mobility of the suit. More work should be done on developing the Shoulder Harness design to optimize it for use in the NBL, but it will supplement, rather than replace, the existing LCVG pads. Additionally, some thought should be given to developing other LCVG pad configurations, using other materials and/or different geometries.

Test Hardware:

Williams:

Large Planar HUT, -335 LCVG pads, HUT Shoulder Harness

Walheim:

Medium Planar HUT, -338 LCVG pads, HUT Shoulder Harness

Attachments:

None.

Appendix D:

Mission Operations Directorate Survey Results

Survey Concern	Survey Finding	Forward Work
1 How does DX3 judge "success" in skills classes? Are there unreasonable expectations?	DX3 minimizes unreasonable expectations such as intense "over the head" or inverted operations to assess general EVA skill	None
2 Does DX3 expect crewmembers to "tough it out" during skills runs?	DX3 does not expect crewmembers to "tough it out"; this is more of a CB culture than a DX3 culture.	CB: Keep reinforcing to crewmembers that they are not being graded on how much pain they can endure; follow up with actions that support this claim.
3 Does DX3 brief crews to avoid over taxing themselves physically, especially shoulders?	Yes; this is done for every run. In addition, this is also a debrief topic when the runs are completed.	DX to ensure that this information is consistent among instructors and runs; document in lesson plans for skills, ASCAN and flight specific runs
4 Does DX3 demonstrate/explain the limitations of the EMU (e.g. work envelop, overhead tasks, inversion ops) and how to best accomplish tasks given the limits of the EMU?	No; DX3 does not generally include this information in either pre-briefs or debriefs of skills or ASCAN runs	1) DX3 must watch runs closely and specifically evaluate if problems encountered are related to skill level or EMU limitations 2) Weigh out must be good (VERY IMPORTANT) 3) Suit quals/ASCAN runs should be performed with more emphasis regarding specifics on how to work in the EMU (DX3)
5 What tools are the most prone to create an environment conducive to injury?	PGT, Centerline Latch Tool, 3 pt latch tool; in addition, the TM adds about 10 lbs.	Discussions to follow with XA on how to make tools more user friendly in the NBL while retaining fidelity; DX3 currently assessing what the requirements; TM could be made lighter
6 What are the factors that make these tools prone to cause injury	Weight (PGT); body position (PGT and latch tools)	
7 Are there ways to make these tools more user friendly during training	Yes; these could be made more neutrally buoyant and lightweight	These discussions are to be held with XA reps
8 What ISS elements/tasks have poor accessibility or are difficult in the NBL?	1) A/L egress 2) Truss with WIFs on zenith side 3) inverted APFR ingress 4)FHRC	We try to minimize inverted time to 10 minutes or less if possible; it is not always possible
9 What non-ISS elements/tasks have poor accessibility or are difficult in the NBL	Hubble tasks are often difficult due to tight areas and worksite access; A/L egress is inverted	
10 What skills tasks are inverted and how much of the skills runs are targetted for inverted ops?	About 50% of the possible skills worksites are inverted; however, any given skills run will select a subset of these resulting in approximately 5-10% of the skills class requiring the inverted position to various extents.	NOTE: DX3 must retain the option to use some of the inverted worksites to ensure that various degrees of difficulty have been assessed. However, DX3 does/will limit the inverted time to 10-15 min.
11 What variability is seen in the dive teams and to what extent will they assist a crewmember when needed?	The dive teams are invariably capable and willing to assist provided they have access to the crewmember	One concern here goes back to the issue of crewmembers not requesting assistance when needed
FLIGHT SPECIFIC CONCERNS		
ULF-1	There are some work areas that would normally require inverted ops, but ULF-1 has made accomodation to do these in a more heads up position; in addition, there is some PGT work, but <u>not for long periods of time.</u>	Because the attachment point is a circular ring, there is no way to rotate the NBL model to avoid inversion.
12A	Launch Locks require inversion and this is a concern for one cm; the task requires approximately 30-40 minutes inverted.	Because the attachment point is a circular ring, there is no way to rotate the NBL model to avoid inversion.
12A.1		

Appendix E:

Crew Consensus Memo

National Aeronautics and
Space Administration



Lyndon B. Johnson Space Center
Houston, Texas 77058

June 16, 2000

Reply to Attn of: CB-00-061

TO: XA/Lead, Extra Vehicular Activity (EVA) Integration and Operations Group
FROM: CB/Chief, EVA Branch
SUBJECT: Crew Consensus of Extra-Large (X-L) Planer Hard Upper Torso (HUT)

A crew consensus meeting relating to the X-L planar HUT was held May 25, 2000. After careful review of the fit check records, the crew consensus is as follows:

1. The X-L planar HUT is UNACCEPTABLE 2 (U2) for permanent long-term use. This is based on the fact that of the 14 crew test subjects, 2 could not reach the SAFER nitrogen and hand controller module switches, 3 felt that HUT donning risked injury to their shoulders and upper arms, and 1 could not reach the displays and controls module controls. In addition, (although not the basis for the U2) several crew members complained of insufficient chest circumference, inability to take a full breath, and marginally adequate reach access to the EMU D-rings. None of these crew members had any of the above problems with the X-L pivoted HUT.
2. We recommend that a fit check evaluation program be initiated to provide a more in-depth understanding of the differences between the X-L pivoted and planar HUT's, with the objective of identifying specific corrective solutions to make the X-L HUT acceptable for the long term.

We recognize the challenges and complexity of fitting space suits to a wide range of anthropometrics. We also are keenly aware of the schedule and budget constraints associated with supporting the near term ISS assembly and utilization flights. We look forward to working with the EVA Office in a balanced constructive effort to provide an acceptable long-term solution to these issues.

Please contact me at (281) 244-8957, or Mike Gernhardt at (281) 244-8977, if you have any questions.

Original signed by David Wolf for:

John M. Grunsfield

cc: see attached list

REPORT DOCUMENTATION PAGE			Form Approved OMB No. 0704-0188	
Public reporting burden for this collection of information is estimated to average 1 hour per response, including the time for reviewing instructions, searching existing data sources, gathering and maintaining the data needed, and completing and reviewing the collection of information. Send comments regarding this burden estimate or any other aspect of this collection of information, including suggestions for reducing this burden, to Washington Headquarters Services, Directorate for Information Operations and Reports, 1215 Jefferson Davis Highway, Suite 1204, Arlington, VA 22202-4302, and to the Office of Management and Budget, Paperwork Reduction Project (0704-0188), Washington, DC 20503.				
1. AGENCY USE ONLY (Leave Blank)	2. REPORT DATE September 2003	3. REPORT TYPE AND DATES COVERED NASA Technical Memorandum		
4. TITLE AND SUBTITLE EMU Shoulder Injury Tiger Team Report			5. FUNDING NUMBERS	
6. AUTHOR(S) David R. Williams, M.D.*; Brian J. Johnson				
7. PERFORMING ORGANIZATION NAME(S) AND ADDRESS(ES) Lyndon B. Johnson Space Center Houston, Texas 77058			8. PERFORMING ORGANIZATION REPORT NUMBERS S-912	
9. SPONSORING/MONITORING AGENCY NAME(S) AND ADDRESS(ES) National Aeronautics and Space Administration Washington, DC 20546-0001			10. SPONSORING/MONITORING AGENCY REPORT NUMBER TM-2003-212058	
11. SUPPLEMENTARY NOTES * Canadian Space Agency, Saint Hubert, Québec				
12a. DISTRIBUTION/AVAILABILITY STATEMENT Unclassified/Unlimited Available from the NASA Center for AeroSpace Information (CASI) 7121 Standard Hanover, MD 21076-1320 subject category 54			12b. DISTRIBUTION CODE	
13. ABSTRACT (Maximum 200 words) The number and complexity of extravehicular activities required for the completion and maintenance of the International Space Station is unprecedented. It is not surprising that training to perform these space walks presents a risk of overuse musculoskeletal injuries. The goal of this tiger team, created in December 2002, was to identify the different factors contributing to the risk of EVA training-related shoulder injury in the Neutral Buoyancy Lab at the Sonny Carter Training Facility and to make recommendations that would either significantly reduce or eliminate those risks. Since 1999, concerns have been expressed about the risk of shoulder injury associated with EVA training at the NBL, particularly in inverted body positions (McMonigal, 1999). A survey was developed and administered to 42 astronauts and astronaut candidates; the results suggest a causal relationship between EVA training at the NBL and the observed injuries. Also, during the tiger team review, it became evident that training in the extravehicular mobility unit may also result in other types of injuries, including fingernail delamination, elbow pain, knee pain, foot pain, and nerve compression leading to transient loss of sensation in certain areas of the upper or lower extremity. A multi-directorate team to detect, evaluate and respond to the medical issues associated with EVA training should be implemented immediately and given the appropriate resources and authority to reduce the risk of injury to crew during training to a level as low as reasonably achievable.				
14. SUBJECT TERMS injury; extravehicular activity; EVA; International Space Station; NBL; Neutral Buoyancy Lab; inverted body position; training; shoulder injury; musculoskeletal			15. NUMBER OF PAGES 101	16. PRICE CODE
17. SECURITY CLASSIFICATION OF REPORT Unclassified	18. SECURITY CLASSIFICATION OF THIS PAGE Unclassified	19. SECURITY CLASSIFICATION OF ABSTRACT Unclassified	20. LIMITATION OF ABSTRACT Unlimited	
