

# **FINAL TECHNICAL REPORT**

## **Lewis' Educational and Research Collaborative Internship Program**

**NASA Cooperative Agreement  
NNC3-04-GB09G**

**May 10, 2004 – May 9, 2005**

**Cleveland, OH 44142**

**September 2004**

**Lewis' Educational and Research Collaborative Internship Program**  
**Grant Closeout Report**  
NNC3-04-GB09G

## SUMMARY

The Lewis' Educational and Research Collaborative Internship Program (LERCIP) is a collaborative undertaking by the Office of Educational Programs at NASA Glenn Research Center at Lewis Field (formerly NASA Lewis Research Center) and the Ohio Aerospace Institute. This program provides 10-week internships in addition to summer and winter extensions if funding is available and/or is requested by mentor (no less than 1 week no more than 4 weeks) for undergraduate/graduate students and secondary school teachers. Students who meet the travel reimbursement criteria receive up to \$500 for travel expenses. Approximately 178 interns are selected to participate in this program each year and begin arriving the fourth week in May.

The internships provide students with introductory professional experiences to complement their academic programs. The interns are given assignments on research and development projects under the personal guidance of NASA professional staff members. Each intern is assigned a NASA mentor who facilitates a research assignment. In addition to the research assignment, the summer program includes a strong educational component that enhances the professional stature of the participants. The educational activities include a research symposium and a variety of workshops, and lectures. An important aspect of the program is that it includes students with diverse social, cultural and economic backgrounds.

The purpose of this report is to document the program accomplishments for 2004.

## ACTIVITIES

The program is explained through a chronological calendar followed by abstracts detailing the research projects students worked on while at NASA.

- |                  |   |
|------------------|---|
| November 2003    | Approximately three thousand applications distributed nationally.   |
| January 31, 2004 | <u>Application Deadline</u> – All applications were reviewed by OAI to ensure that applicants met the qualifications and submitted complete application packages. All information was entered by OAI into the OEP database and the applications were filed by area of interest. There were approximately 707 received.      |
| February 2004    | <u>Call for Mentors</u> – Request for interested mentors who have a need for students to complete on-line student assignment forms, confirmation of funding made. Upon completion original grant proposal is submitted to GRC Grants Office.  |
| March 2004       | <u>Application Review</u> – Posting for NASA Mentors to review eligible applications of students, targeted timeframe 7-10 days and identify primary and alternate candidates.   |
| April 2004       | <u>Interns Selected</u> – NASA mentors selected 178 students/teachers from the pool of applicants. Processing of offer letters, confirmation, declines, and identification of alternate candidates. Emails to mentors confirming status of students, compiling payroll, travel, and reports for Security/badging clearance. |

- May 2004      Mentor Briefing – The orientation provided information to mentors regarding specific aspects of the program such as completing timesheets, missed days, and etc.
- May 24, June 7,  
and June 14, 2004      Orientations – The purpose of this and the two subsequent orientations was to acquaint the interns with some of the specifics of the program and provide mandatory training / policy overview: Representatives of the Computer Services Division, Security, Safety Assurance Office (General Safety and Hazardous Communications Training), and Sexual Harassment/Employment Policy review, were provided to the group. Distribution about other services available: on-site Credit Union, Library, and Learning Center opportunities were provided to the attendees.
- May 27, June 10,  
and June 17, 2004      Networking Activities – the purpose of this activity is to give the students an opportunity to meet each other and talk about their summer assignments, education programs, research interests, and etc.
- June 22 – 23, 2004      Technical Presentation Workshop – this workshop is held to provide guidance to the interns on how to prepare for and give successful presentations. Carpe Diem Motivational Speakers presented the 2 and ½ hour lecture.
- July 7 – 8, 2004      Research Symposium I – provided students with an opportunity to give technical presentations in front of their peers, mentors, and supervisors. Students were evaluated on their presentations and given meaningful feedback to assist them in preparing for future presentations.
- July 14, 2004      Annual Student/Mentor Picnic – a picnic was held which included College and High School summer interns, mentors, and several other groups. A total of approximately 280 attended.
- July 21, 2004      Recognition Banquet Ceremony – All Mentors, Branch Chiefs, Division Chiefs, Senior Management, and both NASA and OAI, were invited to meet and interact with the summer interns on an informal basis to recognize both mentors and students for their participation in the program. Approximately 229 attended this activity, which was held in the NASA cafeteria.
- Aug. 4 – 5, 2004      Research Symposium II – this set of symposiums consisted of those interns that arrived on the second or third orientation dates.
- August-September      Summer/Winter Extensions - Mentors who have projects and funding available are given the opportunity to have their interns return to GRC during their winter break. Travel reimbursements are not given during the extensions and tenure is limited to 4 weeks.

There is a great deal of planning, communicating, coordinating and evaluating that occurs behind the scenes prior to, during, and after the program. Beginning in September the program managers meet to revise the existing application and implement any changes. Starting in January, the program team meets regularly to ensure that the program is progressing on schedule. Follow-up sessions are scheduled for all interns for the purpose of ensuring that each intern has a successful experience at NASA.

LERCIP now encompasses a high school summer internship component. This component is covered in a supplement to the grant and provides 8-week internships for incoming junior and seniors (must be at least 16 years of age when program begins in June). Approximately 60 high school students are selected to participate in this program each year. A copy of the high school calendar is attached. No summer or winter extensions are provided to high school students. Coordination of this component is done between the GRC technical monitor and Educational Programs Office, high school leads.

In addition, there are literally hundreds of phone calls from college representatives, students, and parents inquiring about the Intern Program. Students have questions about eligibility requirements, how to apply, and if they are not selected, how they can improve their chance of being selected the following year.

Management and operation of the program is performed in a team-like manner. Below is the management structure of the program.

NASA Glenn Research Center  
EPO Branch Chief: Jo Ann Charleston  
Program Manager: Susan Gott  
Technical Officer: Susan Gott

Ohio Aerospace Institute  
Principal Investigator: Ann Heyward  
Vice President of Workforce Enhancement  
Program Manager: Mary E. Auzenne



# **HIGH SCHOOL SCHEDULE OF ACTIVITIES**

## 2004 L.E.R.C.I.P. High School Schedule of Events

| DATE            | DESCRIPTION OF EVENTS  | TIME                               | LOCATION                                    |
|-----------------|--|------------------------------------|---|
| June 8          | Pre-Orientation  | 6:00 – 8:00 p.m.                   | Bldg 3 Auditorium                           |
| June 21         | Orientation/GRC Overview   | 8:00–11:30 a.m.<br>Mentors pick-up | Bldg 3 Auditorium<br>students at 11:30 a.m. |
| June 24         | Field Installation Tour<br>Specific Student Schedules TBA          | 1:00-3:30 p.m.                     | Visitor Center                              |
| June 28 –<br>29 | Aerospace Workshop<br>Specific Student Schedules TBA               | 8:30a.m.– 3:30 p.m.                | Visitor Center Auditorium                   |
| June 30         | Field Installation Tour<br>Specific Student Schedules TBA          | 1:00-3:30 p.m.                     | Visitor Center                              |
| July 2          | Professional Development<br>Workshop/Sexual Harassment<br>Training | 8:00a.m.-4:00 p.m.                 | Bldg 3 Auditorium                           |
| July 6-7        | One-on-One Follow-ups  | Schedules TBD                      | Upper Level Main<br>Cafeteria               |
| July 9          | Field Trip @ COSI, Columbus  | 8:00a.m. – 4:30 p.m.               | Meet at DEB Parking Lot<br>for Departure    |
| July 12         | Technical Presentation Workshop<br>Specific Student Schedules TBA  | 8:00a.m.-4:30 p.m.                 | Bldg 3 Auditorium                           |
| July 14         | LERCIP Student/Mentor Picnic                                       | 3:30-8:00 p.m.                     | NASA Picnic Grounds                         |
| July 15         | NASA Plus Activity   | 8:30a.m.-11:30 a.m.                | Bldg 3 Auditorium                           |
| July 15         | GRC Summer Job Fair  | 1:00-3:00 p.m.                     | OAI   |
| July 16         | Residential SHARP Site Visit<br>Michigan & Wisconsin               | 8:30a.m. – Noon                    | Bldg 3 Auditorium                           |
| July 19         | Presentation Pre-meet  | 3:30-4:30 p.m.                     | Visitor Center Auditorium                   |
| July 21         | SHARP Closeout VITS  | 12:30-4:00 p.m.                    | Bldg 3, Room 7                              |
| July 22-23      | Worksite Visits  | Schedules TBA                      | Program Managers visit<br>intern worksites  |
| July 26         | Kids Replay Workshop<br>Specific Student Schedules TBA             | 8:00a.m.-4:00p.m.                  | Bldg 3 Auditorium                           |
| July 27         | NEEIS/EDCATS<br>Specific Student Schedules TBA                     | 8:00a.m.-4:00p.m.                  | Bldg 3 Auditorium                           |
| July 28         | Career Awareness Workshop<br>New Interns ONLY                      | 8:00a.m.-11:30a.m.                 | Bldg 3 Auditorium                           |
| August 2-3      | Intern Presentations   | 8:00a.m.-4:00p.m.                  | Bldg 3 Auditorium                           |
| August 11       | Awards Dinner  | 5:00-8:00p.m.                      | Main Cafeteria                              |
| August 12       | Program Wrap-Up  | 12:30-4:30p.m.                     | Visitor's Center                            |

### L.E.R.C.I.P. Bi-Weekly Pay Schedule

| Pay Period Ending | Pay Date  |
|-------------------|-----------|
| July 3, 2004      | July 9    |
| July 17, 2004     | July 23   |
| July 31, 2004     | August 6  |
| August 14, 2004   | August 20 |

### MTSI Semi-Monthly Pay Schedule

| Pay Period Ending | Pay Date  |
|-------------------|-----------|
| June 30, 2004     | July 15   |
| July 15, 2004     | July 30   |
| July 30, 2004     | August 13 |
| August 15, 2004   | August 30 |

# **COLLEGE APPLICATION**



National Aeronautics and  
Space Administration

John H. Glenn Research Center  
at Lewis Field

## Lewis' Educational and Research Collaborative Internship Program (L.E.R.C.I.P.)

### 2004 SUMMER INTERNSHIP FOR COLLEGE STUDENTS

**"To inspire the next generation of explorers... as only NASA can."**

#### **Program Description**

This is an educational program that provides a summer opportunity for college students of Science, Technology, Engineering, and Mathematics (STEM). Internships of a 10-week duration are available during the summer months at the NASA John H. Glenn Research Center (GRC). The internships are offered under the auspices of Lewis' Educational and Research Collaborative Internship Program (L.E.R.C.I.P.) and are a collaborative undertaking of GRC's Educational Programs Office (EPO) and the Ohio Aerospace Institute (OAI). The L.E.R.C.I.P. college component offers opportunities for graduating 2004 high school seniors through Ph.D students.

#### **Program Goal**

L.E.R.C.I.P. provides students with introductory professional experiences to complement their academic programs and research interest under the guidance of a GRC scientist or engineer who serves as the student's mentor. The program is designed to provide experiences in a research and development environment in order to expand the student's understanding of possible career choices that are available at NASA. Program activities include oral presentations, and a variety of enrichment activities. Because of the program's short duration and intensive requirements, no vacation time or summer day classes can be taken during the internship. If selected, the student must be present for the entire 5-day, 40-hours per week (8:00 am to 4:30 pm, Monday through Friday) assignment.

#### **Additional Opportunities**

The L.E.R.C.I.P. program also has the following other internship opportunities: NASA college scholars, secondary school teachers, and high school students who are current 10th and 11th graders. Interested individuals can obtain L.E.R.C.I.P. application information and respective deadline dates by accessing the EPO website at <http://www.grc.nasa.gov/WWW/OEP/intern.htm> or <http://www.oai.org>

#### **Glenn Research Center**

NASA GRC is located in the Great Lakes region of Ohio and occupies a 350-acre site, adjacent to Cleveland Hopkins International Airport. The Center comprises over 150 buildings, which contains a unique collection of world-class facilities. Over 3600 people staff Glenn, including civil service employees and support service contractors.

Since 1941, GRC have been pioneers and innovators who have expanded horizons and opened frontiers for our explorers in air and space. GRC is responsible for developing and transferring critical technologies that address national priorities in aeropropulsion and space applications. Our work is focused on research for new aeropropulsion technologies, aerospace power, microgravity science, electric propulsion, and communications technologies for aeronautics, space, and aerospace applications. You are encouraged to visit the NASA GRC home page to learn more about our research activities, programs and personnel at <http://www.grc.nasa.gov>.

#### **Ohio Aerospace Institute**

Established in 1989, OAI is a private, nonprofit consortium of education, industry, and government partners supporting collaborative efforts in research, education, and training. OAI is located next to the GRC, West Area. OAI's research partnerships have led to significant advances in aerospace systems, new technologies in biomedical components, and improved design and manufacturing systems. More information on OAI can be found at <http://www.oai.org>.

# 2004 COLLEGE STUDENT APPLICATION FORM

Please type or print in black ink only.

Legal name: \_\_\_\_\_  
                    *First*                    *MI*                    *Last*

Date of birth: \_\_\_\_\_  
  *Month*  *Date*  *Year*

Social Security number: \_\_\_\_\_

Place of birth: \_\_\_\_\_  
  *City*          *State*  *Country*

U.S. citizen  Yes  No

Gender: Male  Female

If U.S. citizen and born outside the U.S. or Puerto Rico you **must** provide the information requested below and if selected provide documentation prior to start date.

Naturalization or Passport Number: \_\_\_\_\_

Date Issued: \_\_\_\_\_ Date Expired: \_\_\_\_\_

## YOU MUST PROVIDE BOTH ADDRESSES:

Permanent (home) address: \_\_\_\_\_

School name/address: \_\_\_\_\_

\_\_\_\_\_  
\_\_\_\_\_

\_\_\_\_\_  
\_\_\_\_\_

City State Zip Code

City State Zip Code

Telephone: \_\_\_\_\_

Telephone: \_\_\_\_\_

Alternate telephone: \_\_\_\_\_

Alternate telephone: \_\_\_\_\_

E-mail address: \_\_\_\_\_

School E-mail address: \_\_\_\_\_

Please check box below where you want any L.E.R.C.I.P. program correspondence sent to (prior April 30):

Permanent Home Address  School Address

If you are a graduating high school senior, you will be considered a college freshmen in the Fall 2004. List college(s) you have applied or been accepted to for fall enrollment:

1. \_\_\_\_\_ 2. \_\_\_\_\_ 3. \_\_\_\_\_

Current academic level: \_\_\_\_\_

ACADEMIC LEVEL as of Fall 2004: \_\_\_\_\_ COLLEGE MAJOR: \_\_\_\_\_

- |   |  |  |
|---|--|--|
| <input type="checkbox"/> College Freshman (13)  | <input type="checkbox"/> College Junior (15) | <input type="checkbox"/> Master Student (17) |
| <input type="checkbox"/> College Sophomore (14) | <input type="checkbox"/> College Senior (16) | <input type="checkbox"/> Ph.D. Student (18)  |
|   |  | <input type="checkbox"/> HS Teacher (19)     |

Credit hours earned as of May/June 2004: \_\_\_\_\_ Total credit hours required for graduation: \_\_\_\_\_

Planned graduation date: \_\_\_\_\_

Cumulative GPA out of 4.0 \_\_\_\_\_ must be supported by school transcripts (*Minimum eligibility: 3.0 GPA*)

## PROGRAM USE ONLY

Date Received: \_\_\_\_\_

PR Requirement: \$ \_\_\_\_\_

Date Processed: \_\_\_\_\_

11 12 13 14 15 16 17 18 19

Initials: \_\_\_\_\_

## Student's Narrative Statement

Student's name \_\_\_\_\_ Date \_\_\_\_\_

In the space below, tell us what you would like to achieve during your internship at GRC (Typed or legibly written using black ink) addressing the following:

- Reason(s) for wanting to participate in L.E.R.C.I.P.
- Academic field of interests and potential placement areas
- How this internship would help you pursue your career interests/aspirations
- How both you and NASA will benefit if you are selected to participate

## STUDENT CERTIFICATION

---

I certify, by my signature below, that I am a citizen of the United States of America and that all information contained in this application is accurate and correct. I further understand and agree that any misrepresentation or inaccurate information on this completed application will be cause for disqualification for consideration and from participation in the L.E.R.C.I.P. program and other NASA Programs. I also understand that if selected to participate, I must participate for the full duration of the program and failure to do so or abide by the program policies if selected will result in the immediate termination of my internship.

Printed legal name \_\_\_\_\_

Signature \_\_\_\_\_ Date \_\_\_\_\_

---

### **L.E.R.C.I.P. Past Participants Only:**

If you were a past participant of L.E.R.C.I.P. 2003 at GRC, would you like to return to the same organization and mentor?  Yes  No

If yes, you are encouraged to contact the mentor and let him/her know that you have applied for 2004 and if summer positions are available in his/her respective organization you would like to be considered. Remember there is **NO** guarantee of a position, as organizational and budgetary needs change each year.

Would you like to be notified of other internship opportunities that may be available?  Yes  No

## Student Information

Name: \_\_\_\_\_

Male  Female

Program you are applying for: L.E.R.C.I.P. College Internship

In order to determine the degree to which members of each ethnic/racial group are reached by this announcement, NASA requests that the student check the appropriate block(s) below. Submission of this information is VOLUNTARY. Please complete and return with application materials.

### 1. Ethnicity background

- a.  African-American/Black
- b.  Asian American\*
- c.  Caucasian/White
- d.  Hispanic/Latino
- e.  Native American or Alaskan Native
- f.  Pacific Islander/Native Hawaiian\*\*
- g.  Other, please specify: \_\_\_\_\_

### 2. Individual with disabilities\*\*\*

- a.  Yes  No
- b. If yes, please specify: \_\_\_\_\_
- c. Please list any special accommodations required:  
\_\_\_\_\_  
\_\_\_\_\_

\* This includes, for example, China, India, Japan, and Korea.

\*\*This area includes any of the original peoples of Hawaii; the U.S. Pacific Territories of Guam, American Samoa, and the Northern Marianas; the U.S. Trust Territory of Palau; the Islands of Micronesia and Melanesia; and the Philippines.

\*\*\*A person having a physical or mental impairment that substantially limits one or more major life activities, has a record of such impairment, or is regarded as having such impairment.

The information solicited on this form will not be available to those responsible for reviewing applications but will be used by OAI/NASA primarily to determine the extent to which various populations are represented in the applicant pool. This information will remain strictly confidential.



Applicant, fill in your name on the endorsement form, separate it from the application form, and give it along with the enclosed envelope (or a plain white envelope) to the teacher/faculty member you are asking to provide a recommendation based on your academic ability and interpersonal skills. Because the endorsement letter is requirement of the application package, you are encouraged to set a predetermined date with the faculty member of when you can pick up the endorsement.

## L.E.R.C.I.P. TEACHER/FACULTY ENDORSEMENT

**\*\*Must be a current instructor in applicant's area of expertise.\*\***

Student's name: \_\_\_\_\_

Student's school: \_\_\_\_\_

The above-named student is applying for a summer internship at the NASA GRC. If selected, the student will be given the opportunity to work with GRC staff in a professional environment. Your endorsement of the student is requested in the space provided below or attach a separate letter. Be sure to address the following: *Student's potential to contribute and benefit from the experience, academic interests, maturity and commitment to completion of assignments.*

YES, I recommend the student for the program

NO, I do not recommend the student

Printed name: \_\_\_\_\_ Date: \_\_\_\_\_

School title: \_\_\_\_\_ Telephone: \_\_\_\_\_

Department: \_\_\_\_\_

Address: \_\_\_\_\_

Email Address: \_\_\_\_\_

City

State

Zip Code

May we contact you for additional information?  YES  NO

**IMPORTANT:** For the student to be eligible for the program the endorsement and his/her application must be received no later than **January 31, 2004**. The student should return this form in a sealed envelope with their application materials. If the endorsement must be sent separately, it should be sent to the following address:

**Ohio Aerospace Institute  
Attention: L.E.R.C.I.P.  
22800 Cedar Point Road  
Cleveland, OH 44142**

## APPLICATION PACKAGE CHECKLIST

Before submitting your application materials, you should read it thoroughly. Special attention should be given to eligibility requirements, program dates, and deadlines. Be sure that you have supplied all information and materials requested. You are encouraged to make a copy of your completed application package, as we are unable to return any application materials submitted for the program.

### REQUIRED APPLICATION INFORMATION FOR COMPLETED APPLICATION PACKAGE

(check when completed)

1.  **2004 COLLEGE Student Application Form**
2.  **Placement Information**
3.  **Student's Narrative Statement**
4.  **Academic Information**
5.  **Student Certification** (*Name printed, signed and dated*)
6.  **Student Information**
7.  **Teacher/Faculty Endorsement Form** (*Return in sealed white envelope, be sure student's name is printed across the front of the envelope, photocopies of this form are not required. Must be received by January 31, 2004 for student to be eligible for program.*)
8.  **School Transcripts** (*Attach your current transcript of courses completed. Transcript should include final grades, cumulative GPA, and credit hours taken to date thru 2003 Fall semester/quarters. Photocopying your original transcript for application copies is acceptable. Unofficial school photocopies are also acceptable. Unacceptable: computer generated or handwritten report cards.*)
9.  **Original, signed application**
10.  **Three, complete copies of application, NOT including original** (*Applications that do not have the required copies are considered incomplete and will not be processed.*)

**Your application package will not be considered complete unless the original, signed application plus three copies of required items are included and received by January 31, 2004.**

**FAXED APPLICATION COPIES OR MATERIALS ARE UNACCEPTABLE.**

---

Mail your completed application package to:

**Ohio Aerospace Institute (OAI)  
Attn: L.E.R.C.I.P.  
22800 Cedar Point Road  
Cleveland, OH 44142**

---

**Questions or additional information, contact:**

OAI Telephone: 440-962-3170 Ext. 5006 or email: [internships@oai.org](mailto:internships@oai.org) or [intern@grc.nasa.gov](mailto:intern@grc.nasa.gov)

Want more information about OAI or GRC visit:  
website: <http://www.oai.org> or website: <http://www.grc.nasa.gov>

**PLEASE BE ADVISED THAT ANY APPLICATION OR APPLICATION MATERIALS RECEIVED AFTER THE DEADLINE DATE, JANUARY 31, 2004, WILL NOT BE CONSIDERED OR PROCESSED AND ARE CONSIDERED INELIGIBLE—NO EXCEPTIONS.**

**OFFER AND CONFIRMATION LETTER**

May 19, 2004

«First\_Name» «Last\_Name»  
«Street1»  
«City», «State» «Zip\_Code»

Dear «First\_Name»,

On behalf of OAI and the Educational Programs Office at NASA John H. Glenn Research Center (GRC) at Lewis Field, it is a pleasure to inform you that you have been selected for an internship in the 2004 Lewis' Educational and Research Collaborative Internship Program (L.E.R.C.I.P.). As usual, the applicant pool was competitive and you are to be congratulated for having been selected. This internship is intended to provide you with research oriented educational experiences to complement your academic field of study.

Your starting date is planned for «Tenure» and the length of your tenure will be 10 weeks. Plan to arrive at NASA GRC by 7:45 A.M. on your starting date for a student orientation. The main entrance to NASA GRC is on the south side of Brookpark Road at the western end of Cleveland Hopkins International Airport. It can be reached from the Grayton Road exit off of Interstate 480. A map is enclosed to assist you. The orientation will be held in the Administration Building Auditorium (Building 3) and will begin at 8:00 A.M. Stop at the main gate by the guardhouse for directions to the Administration Building (Building 3) and the Hanger Parking Lot, which is located just across Taylor Road. For identification and admission to NASA GRC, you must bring this letter with you. The receptionist at the entrance of the building will direct you to the Auditorium for orientation and completion of appropriate paperwork. In order to assist in this process, you will need to bring with you two forms of identification to show 1) a photo ID (driver's license or school ID) and 2) your social security card. Upon review of these materials you will be issued your NASA badge.

The enclosed Mentor Student Assignment Form indicates the organization that will host you during your internship, the activities and responsibilities planned for you, and the NASA employee who will serve as your mentor. Your mentor will provide you with guidance and assistance throughout your internship. You are encouraged to contact your mentor prior to your arrival so you can begin to prepare for your internship and ask any additional questions you may have about your assignment. Under a cooperative agreement with NASA GRC and OAI your salary for the full internship period will be «Full\_salary». Your salary will be paid in equal biweekly installments of «Biweekly\_Salary» and distributed by OAI beginning two weeks after you start your tenure.

Because of the tight schedule and intense competition for internships, we must have you confirm or decline your offer by May 26, 2004. If you fail to respond by that time, we will assume you are unavailable and this offer will be withdrawn. Notify Mary Auzenne at (440) 962-3025 or via e-mail, [maryauzenne@oai.org](mailto:maryauzenne@oai.org), of your acceptance or decline of this offer, and specifically confirm your dates of participation. **In addition, complete the enclosed 1) Application for Badge Form, 2) Confirmation of Acceptance Form and 3) Tax Forms and forward the originals in the enclosed return envelope to acknowledge your acceptance of the terms and conditions of this offer by the deadline date above.**

All interns will be regarded as professionals for which business dress is always appropriate. Shorts are strictly prohibited at your worksite. In addition to performing your internship assignment, you are expected to participate in the scheduled professional and social activities.

If you require more information about your responsibilities as an intern, we suggest that you contact your mentor at the number listed on the enclosed Student Assignment Form. If you need additional information, please contact Mary Auzenne, Program Manager, OAI at (440) 962-3025 or Susan Gott, Program Manager, NASA Glenn Research Center at (216) 433-3833. We look forward to your arrival.

Sincerely,

Ann O. Heyward  
Vice President of Workforce Enhancement

6 Enclosures

1. Confirmation of Acceptance Form
2. Application for Badge Form with Return Envelope
3. Student Assignment Form
4. Map
5. Federal and State Tax Forms
6. Housing List (if requested)

cc: Mary Auzenne OAI  
Official File 9200  
«Mentor\_Name» «MS»  
«Alt\_mentor» «MS1»

**L.E.R.C.I.P.**  
**Confirmation of Acceptance of Offer**

This confirms my acceptance of a NASA internship

Please sign and return this form in the enclosed envelope  
By May 26, 2004

Questions contact:  
Mary Auzenne  
at maryauzenne@oai.org

I, «First\_Name» «Last\_Name», accept the assignment and agree to serve the entire 10 week tenure, effective «Tenure», at NASA John H. Glenn Research Center at Lewis Field.

\_\_\_\_\_  
Signature

\_\_\_\_\_  
Date

Academic Level (\$) «Full\_salary»

*(please check)*

Correct \_\_\_\_\_

Incorrect \_\_\_\_\_

Corrected Level \_\_\_\_\_

*(write in correct amount)*

**For Office Use Only**

Date Received: \_\_\_\_\_

Date Entered: \_\_\_\_\_

# **LIST OF COLLEGE INTERNS**

## 2004 L.E.R.C.I.P. College Participants

Number of participants: 178

| <u>Student Name</u>       | <u>School</u>                          |
|---------------------------|--|
| ANGEL, HEATHER K          | COLORADO SCH. MINES                    |
| ARMSTRONG, AARON E        | BRIGHAM YOUNG UNIVERSITY-IDAHO         |
| ASNANI, VIVAKE M          | OHIO STATE UNIVERSITY                  |
| AUDU, ABDULLAHI M         | CLEVELAND STATE UNIVERSITY             |
| BARKER, SAMUEL P          | BRIGHAM YOUNG UNIVERSITY-IDAHO         |
| BARNETT, TRACI M          | KENT STATE UNIVERSITY                  |
| BARR, PHILIP J            | PURDUE UNIVERSITY                      |
| BASTRZYK, MARTA B         | ILLINOIS INSTITUTE OF TECHNOLOGY       |
| BELIERES, JEAN-PHILIPPE A | ARIZONA STATE UNIVERSITY               |
| BENDER, JEFFREY B         | PENN STATE UNIVERSITY                  |
| BERKELEY, EMILY R         | JOHNS HOPKINS UNIVERSITY               |
| BEWLEY, NATHANIEL M       | CUYAHOGA COMMUNITY COLLEGE - WEST      |
| BIELOZER, MATTHEW C       | OHIO STATE UNIVERSITY                  |
| BIGACH, KRISTIN M         | LEHIGH UNIVERSITY                      |
| BISHOP, ERIC              | OHIO STATE UNIVERSITY                  |
| BLACKWELL, KEITH M        | CLEVELAND STATE UNIVERSITY             |
| BLAZE, GINA M             | CLEVELAND STATE UNIVERSITY             |
| BOGUSZ, ZACHARY A         | ITHACA COLLEGE                         |
| BOZYM, PATRICK J          | UNIVERSITY OF ILLINOIS                 |
| BRINSON, THOMAS E         | FLORIDA AGRICULTURAL & MECHANICAL U    |
| BURKE, LAURA M            | CASE WESTERN RESERVE UNIVERSITY        |
| BURNS, ERIN A             | MICHIGAN TECH UNIVERSITY               |
| BUTTNER, JENNIFER A       | BOWLING GREEN STATE UNIVERSITY         |
| CASSELLE, JUSTINE S       | XAVIER UNIVERSITY                      |
| CATER, GEORGE M           | UNIVERSITY OF MICHIGAN                 |
| CHAMBERS, RODNEY D        | OHIO STATE UNIVERSITY                  |
| CHAUDHARY, NILIKA         | MASSACHUSETTS INSTITUTE OF TECHNOLOGY  |
| CHENNAULT, JONATHAN L     | OHIO STATE UNIVERSITY                  |
| CHEPLAK, MATTHEW L        | GEORGIA TECH                           |
| CHIN, JENNIFER L          | JOHN CARROLL UNIVERSITY                |
| COLLINS, JR., TIMOTHY M   | UNIVERSITY OF CENTRAL OKLAHOMA         |
| CORRIGAN, JACQUELINE M    | UNIVERSITY OF DAYTON                   |
| CORRIGAN, JENNIFER R      | UNIVERSITY OF DAYTON                   |
| DANKOVICH, JOHN A         | CASE WESTERN RESERVE UNIVERSITY        |
| DEANGELIS, DAVID          | UNIVERSITY OF TEXAS AUSTIN             |
| DEGENNARO, ALFRED J       | CLEVELAND HEIGHTS HS                   |
| DEHPANDE, ARATI V         | OHIO STATE UNIVERSITY                  |
| DONOVAN, OWEN M           | DUKE UNIVERSITY                        |
| DORAIS, CHRISTOPHER M     | NASHVILLE STATE TECH COMMUNITY COLLEGE |
| DOWNEY, JOSEPH A          | UNIVERSITY OF TOLEDO                   |
| DVORACEK, CHARLENE M      | ROSE-HULMAN INSTITUTE OF TECHNOLOGY    |
| ELLIS, MATTHEW T          | PURDUE UNIVERSITY                      |
| EPPS, NICOLE E            | SPELMAN COLLEGE                        |
| FALSEY, JOHN R            | CLEVELAND STATE UNIVERSITY             |
| FEDOR, JESSICA L          | UNIVERSITY OF NOTRE DAME               |



## 2004 L.E.R.C.I.P. College Participants

Number of participants: 178

| Student Name               | School                                |
|----------------------------|---------------------------------------|
| FEHRMANN, ELIZABETH A      | ROCHESTER INSTITUTE OF TECHNOLOGY     |
| FINLAY, KATHERINE A        | CASE WESTERN RESERVE UNIVERSITY       |
| FLEGEL, ASHLIE B           | UNIVERSITY OF TOLEDO                  |
| FORNUFF, JONATHAN T        | GEORGIA TECH                          |
| FOSTER, RYAN A             | UNIVERSITY OF MICHIGAN                |
| FRANCE, JOSHUA             | UNIVERSITY OF CINCINNATI              |
| GAMBLE, ELEANOR A          | PURDUE UNIVERSITY                     |
| GOMEZ CRUZ, YAZMIN         | UNIVERSITY OF TURABO                  |
| GONZALEZ-RODRIGUEZ, ROSANA | UNIVERSITY OF PUERTO R-HUMA           |
| GOODENOW, DEBRA A          | OHIO NORTHERN UNIVERSITY              |
| GRAHAM, LAQUILIA E         | HIRAM COLLEGE                         |
| GREEN, BRYAN D             | TENNESSEE STATE UNIVERSITY            |
| GRUBER, CHRISTOPHER        | UNIVERSITY OF NOTRE DAME              |
| GUO, THERESA W             | MASSACHUSETTS INSTITUTE OF TECHNOLOGY |
| HAMMOND, BRANDY M          | CLEVELAND STATE UNIVERSITY            |
| HAUSER, DANIEL M           | OHIO UNIVERSITY                       |
| HAWES, NICHOLAS E          | CLEVELAND INSTITUTE OF ART            |
| HENKE, STEPHEN A           | LORAIN COUNTY COMMUNITY COLLEGE       |
| HERTERT III, LUCIEN D      | OHIO STATE UNIVERSITY                 |
| HILL, CHANTE A             | TENNESSEE STATE UNIVERSITY            |
| HOLCHIN, JOHN E            | UNIVERSITY OF DAYTON                  |
| HOLDA, JULIE E             | OHIO NORTHERN UNIVERSITY              |
| HOMENKO, HILARY N          | STANFORD UNIVERSITY                   |
| HUANG, STEPHEN E           | CALIFORNIA POLYTECHNIC STATE U        |
| INMAN, CHRISTINA A         | SPELMAN COLLEGE                       |
| JEFFRIES, TAMARCUS L       | TENNESSEE STATE UNIVERSITY            |
| JOHNSON, MELISSA S         | HOWARD UNIVERSITY                     |
| JONES, JANELLE             | SPELMAN COLLEGE                       |
| JORDAN, TRACEE M           | TENNESSEE STATE UNIVERSITY            |
| JORDAN, WILLIAM A          | UNIVERSITY OF KENTUCKY                |
| KARDAMIS, JOSEPH R         | ROCHESTER IT                          |
| KASCAK, DANIEL J           | OHIO UNIVERSITY                       |
| KASICK, MICHAEL P          | CARNEGIE MELLON UNIVERSITY            |
| KELLERMAN, CORINNE R       | UNIVERSITY OF ARIZONA                 |
| KENNY, PATRICK W           | OHIO STATE UNIVERSITY                 |
| KIEFER, WALTER D           | UNIVERSITY OF AKRON                   |
| KING, JAMES D              | FAYETTEVILLE STATE UNIVERSITY         |
| KUNDU, SAMPA               | CLEVELAND STATE UNIVERSITY            |
| LANGE, STUART R            | PRINCETON UNIVERSITY                  |
| LASTER, RACHEL M           | KENTUCKY STATE UNIVERSITY             |
| LIANG, MARGARET I          | OHIO STATE UNIVERSITY                 |
| LOGAN, JULIAN A            | MC NAIR                               |
| LORIG, JONATHAN            | UNIVERSITY OF ILLINOIS                |
| LUGAS, GRANT A             | LORAIN COUNTY COMMUNITY COLLEGE       |
| MACISCO, CHRISTOPHER A     | OHIO STATE UNIVERSITY                 |

## 2004 L.E.R.C.I.P. College Participants

Number of participants: 178

| Student Name           | School                                    |
|------------------------|---|
| MAKUCH, LAUREN A       | PENN STATE UNIVERSITY                     |
| MALDONADO, CHRISTINA M | TRINITY HS                                |
| MARTINEZ, DIANA A      | UNIVERSITY OF TEXAS-EL PASO               |
| MATE, JR., ROBERT C    | MARQUETTE UNIVERSITY                      |
| MATTEI, NICHOLAS S     | UNIVERSITY OF KENTUCKY                    |
| MCRAE, KALINDRA A      | FAYETTEVILLE STATE UNIVERSITY             |
| MIGNOSA, GIOVANNA E    | OHIO UNIVERSITY                           |
| MILLER, DAVID A        | SHAW UNIVERSITY                           |
| MILLER, ERIC J         | UNIVERSITY OF CINCINNATI                  |
| MINTZ, SHAUNA M        | UNIVERSITY OF AKRON                       |
| MONTAGUE, IDOREYIN P   | SHAW UNIVERSITY                           |
| MOON, JAMES S          | TENNESSEE STATE UNIVERSITY                |
| MORENO, MICHELLE       | UNIVERSITY OF TEXAS PAN AM                |
| MORIARTY, MICHAEL J    | LORAIN COUNTY COMMUNITY COLLEGE           |
| MURRAY, SHATEREA R     | MISSISSIPPI VALLEY STATE UNIVERSITY- ITTA |
| NAKIS, CHRISTOPHER G   | GROVE CITY COLLEGE                        |
| NEAL, BRITTANY D       | ALLEGHENY COLLEGE                         |
| NEEDHAM, ROBERT J      | CASE WESTERN RESERVE UNIVERSITY           |
| NEVILLE, JOSHUA T      | OHIO UNIVERSITY                           |
| NEWSTADT, GREGORY E    | MIAMI UNIVERSITY                          |
| NGUYEN, SONCA          | UNIVERSITY OF WASHINGTON                  |
| OGUNWUYI, OLUWATOSIN O | CITY COLLEGE OF NEW YORK                  |
| OKORO, CHIKA L         | FLORIDA AGRICULTURAL & MECHANICAL U       |
| OPALUCH, AMANDA M      | WITTENBERG UNIVERSITY                     |
| ORTIZ, FRANCISCO       | FLORIDA AGRICULTURAL & MECHANICAL U       |
| PADGETT, ALEXANDER D   | PURDUE UNIVERSITY                         |
| PANAIT, CLAUDIA        | GEORGE WASHINGTON UNIVERSITY              |
| PAPA, MELISSA R        | PENN STATE UNIVERSITY                     |
| PARMA, BRIAN J         | ARIZONA STATE UNIVERSITY                  |
| PEPLOWSKI, KATHERINE M | OHIO NORTHERN UNIVERSITY                  |
| PETERS, LEIGH C        | CASE WESTERN RESERVE UNIVERSITY           |
| PETRO, KATHRYN E       | MIAMI UNIVERSITY                          |
| PHO, SUSAN             | CASE WESTERN RESERVE UNIVERSITY           |
| POKORNY, FRANK M       | UNIVERSITY OF CINCINNATI                  |
| PRAK, MOLINE K         | JOHN CARROLL UNIVERSITY                   |
| RAACK, TAYLOR          | NORTHWESTERN UNIVERSITY                   |
| RADHAMOHAN, RANJAN S   | UNIVERSITY OF MICHIGAN                    |
| RADKE, ERIC M          | UNIVERSITY OF CALIFORNIA-LA               |
| RAMSEY, AMANDA J       | LORAIN COUNTY COMMUNITY COLLEGE           |
| REID II, ROBERT O      | UNIVERSITY OF DETROIT MERCY               |
| REIGEL, MARISSA M      | COLORADO SCH. MINES                       |
| REINERT, JASON M       | YOUNGSTOWN STATE UNIVERSITY               |
| REYNOLDS, JUSTIN A     | LORAIN COUNTY COMMUNITY COLLEGE           |
| RIOS, JEFFREY N        | CASE WESTERN RESERVE UNIVERSITY           |
| RITCHIE, LISA M        | KENT STATE UNIVERSITY                     |

## 2004 L.E.R.C.I.P. College Participants

Number of participants: 178

| <u>Student Name</u>   | <u>School</u>                         |
|-----------------------|---------------------------------------|
| RIVERAS, NYKKITA L    | UNIVERSITY OF MARYLAND-BALTIMORE      |
| ROBB, KEVIN R         | PENN STATE UNIVERSITY                 |
| ROBINSON, HEIDI N     | UNIVERSITY OF AKRON                   |
| ROBINSON, BRANDI L    | UNIVERSITY OF TOLEDO                  |
| ROGERS, RAYNA C       | UNIVERSITY OF DAYTON                  |
| SAVICH, GREGORY R     | UNIVERSITY OF ROCHESTER               |
| SHEARER, JONATHAN P   | PURDUE UNIVERSITY                     |
| SILVA, ODLANIER       | UNIVERSITY OF TURABO                  |
| SIMPSON, MICHAEL B    | GEORGIA TECH                          |
| SMITH, GENE S         | FAYETTEVILLE STATE UNIVERSITY         |
| SMITH, MATTHEW J      | PENN STATE UNIVERSITY                 |
| SOADWA, AKUA          | CLEVELAND STATE UNIVERSITY            |
| SPEER, KEVIN M        | UNIVERSITY OF ARKANSAS                |
| STORM, ROGER C        | FAIRVIEW HS                           |
| STRUHAR JR., PAUL T   | UNIVERSITY OF AKRON                   |
| SU, RICHARD Y         | UNIVERSITY OF MARYLAND-COLLEGEPK      |
| SUBICH, CHRISTOPHER J | UNIVERSITY OF CENTRAL FLORIDA         |
| SUDER, JENNIFER L     | UNIVERSITY OF AKRON                   |
| SUMMERS, EDWARD K     | MASSACHUSETTS INSTITUTE OF TECHNOLOGY |
| SZABO, HORTENZIA      | BALDWIN WALLACE COLLEGE               |
| THANH, PHI HUNG X     | COLORADO SCH. MINES                   |
| THOMAS, CANDACE J     | HAMPTON UNIVERSITY                    |
| THOMAS, ASHLEY N      | UNIVERSITY OF AKRON                   |
| THOMPSON, DANIEL      | OHIO WESLEYAN UNIVERSITY              |
| THREATT, JAMARR A     | COLUMBUS ALT. HS                      |
| TRAPP, SCOTT J        | UNIVERSITY OF TOLEDO                  |
| TRAPP, MARK A         | CARNEGIE MELLON UNIVERSITY            |
| TRAVIS, BRANDON E     | UNIVERSITY OF KENTUCKY                |
| TURGAY, EREN H        | UNIVERSITY OF KENTUCKY                |
| UNTON, TIMOTHY J      | EMBRY-RIDDLE AERO UNIVERSITY          |
| VARALJAY, VANESSA A   | CLEVELAND STATE UNIVERSITY            |
| VASSILARAS, PLOUSIA E | BALDWIN WALLACE COLLEGE               |
| WARD, LA'NITA D       | SPELMAN COLLEGE                       |
| WEILER, CARLY P       | UNIVERSITY CINCINNATI                 |
| WILDER, WILLIAM D     | CLEVELAND STATE UNIVERSITY            |
| WONG, DAVID           | UNIVERSITY OF MICHIGAN                |
| WRIGHT, SHAYLA L      | UNIVERSITY OF TOLEDO                  |
| YANKE, ANNE M         | CLEVELAND STATE UNIVERSITY            |
| YASSINE, NATHAN K     | CLEVELAND STATE UNIVERSITY            |
| YOUNG, III, NATHANIEL | PRAIRIE VIEW A&M UNIVERSITY           |
| ZESZOTEK, MICHELLE    | PURDUE UNIVERSITY                     |
| ZHANG, WEI            | GEORGIA TECH                          |
| ZIVICH, CHAD P        | CASE WESTERN RESERVE UNIVERSITY       |

# **COLLEGE SCHEDULE OF ACTIVITIES**

**2004 L.E.R.C.I.P. SCHEDULE OF ACTIVITIES**  
**NASA John H. Glenn Research Center at Lewis Field**

| <b>Date</b>      | <b>Event</b>  | <b>Location/Time</b>   |
|------------------|---|--|
| May 24, 2004     | Orientation #1  | Administration Building, 8:00-12:00 P.M.                                 |
| May 27, 2004     | Social/Networking   | Guerin House, 3:30-6:30 P.M.   |
| May 28, 2004     | PAYDAY  | NASA Main Cafeteria, 11:00-1:00 P.M.                                     |
| June 7, 2004     | Orientation #2  | Administration Building, 8:00-12:00 P.M.                                 |
| June 10, 2004    | Social/Networking   | Guerin House, 3:30-6:30 P.M.   |
| June 11, 2004    | PAYDAY<br>Follow-Up Session #1 (Mandatory)*                                     | NASA Main Cafeteria, 11:00-1:00 P.M.<br>NASA Main Cafeteria, 9:00-4 P.M. |
| June 14, 2004    | Orientation #3  | Administration Building, 8:00-12:00 P.M.                                 |
| June 17, 2004    | Social/Networking   | Guerin House, 3:30-6:30 P.M.   |
| June 22, 2004    | Technical Presentation Workshop<br>(Mandatory for 1 <sup>st</sup> year interns) | OAI Forum, 8:00 A.M.--5:00 P.M.<br>(two sessions)                        |
| June 23, 2004    | Professional Development Workshop<br>(Mandatory for 2 <sup>nd</sup> + years)    | OAI Forum, 8:00 A.M.--5:00 P.M.<br>(two sessions)                        |
| June 25, 2004    | PAYDAY<br>Follow-Up Session #2 (Mandatory)*                                     | NASA Main Cafeteria, 11:00-1:00 P.M.<br>NASA Main Cafeteria, 9:00-4 P.M. |
| July 7 - 8, 2004 | Research Symposium I (Mandatory)  | OAI Forum, Federal and Industry Rooms<br>9:00-3:30 P.M.                  |
| July 9, 2004     | PAYDAY<br>Follow-Up Session #3 (Mandatory)*                                     | NASA Main Cafeteria, 11:00-1:00 P.M.<br>NASA Main Cafeteria, 9:00-4 P.M. |
| July 14, 2004    | Student/Mentor Picnic   | NASA Picnic Grounds, 3:30-8:00 P.M.                                      |
| July 15, 2004    | GRC Summer Job Fair   | OAI, 1:00 P.M.   |
| July 21, 2004    | Student/Mentor Recognition Banquet  | NASA Main Cafeteria, 3:30-6:30 P.M.                                      |
| July 23, 2004    | PAYDAY  | NASA Main Cafeteria, 11:00-1:00 P.M.                                     |
| July 30, 2004    | EDCATS DUE / End Date – May 24 <sup>th</sup> Start Date                         | TBA  |
| August 4-5, 2004 | Research Symposium II (Mandatory)   | OAI President, Federal and Industry Rooms<br>9:00-3:30 P.M.              |
| August 6, 2004   | PAYDAY  | NASA Main Cafeteria, 11:00-1:00 P.M.                                     |
| August 13, 2004  | EDCATS DUE / End Date – June 7 <sup>th</sup> Start Date                         | TBA  |
| August 20, 2004  | PAYDAY / EDCATS DUE<br>End Date – June 14 <sup>th</sup> Start Date              | NASA Main Cafeteria, 11:00-1:00 P.M.                                     |

**\*EXCLUDING SCHOLARS**

The NASA-ASEE Summer Faculty Fellowship Program holds Research & Technology Briefings every Friday at 2:00 P.M. in the OAI Forum Room.

**Paid HOLIDAYS : Memorial Day and Independence Day**

## **RESEARCH SYMPOSIUMS I & II**

# Research Symposium I

## Ohio Aerospace Institute

### Wednesday, July 7, 2004

#### OAI Forum Room

9:00 A.M. **Jennifer Buttler, Bowling Green State U, Sophomore**

“Low Emissions Alternative Power (LEAP) Project Office Business Team of the  
Aeropropulsion Research Program Office (ARPO) ”

0140/Barbara Mader, Aeropropulsion Research Program Office

9:15 **Jennifer Chin, John Carroll University, Junior**

“Office of Equal Opportunity Programs”

0180/Deborah Coteleur, Office of Equal Opportunity Programs

9:30 **Susan Pho, Case Western Reserve University, Junior**

“Integrated Financial Management Program”

0222/Joseph Kan, Employee and Commercial Payments Branch

9:45 **Odlanier Silva, U of Turabo, Senior**

“Investigation of Injector Slot Geometry on Curved-Diffuser Aerodynamic Performance”

0300/Gerard Welch, Vehicle Technology Directorate

10:00 **Kathryn Petro, Miami University, Junior**

“Records Management: Preserving the Past to Make the Future”

0620/Kevin Coleman, Logistics and Technical Information Division

10:15 **Session Break**

10:30 **Samuel Barker, Brigham Young U-Idaho, Senior**

“Making Space Travel to Jupiter Possible”

5120/Frank Ritzert, Advanced Metallics Branch

10:45 **Session Ending**

11:00 **LUNCH**

1:00 **Jean-Philippe Belieres, Arizona State University, PhD**

“Ionic Liquids and New Proton Exchange Membranes for Fuel Cells”

5150/James Kinder, Polymers Branch

1:15 **Katherine Peplowski, Ohio Northern University, Senior**

“High Temperature Polymers for use in Fuel Cells”

5150/James Kinder, Polymers Branch

1:30 **Plousia Vassilaras, Baldwin Wallace College, Senior**

“Nano-Casted Metal Oxide Aerogels as Dual Purpose Structural Components for Space Exploration”

5150/Nicholas Leventis, Polymers Branch

1:45 **Christina Inman, Spelman College, Sophomore**

"Photo-Curing: UV Radiation curing of polymers"

5160/Dennis Fox, Durability and Protective Coatings Branch

2:00 **John Holchin, University of Dayton, Sophomore**

"Durability of Environmental Barrier Coatings in a Water Vapor/Oxygen Environment"

5150/Dennis Fox, Polymers Branch

2:15 **John Dankovich, Case Western Reserve University, Senior**

"Thin Film Solar Cells: Organic, Inorganic and Hybrid"

5410/Sheila Bailey, Photovoltaic and Space Environments Effects Branch

2:30 **Michael Kasick, Carnegie Mellon University, Sophomore**

"Analysis of Electrical Characteristics of Thin Film Photovoltaic Cells"

5410/Aloysius Hepp, Photovoltaic and Space Environments Effects Branch

2:45 **Eren Turgay, University of Kentucky, Senior**

"Dust Accumulation and Solar Panel Array Performance on the Mars Exploration Rover (MER) Project"

5410/Geoffrey Landis, Photovoltaic and Space Environments Effects Branch

3:00 **Leigh Peters, Case Western Reserve University, Junior**

"Evaporator Development for an Evaporative Heat Pipe System"

5410/Kenneth Burke, Photovoltaic and Space Environments Effects Branch

3:15 **Robert Needham, Case Western Reserve University, Senior**

"Aircraft Fuel Cell Power Systems"

5410/Patricia Loyselle, Photovoltaic and Space Environments Effects Branch

3:30 **ADJOURN**



**Low Emissions Alternative Power (LEAP) Project Office Business Team of the  
Aeropropulsion Research Program Office (ARPO) Org. 0140**

**Jennifer A. Buttler**  
Bowling Green State University  
Marketing  
Undergraduate, sophomore  
**Mentor: Barbara Mader**

The program for which I am working at this summer is Propulsion and Power/Low Emissions Alternative Power (P&P/LEAP). It invests in a fundamental TRL 1-6 research and technology portfolio that will enable the future of: Alternative fuels and/or alternative propulsion systems, non-combustion (electric) propulsion systems. P&P/LEAP will identify and capitalize on the highest potential concepts generated both internal and external to the Agency. During my 2004 summer at NASA Glenn Research Center, I worked with my mentor Barbara Mader, in the Project Office with the Business Team completing various tasks for the project and personnel.

The LEAP project is a highly matrixed organization. The Project Office is responsible for the goals advocacy and dollar (budget) of the LEAP project. The objectives of the LEAP Project are to discover new energy sources and develop unconventional engines and power systems directed towards greatly reduced emissions, enable new vehicle concepts for public mobility, new science missions and national security. The Propulsion and Power/Low Emissions Alternative Power directly supports the environmental, mobility, national security objectives of the Vehicle Systems Program and the Aeronautics Technology Theme. Technology deliverables include the demonstration through integrated ground tests, a constant volume combustor in an engine system, and UAV/small transport aircraft all electric power system. My mentor serves as a key member of the management team for the Aeropropulsion Research Program Office (ARPO). She has represented the office on numerous occasions, and is a member of a number of center-wide panels/teams, such as the Space management Committee and is chair to the Business Process Consolidation Team. She is responsible for the overall coordination of resources for the Propulsion and Power Project- from advocacy to implementation.

The goal for my summer at NASA was to document processes and archive program documents from the past years. I used the computer and office machines, and also worked with personnel in setting up a Cost Estimation Plan. I gained office experience in Word, Excel, and Power Point, with the completion of a variety of tasks. I made spreadsheets that pertained to the budget plan for Journey to Tomorrow, to name a few I have supported the office by tracking resource information: including programmatic travel, project budget at the center level to budgets for individual research sub-projects and grants. I also assisted the Program Support Office in their duties including, representing the office on numerous occasions on center-wide teams/panels, such as the Space management committee, IFMP Budget Formulation, Journey to Tomorrow Committee, and the Vehicle Systems Program Business Process Team.

Office of Equal Opportunity Programs

**Jennifer L. Chin**

John Carroll University  
Marketing and Logistics  
Senior

**Mentor: Deborah Cotleur**

ABSTRACT

---

The NASA Glenn Office of Equal Opportunity Programs works to provide quality service for all programs and/or to assist the Center in becoming a model workplace. During the summer of 2004, I worked with Deborah Cotleur along with other staff members to create and modify customer satisfaction surveys.

This office aims to assist in developing a model workplace by providing functions as a change agent to the center by serving as an advisor to management to ensure equity throughout the Center. In addition, the office serves as a mediator for the Center in addressing issues and concerns. Lastly, the office provides assistance to employees to enable attainment of personal and organizational goals.

The Office of Equal Opportunities is a staff office which reports and provides advice to the Center Director and Executive Leadership, implements laws, regulations, and presidential executive orders, and provides center wide leadership and assistance to NASA GRC employees.

Some of the major responsibilities of the office include working with the discrimination complaints program, special emphasis programs (advisory groups), management support, monitoring and evaluation, contract compliance, and community outreach.

During my internship in this office, my main objective was to create four customer satisfaction surveys based on EO retreats, EO observances, EO advisory boards, and EO mediation/counseling. I created these surveys after conducting research on past events and surveys as well as similar survey research created and conducted by other NASA centers.

I began the process by reviewing the past surveys created to obtain feedback from the EO program for EO Advisory group members, leadership training sessions for supervisors, preventing sexual harassment training sessions, and observance events. In addition, I also conducted research on the style and format from feedback surveys from the Marshall Equal Opportunity website, the Goddard website, and the main NASA website. Using the material from the Office of Equal Opportunity Programs at Glenn Research Center along with my previous research, I created four customer satisfaction surveys. These surveys were then forwarded to the Equal Opportunity staff for review. Feedback from the staff gave me a framework with which to work and to improve the surveys.

My goal in the Office of Equal Opportunity Programs was to create customer satisfaction surveys to get feedback about retreats, observances, advisory boards, and mediation/counseling sessions. With this feedback, the office would be able to serve its customers in a more efficient manner by working to make any improvements to future programs.

The method to obtain more feedback from these surveys was through the posting of these surveys electronically. In addition, we intended to have an automatic survey distribution to get a faster response through the internet. In doing so, we would be able to target all the attendees and to get their feedback about the events or sessions attended.

## **Integrated Financial Management Program**

**Susan Pho**

Case Western Reserve University

Accounting

Undergraduate, Junior

**Mentor: Joseph J. Kan**

### **ABSTRACT**

Having worked in the Employees and Commercial Payments Branch of the Financial Management Division for the past 3 summers, I have seen the many changes that have occurred within the NASA organization. As I return each summer, I find that new programs and systems have been adapted to better serve the needs of the Center and of the Agency. The NASA Agency has transformed itself the past couple years with the implementation of the Integrated Financial Management Program (IFMP). IFMP is designed to allow the Agency to improve its management of its Financial, Physical, and Human Resources through the use of multiple enterprise module applications.

With my mentor, Joseph Kan, being the branch chief of the Employees and Commercial Payments Branch, I have been exposed to several modules, such as Travel Manager, WebTads, and Core Financial/SAP, which were implemented in the last couple of years under the IFMP. The implementation of these agency-wide systems has sometimes proven to be troublesome. Prior to IFMP, each NASA Center utilizes their own systems for Payroll, Travel, Accounts Payable, etc. But with the implementation of the Integrated Financial Management Program, all the "legacy" systems had to be eliminated. As a result, a great deal of enhancement and preparation work is necessary to ease the transformation from the old systems to the new. All this work occurs simultaneously; for example, e-Payroll will "go live" in several months, but a system like Travel Manager will need to have information upgraded within the system to meet the requirements set by Headquarters.

My assignments this summer have given me the opportunity to become involved with such work. So far, I have been given the opportunity to participate in projects resulting from a congressional request, several bankcard reconciliations, updating routing lists for Travel Manager, updating the majordomo list for Travel Manager approvers and point of contacts, and a NASA Headquarters project involving improper payments on firm fixed price contracts.

Each of the projects that I have worked on this summer presents a different aspect of the work performed on a regular basis by members of this branch. Not only do I get to see the "big picture" of what occurs within the organization, but I also get to experience the "little stuff" that goes on here and throughout the NASA Agency.

# INVESTIGATION OF INJECTOR SLOT GEOMETRY ON CURVED-DIFFUSER AERODYNAMIC PERFORMANCE

Odlanier Silva  
University of Turabo  
Mechanical Engineering  
Undergraduate, Senior  
**Mentor: Gerard E. Welch**

## ABSTRACT

The Compressor Branch vision is to be recognized as world-class leaders in research for fluid mechanics of compressors. Its mission is to conduct research and develop technology to advance the state of the art of compressors and transfer new technology to U. S. industries. Maintain partnerships with U.S. industries, universities, and other government organizations. Maintain a balance between customers focused and long range research.

Flow control comprises enabling technologies to meet compression system performance requirements driven by emissions and fuel reduction goals (*e.g.*, in UEET), missions (*e.g.*, access-to-space), aerodynamically aggressive vehicle configurations (*e.g.*, UAV and future blended wing body configurations with highly distorted inlets), and cost goals (*e.g.*, in VAATE). The compression system requirements include increased efficiency, power-to-weight, and adaptability (*i.e.*, robustness in terms of wide operability, distortion tolerance, and engine system health and reliability). The compressor flow control task comprises efforts to develop, demonstrate, and transfer adaptive flow control technology to industry to increase aerodynamic loading at current blade row loss levels, to enable adaptively wide operability, and to develop plant models for adaptive compression systems. In this context, flow control is the controlled modification of a flow field by a deliberate means beyond the natural (uncontrolled) shaping of the solid surfaces that define the principal flow path. The objective of the compressor flow control task is to develop and apply techniques that control circulation, aerodynamic blockage, and entropy production in order to enhance the performance and operability of compression systems for advanced aero-propulsion applications.

This summer I would be working with a curved-diffuser because it simulates what happens with flow in the stator blades in the compressor. With this experiment I will be doing some data analysis and parametric study of the injector slot geometries to get the best aerodynamic performance of it. This includes some data reduction, redesign and fast prototyping of the injector nozzle.

**Kathryn Petro**  
Miami University  
Major: Marketing  
Mentor: Kevin Coleman

### **Records Management: Preserving the Past to Make the Future**

As an intern in the Records Management Office at NASA, I have learned the importance of records management and teamwork. I work in building 60 with Kevin Coleman, the Records and Forms Manager and History Officer, and Deborah Demaline, the senior records specialist. Prior to my internship, I had never paid attention to records and their role in operating a business. However, after my first assignment of identifying files and filling out a C-277 form, I realized the importance of preserving each file.

Since NASA is a government agency, keeping our records in a safe and easily accessible area is a major priority. As the records have accumulated over the years, and the destruction of records has been put on hold due to the fairly recent tobacco litigation; the amount of NASA's records has been quickly accumulating. Currently, our records are stored at Plum Brook in Sandusky, Ohio. Recently, rain has leaked through the bunkers and caused damage to some of our records boxes. Plum Brook has been experiencing difficulty in finding the funds to repair the damage. NASA Glenn is reluctant to give Plum Brook more money because the staff at the Sandusky site has not shown us a detailed summary of what they are doing with the funds we give them annually.

Even though storing our records at Plum Brook comes with little cost, there are plenty other companies that offer a records storage area and a special software database for easy record retrieval. My assignment is to do a feasibility study on these companies to see how they compare in providing the appropriate criteria for NASA Glenn's needs. Other research I am doing is on which companies will allow us to convert our physical records into an electronic database for quicker retrieval and to eliminate the cost of storing our records in a facility altogether.

The two studies have required me to not only work closely with the Records Management Department, but also the Information Technology staff. It has been important for me to thoroughly understand the criteria both departments here at NASA Glenn need in order to make the system effective for the entire organization. The interaction that I am experiencing with different organizations within NASA Glenn and the various companies we are looking at has enhanced my communication skills. Without proficient communication skills, it is difficult to seek how each company meets all of NASA's standards. This includes webx conferences, teleconferences, face-to-face meetings, knowing the appropriate time to ask questions, knowing what those appropriate questions are, and most importantly, being a good listener. During the meetings and conferences I attend, I ensure that I understand where each party is coming from and listen carefully to the points people make.

In addition to working with the feasibility study, I will later work on a marketing plan to encourage employees to take care in storing their records and learn the importance of the History Office. Also, the department is trying to develop a special presentation for new employees during their orientation. Assisting Deborah Demaline in taking inventory at Plum Brook is another task that must be done to ensure that the records have been properly placed.

## MAKING SPACE TRAVEL TO JUPITER POSSIBLE

**Samuel P. Barker**

Brigham Young University-Idaho

Senior

Frank Ritzert

### ABSTRACT

From man landing on the moon to a simple satellite being launched into orbit, many incredible space accomplishments have been witnessed by us all. However, what goes un-noticed to the common man is the extensive research and testing that lasts months, years, and even decades. Much of this required research just so happens to take place in the corridors of the Glen Research Center building number 49.

In the Advanced Materials division of G.R.C., a number of researchers have the responsibility of discovering which metal, ceramic, or polymer is best for a specific application. Under the guidance of mentor extraordinaire Frank Ritzert, I am involved in many critical projects dealing with refractory metals, two of which I will mention in this report.

The Jupiter Icy Moons Orbiter (JIMO) project actually was under full swing back in the 50's and early 60's. To enable the 14 year trek to the icy moons of Europa, Callisto, and Ganymede, nuclear propulsion methods were selected. Due to the extreme temperature of the reactor and the extended time period, a refractory metal would need to be implemented. After years of research and progress, the program was suddenly canceled.

About a decade ago, the JIMO project was re-instated and now has a goal for departure around 2014. However, a few obstacles lie in our way concerning the use of refractory metals. In certain areas of the orbiter a joint is required between the refractories and other less dense metals. Two of these joints are with nickel based super alloys. Being an intern for Frank Ritzert, the refractory metals expert, I have the opportunity to develop the best method to braze refractory metals to Nickel 201. This involves the actual brazing, electron microscopy and reporting the results. My second project involves a certain part of the orbiter where Niobium 1Zirconium, a refractory metal, is joined with Hastelloy-X a Ni based metal. Small quantities of oxygen, helium and other impurities in the Ni alloy could diffuse into the Nb1Zr causing embrittlement and possibly major failure. I will be testing the effects of Hast-X on Nb1Zr in a high temperature for 10, 50, 100, and 500 hours. After the samples are run through the heat treatment, strength and chemistry will be tested and reported.

My appreciation for the research that goes behind every project has and will continue to grow. By digging through old documents written in the 50's and 60's, scouring through forgotten closets, and learning from those with experience in the refractory metals, I am bound to have an incredible learning experience here at N.A.S.A.

# IONIC LIQUIDS AND NEW PROTON EXCHANGE MEMBRANES FOR FUEL CELLS

**Jean-Philippe Belières**  
Arizona State University  
Physical Chemistry  
PhD  
**Mentor: James Kinder**

## ABSTRACT

There is currently a great surge of activity in fuel cell research as laboratories across the world seek to take advantage of the high energy capacity provided by fuel cells relative to those of other portable electrochemical power systems. Much of this activity is aimed at high temperature fuel cells, and a vital component of such fuel cells must be the availability of a high temperature stable proton-permeable membrane. NASA Glenn Research Center is greatly involved in developing this technology.

Other approaches to the high temperature fuel cell involve the use of single-component or almost-single-component electrolytes that provide a path for protons through the cell. A heavily researched case is the phosphoric acid fuel cell, in which the electrolyte is almost pure phosphoric acid and the cathode reaction produces water directly. The phosphoric acid fuel cell delivers an open circuit voltage of 0.9 V falling to about 0.7 V under operating conditions at 170°C. The proton transport mechanism is mainly vehicular in character according to the viscosity /conductance relation.

Here we describe some Proton Transfer Ionic Liquids (PTILs) with low vapor pressure and high temperature stability that have conductivities of unprecedented magnitude for non-aqueous systems. The first requirement of an ionic liquid is that, contrary to experience with most liquids consisting of ions, it must have a melting point that is not much above room temperature. The limit commonly suggested is 100°C. PTILs constitute an interesting class of non-corrosive proton-exchange electrolyte, which can serve well in high temperature ( $T = 100 \sim 250^\circ\text{C}$ ) fuel cell applications.

We will present cell performance data showing that the open circuit voltage output, and the performance of a simple  $\text{H}_2(\text{g})/\text{Pt}/\text{PTIL}/\text{Pt}/\text{O}_2(\text{g})$  fuel cell may be superior to those of the equivalent phosphoric acid electrolyte fuel cell both at ambient temperature and temperatures up to and above 200°C.

My work at NASA Glenn Research Center during this summer is to develop and characterize proton exchange membranes doped with ionic liquids. The main techniques used to characterize these materials are: Impedance Spectroscopy, NMR, DSC, TGA, DMA, IR, and SEM ...

## High Temperature Polymers for use in Fuel Cells

**Katherine M. Peplowski**  
Ohio Northern University  
Chemistry  
Senior

**Mentor: James Kinder**

### ABSTRACT

NASA Glenn Research Center (GRC) is currently working on polymers for fuel cell and lithium battery applications. The desire for more efficient, higher power density, and a lower environmental impact power sources has led to interest in proton exchanges membrane fuels cells (PEMFC) and lithium batteries.

A PEMFC has many advantages as a power source. The fuel cell uses oxygen and hydrogen as reactants. The resulting products are electricity, heat, and water. The PEMFC consists of electrodes with a catalyst, and an electrolyte. The electrolyte is an ion-conducting polymer that transports protons from the anode to the cathode.

Typically, a PEMFC is operated at a temperature of about 80°C. There is intense interest in developing a fuel cell membrane that can operate at higher temperatures in the range of 80°C-120°C. Operating the fuel cell at higher temperatures increases the kinetics of the fuel cell reaction as well as decreasing the susceptibility of the catalyst to be poisoned by impurities. Currently, Nafion made by Dupont is the most widely used polymer membrane in PEMFC. Nafion does not function well above 80°C due to a significant decrease in the conductivity of the membrane from a loss of hydration. In addition to the loss of conductivity at high temperatures, the long term stability and relatively high cost of Nafion have stimulated many researches to find a substitute for Nafion.

Lithium ion batteries are popular for use in portable electronic devices, such as laptop computers and mobile phones. The high power density of lithium batteries makes them ideal for the high power demand of today's advanced electronics. NASA is developing a solid polymer electrolyte that can be used for lithium batteries. Solid polymer electrolytes have many advantages over the current gel or liquid based systems that are used currently. Among these advantages are the potential for increased power density and design flexibility.

Automobiles, computers, and cell phones require highly efficient power density for lowering emissions and meeting increasing consumer demands. Many of the solutions can be provided by proton exchange membrane fuel cells and lithium batteries. NASA Glenn Research Center has recognized this need, and is presently engaged in a solution. The goals for the summer include mastering synthesis techniques, understanding the reactions occurring during the synthesis, and characterizing the resulting polymer membranes using NMR, DSC, and TGA for the PEMFC and lithium batteries.



NANO-CASTED METAL OXIDE AEROGELS  
AS DUAL PURPOSE STRUCTURAL COMPONENTS FOR SPACE EXPLORATION

Plousia E. Vassilaras  
Baldwin-Wallace College  
Physics and Chemistry  
Undergraduate  
Mentor: Dr. Nicholas Leventis

NASA missions and space exploration rely on strong, ultra lightweight materials. Such materials are needed for building up past and present space vehicles such as the Sojourner Rover (1997) or the two MERs (2003), but also for a number of components and/or systems including thermal insulators, Solar Sails, Rigid Aeroshells, and Ballutes. The purpose of my internship here at Glenn Research Center is to make dual purpose materials; materials that in addition to being lightweight have electronic, photophysical and magnetic properties and, therefore, act as electronic components and sensors as well as structural components. One type of ultra lightweight material of great interest is aerogels, which have densities ranging from  $0.003 \text{ g/cm}^3$  to  $0.8 \text{ g/cm}^3$ . However, aerogels are extremely fragile and, as a result, have limited practical applications. Recently, Glenn Research Center has developed a process of nano-casting polymers onto the inorganic network of silica-based aerogels increasing the strength 300 fold while only increasing the density 3 fold. By combining the process of nano-casting polymers with inorganic oxide networks other than silica, we are actively pursuing lightweight dual purpose materials.

To date, thirty different inorganic oxide aerogels have been prepared using either standard sol-gel chemistry or a non-alkoxide method involving metal chloride precursors and an epoxide; epichlorohydrin, propylene oxide or trimethylene oxide, as proton scavengers. More importantly, preliminary investigations show that the residual surface hydroxyl groups on each of these inorganic oxide aerogels can be successfully crosslinked with urethane. In addition to characterizing physical and mechanical properties such as density, strength and flexibility, each of these metal oxide aerogels are being characterized for thermal and electronic conductivity and magnetic and optical properties.

## **Photo-Curing: UV Radiation curing of polymers**

**Christina A. Inman**

Spelman College

Major: Chemistry/ Industrial Engineering

Undergraduate Sophomore

**Mentor: Michael A. Meador**

### **ABSTRACT**

The Polymers Branch of the Materials Division is dedicated to the development of high-performance for a variety of applications. Areas of significant interest include high-temperature polymers, low density, and high strength insulating materials, conductive polymers, and high density polymer electrolytes. This summer our group is working diligently on a photo-curing project. There is interest in the medical community feel the need for a new and improved balloon that will be used for angioplasty (a form of heart surgery). This product should maintain flexibility but add many other properties. Like possibly further processability and resistance to infection. Our group intends on coming up with this product by using photo-enolization (or simply, photo-curing) by Diels-Alder trapping.

The main objective was to synthesize a series of new polymers by Diels-Alder cycloaddition of photoenols with more elastomeric properties. Our group was responsible for performing the proper photo-curing techniques of the polymers with diacrylates and bismaleimides, synthesizing novel monomers, and evaluating experimental results. We attempted to use a diacrylate to synthesize the polymer because of previous research done within the Polymers Branch here at NASA. Most acrylates are commercially available, have more elastometric properties than a typical rigid aromatic structure has and they contain ethylene oxides in the middle of their structure that create extensive flexibility. The problem we encountered with the acrylates is that they photo chemically and thermally self polymerize and create diradicals at low temperatures; these constraints caused a lot of unnecessary side reactions. We want to promote solely, diketone polymerization because this type of polymerization has the ability to cause very elastic polymers. We chose to direct our attention towards the usage of maleimides because they are known for eliminating these unnecessary side reactions.

We tried to synthesize several different compounds in order to combine the two techniques and properties of both the acrylates and the maleimides. The Jeffamine 600 maleimide was unsuccessful because it was too large (containing approximately 13 repeating groups). We synthesized another maleimide but because of their low molecular weights, the product appeared to be a very gooey and non useful substance. We synthesized yet another maleimide using the same concept but a different amine, but we could not purify it. We tried several purification options including, column chromatography, flash columns and vacuum distillation. We tried a different bismaleimide and ran it through our UV light chamber, but in the end it turned out to be a very brittle product because of its rigid structure.

Currently, our primary goal is to synthesize a maleimide similar to the Jeffamine 600, using other amines that have shorter chains. Our hypothesis is that these shorter chains will contain both acrylate and maleimide characteristics. Our product will hopefully be very flexible, very elastic and experience no side reactions.

## Durability of Environmental Barrier Coatings in a Water Vapor/Oxygen Environment

**John E. Holchin**  
University of Dayton  
Mechanical Engineering  
Sophomore  
**Dennis S. Fox**

### ABSTRACT

Silicon carbide (SiC) and silicon nitride (Si<sub>3</sub>N<sub>4</sub>) show potential for application in the hot sections of advanced jet engines. The oxidation behavior of these materials has been studied in great detail. In a pure oxygen environment, a silica (SiO<sub>2</sub>) layer forms on the surface and provides protection from further oxidation. Initial oxidation is rapid, but slows as silica layer grows; this is known as parabolic oxidation. When exposed to model fuel-lean combustion applications (standard in jet engines), wherein the partial pressure of water vapor is approximately 0.5 atm., these materials exhibit different characteristics. In such an environment, the primary oxidant to form silica is water vapor. At the same time, water vapor reacts with the surface oxide to form gaseous silicon hydroxide (Si(OH)<sub>4</sub>). The simultaneous formation of both silica and Si(OH)<sub>4</sub> -the latter which is lost to the atmosphere- the material continues to recede. Recession rates for uncoated SiC and Si<sub>3</sub>N<sub>4</sub> are unacceptably high, for use in jet engines, - on the order of 1mm/4000h.

External coatings have been developed that protect Si-based materials from water vapor attack. One such coating consists of a Ba<sub>0.75</sub>Sr<sub>0.25</sub>Al<sub>2</sub>Si<sub>2</sub>O<sub>8</sub> (BSAS) topcoat, a mullite/BSAS intermediate layer and a Si bond coat. The key function of the topcoat is to protect the Si-base material from water vapor; therefore it must be fairly stable in water vapor (recession rate of about 1mm/40,000h) and remain crack free. Although BSAS is much more resistant to water vapor attack than pure silica, it exhibits a linear weight loss in 50% H<sub>2</sub>O - 50% O<sub>2</sub> at 1500°C.

The objective of my research is to determine the oxidation behavior of a number of alternate hot-pressed monolithic top coat candidates. Potential coatings were exposed at 1500°C to a 50% H<sub>2</sub>O - 50% O<sub>2</sub> gas mixture flowing at 4.4 cm/s. These included rare-earth silicates, barium-strontium aluminosilicates. When weight changes were measured with a continuously recording microbalance, linear weight loss was observed. BSAS materials have a fairly high volatility at this temperature, but rare-earth mono-silicate compounds were significantly more stable.

# Thin Film Solar Cells: Organic, Inorganic and Hybrid

**John Dankovich**

Case Western Reserve University

Chemistry / Political Science

Senior Undergraduate

**Mentor: Sheila Bailey**

## ABSTRACT

Thin film solar cells are an important developing resource for hundreds of applications including space travel. In addition to being more cost effective than traditional single crystal silicon cells, thin film multi-crystalline cells are plastic and light weight. The plasticity of the cells allows for whole solar "panels" to be rolled out from reams. Organic layers are being investigated in order to increase the efficiency of the cells to create an organic / inorganic hybrid cell.

The main focus of the group is a thin film inorganic cell made with the absorber  $\text{CuInS}_2$ . So far the group has been successful in creating the layer from a single-source precursor. They also use a unique method of film deposition called chemical vapor deposition for this. The general makeup of the cell is a molybdenum back contact with the  $\text{CuInS}_2$  layer, then CdS, ZnO and aluminum top contacts. While working cells have been produced, the efficiency so far has been low.

Along with quantum dot fabrication the side project of this that is currently being studied is adding a polymer layer to increase efficiency. The polymer that we are using is P3OT (Poly(3-octylthiophene-2,5-diyl), retroregular). Before (and if) it is added to the cell, it must be understood in itself. To do this simple diodes are being constructed to begin to look at its behavior. The P3OT is spin coated onto indium tin oxide and silver or aluminum contacts are added. This method is being studied in order to find the optimal thickness of the layer as well as other important considerations that may later affect the composition of the finished solar cell.

Because the sun is the most abundant renewable, energy source that we have, it is important to learn how to harness that energy and begin to move away from our other depleted non-renewable energy sources. While traditional silicon cells currently create electricity at relatively high efficiencies, they have drawbacks such as weight and rigidity that make them unattractive especially for space applications. Thin film photovoltaics have the potential to alleviate these problems and create a cheap and efficient way to harness the power of the sun.

## **Analysis of Electrical Characteristics of Thin Film Photovoltaic Cells**

**Michael P. Kasick**

Carnegie Mellon University  
Electrical & Computer Engineering

Undergraduate Sophomore

**Mentor: Aloysius F. Hepp**

### **ABSTRACT**

Solar energy is the most abundant form of energy in many terrestrial and extraterrestrial environments. Often in extraterrestrial environments sunlight is the only readily available form of energy. Thus the ability to efficiently harness solar energy is one of the ultimate goals in the design of space power systems. The essential component that converts solar energy into electrical energy in a solar energy based power system is the photovoltaic cell.

Traditionally, photovoltaic cells are based on a single crystal silicon absorber. While silicon is a well understood technology and yields high efficiency, there are inherent disadvantages to using single crystal materials. The requirements of weight, large planar surfaces, and high manufacturing costs make large silicon cells prohibitively expensive for use in certain applications. Because of silicon's disadvantages, there is considerable ongoing research into alternative photovoltaic technologies. In particular, thin film photovoltaic technologies exhibit a promising future in space power systems. While they are less mature than silicon, the better radiation hardness, reduced weight, ease of manufacturing, low material cost, and the ability to use virtually any exposed surface as a substrate makes thin film technologies very attractive for space applications.

The research group lead by Dr. Hepp has spent several years researching copper indium disulfide as an absorber material for use in thin film photovoltaic cells. While the group has succeeded in developing a single source precursor for  $\text{CuInS}_2$  as well as a unique method of aerosol assisted chemical vapor deposition, the resulting cells have not achieved adequate efficiencies. While efficiencies of 11% have been demonstrated with  $\text{CuInS}_2$  based cells, the cells produced by this group have shown efficiencies of approximately 1%. Thus, current research efforts are turning towards the analysis of the individual layers of these cells, as well as the junctions between them, to determine the cause of the poor yields.

As a student of electrical engineering with some material science background, my role in this research is to develop techniques for analyzing the electrical characteristics of the  $\text{CuInS}_2$  cells. My first task was to design a shadow mask to be used to place molybdenum contacts under a layer of  $\text{CuInS}_2$  in order to analyze the contact resistance between the materials. In addition, I have also analyzed evaporated aluminum top contacts and have tested various methods of increasing their thicknesses in order to decrease series resistance. More recently I have worked with other members of the research group in reviving a vertical cold-wall reactor for experimentation with  $\text{CuInS}_2$  quantum dots. As part of that project, I have improved the design for a variable frequency and pulse width square wave generator to be used in driving the precursor injection process. My task throughout the remainder of my tenure is to continue to analyze and develop tools for the analysis of electrical properties of the  $\text{CuInS}_2$  cells with the ultimate goal of discovering ways to improve the efficiency of our photovoltaic cells.

# DUST ACCUMULATION AND SOLAR PANEL ARRAY PERFORMANCE ON THE MARS EXPLORATION ROVER (MER) PROJECT

**EREN H. TURGAY**  
University of Kentucky  
Computer Science and Electrical Engineering  
Undergraduate, Senior  
**Mentor: Geoffrey A. Landis**

## ABSTRACT

One of the most fundamental design considerations for any space vehicle is its power supply system. Many options exist, including batteries, fuel cells, nuclear reactors, radioisotopic thermal generators (RTGs), and solar panel arrays. Solar arrays have many advantages over other types of power generation. They are lightweight and relatively inexpensive, allowing more mass and funding to be allocated for other important devices, such as scientific instruments. For Mars applications, solar power is an excellent option, especially for long missions. One might think that dust storms would be a problem; however, while dust blocks some solar energy, it also scatters it, making it diffuse rather than beamed. Solar cells are still able to capture this diffuse energy and convert it into substantial electrical power. For these reasons, solar power was chosen to be used on the 1997 Mars Pathfinder mission. The success of this mission set a precedent, as NASA engineers have selected solar power as the energy system of choice for all future Mars missions, including the Mars Exploration Rover (MER) Project.

Solar cells have their drawbacks, however. They are difficult to manufacture and are relatively fragile. In addition, solar cells are highly sensitive to different parts of the solar spectrum, and finding the correct balance is crucial to the success of space missions. Another drawback is that the power generated is not a constant with respect to time, but rather changes with the relative angle to the sun. On Mars, dust accumulation also becomes a factor. Over time, dust settles out of the atmosphere and onto solar panels. This dust blocks and shifts the frequency of the incoming light, degrading solar cell performance.

My goal is to analyze solar panel telemetry data from the two MERs (Spirit and Opportunity) in an effort to accurately model the effect of dust accumulation on solar panels. This is no easy process due to the large number of factors involved. Changing solar flux (the amount of solar energy reaching the planet), solar spectrum, solar angle, rover tilt, and optical depth (the opacity of the atmosphere due to dust) were the most significant. Microsoft Excel and Visual Basic are used for data analysis. The results of this work will be used to improve the dust accumulation and atmosphere effects model that was first created after the Mars Pathfinder mission.

This model will be utilized and applied when considering the design of solar panel array systems on future Mars projects. Based on this data, and depending upon the tenure and application of the mission, designers may also elect to employ special tools to abate dust accumulation, or decide that the expected level of accumulation is acceptable.

## **Evaporator Development for an Evaporative Heat Pipe System**

Leigh C. Peters  
Case Western Reserve University  
Mechanical Engineering  
Junior Undergraduate  
Mentor: Kenneth A. Burke

### **ABSTRACT**

As fossil fuel resources continue to deplete, research for alternate power sources continues to develop. One of these alternate technologies is fuel cells. They are a practical fuel source able to provide significant amounts of power for applications from laptops to automobiles and their only byproduct is water. However, although this technology is over a century old and NASA has been working with it since the early 1960's there is still room for improvement.

The research I am involved in at NASA's Glenn Research Center is focusing on what is called a regenerative fuel cell system. The unique characteristic of this type of system is that it used an outside power source to create electrolysis of the water it produces and it then reuses the hydrogen and oxygen to continue producing power. The advantage of this type of system is that, for example, on space missions it can use solar power to recharge its gas supplies between periods when the object being orbited blocks out the sun.

This particular system however is far from completion. This is because of the many components that are required to make up a fuel cell that need to be tested individually. The specific part of the system that is being worked on this summer of 2004 is the cooling system. The fuel cell stack, that is the part that actually creates the power, also produces a lot of heat. When not properly cooled, it has been known to cause fires which, needless to say are not conducive to the type of power that is trying to be created. In order to cool the fuel cell stack in this system we are developing a heat pipe cooling system.

One of the main components of a heat pipe cooling system is what is known as the evaporator, and that is what happens to be the part of the system we are developing this summer. In most heat pipe systems the evaporator is a tube in which the working fluid is cooled and then re-circulated through the system to absorb more heat energy from the fuel cell stack. For this system, instead of a tube, the evaporator is made up of a stack-up of screen material and absorbent membranes inside a stainless steel shell and held together by a film adhesive and epoxy.

There is an initial design for this flat plate evaporator, however it has not yet been made. The components of the stack-up are known, so all testing is focused on how it will all go together. This includes finding an appropriate epoxy to make the evaporator conductive all the way through and finding a way to hold the required tight tolerances as the stainless steel outer shell is put together. By doing the tests on smaller samples of the stack-ups and then testing the full size component, the final flat plate evaporator will reach its final design so that research can continue on other parts of the regenerative fuel cell system, and another step in the improvement of fuel cell technology can be made.

# AIRCRAFT FUEL CELL POWER SYSTEMS

**Robert Needham**

Case Western Reserve University

Electrical Engineering

Senior

**Mentor: Patricia Loyselle**

## ABSTRACT

In recent years, fuel cells have been explored for use in aircraft. While the weight and size of fuel cells allows only the smallest of aircraft to use fuel cells for their primary engines, fuel cells have showed promise for use as auxiliary power units (APUs), which power aircraft accessories and serve as an electrical backup in case of an engine failure. Fuel cell APUs are both more efficient and emit fewer pollutants.

However, sea-level fuel cells need modifications to be properly used in aircraft applications. At high altitudes, the ambient air has a much lower pressure than at sea level, which makes it much more difficult to get air into the fuel cell to react and produce electricity. Compressors can be used to pressurize the air, but this leads to added weight, volume, and power usage, all of which are undesirable things.

Another problem is that fuel cells require hydrogen to create electricity, and ever since the Hindenburg burst into flames, aircraft carrying large quantities of hydrogen have not been in high demand. However, jet fuel is a hydrocarbon, so it is possible to reform it into hydrogen. Since jet fuel is already used to power conventional APUs, it is very convenient to use this to generate the hydrogen for fuel-cell-based APUs.

Fuel cells also tend to get large and heavy when used for applications that require a large amount of power. Reducing the size and weight becomes especially beneficial when it comes to fuel cells for aircraft.

My goal this summer is to work on several aspects of Aircraft Fuel Cell Power System project. My first goal is to perform checks on a newly built injector rig designed to test different catalysts to determine the best setup for reforming Jet-A fuel into hydrogen. These checks include testing various thermocouples, transmitters, and transducers, as well making sure that the rig was actually built to the design specifications. These checks will help to ensure that the rig will operate properly and give correct results when it is finally ready for testing.

Another of my goals is to test new membranes for use in proton-exchange membrane fuel cells, in the hope that these membranes can increase the electricity that is produced by fuel cells. Producing more electricity means that fewer fuel cells are needed, thus reducing the weight and volume of an APU based on fuel cells, making such an APU much more viable.



# Research Symposium I Ohio Aerospace Institute Wednesday, July 7, 2004

## OAI Federal Room

9:00 A.M. **Kevin Robb, Penn State University, Senior**

“Improved Nuclear Reactor and Shield Mass Model for Space Applications”

5490/Michael Barrett, Thermo-Mechanical Systems Branch

9:15 **Melissa Papa, Penn State University, Senior**

“Main Power Distribution Unit for the Jupiter Icy Moons Orbiter (JIMO)”

5490/Charles Castle, Thermo-Mechanical Systems Branch

9:30 **Gina Blaze, Cleveland State University, Senior**

“Stirling Engine Controller”

5490/Mary Ellen Roth, Thermo-Mechanical Systems Branch

9:45 **Christopher Nakis, Grove City College, Junior**

“Stirling Engine Dynamic System Modeling”

5490/Jeff Schreiber, Thermo-Mechanical Systems Branch

10:00 **Erin Burns, Michigan Tech University, Senior**

“Research Performed Within the Non-Destructive Evaluation Team at NASA Glenn Research Center”

5520/Laura Cosgriff, Optical Instrumentation Technology Branch

10:15 **Thomas Brinson, Florida A&M University, Masters**

“Thermodynamic Modeling of a Solid Oxide Fuel Cell to Couple with an Existing Gas Turbine Engine Model”

5530/George Kopasakis, Controls and Dynamics Technology Branch

10:30 **Gregory Savich, University of Rochester, Junior**

“Fabrication of a Novel Gigabit/Second Free-Space Optical Interconnect – Photodetector Characterization and Testing and System Development”

5620/Rainee Simons, Electron Device Technology Branch

10:45 **Eric Radke, University of California-Los Angeles, Masters**

“Application of Simulated Annealing and Related Algorithms to TWTA Design”

5620/Karl Vaden, Electron Device Technology Branch

11:00 **LUNCH**

1:00 **Richard Su, University of Maryland-College Park, Masters**

“Design of Amphoteric Refraction Models Using Wavica and Rayica”

5620/Jeffrey Wilson, Electron Device Technology Branch

1:15 **Christopher Subich, University of Central Florida, Senior**

“Model of Atmospheric Links on Optical Communications from High Altitude”

5640/Felix Miranda, Applied RF Technology Branch

- 1:30 **Nathan Yassine, Cleveland State University, Senior**  
“Digital Communication Constraints in Prior Space Missions”  
5640/Robert Romanofsky, Applied RF Technology Branch
- 1:45 **Mark Trapp, Carnegie Mellon University, Senior**  
“Eccentric Loading of Microtensile Specimens”  
5920/Noel Nemeth, Life Prediction Branch
- 2:00 **Matthew Smith, Penn State University, Masters**  
“Consideration of Alternate Working Fluid Properties in Gas Lubricated Foil Journal Bearings”  
5930/Samuel Howard, Structural Mechanics and Dynamics Branch
- 2:15 **Matthew Ellis, Purdue University, Masters**  
“Effect of Detonation through a Turbine Stage”  
5940/Edmane Envia, Acoustics Branch
- 2:30 **La'nita Ward, Spelman College, Junior**  
“Investigation of the Environmental Durability of a Powder Metallurgy Material”  
5960/Malcolm Stanford, Tribology and Surface Science Branch
- 2:45 **Rachel Laster, Kentucky State University, Senior**  
“The Monitoring System for Vibratory Disturbance Detection in Microgravity Environment Aboard the International Space Station”  
6727/Kenol Jules, Microgravity Environment and Telescience Branch
- 3:00 **Theresa Guo, Massachusetts Institute of Technology, Freshman**  
“Visualizing Ultrasound Through Computational Modeling”  
6728/Jerry Myers, Fluid Flights Projects Branch
- 3:15 **ADJOURN**

## **Improved Nuclear Reactor and Shield Mass Model for Space Applications**

**Kevin Robb**

Penn State University

Mechanical and Nuclear Engineering

Undergraduate, Senior

**Mentor: Michael Barrett**

### **ABSTRACT**

New technologies are being developed to explore the distant reaches of the solar system. Beyond Mars, solar energy is inadequate to power advanced scientific instruments. One technology that can meet the energy requirements is the space nuclear reactor. The nuclear reactor is used as a heat source for which a heat-to-electricity conversion system is needed. Examples of such conversion systems are the Brayton, Rankine, and Stirling cycles.

Since launch cost is proportional to the amount of mass to lift, mass is always a concern in designing spacecraft. Estimations of system masses are an important part in determining the feasibility of a design.

I worked under Michael Barrett in the Thermal Energy Conversion Branch of the Power & Electric Propulsion Division. An in-house Closed Cycle Engine Program (CCEP) is used for the design and performance analysis of closed-Brayton-cycle energy conversion systems for space applications. This program also calculates the system mass including the heat source. CCEP uses the subroutine RSMASS, which has been updated to RSMASS-D, to estimate the mass of the reactor.

RSMASS was developed in 1986 at Sandia National Laboratories to quickly estimate the mass of multi-megawatt nuclear reactors for space applications. In response to an emphasis for lower power reactors, RSMASS-D was developed in 1997 and is based off of the SP-100 liquid metal cooled reactor. The subroutine calculates the mass of reactor components such as the safety systems, instrumentation and control, radiation shield, structure, reflector, and core. The major improvements in RSMASS-D are that it uses higher fidelity calculations, is easier to use, and automatically optimizes the systems mass. RSMASS-D is accurate within 15% of actual data while RSMASS is only accurate within 50%.

My goal this summer was to learn FORTRAN 77 programming language and update the CCEP program with the RSMASS-D model.

# **MAIN POWER DISTRIBUTION UNIT FOR THE JUPITER ICY MOONS ORBITER (JIMO)**

**Melissa R. Papa**  
Pennsylvania State University  
Aerospace Engineering  
Undergraduate, Senior  
**Mentor: Charles H. Castle**

## **ABSTRACT**

Around the year 2011, the Jupiter Icy Moons Orbiter (JIMO) will be launched and on its way to orbit three of Jupiter's planet-sized moons. The mission goals for the JIMO project revolve heavily around gathering scientific data concerning ingredients we, as humans, consider essential: water, energy and necessary chemical elements. The JIMO is an ambitious mission which will implore propulsion from an ION thruster powered by a nuclear fission reactor. Glenn Research Center is responsible for the development of the dynamic power conversion, power management and distribution, heat rejection and ION thrusters.

The first test phase for the JIMO program concerns the High Power AC Power Management and Distribution (PMAD) Test Bed. The goal of this testing is to support electrical performance verification of the power systems. The test bed will incorporate a 2kW Brayton Rotating Unit (BRU) to simulate the nuclear reactor as well as two ION thrusters. The first module of the PMAD Test Bed to be designed is the Main Power Distribution Unit (MPDU) which relays the power input to the various propulsion systems and scientific instruments.

The MPDU involves circuitry design as well as mechanical design to determine the placement of the components. The MPDU consists of fourteen relays of four different variations used to convert the input power into the appropriate power output. The three phase system uses 400 Volts<sub>L-L</sub> rms at 1000 Hertz. The power is relayed through the circuit and distributed to the scientific instruments, the ION thrusters and other controlled systems. The mechanical design requires the components to be positioned for easy electrical wiring as well as allowing adequate room for the main buss bars, individual circuit boards connected to each component and power supplies.

To accomplish creating a suitable design, AutoCAD was used as a drafting tool. By showing a visual layout of the components, it is easy to see where there is extra room or where the components may interfere with one another. By working with the electrical engineer who is designing the circuit, the specific design requirements for the MPDU were determined and used as guidelines. Space is limited due to the size of the mounting plate therefore each component must be strategically placed. Since the MPDU is being designed to fit into a simulated model of the spacecraft systems on the JIMO, components must be positioned where they are easily accessible to be wired to the other onboard systems. Mechanical and electrical requirements provided equally important limits which are combined to produce the best possible design of the MPDU.

## **Stirling Engine Controller**

**Gina M. Blaze**

Cleveland State University

Electrical Engineering

Undergraduate, Junior

**Mentor: Mary Ellen Roth**

Stirling technology is being developed to replace RTG's (Radioisotope Thermoelectric Generators), more specifically a stirling convertor, which is a stirling engine coupled to a linear alternator. Over the past three decades, the stirling engine has been designed to perform different functions. Stirling convertors have been designed to decrease fuel consumption in automobiles. They have also been designed for terrestrial and space applications. Currently NASA Glenn is using the convertor for space based applications.

A stirling convertor is a better means of power for deep space missions and "dusty" missions, like the Mars Rovers, than solar panels because it is not affected by dust. Spirit and Opportunity, two Mars rovers currently navigating the planet, are losing their ability to generate electricity because dust is collecting on their solar panels. Opportunity is losing more energy because its robotic arm has a heater with a switch that can not be turned off. The heater is not needed at night, but yet still runs. This generates a greater loss of electricity and in turn diminishes the performance of the rover. The stirling cycle has the potential to provide very efficient conversion of heat energy to electric al energy, more so than RTG's. The stirling engine converts the thermal energy produced by the decaying radioisotope to mechanical energy; the linear alternator converts this into electricity.

Since the early 1990's, tests have been performed to maximize the efficiency of the stirling convertor. Many months, even years, are dedicated to preparing and performing tests. Currently, two stirling convertors #'s 13 and 14, which were developed by Stirling Technology Company, are on an extended operation test. As of June 7th, the two convertors reached 7,500 hours each of operation. Before the convertors could run unattended, many safety precautions had to be examined. So, special instrumentation and circuits were developed to detect off nominal conditions and also safely shutdown the engines. The test will last for a period of 8000 to 9000 hours. Other types of tests that have been performed are: performance mapping, controller development, launch environment, and vibration emissions testing.

Currently, the thermo-mechanical systems branch is housing a RG-350, a stirling convertor. The convertor was used in previous tests such as a Hall Thruster test, world's first integrated test of a dynamic power system with electric propulsion. Another test performed was to conclude if free piston stirling convertors can be synchronized for vibration balancing, with no thermodynamic or electrical connections and not cause both to shutdown if one failed. The ability to reduce vibration by synchronizing convertor operation but still be able to operate when one partner fails is pertinent in space and terrestrial applications. The convertor is now being brought back into operation and a controller is in the process of being developed. This convertor will be used as a testbed for new controllers.

I worked with Mary Ellen Roth on the electrical engineering aspects of the RG-350. My main goal was to enhance the data collection process. I worked on different aspects of the RG-350, with a main focus on the engine controller. I drew a schematic of the wire connections in the engine controller, using PCB Express, so that a plan could be devised to connect the power meter properly between the output of the engine and the engine controller. I measured the power using two different instruments: Valhalla Scientific power meter and Ohio Semitronics power measurement device. The convertor is connected to an Agilent 34970A Data Acquisition/Switch Unit, which allows the user to measure, record, and monitor voltage, current, frequency, and temperature. I assisted in preparing the Data Acquisition for general operation. I also helped test a panel of transducers, which will be placed in the rack that powers and monitors the convertor.

## Stirling Engine Dynamic System Modeling

Christopher G. Nakis  
Grove City College  
Mechanical Engineering  
Junior  
Mentor: Jeff Schreiber

### ABSTRACT

The Thermo-Mechanical systems branch at the Glenn Research Center focuses a large amount time on Stirling engines. These engines will be used on missions where solar power is inefficient, especially in deep space. I work with Tim Regan and Ed Lewandowski who are currently developing and validating a mathematical model for the Stirling engines. This model incorporates all aspects of the system including, mechanical, electrical and thermodynamic components. Modeling is done through Simplorer, a program capable of running simulations of the model. Once created and then proven to be accurate, a model is used for developing new ideas for engine design.

My largest specific project involves varying key parameters in the model and quantifying the results. This can all be done relatively trouble-free with the help of Simplorer. Once the model is complete, Simplorer will do all the necessary calculations. The more complicated part of this project is determining which parameters to vary. Finding key parameters depends on the potential for a value to be independently altered in the design. For example, a change in one dimension may lead to a proportional change to the rest of the model, and no real progress is made. Also, the ability for a changed value to have a substantial impact on the outputs of the system is important. Results will be condensed into graphs and tables with the purpose of better communication and understanding of the data.

With the changing of these parameters, a more optimal design can be created without having to purchase or build any models. Also, hours and hours of results can be simulated in minutes. In the long run, using mathematical models can save time and money. Along with this project, I have many other smaller assignments throughout the summer. My main goal is to assist in the processes of model development, validation and testing.

## RESEARCH PERFORMED WITHIN THE NON-DESTRUCTIVE EVALUATION TEAM AT NASA GLENN RESEARCH CENTER

**Erin A. Burns**

Michigan Technological University

Mechanical Engineering

Masters, Candidate

**Mentors: Dr. Don Roth and Laura Cosgriff**

### ABSTRACT

Non-destructive testing is essential in many fields of manufacturing and research in order to perform reliable examination of potentially damaged materials and parts without destroying the inherent structure of the materials. Thus, the Non-Destructive Evaluation (NDE) Team at NASA Glenn Research Center partakes in various projects to improve materials testing equipment as well as analyze materials, material defects, and material deficiencies.

Due to the array of projects within the NDE Team at this time, five research aims were supplemental to some current projects.

A literature survey of NDE and testing methodologies as related to rocks was performed. Also, Mars Expedition Rover technology was assessed to understand the requirements for instrumentation in harsh space environments (e.g. temperature). Potential instrumentation and technologies were also considered and documented. The literature survey provided background and potential sources for a proposal to acquire funding for ultrasonic instrumentation on board a future Mars expedition.

The laboratory uses a Santec Systems AcousticScope AS200 acoustography system. Labview code was written within the current program in order to improve the current performance of the acoustography system.

A sample of Reinforced Carbon/Carbon (RCC) material from the leading edge of the space shuttle underwent various non-destructive tests (guided wave scanning, thermography, computed tomography, real time x-ray, etc.) in order to characterize its structure and examine possible defects.

Guided wave scan data of a ceramic matrix composite (CMC) panel was reanalyzed utilizing image correlations and signal processing variables. Additional guided wave scans and thermography were also performed on the CMC panel. These reevaluated data and images will be used in future presentations and publications.

An additional axis for the guided wave scanner was designed, constructed, and implemented. This additional axis allowed incremental spacing of the previously fixed transducers for ultrasonic velocity measurements.

# **THERMODYNAMIC MODELING OF A SOLID OXIDE FUEL CELL TO COUPLE WITH AN EXISTING GAS TURBINE ENGINE MODEL**

**Thomas E. Brinson**

Florida Agricultural and Mechanical University

Mechanical Engineering

Graduate, 2<sup>nd</sup> year Master's

**Mentor: George Kopasakis**

## **ABSTRACT**

The Controls and Dynamics Technology Branch at NASA Glenn Research Center are interested in combining a solid oxide fuel cell (SOFC) to operate in conjunction with a gas turbine engine. A detailed engine model currently exists in the Matlab/Simulink environment. The idea is to incorporate a SOFC model within the turbine engine simulation and observe the hybrid system's performance. The fuel cell will be heated to its appropriate operating condition by the engine's combustor. Once the fuel cell is operating at its steady-state temperature, the gas burner will back down slowly until the engine is fully operating on the hot gases exhausted from the SOFC. The SOFC code is based on a steady-state model developed by The U.S. Department of Energy (DOE). In its current form, the DOE SOFC model exists in Microsoft Excel and uses Visual Basics to create an I-V (current-voltage) profile. For the project's application, the main issue with this model is that the gas path flow and fuel flow temperatures are used as input parameters instead of outputs. The objective is to create a SOFC model based on the DOE model that inputs the fuel cells flow rates and outputs temperature of the flow streams; therefore, creating a temperature profile as a function of fuel flow rate. This will be done by applying the First Law of Thermodynamics for a flow system to the fuel cell. Validation of this model will be done in two procedures. First, for a given flow rate the exit stream temperature will be calculated and compared to DOE SOFC temperature as a point comparison. Next, an I-V curve and temperature curve will be generated where the I-V curve will be compared with the DOE SOFC I-V curve. Matching I-V curves will suggest validation of the temperature curve because voltage is a function of temperature. Once the temperature profile is created and validated, the model will then be placed into the turbine engine simulation for system analysis.



# **FABRICATION OF A NOVEL GIGABIT/SECOND FREE-SPACE OPTICAL INTERCONNECT - PHOTODETECTOR CHARACTERIZATION AND TESTING AND SYSTEM DEVELOPMENT**

**Gregory R. Savich**  
University of Rochester  
Optics/Optical Engineering  
Undergraduate - Third Year  
**Mentor: Rainee N. Simons**

## **ABSTRACT**

The time when computing power is limited by the copper wire inherent in the computer system and not the speed of the microprocessor is rapidly approaching. With constant advances in computer technology, many researchers believe that in only a few years, optical interconnects will begin to replace copper wires in your Central Processing Unit (CPU). On a more macroscopic scale, the telecommunications industry has already made the switch to optical data transmission as, to date, fiber optic technology is the only reasonable method of reliable, long range data transmission. Within the span of a decade, we will see optical technologies move from the macroscopic world of the telecommunications industry to the microscopic world of the computer chip. Already, the communications industry is marketing commercially available optical links to connect two personal computers, thereby eliminating the need for standard and comparatively slow wired and wireless Ethernet transfers and greatly increasing the distance the computers can be separated. As processing demands continue to increase, the realm of optical communications will continue to move closer to the microprocessor and quite possibly onto the microprocessor itself. A day may come when copper connections are used only to supply power, not transfer data.

This summer's work marks some of the beginning stages of a 5 to 10 year, long-term research project to create and study a free-space, 1 Gigabit/sec optical interconnect. The research will result in a novel fabricated, chip-to-chip interconnect consisting of a Vertical Cavity Surface Emitting Laser (VCSEL) Diode linked through free space to a Metal-Semiconductor-Metal (MSM) Photodetector with the possible integration of microlenses for signal focusing and Micro-Electromechanical Systems (MEMS) devices for optical signal steering. The advantages, disadvantages, and practicality of incorporating flip-chip mounting technologies will also be addressed.

My work began with the design and construction of a test setup for the experiment and then appropriate characterization of the test system. Specifically, I am involved in the characterization of a commercially available 1550nm wavelength, 5mW diode laser and a study of its modulation bandwidth. Commercially produced photodetectors as well as the incorporation of microwave technology, in the form of RF input and output, are used in the characterization procedure. The next stage involves the use of a probe station and network analyzer to characterize and test a series of photodetectors fabricated on a 2 inch, Indium Gallium Arsenide (InGaAs) wafer in the Branch's microlithography lab. Other project responsibilities include, but are not limited to the incorporation of a transimpedance amplifier to the photodetector circuit; a study of VCSEL technology; bit error rate analysis of an optical interconnect system; and analysis of free space divergence of the VCSEL, optical path length of the interconnect; and any other pertinent optical properties of the one gigabit per second interconnect for fabrication and testing.

# Application of Simulated Annealing and Related Algorithms to TWTA Design

**Eric M. Radke**

University of California, Los Angeles

Mathematics

Graduate

**Mentor: Karl R. Vaden**

Simulated Annealing (SA) is a stochastic optimization algorithm used to search for global minima in complex design surfaces where exhaustive searches are not computationally feasible. The algorithm is derived by simulating the annealing process, whereby a solid is heated to a liquid state and then cooled slowly to reach thermodynamic equilibrium at each temperature. The idea is that atoms in the solid continually bond and re-bond at various quantum energy levels, and with sufficient cooling time they will rearrange at the minimum energy state to form a perfect crystal. The distribution of energy levels is given by the Boltzmann distribution: as temperature drops, the probability of the presence of high-energy bonds decreases.

In searching for an optimal design, local minima and discontinuities are often present in a design surface. SA presents a distinct advantage over other optimization algorithms in its ability to escape from these local minima. Just as high-energy atomic configurations are visited in the actual annealing process in order to eventually reach the minimum energy state, in SA highly non-optimal configurations are visited in order to find otherwise inaccessible global minima.

The SA algorithm produces a Markov chain of points in the design space at each temperature, with a monotonically decreasing temperature. A random point is started upon, and the objective function is evaluated at that point. A stochastic perturbation is then made to the parameters of the point to arrive at a proposed new point in the design space, at which the objection function is evaluated as well. If the change in objective function values  $\Delta E$  is negative, the proposed new point is accepted. If  $\Delta E$  is positive, the proposed new point is accepted according to the Metropolis criterion:  $p(\Delta f) = \exp(-\Delta E/T)$ , where  $T$  is the temperature for the current Markov chain. The process then repeats for the remainder of the Markov chain, after which the temperature is decremented and the process repeats. Eventually (and hopefully), a near-globally optimal solution is attained as  $T$  approaches zero.

Several exciting variants of SA have recently emerged, including Discrete-State Simulated Annealing (DSSA) and Simulated Tempering (ST). The DSSA algorithm takes the thermodynamic analogy one step further by categorizing objective function evaluations into discrete states. In doing so, many of the case-specific problems associated with fine-tuning the SA algorithm can be avoided; for example, theoretical approximations for the initial and final temperature can be derived independently of the case. In this manner, DSSA provides a scheme that is more robust with respect to widely differing design surfaces. ST differs from SA in that the temperature  $T$  becomes an additional random variable in the optimization. The system is also kept in equilibrium as the temperature changes, as opposed to the system being driven out of equilibrium as temperature changes in SA. ST is designed to overcome obstacles in design surfaces where numerous local minima are separated by high barriers.

These algorithms are incorporated into the optimal design of the traveling-wave tube amplifier (TWTA). The area under scrutiny is the collector, in which it would be ideal to use negative potential to decelerate the spent electron beam to zero kinetic energy just as it reaches the collector surface. In reality this is not plausible due to a number of physical limitations, including repulsion and differing levels of kinetic energy among individual electrons. Instead, the collector is designed with multiple stages depressed below ground potential. The design of this multiple-stage collector is the optimization problem of interest.

One remaining problem in SA and DSSA is the difficulty in determining when equilibrium has been reached so that the current Markov chain can be terminated. It has been suggested in recent literature that simulating the thermodynamic properties of specific heat, entropy, and internal energy from the Boltzmann distribution can provide good indicators of having reached equilibrium at a certain temperature. These properties are tested for their efficacy and implemented in SA and DSSA code with respect to TWTA collector optimization.

# **DESIGN OF AMPHOTERIC REFRACTION MODELS USING WAVICA AND RAYICA**

**Richard Su**

University of California, Berkeley

Electrical Engineering

Graduate

**Mentor: Jeffrey Wilson**

## **Abstract**

The phenomenon of refraction of light is due to refractive index mismatches in two different media. However, to achieve this effect, a finite reflection loss is inevitable. A recent finding presented a unique type of interface, ferroelastic materials, that enables refraction without any reflection for either an electron or a light beam. This property is called total refraction.

The same type of interface that yields total refraction can also yield amphoteric refraction, where the index of refraction can be either positive or negative depending on the incident angle. This interface could potentially be used to steer light without reflections which could have major applications in high power optics.

My goal this summer is to first familiarize myself with the Mathematica software, especially the Wavica and Rayica packages. I will then model the amphoteric refraction by either modifying the Wavica and Rayica packages or using the built-in functions in these packages.

# **MODEL OF ATMOSPHERIC LINKS ON OPTICAL COMMUNICATIONS FROM HIGH ALTITUDE**

**Christopher Subich**

University of Central Florida  
Mathematics & Computer Science  
Undergraduate, Senior

**Mentors: Grigory Adamovsky (RIO, 5520) and Félix Miranda (RCA, 5640)**

## **ABSTRACT**

Optical communication links have the potential to solve many of the problems of current radio and microwave links to satellites and high-altitude aircraft. The higher frequency involved in optical systems allows for significantly greater signal bandwidth, and thus information transfer rate, in excess of 10 Gbps, and the highly directional nature of laser-based signals eliminates the need for frequency-division multiplexing seen in radio and microwave links today.

The atmosphere, however, distorts an optical signal differently than a microwave signal. While the ionosphere is one of the most significant sources of noise and distortion in a microwave or radio signal, the lower atmosphere affects an optical signal more significantly. Refractive index fluctuations, primarily caused by changes in atmospheric temperature and density, distort the incoming signal in both deterministic and nondeterministic ways. Additionally, suspended particles, such as those in haze or rain, further corrupt the transmitted signal.

To model many of the atmospheric effects on the propagating beam, we use simulations based on the beam-propagation method. This method, developed both for simulation of signals in waveguides and propagation in atmospheric turbulence, separates the propagation into a diffraction and refraction problem. The diffraction step is an exact solution, within the limits of numerical precision, to the problem of propagation in free space, and the refraction step models the refractive index variances over a segment of the propagation path. By applying refraction for a segment of the propagation path, then diffracting over that same segment, this method forms a good approximation to true propagation through the atmospheric medium. Iterating over small segments of the total propagation path gives a good approximation to the problem of propagation over the entire path.

Parameters in this model, such as initial beam profile and atmospheric constants, are easily modified in a simulation such as this, which allows for the rapid analysis of different propagation scenarios. Therefore, this method allows the development of a near-optimal system design for a wide range of situations, typical of what would be seen in different atmospheric conditions over a receiving ground station.

A simulation framework based upon this model was developed in FORTRAN, and for moderate grid sizes and propagation distances these simulations are computable in reasonable time on a standard workstation. This presentation will discuss results thus far.

## **ACKNOWLEDGEMENTS**

Insight and input from Dr. Robert Manning of the Antenna, Microwave, and Optical Systems Branch (RCA, 5640) are deeply appreciated.

# DIGITAL COMMUNICATION CONSTRAINTS IN PRIOR SPACE MISSIONS

**Nathan K. Yassine**  
Cleveland State University  
Electrical Engineering  
Post-graduate  
**Mentor: Robert R. Romanofsky**

## ABSTRACT

Digital communication is crucial for space endeavors. It transmits scientific and command data between earth stations and the spacecraft crew. It facilitates communications between astronauts, and provides live coverage during all phases of the mission. Digital communications provide ground stations and spacecraft crew precise data on the spacecraft position throughout the entire mission.

Lessons learned from prior space missions are valuable for our new lunar and Mars missions set by our president's speech. These data will save our agency time and money, and set course our current developing technologies. Limitations on digital communications equipment pertaining mass, volume, data rate, frequency, antenna type and size, modulation, format, and power in the passed space missions are of particular interest. This activity is in support of ongoing communication architectural studies pertaining to robotic and human lunar exploration. The design capabilities and functionalities will depend on the space and power allocated for digital communication equipment. My contribution will be gathering these data, write a report, and present it to Communications Technology Division Staff.

Antenna design is very carefully studied for each mission scenario. Currently, Phased array antennas are being developed for the lunar mission. Phased array antennas use little power, and electronically steer a beam instead of DC motors. There are 615 patches in the phased array antenna. These patches have to be modified to have high yield. 50 patches were created for testing. My part is to assist in the characterization of these patch antennas, and determine whether or not certain modifications to quartz micro-strip patch radiators result in a significant yield to warrant proceeding with repairs to the prototype 19 GHz ferroelectric reflect-array antenna. This work requires learning how to calibrate an automatic network, and mounting and testing antennas in coaxial fixtures. The purpose of this activity is to assist in the set-up of phase noise instrumentation, assist in the process of automated wire bonding, assist in the design and optimization of tunable microwave components, especially phase shifters, based on thin ferroelectric films, and learn how to use commercial electromagnetic simulation software.

## **ECCENTRIC LOADING OF MICROTENSILE SPECIMENS**

**Mark A. Trapp**  
Carnegie Mellon University  
Mechanical Engineering  
Mentor: Noel Nemeth

### **ABSTRACT**

Ceramic materials have a lower density than most metals and are capable of performing at extremely high temperatures. The utility of these materials is obvious; however, the fracture strength of brittle materials is not easily predicted and often varies greatly. Characteristically, brittle materials lack ductility and do not yield as other materials. Ceramics materials are naturally populated with microscopic cracks due to fabrication techniques. Upon application of a load, stress concentration occurs at the root of these cracks and fracture will eventually occur at some not easily predicted strength. In order to use ceramics in any application some design methodology must exist from which a component can be placed into service.

This design methodology is CARES/LIFE (Ceramics Analysis and Reliability Evaluation of Structures) which has been developed and refined at NASA over the last several decades. The CARES/LIFE computer program predicts the probability of failure of a ceramic component over its service life. CARES combines finite element results from a commercial FE (finite element) package such as ANSYS and experimental results to compute the abovementioned probability of failure. Over the course of several tests CARES has had great success in predicting the life of various ceramic components and has been used throughout industry. The latest challenge is to verify that CARES is valid for MEMS (Micro-Electro Mechanical Systems). To investigate a series of microtensile specimens were fractured in the laboratory. From this data, material parameters were determined and used to predict a distribution of strength for other specimens that exhibit a known stress concentration. If the prediction matches the experimental results then these parameters can be applied to a desired component outside of the laboratory.

During testing nearly half of the tensile specimens fractured at a location that was not expected and hence not captured in the FE model. It has been my duty to investigate the nature of this phenomenon in hopes of finding a better correlation between theory and empirical results. To investigate I built complete FE models of all of the tensile specimens using ANSYS. It is suspected that some misalignment naturally occurs during testing and thus additional bending stresses are present in the specimens. I modeled this eccentric loading and ran several FE trials using ANSYS/PDS (a probabilistic design system in ANSYS).

My objective this summer has been to familiarize myself with the CARES/LIFE program in hopes of using it in conjunction with ANSYS to help verify that CARES is applicable to MEMS-scale (greater than 1 micron, less than 1 millimeter) components.

# CONSIDERATION OF ALTERNATE WORKING FLUID PROPERTIES IN GAS LUBRICATED FOIL JOURNAL BEARINGS

**Matthew J. Smith**  
Penn State University  
Mechanical Engineering  
Graduate, Masters  
**Mentor: Dr. Adam Howard**

## ABSTRACT

The Oil-Free Turbomachinery Program at the NASA Glenn Research center is committed to, revolutionary improvements in performance, efficiency and reliability of turbomachinery propulsion systems. One of the key breakthroughs by which this goal is being achieved is the maturation of air lubricated foil bearing technology. Through experimental testing, foil bearings have demonstrated a variety of exceptional qualities that show them to have an important role in the future of rotordynamic lubrication. Most of the work done with foil bearings thus far has considered ambient air at atmospheric pressure as the working fluid or lubricating fluid in the bearing. However, special applications of oil-free technology require the use of air at non-standard ambient conditions or completely different working fluids altogether.

The NASA Jupiter Icy Moon Orbiter program presents power generation needs far beyond that of any previous space exploration effort. The proposed spacecraft will require significant power generation to provide the propulsion necessary to reach the moons of Jupiter and navigate between them. Once there, extensive scientific research will be conducted that will also present significant power requirements. Such extreme needs require exploring a new method for power generation in space. A proposed solution involves a Brayton cycle nuclear fission reactor. The nature of this application requires reliable performance of all reactor components for many years of operation under demanding conditions. This includes the bearings which will be operating with an alternative working fluid that is a combination of Helium and Xenon gases commonly known as HeXe. This fluid has transport and thermal properties that vary significantly from that of air and the effect of these property differences on bearing performance must be considered.

One of the most promising applications of oil-free technology is in aircraft turbine engines. Eliminating the oil supply systems from aircraft engines will lead to significant weight and maintenance reduction. In such applications, the lubricating fluid will be high altitude air. This air will be at much lower pressure than that at sea level. Again this property change will result in a change in bearing performance, and analysis is required to quantify this effect.

The study of these alternate working fluid properties will be conducted in two ways: analytically and experimentally. Analytical research will include the use of a mathematical code that can predict film thickness profiles for various ambient conditions. Estimations of load capacity can be made based upon the film thickness trends. These values will then be compared to those obtained from classical rigid bearing analysis. Experimental Research will include testing a foil bearing at a variety of ambient air pressures. The analytical and experimental data will be compared to draw conclusions on bearing performance under alternate working fluid properties.

# Effect of Detonation through a Turbine Stage

Matthew T. Ellis  
Purdue University  
Aerospace Engineering  
Graduate Student  
Mentor: Dr. Dale E. Van Zante

## ABSTRACT

Pulse detonation engines (PDE) have been investigated as a more efficient means of propulsion due to its constant volume combustion rather than the more often used constant pressure combustion of other propulsion systems. It has been proposed that a hybrid PDE-gas turbine engine would be a feasible means of improving the efficiency of the typical constant pressure combustion gas turbine cycle. In this proposed system, multiple pulse detonation tubes would replace the conventional combustor. Also, some of the compressor stages may be removed due to the pressure rise gained across the detonation wave.

The benefits of higher thermal efficiency and reduced compressor size may come at a cost. The first question that arises is the unsteadiness in the flow created by the pulse detonation tubes. A constant pressure combustor has the advantage of supplying a steady and large mass flow rate. The use of the pulse detonation tubes will create an unsteady mass flow which will have currently unknown effects on the turbine located downstream of the combustor. Using multiple pulse detonation tubes will hopefully improve the unsteadiness. The interaction between the turbine and the shock waves exiting the tubes will also have an unknown effect. Noise levels are also a concern with this hybrid system.

These unknown effects are being investigated using TURBO, an unsteady turbomachinery flow simulation code developed at Mississippi State University. A baseline case corresponding to a system using a constant pressure combustor with the same mass flow rate achieved with the pulse detonation hybrid system will be investigated first.



## **Investigation of the Environmental Durability of a Powder Metallurgy Material**

**La'Nita D. Ward**  
Spelman College  
Chemistry/Mathematics  
Undergraduate, Junior  
**Mentor: Dr. Malcolm K. Stanford**

### **ABSTRACT**

PM304 is a NASA-developed composite powder metallurgy material that is being developed for high temperature applications such as bushings in high temperature industrial furnace conveyor systems. My goal this summer was to analyze and evaluate the effects that heat exposure had on the PM304 material at 500°C and 650°C. The material is composed of Ni-Cr, Ag, Cr<sub>2</sub>O<sub>3</sub>, and eutectic BaF<sub>2</sub>-CaF<sub>2</sub>. PM304 is designed to eliminate the need for oil based lubricants in high temperature applications, while reducing friction and wear. However, further investigation was needed to thoroughly examine the properties of PM304.

The effects of heat exposure on PM304 bushings were investigated. This investigation was necessary due to the high temperatures that the material would be exposed to in a typical application. Each bushing was cut into eight sections. The specimens were heated to 500°C or 650°C for time intervals from 1 hr to 5,000 hrs. Control specimens were kept at room temperature.

Weight and thickness measurements were taken before and after the bushing sections were exposed to heat. Then the heat treated specimens were mounted and polished side by side with the control specimens. This enabled optical examination of the material's microstructure using a metallograph. The specimens were also examined with a scanning electron microscope (SEM). The microstructures were compared to observe the effects of the heat exposure.

Chemical analysis was done to investigate the interactions between Ni-Cr and BaF<sub>2</sub>-CaF<sub>2</sub> and between Cr<sub>2</sub>O<sub>3</sub> and BaF<sub>2</sub>-CaF<sub>2</sub> at high temperature. To observe this, the two compounds that were being analyzed were mixed in a crucible in varied weight percentages and heated to 1100°C in a furnace for approximately two hours. Then the product was allowed to cool and was then analyzed by X-ray diffraction. Interpretation of the results is in progress.

**THE MONITORING SYSTEM FOR VIBRATORY DISTURBANCE DETECTION  
IN MICROGRAVITY ENVIRONMENT  
ABOARD THE INTERNATIONAL SPACE STATION**

**Rachel M. Laster**  
Kentucky State University  
Computer Science/ Liberal Studies  
Undergraduate Level, Senior  
**Mentor: Kenol Jules**

**ABSTRACT**

Scientists in the Office of Life and Microgravity Sciences and Applications within the Microgravity Research Division oversee studies in important physical, chemical, and biological processes in microgravity environment. Research is conducted in microgravity environment because of the beneficial results that come about for experiments. When research is done in normal gravity, scientists are limited to results that are affected by the gravity of Earth. Microgravity provides an environment where solid, liquid, and gas can be observed in a natural state of free fall and where many different variables are eliminated.

One challenge that NASA faces is that space flight opportunities need to be used effectively and efficiently in order to ensure that some of the most scientifically promising research is conducted. Different vibratory sources are continually active aboard the International Space Station (ISS). Some of the vibratory sources include crew exercise, experiment setup, machinery startup (life support fans, pumps, freezer/compressor, centrifuge), thruster firings, and some unknown events. The Space Acceleration Measurement System (SAMS), which acts as the hardware and carefully positioned aboard the ISS, along with the Microgravity Environment Monitoring System (MEMS), which acts as the software and is located here at NASA Glenn, are used to detect these vibratory sources aboard the ISS and recognize them as disturbances. The various vibratory disturbances can sometimes be harmful to the scientists' different research projects. Some vibratory disturbances are recognized by the MEMS's database and some are not. Mainly, the unknown events that occur aboard the International Space Station are the ones of major concern.

To better aid in the research experiments, the unknown events are identified and verified as unknown events. Features, such as frequency, acceleration level, time and date of recognition of the new patterns are stored in an Excel database. My task is to carefully synthesize frequency and acceleration patterns of unknown events within the Excel database into a new file to determine whether or not certain information that is received is considered a real vibratory source. Once considered as a vibratory source, further analysis is carried out. The resulting information is used to retrain the MEMS to recognize them as known patterns.

These different vibratory disturbances are being constantly monitored to observe if, in any way, the disturbances have an effect on the microgravity environment that research experiments are exposed to. If the disturbance has little or no effect on the experiments, then research is continued. However, if the disturbance is harmful to the experiment, scientists act accordingly by either minimizing the source or terminating the research and neither NASA's time nor money is wasted.

# VISUALIZING ULTRASOUND THROUGH COMPUTATIONAL MODELING

**Theresa W. Guo**

Massachusetts Institute of Technology

Mechanical Engineering

Undergraduate, Sophomore

**Mentor: Jerry G. Myers**

## ABSTRACT

The Doppler Ultrasound Hematocrit Project (DHP) hopes to find non-invasive methods of determining a person's blood characteristics. Because of the limits of microgravity and the space travel environment, it is important to find non-invasive methods of evaluating the health of persons in space. Presently, there is no well developed method of determining blood composition non-invasively. This projects hopes to use ultrasound and Doppler signals to evaluate the characteristic of hematocrit, the percentage by volume of red blood cells within whole blood. These non-invasive techniques may also be developed to be used on earth for trauma patients where invasive measure might be detrimental.

Computational modeling is a useful tool for collecting preliminary information and predictions for the laboratory research. We hope to find and develop a computer program that will be able to simulate the ultrasound signals the project will work with. Simulated models of test conditions will more easily show what might be expected from laboratory results thus help the research group make informed decisions before and during experimentation.

There are several existing Matlab based computer programs available, designed to interpret and simulate ultrasound signals. These programs will be evaluated to find which is best suited for the project needs. The criteria of evaluation that will be used are 1) the program must be able to specify transducer properties and specify transmitting and receiving signals, 2) the program must be able to simulate ultrasound signals through different attenuating mediums, 3) the program must be able to process moving targets in order to simulate the Doppler effects that are associated with blood flow, 4) the program should be user friendly and adaptable to various models. After a computer program is chosen, two simulation models will be constructed. These models will simulate and interpret an RF data signal and a Doppler signal.

**Research Symposium I  
Ohio Aerospace Institute  
Wednesday, July 7, 2004**

**OAI Industry Room**

9:00 A.M. **Daniel Thompson, Ohio Wesleyan University, Sophomore**

“Computing and Combustion”

5800/Dhanireddy Reddy, Turbomachinery and Propulsion Systems Division

9:15 **William Jordan, University of Kentucky, Senior**

“Certification of CFD Heat Transfer Software for Turbine Blade Analysis”

5820/Ali Ameri, Turbine Branch

9:30 **Michelle Moreno, University of Texas-Pan Am, Junior**

“Calibration, Data Acquisition, and Post Analysis of Turbulent Fluid Flow in a Calibration Jet Using Hot-Wire Anemometry”

5820/Robert Boyle, Turbine Branch

9:45 **Walter Kiefer, University of Akron, Senior**

“Validation of CFD/Heat Transfer Software for Turbine Blade Analysis”

5820/James Heidmann, Turbine Branch

10:00 **Eric Bishop, Ohio State University, PhD**

“Combustion Branch Website Development”

5830/Chi-Ming Lee, Combustion Branch

10:15 **Edward Summers, Massachusetts Institute of Technology, Freshman**

“Development of Message Passing Routines for High Performance Parallel Computations”

5830/Jinho Lee, Combustion Branch

10:30 **Brian Parma, Arizona State University, Senior**

“Numerical Modeling and Testing of an Inductively-Driven and High-Energy Pulsed Plasma Thrusters”

5430/Hani Kamhawi, On-Board Propulsion Branch

10:45 **Scott Trapp, University of Toledo, Senior**

“Jupiter Icy Moons Orbiter (JIMO) Electrical Systems Testbed”

5450/Ramon Lebron-Velilla, Electrical Systems Development Branch

11:00 **LUNCH**

1:00 **Rayna Rogers, University of Dayton, Junior**

“Computer Graphic Design using Auto-CAD and Plug Nozzle Research”

5860/Albert Johns, Nozzle Branch

1:15 **Jennifer Suder, University of Akron, Junior**

“Reformer Fuel Injector”

5870/Thomas Tomsik, Propellant Systems Technology Branch

**1:30 Ryan Foster, University of Michigan, Sophomore**

“Simplifying CEA through Excel, VBA, and Subeq”

5880/Russell Claus, Engine Systems Technology Branch

**1:45 Sampa Kundu, Cleveland State University, Senior**

“The Fluids and Combustion Facility”

6701/Janice Gassaway, Business Management Office

**2:00 Shauna Mintz, University of Akron, Junior**

“Safety Aboard the International Space Station”

6711/Michael Hicks, Microgravity Combustion Science Branch

**2:15 James King, Fayetteville State University, Junior**

“Soot Nanostructure: Using Fringe Analysis Software on High Resolution Transmission Electron Microscopy of Carbon Soot”

6711/Randall Vanderwal, Microgravity Combustion Science Branch

**2:30 Patrick Bozym, University of Illinois, Senior**

“Exploring Space on the Computer”

6711/Dennis Stocker, Microgravity Combustion Science Branch

**2:45 Idoreyin Montague, Shaw University, Junior**

“Regulation of Vascular Growth in the Chorioallantoic Membrane of Japanese Quail Eggs”

6712/Patricia Parsons-Wingerter, Microgravity Fluid Physics Branch

**3:00 Genee Smith, Fayetteville State University, Sophomore**

“The Fractal-based Analysis of the Regulation of Vascular Remodeling in the Quail Chorioallantoic Membrane”

6712/Patricia Parsons-Wingerter, Microgravity Fluid Physics Branch

**3:15 Julian Logan, Morehouse College, Sophomore**

“Practical Pocket PC Application w/ Biometric Security”

7140/Tammy Blaser, Flight Software Engineering Branch

**3:30 ADJOURN**

## COMPUTING AND COMBUSTION

**Daniel Thompson**  
Ohio Wesleyan University  
Computer Science  
Undergraduate Sophomore  
**Mentor: Dhanireddy Reddy**

### ABSTRACT

Coming into the Combustion Branch of the Turbomachinery and Propulsion Systems Division, there was not any set project planned out for me to work on. This was understandable, considering I am only at my sophomore year in college. Also, my mentor was a division chief and it was expected that I would be passed down the line. It took about a week for me to be placed with somebody who could use me.

My first project was to write a macro for TecPlot. Commonly, a person would have a 3D contour volume modeling something such as a combustion engine. This 3D volume needed to have slices extracted from it and made into 2D scientific plots with all of the appropriate axis and titles. This was very tedious to do by hand. My macro needed to automate the process.

There was some education I needed before I could start, however. First, TecPlot ran on Unix and Linux, like a growing majority of scientific applications. I knew a little about Linux, but I would need to know more to use the software at hand. I took two classes at the Learning Center on Unix and am now comfortable with Linux and Unix.

I already had taken Computer Science I and II, and had undergone the transformation from Computer Programmer to Procedural Epistemologist. I knew how to design efficient algorithms, I just needed to learn the macro language. After a little less than a week, I had learned the basics of the language. Like most languages, the best way to learn more of it was by using it.

It was decided that it was best that I do the macro in layers, starting simple and adding features as I went. The macro started out slicing with respect to only one axis, and did not make 2D plots out of the slices. Instead, it lined them up inside the solid. Next, I allowed for more than one axis and placed each slice in a separate frame. After this, I added code that transformed each individual slice-frame into a scientific plot. I also made frames for composite volumes, which showed all of the slices in the same XYZ space. I then designed an additional companion macro that exported each frame into its own image file. I then distributed the macros to a test group, and am awaiting feedback.

In the meantime, I am researching the possible applications of distributed computing on the National Combustor Code. Many of our Linux boxes were idle for most of the day. The department thinks that it would be wonderful if we could get all of these idle processors to work on a problem under the NCC code. The client software would have to be easily distributed, such as in screensaver format or as a program that only ran when the computer was not in use. This project proves to be an interesting challenge.

# CERTIFICATION OF CFD HEAT TRANSFER SOFTWARE FOR TURBINE BLADE ANALYSIS

**William A. Jordan**  
University of Kentucky  
Mechanical Engineering  
Senior  
Mentor: **Ali A. Ameri**

## ABSTRACT

Accurate modeling of heat transfer effects is a critical component of the Turbine Branch of the Turbomachinery and Propulsion Systems Division. Being able to adequately predict and model heat flux, coolant flows, and peak temperatures are necessary for the analysis of high pressure turbine blades. To that end, the primary goal of my internship this summer will be to certify the reliability of the CFD program *GlennHT* for the purpose of turbine blade heat transfer analysis.

*GlennHT* is currently in use by the engineers in the Turbine Branch who use the FORTRAN 77 version of the code for analysis. The program, however, has been updated to a FORTRAN 90 version which is more robust than the older code. In order for the new code to be distributed for use, its reliability must first be certified. Over the course of my internship I will create and run test cases using the FORTRAN 90 version of *GlennHT* and compare the results to older cases which are known to be accurate. If the results of the new code match those of the sample cases then the newer version will be one step closer to certification for distribution.

In order to complete these tests it will first be necessary to become familiar with operating a number of other programs. Among them are *GridPro*, which is used to create a grid mesh around a blade geometry, and *FieldView*, whose purpose is to graphically display the results from the *GlennHT* program. Once enough familiarity is established with these programs to render them useful, then the work of creating and running test scenarios will begin.

The work is additionally complicated by a transition in computer hardware. Most of the working computers in the Turbine Branch are Silicon Graphics machines, which will soon be replaced by LINUX PC's. My project is one of the first to make use the new PC's. The change in system architecture however, has created several software related issues which have greatly increased the time and effort investments required by the project.

Although complications with the project continue to arise, it is expected that the goal of my internship can still be achieved within the remaining time period. Critical steps have been achieved and test scenarios can now be designed and run. At the completion of my internship, the FORTRAN 90 version of *GlennHT* should be well on its way to certification.

# **Calibration, Data Acquisition, and Post Analysis of Turbulent Fluid Flow in a Calibration Jet Using Hot-Wire Anemometry**

**Michelle Moreno**

University of Texas Pan American

Mechanical Engineering

Undergraduate Junior

**Mentor: Robert Boyle**

## **ABSTRACT**

The Turbine Brach concentrates on the following areas: Computational Fluid Dynamics (CFD), and implementing experimental procedures to obtain physical modeling data. Hot-Wire Anemometry is a valuable tool for obtaining physical modeling data.

Hot-Wire Anemometry is likely to remain the principal research tool for most turbulent air/gas flow studies. The Hot-Wire anemometer consists of a fine wire heated by electric current. When placed in a fluid stream, the hot-wire loses heat to the fluid by forced convection. In forced convection, energy transfer is due to molecular motion imposed by an extraneous force moving fluid parcels. When the hot-wire is in "equilibrium", the rate of heat input to the wire is equal to the rate of heat loss at the wire ends. The equality between heat input and heat loss is the basis for King's equation, which relates the electrical parameters of the hot-wire to the flow parameters of the fluid.

Hot-Wire anemometry is based on convective heat transfer from a heated wire element placed in a fluid flow. Any change in the fluid flow condition that affects the heat transfer from the heated element will be detected virtually instantaneously by a constant-temperature Hot-Wire anemometry system. The system implemented for this research is the IFA 300. The system is a fully-integrated, thermal anemometer-based system that measures mean and fluctuating velocity components in air, water, and other fluids. It also measures turbulence and makes localized temperature measurements.

A constant-temperature anemometer is a bridge and amplifier circuit that controls a tiny wire at constant temperature. As a fluid flow passes over the heated sensor, the amplifier senses the bridge off-balance and adjusts the voltage to the top of the bridge, keeping the bridge in balance. The voltage on top of the bridge can then be related to the velocity of the flow. The bridge voltage is sensitive to temperature as well as velocity and so the built-in thermocouple circuit can be attached to a thermocouple that can measure the fluid temperature. This temperature reading can then be used by the software to correct the results to minimize the effect of temperature.

The working apparatus will contain the necessary components to run the system appropriately. A calibration jet will be used to create turbulent flow. A hot-wire will be placed 4 diameter distances from the exit, and data will be acquired using the IFA 300 software named Thermo Pro. Through Thermo Pro, one can calibrate the necessary hot-wire probes, acquire data, and analyze the collected data. The data will be compared to a similar test performed using Pitot - static tube measuring pressure changes. Using Bernoulli's equation, which relates pressure and velocity changes, both sets of data will be compared to see the exactness of the system.

The goal for summer 2004 is to be familiar with IFA 300, implement the software, acquire suitable data, and make relevant comparisons to similar models. Once the system runs accordingly, a training manual will be created for future use.



# VALIDATION OF CFD/HEAT TRANSFER SOFTWARE FOR TURBINE BLADE ANALYSIS

**Walter D. Kiefer**

The University of Akron  
Mechanical Engineering and Applied Math  
Undergraduate, Senior

**Mentor: James Heidmann**

## ABSTRACT

I am an intern in the Turbine Branch of the Turbomachinery and Propulsion Systems Division. The division is primarily concerned with experimental and computational methods of calculating heat transfer effects of turbine blades during operation in jet engines and land-based power systems. These include modeling flow in internal cooling passages and film cooling, as well as calculating heat flux and peak temperatures to ensure safe and efficient operation. The branch is research-oriented, emphasizing the development of tools that may be used by gas turbine designers in industry.

The branch has been developing a computational fluid dynamics (CFD) and heat transfer code called *GlennHT* to achieve the computational end of this analysis. The code was originally written in FORTRAN 77 and run on Silicon Graphics machines. However the code has been re-written and compiled in FORTRAN 90 to take advantage of more modern computer memory systems. In addition the branch has made a switch in system architectures from SGI's to Linux PC's. The newly modified code therefore needs to be tested and validated. This is the primary goal of my internship.

To validate the *GlennHT* code, it must be run using benchmark fluid mechanics and heat transfer test cases, for which there are either analytical solutions or widely accepted experimental data. From the solutions generated by the code, comparisons can be made to the correct solutions to establish the accuracy of the code. To design and create these test cases, there are many steps and programs that must be used.

Before a test case can be run, pre-processing steps must be accomplished. These include generating a grid to describe the geometry, using a software package called *GridPro*. Also various files required by the *GlennHT* code must be created including a boundary condition file, a file for multi-processor computing, and a file to describe problem and algorithm parameters. After the case is run to completion, post-processing must then be accomplished. The software package for this step is called *FieldView* which is used to view the solution graphically, as well as generate relevant data of the solution for analysis and comparison. A good deal of this internship will be to become familiar with these programs and the structure of the *GlennHT* code, as well as dealing with the problems associated with the change in system architecture.

The end goal of my internship will be to create and organize a collection of test cases to validate the *GlennHT* code. These will include various plots to demonstrate the accuracy of the code, as well as sufficient documentation to describe the procedures required to run these cases, and technical difficulties encountered and their solutions, so that future work may be done on the basis of this earlier experience. At this point the *GlennHT* code should be well on its way towards validation and certification for use in industry.

# **Combustion Branch Website Development**

**Eric Bishop**  
Boston University  
Bionformatics  
First Year Graduate Student  
**Mentor: Chi-Ming Lee**

The NASA combustion branch is a leader in developing and applying combustion science to focused aerospace propulsion systems concepts. It is widely recognized for unique facilities, analytical tools, and personnel. In order to better communicate the outstanding research being done in this Branch to the public and other research organization, a more substantial website was desired. The objective of this project was to build an up-to-date site that reflects current research in a usable and attractive manner.

In order to accomplish this, information was requested from all researchers in the Combustion branch, on their professional skills and on the current projects. This information was used to fill in the Personnel and Research sections of the website. A digital camera was used to photograph all personnel and these photographs were included in the personnel section as well.

The design of the site was implemented using the latest web standards: xhtml and external css stylesheets. This implementation conforms to the guidelines recommended by the w3c. It also helps to ensure that the web site is accessible by disabled users, and complies with Section 508 Federal legislation (which mandates that all Federal websites be accessible).

Graphics for the new site were generated using the gimp ([www.gimp.org](http://www.gimp.org)) an open-source graphics program similar to Adobe Photoshop. Also, all graphics on the site were of a reasonable size (less than 20k, most less than 2k) so that the page would load quickly.

Technologies such as Macromedia Flash and Javascript were avoided, as these only function on some clients which have the proper software installed or enabled.

The website was tested on different platforms with many different browsers to ensure there were no compatibility issues. The website was tested on windows with MS IE 6, MSIE 5, Netscape 7, Mozilla and Opera. On a Mac, the site was tested with MS IE 5, Netscape 7 and Safari.

# **DEVELOPMENT OF MESSAGE PASSING ROUTINES FOR HIGH PERFORMANCE PARALLEL COMPUTATIONS**

**Edward K. Summers**  
Massachusetts Institute of Technology  
Engineering  
Undergraduate, Freshman  
**Mentor: Jinho Lee, Ph.D.**

## **ABSTRACT**

Computational Fluid Dynamics (CFD) calculations require a great deal of computing power for completing the detailed computations involved. In an effort shorten the time it takes to complete such calculations they are implemented on a parallel computer.

In the case of a parallel computer some sort of message passing structure must be used to communicate between the computers because, unlike a single machine, each computer in a parallel computing cluster does not have access to all the data or run all the parts of the total program. Thus, message passing is used to divide up the data and send instructions to each machine.

The nature of my work this summer involves programming the "message passing" aspect of the parallel computer. I am working on modifying an existing program, which was written with OpenMP, and does not use a multi-machine parallel computing structure, to work with Message Passing Interface (MPI) routines. The actual code is being written in the FORTRAN 90 programming language.

My goal is to write a parameterized message passing structure that could be used for a variety of individual applications and implement it on Silicon Graphics Incorporated's (SGI) IRIX operating system.

With this new parameterized structure engineers would be able to speed up computations for a wide variety of purposes without having to use larger and more expensive computing equipment from another division or another NASA center.

# **Numerical Modeling and Testing of an Inductively-Driven and High-Energy Pulsed Plasma Thrusters**

**Brian Parma**

Arizona State University  
Aerospace Engineering  
Senior

**Mentor: Hani Kamhawi**

## **ABSTRACT**

Pulsed Plasma Thrusters (PPTs) are advanced electric space propulsion devices that are characterized by simplicity and robustness. They suffer, however, from low thrust efficiencies. This summer, two approaches to improve the thrust efficiency of PPTs will be investigated through both numerical modeling and experimental testing.

The first approach, an inductively-driven PPT, uses a double-ignition circuit to fire two PPTs in succession. This effectively changes the PPTs' configuration from an LRC circuit to an LR circuit. The LR circuit is expected to provide better impedance matching and improving the efficiency of the energy transfer to the plasma. An added benefit of the LR circuit is an exponential decay of the current, whereas a traditional PPT's under damped LRC circuit experiences the characteristic "ringing" of its current. The exponential decay may provide improved lifetime and sustained electromagnetic acceleration.

The second approach, a high-energy PPT, is a traditional PPT with a variable size capacitor bank. This PPT will be simulated and tested at energy levels between 100 and 450 joules in order to investigate the relationship between efficiency and energy level.

For the numerical modeling, a two-dimensional, axisymmetric Multi-Block Arbitrary Coordinate Hydromagnetic (MACH2) code is used. The MACH2 code, designed by the Center for Plasma Theory and Computation at the Air Force Research Laboratory, has been used to gain insight into a variety of plasma problems, including electric plasma thrusters. The goals for this summer include numerical predictions of performance for both the inductively-driven PPT and high-energy PPT, experimental validation of the numerical models, and numerical optimization of the designs. These goals will be met through numerical and experimental investigation of the PPTs' current waveforms, mass loss (or ablation), and impulse bit characteristics.

# JUPITER ICY MOONS ORBITER (JIMO) ELECTRICAL SYSTEMS TESTBED

**Scott J. Trapp**  
University of Toledo  
Electrical Engineering  
Undergraduate  
**Mentor: Ramon Lebron**

## ABSTRACT

The Jupiter Icy Moons Orbiter (JIMO) mission will send a spacecraft to explore three of Jupiter's moons (Callisto, Ganymede, and Europa), all of which show evidence of containing vast subterranean oceans beneath their icy surfaces. The evidence of these oceans was discovered by Galileo, and the moons are believed to have the three essential ingredients for life: water, energy, and the necessary chemical elements. Galileo has shown that melted water on Europa has been in contact with the surface of the moon in geologically recent times, and may still lie relatively close to the surface.

This project will also introduce a revolutionary new form of electric propulsion powered by a nuclear fission reactor. This electric propulsion is called ion propulsion. It was used on a previous mission called Deep Space 1, proving that ion propulsion works for interplanetary travel. Since JIMO will be traveling farther from the sun, solar power will be difficult to supply the electric energy demanded by the mission. Therefore a nuclear reactor and a thermo-electric converter system will be necessary.

Besides making the trip to three of Jupiter's moons – one after the other – a realistic possibility, this new form of power and propulsion opens up the rest of the outer solar system for future exploration. JIMO will fulfill its goals by exploring Europa first, with subsequent trips to the moons Callisto and Ganymede in order to provide comparisons key to understanding the evolution of all three.

In order to ensure the stability and proper preparation of the electrical system on JIMO, the High Power AC Power Management and Distribution (PMAD) Test Bed is being developed. The testing on this AC PMAD will consist of electrical performance verification of candidate power system components. Examples of these components are: high power AC switchgear, high power AC/DC converters, AC power distribution units, DC power distribution units, etc.

Throughout the course of the summer the over-current control circuit for the five different size relays will be constructed and tested. This circuit will sense the current input to the spacecraft loads and automatically switch off power if the current is too high. Once the circuit is verified to function properly and all necessary modifications have been made, a circuit schematic and board layout will have to be drawn using OrCAD, and the circuits will have to be built.

## **Computer Graphic design using Auto-CAD and Plug Nozzle Research**

**Rayna C. Rogers**  
University of Dayton  
Mechanical Engineering  
Undergraduate, Junior  
**Mentor: Albert L. Johns**

### **ABSTRACT**

The purpose of creating computer generated images varies widely. They can be use for computational fluid dynamics (CFD), or as a blueprint for designing parts. The schematic that I will be working on the summer will be used to create nozzles that are a part of a larger system. At this phase in the project, the nozzles needed for the systems have been fabricated. One part of my mission is to create both three dimensional and two dimensional models on Auto-CAD 2002 of the nozzles.

The research on plug nozzles will allow me to have a better understanding of how they assist in the thrust need for a missile to take off. NASA and the United States military are working together to develop a new design concept. On most missiles a convergent-divergent nozzle is used to create thrust. However, the two are looking into different concepts for the nozzle. The standard convergent-divergent nozzle forces a mixture of combustible fluids and air through a smaller area in comparison to where the combination was mixed. Once it passes through the smaller area known as A8 it comes out the end of the nozzle which is larger the first or area A9. This creates enough thrust for the mechanism whether it is an F-18 fighter jet or a missile. The A9 section of the convergent-divergent nozzle has a mechanism that controls how large A9 can be. This is needed because the pressure of the air coming out nozzle must be equal to that of the ambient pressure other wise there will be a loss of performance in the machine. The plug nozzle however does not need to have an A9 that can vary. When the air flow comes out it can automatically sense what the ambient pressure is and will adjust accordingly.

The objective of this design is to create a plug nozzle that is not as complicated mechanically as it counterpart the convergent-divergent nozzle.

## REFORMER FUEL INJECTOR

Jennifer L. Suder  
The University of Akron  
Chemical Engineering  
Undergraduate, Junior

Today's form of jet engine power comes from what is called a gas turbine engine. This engine is on average 14% efficient and emits great quantities of green house gas carbon dioxide and air pollutants, i.e. nitrogen oxides and sulfur oxides. The alternate method being researched involves a reformer and a solid oxide fuel cell (SOFC). Reformers are becoming a popular area of research within the industry scale. NASA Glenn Research Center's approach is based on modifying the large aspects of industry reforming processes into a smaller jet fuel reformer. This process must not only be scaled down in size, but also decrease in weight and increase in efficiency. In comparison to today's method, the Jet A fuel reformer will be more efficient as well as reduce the amount of air pollutants discharged.

The intent is to develop a 10kW process that can be used to satisfy the needs of commercial jet engines. Presently, commercial jets use Jet-A fuel, which is a kerosene based hydrocarbon fuel. Hydrocarbon fuels cannot be directly fed into a SOFC for the reason that the high temperature causes it to decompose into solid carbon and  $H_2$ . A reforming process converts fuel into hydrogen and supplies it to a fuel cell for power, as well as eliminating sulfur compounds. The SOFC produces electricity by converting  $H_2$  and  $CO_2$ . The reformer contains a catalyst which is used to speed up the reaction rate and overall conversion. An outside company will perform a catalyst screening with our baseline Jet-A fuel to determine the most durable catalyst for this application.

Poor feed mixing within the reformer effects the distribution of temperature, which can cause a deposit of carbon residue resulting in poor reformer performance and conversion efficiency. The first phase of the project is dedicated to designing a steam, fuel, and air injector and testing several in order to prevent these carbon residue deposits. The injectors will have a separate test run with a quartz tube and laser diagnostics that will analyze the mixing properties of the designed injectors. These will then be used to inject various mixtures of steam, fuel and air into the reformers.

Our project team is focusing on the overall research of the reforming process. Eventually we will do a component evaluation on the different reformer designs and catalysts. The current status of the project is the completion of buildup in the test rig and check outs on all equipment and electronic signals to our data system. The objective is to test various reformer designs and catalysts in our test rig to determine the most efficient configuration to incorporate into the specific compact jet fuel reformer test rig.

## **Simplifying CEA through Excel, VBA, and Subeq**

**Ryan Foster**  
University of Michigan  
Computer Science  
Undergraduate, Sophomore  
**Mentor: Russ Claus**

### **ABSTRACT**

Many people use compound equilibrium programs for very different reasons, varying from refrigerators to light bulbs to rockets. A commonly used equilibrium program is CEA. CEA can take various inputs such as pressure, temperature, and volume along with numerous reactants and run them through equilibrium equations to obtain valuable output information, including products formed and their relative amounts.

A little over a year ago, Bonnie McBride created the program subeq with the goal to simplify the calling of CEA. Subeq was also designed to be called by other programs, including Excel, through the use of Visual Basic for Applications (VBA).

The largest advantage of using Excel is that it allows the user to input the information in a colorful and user-friendly environment while allowing VBA to run subeq, which is in the form of a FORTRAN DLL (Dynamic Link Library). Calling subeq in this form makes it much faster than if it was converted to VBA.

Since subeq requires such large lists of reactant and product names, all of which can't be passed in as an array, subeq had to be changed to accept very long strings of reactants and products. To pass this string and adjust the transfer of input and output parameters, the subeq DLL had to be changed. One program that does this is Compaq Visual FORTRAN, which allows DLLs to be edited, debugged, and compiled. Compaq Visual FORTRAN uses FORTRAN 90/95, which has additional features to that of FORTRAN 77.

My goals this summer include finishing up the excel spreadsheet of subeq, which I started last summer, and putting it on the internet so that others can use it without having to download my spreadsheet. To finish up the spreadsheet I will need to work on debugging current options and problems. I will also work on making it as robust as possible, so that all errors that may arise will be clearly communicated to the user. New features will be added old ones will be changed as I receive comments from people using the spreadsheet. To implement this onto the Internet, I will need to develop an XML input/output format and learn how to write HTML.



## THE FLUIDS AND COMBUSTION FACILITY

**Sampa Kundu**

Cleveland State University

Accounting

Undergraduate, Senior

**Mentor: Janice K. Gassaway**

### ABSTRACT

Microgravity is an environment with very weak gravitational effects. The Fluids and Combustion Facility (FCF) on the International Space Station (ISS) will support the study of fluid physics and combustion science in a long-duration microgravity environment.

The Fluid Combustion Facility's design will permit both independent and remote control operations from the Telescience Support Center. The crew of the International Space Station will continue to insert and remove the experiment module, store and reload removable data storage and media data tapes, and reconfigure diagnostics on either side of the optics benches. Upon completion of the Fluids Combustion Facility, about ten experiments will be conducted within a ten-year period.

Several different areas of fluid physics will be studied in the Fluids Combustion Facility. These areas include complex fluids, interfacial phenomena, dynamics and instabilities, and multiphase flows and phase change. Recently, emphasis has been placed in areas that relate directly to NASA missions including life support, power, propulsion, and thermal control systems. By 2006 or 2007, a Fluids Integrated Rack (FIR) and a Combustion Integrated Rack (CIR) will be installed inside the International Space Station.

The Fluids Integrated Rack will contain all the hardware and software necessary to perform experiments in fluid physics. A wide range of experiments that meet the requirements of the international space station, including research from other specialties, will be considered. Experiments will be contained in subsystems such as the international standard payload rack, the active rack isolation system, the optics bench, environmental subsystem, electrical power control unit, the gas interface subsystem, and the command and data management subsystem.

Just like the Fluids Integrated Rack, the Combustion Integrated Rack is composed of several subsystems. These subsystems are the international standard payload rack, the optics bench, the combustion chamber, the diagnostics measurements system, the fuel/oxidizer, management assembly, the electrical power system, the environmental control systems, and the command and data management system. Some of the areas that will likely be studied include fire prevention, detection, and suppression, incineration of solid waste, power generation, flame spread, soot and polycyclic aromatic hydrocarbons, and materials synthesis. Similar investigations will be flown together whenever possible. Multi-user chamber inserts will be used to support experiments in droplets, solids, and gaseous fluids.

In conclusion, the Fluids and Combustion Facility will allow researchers to study fluid physics and combustion science in a long-duration microgravity environment.

# **SAFETY ABOARD THE INTERNATIONAL SPACE STATION**

**Shauna M. Mintz**  
University of Akron  
Mechanical Engineering  
Undergraduate  
**Mentor: Mike Hicks**

## **ABSTRACT**

As with any task that NASA takes on, safety is of utmost importance. There are pages of safety codes and procedures that must be followed before any idea can be brought to life. Unfortunately, the International Space Station's (ISS) safety regulations and procedures are based on 1g standards rather than on 0g. To aide in making this space age "home away from home" a less hazardous environment, I worked on several projects revolving around the dangers of flammable items in microgravity.

The first task I was assigned was to track flames. This involves turning eight millimeter video recordings, of tests run in the five second drop tower, into avi format on the computer. The footage is then compressed and altered so that the flame can be seen more clearly. Using another program called Spotlight, line profiles were used to collect data describing the luminescence of the flame at different points. These raw data are saved as text files and run through a macro so that a Matlab program can analyze it. By fitting the data to a curve and determining the areas of brightest luminescence, the behavior of the flame can be recorded numerically. After entering the data into a database, researchers can come back later and easily get information on flames resulting from different gas and liquid mixtures in microgravity.

I also worked on phase two of the FATE project, which deals with safety aboard the ISS. This phase involves igniting projected droplets and determining how they react with secondary materials. Such simulations represent, on a small scale, the spread of onboard fires due to the effervescence of burning primary materials. I set up existing hardware to operate these experiments and ran tests with it, photographing the results. I also made CAD drawings of the apparatus and the area available on the (SF)<sup>2</sup> rig for it to fit into. Those drawings were then used to determine how the hardware could be made to fit into the small region allotted for it. The experiment will later be performed on the KC-135, and the results gathered will be used to reanalyze current safety standards for the ISS, including the distance of required separation for flammable materials.

My most exciting project dealt with the droplet generator used for FATE. The current apparatus is very large and bulky. It can, also, possibly produce slightly inaccurate results when droplets are dislodged from the needle, when projected. This is because the system is pressure based. When droplets are made in microgravity they form a ball around the tip of the needle. The droplets are then blown off using air pressure. A piezoelectric droplet generator was determined to be the best route for redesign. Rather than having to blow off the droplet, a quick pulse from the generator would provide enough force to produce a projectile. I spent days researching and networking to find the information needed to understand piezoceramics and make a suitable device. After determining the appropriate design, drawings were put together in AutoCAD and parts were made and ordered. The final product will be included in the experiments sent up on the KC-135.

**Soot Nanostructure: Using Fringe Analysis Software on High Resolution  
Transmission Electron Microscopy of Carbon Soot**

**James D. King**

Fayetteville State University

Double Major in Computer Science and Mathematics

Undergraduate, junior

**Mentor: Randy Vanderwall**

**Abstract**

Using high resolution transmission electron images of carbon nanotubes and carbon particles, we are able to use image analysis program to determine several carbon fringe properties, including length, separation, curvature and orientation. Results are shown in the form of histograms for each of those quantities. The combination of those measurements can give a better indication of the graphic structure within nanotubes and particles of carbon and can distinguish carbons based upon fringe properties. Carbon with longer, straighter and closer spaced fringes are considered graphitice, while amorphous carbon contain shorter, less structured fringes.

## Exploring Space on the Computer

Patrick Bozym  
University of Illinois  
Physics / Nuclear Engineering  
Senior  
**Mentor: Dennis P. Stocker**

For the past year Dennis Stocker has been in the process of developing pencil and paper games, which are fun, challenging, and educational for middle school and high school students. The latest version of these pencil and paper games is Spaceship Commander. The objective of the game is to earn points by plotting the flight path of a spaceship so astronauts can perform microgravity experiments, and make short-range measurements of other planets. During my ten weeks here at the GRC my goal is to create a computer based version of Spaceship commander.

During the development of this game the primary focus has been on making it as educational and fun for the student as possible. The main educational objective of this game is to give students an understanding of forces and motion, including gravity. This is done by incorporating Newton's laws into the game. For example a space craft in the video game experiences a gravitational force applied to it by planets.

The software I am using to create this game is a freeware application called Game Maker. Game Maker allows novice computer programmers like me to create arcade style games using a visual drag and drop interface. By using functions provided by Game Maker and a few I have written myself, I have been able to create a few simple computer games.

Currently the computer game allows the student to navigate a space ship around planets, and asteroids by using the arrow keys on the numeric keypad. Each time an arrow key is pressed by the student the corresponding acceleration of the space ship is seen on the screen. Points are earned by navigating the space ship close enough to planets to gather scientific data. However the game encourages the student to plan his or her course carefully, because if the student gets too close to a planet they may not be able to escape the planet's gravity, and crash into the planet.

The next step in the game development is to include a launch sequence which allows the student to launch from their home planet at a speed and direction determined by the student. In addition to that, I hope to include additional levels, and mission objectives for the student to carry out. When the game is completed it will be posted on the internet as a freeware application. It is hoped that young people who play this game will become more interested in NASA and pursuing careers in science, technology, engineering, and mathematics.

# Regulation of Vascular Growth in the Chorioallantoic Membrane of Japanese Quail Eggs

Idoreyin P. Montague

Shaw University

Physics

Undergraduate

Mentor: Dr. Patricia Parsons-Wingenter

The Microgravity Research Program is part of NASA's Office of Biological and Physical Research (OBPR). The mission of the Microgravity Fluid Physics research program is to facilitate and conduct the best possible fluid physics research using the space environment and make this knowledge available to the scientific community and the public at large.

During the summer of 2004, I worked in this division with Dr. Patricia Parsons-Wingenter. Dr. Parsons was working on several projects that used the chorioallantoic membrane (CAM) of Japanese quail eggs. The CAM develops in the eggs of birds and reptiles and is a very vascular fetal membrane composed of the fused chorion and adjacent wall of the allantois. The CAM is formed on day 4 of incubation and its primary job is to mediate gas exchanges with the extra embryonic environment. The CAM of our Japanese quail eggs is easily identifiable to us because it is transparent and it sits on top of the yolk with the embryo in the center.

The CAM is of interest because of its many applications in the field of medicine as it relates to vascular remodeling and angiogenesis. Angiogenesis is simply the growth or formation of new blood vessels and anti-angiogenesis is the inhibition of said vessels. Angiogenesis occurs naturally in a healthy body for healing wounds and for restoring blood flow to tissues after injury and in females during the monthly reproductive cycle. In many serious diseases, like several types of cancer and those that affect the heart and cardiovascular system, the body loses control over angiogenesis. These diseases, which are dependent on angiogenesis, result when new blood vessels either grow excessively or insufficiently.

The chorioallantoic membrane of our Japanese quail eggs gives a good model of angiogenesis. We used angiogenic regulators to inhibit or stimulate vascular growth in the CAM in a healthy manner and they induced distinct vascular patterns *in vivo*. Certain dominant regulators can be recognized by their unique vascular patterns and from these patterns; we can deduce specific alterations in vascular remodeling and angiogenesis. This will aid us in early-stage diagnosis and customized therapies for patients with angiogenic-dependent diseases.

This particular research is important to NASA because cardiovascular health issues are the second highest of ten categories that have been defined as risk factors in human space exploration. Also, cardiovascular-related diseases have been the leading cause of death in America since 1981. Therefore, this kind of research in the field of cardiovascular health is of great importance to humans on earth and in space.

# **The Fractal-based Analysis of the Regulation of Vascular Remodeling in the Quail Chorioallantoic Membrane**

**Geneé S. Smith**

Fayetteville State University

Biology

Undergraduate, Senior

**Mentor: Patricia Parsons-Wingenter**

## **ABSTRACT**

Critical to the advancement of space exploration is the safety and well being of astronauts while in space. This study focuses on the second highest of NASA-defined risk categories for human space exploration, cardiovascular alterations. Current research of this problem is being tackled by investigating angiogenesis through vascular remodeling. Angiogenesis is the growth and formation of new blood vessels. Angiogenesis is an important part of maintaining normal development and bodily functions. The loss of control of this process, either insufficient or excessive vascular growth, is considered a common denominator in many diseases, such as cancer, diabetes, and coronary artery disease.

Objectives are presently being met by observing the effects of various regulators, like thrombospondin 1 (TSP-1) and a novel vessel tortuosity factor (TF), through the use of the chorioallantoic membrane (CAM) of Japanese quail embryos, which enable the direct optical imaging of 2-dimensional vascular branching trees. Research within the CAM is being performed to deduce numerous methods of regulating vessel growth. This project centers on the ability of a novel vessel regulator to affect angiogenesis. For example, it is hypothesized that the TSP-1 will inhibit the growth of CAM vasculature.

Fractal/VESGEN-based techniques and PIV analysis are the methodologies used to investigate vascular differentiation. This tactic is used to quantify results and measure the growth patterns and morphology of blood vessels. The regulatory mechanisms posed by this vessel regulator can be deduced by alterations found within the vasculature patterns of quail embryos.

# Practical Pocket PC Application w/ Biometric Security

**Julian Logan**

Morehouse College

Computer Science

Undergraduate Junior

**Mentor: Tammy M. Blazer**

## Abstract

I work in the Flight Software Engineering Branch, where we provide design and development of embedded real-time software applications for flight and supporting ground systems to support the NASA Aeronautics and Space Programs. In addition, this branch evaluates, develops and implements new technologies for embedded real-time systems, and maintains a laboratory for applications of embedded technology.

The majority of microchips that are used in modern society have been programmed using embedded technology. These small chips can be found in microwaves, calculators, home security systems, cell phones and more. My assignment this summer entails working with an iPAQ HP 5500 Pocket PC. This top-of-the-line hand-held device is one of the first mobile PC's to introduce biometric security capabilities. Biometric security, in this case a fingerprint authentication system, is on the edge of technology as far as securing information. The benefits of fingerprint authentication are enormous. The most significant of them are that it is extremely difficult to reproduce someone else's fingerprint, and it is equally difficult to lose or forget your own fingerprint as opposed to a password or pin number. One of my goals for this summer is to integrate this technology with another Pocket PC application.

The second task for the summer is to develop a simple application that provides an Astronaut EVA (Extravehicular Activity) Log Book capability. The Astronaut EVA Log Book is what an astronaut would use to report the status of field missions, crew physical health, successes, future plans, etc. My goal is to develop a user interface into which these data fields can be entered and stored. The applications that I am developing are created using eMbedded Visual C++ 4.0 with the Pocket PC 2003 Software Development Kit provided by Microsoft.

**Research Symposium I  
Ohio Aerospace Institute  
Thursday, July 8, 2004**

**OAI Industry Room**

9:00 A.M. **Chante Hill, Tennessee State University, Junior**

“Space Communications Emulation Facility”

7160/Rafael Sanabria, Computational Environments Branch

9:15 **Brandy Hammond, Cleveland State University, Freshman**

“Surface Modeling and Grid Generation for Iced Airfoils (SMAGGICE)”

7170/Herbert Schilling, Computational Sciences Branch

9:30 **Session Break**

9:45 **Kristin Bigach, Lehigh University, Senior**

“The Center Master Plan for NASA Glenn Research Center”

7320/Joseph Morris, Systems Management and Maintenance Branch

10:00 **Ashlie Flegel, University of Toledo, Sophomore**

“The Multistage Compressor Facility”

7610/Hal Weaver, Aviation Environments Test Engineering Branch

10:15 **Grant Lugas, Lorain County Community College, Sophomore**

“Stator Blade Laser Window Research”

7700/John Taylor, Engineering Development Division

10:30 **Brandon Travis, University of Kentucky, Junior**

“Bolt Analysis Program”

7725/Kelly McEntire, Turbomachinery Branch

10:45 **Nathaniel Young III, Prairie View A&M University, Junior**

“Design of Timer Circuit for Dynamic Data System”

7660/Mark Sorrells, Electronic and Special Systems Branch

11:00 **LUNCH**

1:00 **Moline Prak, John Carroll University, Sophomore**

“The Investigation of Carbon Contamination and Sputtering Effects of Xenon Ion Thrusters”

5480/Bruce Banks, Electro-Physics Branch

1:15 **Amanda Opaluch, Wittenberg University, Senior**

“The Use of Pristine and Intercalated Graphite Fiber Composites as Buss Bars in Lead-Acid Batteries”

5480/James Gaier, Electro-Physics Branch

1:30 **Yazmin Gomez Cruz, University of Turabo, Junior**

“Manufacturing BMS/ISO System Review”

7720/Wilma Taylor, Electrical and Avionics Systems Branch



**1:45 Lisa Ritchie, Kent State University, Junior**

**“Flywheel Technology”**

7630/Vicki Crable, Space Power and Propulsion Test Engineering Branch

**2:00 Laura Burke, Case Western Reserve University, Junior**

**“Trajectory Analysis”**

7820/Robert Falck, Systems Analysis Branch

**2:15 Corinne Kellerman, University of Arizona, Sophomore**

**“Website of the Systems and Analysis Branch Supported Projects and Graph Analysis”**

7820/Melissa McGuire, Systems Analysis Branch

**2:30 Claudia Panait, George Washington U, Junior**

**“Book Out! An Inventory Story”**

0620/Susan Oberc, Logistics and Technical Information Division

**2:45 ADJOURN**

## SPACE COMMUNICATIONS EMULATION FACILITY

**Chante' A. Hill**

Tennessee State University  
Electrical, Computer Engineering  
Undergraduate, Senior

**Mentor: Frances Lawas-Grodek**

### ABSTRACT

Establishing space communication between ground facilities and other satellites is a painstaking task that requires many precise calculations dealing with relay time, atmospheric conditions, and satellite positions, to name a few. The Space Communications Emulation Facility (SCEF) team here at NASA is developing a facility that will approximately emulate the conditions in space that impact space communication. The emulation facility is comprised of a 32 node distributed cluster of computers; each node representing a satellite or ground station. The objective of the satellites is to observe the topography of the Earth (water, vegetation, land, and ice) and relay this information back to the ground stations. Software originally designed by the University of Kansas, labeled the Emulation Manager, controls the interaction of the satellites and ground stations, as well as handling the recording of data.

The Emulation Manager is installed on a Linux Operating System, employing both Java and C++ programming codes. The emulation scenarios are written in eXtensible Markup Language, XML. XML documents are designed to store, carry, and exchange data. With XML documents data can be exchanged between incompatible systems, which makes it ideal for this project because Linux, MAC and Windows Operating Systems are all used. Unfortunately, XML documents cannot display data like HTML documents. Therefore, the SCEF team uses XML Schema Definition (XSD) or just schema to describe the structure of an XML document. Schemas are very important because they have the capability to validate the correctness of data, define restrictions on data, define data formats, and convert data between different data types, among other things. At this time, in order for the Emulation Manager to open and run an XML emulation scenario file, the user must first establish a link between the schema file and the directory under which the XML scenario files are saved. This procedure takes place on the command line on the Linux Operating System. Once this link has been established the Emulation manager validates all the XML files in that directory against the schema file, before the actual scenario is run.

Using some very sophisticated commercial software called the Satellite Tool Kit (STK) installed on the Linux box, the Emulation Manager is able to display the data and graphics generated by the execution of a XML emulation scenario file. The Emulation Manager software is written in JAVA programming code. Since the SCEF project is in the developmental stage, the source code for this type of software is being modified to better fit the requirements of the SCEF project. Some parameters for the emulation are hard coded, set at fixed values. Members of the SCEF team are altering the code to allow the user to choose the values of these hard coded parameters by inserting a toolbar onto the preexisting GUI.

## **SURFACE MODELING AND GRID GENERATION FOR ICED AIRFOILS (SMAGGIce)**

**Brandy M. Hammond**  
Cleveland State University  
Computer Engineering  
Undergraduate, Sophomore  
**Mentor: Herbert W. Schilling**

### **ABSTRACT**

Many of the troubles associated with problem solving are alleviated when there is a model that can be used to represent the problem. Through the Advanced Graphics and Visualization (G-VIS) Laboratory and other facilities located within the Research Analysis Center, the Computer Services Division (CSD) is able to develop and maintain programs and software that allow for the modeling of various situations. For example, the Icing Research Branch is devoted to investigating the effect of ice that forms on the wings and other airfoils of airplanes while in flight.

While running tests that physically generate ice and wind on airfoils within the laboratories and wind tunnels on site are done, it would be beneficial if most of the preliminary work could be done outside of the lab. Therefore, individuals from within CSD have collaborated with Icing Research in order to create SmaggIce. This software allows users to create ice patterns on clean airfoils or open files containing a variety of icing situations, manipulate and measure these forms, generate, divide, and merge grids around these elements for more explicit analysis, and specify and discretize subcurves.

With the projected completion date of Summer 2005, the majority of the focus of the SmaggIce team is user-functionality and error handling. My primary responsibility is to test the Graphical User Interface (GUI) in SmaggIce in order to ensure the usability and verify the expected results of the events (buttons, menus, etc.) within the program. However, there is no standardized, systematic way in which to test all the possible combinations or permutations of events, not to mention unsolicited events such as errors. Moreover, scripting tests, if not done properly and with a view towards inevitable revision, can result in more apparent errors within the software and in effect become useless whenever the developers of the program make a slight change in the way a specific process is executed. My task therefore requires a brief yet intense study into GUI coverage criteria and creating algorithms for GUI implementation.

Nevertheless, there are still heavily graphical features of SmaggIceSmaggIce that must be either corrected or redesigned before its release. A particular feature of SmaggIce is the ability to smooth out curves created by control points that form an arbitrary shape into something more acquiescent to gridding (while maintaining the integrity of the data). This is done by a mathematical model known as Non-Uniform Rational B-Spline (NURBS) curves. Existing NURBS code is written in FORTRAN-77 with static arrays for holding information. My new assignment is to allow for dynamic memory allocation within the code and to make it possible for the developers to call out functions from the NURBS code using C.

GEOGRAPHIC INFORMATION SYSTEMS &  
WEB PAGE DEVELOPMENT

Justin Reynolds

Mentors: Ronald Zurawski & Karl Hagelin

The Facilities Engineering and Architectural Branch is responsible for the design and maintenance of buildings, laboratories, and civil structures. In order to improve efficiency and quality, the FEAB has dedicated itself to establishing a data infrastructure based on Geographic Information Systems, GIS. The value of GIS was explained in an article dating back to 1980 entitled "Need for a Multipurpose Cadastre" which stated,

*"There is a critical need for a better land-information system in the United States to improve land-conveyance procedures, furnish a basis for equitable taxation, and provide much-needed information for resource management and environmental planning."*

Scientists and engineers both point to GIS as the solution. What is GIS? According to most text books, Geographic Information Systems is a class of software that stores, manages, and analyzes mapable features on, above, or below the surface of the earth. GIS software is basically database management software to the management of spatial data and information. Simply put, Geographic Information Systems manage, analyze, chart, graph, and map spatial information.

At the outset, I was given goals and expectations from my branch and from my mentor with regards to the further implementation of GIS. Those goals are as follows: (1) Continue the development of GIS for the underground structures. (2) Extract and export annotated data from AutoCAD drawing files and construct a database (to serve as a prototype for future work). (3) Examine existing underground record drawings to determine existing and non-existing underground tanks. Once this data was collected and analyzed, I set out on the task of creating a user-friendly database that could be assessed by all members of the branch. It was important that the database be built using programs that most employees already possess, ruling out most AutoCAD-based viewers. Therefore, I set out to create an Access database that translated onto the web using Internet Explorer as the foundation. After some programming, it was possible to view AutoCAD files and other GIS-related applications on Internet Explorer, while providing the user with a variety of editing commands and setting options.

I was also given the task of launching a divisional website using Macromedia Flash and other web-development programs.

# THE CENTER MASTER PLAN FOR NASA GLENN RESEARCH CENTER

**Kristin M. Bigach**  
Lehigh University  
Industrial Engineering  
Undergraduate, Senior  
**Mentor: Joseph E. Morris**

## ABSTRACT

The Center Master Plan for NASA Glenn Research Center is a comprehensive survey of NASA Glenn's current facility assets and a vision of how we see the facilities will change over the next 20 years in order to support the changing NASA Mission. This Center Master Plan is a vital management tool used by all organizations for making near term decisions and in future planning. During the summer of 2004, I worked with Joseph Morris, the Chief Architect in the Facilities Division, on beginning this Center Master Planning Process.

The previous Master Plan was completed by the Center in 1985 and contained general information on the background of the facility as well as maps detailing environmental and historic records, land use, utilities, etc. The new Master Plan is required for the Center by NASA headquarters and will include similar types of information as used in the past. The new study will provide additional features including showing how individual buildings are linked to the programs and missions that they serve. The Master Plan will show practical future options for the facility's assets with a twenty year look ahead. The Plan will be electronically retrievable so that it becomes a communications tool for Center personnel.

A Center Master Plan, although required, is very beneficial to NASA Glenn Research Center in aiding management with the future direction of the campus. Keeping up-to-date information and future plans readily available to all of NASA Glenn will insure that future real property development efficiently and effectively supports the missions carried out and supported by the Center. A Center Master Plan will also facilitate coordination with Center supported programs, stakeholders, and customers. In addition, it will provide a basis for cooperative planning with local and other governmental organizations and ultimately ensure that future budgets include the Center program needs described in the plan. This will ensure that development plans are safe, practical, and cost effective.

To properly formulate any future plans, background information and research are required. Before bringing in a consultant to tackle the three year process anticipated to prepare a Center Master Plan, my job was to gather information on different organizations' contributions to the NASA mission, their facility needs, consistent trends they observe, etc. I conducted numerous interviews with personnel such as Directorate Representatives, Division Chiefs, Branch Chiefs, System Managers and Building Managers. I documented the information I received from them for future use. I used the information to create various color-coded maps layering the different data. This was done with the ending objective being to collect the information and place it in a database that will be linked with Aperture (a computer program that generates color-coded map layers from database information) and made electronically retrievable to the Planning Consultant, NASA personnel, program stakeholders, and other governmental agencies.

My goal this summer was to gather information and ideas appropriate for use in NASA Glenn Research Center's Master Plan and organize them for future application by the Planning Consultant. By the end of the summer, after completion of my goal, I will utilize my knowledge and create an array of "preliminary" future plans for the facility that can be passed along as a guidance tool.

# The Multistage Compressor Facility

**Ashlie Flegel**  
University of Toledo  
Mechanical Engineering  
Undergraduate, Sophomore  
**Mentor: Hal Weaver**

## ABSTRACT

Research and developments of new aerospace technologies is one of Glenn Research Center's specialties. One facility that deals with the research of aerospace technologies is the High-speed Multistage Compressor Facility. This facility will be testing the performance and efficiency of an Ultra Efficient Engine Technology (UEET) two-stage compressor.

There is a lot of preparation involved with testing something of this caliber. Before the test article can be installed into the test rig, the facility must be fully operational and ready to run. Meaning all the necessary instrumentation must be calibrated and installed in the facility. The test rig should also be in safe operating condition, and the proper safety permits obtained. In preparation for the test, the Multistage Compressor Facility went through a few changes. For instance the facility will now be utilizing slip rings, the gearbox went through some maintenance, new lubrications systems replaced the old ones, and special instrumentation needs to be fine tuned to achieve the maximum amount of accurate data.

Slips rings help gather information off of a rotating device- in this case from a shaft- onto stationary contacts. The contacts (or brushes) need to be cooled to reduce the amount of frictional heat produced between the slip ring and brushes. The coolant being run through the slip ring is AK-225, a material hazardous to the ozone. To abide by the safety regulations the coolant must be run through a closed chiller system. A new chiller system was purchased but the reservoir that holds the coolant was ventilated which doesn't make the system truly closed and sealed. My task was to design and have a new reservoir built for the chiller system that complies with the safety guidelines.

The gearbox had some safety issues also. Located in the back of the gearbox an inching drive was set up. When the inching drive is in use the gears and chain are bare and someone can easily get caught up in it. So to prevent anyone from getting hurt in the gears I designed a chain guard. The guard fully covers the whole sprocket gear and chain.

Some of the facility's systems were modified such as the lubrication system. This system is used to lubricate both the gearbox and compressor bearings, but now the system has been split into two separate systems; an independent system for the gearbox and another independent system for the compressor bearings. Since the lube system has been changed, the facility drawings became incorrect so it was my task to look over each system and update the drawings. There were a couple other systems that had minor changes so I updated those drawings as well.

When it comes time to test the compressor it is vital to get accurate data, one of the important pieces of data is to find out the compressor efficiency. Through calculations the efficiency can be found by getting the temperature. The facility uses thermocouples for temperature readings; they are very useful but not very accurate. A method has been found to improve the accuracy of these thermocouples by putting them through extreme temperature changes. The thermocouples will have to be heated up and cooled at a uniform temperature. The best way to achieve this is to put the thermocouples in an isothermal block. I was given a 10" diameter by 12" copper block and my assignment was to design the isothermal block for the thermocouple rakes.



Project Abstract

## Stator Blade Laser Window Research

Grant A. Lugas

Lorain County Community College

Mechanical Design

Undergraduate

Mentor: Vincent E. Satterwhite

### *Introduction:*

All turbofan engines used in modern aviation contain a series of fan blades and compressor blades which are all connected to one drive shaft. The drive shaft runs directly down the center of the engine. When looking at the front of a turbofan engine inlet the first visible set of blades are the fan blades which have the biggest diameter. The compressor stages are located from about the midpoint to the back of the engine. The compressor is a smaller bladed rotor that takes a percentage of the air from the intake and compresses it, while fuel is being added, to a high pressure; then it is ignited and combusted, while the exhaust trails out the back. The hot combusted fuel expands and exits out the rear of the engine rather quickly; this hot expansion of air turns the compressor wheels at a moderate rate which in return turns the shaft that the fan blades are connected to. Thus the fan blade tips are turning very fast creating almost all of the engines thrust needed for flight, which is mostly bypassed around the outside of the engine cowling. A commercial jet during flight as well as take-off is propelled by the front fan blades in the jet, while dark exhaust trails out the back from the compressor stages, which is the driving force that rotates the fan blades. Inside the jet engine between each set of blades are **stator blades**, which are pitched opposite of the fan and compressor blades, the stator blades are both rotational and axial fixed in place.

### *Project:*

The project that I was assigned to involves the QAT 22 fan test rig; which is currently under final design review and very soon will be fabricated. The purpose of this research facility is to better understand the effects of stator blades. Stator blades are used to straiten the air in a turbine. Although these blades are already being used in the aviation industry, there is still much information that is not yet fully known about them. The researcher's primary aim is to determine what the airflow is like at both the leading edge and the trailing edge of a stator blade.

My work focused on designing the windows usable for both a compressor rig and a test fan rig. The difference between the two is the test fan application will be looking into a stator blade array rather than just looking at the rotor. My discussion will include a detailed explanation of how the PIV laser window system functions from start to finish. I will also discuss how the information is gathered and organized. Further more I plan to talk about the purpose of this kind of research and the advantages to using this technology to determine the airflow characteristics of blade designs. Finally I will discuss the researcher's conclusion on the relationship between aerodynamics of a blade and how noise is produced. NASA's main goal with this particular facility is find ways to quiet engine noise by reducing the amount of cavitations that occurs around the blades of a turbofan engine.

## Bolt Analysis Program

Brandon E. Travis  
University of Kentucky  
Mechanical Engineering  
Junior  
Mentor: Kelly J. McEntire

### ABSTRACT

In designing and testing bolted joints there are multiple parameters to be considered and calculations that must be performed to predict the joint behavior. Each different set of parameters may call for a different set of equations. Determining every parameter in each bolted joint is impractical and in many cases impossible. On the other hand, it is much easier to reduce these calculations to a universal set that can be used for all bolted joints. This is the purpose of the Bolt Analysis Program.

My project under the Mechanical and Rotating Systems branch of the Engineering Development and Analysis Division was to take the Bolt Analysis Program Version 2.0 and update the program to a modern and user-friendly format. Version 2.0 of the Bolt Analysis Program is a useful program, but lacks the dynamic capabilities that are needed for current applications. Version 2.0 of the Bolt Analysis Program was written in 1993 using the Pascal programming language in a DOS format. This program allows you to input data in a step-by-step format, calculates the data, and then on a final screen displays the input and the output from the calculations.

Version 2.0 is still applicable for all bolted joint analysis, but has many updates that are desired. First, the program runs in DOS format. With the applications available today, my mentor decided it would be best to update the program into Microsoft Excel using Visual Basic for Applications (VBA). This would allow the program to have multiple Graphical User Interfaces (GUI's) while retaining all functions of the previous program. Version 2.0 only allows you to input data in a step-by-step process. If you make a mistake and need to go back, you must run through the entire program before you can return to fix your error. This becomes tedious when needing to change one parameter or test multiple sets of data. In Version 3.0, the program allows you to enter and change data at any time while displaying real-time output data. If you realize an error, it is as simple as scrolling back to your mistake and changing the data.

The second update for the program was to add capabilities not original to the program. Version 2.0 allows the user to input data and receive output data in an English unit format alone, restricting the user to units such as pound, inch, and psi. Version 3.0 will allow the user to use either Metric units or English units, giving the user the capability to use units such as the meter, Newton, and Mega-Pascal. Version 2.0 allowed the user to define the thread series on the bolt as either coarse threads or fine threads; Version 3.0 adds the extra-fine thread series. Also, graphing and printing capabilities were updated to allow the user to convert all documents to Microsoft Office compatible programs.

In conclusion, Bolt Analysis Program Version 3.0 upon completion will have achieved all desired goals.



## **Design of Timer Circuit for Dynamic Data System**

**Nathaniel Young III**  
Prairie View A&M University  
Electrical Engineering  
Undergraduate, Senior  
**Mentor: Mark Sorrells**

### **Abstract**

The Branch That I work in is in the Aero Electronic Test Branch, which is part of the Research and Testing Division. The Aero Electronic Test Branch deals with electronic control and instrumentation systems. This branch supports the research and test study of wind tunnels such as the 10x10, 9x15, and 8x6. Wind tunnels are used in research to test certain parts of a jet, plane, shuttle or any other flying object in certain test conditions.

My assignment is to design a programmable trigger circuit on a 19" standard rack mount that will allow the circuit to latch and hold for a predefined amount of time entered by the user when receiving a signal. It should then rearm itself within 0.25 seconds after the time is finished. The time should be able to be seen on a display showing the time entered. The time range has to be from 0-600 seconds in 0.01 second increments (600.00). From the information given, counters will be needed to design and build this circuit. A counter, in it's simplest form, is a group of flip flops that can temporarily store bits of information put into the circuit. They can be constructed in many different ways, such as in 4 flip flops (4-bit counter) or 8 flip flops and even higher. Counters are usually cascaded with other counters to reach higher bits, such as 16 or 24 bit counters. The application in which I will use the counters will be to count down from any programmable number that I input either by a keyboard or a thumbwheel. Also, I will use counters that will be used specifically as a frequency divider to divide the pulses that enter the circuit through an input signal from a crystal clock. The pulses will need to be divided so that it will function as a 100Hz clock putting out 100 pulses per second. A switch will be used to load my inputs in and more than likely a button also so that I can stop and hold the count at any point of time. I will use 5 BCD up/down programmable counters, and a certain amount (depending on what kind of "divide by N" counter I use) of frequency dividing counters for the assignment. After the design is carefully made, a task order will be written and then given to the manufacturer to create a rack mount circuit board that will match my specifications given.

The applications in which this design will be used for is in the use of the six-component balance signal conditioner for measurement and electronic system control. It can be used as a timer system for the balance signal conditioner in which it does numerous tests for the Wind tunnel research, in which a preset time can be set for how long it performs its tests. Specifically, my design should be applied to the balance signal conditioner used for the 8x6 wind tunnel research. Hopefully this design should aid in more efficient research for the 8x6 wind tunnel.

# THE INVESTIGATION OF CARBON CONTAMINATION AND SPUTTERING EFFECTS OF XENON ION THRUSTERS

**Moline K. Prak**  
John Carroll University  
Engineering  
Undergraduate, Sophomore  
**Mentor: Bruce A. Banks**

## ABSTRACT

The Electro-Physics Branch of the NASA Glenn Research Center investigates the effect of atomic oxygen, environmental durability of high performance power materials and surfaces, and low earth orbit. One of its current projects involves the analysis of ion thrusters.

Ion thrusters are devices that initiate a beam of ions to a target area. The type of ion thruster that I have been working with this Summer of 2004 emits positively charged Xenon ( $Xe^+$ ) atoms through two grids, the screen grid and the accelerator grid, after it enters an ionization chamber. Insulators are used to mechanically hold and separate these two grids. A propellant isolator, an instrument that closely resembles insulators, is placed in front of the ionization chamber. Both the insulator and isolator are made with a ceramic compound and filled with insulating beads. The main difference between the two devices is that the propellant isolator allows gas to flow through, in this case, the gas is  $Xe^+$ , and the insulators do not.

In order to avoid carbon deposits and other contaminating chemicals to settle on the insulators and propellant isolator, a metal shadow shield is placed around them. These shadow shields function as a protectant and can be shaped in numerous configurations. Part of my job responsibility this summer is to investigate the effectiveness of different shadow shields that are utilized on three different ion engines: the NSTAR (NASA Solar Electric Propulsion Technology Application Readiness), JIMO (Jupiter Icy Moons Orbiter), and NEXIS (Nuclear Electric Xenon Ion System). Using calculus and other mathematical tactics, I was asked to find the total flux of carbon contamination that was able to pass the protectant shadow shield. I familiarized myself with the software program, MathCad2004, to help perform some mathematical computations such as complex integration.

Another method of studying the probability of contamination is by experimental simulation. After attaining the precise parameters of the actual shadow shields, I created replicas of three types of shadow shielding to be used to undergo testing. It will be placed in a machine that produces carbon atoms at a high temperature of 200°C.

Carbon contamination is the effect of sputtering. Sputtering occurs when an ion particle or beam is aimed at a targeted material. As a result of this collision, atoms and other particles are ejected out of the target surface. Another part of my internship consisted of research on sputter ejection, or the angle distribution of sputtered material. This research entailed finding the past results of sputter ejection investigation as well as creating another type of mock simulation. Other minor projects include calculating the path of  $Xe^+$  gas through the insulating beads of the isolators and assisting my mentor in collecting data for his paper for the Joint Propulsion Conference & Exhibit to be held July 11-14, 2004 in Fort Lauderdale, Florida.

# **The Use of Pristine and Intercalated Graphite Fiber Composites as Buss Bars in Lead-Acid Batteries**

**Amanda M. Opaluch**  
Wittenberg University  
Biochemistry/Molecular Biology  
Undergraduate, Senior  
**Mentor: James R. Gaier**

## **ABSTRACT**

This study was conducted as a part of the Firefly Energy Space Act Agreement project to investigate the possible use of composite materials in lead acid batteries. Specifically, it examined the use of intercalated graphite composites as buss bars. Currently, buss bars of these batteries are made of lead, a material that is problematic for several reasons. Over time, the lead is subject to both corrosion at the positive plate and sulfation at the negative plate, resulting in decreased battery life. In addition, the weight and size of the lead buss bars make for a heavy and cumbersome battery that is undesirable. Functionality and practicality of lead buss bars is adequate at best; consequently, investigation of more efficient composite materials would be advantageous.

Practically speaking, graphite composites have a low density that is nearly one fourth that of its lead counterpart. A battery made of less dense materials would be more attractive to the consumer and the producer because it would be light and convenient. More importantly, low weight would be especially beneficial because it would result in greater overall power density of the battery. In addition to power density, use of graphite composite materials can also increase the life of the battery. From a functional standpoint, corrosion and sulfation at the positive and negative plates are major obstacles when considering how to extend battery life. Neither of these reactions are a factor when graphite composites replace lead parts because graphite is chemically non-reactive with the electrolyte within the battery. Without the problem of corrosion or sulfation, battery life expectancy can be almost doubled. The replacement of lead battery parts with composite materials is also more environmentally favorable because of easy disposal of organic materials.

For this study, both pristine and bromine intercalated single-ply graphite fiber composites were created. The composites were fabricated in such a way as to facilitate their use in a 3"x 1/2" buss bar test cell. The prime objective of this investigation was to examine the effectiveness of a variety of graphite composite materials to act as buss bars and carry the current to and from the positive and negative battery plates. This energy transfer can be maximized by use of materials with high conductivity to minimize the buss resistance. Electrical conductivity of composites was measured using both a contactless eddy current probe and a four point measurement. In addition, the stability of these materials at battery-use conditions was characterized.

## **MANUFACTURING BMS/ISO SYSTEM REVIEW**

**Yazmín Gómez**  
University of Turabo  
Industrial and Management Engineering  
Undergraduate, Senior  
**Mentor: Wilma J. Taylor**

### **ABSTRACT**

The Quality Management System (QMS) is one that recognizes the need to continuously change and improve an organization's products and services as determined by system feedback, and corresponding management decisions. The purpose of a Quality Management System is to minimize quality variability of an organization's products and services. The optimal Quality Management System balances the need for an organization to maintain flexibility in the products and services it provides with the need for providing the appropriate level of discipline and control over the processes used to provide them. The goal of a Quality Management System is to ensure the quality of the products and services while consistently (through minimizing quality variability) meeting or exceeding customer expectations.

The GRC Business Management System (BMS) is the foundation of the Center's ISO 9001:2000 registered quality system. ISO 9001 is a quality system model developed by the International Organization for Standardization. BMS supports and promote the Glenn Research Center Quality Policy and wants to ensure the customer satisfaction while also meeting quality standards.

My assignment during this summer is to examine the manufacturing processes used to develop research hardware, which in most cases are one of a kind hardware, made with non conventional equipment and materials. During this process of observation I will make a determination, based on my observations of the hardware development processes the best way to meet customer requirements and at the same time achieve the GRC quality standards.

The purpose of my task is to review the manufacturing processes identifying opportunities in which to optimize the efficiency of the processes and establish a plan for implementation and continuous improvement.

## FLYWHEEL TECHNOLOGY

**Lisa M. Ritchie**  
Kent State University  
Integrated Mathematics  
Undergraduate, Junior  
**Mentor: Vicki J. Crable**

### ABSTRACT

Throughout the summer of 2004, I am working on a number of different projects. While located in the Space Power and Propulsion Test Engineering branch, my main area of study is flywheel technology. I have been exposed to flywheels, their components, and their uses in today's society. I have been able to experience numerous flywheels here in the flywheel lab at NASA Glenn.

My first main project was to explore the attributes and physical characteristics of a flywheel. Our branch was constructing a flywheel demonstration to be presented at the public open house taking place in June. Our Flywheel Interactive Demo, or FIDO, represents a real life multi-flywheel system here at NASA. I was given the opportunity to learn about how these flywheels store energy and are able to position a satellite. With all of this new knowledge, I was able to create the posters that explained how our demonstration worked. I also composed a step-by-step process made up of four experiments that any visitor could follow and perform on FIDO. By stepping through these experiments, the individual learns how a flywheel works. They not only read the explanation of what is happening, but they are also able to see it happen. Creating these two posters not only taught me, but also helped teach the general public during the open house, how flywheel technology is a very important part of our future.

Through my research, I have learned that flywheels are able to store massive amounts of energy. They can be described as an electro-mechanical battery that stores kinetic energy while rotating. The faster it rotates, the more energy it stores. Their lifetime is about triple that of an ordinary battery. Flywheels also have the ability to combine energy storage with attitude control all in a single system. Attitude control is the ability to position a satellite as required. FIDO helps us to understand the rotational force (torque) that is applied upon a turntable or satellite during wheel acceleration/deceleration.

My other main project that I have just begun is to create a flywheel presentation, brochure, and video all explaining the history, applications, early attempts, and working processes of modern flywheels. These items are all useful tools for educating school children and even adults about flywheels. This task will require a large amount of research and skills in the use of multiple applications.

My goal this summer is to learn the dynamics and uses of a flywheel in today's society, and then inform and encourage the public about flywheels. I am able to express my knowledge by creating some effective as well as attractive posters, presentations, brochures, videos, etc. that are able to explain how a flywheel works along with how our FIDO demonstration simulates a real flywheel. My goal is underway, and should be successfully reached with the help of my mentor, other coworkers, and fellow interns.

# Trajectory Analysis

Laura M. Burke  
Case Western Reserve University  
Aerospace Engineering  
Undergraduate, Junior  
Mentor: Robert D. Falck

## ABSTRACT

The Systems Analysis Branch performs trajectory and systems analysis for next-generation launch vehicle and space transportation technologies. Currently the branch is supporting the Project Prometheus with analysis of nuclear electric and nuclear thermal propulsion missions to a variety of destinations. Within Project Prometheus a proposed mission to Jupiter and three of the planet sized icy moons that orbit it is developing. The Jupiter Icy Moons Orbiter (JIMO) as the project is being called will enable detailed scientific investigation of Jupiter's moons Callisto, Ganymede, and Europa. These moons were chosen to orbit for intensive study in particular because they are each believed to have water, energy, and organic material. The JIMO mission will utilize nuclear fission power and electric propulsion in order to allow the spacecraft to orbit the moons at close range for long durations of time.

My assignment this summer was to assist in developing a trajectory analysis for the spacecraft system the Jupiter Icy Moons Orbiter by rewriting an inefficient Excel file into a more efficient FORTRAN program. This program has been created for use planning the trajectory of the Jupiter Icy Moons Orbiter Mission. The program uses a database of thousands of data points representing flight time, burn time, thrust, mass of the propellant used, final mass of the spacecraft, ratio of final mass to initial mass, and change in velocity that a spacecraft experiences during each phase in the Jupiter Icy Moons Orbiter Mission. The trajectory program is capable of taking a specific user entered specific impulse (isp), final mass fraction, and thrust ( $P_f/m_0$ ) and through the use of cubic splines to fit specific data curves, the program can locate the exact flight time linked to the user specified values of specific impulse and final over initial mass fraction.

Currently, the database used by the program to calculate flight times for a given thrust is only for isps in the range of 2000 to 9000 seconds. Although the program is specific to the Jupiter Icy Moons Orbiter mission, it can be easily modified to fit any mission with a propulsion system expected isp range between 2000 and 9000 seconds.

This program performs the same tasks as the old Excel file but in a more timely fashion. Finally, this FORTRAN program will replace the Excel file as the tool used to calculate trajectory properties in missions and will provide valuable data to mission analysts for years to come.

## Website of the Systems and Analysis Branch Supported Projects and Graph Analysis

**Corinne Kellerman**  
University of Arizona  
Astronomy and Physics  
Undergraduate, Sophomore  
**Mentor: Melissa L. McGuire**

### ABSTRACT

Throughout the past few weeks I have learned a great amount of information about many interesting aspects that go on here at NASA Glenn Research Center Branch 7820. Branch 7820 is the Systems and Analysis Branch. The people involved in this Branch deal with in a nutshell the analysis of propulsion systems for Earth to orbit and space transportation systems.

The first project that I had worked on was helping my mentor learn more about lunar geography and the most recommended way to maintain communication for our future lunar missions. During this time I studied the craters of the moon, especially the South Pole, to provide her with information so that she can make decisions. I also researched to provide her with contact information on those people who are specialized in lunar geography so that she may talk to them to find out more in depth information.

Most of my time spent here has been helping to develop a comprehensive explanation and background of the different projects our Branch has supported. When I first came to NASA Glenn and started working with the 7820 Branch there website had many holes that needed to be filled in. I have spent numerous weeks researching information about topics such as Project Prometheus itself and one of its components Jupiter's Icy Moons Orbiter (JIMO). I have also done a large amount of research on propulsion systems and how different kinds work. I have learned many facts about Nuclear Electric Propulsion (NEP) all the way to Nuclear Thermal Propulsion (NTP) systems. I will continue to do this until all the holes are filled and find out about Global Integrated Design Environment (GLIDE) and Next Generation Launch technology (NGLT).

Since most of my job was providing information to go onto a website I had to learn how to put my information into a HTML format. I had no previous knowledge on how to do that kind of task and had to study how to do it and am now able to create a document in HTML format.

There has been reorganizing done here at NASA Glenn and our Branch was moved to another building. Therefore, our library had to be moved with us. I spent time helping to put together the boxes, pack the library, and label them accordingly. This was not an easy task but was an experience in itself. I was able to see old posters that NASA had produced about different space missions and look at Russian map of the US and books on space missions. I was also about to see what was in the library in terms of reference material helped because now I can make use of the information for my research on the website.

Throughout my internship my mentor will provide me with graphs to analyze and recreate so that she may use them to her advantage. I will learn from every piece of data that comes my way. Later, I will study and analysis gravity-loss for Earth departure trajectories. Since I haven't done that yet I cannot really describe what I will learn or what exactly the project entails. The whole experience has been great and I have no doubt that it will exceed every expectation previously thought.

## **Book Out! An Inventory Story.**

**Claudia M. Panait**  
George Washington University  
International Business  
Junior  
**Mentor: Susan Oberc**

### **Abstract**

The NASA Glenn Library is a science and engineering research library providing the most current books, journals, CD-ROM's and documents to support the study of aeronautics, space propulsion and power, communications technology, materials and structures and microgravity science. The GRC technical library also supports the research and development efforts of all scientists and engineers on site via full text electronic files, literature searching, technical reports, etc. As an intern in the NASA Glenn Library, I attempt to support these objectives through efficiently and effectively fulfilling the assignment that was given to me.

The assignment that was relegated to me was to catalog National Advisory Committee for Aeronautics, NASA Technical Documents into NASA Galaxie. This process consists of holdings being added to existing Galaxie records, upgrades and editing done to the bibliographic records when needed, adding URL's into Galaxie when they were missing from the record. NASA ASAP and Digidoc was used to locate URL's of PDF's that were not in Galaxie. A spreadsheet of documents with no URL's were maintained. Also, a subject channel of web, full-text, paid and free, journal and other subject specific pages were developed and expanded from current content of intranet pages.

To expand upon the second half of my assignment, I was given the project of taking inventory of the library's book collection. I kept record of the books that were not accounted for on a master list I was given to work from and submitted them for correction and addition. I also made sure the books were placed in the appropriate order and made corrections to any discrepancies that existed between the master list and what was on the shelf. Upon completion of this assignment, I will have verified that 21,113 books were in the correct location, order and have the correct corresponding serial number and barcode.

In conclusion, as of this date I have input around 750 documents into NASA Galaxie, inputting about half of the NASA Technical Documents into the system. The rest of my tenure in this program will consist of finishing the other half of the reports. In regard to the second assignment, I still have about three-quarters of the collection to record and correct.



# Research Symposium I

## Ohio Aerospace Institute

### Thursday, July 8, 2004

#### OAI Federal Room

9:00 A.M. **Kevin Speer, University of Arkansas, Masters**

"Quantification of 4H-to-3C-Polymorphism in Silicon Carbide (SiC) Epilayers and an Investigation of Recombination-Enhanced Dislocation Motion in SiC by Optical Emission Microscopy (OEM) Techniques"

5510/Philip Neudeck, Sensors and Electronics Technology Branch

9:15 **Jennifer Corrigan, University of Dayton, Senior**

"Finite Element Analysis of MEMS Devices"

5510/Robert Okojie, Sensors and Electronics Technology Branch

9:30 **Hilary Homenko, Stanford University, Freshman**

"Evaluation of Droplet Splashing Algorithm in LEWICE 3.0"

5840/Mark Potapczuk, Icing Branch

9:45 **Aaron Armstrong, Brigham Young University-Idaho, Senior**

"The Lewice Console"

5840/William Wright, Icing Branch

10:00 **Nicholas Mattei, University of Kentucky, Junior**

"Evaluation of Open-Source Hard Real Time Software Packages"

8100/Cynthia Calhoun, Risk Management Office

10:15 **Kalindra Mcrae, Fayetteville State University, Junior**

"Software Quality Assurance Metrics"

8100/Cynthia Calhoun, Risk Management Office

10:30 **Tracee Jordan, Tennessee State University, Freshman**

"Monitoring and Testing the Parts Cleaning Stations, Abrasive Blasting Cabinets, and Paint Booths"

8400/Danielle Griffin, Environmental Management Office

10:45 **Nathaniel Bewley, Cuyahoga Community College-West Campus, Sophomore**

"Security Management and Safeguards Office"

8500/Richard Soppet, Security Management and Safegaurds Office

11:00 **LUNCH**

1:00 **Nicole Epps, Spelman College, Sophomore**

"Constructing an Educational Mars Simulation"

9200/William Dedula, Educational Programs Office

1:15 **Stephen Henke, Lorain County Community College, Sophomore**

"Constructing an Educational Mars Simulation"

9200/William Dedula, Educational Programs Office

**1:30 Debra Goodenow, Ohio Northern University, Senior**

**“Model of a Piezoelectric Transducer”**

7715/Richard Oeftering, Instrumentation and Data Systems Branch

**1:45 Keith Blackwell, Cleveland State University, Junior**

**“Adaptive Clearance Control Systems for Turbine Engines”**

5530/Kevin Melcher, Controls and Dynamics Technology Branch

**2:00 ADJOURN**



**QUANTIFICATION OF 4H- TO 3C-POLYMORPHISM IN SILICON CARBIDE (SiC)  
EPILAYERS AND AN INVESTIGATION OF RECOMBINATION-  
ENHANCED DISLOCATION MOTION IN SiC BY OPTICAL  
EMISSION MICROSCOPY (OEM) TECHNIQUES**

**Kevin M. Speer**

Case Western Reserve University  
Materials Science & Engineering  
Ph.D. Student

**Mentor: Philip G. Neudeck, Ph.D.**

**ABSTRACT**

Environments that impose operational constraints on conventional silicon-(Si) based semiconductor devices frequently appear in military- and space-grade applications. These constraints include high temperature, high power, and high radiation environments. Silicon carbide (SiC), an alternative type of semiconductor material, has received abundant research attention in the past few years, owing to its radiation-hardened properties as well as its capability to withstand high temperatures and power levels. However, the growth and manufacture of SiC devices is still comparatively immature, and there are severe limitations in present crystal growth and device fabrication processes.

Among these limitations is a variety of crystal imperfections known as defects. These imperfections can be point defects (e.g., vacancies and interstitials), line defects (e.g., edge and screw dislocations), or planar defects (e.g., stacking faults and double-positioning boundaries). All of these defects have been experimentally shown to be detrimental to the performance of electron devices made from SiC. As such, it is imperative that these defects are significantly reduced in order for SiC devices to become a viable entity in the electronics world.

The NASA Glenn High Temperature Integrated Electronics & Sensors Team (HTIES) is working to identify and eliminate these defects in SiC by implementing improved epitaxial crystal growth procedures. HTIES takes two-inch SiC wafers and etches patterns, producing thousands of mesas into each wafer. Crystal growth is then carried out on top of these mesas in an effort to produce films of improved quality—resulting in electron devices that demonstrate superior performance—as well as fabrication processes that are cost-effective, reliable, and reproducible.

In this work, further steps are taken to automate HTIES' SiC wafer inspection system. National Instruments™ LabVIEW® image processing and pattern recognition routines are developed that are capable of quantifying and mapping defects on both the substrate and mesa surfaces, and of quantifying polymorphic changes in the grown materials. In addition, an optical emission microscopy (OEM) system is developed that will facilitate comprehensive study of recombination-enhanced dislocation motion (REDM).

# Finite Element Analysis of MEMS Devices

Jennifer Corrigan

L.E.R.C.I.P. Summer 2004

Mentor: Dr. Robert Okojie

18 June 2004

A side-slide actuator and a corrugated diaphragm actuator will be analyzed and optimized this summer. Coupled electrostatic and fluid analyses will also be initiated. Both the side-slide actuator and the corrugated diaphragm actuator will be used to regulate the flow of fuel in a jet engine. Many of the side-slide actuators will be placed on top of a fuel injector that is still in the developmental stage as well. The corrugated diaphragm actuator will also be used to regulate the flow of fuel in fuel injectors. A comparative analysis of the performance matrix of both actuators will be conducted.

The side-slide actuator uses the concept of mechanical advantage to regulate the flow of fuel using electrostatic forces. It is made from Nickel, Silicon Carbide, and thin layers of Oxide. The slider will have a hole in the middle that will allow fuel to pass through the hole underneath it. The goal is to regulate the flow of fuel through the inlet. This means that the actuator needs to be designed so that when a voltage is applied to the push rod, the slider will deflect in the x-direction and be able to completely block the inlet and no fuel can pass through. Different voltage levels will be tested. The parameters that are being optimized are the thickness of the diaphragm, what kind of corrugation the diaphragm should have, the length, width, and thickness of the push rod, and what design should be used to return the slider. The current possibilities for a return rod are a built in spring on the slider, a return rod that acts like a spring, or a return rod that is identical to the push rod. The final actuator design should have a push rod that has rotational motion and no translation motion, a push rod thickness that prevents warping due to the slider, and a large ratio of the displacement on the bottom of the push rod to displacement on the top of the push rod.

The corrugated diaphragm actuator was optimized last winter and this summer will be spent completing the optimization of the coupled electrostatic and fluid flow parameters. It was found that Nickel is the best material to use for the diaphragm because it has a higher yield strength and allows for a larger stress, deflection and applied pressure. The parameters that were optimized were the wavelength and thickness of the diaphragm.

## **Evaluation of Droplet Splashing Algorithm in LEWICE 3.0**

**Hilary N. Homenko**  
Stanford University  
Science, Technology and Society  
Undergraduate, Freshman  
**Mentor: Mark Potapczuk**

### **ABSTRACT**

The Icing Branch at NASA Glenn Research has developed a computer program to simulate ice formation on the leading edge of an aircraft wing during flight through cold, moist air. As part of the branch's current research, members have developed software known as LEWICE. This program is capable of predicting the formation of ice under designated weather conditions. The success of LEWICE is an asset to airplane manufacturers, ice protection system manufacturers, and the airline industry. Simulations of ice formation conducted in the tunnel and in flight is costly and time consuming. However, the danger of in-flight icing continues to be a concern for both commercial and military pilots. The LEWICE software is a step towards inexpensive and time efficient prediction of ice collection.

In the most recent version of the program, LEWICE contains an algorithm for droplet splashing. Droplet splashing is a natural occurrence that causes accumulation of ice on aircraft surfaces. At impingement water droplets lose a portion of their mass to splashing. With part of each droplet joining the airflow and failing to freeze, early versions of LEWICE without the splashing algorithm over-predicted the collection of ice on the leading edge.

The objective of my project was to determine whether the revised version of LEWICE accurately reflected the ice collection data obtained from the Icing Research Tunnel (IRT). The experimental data from the IRT was collected by Mark Potapczuk in January, March and July of 2001 and April and December of 2002. Experimental data points were the result of ice tracings conducted shortly after testing in the tunnel. Run sheets, which included a record of velocity, temperature, liquid water content and droplet diameter, served as the input of the LEWICE computer program. Parameters identical to the tunnel conditions were used to run LEWICE 2.0 and LEWICE 3.0.

The results from IRT and versions of LEWICE were compared graphically. After entering the raw experimental data and computer output into a spread sheet, I mapped each ice formation onto a clean airfoil. The LEWICE output provided the data points to graphically depict ice formations developed by the program.

After comparing the collection efficiency, mass values and ice shapes produced by weather conditions of runs conducted in January 2001, it was evident that the splashing algorithm of LEWICE 3.0 predicts ice formations more accurately than LEWICE 2.0. Especially at conditions with droplet size between 80 and 160 microns, the splashing algorithm of the new LEWICE version compensated for the loss of droplet mass as a result of splashing. In contrast, LEWICE 2.0 consistently over-predicted the mass of the ice in conditions with droplet size exceeding 80 microns. This evidence confirms that changes made to algorithms of LEWICE 3.0 have increased the accuracy of predicting ice collection.

## **The Lewice Console**

**Aaron E. Armstrong**  
Brigham Young University-Idaho  
Computer Science  
Senior  
**Mentor: William B. Wright**

### **ABSTRACT**

Lewice (LEWIS ICE accretion program) is software used by literally hundreds of users in the aeronautics community for predicting ice shapes, collection efficiencies, and anti-icing heat requirements for aircraft. LEWICE performs its analysis in minutes on a desktop PC, allowing the user to run several parameter studies for design purposes. The ice shape predictions have been used to assess performance degradation both as an input to a CFD program or experimentally in flight or in a wind tunnel. This information is important to ensure an airplane's safe passage through an icing cloud.

Currently, Lewice runs as a DOS program that accepts many different inputs such as cloud conditions, wing shapes, and thermal deicing inputs. Usually, such experimental data is stored in spreadsheets. However, Lewice inputs are text files; therefore, they must be generated by the user. Lewice's outputs (collection efficiency, ice shapes and thicknesses) are also text files; to plot the data, users must generate a spreadsheet with this output. Because all Lewice I/O is in the form of text files, using Lewice can be tricky and time-consuming.

Our goal was to improve Lewice's usability by creating a user interface that would automatically generate Lewice input from a spreadsheet and automatically put Lewice output into spreadsheets with charts. Additionally, this user interface would automatically convert units (as Lewice only accepts input in certain units) and offer several output options. I call this program the "Lewice Console".

The Lewice Console is an easy to use interface for Lewice written in Visual Basic. It allows users to run Lewice given a spreadsheet listing experimental conditions. It automatically generates the input to Lewice, does necessary unit conversions, runs Lewice, and produces a spreadsheet with charts plotting the data. It allows users to import data from previously generated Lewice inputs into a spreadsheet. It also allows users to batch run Lewice on several different inputs to automatically generate multiple output spreadsheets. You can also generate plots of actual data vs. experimental data.

These capabilities are just the beginning for the Lewice Console. Lewice is capable of running a full deicing experiment given a geometry and heating apparatus information. However, users find it difficult to run such experiments due to the number of inputs and the difficult input file format. The Lewice Console would simplify experiment generation by allowing the user to interactively draw a geometry, place heating apparatus, and specify information about each part. The input to Lewice would be automatically generated from the experiment the user draws on the screen. The Lewice Console would simplify the experiment building process.

## **Evaluation of Open-Source Hard Real Time Software Packages**

**Nicholas S. Mattei**  
University of Kentucky  
Computer Science and Electrical Engineering  
Undergraduate, Junior  
**Mentor: Cynthia Calhoun**

### **ABSTRACT**

Reliable software is, at times, hard to find. No piece of software can be guaranteed to work in every situation that may arise during its use here at Glenn Research Center or in space. The job of the Software Assurance (SA) group in the Risk Management Office is to rigorously test the software in an effort to ensure it matches the contract specifications. In some cases the SA team also researches new alternatives for selected software packages. This testing and research is an integral part of the department of Safety and Mission Assurance.

Real Time operation in reference to a computer system is a particular style of handing the timing and manner with which inputs and outputs are handled. A real time system executes these commands and appropriate processing within a defined timing constraint. Within this definition there are two other classifications of real time systems: hard and soft. A soft real time system is one in which if the particular timing constraints are not rigidly met there will be no critical results. On the other hand, a hard real time system is one in which if the timing constraints are not met the results could be catastrophic. An example of a soft real time system is a DVD decoder. If the particular piece of data from the input is not decoded and displayed to the screen at exactly the correct moment nothing critical will become of it, the user may not even notice it. However, a hard real time system is needed to control the timing of fuel injections or steering on the Space Shuttle; a delay of even a fraction of a second could be catastrophic in such a complex system.

The current real time system employed by most NASA projects is Wind River's VxWorks operating system. This is a proprietary operating system that can be configured to work with many of NASA's needs and it provides very accurate and reliable hard real time performance. The down side is that since it is a proprietary operating system it is also costly to implement. The prospect of replacing this somewhat costly implementation is the focus of one of the SA group's current research projects. The explosion of open source software in the last ten years has led to the development of a multitude of software solutions which were once only produced by major corporations. The benefits of these open projects include faster release and bug patching cycles as well as inexpensive if not free software solutions. The main packages for hard real time solutions under Linux are Real Time Application Interface (RTAI) and two varieties of Real Time Linux (RTL), RTLFree and RTLPro.

During my time here at NASA I have been testing various hard real time solutions operating as layers on the Linux Operating System. All testing is being run on an Intel SBC 2590 which is a common embedded hardware platform. The test plan was provided to me by the Software Assurance group at the start of my internship and my job has been to test the systems by developing and executing the test cases on the hardware. These tests are constructed so that the Software Assurance group can get hard test data for a comparison between the open source and proprietary implementations of hard real time solutions.

## **Software Quality Assurance Metrics**

**Kalindra A. McRae**  
Fayetteville State University  
Computer Science  
Undergraduate Senior  
**Mentor: Cynthia Calhoun**

### **ABSTRACT**

Software Quality Assurance (SQA) is a planned and systematic set of activities that ensures conformance of software life cycle processes and products conform to requirements, standards and procedures. In software development, software quality means meeting requirements and a degree of excellence and refinement of a project or product. Software Quality is a set of attributes of a software product by which its quality is described and evaluated. The set of attributes includes functionality, reliability, usability, efficiency, maintainability, and portability. Software Metrics help us understand the technical process that is used to develop a product. The process is measured to improve it and the product is measured to increase quality throughout the life cycle of software. Software Metrics are measurements of the quality of software. Software is measured to indicate the quality of the product, to assess the productivity of the people who produce the product, to assess the benefits derived from new software engineering methods and tools, to form a baseline for estimation, and to help justify requests for new tools or additional training. Any part of the software development can be measured. If Software Metrics are implemented in software development, it can save time, money, and allow the organization to identify the caused of defects which have the greatest effect on software development.

The summer of 2004, I worked with Cynthia Calhoun and Frank Robinson in the Software Assurance/Risk Management department. My task was to research and collect, compile, and analyze SQA Metrics that have been used in other projects that are not currently being used by the SA team and report them to the Software Assurance team to see if any metrics can be implemented in their software assurance life cycle process.



**MONITORING AND TESTING THE PARTS CLEANING STATIONS,  
ABRASIVE BLASTING CABINETS, AND PAINT BOOTHS**

**Tracee M. Jordan**

Tennessee State University  
Civil and Environmental Engineering

Sophomore

**Mentor: Priscilla A. Mobley**

**ABSTRACT**

I have the opportunity to work in the Environmental Management Office (EMO) this summer. One of the EMO's tasks is to make sure the Environmental Management System is implemented to the entire Glenn Research Center (GRC). The Environmental Management System (EMS) is a policy or plan that is oriented toward minimizing an organization's impact to the environment. Our EMS includes the reduction of solid waste regeneration and the reduction of hazardous material use, waste, and pollution. With the Waste Management Team's (WMT) help, the EMS can be implemented throughout the NASA Glenn Research Center. The WMT is responsible for the disposal and managing of waste throughout the GRC. They are also responsible for the management of all chemical waste in the facility. My responsibility is to support the waste management team by performing an inventory on parts cleaning stations, abrasive cabinets, and paint booths through out the entire facility. These booths/stations are used throughout the center and they need to be monitored and tested for hazardous waste and material. My job is to visit each of these booths/stations, take samples of the waste, and analyze the samples.

## **Security Management and Safeguards Office**

**Nathaniel M. Bewley**  
Cuyahoga Community College  
Criminal Justice  
Undergraduate Sophomore  
**Mentor: Richard Soppet**

### **Abstract**

The Security Management and Safeguards Office at NASA is here to keep the people working in a safe environment. They also are here to protect the buildings and documents from sabotage, espionage, and theft. During the summer of 2004, I worked with Richard Soppet in Physical Security.

While I was working here I helped out with updating the map that we currently use at NASA Glenn Research Center, attended meetings for homeland security, worked with the security guards and the locksmith. The meetings that I attended for homeland security talked about how to protect ourselves before something happened, they told us to always be on the guard and look for anything suspicious, and the different ways that terrorist groups operate. When I was with the security guards I was taught how to check someone into the base, showed how to use a radar gun, observed a security guard make a traffic stop for training and was with them while they patrolled NASA Glenn Research Center to make sure things were running smooth and no one was in danger. When I was with the lock smith I was taught how to make keys and locks for the employees here at NASA. The lock smith also showed me that he had inventory cabinets of files that show how many keys were out to people and who currently has access to the rooms that they keys were made for.

I also helped out the open house at NASA Glenn Research Center. I helped out by showing the Army Reserves, and Brook Park's SWAT team where all the main events were going to take place a week before the open house was going to begin. Then during the open house I helped out by making sure people had there IDs, checked through there bags, and handed out a map to them that showed where the different activities were going to take place.

So the main job here at NASA Glenn Research Center for the Security Management and Safeguards Office is to make sure that nothing is stolen, sabotaged, and espionaged. Also most importantly make sure all the employees here at NASA are in a safe environment.

# CONSTRUCTING AN EDUCATIONAL MARS SIMULATION

**Nicole E. Epps**

Spelman College

Computer Science

Junior

Mentor: William T. Dedula

## ABSTRACT

Working in the Educational Programs Office, my task this summer is to model a 3D habitat that will be part of a future Mars base. With the President's charge to further explore Mars by way of robotic-led and human-led missions, there has been a surge in the activity regarding the "red planet". Since all present designs are merely conjecture, I have some creative freedom in deciding what the habitat will look like.

To get ideas for what a Mars habitat might be like, I looked at several references including websites and NASA documents. One of these was a NASA Technical Memorandum about Space Transportation Systems that I looked at to get insight on spaceship design. Information about the planet's environment, such as the gravity and the weather, is useful as well when designing the structure.

The main software that I am using is Lightwave 3D 7.5 and Modeler 7.5 that comes along with it. Lightwave is very complex in that it lets you model, surface, and animate so there was a lot to learn. To learn the software I watched a series of instructional videos, looked at online tutorials, and referenced several books. Modeling is like shaping clay with a computer. Every item modeled is made of smaller shapes called polygons. For example, each side of a box would be a different polygon. Modelers must be careful to design with users' systems in mind. Having a model made with too many polygons can slow down a walk-through, but it usually improves the small details on a model. Getting speed *and* quality proved tricky.

An important thing for me to remember when modeling the habitat was to save space. Also, I must consider that technology in the future will be much different than now, so I must be especially creative. My project will be used in an educational walk-through simulation in which users can interact with the environment. I worked closely with intern Stephen Henke who built a Mars Rover, terrain and programmed code for the simulation. This summer's project will help me with future aspirations in computer graphics. Modeling is a valuable skill that I appreciate having the chance to learn and practice.

# Constructing an Educational Mars Simulation

**Stephen A. Henke**

LCCC / University of Toledo Partnership

Computer Science Engineering (CSE)

Undergraduate

Mentor: **William Dedula**

Abstract

January 14<sup>th</sup> 2004, President George Bush announces his plans to catalyze the space program into a new era of space exploration and discovery. His vision encompasses a robotics program to explore our solar system, a return to the moon, the human exploration of Mars, and to promote international prosperity towards our endeavors. We at NASA now have the task of constructing this vision in a very real timeframe.

I have been chosen to begin phase 1 of making this vision a reality. I will be working on creating an Educational Mars Simulation of human exploration of Mars to stimulate interest and involvement with the project from investors and the community. GRC's Computer Services Division (CSD) in collaboration with the Office of Education Programs will be designing models, constructing terrain, and programming this simulation to create a realistic portrayal of human exploration on Mars.

With recent and past technological breakthroughs in computing, my primary goal can be accomplished with only the aid of 3-4 software packages. Lightwave 3D is the modeling package we have selected to use for the creation of our digital objects. This includes a Mars pressurized rover, rover cockpit, landscape/terrain, and habitat. Once we have the models completed they need to be textured so Photoshop and Macromedia Fireworks are handy for bringing these objects to life. Before directly importing all of this data into a simulation environment, it is necessary to first render a stunning animation of the desired final product. This animation will represent what we hope to capture out of the simulation and it will include all of the accessories like ray-tracing, fog effects, shadows, anti-aliasing, particle effects, volumetric lighting, and lens flares. Adobe Premier will more than likely be used for video editing and adding ambient noises and music.

Lastly, V-Tree is the real-time 3D graphics engine which will facilitate our realistic simulation. Using V-Tree template libraries and Microsoft Visual Studio 6, I hope to take all of our summer work and construct an interactive scene. The final program will be controlled from a flight box or computer joystick and run on the Vision Station (Vision Domes). The simulation testers will get a first hand feel for the system by trying to navigate the rover safely through the labyrinth of the Mars surface. The final program will be a great realistic success and discovery.

## **Model of a Piezoelectric Transducer**

Debra Goodenow  
Ohio Northern University  
Electrical Engineering  
Senior  
**Mentor: Rich Oeftering**

### **ABSTRACT**

It's difficult to control liquid and gas in propellant tanks in zero gravity. A possible design would utilize acoustic liquid manipulation (ALM) technology which uses ultrasonic beams conducted through a liquid and solid media, to push gas bubbles in the liquid to desirable locations. We can propel and control the bubble with acoustic radiation pressure by aiming the acoustic waves on the bubble's surface. This allows us to design a so called "smart tank" in which the ALM devices transfer the gas to the outer wall of the tank and isolating the liquid in the center. Because the heat transfer rate of a gas is lower of that of the liquid it would substantially decrease boil off and provide of for a longer storage life.

The ALM the beam is composed of little "wavelets" which are individual waves that constructively interfere with each other to produce a single, combined acoustic wave front. This is accomplished by using a set of synchronized ultrasound transducers arranged in an array. A slight phase offset of these elements allows us to focus and steer the beam.

The device that we are using to produce the acoustic beam is called the piezoelectric transducer. This device converts electrical energy to mechanical energy, which appears in the form of acoustic energy. Therefore the behavior of the device is dependent on both the mechanical characteristics, such as its density, cross-sectional area, and its electrical characteristics, such as, electric flux permittivity and coupling factor. These devices can also be set up in a number of modes which are determined by the way the piezoelectric device is arranged, and the shape of the transducer. For this application we are using the longitudinal or thickness mode for our operation. The transducer also vibrates in the lateral mode, and one of the goals of my project is to decrease the amount of energy lost to the lateral mode.

To model the behavior of the transducers I will be using Pspice, electric circuit modeling tool, to determine the transducer's electrical characteristics at the frequency of interest. This will also help me determine the characteristics of an impedance matching network to operate the transducer at its optimum efficiency. For this I will use ABMs (analog behavioral modeling) to model dependent current and voltage sources that represent the transducer. I have also been working on the Labview control software for the phased array used to control the bubbles, and will begin testing on that before the end of my internship.

## ADAPTIVE CLEARANCE CONTROL SYSTEMS FOR TURBINE ENGINES

**Keith M. Blackwell**  
Cleveland State University  
Electrical Engineering  
Undergraduate, Junior  
**Mentor: Kevin J Melcher**

The Controls and Dynamics Technology Branch at NASA Glenn Research Center primarily deals in developing controls, dynamic models, and health management technologies for air and space propulsion systems. During the summer of 2004 I was granted the privilege of working alongside professionals who were developing an active clearance control system for commercial jet engines. Clearance, the gap between the turbine blade tip and the encompassing shroud, increases as a result of wear mechanisms and rubbing of the turbine blades on shroud. Increases in clearance cause larger specific fuel consumption (SFC) and loss of efficient air flow. This occurs because, as clearances increase, the engine must run hotter and burn more fuel to achieve the same thrust. In order to maintain efficiency, reduce fuel burn, and reduce exhaust gas temperature (EGT), the clearance must be accurately controlled to gap sizes no greater than a few hundredths of an inch. To address this problem, NASA Glenn researchers have developed a basic control system with actuators and sensors on each section of the shroud. Instead of having a large uniform metal casing, there would be sections of the shroud with individual sensors attached internally that would move slightly to reform and maintain clearance. The proposed method would ultimately save the airline industry millions of dollars.

As part of this research, it was my task to assist in the preliminary testing by updating the programs to simulate and control actual test rig conditions. Using the latest version of Labview, I had to revise a time-based program that would accurately record the feedback from an actuator and the signal read by the position sensor in terms of displacement, velocity, and acceleration. Once the foundation for the program had been laid to precision with the initial variables to be defined under *user specified* conditions, I had to integrate additional factors such as the engine temperature and pressure in order to fully apply actual test conditions.

A couple engineers and I had to make subtle changes before we ran the preparatory test rig several times to ensure that both the program and the connected components were ready for the actual test. Accordingly, we used a capacitive sensor in place of an encoder which correlated well with my course studies in electrical engineering because sensors of this type can determine displacement based on the amount of voltage. With air as the dielectric, larger voltages would suggest a closer position of the two charged plates. Similarly we used a vertically positioned stepper motor in place of an actuator and loaded the motor with weights to simulate the pressure force on the turbine shroud.

Through this experience I learned that not all research has to be conducted with the actual experimental hardware, but that there are other ways (experimental and analytical) to simulate dynamic systems. Also, I was able to get a glimpse into the work of controls engineers which will help me decide my specific area of electrical engineering.

**Research Symposium II**  
**Ohio Aerospace Institute**  
**Wednesday, August 4, 2004**

**OAI Federal Room**

9:00 A.M. **Christopher Macisco, Ohio State University, Junior**

“The Office of Inspector General (OIG)”

0160/Donald Catanzarito, Office of the Inspector General

9:15 **Daniel Kascak, Ohio University, Senior**

“High Power Density Motors”

0300/Jerry Montague, Vehicle Technology Directorate

9:30 **Melissa Johnson, Howard University, Freshman**

“The Training Process of the Organization Development and Training Office”

0480/Nola Bland, Organization Development and Training Office

9:45 **David Miller, Shaw University, Masters**

“JDD, Inc. Database”

0620/Devan Anderson, Logistics and Technical Information Division

10:00 **Michael Simpson, Georgia Tech, Masters**

“Modeling and Analysis of a Regenerative Fuel Cell Propulsion System for a High Altitude Long Endurance UAV”

2400/Joshua Freed, Propulsion Systems Analysis Office

10:15 **Jeffrey Bender, Penn State University, Senior**

“Increasing the Thermal Stability of Aluminum Titanate for Solid Oxide Fuel Cell Anodes”

5130/Mrityunjay Singh, Ceramics Branch

10:30 **Amanda Ramsey, Lorain County Community College, Freshman**

“The Office of the Materials Division”

5100/Pamela Spinosi, Materials Division

10:45 **John Falsey, Cleveland State University, Senior**

“Microstructural Evaluation of Forging Parameters for Superalloy Disks”

5120/Tim Gabb, Advanced Metalics Branch

11:00 **LUNCH**

1:00 **Jonathan Fornuff and Matthew Cheplak, Georgia Tech, Masters**

“Property Variation and Life Prediction of Silicon-Carbide Ceramic Matrix Composites”

5130/Ajay Misra, Ceramics Branch and 5100/James DiCarlo, Materials Division

1:30 **Zachary Bogusz, Ithaca College, Junior**

“Syntheses and Chemosensory of Anthracene and Phenanthrene Bisimide Derivatives”

5150/Michael Meador, Polymers Branch

1:45 **George Cater, University of Michigan, Sophomore**

“Epoxy Adhesives for Stator Magnet Assembly in Stirling Radioisotope Generators (SRG)”

5150/Euy-Sik Shin, Polymers Branch

**2:00 Emily Berkeley, Johns Hopkins University, Junior**

**“Lithium Polymer Electrolytes and Solid State NMR”**

5160/Mary Ann Meador, Environmental Durability Branch

**2:15 Marissa Reigel, Colorado School of Mines, Senior**

**“Cyclic Oxidation of High-Temperature Alloy Wires in Air”**

5160/Elizabeth Opila, Environmental Durability Branch

**2:30 Daniel Hauser, Ohio University, Junior**

**“Thermal characteristics of Lithium-ion batteries”**

5420/Thomas Miller, Electrochemistry Branch

**2:45 Francisco Ortiz, Florida Agricultural and Mechanical University, Masters**

**“A Study of Penalty Function Methods for Constraint Handling with Genetic Algorithm”**

5920/Pappu Murthy, Life Prediction Branch

**3:00 Jonathan Lorig, University of Illinois, Masters**

**“Library Services Funding Assessment”**

0620/Susan Oberc, Logistics and Technical Information Division

**3:15 ADJOURN**



The Office of Inspector General (OIG)

Christopher A. Macisco  
The Ohio State University  
World Economy and Business  
Junior  
Mentor: Donald L. Catanzarito

ABSTRACT

The NASA Office of Inspector General is the Federal Law Enforcement Agency at NASA which conducts criminal and regulatory investigations in which NASA is a victim. The OIG prevents and detects crime, fraud, waste and abuse and assists NASA management in promoting economy, efficiency, and effectiveness in its programs and operations.

The IG organization is divided up into two separate disciplines, the Office of Investigations (OI) and the Office of Audits (OA). The investigations side deals with criminal Investigations, administrative investigations, and civil investigations. The Audits side deals with inspections and assessments as well as the Auditing of NASA Programs and Activities.

Our mission at the OIG is to conduct and supervise independent and objective audits and investigations relating to agency programs and operations; to promote economy, effectiveness and efficiency within the agency; to prevent and detect crime, fraud, waste and abuse in agency programs and operations; to review and make recommendations regarding existing and proposed legislation and regulations relating to agency programs and operations. We are also responsible for keeping the agency head and the Congress fully and currently informed of problems in agency programs and operations.

OI investigations primarily focus on violations of Federal laws. Some of these violations deal with False Claims, False Statements, Conspiracy, Theft, Computer Crime, Mail Fraud, the Procurement Integrity Act, the Anti-Kickback Act, as well as noncompliance with NASA Management Instructions, the Federal Acquisition Regulations (FAR), and the Code of Federal Regulations (CFR).

Most of the casework that is dealt with in our office is generated through "gum shoe work" or cases that we generate on our own. These cases can come from Law Enforcement Referrals, GIDEP Reports, EPIMS (NASA Quality System), Defense Contract Audit Agency, Newspaper Articles, and Confidential Information. In many cases, confidentiality is the biggest factor to informants coming forward. We are able to maintain confidentiality because the OI is independent of NASA Management and doesn't report to the Center Directors, therefore the informant's managers and supervisors are unaware of the informants actions. The only time when an informant's confidentiality may be compromised is when it is needed in a Court of Law and is released through a Judicial Court Order.

During my tenure here at the NASA OIG/OI at Glenn Research Center, I have been involved in many different tasks. They have ranged from updating Suspected Unapproved Parts case files to independently interviewing NASA employees to turn up general background information. The OI has the duty of informing NASA aeronautical safety managers of potential Nonconforming products. My mission is to compile a database of Nonconformance reports for distribution. The background information that I turn up from my interviews is then used to determine NASA's susceptibility to acceptance of unapproved parts.

## High Power Density Motors

Daniel J Kascak  
Ohio University  
Mechanical Engineering  
Senior

Mentor: Jerry Montague

### ABSTRACT

With the growing concerns of global warming, the need for pollution-free vehicles is ever increasing. Pollution-free flight is one of NASA's goals for the 21<sup>st</sup> Century. One method of approaching that goal is hydrogen-fueled aircraft that use fuel cells or turbo-generators to develop electric power that can drive electric motors that turn the aircraft's propulsive fans or propellers. Hydrogen fuel would likely be carried as a liquid, stored in tanks at its boiling point of 20.5 K (-422.5 F). Conventional electric motors, however, are far too heavy (for a given horsepower) to use on aircraft. Fortunately the liquid hydrogen fuel can provide essentially free refrigeration that can be used to cool the windings of motors before the hydrogen is used for fuel. Either High Temperature Superconductors (HTS) or high purity metals such as copper or aluminum may be used in the motor windings. Superconductors have essentially zero electrical resistance to steady current. The electrical resistance of high purity aluminum or copper near liquid hydrogen temperature can be 1/100<sup>th</sup> or less of the room temperature resistance. These conductors could provide higher motor efficiency than normal room-temperature motors achieve. But much more importantly, these conductors can carry ten to a hundred times more current than copper conductors do in normal motors operating at room temperature. This is a consequence of the low electrical resistance and of good heat transfer coefficients in boiling LH<sub>2</sub>. Thus the conductors can produce higher magnetic field strengths and consequently higher motor torque and power. Designs, analysis and actual cryogenic motor tests show that such cryogenic motors could produce three or more times as much power per unit weight as turbine engines can, whereas conventional motors produce only 1/5 as much power per weight as turbine engines.

This summer work has been done with Litz wire to maximize the current density. The current is limited by the amount of heat it generates. By increasing the heat transfer out of the wire, the wires can carry a larger current and therefore produce more force. This was done by increasing the surface area of the wire to allow more coolant to flow over it. Litz wire was used because it can carry high frequency current. It also can be deformed into configurations that would increase the surface area. The best configuration was determined by heat transfer and force plots that were generated using Maxwell 2D. Future work will be done by testing and measuring the thrust force produced by the wires in a magnetic field.

## **The Training Process of the Organization Development and Training Office**

**Melissa S. Johnson**

Howard University

Business Management

Undergraduate, Freshman

**Mentor: Nola L. Bland**

The Organization Development and Training Office provides training and development opportunities to employees at NASA Glenn Research Center, as a division of the Office of Human Resources and Workforce Planning. Center-wide required trainings, new employee trainings, workshops and career development programs are organized by the OD&TO staff. They also arrange all academic, non-academic, headquarters, fellowship and learning center sponsored courses. They also service organizations wishing to work more effectively by facilitating teambuilding exercises.

My mentor, Nola Bland, is responsible for secretarial training, undergraduate programs, Equal Opportunity programs and upward mobility programs such as the STEP and GO programs for administrative staff. In working with my mentor I am very involved with Cuyahoga Community College classes, mandatory supervisory training and administrative staff workshops.

My largest tasks are in the secretarial training category. The Supporting Organizations And Relationships workshop for administrative personnel, commonly known as SOAR, began last year and continued this summer with follow-up workshops. Months before a workshop or class is brought to Glenn, a need has to be realized. In this case, administrative staff did not feel they had an opportunity to receive relevant training and develop skills through teambuilding, networking and communication. A Statement of work is then created as several companies are contacted about providing the training. After the company best suited to meet the target group's needs is selected, the course is announced with an outline of all pertinent information. A reservation for a facility is made and applications or nominations, depending on the announcement's guidelines, are received from interested employees. Confirmations are sent to participants and final preparations are made but there are still several concluding steps. A training office staff member also assists the facilitator with setting up the facility and introducing the class. After the class, participants' evaluations are read and summarized to determine the effectiveness of the class and instructor.

In addition to the SOAR workshops, I have several projects and daily tasks to complete. Coding training applications, which require me to be familiar with Glenn's budgetary allocations and policies on training, is an ongoing process. It also requires verifying information reported by an employee via her C-478 form, more commonly known as the training application. I am also the point of contact for the Cuyahoga Community College Advising Sessions held here at NASA Glenn which involves coordinating counselors' visits with employees' schedules. Two databases had to be created. The first database holds information on administrative staff, and the other tracks supervisors' training histories.

Through these assignments I gained experience in Microsoft Access 2002 and spreadsheet creation, communicating with co-workers, and successfully facilitating a training to serve specific purposes. With trainings and evaluations to assess them, the Organization Development and Training Office can assure a quality product and continued customer satisfaction.

## **JDD, Inc. Database**

**David A. Miller Jr.**

Shaw University

Computer Science

Master Candidate

**Mentor: Devan Anderson**

### **ABSTRACT**

JDD Inc, is a maintenance and custodial contracting company whose mission is to provide their clients in the private and government sectors "quality construction, construction management and cleaning services in the most efficient and cost effective manners, (JDD, Inc. Mission Statement)." This company provides facilities support for Fort Riley in Fort Riley, Kansas and the NASA John H. Glenn Research Center at Lewis Field here in Cleveland, Ohio. JDD, Inc. is owned and operated by James Vaughn, who started as painter at NASA Glenn and has been working here for the past seventeen years.

This summer I worked under Devan Anderson, who is the safety manager for JDD Inc. in the Logistics and Technical Information Division at Glenn Research Center. The LTID provides all transportation, secretarial, security needs and contract management of these various services for the center. As a safety manager, my mentor provides Occupational Health and Safety Occupation (OSHA) compliance to all JDD, Inc. employees and handles all other issues (Environmental Protection Agency issues, workers compensation, safety and health training) involving to job safety.

My summer assignment was not as considered "groundbreaking research" like many other summer interns have done in the past, but it is just as important and beneficial to JDD, Inc. I initially created a database using a Microsoft Excel program to classify and categorize data pertaining to numerous safety training certification courses instructed by our safety manager during the course of the fiscal year. This early portion of the database consisted of only data (training field index, employees who were present at these training courses and who was absent) from the training certification courses. Once I completed this phase of the database, I decided to expand the database and add as many dimensions to it as possible. Throughout the last seven weeks, I have been compiling more data from day to day operations and been adding the information to the database. It now consists of seven different categories of data (carpet cleaning, forms, NASA Event Schedules, training certifications, wall and vent cleaning, work schedules, and miscellaneous) . I also did some field inspecting with the supervisors around the site and was present at all of the training certification courses that have been scheduled since June 2004. My future outlook for the JDD, Inc. database is to have all of company's information from future contract proposals, weekly inventory, to employee timesheets all in this same database.

# MODELLING AND ANALYSIS OF A REGENERATIVE FUEL CELL PROPULSION SYSTEM FOR A HIGH ALTITUDE LONG ENDURANCE UAV

**Mike B. Simpson**  
Georgia Institute of Technology  
Aerospace Engineering  
2<sup>nd</sup> Year Graduate Student  
**Mentor: Joshua Freeh**

## ABSTRACT

In the search to bridge current gaps in surveillance and communication technologies, a new type of aircraft is currently undergoing design. The idea of a High Altitude Long Endurance (HALE) aircraft is already a few decades old, but has only recently become realizable. A relay and collector of information at altitudes of 65,000 feet and higher could greatly improve standards of data exchange, homeland security, and research of the air, land and sea.

NASA, as a major force in propulsion research, is exploring methods of powering an autonomous aircraft for days, weeks, or even months without refueling. Such a task requires not only high energy density, but also the ability to make use of renewable energy sources to regenerate power.

Hydrogen is one of the most energy dense fuels available. Fuel cells make use of hydrogen by harnessing the energy released as it combines with oxygen to produce electricity and water. Fuel cells are envisioned to occupy future propulsion systems in cooperation with solar cells where the photovoltaic arrays harness sunlight into power which can electrolyze the water byproduct into reusable hydrogen and oxygen.

Modeling this type of system requires adequate assumptions of support hardware and daily transients in operation. The performance of a regenerative fuel cell propulsion system lies in the flight characteristics (altitude, density, temperature, latitude, etc.). Each subsystem is defined by many parameters which can be varied across wide ranges. Statistical and probabilistic analyses bring forward a wealth of information that can be utilized in the design process. This is necessary since the required technologies are relatively young and barely, if yet, capable.

Once the modeling is complete, a design space exploration of this highly constrained scenario can be utilized to find the optimal design. The model will become an interactive environment with which experiments and tests can be run. When linked to models of the airframe and drag polars, a complete vehicle will be available for simulation.

# INCREASING THE THERMAL STABILITY OF ALUMINUM TITANATE FOR SOLID OXIDE FUEL CELL ANODES

**Jeffrey B. Bender**

The Pennsylvania State University  
Materials Science and Engineering  
Senior

**Mentor: Stephen W. Sofie**

## ABSTRACT

Solid-oxide fuel cells (SOFCs) show great potential as a power source for future space exploration missions. Because SOFCs operate at temperatures significantly higher than other types of fuel cells, they can reach overall efficiencies of up to 60% and are able to utilize fossil fuels. The SOFC team at GRC is leading NASA's effort to develop a solid oxide fuel cell with a power density high enough to be used for aeronautics and space applications, which is approximately ten times higher than ground transport targets.

Every SOFC consists of a cathode and an anode separated by an electrolyte. These three layers must be able to operate as a single unit at temperatures upwards of 900°C for at least 40,000 hours with less than ten percent degradation. One key challenge to meeting this goal arises from the thermal expansion mismatch between different layers. The amount a material expands upon heating is expressed by its coefficient of thermal expansion (CTE). If the CTEs of adjacent layers are substantially different, thermal stresses will arise during the cell's fabrication and operation. These stresses, accompanied by thermal cycling, can fracture and destroy the cell. While this is not an issue at the electrolyte-cathode interface, it is a major concern at the electrolyte-anode interface, especially in high power anode-supported systems.

One way to avoid this problem is to design the cell such that the CTEs of the anode and electrolyte are nearly identical. Conventionally, this has been accomplished by varying the composition of the anode to match the CTE of the yttria-stabilized zirconia (YSZ) electrolyte ( $\sim 10.8 \times 10^{-6} / ^\circ\text{C}$ ). A Ni/YSZ composite is typically used as a base material for the anode due to its excellent electrochemical properties, but its CTE is about  $13.4 \times 10^{-6} / ^\circ\text{C}$ . One potential way to lower the CTE of this anode is to add a small percentage of polycrystalline  $\text{Al}_2\text{TiO}_5$ , with a CTE of  $0.68 \times 10^{-6} / ^\circ\text{C}$ , to the Ni/YSZ base. However,  $\text{Al}_2\text{TiO}_5$  is thermally unstable and loses its effectiveness as it decomposes to  $\text{Al}_2\text{O}_3$  and  $\text{TiO}_2$  between 750°C and 1280°C.

The objective of this summer research project was to evaluate several materials that could be used as additives to increase the thermal stability of  $\text{Al}_2\text{TiO}_5$  in SOFC operating conditions without adversely affecting the electrochemical properties of the SOFC anode. Three candidate materials were chosen through an extensive literature review:  $\text{MgO}$ ,  $\text{Fe}_2\text{O}_3$ , and  $\text{ZrTiO}_4$ . Although all three have been shown to prevent  $\text{Al}_2\text{TiO}_5$  decomposition under various conditions, their effectiveness in the temperature range and atmosphere of the SOFC has not yet been evaluated. Several batches of  $\text{Al}_2\text{TiO}_5$  with varying amounts of additives were prepared, exposed to reducing and oxidizing atmospheres at elevated temperatures, and the resulting decomposition of  $\text{Al}_2\text{TiO}_5$  was measured. The most promising additives were further evaluated with the goal of ultimately preparing low CTE anodes that are chemically compatible to current systems.

Adding minor constituents to stabilize  $\text{Al}_2\text{TiO}_5$  could ultimately preserve its low CTE for the life of the fuel cell and improve the cell's long-term performance without a drop in anode conductivity. Further, these low CTE filler additions could allow the use of new sulfur tolerant anode materials, improving the viability of SOFCs for future aeronautics and space applications.

## **The Office of the Materials Division**

**Amanda J. Ramsey**  
Lorain County Community College  
Communications/Physical Therapy  
Freshman

**Mentor: Raysa M. Rodriguez**  
**Denise S. Prestien**  
**Pamela Spinosi**

### **Abstract**

I was assigned to the Materials Division, which consists of the following branches; the Advanced Metallics Branch/5120-RMM, Ceramics Branch/5130-RMC, Polymers Branch/5150-RMP, and the Durability and Protective Coatings Branch/5160-RMD.

Mrs. Pamela Spinosi is my assigned mentor. She was assisted by Ms. Raysa Rodriguez/5100-RM and Mrs. Denise Prestien/5100-RM, who are both employed by InDyne, Inc.

My primary assignment this past summer was working directly with Ms. Rodriguez, assisting her with setting up the Integrated Financial Management Program (IFMP) 5130-RMC/Branch procedures and logs. These duties consisted of creating various spreadsheets for each individual branch member, which were updated daily. It was not hard to familiarize myself with these duties since this is my second summer working with Ms Rodriguez at NASA Glenn Research Center.

Another meticulous daily duty was working directly with Mr. Earl Hanes/5130-RMC ordering laboratory, supplies and equipment for the Basic Materials Laboratory (Building 106) using the IFMP/Purchase Card (P-card), a NASA-wide software program. I entered into the IFMP/Travel and Requisitions System, new Travel Authorizations for the 5130-RMC Civil Servant Branch Members. I also entered and completed Travel Vouchers for the 5130-RMC Ceramics Branch.

I assisted in the Division Office creating new Emergency Contact list for the Materials Division. I worked with Dr. Hugh Gray, the Division Chief, and Dr. Ajay Misra, the 5130-RMC Branch Chief, on priority action items, with a close deadline, for a large NASA Proposal.

Another project was working closely with Ms. Rodriguez in organizing and preparing for Dr. Ajay K. Misra's SESCDP (two year detail). This consisted of organizing files, file folders, personal information, and recording all data material onto CD's and printing all presentations for display in binders. I attended numerous Branch meetings, and observed many changes in the Branch Management organization.

From this experience, I not only gained many organizational and computer skills, but I also learned the importance of teamwork, and how to work with a positive attitude towards accomplishing many facets of office tasks.

Through this internship, I worked with many diverse groups, on many different levels. From this positive experience, I have a better understanding of how an efficient workplace is accomplished.

I feel privileged to have worked at the NASA Glenn Research Center this summer and exposing myself to the many opportunities that the Center has to offer.

Microstructural Evaluation of Forging Parameters for Superalloy Disks (tentative title)

John.R.Falsey  
Cleveland State University  
Mechanical Engineering  
Undergraduate, Senior  
**MENTOR:** Tim Gabb

ABSTRACT

Forgings of nickel base superalloy were formed under several different strain rates and forging temperatures. Samples were taken from each forging condition to find the ASTM grain size, and the as large as grain (ALA). The specimens were mounted in bakelite, polished, etched and then optical microscopy was used to determine grain size. The specimens ASTM grain sizes from each forging condition were plotted against strain rate, forging temperature, and presoak time. Grain sizes increased with increasing forging temperature. Grain sizes also increased with decreasing strain rates and increasing forging presoak time. The ALA had been determined from each forging condition using the ASTM standard method. Each ALA was compared with the ASTM grain size of each forging condition to determine if the grain sizes were uniform or not. The forging condition of a strain rate of  $.03 \text{ sec}^{-1}$  and supersolvus heat treatment produced non uniform grains indicated by critical grain growth. Other anomalies are noted as well.



# Statistical Analysis of CMC Constituent and Processing Data

Jonathan Fornuff  
Georgia Institute of Technology  
Aerospace Engineering  
Graduate  
Mentor: DiCarlo, James

## Abstract

Ceramic Matrix Composites (CMCs) are the next "big thing" in high-temperature structural materials. In the case of jet engines, it is widely believed that the metallic superalloys currently being utilized for hot structures (combustors, shrouds, turbine vanes and blades) are nearing their potential limits of improvement. In order to allow for increased turbine temperatures to increase engine efficiency, material scientists have begun looking toward advanced CMCs and SiC/SiC composites in particular. Ceramic composites provide greater strength-to-weight ratios at higher temperatures than metallic alloys, but at the same time require greater challenges in micro-structural optimization that in turn increases the cost of the material as well as increases the risk of variability in the material's thermo-structural behavior.

The work I have taken part in this summer explores, in general, the key properties needed to model various potential CMC engine materials and examines the current variability in these properties due to variability in component processing conditions and constituent materials; then, to see how processing and constituent variations effect key strength, stiffness, and thermal properties of the finished components. Basically, this means trying to model variations in the component's behavior by knowing what went into creating it.

In this study SiC/SiC composites of varying architectures, utilizing a boron-nitride (BN) inter-phase and manufactured by chemical vapor infiltration (CVI) and melt infiltration (MI) were considered. Examinations of: (1) the percent constituents by volume, (2) the inter-phase thickness, (3) variations in the total porosity, and (4) variations in the chemical composition of the SiC fiber are carried out and modeled using various codes used here at NASA-Glenn (PCGina, NASALife, CEMCAN, etc...). The effects of these variations and the ranking of their respective influences on the various thermo-mechanical material properties are studied and compared to available test data. The properties of the materials as well as minor changes to geometry are then made to the computer model and the detrimental effects observed using statistical analysis software. The ultimate purpose of this study is to determine what variations in material processing can lead to the most critical changes in the materials property.

# CMC PROPERTY VARIABILITY AND LIFE PREDICTION METHODS FOR TURBINE ENGINE COMPONENT APPLICATION

Matthew L. Cheplak  
Georgia Institute of Technology  
Aerospace Engineering  
Masters Student  
Mentor: James DiCarlo

## ABSTRACT

The ever increasing need for lower density and higher temperature-capable materials for aircraft engines has led to the development of Ceramic Matrix Composites (CMCs). Today's aircraft engines operate with  $>3000^{\circ}\text{F}$  gas temperatures at the entrance to the turbine section, but unless heavily cooled, metallic components cannot operate above  $\sim 2000^{\circ}\text{F}$ . CMCs attempt to push component capability to nearly  $2700^{\circ}\text{F}$  with much less cooling, which can help improve engine efficiency and performance in terms of better fuel efficiency, higher thrust, and reduced emissions.

The NASA Glenn Research Center has been researching the benefits of the SiC/SiC CMC for engine applications. A CMC is made up of a matrix material, fibers, and an interphase, which is a protective coating over the fibers. There are several methods or architectures in which the orientation of the fibers can be manipulated to achieve a particular material property objective as well as a particular component geometric shape and size. The required shape manipulation can be a limiting factor in the design and performance of the component if there is a lack of bending capability of the fiber as making the fiber more flexible typically sacrifices strength and other fiber properties.

Various analysis codes are available (pcGINA, CEMCAN) that can predict the effective Young's Moduli, thermal conductivities, coefficients of thermal expansion (CTE), and various other properties of a CMC. There are also various analysis codes (NASAlife) that can be used to predict the life of CMCs under expected engine service conditions. The objective of this summer study is to utilize and optimize these codes for examining the tradeoffs between CMC properties and the complex fiber architectures that will be needed for several different component designs. For example, for the pcGINA code, there are six variations of architecture available. Depending on which architecture is analyzed, the user is able to specify the fiber tow size, tow spacing, weave parameter, and angle of orientation of fibers. By holding the volume fraction of the fibers constant, variations in tow spacing can be explored for different architectures. The CMC material properties are usually calculated assuming the component is manufactured perfectly. However, this is typically not the case so that a quantification of the material property variability is needed to account for processing and/or manufacturing imperfections. The overall inputs and outputs are presented using a regression software to rapidly investigate the tradeoffs associated with fiber architecture, material properties, and ultimately cost. This information is then propagated through lifing models and Larson-Miller data to assess time/temperature-dependent CMC strength. In addition, a first order cost estimation will be quantified from a current qualitative perspective. This cost estimation includes the manufacturing challenges, such as tooling, as well as the component cost for a particular application. Ultimately, a cost to performance ratio should be established that compares the effectiveness of CMCs to their current rival, nickel superalloys.

## Syntheses and Chemosensory of Anthracene and Phenanthrene Bisimide Derivatives

Zachary A. Bogusz

Ithaca College

Chemical Engineering

Junior, Undergraduate

**Mentor: Dr. Michael A. Meador**

### Abstract

As the present technology of biochemical weapons advances, it is essential for science to attempt to prepare our nation for such an occurrence. Various areas of current research are devoted to precautionary measures and potential antidotes for national security. A practical application of these precautions would be the development of a chemical capable of detecting harmful gas. The benefits of being capable to synthesis a chemical compound that would warn and identify potentially deadly gases would ensure a higher level of safety.

The chemicals in question can be generalized as bisimide anthracene derivatives. The idea behind these compounds is that in the presence of certain nerve gases, the compound will actually fluoresce, giving an indication that there is a strong likelihood of the presence of a nerve gas and ensure the proper precautionary measures are taken. The fluorescence is due to the quenching of an electric proton transfer within the structure of the molecule. The system proves to be very unique on account of the fact that the fluorescence can be "turned off" by reducing the system. By utilizing the synthesis designed by Dr. Faysal Ilhan, four distinct compounds can be synthesized through photochemical reactions involving para- and ortho- diketones. The photochemistry involved is very modern and much research is being devoted to fully understanding the possibilities and alternative applications of such materials.

The objective of my project is to synthesis several derivates of this compound, a para- and meta- nitro anthracene bisimide (ABI-NO<sub>2</sub>), the amine of each (ABI-NH<sub>2</sub>), a para- and meta- nitro phenanthrene bisimide (PBI-NO<sub>2</sub>), and the amine of each (PBI-NH<sub>2</sub>). Upon synthesizing these distinct compounds, I must then purify and analyze them in order to obtain any relevant trends, behaviors, and characteristics. The chemical composition analyses that will be conducted are the procedures taken by Dr. Daniel Tyson on previous experiments. The results generated from the data will point further research in the correct direction and hopefully provide enough information to possibly create a stepping-stone for a brand new area in an unexplored frontier of chemistry.

# **EPOXY ADHESIVES FOR STATOR MAGNET ASSEMBLY IN STIRLING RADIOISOTOPE GENERATORS (SRG)**

**George M. Cater**  
University of Michigan  
Chemical Engineering  
Sophomore

**Mentor: E. Eugene Shin & James K. Sutter**

## **ABSTRACT**

As NASA seeks to fulfill its goals of exploration and understanding through missions planned to visit the moons of Saturn and beyond, a number of challenges arise from the idea of deep space flight. One of the first problems associated with deep space travel is electrical power production for systems on the spacecraft. Conventional methods such as solar power are not practical because efficiency decreases substantially as the craft moves away from the Sun. The criterion for power generation during deep space missions are very specific, the main points requiring high reliability, low mass, minimal vibration and a long lifespan. A Stirling generator, although fairly old in concept, is considered to be a potential solution for electrical power generation for deep space flight.

A Stirling generator works on the same electromagnetic principles of a standard generator, using the linear motion of the alternator through the stationary stator which produces electric induction. The motion of the alternator, however, is produced by the heating and cooling dynamics of pressurized gasses. Essentially heating one end and cooling another of a contained gas will cause a periodic expansion and compression of the gas from one side to the other, which a displacer translates into linear mechanical motion. NASA needs to confirm that the materials used in the generator will be able to withstand the rigors of space and the life expectancy of the mission. I am working on the verification of the epoxy adhesives used to bond magnets to the steel lamination stack to complete the stator; in terms of in-service performance and durability under various space environments. Understanding the proper curing conditions, high temperature properties, and degassing problems as well as production difficulties are crucial to the long term success of the generator.

My work involves specimen fabrications, testing, and data analyses of the epoxy adhesive system and steel substrate used in the stator. To optimize the curing conditions of the epoxies, modulated differential scanning calorimetry analysis was done as a function of cure time and temperatures. Adhesion bond strength was tested at various temperatures with lap shear samples using Hiperco 50 substrate to ensure that the proper adhesive is being used. To try and solve the problem of bondline thickness, micro glass beads of 0.0017" in diameter were investigated to see if any other physical properties of the epoxy were affected. Efforts will be made to develop a standard, optimized, fabrication process/procedure of sub-scale magnet-stator assemblies for various adhesive performance evaluation studies under simulated generator conditions. Also, accelerated aging testing will be done in a pressurized canister with stator assembly samples for three years to verify if any degassing or thermal degradation of the epoxy occurs. The necessity of verifying the correct epoxy adhesive system for the stator magnet in the SRG is crucial because failure of the stator assembly would jeopardize the electrical system, and thereby the entire mission itself.

# LITHIUM POLYMER ELECTROLYTES and SOLID STATE NMR

**Emily R. Berkeley**  
Johns Hopkins University  
Chemistry  
Junior  
**Mentor: Mary Ann B. Meador**

## ABSTRACT

Research is being done at the Glenn Research Center (GRC) developing new kinds of batteries that do not depend on a solution. Currently, batteries use liquid electrolytes containing lithium. Problems with the liquid electrolyte are (1) solvents used can leak out of the battery, so larger, more restrictive, packages have to be made, inhibiting the diversity of application and decreasing the power density; (2) the liquid is incompatible with the lithium metal anode, so alternative, less efficient, anodes are required. The Materials Department at GRC has been working to synthesize polymer electrolytes that can replace the liquid electrolytes. The advantages are that polymer electrolytes do not have the potential to leak so they can be used for a variety of tasks, small or large, including in the space rover or in space suits.

The polymers generated by Dr. Mary Ann Meador's group are in the form of rod-coil structures. The rod aspect gives the polymer structural integrity, while the coil makes it flexible. Lithium ions are used in these polymers because of their high mobility. The coils have repeating units of oxygen which stabilize the positive lithium by donating electron density. This aids in the movement of the lithium within the polymer, which contributes to higher conductivity. In addition to conductivity testing, these polymers are characterized using DSC, TGA, FTIR, and solid state NMR.

Solid state NMR is used in classifying materials that are not soluble in solvents, such as polymers. The NMR spins the sample at a magic angle ( $54.7^\circ$ ) allowing the significant peaks to emerge. Although solid state NMR is a helpful technique in determining bonding, the process of preparing the sample and tuning it properly are intricate jobs that require patience; especially since each run takes about six hours. The NMR allows for the advancement of polymer synthesis by showing if the expected results were achieved. Using the NMR, in addition to looking at polymers, allows for participation on a variety of other projects, including aero-gels and carbon graphite materials.

The goals of the polymer electrolyte research are to improve the physical properties of the polymers. This includes improving conductivity, durability, and expanding the temperature range over which it is effective. Currently, good conductivity is only present at high temperatures. My goals are to experiment with different arrangements of rods and coils to achieve these desirable properties. Some of my experiments include changing the number of repeat units in the polymer, the size of the diamines, and the types of coil. Analysis of these new polymers indicates improvement in some properties, such as lower glass transition temperature; however, they are not as flexible as desired. With further research we hope to produce polymers that encompass all of these properties to a high degree.

# CYCLIC OXIDATION OF HIGH-TEMPERATURE ALLOY WIRES IN AIR

**Marissa M. Reigel**  
Colorado School of Mines  
Metallurgy and Materials Engineering  
Senior  
**Mentor: Elizabeth J. Opila**

## ABSTRACT

High-temperature alloy wires are proposed for use in seal applications for future re-useable space vehicles. These alloys offer the potential for improved wear resistance of the seals. The wires must withstand the high temperature environments the seals are subjected to as well as maintain their oxidation resistance during the heating and cooling cycles of vehicle re-entry. To model this, the wires were subjected to cyclic oxidation in stagnant air.

All metals react with oxygen in the atmosphere to form an oxide layer. The rate of this layer formation is dependent on temperature. Slow growing oxides such as chromia and alumina are desirable. Once the oxide is formed it can prevent the metal from further reacting with its environment. Cyclic oxidation models the changes in temperature these wires will undergo in application. Cycling the temperature introduces thermal stresses which can cause the oxide layer to break off. Re-growth of the oxide layer consumes more metal and therefore reduces the properties and durability of the material.

Based on earlier isothermal testing in oxygen, three different wire compositions were used for cyclic oxidation testing. The baseline material, Haynes 188, has a Co base and is a chromia former while the other two alloys, Kanthal A1 and PM2000, both have a Fe base and are alumina formers. Haynes 188 and Kanthal A1 wires are 250  $\mu\text{m}$  in diameter and PM2000 wires are 150  $\mu\text{m}$  in diameter. The coiled wire has a total surface area of 3 to 5  $\text{cm}^2$ . The wires were oxidized for 11 cycles at 1204°C, each cycle containing a 1 hour heating time and a minimum 20 minute cooling time. Weights were taken between cycles. After 11 cycles, one wire of each composition was removed for analysis. The other wire continued testing for 70 cycles. Post-test analysis includes X-Ray Diffraction (XRD), Scanning Electron Microscopy (SEM) and Energy Dispersive Spectroscopy (EDS) for phase identification and morphology.

In previous isothermal testing, the Kanthal A1 and PM2000 wires performed better than the Haynes 188 wires. The cyclic oxidation results showed the same trend. This is to be expected since alumina forming alloys typically outperform chromia-forming alloys at this temperature.

Based on the results thus far, a few questions have been raised. Why is the weight gain higher in isothermal testing than cyclic testing? Are the wires affected by the way they are suspended in the furnace, either in a bucket or by themselves? What role does dry oxygen vs. stagnant air play in the oxidation rate of the wire? Continued efforts for this project include post-test analysis of the wires still undergoing cyclic oxidation testing. Further analysis should help answer these questions.

## **Thermal characteristics of Lithium-ion batteries**

**Dan Hauser**

Ohio University

Chemical Engineering

Undergraduate, Junior

Mentor: Thomas Miller, Concha Reid

### **ABSTRACT**

Lithium-ion batteries have a very promising future for space applications. Currently they are being used on a few GEO satellites, and were used on the two recent Mars rovers' Spirit and Opportunity. There are still problems that exist that need to be addressed before these batteries can fully take flight. One of the problems is that the cycle life of these batteries needs to be increased.

One way of increasing the cycle life is to increase the stability of the materials inside the battery. Research is being focused on the chemistry of the materials inside the battery. This includes the anode, cathode, and the cell electrolyte solution. These components can undergo unwanted chemical reactions inside the cell that deteriorate the materials of the battery. During discharge/ charge cycles there is heat dissipated in the cell, and the battery heats up and its temperature increases. An increase in temperature can speed up any unwanted reactions in the cell. Exothermic reactions cause the temperature to increase; therefore increasing the reaction rate will cause the increase of the temperature inside the cell to occur at a faster rate. If the temperature gets too high thermal runaway will occur, and the cell can explode.

The material that separates the electrode from the electrolyte is a non-conducting polymer. At high temperatures the separator will melt and the battery will be destroyed. The separator also contains small pores that allow lithium ions to diffuse through during charge and discharge. High temperatures can cause these pores to close up, permanently damaging the cell.

My job at NASA Glenn research center this summer will be to perform thermal characterization tests on an 18650 type lithium-ion battery. High temperatures cause the chemicals inside lithium ion batteries to spontaneously react with each other. My task is to conduct experiments to determine the temperature that the reaction takes place at, what components in the cell are reacting and the mechanism of the reaction. The experiments will be conducted using an accelerating rate calorimeter (ARC), which uses a heat-wait-search mode until an exothermic reaction is detected. After an exotherm is found the calorimeter maintains an adiabatic environment around a bomb which holds the test sample. The ARC will help identify important reactions and what temperature these exothermic reactions take place at.

In order fully understand the battery, we are first going to take apart the battery and test the individual components of the battery using the ARC. I will first conduct a test on the electrolyte solution by itself. We will then test the electrolyte solution with the anode. We would like to see how the electrolyte solution reacts with the anode and its binder material. The next would be the same test using the cathode instead of the anode.

By comparing the results of the electrolyte, electrolyte with anode, and the electrolyte with the cathode we can determine the reactions that are taking place due to each component. Using the heat capacity of the each individual sample and the temperature by which the sample increases, kinetic and thermo-dynamical information can then be found. A Gas chromatograph could be used to help with the task of identifying the by-products at the end of each test.

# **A STUDY OF PENALTY FUNCTION METHODS FOR CONSTRAINT HANDLING WITH GENETIC ALGORITHM**

**Francisco Ortiz**

Florida A&M University

Industrial Engineering

PhD Candidate

**Mentor: Surya N Patnaik**

## **ABSTRACT**

COMETBOARDS (Comparative Evaluation Testbed of Optimization and Analysis Routines for Design of Structures) is a design optimization test bed that can evaluate the performance of several different optimization algorithms. A few of these optimization algorithms are the sequence of unconstrained minimization techniques (SUMT), sequential linear programming (SLP) and the sequential quadratic programming techniques (SQP).

A genetic algorithm (GA) is a search technique that is based on the principles of natural selection or "survival of the fittest". Instead of using gradient information, the GA uses the objective function directly in the search. The GA searches the solution space by maintaining a population of potential solutions. Then, using evolving operations such as recombination, mutation and selection, the GA creates successive generations of solutions that will evolve and take on the positive characteristics of their parents and thus gradually approach optimal or near-optimal solutions. By using the objective function directly in the search, genetic algorithms can be effectively applied in non-convex, highly nonlinear, complex problems. The genetic algorithm is not guaranteed to find the global optimum, but it is less likely to get trapped at a local optimum than traditional gradient-based search methods when the objective function is not smooth and generally well behaved.

The purpose of this research is to assist in the integration of genetic algorithm (GA) into COMETBOARDS. COMETBOARDS cast the design of structures as a constrained nonlinear optimization problem. One method used to solve constrained optimization problem with a GA to convert the constrained optimization problem into an unconstrained optimization problem by developing a penalty function that penalizes infeasible solutions. There have been several suggested penalty function in the literature each with their own strengths and weaknesses. A statistical analysis of some suggested penalty functions is performed in this study. Also, a response surface approach to robust design is used to develop a new penalty function approach. This new penalty function approach is then compared with the other existing penalty functions.



## Library Services Funding Assessment

Jonathan A. Lorig  
University of Illinois at Urbana-Champaign  
Graduate School of Library and Information Science  
Level: Master's  
Mentor: Susan F. Oberc

### ABSTRACT

The Glenn Technical Library is a science and engineering library that primarily supports research activities at the Glenn Research Center, and provides selected services to researchers at all of the NASA research centers. Resources available in the library include books, journals, CD-ROMs, and access to various online sources, as well as live reference and inter-library loan services. The collection contains over 77,000 books, 800,000 research reports, and print or online access to over 1,400 journals. Currently the library operates within the Logistics and Technical Information Division, and is funded as an open-access resource within the GRC.

Some of the research units at the GRC have recently requested that the library convert to a "pay-for-services" model, in which individual research units could fund only those journal subscriptions for which they have a specific need. Under this model, the library would always maintain a certain minimum level of pooled-expense services, including the ready reference and book collections, and inter-library loan services. Theoretically the "pay-for-services" model would encourage efficient financial allocation, and minimize the extent to which paid journal subscriptions go unused. However, this model also could potentially negate the benefits of group purchases for journal subscriptions and access. All of the major journal publishers offer package subscriptions that compare favorably in cost with the sum of individual subscription costs for a similar selection of titles. Furthermore, some of these subscription packages are "consortium" purchases that are funded collectively by the libraries at multiple NASA research centers; such consortial memberships would be difficult for the library to pay, if enough GRC research units were to withdraw their pooled contributions.

The head librarian wishes to establish a cost analysis dataset that compares the cost of collectively-funded journal access with the cost of individual subscriptions. My primary task this summer is to create the cost dataset framework, and collect as much of the relevant data as possible. Hopefully this dataset will permit the research units at the GRC, and library administration as well, to make informed decisions about future library funding. Prior to the creation of the actual dataset, I established a comprehensive list of the library's print and online journal subscriptions. This list will be useful outside the context of the cost analysis project, as an addition to the library website. The cost analysis dataset's primary fields are: journal name, vendor, publisher, ISSN (International Standard Serial Number, to uniquely identify the titles), stand-alone price, and indication as to the presence of the journal in current GRC Technical Library consortium membership subscriptions. The dataset will hopefully facilitate comparisons between the stand-alone journal prices and the cost of shared journal subscriptions for groups of titles.

**Research Symposium II**  
**Ohio Aerospace Institute**  
**Wednesday, August 4, 2004**

**OAI Industry Room**

**9:00 A.M. Elizabeth Fehrmann, Rochester Institute of Technology, Junior**

“Resolving the Issues with Flywheel Position Sensors”

5450/Barbara Kenny, Electrical Systems Development Branch

**9:15 Robert Reid II, University of Detroit-Mercy, Freshman**

“Nickel-Hydrogen and Lithium Ion Space Batteries”

5420/Marla Perez-David, Electrochemistry Branch

**9:30 Matthew Bielozzer, Ohio State University, Senior**

“Thermal Energy Conversion Branch”

5490/Jeff Schreiber, Thermo-Mechanical Systems Branch

**9:45 Timothy Collins, University of Central Oklahoma, Senior**

“Optical Tweezer Assembly and Calibration”

5520/Susan Wrbanek, Optical Instrumentation Technology Branch

**10:00 Wei Zhang, Georgia Tech, Masters**

“Parametric Studies of Flow Separation using Air Injection”

5530/Dennis Culley, Controls and Dynamics Technology Branch

**10:15 Ranjan Radhamohan, University of Michigan, Junior**

“The Direct Digital Modulation of Traveling Wave Tubes”

5620/Dale Force, Electron Device Technology Branch

**10:30 Vanessa Varaljay, Cleveland State University, Junior**

“A Novel Biomedical Device Utilizing Light Emitting Nano-Structures”

5620/Maximilian Scardelletti, Electron Device Technology Branch

**10:45 Jason Reinert, Youngstown State University, Senior**

“Modeling of a Variable Focal Length Flat Lens Using Left Handed Metamaterials”

5620/Jeffrey Wilson, Electron Device Technology Branch

**11:00 LUNCH**

**1:00 Joseph Downey, University of Toledo, Freshman**

“Traveling Wave Tube (TWT) RF Power Combining Demonstration for Use in the Jupiter Icy Moons Orbiter (JIMO)”

5620/Edwin Wintucky, Electron Device Technology Branch

**1:15 Oluwatosin Ogunwuyi, City College of New York, Masters**

“Statistical and Prediction modeling of the Ka Band Using Experimental Results from ACTS Propagation Terminals at 20.185 and 27.505 GHz”

5640/Roberto Acosta, Applied RF Technology Branch

**1:30 Eric Miller, University of Cincinnati, Sophomore**

“Analysis of Droplet Size During the Ice Accumulation Phase of Flight Testing”

5840/Sam Lee, Icing Branch

**1:45 Nilika Chaudhary, MIT, Sophomore**

“Graphical User Interface Development for Representing Air Flow Patterns”

5820/David Ashpis, Turbine Branch

**2:00 Joseph Kardamis, Rochester Institute of Technology, Junior**

“Glenn Heat Transfer Simulation and Solver Graphical User Interface:  
Development and Testing”

5820/Barbara Lucci, Turbine Branch

**2:15 Stephen Huang, California Polytechnical State University, Senior**

“Air Separation Using Hollow Fiber Membranes”

5830/Clarence Chang, Combustion Branch

**2:30 Heidi Robinson, University of Akron, Masters**

“ ‘We Burn to Learn’ About Fuel-Air Mixing Within Aircraft Powerplants”

5830/Yolanda Hicks, Combustion Branch

**2:45 Jacqueline Corrigan, University of Dayton, Sophomore**

“Bubble Combustion”

5830/Viet Nguyen, Combustion Branch

**3:00 Gregory Newstadt, Miami University, Junior**

“Battery Resistance Analysis of ISS Power System”

6920/Ann Delleur, Analysis and Management Branch

**3:15 ADJOURN**

## RESOLVING THE ISSUES WITH FLYWHEEL POSITION SENSORS

**Elizabeth A. Fehrmann**  
Rochester Institute of Technology  
Computer Engineering  
Undergraduate, Junior  
**Mentor: Barbara Kenny**

### ABSTRACT

For the past few years, the Advanced Electrical Systems Branch here at NASA Glenn has been pursuing research in the area of flywheels. The purpose of these pursuits has been to explore the potential for flywheels to replace current battery-powered systems in space. So far it has been learned that flywheels offer large momentum storage capacity, comparatively small volume, high durability, and near-complete discharge capabilities, all of which are advancements over the existing nickel hydrogen and nickel cadmium batteries. Another significant advantage of flywheels is the potential they offer for combining the function of attitude control with energy storage. During the summer of 2004, I worked with Dr. Barbara Kenny in the Advanced Electrical Systems Branch, supporting the work she is doing by analyzing and testing some new components for the new Generation-2 flywheel.

To monitor the speed and angular position of the flywheel rotor, a once-around (OAR) signal along with a sensorless algorithm is used. The OAR signal is used for the magnetic bearings that keep the flywheel suspended for frictionless operation. The sensorless algorithm is used for the flywheel motor/generator control. The OAR is generated from position sensors that monitor a circular plate. The plate has a cut down the middle such that one half of the circle is on a slightly lower level than the other. Every half-turn, or 180°, the sensors detect the "cut" on the plate, and trigger the OAR, telling the computer that the rotor has made half a revolution. This, however, doesn't provide needed detailed information about the angular position of the rotor, since it only provides a signal alert every half-revolution. This is enough information for the magnetic bearing control but is insufficient for the motor/generator control. A new resolver was designed such that it would give continuous angle information rather than the 180 degree information of the OAR. The new resolver has two separate observable pieces: a flat middle section to monitor vertical motion, and an angled section around the circumference, which, when observed from above, produces a sine-wave displacement through the entire 360° revolution. My first job when I arrived this summer was to calibrate the sensors that would be mounted on the inside of the flywheel casing to monitor the position (angular and vertical) of the shaft. After calibration, I used the sensors to evaluate voltage outputs created by position differences between two pairs of sensors on the angled portion of the resolver for eight different angular positions, moving the resolver vertically and laterally through its entire potential range of motion. The results of these tests will be used to determine the rotor angular (and axial) position from the sensor readings once the new flywheel unit is assembled.

The sensorless algorithm mentioned above consists of two operations: the signal injection method and the back electro-motive force (EMF). The signal injection is meant to work at low speeds, while the back EMF algorithm is meant to work at higher speeds. Both work together to determine the correct estimate of rotor position and speed based on the measured motor/generator current. It was determined that we wanted to know exactly how accurate our estimation methods were, and so a resolver (a commercially available mechanical sensor mounted to the motor/generator shaft to measure rotor position and speed) and a "Resolver to Digital" (R2D) circuit board was purchased to make the comparison to the existing estimation. My work related to the R2D board has included the following: creating two connector cables (one to power the circuit and one to get readable output off the board), writing Simulink code to process the board's output, and building a dSpace panel to control and monitor the circuit. The next step in the process will be to perform tests to compare the estimated rotor position and speed from the sensorless algorithm to the actual rotor and speed from the resolver signal.

# Nickel-Hydrogen and Lithium Ion Space Batteries

**Robert O. Reid, II**

University of Detroit Mercy  
Mechanical Engineering  
Undergraduate, Rising Freshman

**Mentors: Thomas B. Miller**

**Concha L. Reid-Callwood**

## Abstract

The tasks of the Electrochemistry Branch of NASA Glenn Research Center are to improve and develop high energy density and rechargeable, life-long batteries. It is with these batteries that people across the globe are able to power their cell phones, laptop computers, and cameras. Here, at NASA Glenn Research Center, the engineers and scientists of the Electrochemistry branch are leading the way in the development of more powerful, long life batteries that can be used to power space shuttles and satellites.

As of now, the cutting edge research and development is being done on nickel-hydrogen batteries and lithium ion batteries. Presently, nickel-hydrogen batteries are common types of batteries that are used to power satellites, space stations, and space shuttles, while lithium batteries are mainly used to power smaller appliances such as portable computers and phones. However, the Electrochemistry Branch at NASA Glenn Research Center is focusing more on the development of lithium ion batteries for deep space use. Because of the limitless possibilities, lithium ion batteries can revolutionize the space industry for the better.

When compared to nickel-hydrogen batteries, lithium ion batteries possess more advantages than its counterpart. Lithium ion batteries are much smaller than nickel-hydrogen batteries and also put out more power. They are more energy efficient and operate with much more power at a reduced weight than its counterpart. Lithium ion cells are also cheaper to make, possess flexibility that allow for different design modifications. With those statistics in hand, the Electrochemistry Branch of NASA Glenn has decided to shut down its Nickel-Hydrogen testing for lithium ion battery development. Also, the blackout in the summer of 2003 eliminated vital test data, which played a part in shutting down the program.

Therefore, during my tenure, it is my responsibility to take down final test data from the nickel-hydrogen batteries and compare it to past data. My other responsibilities include superheating the electrolyte that is used in the nickel-hydrogen cell in a calorimeter to test its performance under various conditions. I used a program called Arbin to study my data. The Arbin allows me to look at different parameters such as pressure and time and how they affect the changing temperature of the electrolyte that is being tested. In addition, I had the responsibility of taking apart and modifying battery coolers that would be used. My mentors told me that the batteries kept shutting down, so it was my responsibility to remove excess fan grilles, rotate the fans, and then switch the aluminum standoffs with nylon ones so that the coolers could operate without problems. My last task is to collect all the battery test data and organize them into charts using Microsoft Excel, before the Branch is able to conduct its research on lithium ion batteries.

## **Thermal Energy Conversion Branch**

**Matthew C. Bielozer**  
The Ohio State University  
Mechanical Engineering  
Senior

**Mentor: Jeffrey G. Schreiber  
& Scott D. Wilson**

### **ABSTRACT**

The Thermal Energy Conversion Branch (5490) leads the way in designing, conducting, and implementing research for the newest thermal systems used in space applications at the NASA Glenn Research Center. Specifically some of the most advanced technologies developed in this branch can be broken down into four main areas: Dynamic Power Systems, Primary Solar Concentrators, Secondary Solar Concentrators, and Thermal Management. Work was performed in the Dynamic Power Systems area, specifically the Stirling Engine subdivision. Today, the main focus of the 5490 branch is free-piston Stirling cycle converters, Brayton cycle nuclear reactors, and heat rejection systems for long duration mission spacecraft.

All space exploring devices need electricity to operate. In most space applications, heat energy from radioisotopes is converted to electrical power. The Radioisotope Thermoelectric Generator (RTG) already supplies electricity for missions such as the Cassini Spacecraft. The focus of today's Stirling research at GRC is aimed at creating an engine that can replace the RTG. The primary appeal of the Stirling engine is its high system efficiency. Because it is so efficient, the Stirling engine will significantly reduce the plutonium fuel mission requirements compared to the RTG. Stirling is also be considered for missions such as the lunar/Mars bases and rovers

This project has focused largely on Stirling Engines of all types, particularly the fluidyne liquid piston engine. The fluidyne was developed by Colin D. West. This engine uses the same concepts found in any type of Stirling engine, with the exception of missing mechanical components. All the working components are fluid. One goal was to develop and demonstrate a working Stirling Fluidyne Engine at the 2<sup>nd</sup> Annual International Energy Conversion Engineering Conference in Providence, Rhode Island.

## OPTICAL TWEEZER ASSEMBLY AND CALIBRATION

**Timothy M. Collins**  
University of Central Oklahoma  
Engineering Physics  
Senior

**Mentor: Susan Y. Wrbanek**

### ABSTRACT

An Optical Tweezer, as the name implies, is a useful tool for precision manipulation of micro and nano scale objects. Using the principle of electromagnetic radiation pressure, an optical tweezer employs a tightly focused laser beam to trap and position objects of various shapes and sizes. These devices can trap micrometer and nanometer sized objects. An exciting possibility for optical tweezers is its future potential to manipulate and assemble micro and nano sized sensors. A typical optical tweezer makes use of the following components: laser, mirrors, lenses, a high quality microscope, stage, Charge Coupled Device (CCD) camera, TV monitor and Position Sensitive Detectors (PSD's). The laser wavelength employed is typically in the visible or infrared spectrum. The laser beam is directed via mirrors and lenses into the microscope. It is then tightly focused by a high magnification, high numerical aperture microscope objective into the sample slide, which is mounted on a translating stage. The sample slide contains a sealed, small volume of fluid that the objects are suspended in. The most common objects trapped by optical tweezers are dielectric spheres. When trapped, a sphere will literally "snap" into and center itself in the laser beam. The PSD's are mounted in such a way to receive the backscatter after the beam has passed through the trap. PSD's used with the Differential Interference Contrast (DIC) technique provide highly precise data.

Most optical tweezers employ lasers with power levels ranging from 10 to 100 milliwatts. Typical forces exerted on trapped objects are in the pico-newton range. When PSD's are employed, object movement can be resolved on a nanometer scale in a time range of milliseconds. Such accuracy, however, can only be utilized by calibrating the optical tweezer. Fortunately, an optical tweezer can be modeled accurately as a simple spring. This allows Hook's Law to be used.

My goal this summer at NASA Glenn Research Center is the assembly and calibration of an optical tweezer setup in the Instrumentation and Controls Division (5520). I am utilizing a custom LabVIEW Virtual Instrument program for data collection and microscope stage control. Helping me in my assignment are the following people: Mentor Susan Wrbanek (5520), Dr. Baha Jassemnejad (UCO) and Technicians Ken Weiland (7650) and James Williams (7650). Without their help, my task would not be possible.

# **Parametric Studies of Flow Separation using Air Injection**

**Wei Zhang**

Georgia Institute of Technology  
Aerospace Engineering  
Graduate: Master Degree Candidate

**Mentor: Dennis E. Culley**

## **Abstract**

Boundary Layer separation causes the airfoil to stall and therefore imposes dramatic performance degradation on the airfoil. In recent years, flow separation control has been one of the active research areas in the field of aerodynamics due to its promising performance improvements on the lifting device. These active flow separation control techniques include steady and unsteady air injection as well as suction on the airfoil surface etc. This paper will be focusing on the steady and unsteady air injection on the airfoil. Although wind tunnel experiments revealed that the performance improvements on the airfoil using injection techniques, the details of how the key variables such as air injection slot geometry and air injection angle etc impact the effectiveness of flow separation control via air injection has not been studied.

A parametric study of both steady and unsteady air injection active flow control will be the main objective for this summer. For steady injection, the key variables include the slot geometry, orientation, spacing, air injection velocity as well as the injection angle. For unsteady injection, the injection frequency will also be investigated. Key metrics such as lift coefficient, drag coefficient, total pressure loss and total injection mass will be used to measure the effectiveness of the control technique. A design of experiments using the Box-Behnken Design is set up in order to determine how each of the variables affects each of the key metrics. Design of experiment is used so that the number of experimental runs will be at minimum and still be able to predict which variables are the key contributors to the responses. The experiments will then be conducted in the 1 ft by 1 ft wind tunnel according to the design of experiment settings. The data obtained from the experiments will be imported into JMP, statistical software, to generate sets of response surface equations which represent the statistical empirical model for each of the metrics as a function of the key variables. Next, the variables such as the slot geometry can be optimized using the build-in optimizer within JMP. Finally, a wind tunnel testing will be conducted using the optimized slot geometry and other key variables to verify the empirical statistical model.

The long term goal for this effort is to assess the impacts of active flow control using air injection at system level as one of the task plan included in the NASA's URETI program with Georgia Institute of Technology.



# THE DIRECT DIGITAL MODULATION OF TRAVELING WAVE TUBES

**Ranjan S. Radhamohan**  
University of Michigan  
Electrical Engineering  
Undergraduate, Junior  
**Mentor: Dale A. Force**

## ABSTRACT

Traveling wave tube (TWT) technology, first described by Rudolf Kompfner in the early 1940s, has been a key component of space missions from the earliest communication satellites in the 1960s to the Cassini probe today. TWTs are essentially signal amplifiers that have the special capability of operating at microwave frequencies. The microwave frequency range, which spans from approximately 500 MHz to 300 GHz, is shared by many technologies including cellular phones, satellite television, space communication, and radar. TWT devices are superior in reliability, weight, and efficiency to solid-state amplifiers at the high power and frequency levels required for most space missions.

TWTs have three main components –an electron gun, slow wave structure, and collector. The electron gun generates an electron beam that moves along the length of the tube axis, inside of the slow wave circuit. At the same time, the inputted signal is slowed by its travel through the coils of the helical slow wave circuit. The interaction of the electron beam and this slowed signal produces a transfer of kinetic energy to the signal, and in turn, amplification. At the end of its travel, the spent electron beam moves into the collector where its remaining energy is dissipated as heat or harnessed for reuse. TWTs can easily produce gains in the tens of decibels, numbers that are suitable for space missions.

To date, however, TWTs have typically operated at fixed levels of gain. This gain is determined by various, unchanging, physical factors of the tube. Traditionally, to achieve varying gain, an input signal's amplitude has had to first be modulated by a separate device before being fed into the TWT. This is not always desirable, as significant distortion can occur in certain situations. My mentor, Mr. Dale Force, has proposed an innovative solution to this problem called 'direct digital modulation'. The testing and implementation of this solution is the focus of my summer internship.

The direct digital modulation of a TWT removes the need for a separate amplitude modulation device. Instead, different levels of gain are achieved by varying the electron beam current. The lower the current, the less kinetic energy is available to be transferred to the signal. To vary the current, a grid is placed in-between the electron gun and the slow wave circuit. By changing the voltage across the grid, the electron beam current can be controlled. Grid technology has mostly been used in pulse applications such as radar, where only two voltage states are necessary. For direct digital modulation, however, a continuous range of voltages is required.

Our current task is to enhance an existing TWT so that it produces varying electron beam current, and also to add certain features that reverse the small side-effects of this operation.

Vanessa A. Varaljay  
Cleveland State University  
Biology  
Undergraduate, Junior

Mentor: Maximilian C. Scardelletti

## A Novel Biomedical Device Utilizing Light Emitting Nano-Structures

### ABSTRACT

This paper will discuss the development of a novel biomedical detection device that will be used to detect microorganisms with the use of infrared fluorochrome polymers attached to antibodies in fluids such as water. The fluorochrome polymers emit light in the near infrared region (NIR), approximately 805 nm, when excited by an NIR laser at 778 nm.

The device could remarkably change the way laboratory testing is done today. The testing process is usually performed on a time scale of days while our device will be able to detect microorganisms in minutes. This type of time efficient analysis is ideal for use aboard the International Space Station and the Space Shuttle (ISS/SS) and has many useful commercial applications, for instance at a water treatment plant and food processing plants. With more research and experimentation the testing might also one day be used to detect bacteria and viruses in complex fluids such as blood, which would revolutionize blood analysis as it is performed today.

My contribution to the project has been to develop a process which will allow an antibody/fluorescent dye pair to be conjugated to a specific bacteria or virus and then to be separated from a sample body of water for detection. The antibody being used in this experiment is anti beta galactosidase and its complement enzyme is beta galactosidase, a non harmful derivative of E. Coli. The anti beta galactosidase has been conjugated to the fluorochrome polymer, IRDye800, which emits at approximately 806 nm. The dye when excited by the NIR laser emits a signal which is detected by a spectrometer and then is read by state of the art computer software.

The state-of-the-art process includes incubating the anti beta galactosidase and beta galactosidase in a phosphate buffer solution in a test tube, allowing the antibody to bind to specific sites on the enzyme. After the antibody is bound to the enzyme, it is centrifuged in specific filters that will allow free antibody to wash away and leave the antibody-enzyme complexes on top in solution for testing and analysis. This solution is pipetted into a cuvette, a special plastic test tube, which will then be excited by the laser. The signal read will tell us that an antibody is present and since it is bound to the enzyme, that the bacteria is also present.

# Modeling of a Variable Focal Length Flat Lens Using Left Handed Metamaterials

**Jason Reinert**

Youngstown State University  
Electrical and Computer Engineering  
Senior

**Mentor: Jeffrey D. Wilson**

## ABSTRACT

Left Handed Metamaterials (LHM) were originally proposed by Victor Veselago in 1968. These substances would allow a flat structure to focus electromagnetic (EM) waves because they have a negative index of refraction. A similar structure made from conventional materials, those with a positive index of refraction, would disperse the waves. But until recently, these structures have been purely theoretical because substances with both a negative permittivity and negative permeability, material properties necessary for a negative index of refraction, do not naturally exist. Recent developments have produced a structure composed of an array of thin wires and split ring resonators that shows a negative index of refraction.

Traditional lenses made from conventional materials cannot focus an EM wave onto an area smaller than a square wavelength. How small the area is can be determined by how perfectly the lens is polished and how pure the substance is that composes the lens. These lenses must also be curved for focusing to occur. The focal length is determined by the curvature of the lens and the material. On the other hand, a flat structure made from LHM would focus light because of the effect of a negative index of refraction in Snell's law. The focal length could also be varied by simply adjusting the distance of the lens from the source of radiation. This could create many devices that are adjustable to different situations in fields such as biomedical imaging and communication.

My goal was to model LHMs and create a flat lens from them. This was to be done using the software package XFDTD which solves Maxwell's equations in the frequency domain as well as the time domain. The program used Drude models of materials to simulate the effect of negative permittivity and negative permeability. Because of this, a LHM can be simulated as a solid block of material instead of an array of wires and split ring resonators. After a flat lens is formed, I am to examine the focusing effect of the lens and determine if a higher resolution flat lens can be developed.

**TRAVELING WAVE TUBE (TWT) RF POWER COMBINING  
DEMONSTRATION FOR USE IN THE JUPITER ICY MOONS ORBITER  
(JIMO)**

**Joseph A. Downey**  
The University of Toledo  
Electrical Engineering  
Undergraduate, Freshman  
**Edwin G. Wintucky**

**ABSTRACT**

The Jupiter Icy Moons Orbiter (JIMO) is set to launch between the years 2012 and 2015. It will possibly utilize a nuclear reactor power source and ion engines as it travels to the moons of Jupiter. The nuclear reactor will produce hundreds of kilowatts of power for propulsion, communication and various scientific instruments. Hence, the RF amplification devices aboard will be able to operate at a higher power level and data rate. The initial plan for the communications system is for an output of 1000 watts of RF power, a data rate of at least 10 megabits a second, and a frequency of 32 GHz. A higher data rate would be ideal to fully utilize the instruments aboard JIMO.

At NASA Glenn, one of our roles in the JIMO project is to demonstrate RF power combining using multiple traveling wave tubes (TWT). In order for the power of separate TWT's to be combined, the RF output waves from each must be in-phase and have the same amplitude. Since different tubes act differently, we had to characterize each tube using a Network Analyzer. We took frequency sweeps and power sweeps to characterize each tube to ensure that they will behave similarly under the same conditions. The 200 watt Dornier tubes had been optimized to run at a lower power level (120 watts) for their extensive use in the ACTS program, so we also had to experiment with adjusting the voltage settings on several internal components (helix, anode, collector) of the tubes to reach the full 200 watt potential.

The process began with two 100 watt tubes, a Varian and a Logimetrics, salvaged from the ACTS program. Phase shifters and power attenuators were placed in the waveguide circuit at the inputs to the tubes so that adjustments could be made individually to match them exactly. A magic tee was used to route and combine the amplified electromagnetic RF waves on the tube output side. The demonstration of 200 watts of combined power was successful with efficiencies greater than 90% over a 500 MHz bandwidth. The next step will be to demonstrate the use of three amplifiers using two magic tees by adding a 200 watt Dornier tube to the Varian and Logimetrics combined setup for a total of 400 watts. After that we will use two 200 watt Dorniers for 400 watts and eventually four 200 watt Dornier tubes to demonstrate 800 watts.

After demonstrating the success of power combining, we will need to verify the integrity of a modulated signal sent through the combined tubes. The purpose will be to see what effects separating and recombining will have on the modulated signal and also what effect it will have on combining efficiency. A Bit Error Rate (BER) will be determined by a Bit Error Rate Tester (BERT) by comparing the random information it transmits to what it receives back.

# Statistical and Prediction modeling of the Ka Band Using Experimental Results from ACTS Propagation Terminals at 20.185 and 27.505 GHz

**Oluwatosin O. Ogunwuyi**  
City College of New York  
Electrical Engineering  
**Masters Candidate**  
Mentor: Dr. Roberto J. Acosta

## ABSTRACT

With the increase in demand for wireless communication services, most of the operating frequency bands have become very congested. The increase of wireless costumers is only fractional contribution to this phenomenon. The demand for more services such as video streams and internet explorer which require a lot of band width has been a more significant contributor to the congestion in a communication system. One way to increase the amount of information or data per unit of time transmitted with in a wireless communication system is to use a higher radio frequency. However in spite the advantage available in the using higher frequency bands such as, the Ka-band, higher frequencies also implies short wavelengths. And shorter wavelengths are more susceptible to rain attenuation.

Until the Advanced Communication Technology Satellite (ACTS) was launched, the Ka-band frequency was virtually unused - the majority of communication satellites operated in lower frequency bands called the C- and Ku- bands. Ka-band is desirable because its higher frequency allows wide bandwidth applications, smaller spacecraft and ground terminal components, and stronger signal strength. Since the Ka-band is a high frequency band, the millimeter wavelengths of the signals are easily degraded by rain. This problem known as rain fade or rain attenuation The Advanced Communication Technology Satellite (ACTS) propagation experiment has collected 5 years of Radio Frequency (RF) attenuation data from December 1993 to November 1997.

The objective of my summer work is to help develop the statistics and prediction techniques that will help to better characterize the Ka Frequency band. The statistical analysis consists of seasonal and cumulative five-year attenuation statistics for the 20.2 and 27.5 GHz. The cumulative five-year results give the link outage that occurs for a given link margin. The experiment has seven ground station terminals that can be attributed to a unique rain zone climate. The locations are White Sands, NM, Tampa, Fl, Clarksburg, MD, Norman, OK, Ft. Collins, CO, Vancouver, BC, and Fairbanks, AK. The analysis will help us to develop and define specific parameters that will help system engineers develop the appropriated instrumentation and structure for a Ka-band wireless communication systems and networks.

## **Analysis of Droplet Size during the Ice Accumulation Phase Of Flight Testing**

**Eric James Miller**  
University of Cincinnati  
Aerospace Engineering  
Undergraduate, Sophomore  
**Mentor: Sam Lee**

### **Abstract**

There are numerous hazards associated with air travel. One of the most serious dangers to the pilot and passengers' safety is the result of flying into conditions which are conducive to the formation of ice on the surface of an aircraft. Being a pilot myself I am very aware of the dangers that icing can pose and the effects it can have on an airplane. A couple of the missions of the Icing branch is to make flying safer with more research to increase our knowledge of how ice effects the aerodynamics of an airfoil, and to increase our knowledge of the weather for better forecasting.

The Icing Branch uses three different tools to determine the aerodynamic affects that icing has on a wing. The Icing research tunnel is an efficient way to test various airfoils in a controlled setting. To make sure the data received from the wind tunnel is accurate the Icing branch conducts real flight tests with the DHC-6 Twin Otter. This makes sure that the methods used in the wind tunnel accurately model what happens on the actual aircraft. These two tools are also compared to the LEWICE code which is a program that models the ice shape that would be formed on an airfoil in the particular weather conditions that are input by the user. One benefit of LEWICE is that it is a lot cheaper to run than the wind tunnel or flight tests which make it a nice tool for engineers designing aircraft that don't have the money to spend on icing research. Using all three of these tools is a way to cross check the data received from one and check it against the other two.

The information gathered from these tests is not just used in the aircraft industries, but it is also looked at by weather analysts who are trying to improve forecasting methods. The best way to avoid the troubles of icing encounters is to not go into it in the first place. By looking over the flight data the analyst can determine which conditions will most likely lead to an icing encounter and then this information will aid forecasters when briefing the pilots on the weather conditions.

The project that I am working on will have an effect on the projects just talked about. I am looking at the weather data from certain flights and analyzing the type of precipitation that the plane is flying through. During flight tests there is a probe on the bottom of the aircraft that gathers information on the size and shape of the particles that it is flying through. The data can then be viewed on a computer. After grouping the weather into certain groups we can then pick certain groups which we think should be analyzed farther. The goal is to remove all the ice particles because they do not contribute to the icing on an aircraft. We use a 2D analyzer which measures the droplet size and categorizes the drops into bins of certain sizes. We can then look at what the characteristics of the weather that we were flying through such as the temperature and dew point and compare this with the size of the drops that the 2D analyzer measured. We can then look at what type and shape of ice that formed on the wing during this time period. Having this data will help us to reproduce these conditions using LEWICE and the wind tunnel. Having consistency among the tests will make things more accurate. With respect to weather forecasting we will be able to learn which conditions can lead to icing. Better accuracy in weather reporting will lead to fewer run-ins with icing which will also lead to fewer accidents.

# Graphical User Interface Development for Representing Air Flow Patterns

**Nilika Chaudhary**

Massachusetts Institute of Technology

Engineering (Undecided)

Undergraduate, Sophomore

**Mentor: David Ashpis**

## ABSTRACT

In the Turbine Branch, scientists carry out experimental and computational work to advance the efficiency and diminish the noise production of jet engine turbines. One way to do this is by decreasing the heat that the turbine blades receive. Most of the experimental work is carried out by taking a single turbine blade and analyzing the air flow patterns around it, because this data indicates the sections of the turbine blade that are getting too hot. Since the cost of doing turbine blade air flow experiments is very high, researchers try to do computational work that fits the experimental data. The goal of computational fluid dynamics is for scientists to find a numerical way to predict the complex flow patterns around different turbine blades without physically having to perform tests or costly experiments.

When visualizing flow patterns, scientists need a way to represent the flow conditions around a turbine blade. A researcher will assign specific zones that surround the turbine blade. In a two-dimensional view, the zones are usually quadrilaterals. The next step is to assign boundary conditions which define how the flow enters or exits one side of a zone.

Researchers such as my mentor, Dr. David Ashpis, need a quick, user-friendly way of setting up computational zones and grids, visualizing flow patterns, and storing all the flow conditions in a file on the computer for future computation. Such a program is necessary because the only method for creating flow pattern graphs is by hand, which is tedious and time-consuming. By using a computer program to create the zones and grids, the graph would be faster to make and easier to edit. Basically, the user would run a program that is an editable graph. The user could click and drag with the mouse to form various zones and grids, then edit the locations of these grids, add flow and boundary conditions, and finally save the graph for future use and analysis.

My goal this summer is to create a graphical user interface (GUI) that incorporates all of these elements. I am writing the program in Java, a language that is portable among platforms, because it can run on different operating systems such as Windows and Unix without having to be rewritten. I had no prior experience of programming in Java at the start of my internship; I am continuously learning as I create the program. I have written the part of the program that enables a user to draw several zones, edit them, and store their locations. The next phase of my project is to allow the user to click on the side of a zone and create a boundary condition for it. A previous intern wrote a program that allows the user to input boundary conditions. I can integrate the two programs to create a larger, more usable program. After that, I will develop a way for the user to save the graph for future reference. Another eventual goal is to make the GUI capable of creating three-dimensional zones as well.

# **Glenn Heat Transfer Simulation and Solver Graphical User Interface: Development and Testing**

**Joseph R. Kardamis**  
Rochester Institute of Technology  
Computer Science  
Junior  
**Mentor: Barbara L. Lucci**

## **ABSTRACT**

In the Turbine Branch of the Turbomachinery and Propulsion Systems Division, researching and developing efficient turbine aerothermodynamics technologies is the main objective. Creating effective turbines for jet engines is a process which, if based purely on physical experimental testing, would be extremely expensive. It is for this reason, and also for the reasons of speed and ease, that the Turbine Branch spends a large amount of effort working with simulations of turbines. Specifically, they focus their work on two main fields: Computational Field Dynamics (CFD), and Experimental data analysis. The experimental field involves comparing experimental results to simulated results, whereas the CFD field involves running these simulations. The simulations are applied to aerodynamics and heat transfer cases, for both steady and unsteady flow conditions. By and large this work is applied to the domain of flow and heat transfer in axial turbines.

The main application used to run these heat flow simulations is GlennHT. This program, recently rewritten in FORTRAN 90, allows the user to input a job file which specifies all the necessary parameters needed to simulate flow through a user-defined grid. There are several other executables used as well, ranging in application from converting grid files to and from particular formats, to merging blocks in a connectivity file, to converting connectivity files to a GlennHT compatible format. All of these executables are run from the command line in a terminal; some of them have interactive prompts where the user must specify the files to be manipulated after the program starts, while others take all of their parameters from the command line. With this amount of variation comes a good deal of commands and formats to memorize, which can cause slower and less efficient work, as users may forget how to execute a certain program, or not remember the pathnames of the files they wish to use.

Two years ago, steps were made to expedite this process with a graphical user interface (GUI) that combines the functionality of all the executables along with adding some new functionality, such as residuals graphing and boundary conditions creation. Upon my beginning here at Glenn, many parts of the GUI, which was developed in Java, were nonfunctional. There were also issues with cross-platforming, as systems in the branch were transitioning from Silicon Graphics (SGI) machines to Linux machines. My goals this summer are to finish the parts of the GUI that are not yet completed, fix parts that did not work correctly, expand the functionality to include other useful features, such as grid surface highlighting, and make the system compatible with both Linux and SGI. I will also be heavily testing the system and providing sufficient documentation on how to use the GUI, as no such documentation existed previously.



## Air Separation Using Hollow Fiber Membranes

Stephen E. Huang  
California Polytechnic State University San Luis Obispo  
Environmental Engineering  
Undergraduate Senior  
Mentor: Dr. Clarence T. Chang

### ABSTRACT

The NASA Glenn Research Center in partnership with the Ohio Aerospace Institute provides internship programs for high school and college students in the areas of science, engineering, professional administrative, and other technical areas. During the summer of 2004, I worked with Dr. Clarence T. Chang at NASA Glenn Research Center's combustion branch on air separation using hollow fiber membrane technology.

In light of the accident of Trans World Airline's flight 800, FAA has mandated that a suitable solution be created to prevent the ignition of fuel tanks in aircrafts. In order for any type of fuel to ignite, three important things are needed: fuel vapor, oxygen, and an energy source. Two different ways to make fuel tanks less likely to ignite are reformulating the fuel to obtain a lower vapor pressure for the fuel and or using an On Board Inert Gas Generating System (OBIGGS) to inert the Central Wing Tank.

The United States military currently uses air separation technology and their primary goal is to accomplish the mission, which means that the Air Separation Module (ASM) tends to be bulky and heavy. The primary goal for commercial aviation companies is to transport as much as they can with the least amount of cost and fuel per person, therefore the ASM must be compact and light as possible.

The plan is to take bleed air from the aircraft's engines to pass air through a filter first to remove particulates and then pass the air through the ASM containing hollow fiber membranes. In the lab, there will be a heating element provided to simulate the temperature of the bleed air that will be entering the ASM and analysis of the separated air will be analyzed by a Gas Chromatograph/Mass Spectrometer (GC/MS). The GC/MS will separate the different compounds in the exit streams of the ASM and provide information on the performance of hollow fiber membranes. Hopefully I can develop ways to improve efficiency of the ASM.

The other side of making air travel safer is to reformulate the fuel. Analyses of three different types of jet fuel were analyzed and data was well represented on SAE Paper 982485. Data consisted of the concentrations of over 300 different hydrocarbons commonly found in JP-8, Jet A, and JP-5 fuels. I researched the major hydrocarbons that has a concentration of greater than 50 parts per million and found the vapor pressure data coefficients for a specific temperature range. The coefficients were applied to Antoine's Equation and Riedel's Equation to calculate the vapor pressures for that specific hydrocarbon in the specific temperature range. With the vapor pressure data scientists can formulate a fuel composition that has a lower vapor pressure profile, therefore making jet fuels less flammable.

My goal this summer is to learn about hollow fiber membrane technologies and how they work, learn how to operate and examine the data from Gas Chromatograph and Mass Spectrometer, and develop new ways in applying hollow fiber membrane technology to other areas of environmental engineering.

**“We Burn to Learn” About Fuel-Air Mixing Within Aircraft Powerplants**

**Heidi N. Robinson**  
The University of Akron  
Applied Mathematics  
Graduate Student  
**Mentor: Yolanda R. Hicks, Ph.D.**

**ABSTRACT**

I am working with my branch’s advanced diagnostics team to investigate fuel-air mixing in jet-fueled gas turbine combustors and jet-fuel reformers. Our data acquisition begins with bench-top experiments which will help with calibration of equipment for facility testing. While conducting the bench-top experiments I learned to align laser and optical equipment to collect data, to use the data acquisition software, and to process the data into graphs and images.

Thanks to the Low Emissions Alternate Propulsion project, we have a new facility in which jet fuel is to be reformed into hydrogen. Testing will commence shortly, after which we will obtain and analyze data and meet a critical milestone for the end of September.

I am also designing the layout for a Schlieren system that will be used during that time frame. A Schlieren instrument records changes in the refractive index distribution of transparent media like air flows. The refractive index distribution can then be related to density, temperature, or pressure distributions within the flow. I am working on a scheme to quantify this information and add to the knowledge of the fuel-air mixing process.

# Bubble Combustion

**Jackie Corrigan**

Mechanical Engineering, Sophomore  
University of Dayton

**Mentor: Dr. Quang-Viet Nguyen (Combustion Branch / 5830)**

## ABSTRACT

A method of energy production that is capable of low pollutant emissions is fundamental to one of the four pillars of NASA's Aeronautics Blueprint: Revolutionary Vehicles. Bubble combustion, a new engine technology currently being developed at Glenn Research Center promises to provide low emissions combustion in support of NASA's vision under the Emissions Element because it generates power, while minimizing the production of carbon dioxide ( $\text{CO}_2$ ) and nitrous oxides ( $\text{NO}_x$ ), both known to be Greenhouse gases.

Bubble combustion is a simple process that has no moving parts (increased reliability) and allows the use of alternative fuels such as corn oil, low-grade fuels, and even used motor oil. Bubble combustion is analogous to the inverse of spray combustion: the difference between bubble and spray combustion is that spray combustion is spraying a liquid in to a gas to form droplets, whereas bubble combustion involves injecting a gas into a liquid to form gaseous bubbles. In bubble combustion, the process for the ignition of the bubbles takes place on a time scale of less than a nanosecond and begins with acoustic waves perturbing each bubble. This perturbation causes the local pressure to drop below the vapor pressure of the liquid thus producing cavitation in which the bubble diameter grows, and upon reversal of the oscillating pressure field, the bubble then collapses rapidly with the aid of the high surface tension forces acting on the wall of the bubble. The rapid and violent collapse causes the temperatures inside the bubbles to soar as a result of adiabatic heating. As the temperatures rise, the gaseous contents of the bubble ignite with the bubble itself serving as its own combustion chamber. After ignition, this is the time in the bubble's life cycle where power is generated, and  $\text{CO}_2$ , and  $\text{NO}_x$  among other species, are produced. However, the pollutants  $\text{CO}_2$  and  $\text{NO}_x$  are absorbed into the surrounding liquid. The importance of bubble combustion is that it generates power using a simple and compact device.

We conducted a parametric study using CAVCHEM, a computational model developed at Glenn, that simulates the cavitation collapse of a single bubble in a liquid (water) and the subsequent combustion of the gaseous contents inside the bubble. The model solves the time-dependent, compressible Navier-Stokes equations in one-dimension with finite-rate chemical kinetics using the CHEMKIN package. Specifically, parameters such as frequency, pressure, bubble radius, and the equivalence ratio were varied while examining their effect on the maximum temperature, radius, and chemical species. These studies indicate that the radius of the bubble is perhaps the most critical parameter governing bubble combustion dynamics and its efficiency. Based on the results of the parametric studies, we plan on conducting experiments to study the effect of ultrasonic perturbations on the bubble generation process with respect to the bubble radius and size distribution.

# BATTERY RESISTANCE ANALYSIS OF ISS POWER SYSTEM

**Gregory E. Newstadt**  
Miami University of Ohio  
Electrical Engineering, Physics  
Undergraduate, Junior  
**Mentor: Ann Delleur, Dave McKissock**

## ABSTRACT

The computer package, SPACE (Systems Power Analysis for Capability Evaluation) was created by the members of LT-9D to perform power analysis and modeling of the electrical power system on the International Space Station (ISS). Written in FORTRAN, SPACE comprises thousands of lines of code and has been used proficiently in analyzing missions to the ISS. LT-9D has also used its expertise recently to investigate the batteries onboard the Hubble telescope. During the summer of 2004, I worked with the members of LT-9D, under the care of Dave McKissock.

Solar energy will power the ISS through eight solar arrays when the ISS is completed, although only two arrays are currently connected. During the majority of the periods of sunlight, the solar arrays provide enough energy for the ISS. However, rechargeable Nickel-Hydrogen batteries are used during eclipse periods or at other times when the solar arrays cannot be used (at docking for example, when the arrays are turned so that they will not be damaged by the Shuttle). Thirty-eight battery cells are connected in series, which make up an ORU (Orbital Replacement Unit). An ISS "battery" is composed of two ORUs.

The ISS batteries have been found to be very difficult to model, and LT-9D has dedicated a great deal of time into finding the best way to represent them in SPACE. During my internship, I investigated the resistance of the ISS batteries.

SPACE constructs plots of battery charge and discharge voltages vs. time using a constant current. To accommodate for a time-varying current, the voltages are adjusted using the formula,  $\Delta V = \Delta I * \text{Cell Resistance}$ . To enhance our model of the battery resistance, my research concentrated on several topics: investigating the resistance of a qualification unit battery (using data gathered by LORAL), comparing the resistance of the qualification unit to SPACE, looking at the internal resistance and wiring resistance, and examining the impact of possible recommended changes to SPACE.

My analysis of the qualification unit battery testing (called QM-00) showed that the model for resistance that SPACE and Loral had been using does not apply well to the actual battery resistance as it changes with age. A possible change to accommodate for a more accurate prediction of the change in resistance with age was recommended for inspection. Also, the QM-00 data showed that the resistance during charge periods was consistently greater than the resistance during discharge periods, although this may be due to how the sensors function with current flow. Inspecting the internal resistance and wiring resistance showed that SPACE has been using an overly pessimistic value near 20 mOhms. However, the QM-00 data, along with on-orbit data indicates that this value should be nearer to 3 mOhms. A possible change to accommodate for this smaller internal and wiring resistance was also recommended for inspection. A local version of SPACE that contains these changes was run to test the system impact of the changes. It showed that for an analysis of the current batteries on the ISS, the total resistance was lowered, allowing the batteries to use less voltage during discharge periods and to charge more easily during charge periods.

**Research Symposium II**  
**Ohio Aerospace Institute**  
**Thursday, August 5, 2004**

**OAI Federal Room**

- 9:00 A.M. **Jessica Fedor, University of Notre Dame, Junior**  
"Metal Foam Analysis: Improving Sandwich Structure Technology for Engine Fan and Propeller Blades"  
5920/Bradley Lerch, Life Prediction Branch
- 9:15 **Charlene Dvoracek, Rose-Hulman Institute of Technology, Sophomore**  
"Characterization of Composite Fan Case Resins"  
5930/Cheryl Bowman, Structural Mechanics and Dynamics Branch
- 9:30 **Patrick Kenny, Ohio State University, Freshman**  
"Jet Noise Reduction"  
5940/Clifford Brown, Acoustics Branch
- 9:45 **Joshua France, University of Cincinnati, Sophomore**  
"Fan Noise Prediction"  
5940/Edmane Envia, Acoustics Branch
- 10:00 **Timothy Unton, Embry-Riddle Aero University, Freshman**  
"Improving Rotor-Stator Interaction Noise Code Through Analysis of Input Parameters"  
5940/Edmane Envia, Acoustics Branch
- 10:15 **Marta Bastrzyk, Illinois Institute of Technology, Junior**  
"Solid Oxide Fuel Cells Seals Leakage Setup and Testing"  
5950/Christopher Daniels, Mechanical Components Branch
- 10:30 **Vivake Asnani, Ohio State University, Masters**  
"Experimentation Toward the Analysis of Gear Noise Sources Controlled by Sliding Friction and Surface Roughness"  
5950/Timothy Krantz, Mechanical Components Branch
- 10:45 **Christina Maldonado, University of Toledo, Freshman**  
"Determining the Thermal Properties of Space Lubricants"  
5950/Wilfredo Morales, Mechanical Components Branch
- 11:00 **LUNCH**
- 1:00 **Joshua Neville, Ohio University, PhD**  
"Wireless Channel Characterization in the Airport Surface Environment"  
6120/Israel Greenfeld, Project Development Branch
- 1:15 **Justine Casselle, Xavier University, Freshman**  
"Resource Management in the Microgravity Science Division"  
6701/Janice Gassaway, Business Management Office

**1:30 Heather Angel, Colorado School of Mines, Junior**

“Using Piezoelectric Ceramics for Dust Mitigation on Space Suits”

6712/Juan Agui, Microgravity Fluid Physics Branch

**1:45 Phi Hung X Thanh, Colorado School of Mines, Junior**

“Wave Propagation in 2-D Granular Matrix and Dust Mitigation of Fabrics for Space Exploration Mission”

6712/Juan Agui, Microgravity Fluid Physics Branch

**2:00 Chad Zivich, Case Western Reserve University, Senior**

“Microgravity Spray Cooling Research for High Powered Laser Applications”

6712/Eric Gollhofer, Microgravity Fluid Physics Branch

**2:15 Arati Deshpande, Ohio State University, Freshman**

“The Effects of Protein Regulators on the Vascular Remodeling of Japanese Quail Chorioallantoic Membrane”

6712/Patricia Parsons-Wingter, Microgravity Fluid Physics Branch

**2:30 Lauren Makuch, Penn State University, Senior**

“Response of Mineralizing and Non-Mineralizing Bone Cells to Fluid Flow: an *In Vitro* Model for Mechanotransduction”

6712/Gregory Zimmerli, Microgravity Fluid Physics Branch

**2:45 Julie Holda, Ohio Northern University, Senior**

“Methodology for Evaluation of Technology Impacts in Space Electric Power Systems”

6920/Jose Davis, Analysis and Management Branch

**3:00 Tamarcus Jeffries, Tennessee State University, Junior**

“Motor/Generator and Inverter Characterization for Flywheel System Applications”

5450/Walter Santiago, Electrical Systems Development Branch

**3:15 Christopher Dorais, Nashville State Technical Community College, Sophomore**

“Dissemination of information about the technologies of the Vision Research Lab through the World Wide Web”

6712/Rafat Ansari, Microgravity Fluid Physics Branch

**3:30 ADJOURN**

# METAL FOAM ANALYSIS: IMPROVING SANDWICH STRUCTURE TECHNOLOGY FOR ENGINE FAN AND PROPELLER BLADES

**Jessica L. Fedor**  
University of Notre Dame  
Mechanical Engineering  
Undergraduate, Junior  
**Mentor: Bradley A. Lerch**

## ABSTRACT

The Life Prediction Branch of the NASA Glenn Research Center is searching for ways to construct aircraft and rotorcraft engine fan and propeller blades that are lighter and less costly. One possible design is to create a sandwich structure composed of two metal faces sheets and a metal foam core. The face sheets would carry the bending loads and the foam core would have to resist the transverse shear loads.

Metal foam is ideal because of its low density and energy absorption capabilities, making the structure lighter, yet still stiff. The material chosen for the face sheets and core was 17-4PH stainless steel, which is easy to make and has appealing mechanical properties. This material can be made inexpensively compared to titanium and polymer matrix composites, the two current fan blade alternatives.

Initial tests were performed on design models, including vibration and stress analysis. These tests revealed that the design is competitive with existing designs; however, some problems were apparent that must be addressed before it can be implemented in new technology. The foam did not hold up as well as expected under stress. This could be due to a number of issues, but was most likely a result of a large number of pores within the steel that weakened the structure. The brazing between the face sheets and the foam was also identified as a concern. The braze did not hold up well under shear stress causing the foam to break away from the face sheets.

My role in this project was to analyze different options for improving the design. I primarily spent my time examining various foam samples, created with different sintering conditions, to see which exhibited the most favorable characteristics for our purpose. Methods of analysis that I employed included examining strut integrity under a microscope, counting the number of cells per inch, measuring the density, testing the microhardness, and testing the strength under compression. Shear testing will also be done to examine the strengths of different types of brazes.

# CHARACTERIZATION OF COMPOSITE FAN CASE RESINS

**Charlene M. Dvoracek**  
Rose-Hulman Institute of Technology  
Mechanical Engineering  
Undergraduate, Sophomore  
**Mentors: Cheryl L. Bowman**  
**Gary D. Roberts**

## ABSTRACT

The majority of commercial turbine engines that power today's aircraft use a large fan driven by the engine core to generate thrust which dramatically increases the engine's efficiency. However, if one of these fan blades fails during flight, it becomes high energy shrapnel, potentially impacting the engine or puncturing the aircraft itself and thus risking the lives of passengers. To solve this problem, the fan case must be capable of containing a fan blade should it break off during flight. Currently, all commercial fan cases are made of either just a thick metal barrier or a thinner metal wall surrounded by Kevlar—an ultra strong fiber that elastically catches the blade. My summer 2004 project was to characterize the resins for a composite fan case that will be lighter and more efficient than the current metal.

The composite fan case is created by braiding carbon fibers and injecting a polymer resin into the braid. The resin holds the fibers together, so at first using the strongest polymer appears to logically lead to the strongest fan case. Unfortunately, the stronger polymers are too viscous when melted. This makes the manufacturing process more difficult because the polymer does not flow as freely through the braid, and the final product is less dense. With all of this in mind, it is important to remember that the strength of the polymer is still imperative; the case must still contain blades with high impact energy. The research identified which polymer had the right balance of properties, including ease of fabrication, toughness, and ability to transfer the load to the carbon fibers. Resin deformation was studied to better understand the composite response during high speed impact. My role in this research was the testing of polymers using dynamic mechanical analysis and tensile, compression, and torsion testing.

Dynamic mechanical analysis examines the response of materials under cyclic loading. Two techniques were used for dynamic mechanical analysis. The ARES Instrument analyzed the material through torsion. The second machine, TA Instruments' apparatus, applied a bending force to the specimen. These experiments were used to explore the effects of temperature and strain rate on the stiffness and strength of the resins. The two different types of loading allowed us to verify our results. An axial-torsional load frame, manufactured by MTS Systems, Inc., was used to conduct the tensile, compression, and torsional testing. These tests were used to determine the stress-strain curves for the resins. The elastic and plastic deformation data was provided to another team member for characterization of high fidelity material property predictions.

This information was useful in having a better understanding of the polymers so that the fan cases could be as sturdy as possible. Deformation studies are the foundation for the computational modeling that provides the structural design of a composite engine case as well as detailed analysis of the blade impact event.



## **Jet Noise Reduction**

**Patrick Kenny**

Ohio State University  
Electrical Engineering

Freshman

**Mentor: Clifford Brown**

### **ABSTRACT**

The Acoustics Branch is responsible for reducing noise levels for jet and fan components on aircraft engines. To do this, data must be measured and calibrated accurately to ensure validity of test results. This noise reduction is accomplished by modifications to hardware such as jet nozzles, and by the use of other experimental hardware such as fluidic chevrons, elliptic cores, and fluidic shields. To insure validity of data calibration, a variety of software is used. This software adjusts the sound amplitude and frequency to be consistent with data taken on another day. Both the software and the hardware help make noise reduction possible.

The task was to test the data reduction software and ensure that the programs work properly. These software programs were designed to make corrections for atmosphere, shear, attenuation, electronic, and background noise. All data can be converted to a one-foot lossless condition, using the proper software corrections, making a reading independent of weather and distance. Also, data can be transformed from model scale to full scale for noise predictions of a real flight. Other programs included calculations of Over All Sound Pressure Level (OASPL), Effective Perceived Noise Level (EPNL). OASPL is the integration of sound with respect to frequency, and EPNL is weighted for a human's response to different sound frequencies and integrated with respect to time. With the proper software correction, data taken in the NATR are useful in determining ways to reduce noise.

To test the software correction programs, a comparison program was written to display any difference between two or more data files. Using this program and graphs of the data, the actual and predicted data can be compared. This software was tested on data collected at the Aero Acoustic Propulsion Laboratory (AAPL) using a variety of window types and overlaps. Similarly, short scripts were written to test each individual program in the software suite for verification. Each graph displays both the original points and the adjusted points connected with lines.

During this summer, data points were taken during a live experiment at the AAPL to measure Nozzle Acoustic Test Rig (NATR) background noise levels. Six condenser microphones were placed in strategic locations around the dome and the inlet tunnel to measure different noise sources. From the control room the jet was monitored with the help of video cameras and other sensors. The data points were recorded, reduced, and plotted, and will be used to plan future modifications to the NATR.

The primary goal to create data reduction test programs and provide verification was completed. As a result of the internship, I learned C/C++, UNIX/LINUX, Excel, and acoustic data processing methods. I also recorded data at the AAPL, then processed and plotted it. These data would be useful to compare against existing data. In addition, I adjusted software to work on the Mac OSX platform. And I used the available training resources.

## **Fan Noise Prediction**

**Joshua I. France**

University of Cincinnati

Aerospace Engineering

Undergraduate, Sophomore

**Mentor: Dr. Edmane Eniva**

### **ABSTRACT**

Aircraft noise emission level restrictions in and around airports continue to grow more stringent every few years. Thus, it is important to predict noise emissions from aircraft accurately. Predicting noise from the engine(s) is an integral part of the efforts to characterize the noise signature of an aircraft. An important source of engine noise is the rotor-stator interaction noise produced as a result of impingement of fan rotor wakes on the fan exit guide vanes. Interaction noise propagates through the inlet and exhaust ducts of the engine and radiates to the far field.

The subject of this study is to compare the predicted to the measured far field noise levels for a range of model fans stages that represent current aircraft engine designs. Eversman's radiation codes calculate both the inlet and exhaust noise radiation by propagating the internally measured rotor-stator interaction noise to the far field. Predicted far field sound pressure levels are then compared to the measured levels from wind tunnel tests. This effort's objective is to prove that the predicted levels actually describe the measured levels.

# **Improving Rotor-Stator Interaction Noise Code Through Analysis of Input Parameters**

**Timothy J. Unton**

Embry-Riddle Aeronautical University

Aerospace Engineering

Undergraduate, Freshman

**Mentor: Dr. Edmane Envia**

## **ABSTRACT**

There are two major sources of aircraft noise. The first is from the airframe and the second is from the engines. The focus of the acoustics branch at NASA Glenn is on the engine noise sources. There are two major sources of engine noise; fan noise and jet noise. Fan noise, produced by rotating machinery of the engine, consists of both tonal noise, which occurs at discrete frequencies, and broadband noise, which occurs across a wide range of frequencies. The focus of my assignment is on the broadband noise generated by the interaction of fan flow turbulence and the stator blades.

The objective of this study is to investigate the influence of geometric parameters such as the sweep and stagger angles and blade count, as well as the flow parameters such as intensity of turbulence in the flow. The tool I employed in this work is a computer program that predicts broadband noise from fans. The program assumes that the complex shape of the curved blade can be represented as a single flat plate, allowing it to use fairly simple equations that can be solved in a reasonable amount of time. While the results from such representation provided reasonable estimates of the broadband noise levels, they did not usually represent the entire spectrum accurately. My investigation found that the discrepancy between data and theory can be improved if the leading edge and the trailing edge of the blade are treated separately. Using this approach, I reduced the maximum error in noise level from a high of 30% to less than 5% for the cases investigated. Detailed results of this investigation will be discussed at my presentation.

# SOLID OXIDIZED FUEL CELLS SEALS LEAKAGE SETUP AND TESTING

**Marta B. Bastrzyk**

Illinois Institute of Technology in Chicago  
Aerospace Engineering and Applied Mathematics  
Junior

**Mentor: Christopher C. Daniels**

## ABSTRACT

As the world's reserves of fossil fuels are depleted, the U.S. Government, as well as other countries and private industries, is researching solutions for obtaining power, answers that would be more efficient and environmentally friendly. For a long time engineers have been trying to obtain the benefits of clean electric power without heavy batteries or pollution-producing engines. While some of the inventions proved to be effective (i.e. solar panels or windmills) their applications are limited due to dependency on the energy source (i.e. sun or wind). Currently, as energy concerns increase, research is being carried out on the development of a Solid Oxide Fuel Cell (SOFC). The United States government is taking a proactive role in expanding the technology through the Solid State Energy Conversion Alliance (SECA) Program, which is coordinated by the Department of Energy.

A fuel cell is an electrochemical device that converts the chemical energy in fuels into an electrical energy. This occurs by the means of natural tendency of oxygen and hydrogen to chemically react. While controlling the process, it is possible to harvest the energy given off by the reaction. SOFCs use currently available fossil fuels and convert a variety of those fuels with very high efficiency (about 40% more efficient than modern thermal power plants). At the same time they are almost entirely nonpolluting and due to their size they can be placed in remote areas. The main fields where the application of the fuel cells appears to be the most useful for are stationary energy sources, transportation, and military applications.

However, before the SOFC technology can be fully operational, issues with its structure and materials must be resolved. All the components must be operational in harsh environments including temperatures reaching 800°C and cyclic thermal-mechanical loading. Under these conditions, the main concern is the requirement for hermetic seals to (1) prevent mixing of the fuel and oxidant within the stack, (2) prevent parasitic leakage of the fuel from the stack, (3) prevent contamination of the anode by air leaking into the stack, (4) electrically isolate the individual cells within the stack, and (5) mechanically bond the cell components. The sealing challenges are aggravated by the need to maintain hermetic boundaries between the different flow paths within the fuel cell throughout cycled operation. Within the timeframe of my tenure, the main objective is to assist in building a state-of-art test facility.

# EXPERIMENTATION TOWARD THE ANALYSIS OF GEAR NOISE SOURCES CONTROLLED BY SLIDING FRICTION AND SURFACE ROUGHNESS

**Vivake M. Asnani**

The Ohio State University

B.S. Electrical and Computer Engineering

M.S. Mechanical Engineering (In Progress)

Graduate Student

**Mentor: Dr. Timothy L Krantz**

## ABSTRACT

In helicopters and other rotorcraft, the gearbox is a major source of noise and vibration (N&V). The two N&V excitation mechanisms are the relative displacements between mating gears (transmission errors) and the friction associated with sliding between gear teeth. Historically, transmission errors have been minimized via improved manufacturing accuracies and tooth modifications. Yet, at high torque loads, noise levels are still relatively high though transmission errors might be somewhat minimal. This suggests that sliding friction is indeed a dominant noise source for high power density rotorcraft gearboxes. In reality, friction source mechanism is associated with surface roughness, lubrication regime properties, time-varying friction forces/torques and gear-mesh interface dynamics. Currently, the nature of these mechanisms is not well understood, while there is a definite need for analytical tools that incorporate sliding resistance and surface roughness, and predict their effects on the vibro-acoustic behavior of gears. Toward this end, an experiment was conducted to collect sound and vibration data on the NASA Glenn Gear-Noise Rig. Three iterations of the experiment were accomplished: Iteration 1 tested a baseline set of gears to establish a benchmark. Iteration 2 used a gear-set with low surface asperities to reduce the sliding friction excitation. Iteration 3 incorporated low viscosity oil with the baseline set of gears to examine the effect of lubrication. The results from this experiment will contribute to a two year project in collaboration with the Ohio State University to develop the necessary mathematical and computer models for analyzing geared systems and explain key physical phenomena seen in experiments. Given the importance of sliding friction in the gear dynamic and vibro-acoustic behavior of rotorcraft gearboxes, there is considerable potential for research & developmental activities. Better models and understanding will lead to quiet and reliable gear designs, as well as the selection of optimal manufacturing processes.

## Determining the Thermal Properties of Space Lubricants

Christina M. Maldonado  
University of Toldeo  
Chemical Engineering  
Undergraduate  
Mentor: Wilfredo Morales

### Abstract

Many mechanisms used in spacecrafts, such as satellites or the space shuttle, employ ball bearings or gears that need to be lubricated. Normally this is not a problem, but in outer space the regular lubricants that are used on Earth will not function properly. Regular lubricants will quickly vaporize in the near vacuum of space. A unique liquid called a perfluoropolyalkylether (PFPE) has an extremely low vapor pressure, around  $10^{-10}$  torr at  $20^{\circ}\text{C}$ , and has been used in numerous satellites and is currently used in the space shuttle. Many people refer to the PFPEs as "liquid Teflon". PFPE lubricants however, have a number of problems with them. Lubricants need many soluble additives, especially boundary and anti-wear additives, in them to function properly. All the regular known boundary additives are insoluble in PFPEs and so PFPEs lubricate poorly under highly loaded conditions leading to many malfunctioning ball bearings and gears. JAXA, the Japanese Space Agency, is designing and building a centrifuge rotor to be installed in the International Space Station. The centrifuge rotor is part of a biology lab module. They have selected a PFPE lubricant to lubricate the rotor's ball bearings and NASA bearing experts feel this is not a wise choice. An assessment of the centrifuge rotor design is being conducted by NASA and part of the assessment entails knowing the physical and thermal properties of the PFPE lubricant. One important property, the thermal diffusivity, is not known. An experimental apparatus was set up in order to measure the thermal diffusivity of the PFPE. The apparatus consists of a constant temperature heat source, cylindrical Pyrex glassware, a thermal couple and digital thermometer. The apparatus was tested and calibrated using water since the thermal diffusivity of water is known.

# **Wireless Channel Characterization in the Airport Surface Environment**

**Joshua T. Neville**  
Ohio University  
Electrical Engineering  
PhD Student  
**Mentor: Israel Greenfeld**

## **ABSTRACT**

Given the anticipated increase in air traffic in the coming years, modernization of the National Airspace System (NAS) is a necessity. Part of this modernization effort will include updating current communication, navigation, and surveillance (CNS) systems to deal with the increased traffic as well as developing advanced CNS technologies for the systems.

An example of such technology is the integrated CNS (ICNS) network being developed by the Advanced CNS Architecture and Systems Technology (ACAST) group for use in the airport surface environment. The ICNS network would be used to convey voice/data between users in a secure and reliable manner. The current surface system only supports voice and does so through an obsolete physical infrastructure. The old system is vulnerable to outages and costly to maintain.

The proposed ICNS network will include a wireless radio link. To ensure optimal performance, a thorough and accurate characterization of the channel across which the link would operate is necessary. The channel is the path the signal takes from the transmitter to the receiver and is prone to various forms of interference. Channel characterization involves a combination of analysis, simulation, and measurement.

My work this summer was divided into four tasks. The first task required compiling and reviewing reference material that dealt with the characterization and modeling of aeronautical channels. The second task involved developing a systematic approach that could be used to group airports into classes, e.g. small airfields, medium airports, large open airports, large cluttered airports, etc. The third task consisted of implementing computer simulations of existing channel models. The fourth task entailed measuring possible interference sources in the airport surface environment via a spectrum analyzer.

## **Resource Management in the Microgravity Science Division**

**Justine Casselle**  
Xavier University  
International Business  
Undergraduate, Freshman  
**Mentor: Margie Allen**

### **ABSTRACT**

In the Microgravity Science Division, the primary responsibilities of the Business Management Office are resource management and data collection. Resource management involves working with a budget to do a number of specific projects, while data collection involves collecting information such as the status of projects and workforce hours. This summer in the Business Management Office I assisted Margie Allen with resource planning and the implementation of specific microgravity projects.

One of the main duties of a Project Control Specialist, such as my mentor, is to monitor and analyze project manager's financial plans. Project managers work from the bottom up to determine how much money their project will cost. They then set up a twelve month operating plan which shows when money will be spent. I assisted my mentor in checking for variances in her data against those of the project managers.

In order to successfully check for those variances, we had to understand: where the project is including plans vs. actual performance, why it is in its present condition, and what the future impact will be based on known budgetary parameters. Our objective was to make sure that the plan, or estimated resources input, are a valid reflection of the actual cost. To help with my understanding of the process, over the course of my tenure I had to obtain skills in Microsoft Excel and Microsoft Access.



# USING PIEZOELECTRIC CERAMICS FOR DUST MITIGATION ON SPACE SUITS

**Heather K. Angel**

Colorado School of Mines

Mechanical Engineering

Undergraduate Junior

**Mentors: Juan H. Agui and Masami Nakagawa**

## ABSTRACT

The particles that make up moon dust and Mars soil can be hazardous to an astronaut's health if not handled properly. In the near future, while exploring outer space, astronauts plan to wander the surfaces of unknown planets. During these explorations, dust and soil will cling to their space suits and become imbedded in the fabric. The astronauts will track moon dust and mars soil back into their living quarters. This not only will create a mess with millions of tiny air-borne particles floating around, but will also be dangerous in the case that the fine particles are breathed in and become trapped in an astronaut's lungs.

In order to mitigate this problem, engineers and scientists at the NASA-Glenn research center are investigating ways to remove these particles from space suits. This problem is very difficult due to the nature of the particles: They are extremely small and have jagged edges which can easily latch onto the fibers of the fabric. For the past summer, I have been involved in researching the potential problems, investigating ways to remove the particles, and conducting experiments to validate the techniques.

The current technique under investigation uses piezoelectric ceramics imbedded in the fabric that vibrate and shake the particles free. The particles will be left on the planet's surface or collected a vacuum to be disposed of later. The ceramics vibrate when connected to an AC voltage supply and create a small scale motion similar to what people use at the beach to shake sand off of a beach towel. Because the particles are so small, similar to volcanic ash, caution must be taken to make sure that this technique does not further imbed them in the fabric and make removal more difficult. Only a very precise range of frequency and voltage will produce a suitable vibration. My summer project involved many experiments to determine the correct range. Analysis involved hands on experience with oscilloscopes, amplifiers, piezoelectrics, a high speed camera, microscopes and computers.

Further research and experiments are planned to better understand and ultimately perfect this technology. Someday, vibration to remove dust may a vital component to the space exploration program.

# Wave Propagation in 2-D Granular Matrix and Dust Mitigation of Fabrics for Space Exploration Mission

**Phi Hung X. Thanh**

Colorado School of Mines

Physics/Mechanical Engineering

Undergraduate, Junior

**Mentor: Juan Agui and Masami Nakagawa**

## ABSTRACT

Wave Propagation study is essential to exploring the soil on Mars or Moon and Dust Mitigation is a necessity in terms of crew's health in exploration missions.

The study of Dust Mitigation has a significant impact on the crew's health when astronauts track dust back into their living space after exploration trips. We are trying to use piezoelectric fiber to create waves and vibrations at certain critical frequencies and amplitudes so that we can shake the particles off from the astronaut's fabrics. By shaking off the dust and removing it, the astronauts no longer have to worry about breathing in small and possibly hazardous materials, when they are back in their living quarters.

The Wave Propagation in 2-D Granular Matrix studies how the individual particles interact with each other when a pressure wave travels through the matrix. This experiment allows us to understand how wave propagates through soils and other materials. By knowing the details about the interactions of particles when they act as a medium for waves, we can better understand how wave propagates through soils and other materials. With this experiment, we can study how less gravity effects the wave propagation and hence device a way to study soils in space and on Moon or Mars.

Some scientists treat the medium that waves travel through as a "black box," they did not pay much attention to how individual particles act as wave travels through them. With this data, I believe that we can use it to model ways to measure the properties of different materials such as density and composition.

In order to study how the particles interact with each other, I have continued Juan Agui's experiment of the effects of impacts on a 2-D matrix. By controlling the inputs and measuring the outputs of the system, I will be able to study now the particles in that system interact with each other. I will also try to model this with the software called PFC<sup>2D</sup> in order to obtain theoretical data to compare with the experiment.

PFC-2D is a program that allows the user to control the number of particles, the particle's characteristic, and the environment of the particle. With this I can run simulations that mimic the impulse test. This software uses a language called FISH, probably created by the creator of the software. This means that in order to model anything, one must use the command terminal instead of GUI's. I will also use this program to simulate the Moon/Mars simulate adhering to the fabric for the Dust Mitigation project.

My goals for this summer are just to complete preliminary studies of the feasibility of the Shaking Fabric, learn the PFC-2D program, and to complete building and testing the wave propagation experiment.

## Microgravity Spray Cooling Research for High Powered Laser Applications

Chad P. Zivich  
Case Western Reserve University  
Mechanical Engineering  
Senior Undergraduate  
Mentor: Eric L. Golliher

### ABSTRACT

An extremely powerful laser is being developed at Goddard Space Flight Center for use on a satellite. This laser has several potential applications. One application is to use it for upper atmosphere weather research. In this case, the laser would reflect off aerosols in the upper atmosphere and bounce back to the satellite, where the aerosol velocities could be calculated and thus the upper atmosphere weather patterns could be monitored. A second application would be for the U.S. Air Force, which wants to use the laser strategically as a weapon for satellite defense. The Air Force fears that in the coming years as more and more nations gain limited space capabilities that American satellites may become targets, and the laser could protect the satellites.

Regardless of the ultimate application, however, a critical step along the way to putting the laser in space is finding a way to efficiently cool it. While operating the laser becomes very hot and must be cooled to prevent overheating. On earth, this is accomplished by simply running cool tap water over the laser to keep it cool. But on a satellite, this is too inefficient. This would require too much water mass to be practical. Instead, we are investigating spray cooling as a means to cool the laser in microgravity. Spray cooling requires much less volume of fluid, and thus could be suitable for use on a satellite.

We have inherited a 2.2 second Drop Tower rig to conduct our research with. In our experiments, water is pressurized with a compressed air tank and sprayed through a nozzle onto our test plate. We can vary the pressure applied to the water and the temperature of the plate before an experiment trial. The whole process takes place in simulated microgravity in the 2.2 second Drop Tower, and a high speed video camera records the spray as it hits the plate.

We have made much progress in the past few weeks on these experiments. The rig originally did not have the capability to heat the test plate, but I did some heat transfer calculations and picked out a heater to order for the rig. I learned QBasic programming language to change the operating code for our drops, allowing us to rapidly cycle the spray nozzle open and closed to study the effects. We have derived an equation for flow rate vs. pressure for our experiment. We have recorded several videos of drops at different pressures, some with heated test plate and some without, and have noticed substantial differences in the liquid behavior. I have also changed the computer program to write a file with temperature vs. time profiles for the test plate, and once the necessary thermocouple comes in (it was ordered last week), we will have temperature profiles to accompany the videos.

Once we have these temperature profiles to go with the videos, we will be able to see how the temperature is affected by the spray at different pressures, and how the spray changes its behavior once as the plate changes from hot to cool. With quantitative temperature data, we can then mathematically model the heat transfer from the plate to the cooling spray. Finally, we can look at the differences between trials in microgravity and those in normal earth gravity.

# **The Effects of Protein Regulators on the Vascular Remodeling of Japanese Quail Chorioallantoic Membrane**

**Arati Deshpande**  
Ohio State University  
Health Sciences  
Freshman

**Mentor: Patricia Parsons-Wingenter & Glenda Yee**

## **ABSTRACT**

Contributing to NASA's mission, the Microgravity Fluid Physics research program conducts experiments to promote space exploration and improvement of processes and products on Earth. One of the projects through this program deals with the affect of regulators on vascular remodeling and angiogenesis.

This project is being led by Dr. Patricia Parsons-Wingenter. To perform the experiments, protein regulators are tested on the chorioallantoic membrane (CAM) of the Japanese quail embryos. The different types of regulators used can be broken down into two major groups of stimulators, and inhibitors. Stimulators increase the rate of blood vessel growth and inhibitors decrease of blood vessel growth. The specified regulator proteins include thrombospondin 1 (TSP-1) and a novel vessel tortuosity factor (TF), these are just the ones used in this specific experiment; other various protein regulators can also be used. The novel vessel tortuosity factor (TF) is a special kind of stimulator because it stimulates vessel tortuosity and curvature, rather than actual blood vessel growth. These regulators are being tested on Japanese quail embryos. The Japanese quail embryos naturally form a chorioallantoic membrane (CAM) from which blood flow, vascular remodeling, and angiogenesis can be observed. Chorioallantoic membranes are also easier to use because they are two dimensional when mounted onto a slide for examination. The analysis of the affect of the regulators on the CAM can be studied through PIVPROC; the program is used to analyze the altered blood flow in response to application of TF.

Regulators are being thoroughly studied because cardiovascular alterations are the second highest, NASA-defined, risk categories in human space exploration. This research done on the quail is extending to even more projects that will be done on lab animals such as mice and also in human clinical studies like the diabetic retina. Not only will this research be beneficial to further space exploration, but it will also help life here on Earth. The higher understanding of the formation of blood vessels can also help further research in health problems such as diabetes and heart disease.

# RESPONSE OF MINERALIZING AND NON-MINERALIZING BONE CELLS TO FLUID FLOW: AN *IN VITRO* MODEL FOR MECHANOTRANSDUCTION

**Lauren A. Makuch**

Penn State University

Biochemistry and Molecular Biology

Senior

**Mentors: Gregory A. Zimmerli and Nicole R. Compitello**

## ABSTRACT

Humans reach peak bone mass at age 30. After this point, we lose 1 to 2 percent of bone mass each decade. In the microgravity environment of space, astronauts lose bone mass at an accelerated rate of 1 to 2 percent each month. When astronauts travel to Mars, they may be in space for as long as 3 years. During this time, they may lose about half of their bone mass from weight-bearing bones. This loss may be irreversible. The drastic loss in bone that astronauts experience in space makes them much more vulnerable to fractures. In addition, the corresponding removal of calcium from bone results in higher levels of calcium in the blood, which increases the risk of developing kidney stones. Currently, studies are being conducted which investigate factors governing bone adaptation and mechanotransduction.

Bone is constantly adapting in response to mechanical stimuli. Increased mechanical loading stimulates bone formation and suppresses bone resorption. Reduction in mechanical loading caused by bedrest, disuse, or microgravity results in decreased bone formation and possibly increased bone resorption. Osteoblasts and osteoclasts are the two main cell types that participate in bone remodeling. Osteoblasts are anabolic (bone-forming) cells and osteoclasts are catabolic (bone-resorbing) cells. In microgravity, the activity of osteoblasts slows down and the activity of osteoclasts may speed up, causing a loss of bone density.

Mechanotransduction, the molecular mechanism by which mechanical stimuli are converted to biochemical signals, is not yet understood. Exposure of cells to fluid flow imposes a shear stress on the cells. Several studies have shown that the shear stress that results from fluid flow induces a cellular response similar to that induced by mechanical loading. Thus, fluid flow can be used as an *in vitro* model to simulate the mechanical stress that bone cells experience *in vivo*. Previous *in vitro* studies have shown that fluid flow induces several responses in osteoblasts, including increased proliferation, osteoblastic differentiation, alkaline phosphatase activity, and production of nitric oxide, prostaglandins, and osteopontin. Several proteins have been implicated in osteoblastic mechanotransduction including Bone Morphogenetic Protein-2 (BMP-2), parathyroid hormone, 1,25-dihydroxyvitamin D3 receptor, osteopontin (OPN), osteoprotegerin (OPG), and alkaline phosphatase (AP). We will characterize relative levels of each protein in mineralizing or non-mineralizing MC3T3 osteoblastic cells that have been exposed to fluid flow compared to non-fluid flow using immunofluorescent staining and two-photon laser microscopy as well as western blotting. Because calcium-mediated pathways are important in osteoblastic signaling, we will transfect MC3T3 cells with cameleon probes for Ca<sup>2+</sup> containing YFP and CFP. Results will be analyzed using FRET/ FLIM to study differential release of intracellular Ca<sup>2+</sup> in response to fluid flow and conditions inducing matrix mineralization. In addition, we plan to conduct several microarray experiments to determine differential gene expression in MC3T3 cells in response to fluid flow and conditions inducing mineralization.

# METHODOLGY FOR EVALUATION OF TECHNOLOGY IMPACTS IN SPACE ELECTRIC POWER SYSTEMS

**Julie Holda**

Ohio Northern University

Mathematics/Statistics

Undergraduate, Senior

**Mentors: Jose Davis and Timothy Sarver-Verhey**

## ABSTRACT

The Analysis and Management branch of the Power and Propulsion Office at NASA Glenn Research Center is responsible for performing complex analyses of the space power and In-Space propulsion products developed by GRC. This work quantifies the benefits of the advanced technologies to support on-going advocacy efforts. The Power and Propulsion Office is committed to understanding how the advancement in space technologies could benefit future NASA missions. They support many diverse projects and missions throughout NASA as well as industry and academia.

The area of work that we are concentrating on is space technology investment strategies. Our goal is to develop a Monte-Carlo based tool to investigate technology impacts in space electric power systems. The framework is being developed at this stage, which will be used to set up a computer simulation of a space electric power system (EPS). The outcome is expected to be a probabilistic assessment of critical technologies and potential development issues. We are developing methods for integrating existing spreadsheet-based tools into the simulation tool. Also, work is being done on defining interface protocols to enable rapid integration of future tools.

The first task this summer was to evaluate, install, and integrate the various Monte Carlo-based simulation programs for statistical modeling of the EPS Model. I decided to learn and evaluate Palisade's @Risk and Risk Optimizer software, and utilize it's capabilities for the Electric Power System (EPS) model. I also looked at similar software packages (JMP, SPSS, Crystal Ball, VenSim, Analytica) available from other suppliers and evaluated them.

The second task was to develop the framework for the tool, in which we had to define technology characteristics using weighing factors and probability distributions. Also we had to define the simulation space and add hard and soft constraints to the model.

The third task is to incorporate (preliminary) cost factors into the model. A final task is developing a cross-platform solution of this framework.

## **Motor/Generator and Inverter Characterization for Flywheel System Applications**

**Tamarcus L. Jeffries**  
Tennessee State University  
Electrical Engineering  
Undergraduate: Senior  
**Mentor: Mr. Walter Santiago**

---

### ***Abstract:***

The Advanced Electrical Systems Development Branch at NASA Glenn Research Center (GRC) has been involved in the research and development of high speed flywheels systems for satellite energy storage and attitude applications. These flywheels will serve as replacement for chemical nickel hydrogen, nickel cadmium batteries and gyroscopic wheels. The advantages of using flywheel systems for energy storage on satellites are high energy density, high power density, long life, deep depth of discharge, and broad operating temperature ranges.

A flywheel system for space applications consist of a number of flywheel modules, the motor/generator and magnetic bearing, and an electronics package. The motor/generator electronics package includes a pulse-width modulated inverter that drives the flywheel permanent magnet motor/generator located at one end of the shaft.

This summer, I worked under the direct supervision of my mentor, Walter Santiago, and the goal for this summer was to characterize motor generator and inverter attributes in order to increase their viability as a more efficient energy storage source for space applications. To achieve this goal, magnetic field measurements around the motor/generator permanent magnet and the impedance of the motor/generator three phase windings were characterized, and a recreation of the inverter pulse width modulated control system was constructed.

The Flywheel modules for space use are designed to maximize energy density and minimize loss, and attaining these values will aid in locating and reducing losses within the flywheel system as a whole, making flywheel technology more attractive for use as energy storage in future space applications.

**Dissemination of information about the technologies of the Vision Research Lab  
through the World Wide Web.**

**Christopher M. Dorais**  
Nashville State Community College  
Electronic Engineering Technologies  
Sophomore  
**Mentor: Rafat Ansari**

**Abstract**

The Vision Research Lab at NASA John Glenn Research Center is headed by Dr. Rafat Ansari. Dr. Ansari and other researchers have developed technologies that primarily use laser and fiber optics to non-invasively detect different ailments and diseases of the eye. One of my goals as a LERCIP intern and ACCESS scholar for the 2004 summer is to inform other NASA employees, researchers and the general public about these technologies through the development of a website.

The website incorporates the theme that the eye is a window to the body. Thus by investigating the processes of the eye, we can better understand and diagnosis different ailments and diseases. These ailments occur in not only earth bound humans, but astronauts as well as a result of exposure to elevated levels of radiation and microgravity conditions. Thus the technologies being developed at the Vision Research Lab are invaluable to humans on Earth in addition to those astronauts in space.

One of my first goals was to research the technologies being developed at the lab. The first several days were spent immersing myself in the various articles, journals and reports about the theories behind Dynamic Light Scattering, Laser Doppler Flowmetry, Autofluorescence, Raman Spectrophpy, Polarimetry and Oximetry. Interviews with the other researchers proved invaluable to help understand these theories as well gain hands on experience with the devices being developed using these technologies.

The rest of the Vision Research Team and I sat down and discussed how the overall website should be presented. Combining this information with the knowledge of the theories and applications of the hardware being developed, I worked out different ideas to present this information. I quickly learned Paint Shop Pro 8 and FrontPage 2002, as well as using online tutorials and other resources to help design an effective website.

The Vision Research Lab website incorporates the anatomy and physiology of the eye, different diseases that affect the eye and the technologies being develop at the lab to help diagnosis these diseases. It also includes background information on Dr. Ansari as well as other researchers involved in the lab and it includes segments on patents, awards and achievements. There are links to help viewers navigate to internal and external websites to further investigate different ideas and further understand the implications of these technologies at being developed.



**Research Symposium II**  
**Ohio Aerospace Institute**  
**Thursday, August 5, 2004**

**OAI Industry Room**

**9:00 A.M. Laquilia Graham, Hiram College, Freshman**

“A Three-fold Outlook of the Ultra-Efficient Engine Technology Program Office (UEET)”  
2100/Kathy Zona, Ultra-Efficient Engine Technology Office

**9:15 Jonathan Chennault, Ohio State University, Freshman**

“Icing Research Tunnel”  
7600/Richard DelRoso, Research Testing Division

**9:30 Alexander Padgett, Purdue University, Freshman**

“Refining the W1 and SE1 Facilities”  
7600/Mary Gibson, Research Testing Division

**9:45 Ashley Thomas, University of Akron, Freshman**

“Construction and Analysis of Electronic circuits”  
7600/Yves Lamothe, Research Testing Division

**10:00 Rodney Chambers, Ohio State University, Junior**

“Space Electronic Test Engineering”  
7630/Don Fong, Space Power and Propulsion Test Engineering Branch

**10:15 Abdullahi Audu, Cleveland State University, Senior**

“Upgrades at the Propulsion Systems Lab (PSL)”  
7660/Robert Smalley, Electronic and Special Systems Branch

**10:30 Nicholas Hawes, Cleveland Institute of Art, Senior**

“Medical/Scientific Illustration and Production of Otological Health Awareness Materials”  
7735/Beth Cooper, Structural Systems Dynamics Branch

**10:45 Carly Weiler, University of Cincinnati, Sophomore**

“Operating the Central Process Systems at Glenn Research Center”  
7010/Dennis Vano, Business Systems Office

**11:00 LUNCH**

**1:00 Paul Struhar, University of Akron, Freshman**

“Work Done for the Safety and Assurance Directorate”  
8000/Sandra Hardy, Safety and Assurance Directorate

**1:15 Jamarr Threatt, Columbus College of Art and Design, Freshman**

“Software Assurance of PLCs Training Course”  
8100, Cynthia Calhoun, Risk Management Office

**1:30 Shayla Wright, University of Toledo, Freshman**

“Risk Management Implementation Tool”

8100, Cynthia Calhoun, Risk Management Office

**1:45 Frank Pokorny, University of Cincinnati, Sophomore**

“The NASA Continuous Risk Management Process”

8100, Gary Kelm, Risk Management Office

**2:00 Session Break**

**2:15 Traci Barnett, Kent State University, Senior**

“Emergency Response Manual”

8500, Richard Soppet, Security Management Office

**2:30 Brittany Neal, Allegheny College, Freshman**

“College Bound with the Office of Educational Programs”

9200/Marie Borowski, Educational Programs Office

**2:45 Nykkita Riveras, University of Maryland-Baltimore County, Masters**

“Conversion of the Aeronautics Interactive Workstation”

9200/Dovie Lacy, Educational Programs Office

**3:00 Jeffrey Rios, Case Western Reserve University, Freshman**

“MOBI and FEANICS Programming in LabView”

7140/Rochelle May, Flight Software Engineers Branch

**3:15 Chika Okoro, Florida Agricultural & Mechanical University, PhD**

“Effects of Initial Powder Size on the Mechanical Properties and Microstructure of As-Extruded GRCop-84”

5120/David Ellis, Advanced Metallics Branch

**3:30 ADJOURN**

## A Three-fold Outlook of the Ultra-Efficient Engine Technology Program Office (UEET)

**La Quilia E. Graham**  
Hiram College  
Business Management/Biomedical Humanities  
Freshman  
**Mentor: Kathleen A. Zona**

### ABSTRACT

The Ultra-Efficient Engine Technology (UEET) Office at NASA Glenn Research Center is a part of the Aeronautics Directorate. Its vision is to develop and hand off *revolutionary* turbine engine propulsion technologies that will enable future generation vehicles over a wide range of flight speeds. There are seven different technology area projects of UEET.

During my tenure at NASA Glenn Research Center, my assignment was to assist three different areas of UEET, simultaneously. I worked with Kathy Zona in Education Outreach, Lynn Boukalik in Knowledge Management, and Denise Busch with Financial Management. All of my tasks were related to the business side of UEET.

As an intern with Education Outreach I created a word search to partner with an exhibit of a Turbine Engine developed out of the UEET office. This exhibit is a portable model that is presented to students of varying ages. The word search complies with National Standards for Education which are part of every science, engineering, and technology teachers' curriculum. I also updated a Conference Planning/Workshop Excel Spreadsheet for the UEET Office. I collected and inputted facility overviews from various venues, both on and off site to determine where to hold upcoming conferences. I then documented which facilities were compliant with the Federal Emergency Management Agency's (FEMA) Hotel and Motel Fire Safety Act of 1990.

The second area in which I worked was Knowledge Management. The UEET Office has a large knowledge management system online which has extensive documentation that continually needs reviewing, updating, and archiving. Knowledge management is the ability to bring individual or team knowledge to an organizational level so that the information can be stored, shared, reviewed, archived. Livelink and a secure server are the Knowledge Management systems that UEET utilizes. Through these systems, I was able to obtain the documents needed for archiving. My assignment was to obtain intellectual property including reports, presentations, or any other documents related to the project. My next task was to document the author, date of creation, and all other properties of each document. To archive these documents I worked extensively with Microsoft Excel.

The final area of my internship was Financial Management of UEET. I first learned the different financial systems of accounting such as the SAP business accounting system. I also learned the best ways to present financial data and shadowed my mentor as she presented financial data to both UEET's project management and the Resources Analysis and Management Office (RAMO). I analyzed the June 2004 financial data of UEET and used Microsoft Excel to input the results of the data. This process made it easier to present the full cost of the project in the month of June. In addition I assisted in the End of the Year 2003 Reconciliation of Purchases of UEET.

**Icing Research Tunnel**  
**Jonathan Chennault**  
Ohio State University  
Computer/Electrical Engineering  
**Mentor: Richard DelRosa**

**ABSTRACT**

The Icing Research Tunnel in Building 11 at the NASA Glenn Research Center is committed to researching the effects of in flight icing on aircraft and testing ways to stop the formation of hazardous icing conditions on planes. During this summer, I worked here with Richard DelRosa, the lead engineer for this area.

Icing Research Tunnel (IRT), built close to the end of World War 2, was created to address one of the major concerns of aviation: icing conditions. During the war, many planes crashed (especially supply planes going over the Himalayas) because ice built up in their wings and clogged the engines. To this day, it remains the largest ice tunnel in the world, with a test section that measures 6 feet high, 9 feet long, and 20 feet wide. It can simulate airspeeds from 50 to 300 miles per hour at temperatures as low as -50 Fahrenheit. Using these capabilities, IRT can simulate actual conditions at high altitudes.

My main job in the IRT is creating a reference guide for the technicians and engineers. The first thing I did was creating a cross reference in Microsoft Excel. It lists commands for the DPU units that control the pressure and temperature variations in the tunnel, as well as the type of command (keyboard, multiplier, divide, etc). The cross reference also contains the algorithm for every command, and which page it is listed in on the control sheet (visual Auto-CAD graphs, which I helped to make). I actually spent most of the time on the computer using Auto-CAD. I drew a diagram of the entire icing tunnel and then drew diagrams of its various parts. Between my mentor and me, we have drawings of every part of it, from the spray bars to the thermocouples, power cabinets, input-output connectors for power systems, and layouts of various other machines. I was also responsible for drawing schematics for the Escort system (which controls the spray bars), the power system, DPUs, and other electrical systems.

In my spare time, I am attempting to build and program the "toddler". Toddler is a walking robot that I have to program in PBASIC language. When complete, it should be able to walk on level terrain while avoiding obstacles in real-time. It features an infrared detector that can keep it from falling over edges, as well as follow or avoid a light source. The toddler is giving me a much better understanding of the basics of electronic circuitry and computer programming.

## **Refining the W1 and SE1 Facilities**

**Alexander D. Padgett**  
Purdue University  
Aerospace Engineering  
Undergraduate, freshman  
**Mentor: Mary Gibson**

### **ABSTRACT**

The Engine Research Building (ERB) houses more than 60 test rigs that study all aspects of engine development. By working with Mary Gibson in the SE1 and W1A Turbine Facilities, I became aware of her responsibilities and better acquainted with the inner workings of the ERB.

The SE1 Supersonic/Subsonic Wind Tunnel Facility contains 2 small wind tunnels. The first tunnel uses an atmospheric inlet, while the second uses treated 40-psig air. Both of the tunnels are capable of subsonic and supersonic operation. An auxiliary air supply and exhaust piping providing both test sections with suction, blowing, and crossfire capabilities. The current configuration of SE1 consists of a curved diffuser that studies the blockage along the endwalls.

The W1A Low Speed Compressor Facility provides insight for the complex flow phenomena within its 4-stage axial compressor, and the data obtained from W1A is used to develop advanced models for fluid dynamic assessment. W1A is based off of a low speed research compressor developed by GE in the 1950's. This compressor has a removable casing treatment under rotor 1, which allows for various tip treatment studies. The increased size and low speed allows instrumentation to be located in the compressor's complex flow paths. Air enters the facility through a filtered roof vent, conditioned for temperature and turbulence, and then passed through the compressor

W1A is described as a dynamic facility with many projects taking place simultaneously. This current environment makes it challenging to follow the various affairs that are taking place within the area. During my first 4 weeks at the NASA Glenn Research Center, I have assisted Mary Gibson in multiple tasks such as facility documents, record keeping, maintenance and upgrades. The facility has lube systems for its gearbox and compressor. These systems are critical in the successful operation of the facility. I was assigned the task of creating a facility estimate list, which included the filters and strainers required for the compressor. For my remaining time spent here, we expect to complete a facility parts listing and a virtual project summary so that W1A and SE1 will become ergonomic facilities that will make it easier for people to observe the capabilities and history of the area and the employees that operate. Bolstering our efforts in achieving these goal are the online technical tutorials, software such as Microsoft Excel, Macromedia Flash MX, Macromedia Dreamweaver MX, Photoshop 6.0 and the assistance of several NASA employees.

# ***Construction and Analysis of Electronic circuits***

*Ashley N. Thomas*

The University of Akron

Electrical Engineering

*Entering freshman*

*Yves C. Lamothe*

The Aviation Environmental Technical Branch produces many various types of aeronautical research that benefits the NASA mission for space exploration and in turn, produces new technology for our nation. One of the present goals of the Aviation Environmental Technical Branch is to create better engines for airplanes by testing supersonic jet propulsion and safe fuel combustion. During the summer of 2004, I was hired by Vincent Satterwhite Chief executive of the Aviation Environmental Technical Branch to Assist Yves Lamothe with a fuel igniter circuit.

Yves Lamothe is an electrical engineer who is currently working on safe fuel combustion testing. This testing is planned to determine the minimum ignition energy for fuel and air vapors of current and alternative fuels under simulated flight conditions. An air temperature bath will provide simulated flight profile temperatures and the heat fluxes to the test chamber. I was assigned with Yves to help complete the igniter circuit which consists of a 36k voltage supply an oscilloscope, and a high voltage transistor switch.

During my tenure in the L.E.C.I.R.P. program I studied the basics of electricity and circuitry along with two other projects that I completed. In the beginning of my internship, I devote all of my time to research the aspects of circuitry so that I would be prepared for the projects that I was assigned to do. I read about lessons on; the basic physical concepts of electronics, Electrical units, Basic dc circuits, direct current circuit analysis, resistance and cell batteries, various types of magnetism , Alternating current basics, inductance, and power supplies. I received work sheets and math equations from my Mentor so that I could be able to apply these concepts into my work.

After I complete my studies, I went on to construct a LED chaser circuit which displays a series of light patterns using a 555 timer. I incorporated a switch and motion detector into the circuit to create basic alarm system. This project challenged my ability to interpret a schematic and expand it.

While I was still completing the LED chaser circuit I Also was given A Basic Stamp Toddler Robot to build and program. The Toddler robot can walk in 36 various styles using advanced robotics. I used many different programs to create movement and direction of the robot. Also the Toddler can use infrared vision to sense objects. This enables the robot to maneuver indefinitely without running into objects. During my tenure at the NASA Glen Research Center I definite utilized the NASA mission to educate. I learned valuable information to help in my up coming year as a freshman in college.

## SPACE ELECTRONIC TEST ENGINEERING

**Rodney D. Chambers**  
The Ohio State University  
Electrical Engineering  
Undergraduate Junior  
**Mentor: Don Fong**

### ABSTRACT

The Space Power and Propulsion Test Engineering Branch at NASA Glenn Research center has the important duty of controlling electronic test engineering services. These services include test planning and early assessment of Space projects, management and/or technical support required to safely and effectively prepare the article and facility for testing, operation of test facilities, and validation/delivery of data to customer. The Space Electronic Test Engineering Branch is assigned electronic test engineering responsibility for the GRC Space Simulation, Microgravity, Cryogenic, and Combustion Test Facilities.

While working with the Space Power and Propulsion Test Engineering Branch I am working on several different assignments. My primary assignment deals with an electrical hardware unit known as Sunny Boy. Sunny Boy is a DC load Bank that is designed for solar arrays in which it is used to convert DC power from the solar arrays into AC power at 60 hertz to pump back into the electricity grid. However, there are some researchers who decided that they would like to use the Sunny Boy unit in a space simulation as a DC load bank for a space shuttle or even the International Space Station hardware. In order to do so I must create a communication link between a computer and the Sunny Boy unit so that I can preset a few of the limits (such power, set & constant voltage levels) that Sunny Boy will need to operate using the applied DC load.

Apart from this assignment I am also working on a hi-tech circuit that I need to have built at a researcher's request. This is a high voltage analog to digital circuit that will be used to record data from space ion propulsion rocket booster tests. The problem that makes building this circuit so difficult is that it contains high voltage we must find a way to lower the voltage signal before the data is transferred into the computer to be read. The solution to this problem was to transport the signal using infrared light which will lower the voltage signal down low enough so that it is harmless to a computer.

Along with my involvement in the Space Power and Propulsion Test Engineering Branch, I am obligated to assist all other members of the branch in their work. This will help me to strengthen and extend my knowledge of Electrical Engineering.

## Upgrades at the Propulsion Systems Lab (PSL)

Abdullahi M Audu  
Cleveland State University  
Electronic Engineering Technology  
Senior  
Mentor: John Leone

### ABSTRACT

The Propulsion Systems Lab (PSL) does ground testing on full size air breathing engines. These engines range from those on commercial airplanes to fighter jets. At the PSL, engineers receive test requirements from customers and put together the necessary instrumentation, data systems, power requirements, electrical control valves, and engine controls. The engineers are also responsible for facility maintenance, repairs and upgrades.

There are four major sections at the PSL; the Test floor, the Data room, the Control room and, the WDPF room. On the test floor are two test cells, cell #3 and cell #4. It is within these cells that the actual engine resides for ground testing. The cells, once sealed and taken up to altitude, are capable of reaching engine inlet temperatures of 1000° F to -90°F, and various atmospheric pressures. The engine, when operational, takes in air and gives out exhaust of up to 2000°F. The exhaust is led to another section of the cell where it is cooled to 150°F before finally redirected to the appropriate disposer. Temperature and pressure transducers detect the conditions within the cell and transmit them to the data room where the results are captured, processed, analyzed, and translated to a more comprehensive language. This is made possible with the aid of several programmable logic controllers (PLCs) and instrumentation and control systems. The translated data is then sent, via the LAN, to the control room where the results can be viewed on monitors by the engineers and customers. From the control room, the test cell conditions can be changed whenever desired. During tests, a lot takes place in the facility. The WDPF control system monitors and controls all facility parameters.

This summer, I will assist the engineers; on an upgrade to the facility's distributed control and dynamic data system, in preparation for an engine test that will begin in September, the installation of control systems and various miscellaneous projects around the PSL.



## MEDICAL/SCIENTIFIC ILLUSTRATION AND PRODUCTION OF OTOLOGICAL HEALTH AWARENESS MATERIALS

**Nicholas E. Hawes**  
Cleveland Institute of Art  
Medical Illustration  
5<sup>th</sup> year, Undergraduate  
**Mentor: Beth A. Cooper**

Over the past year, I have worked for my mentor, Beth Cooper, on a large variety of projects. Beth is the Manager of the Acoustical Testing Laboratory, which tests the acoustical emissions of payloads destined for the International Space Station. She is also responsible for educating, and developing new methods of educating, people of all occupational and educational backgrounds in hearing conservation.

Beth spends much of her time developing new materials and strategies with which to train people and teach other people to train people in hearing conservation and noise emissions control. I have been helping Beth develop and market these materials by way of graphic design and scientific illustration.

Last summer, I spent much of my time creating educational illustrations that visually explained particular concepts in Beth's presentations. Sometimes these illustrations were small "comics" while, at other times, they were an instructional series of illustrations.

Since then, Beth and her lab have been developing and updating some materials which will be distributed free to hearing conservation and noise control professionals and others in related fields. I have helped with these projects by designing their packaging. In each instance, it was my responsibility to develop an aesthetically appealing package that would also, through its imagery, describe or summarize the contents of the product. I did this for 3 CD's (Auditory Demonstrations II, MACSUG, and JeopEARdy) and saw them through their actual production and distribution.

In addition to working with Beth, I work with the Imaging Technology Center on various imaging projects. Some of my activities include photo retouching and manipulation for videos and print. This summer, I also had the opportunity to develop a screen saver that would show of some of the photography contained on the soon-to-be-released "Highlights of the GRC Image Archives, vol. 2". I was also able to utilize my medical training to help several of ITC's videographers identify the best histological examples of cancerous cells for incorporation in one of their videos.

Over the last part of this summer and then throughout the school year, I will be working with Beth to develop a "pre-packaged" lecture series about the physics of acoustics in the context of hearing conservation. These lectures will be used to teach people of all backgrounds the fundamental concepts involved in acoustical physics so they might be better aware of their own and others' auditory health in and out of the work place, and, in the case of payload developers, to design and build more quiet science experiments for the ISS.

Even though it may not seem as such, this project is precisely what I am learning to do as a student of the Cleveland Institute of Art's Medical Illustration Department. From my perspective, this project is about taking technical information and translating it into terms that anyone, regardless of background, can understand.

OPERATING THE CENTRAL PROCESS SYSTEMS  
AT GLENN RESEARCH CENTER

**Carly P. Weiler**  
University of Cincinnati  
Operations Management  
Undergraduate, Sophomore  
**Mentor: Dennis Vano**

ABSTRACT

As a research facility, the Glenn Research Center (GRC) trusts and expects all the systems controlling their facilities to run properly and efficiently in order for their research and operations to occur proficiently and on time. While there are many systems necessary for the operations at GRC, one of those most vital systems is the Central Process Systems (CPS). The CPS controls operations used by GRC's wind tunnels, propulsion systems lab, engine components research lab, and compressor, turbine and combustor test cells. Used widely throughout the lab, it operates equipment such as exhausters, chillers, cooling towers, compressors, dehydrators, and other such equipment. Through parameters such as pressure, temperature, speed, flow, etc., it performs its primary operations on the major systems of Electrical Dispatch (ED), Central Air Dispatch (CAD), Central Air Equipment Building (CAEB), and Engine Research Building (ERB).

In order for the CPS to continue its operations at Glenn, a new contract must be awarded. Consequently, one of my primary responsibilities was assisting the Source Evaluation Board (SEB) with the process of awarding the recertification contract of the CPS. The job of the SEB was to evaluate the proposals of the contract bidders and then to present their findings to the Source Selecting Official (SSO).

Before the evaluations began, the Center Director established the level of the competition. For this contract, the competition was limited to those companies classified as a small, disadvantaged business. After an industry briefing that explained to qualified companies the CPS and type of work required, each of the interested companies then submitted proposals addressing three components: Mission Suitability, Cost, and Past Performance. These proposals were based off the Statement of Work (SOW) written by the SEB. After companies submitted their proposals, the SEB reviewed all three components and then presented their results to the SSO. While the SEB does not select the company receiving the contract, they can make recommendations based on their findings to the SSO, who actually awards the contract. The SEB began work for this contract in July 2003 by writing the SOW and the selection will tentatively occur July 30, 2004. Contract awarding will take place Aug. 15. Following the awarding, the winning company has a 30-day Phase-in Period beginning Sept. 1, 2004 and full performance will begin October 1.

## **Work Done For the Safety and Assurance Directorate**

**Paul T. Struhar Jr.**  
University of Akron  
Freshman  
**Mentor: Sandra Hardy**

### **Abstract**

The Safety and Assurance Directorate (SAAD) has a vision. The vision is to be an essential part of NASA Glenn's journey to excellence. SAAD is in charge of leading safety, security, and quality and is important to our customers. When it comes to programmatic and technical decision making and implementation, SAAD provides clear safety, reliability, maintainable, quality assurance and security.

I worked on a couple different things during my internship with Sandra Hardy. I did a lot of logistics for meeting and trips. I helped run the budget for the SADD directorate. I also worked with Rich Miller for one week and we took water samples and ran tests. We also calibrated the different equipment.

There is a lot more to meetings are party than people see. I did the logistics for meetings and I did one for a retirement party. I had to get work orders and set up the facilities where the event is going to take place. I also set up a trip to Plum Brook Station. I had to order vans and talk with the people up there to see when a good time was. I also had to make invitations and coordinate everything. I also help Sandy run the numbers in the budget. We use excel to do this, which makes it a lot easier.

I worked with Rich Miller for a week and learned a lot of new and interesting things. He is in the environmental safety office. I learned how to collaborate the equipment using alpha and beta sources. I went out with him and we took water samples and tested them for conductivity and chlorine.

I have learned a lot in the short time I've been here. It has been a great experience and I have had the pleasure of meeting and working with great people.

## Software Assurance of PLCs Training Course

**Jamarr Threatt**

Columbus College of Art and Design

Computer Animation

Undergraduate, Freshman

**Mentor: Cynthia Calhoun**

### ABSTRACT

Being heavily visually-oriented, I am a firm believer in communication and conveying emotions through the art of color, motion, and transformation. A four-part online training course was created in PowerPoint and needed to be translated over into a Flash format. Issues with the PowerPoint were that the size of the files caused noticeable delays when placed online, there were compatibility issues, and from a composition and design perspective, color schemes and layout left much to be desired. High contrast, pixilated yellow text spiraling and flying on to a background of overly rich hues of blue with cheesy gradient patterns was just not appealing to my eye, along with the menu directory buttons located at the top resembling blue pills of NyQuil on top of a stale gray border that had nothing to do with the background. The course itself is extremely broad and verbose, and will get monotonous very soon after starting. Moving about the course was very cumbersome as well.

My task was to convert the course into a Flash format, which would make it much more efficient by drastically reducing the size (The file size of all four parts of the actual course combined will ultimately not even be a *fifth* as big as one part of the original PowerPoint alone!); along with that, the course was made to be more interactive and user-friendly, as well as pleasing to the eye. Upon being viewed by fellow co-workers, nothing but positive feedback has been received. When beginning the presentation, onscreen comes a 3'2", chubby, balding professor, who is a master in his knowledge of Programmable Logic Controllers (PLCs). He introduces himself and presents all of his vast knowledge over PLCs in a fun and innovative manner, making it much easier to acquire the information presented. A Scene Selection feature has been added making it a lot easier to jump from part to part and the back and forth arrows are much easier to utilize, and they are both less obtrusive than its PowerPoint predecessor. The user can also go at their pace, as the presentation pauses after at the end of each statement.

My project surprisingly somewhat dealt with my field of interest—though it was not computer animation, it was...still...animation done on a computer. I was able to incorporate my artistic talent and intuitive creativity into it, one thing I am very proficient at doing when it comes to what I do and what I will do in my profession as an artist/ computer animator. At first, I felt that there was no place for an artist within a faculty of scientists, engineers, chemists, mathematicians, and programmers, but I managed to fit in quite successfully.

## **Risk Management Implementation Tool**

**Shayla L. Wright**  
University Of Toledo  
Biomedical Engineering  
Freshman  
**Mentor: Cynthia Calhoun**

### **ABSTRACT**

Continuous Risk Management (CM) is a software engineering practice with processes, methods, and tools for managing risk in a project. It provides a controlled environment for practical decision making, in order to assess continually what could go wrong, determine which risk are important to deal with, implement strategies to deal with those risk and assure the measure effectiveness of the implemented strategies. Continuous Risk Management provides many training workshops and courses to teach the staff how to implement risk management to their various experiments and projects. The steps of the CRM process are identification, analysis, planning, tracking, and control. These steps and the various methods and tools that go along with them, identification, and dealing with risk is clear-cut.

The office that I worked in was the Risk Management Office (RMO). The RMO at NASA works hard to uphold NASA's mission of exploration and advancement of scientific knowledge and technology by defining and reducing program risk. The RMO is one of the divisions that fall under the Safety and Assurance Directorate (SAAD). I worked under Cynthia Calhoun, Flight Software Systems Engineer. My task was to develop a help screen for the Continuous Risk Management Implementation Tool (RMIT). The Risk Management Implementation Tool will be used by many NASA managers to identify, analyze, track, control, and communicate risks in their programs and projects. The RMIT will provide a means for NASA to continuously assess risks. The goals and purposes for this tool is to provide a simple means to manage risks, be used by program and project managers throughout NASA for managing risk, and to take an aggressive approach to advertise and advocate the use of RMIT at each NASA center.

## **The NASA Continuous Risk Management Process**

**Frank M. Pokorny**  
University of Cincinnati  
Aerospace Engineering  
Undergraduate, Sophomore  
**Mentor: Gary G. Kelm**

### **ABSTRACT**

As an intern this summer in the GRC Risk Management Office, I have become familiar with the NASA Continuous Risk Management Process. In this process, risk is considered in terms of the probability that an undesired event will occur and the impact of the event, should it occur (ref., NASA-NPG: 7120.5). Risk management belongs in every part of every project and should be ongoing from start to finish. Another key point is that a risk is not a problem until it has happened. With that in mind, there is a six step cycle for continuous risk management that prevents risks from becoming problems. The steps are: identify, analyze, plan, track, control, and communicate & document.

Incorporated in the first step are several methods to identify risks such as brainstorming and using lessons learned. Once a risk is identified, a risk statement is made on a risk information sheet consisting of a single condition and one or more consequences. There can also be a context section where the risk is explained in more detail. Additionally there are three main goals of analyzing a risk, which are evaluate, classify, and prioritize. Here is where a value is given to the attributes of a risk (i.e., probability, impact, and timeframe) based on a multi-level classification system (e.g., low, medium, high). It is important to keep in mind that the definitions of these levels are probably different for each project. Furthermore the risks can be combined into groups. Then, the risks are prioritized to see what risk is necessary to mitigate first. After the risks are analyzed, a plan is made to mitigate as many risks as feasible. Each risk should be assigned to someone in the project with knowledge in the area of the risk. Then the possible approaches to choose from are: research, accept, watch, or mitigate. Next, all risks, mitigated or not, are tracked either individually or in groups. As the plan is executed, risks are re-evaluated, and the attribute values are adjusted as necessary. Metrics are established and monitored as tools for risk tracking. Also a trigger or threshold should be set on the metric data that indicates when an action is needed. Results of this tracking are usually evaluated and reported in a relevant format at weekly or monthly meetings. Choosing controls is the subsequent step, which involves the effects of the tracking. The three basic controls are: close, continue tracking, and re-plan. Finally communicate & document is the last step, but occurs throughout the process. It is vital that main risks, plans, changes, and progress are known by everyone in the project. A good way to keep everyone updated and inform other projects of common issues is by thoroughly documenting project risks. NASA sees value in risk management and believes that projects have greater probability for success by using the NASA Continuous Risk Management Process.

## Emergency Response Manual

**Traci M. Barnett**  
Kent State University  
Political Science  
Senior

**Mentor: Dr. Richard Soppet**

Safety and security is very important at NASA. The Security Management and Safeguards Office goal is ensure safety and security for all NASA Lewis and Plum Brook Station visitors and workers. The office protects against theft, sabotage, malicious damage, espionage, and other threats or acts of violence.

There are three types of security at NASA: physical, IT, and personnel. IT is concerned with sensitive and classified information and computers. Physical security includes the officers who check visitors and workers in and patrol the facility. Personnel security is concerned with background checks during hiring. During my internship, I met people from and gained knowledge about all three types of security. I primarily worked with Dr. Richard Soppet in physical security.

During my experience with physical security, I observed and worked with many aspects of it. I attended various security meetings at both NASA Lewis and Plum Brook. The meetings were about homeland security and other improvements that will be made to both facilities. I also spent time with a locksmith. The locksmith makes copies of keys and unlocks doors for people who need them. I rode around in a security vehicle with an officer as he patrolled. I also observed the officer make a search of a visitor's vehicle. All visitors' vehicles are searched upon entering NASA. I spent time and observed in the dispatch office. The officer answers calls and sends out officers when needed. The officer also monitors the security cameras.

My primary task was completing an emergency response manual. This manual would assist local law enforcement and fire agencies in case of an emergency. The manual has pictures and descriptions of the buildings. It also contains the information about hazards inside of the buildings. This information will be very helpful to law enforcement so that when called upon during an emergency, they will not create an even bigger problem with collateral damage.

## **College Bound with the Office of Educational Programs**

**Brittany D. Neal**  
Allegheny College  
Education  
Freshman

**Mentor: Marie L. Borowski**

### **Abstract**

The Educational Programs Office at NASA Glenn Research Center hosts a variety of programs that takes on the hard task of getting students of all ages interested in pursuing careers in science, mathematics, and engineering. To help assist students along the way there are many programs to participate in such as: the explorers, shadowing opportunities, and paid internships. The Educational Programs Office not only creates learning opportunities for students, they also host workshops to help educators enhance their knowledge these fields. This summer I assisted Marie Borowski in the Educational Programs Office with the Tennessee State University College Bound Program.

The Tennessee state University College Bound Program is an intensive two-week summer academic workshop designed to introduce minority students to the profession of engineering. NASA Glenn Research Center sent forty dedicated students on a bus to Nashville, Tennessee to experience college life as a whole. At the college the students day consisted of a math class, aeronautics, ACT/SAT preparation, writing and research, African American Culture, computer science, and study sessions. The students also went on educational field trips to the Fisk Museum, the Space and Rocket Center, and the Parthenon Museum. On the last day of the program the students competed in an oratorical contest where the students made a PowerPoint presentation on the class that they enjoyed the most.

There were many processes that had to be put into action for the college bound program to run smoothly. The process started in early January with the preparation of applications. Once prepared, the applications were then sent to schools and past participants in hopes of receiving a well- qualified pool of applicants. Once the applications were received, a prescreening is done which ensures all of the information is complete. Then, they are reviewed by a panel, using a rubric to evaluate them, and the semifinalists are then selected. Interviews are held with the students and their parents had to be interviewed by a panel of judges and graded on a rubric. The scores were added up and the forty students were selected. My job this summer was getting the students ready to leave for Tennessee.

My job consisted of working very closely with my mentor, Marie Borowski, to compile the student data to provide it to the chaperones, TSU records, and NASA records. I learned about the vital communication between the NASA and the TSU program managers. After all the planning was done and the program had begun I had a chance to fly to Tennessee for six days to observe the students daily activities. The students had adjusted very well to the intense schedule, and seemed very enthusiastic about the activities to follow. The whole group was very attentive and enthusiastic program be longer.

My goals for the summer were all met. I wanted to learn and retain all the information I possibly could on the job I was given. I was very happy with the end result.



## **Conversion of the Aeronautics Interactive Workstation**

**Nykkita L. Riveras**

University of Maryland, Baltimore County

Major: Applied Mathematics

Graduate Student, 1<sup>st</sup> Year

**Mentors: Dovie Lacy, Richard Gilmore & Gerald Voltz**

This summer I am working in the Educational Programs Office. My task is to convert the Aeronautics Interactive Workstation from a Macintosh (Mac) platform to a Personal Computer (PC) platform. The Aeronautics Interactive Workstation is a workstation in the Aerospace Educational Laboratory (AEL), which is one of the three components of the Science, Engineering, Mathematics, and Aerospace Academy (SEMAA). The AEL is a state-of-the-art, electronically enhanced, computerized classroom that puts cutting-edge technology at the fingertips of participating students. It provides a unique learning experience regarding aerospace technology that features activities equipped with aerospace hardware and software that model real-world challenges. The Aeronautics Interactive Workstation, in particular, offers a variety of activities pertaining to the history of aeronautics.

When the Aeronautics Interactive Workstation was first implemented into the AEL it was designed with Macromedia Director 4 for a Mac. Today it is being converted to Macromedia DirectorMX2004 for a PC. Macromedia Director is the proven multimedia tool for building rich content and applications for CDs, DVDs, kiosks, and the Internet. It handles the widest variety of media and offers powerful features for building rich content that delivers real results, integrating interactive audio, video, bitmaps, vectors, text, fonts, and more. Macromedia Director currently offers two programming/scripting languages: Lingo, which is Director's own programming/scripting language and JavaScript. In the workstation, Lingo is used in the programming/scripting since it was the only language in use when the workstation was created.

Since the workstation was created with an older version of Macromedia Director it hosted significantly different programming/scripting protocols. In order to successfully accomplish my task, the final product required correction of Xtra and programming/scripting errors. I also had to convert the Mac platform file extensions into compatible file extensions for a PC.

## **MOBI and FEANICS Programming in LabView**

**Jeffrey N. Rios**

Case Western Reserve University

Computer Engineering

Undergraduate, Freshman

**Mentor: Rochelle L. May**

The flight software engineering branch provides design and development of embedded real-time software applications for flight and supporting ground systems to support the NASA Aeronautics and Space Programs. In addition, this branch evaluates, develops and implements new technologies for embedded real-time systems, and maintains a laboratory for applications of embedded technology. This branch supports other divisions and is involved with many other projects. My mentor Rochelle and I are involved in the Fluids and Combustion Facility (FCF) project, the MOBI project, and the FEANICS project.

The Fluids and Combustion Facility (FCF) will occupy two powered racks on the International Space Station (ISS). It will be a permanent modular, multiuser facility to accommodate microgravity science experiments onboard the ISS's U.S. Laboratory Module. FCF will support NASA Human Exploration and Development of Space program objectives requiring sustained, systematic research in the disciplines of fluid physics and combustion science. The fluids experiment is called FIR and the combustion experiment is called CIR.

The MOBI Experiment is an experiment that is performed to understand the physics of bubble segregation and resuspension in an inertia, monodisperse gas-liquid suspension, and to understand how bubble pressure resists segregation in suspensions with continuous phase inertia.

The main focus of FEANICS and the solid combustion experiments will be to conduct basic and applied scientific investigations in fire-safety to support NASA's Bioastronautics Initiative. Based on data obtained in microgravity and experience gained from the beginning of the U.S. manned space program, these normal gravity flammability assessments have been assumed to be conservative with respect to flammability in all environments. However, some of the complex interactions that govern ignition and flame growth can only be evaluated in the long durations of microgravity available on the ISS.

Before any of these projects actually go to the ISS, they are going to be tested on NASA's KC-135 0g airplane, the KC-135 Low-G Flight Research aircraft (a predecessor of the Boeing 707) is used to fly parabolas to create 20-25 seconds of weightlessness so that the astronauts can experience and researchers can investigate the effects of "zero" gravity.

My mentor and I have been working with Labview to write the programs that are going to acquire, analyze and present the data acquired from these Test flights on the KC-135. We have been working closely with electrical, and mechanical engineers to make sure the program and the hardware can communicate and perform the operations necessary for the flight test.

LabVIEW delivers a powerful graphical development environment for signal acquisition, measurement analysis, and data presentation, giving you the flexibility of a programming language without the complexity of traditional development tools. The programming of the control panel and the code are both done in GUIs which allow for flexibility in the code and the program.

## **Effects of Initial Powder Size on the Mechanical Properties and Microstructure of As-Extruded GRCop-84**

**Chika L. Okoro**

Florida Agricultural & Mechanical University, Mechanical Engineering, Graduate

**Mentor: David Ellis**

ORG: 5120, Advanced Metallics Branch

GRCop-84 was developed to meet the mechanical and thermal property requirements for advanced regeneratively cooled rocket engine main combustion chamber liners. It is a ternary Cu-Cr-Nb alloy having approximately 8 at% Cr and 4 at% Nb. The chromium and niobium constituents combine to form 14 vol% Cr<sub>2</sub>Nb, the strengthening phase. The alloy is made by producing GRCop-84 powder through gas atomization and consolidating the powder using extrusion, hot isostatic pressing (HIP) or vacuum plasma spraying (VPS). GRCop-84 has been selected by Rocketdyne, Pratt & Whitney and Aerojet for use in their next generation of rocket engines.

GRCop-84 demonstrates favorable mechanical and thermal properties at elevated temperatures. Compared to NARloy-Z, the currently used material in the Space Shuttle, GRCop-84 has approximately twice the yield strength, 10-1000 times the creep life, and 1.5-2.5 times the low cycle fatigue life. The thermal expansion of GRCop-84 is 7.5-15% less than NARloy-Z which minimizes thermally induced stresses. The thermal conductivity of the two alloys is comparable at low temperature but NARloy-Z has a 20-50 W/mK thermal conductivity advantage at typical rocket engine hot wall temperatures. GRCop-84 is also much more microstructurally stable than NARloy-Z which translates into better long term stability of mechanical properties.

Previous research into metal alloys fabricated by means of powder metallurgy (PM), has demonstrated that initial powder size can affect the microstructural development and mechanical properties of such materials. Grain size, strength, ductility, size of second phases, etc., have all been shown to vary with starting powder size in PM-alloys. This work focuses on characterizing the effect of varying starting powder size on the microstructural evolution and mechanical properties of as-extruded GRCop-84.

Tensile tests and constant load creep tests were performed on extrusions of four powder meshes: +140 mesh (>105 μm powder size), -140 mesh (≤105 μm), -140/+270 (53 - 105 μm), and -270 mesh (≤53 μm). Samples were tested in tension at room temperature and at 500°C (932°F). Creep tests were performed under vacuum at 500°C using a stress of 111 MPa (16.1 ksi). The fracture surfaces of selected samples from both tests were studied using a Scanning Electron Microscope (SEM). The as-extruded materials were also studied, using both optical microscopy and SEM analysis, to characterize changes within the microstructure.

## **INTERN SUMMARY REPORTS**

## Probe Station Antenna Range

**By: Phil Barr**

**Mentor: Afroz Zaman**

**Date: July 23, 2004**

This summer I was given the task of programming a Probe Station to collect near field antenna patterns and convert them to far field patterns. The purpose of this project is to provide NASA with another means of antenna characterizing. Currently, NASA Glenn can measure near field and far field patterns of many different types of antennas. The antennas targeted for this lab are small patch antennas at high frequencies that require probe biasing. The Probe Station contains two probes for RF signals and another two for DC Biasing. The way this lab works is as follows: A patch antenna is placed on the probe station and biased properly for testing. This antenna is known as the Antenna Under Test (AUT). The AUT is supplied with an RF signal from a probe that is connected to a network analyzer. Above the AUT hangs a probe for measuring the electric field emitted by the AUT. The probe is controlled by four axis. The axis of movements for this probe are back and forth, left and right, up and down, and rotation. The network analyzer and axis controllers are tied into a computer for reading commands and recording data. The probe scans a rectangular pattern above the AUT to measure the electric field emitted by the AUT. This data is then recorded and analyzed back at the computer.

When I arrived here most of the hardware for the lab was already installed. I was given a complete overview of how everything runs and asked to integrate everything in LabVIEW.

From my work this summer a user is now capable of taking a near field antenna scans of many types of patch antennas and converting this to the more important far field pattern in LabVIEW. This program was designed to measure both linear and circularly polarized antennas. My goal for this project was to automate and prevent the user from seeing everything done behind the scenes. This goal proved harder than I had originally thought because I came to learn that to accomplish everything I would need to make use of several applications. LabVIEW is important for hardware control and data acquisition, but when it comes to analysis and display I had to look elsewhere. The conversion of the near field data to far field data is done in Matlab. I was able to integrate Matlab into LabVIEW so that the user wouldn't need to do this them self. Another important feature not capable from LabVIEW was providing the user with an unlimited

number of graph displays. I wanted the user to be able to conduct a scan and be able to choose from a collection of different graphs to display relative to the scan. For a typical scan on a linear patch antenna the user has 24 different types of graphs they can view. In LabVIEW you can only display as many graphs as you code into the program. With 24 different graphs you would either need to exclude some or take up much needed panel space in LabVIEW. To solve this problem I knew I would need to come up with a method to allow the user to open multiple graphs each in their own window. This was accomplished by creating a graphing program in Visual Basic and executing it from LabVIEW. To keep everything uniform I needed to integrate the graphing features of LabVIEW into Visual Basic which took some time to figure out.

This Probe Station antenna range is almost complete. Currently I'm working on safe guards such as making sure a scan isn't attempted when equipment may be off. This antenna range has been tested using predictable horns and observing that the results are what was expected.

The remaining time here I'll finish tweaking and improving the antenna range. A technical memorandum will be written to give exposure to the new capabilities NASA has from this range. I've been given flyers for different conferences that my mentors think would be good for me to apply a paper towards. I've also been asked to search the US Patent and Trademarks office to find out how unique this project is compared to what already exists.

In conclusion, my work this summer has been very beneficial to NASA and myself. NASA has gained the capability of further antenna testing through the use of a new lab and I've been exposed to a number of different programs. I was told what the antenna range should be able to do and was free to implement it however I chose. This allowed me to think creatively without being limited to certain specs. It also forced me to think as a designer. I needed to put myself in the position of the user and make certain my program was the easiest to use along with being robust enough to allow meaningful and useful data analysis and presentation.

David DeAngelis  
7/16/2004

### LERCIP 2004 Summary

This summer I am continuing my project from the previous two summers. My work involves ohmic contacts to N-type silicon carbide (SiC) devices. My mentor, Dr. Robert Okojie, is developing the technology behind high performance sensors and actuators for harsh environments. SiC is useful because it is able to operate at temperatures up to 600 °C and it is resistant to radiation damage. This allows sensors and electronics to be placed in new locations, such as inside a jet engine or in space application without using heavy shielding. Ultimately this results in more efficient, smarter engine technology, reduced launch weights for spacecraft, and high power and high temperature electronics.

A fundamental part of SiC devices is the ohmic contact. The contact is the interface between the semiconductor (SiC) and external circuitry. The current flowing in and out the devices is through the contact. Ensuring that these contacts remain ohmic (linear I-V behavior) allows us to fabricate devices that do not waste power at the metallurgical junction. Another key part is maintaining a low contact resistance. It is desired to maintain minimum energy loss by avoiding a rectifying electrical characteristic.

My project is to develop and implement a testing procedure for measuring the contact resistance while the device is operating at high temperature. It is important to measure the contacts while simulating the true operating environment as closely as possible. For this reason, measurements are taken while the device is heated at intervals up to 600 C in air. To test the long term reliability of the devices, the high temperature measurements are repeated after heating the sample for long intervals in air. A new set of data is gathered after heating for a total of 100, 200 and then 400 hours. The current as a function of voltage and the contact resistance was measured using the four point probe technique. The four point probe method is chosen because it measures contact resistance while eliminating error due to wire resistance and calibration issues.

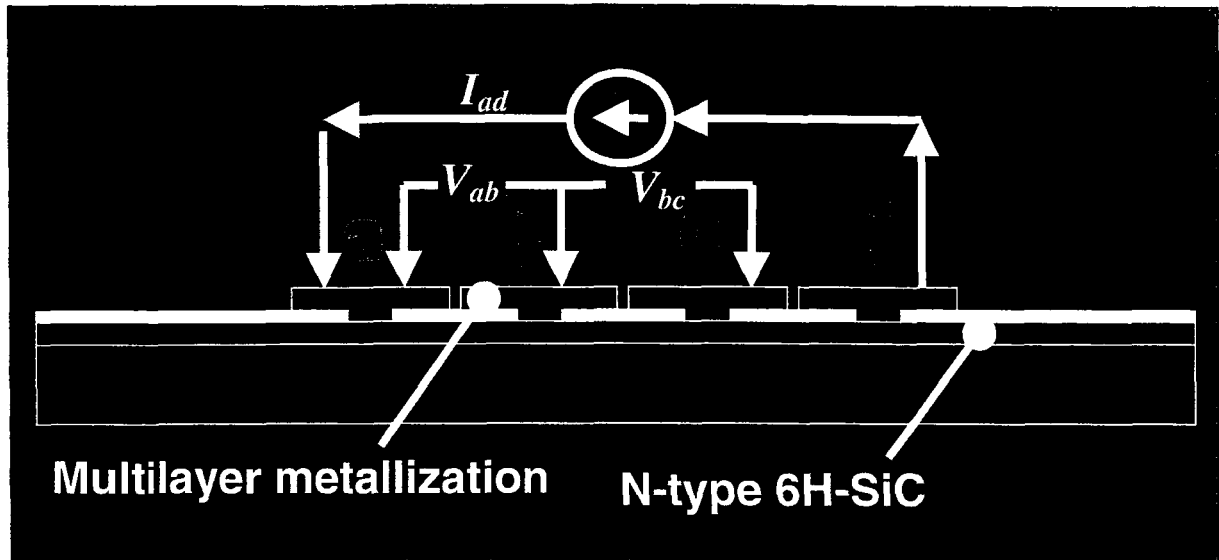

The diagram above shows a cross section of the four point probe test structure, where the letters a, b, c, and d indicate where probe tips are placed. The current supplied,  $I_{ad}$ , is 1 mA. Voltages  $V_{ab}$  and  $V_{bc}$  along with the center to center contact distance 's' and the contact diameter 'd' are then used in a modified Kuphal's formula to find the contact resistance.

$$Rc = \frac{A}{I} \left[ V_{AB} - V_{BC} \frac{\ln\left(3\frac{S}{D} - \frac{1}{2}\right)}{2\ln(2)} \right]$$

These measurements are performed through a microscope on a hot chuck system using probe points that are attached to micromanipulators. Collecting this data is difficult because we must place four probe points simultaneously and make sure we have a strong connection. Also, the outermost layers of the contacts and the probes tend to oxidize, forming a thin barrier that we must penetrate.

Some early results of this work were presented at the 2004 Electronic Materials Conference at the University of Notre Dame. I had the opportunity to attend this conference and gain exposure to the latest news in semiconductor research. I gave a 20 minute presentation to fellow conference attendees and was generally well received. The abstract of this talk is as follows:

#### In-situ High Temperature and Current Characterization of Ohmic Contacts to N-type SiC

We report the results of the in-situ characterization of Ti/TaSi<sub>2</sub>/Pt ohmic contacts to 6H-SiC during high temperature and current accelerated stressing. Several 6H-SiC four-point probe test structures are exposed to a constant current of 1 mA and temperature up to 600 °C in air ambient at intervals of 100 hrs up to 400 hrs. The insertion of SiC devices into the critical sections of the propulsion systems and on-board electronics and sensors for planetary missions to harsh planets (i.e.,



Venus) and other cosmic bodies will require that these devices survive and operate reliably during the entire mission. The temperature in these environments is sometimes greater than 500 °C and with high radiation values. Thus, the goal of this work is to evaluate the long term stability and reliability of Ti/TaSi<sub>2</sub>/Pt ohmic contact metallization to 6H-SiC under simulated constant operating conditions at high temperature. The current-voltage (I-V) characteristics, the series resistance, and the specific contact resistance (SCR) of the test structures are measured in-situ under the above environmental conditions. After every 100 hrs of heating at 600 °C in air and at 1 mA, the samples are cooled and similar measurements are repeated. The results are then compared to determine deviations from the initial values. Unstable voltage offsets that precede the eventual failure of SiC devices have been largely attributed to the electrical instability at the semiconductor metallurgical junction. Another marker of premature failure is associated with the irreversible drift of the device reading during operation. One source of drift is likely due to microstructural changes in the material after extended current stressing. Before the contact resistance is measured, the ohmic behavior of the test structure is verified. The device is heated in the atmosphere from room temperature to 600 °C. The temperature effect on the resistance shows a non-linear behavior, starting with a high resistance at room temperature and gradually decreasing. From about 250 °C, the resistance begins an upward swing and continues to 600 °C. This behavior is explained by the dominance of impurity and phonon scattering mechanisms on current transport at temperature below 250 °C and above, respectively. The plots of the resistance versus temperature during the various 100 hr cyclic soaking period do not track perfectly as is expected under ideal conditions, thus suggesting that microstructural changes are occurring either within the metal contact (e.g., phase transformation), at the metallurgical junction (e.g., chemical reaction), or within the crystal. With regard to the SCR, it is initially measured to be  $4 \times 10^{-4} \text{ cm}^2$  and remains constant over the temperature range after the first 100 hrs. However, a factor of two increase is observed after 400 hrs of soak at 600 °C in air, even as the SCR remain relatively constant at the new values. At the talk scanning electron microscopy and auger analyses will be used in conjunction with the I-V characteristics to discuss the failure mechanisms.

Since the conference, I have been working on preparing and testing new samples to add to our collection of data. Our first high temperature tests support our theory of the chemical mechanism behind our ohmic contacts. We are now measuring the contact resistance of samples that have varying doping levels and epilayer thicknesses to find the optimum combination. We also plan to implement a passivation scheme to prevent edge encroachment, or oxidation of the contact caused by oxygen leaking in from the side. This work should give us a more clear picture of how to create a thermally stable, low resistance ohmic contact to N-type silicon carbide.

## **L.E.R.C.I.P. Internship Summary**

**Owen Donovan**

**Duke University - Senior**

**Mentor: Al Downey, Electron and Optical Devices Branch (5620)**

I am currently working towards a double major in Computer Science and Electrical and Computer Engineering. My summer internship at NASA Glenn Research Center has allowed me to apply and further my knowledge of both of these fields. This summer is my second L.E.R.C.I.P. experience, and has worked out equally well as the first. I haven't been working on one single project this year, but instead have had a good variety of things to work on. Thus far I have spent time on the following tasks: antenna measurements, high-temperature reliability testing, and left-handed metamaterials.

The first two weeks of my summer were put toward testing planar antennas that operate at either 14 GHz or 35 GHz. It is hoped that after some fine-tuning, these two types of antennas can be combined, producing a single antenna that operates at both frequencies. The antennas are tested in an antenna range, which is essentially a Plexiglas box lined with foam absorber. A signal at a specific frequency enters the range via a horn mounted on one side of the Plexiglas box. The antenna under test is mounted on a rotating stage directly in the path of the input signal. During testing, the antenna is rotated from a  $-90^\circ$  position to a  $90^\circ$  position, relative to the input signal. Effectively, this measures the antenna's ability to receive waves coming from any practical angle. Meanwhile, the power of the signal received by the antenna is monitored. This entire testing procedure is performed automatically by software written in a graphical programming language called LabVIEW. In addition to using this software to measure a number of antennas, I was able to tweak the program, allowing it to run three times faster.

Reliability testing has consumed more of my time this summer than any other topic. Reliability

testing occurs over an extended period of time, up to 1000 hours in this case. The devices to be tested are simple, on-wafer circuit components such as resistors, transmission lines, and capacitors. During the entire test, the devices must be kept at a temperature of 500° C. In addition, the devices must be biased to a certain current/voltage level throughout the testing period. I am currently working on the software and hardware for this reliability test setup. The software is again written in LabVIEW. This software will periodically measure the current through and voltage across each device, making it possible to determine when the devices fail, and how their parameters change over time. Due to the extremely high temperatures required by the test, the software will also routinely perform safety checks.

The subject that has filled my spare moments this summer is left-handed metamaterials (LHM's). A metamaterial is a block constructed from more than one type of material. The block is composed in such a way that artificial "cells" are created. The composite behaves like a continuous material because its elements are much smaller than the wavelength of the electromagnetic radiation incident upon it. One way to create a LHM is to start with dielectric sheets that have a thin layer of metal on each side. The sheets are etched so that there are straight, parallel copper lines on one side and split-ring resonators on the other side. Numerous such sheets are interlaced to form a rectangular grid.

Prior to this summer, engineers in my branch had already built one such LHM (See Figure 1 below), using a 20x20 grid.

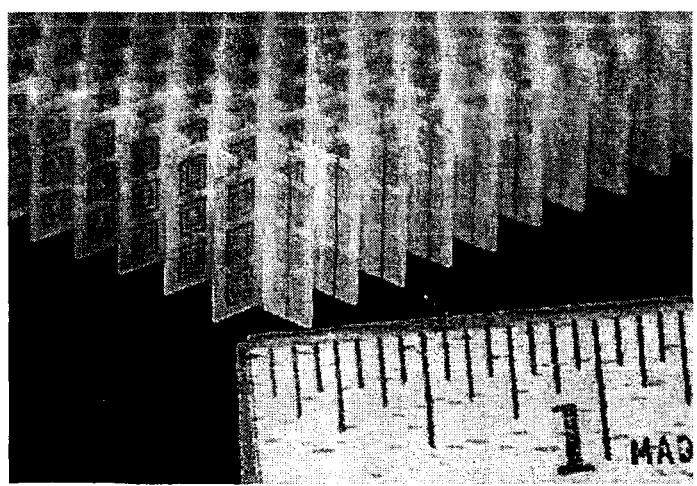

Figure 1: Left-handed metamaterial

My job was to help devise a way to measure the signal inside each cell of the LHM. The signal transmitted through the LHM had previously been measured by sandwiching the material between 2 solid sheets of metal, placing a signal source on one side of the block, and measuring the signal on the opposite side. I worked with another engineer to determine how to test each cell without adding too many additional variables. We built a new fixture to detect the signal. First, we mounted a coaxial connector on the corner of a thin metal sheet. The center conductor of the coax cable was extended out from the metal sheet so that it could be inserted in each cell of the LHM. We chose to attach the connector near the corner of the sheet so that it would be more visible, and hence easier to move quickly from one LHM cell to another. This was especially important because there are hundreds of cells, each of which is relatively small (5mm x 5mm). We used spare metal sheets to cover the parts of the LHM that were left exposed by our new test fixture. With the hardware setup finished, we wrote a simple LabVIEW program to read the power traveling into the block and out through the coax connector. The test setup is now complete and measurements are in progress.

Overall, I have been very pleased with both of my summers at NASA. For me, the experience has been interesting as well as practical. I learned how to use LabVIEW last summer, and was able to apply that skill in a year-long independent study during the past school year. In fact, I would not have been accepted for that position, had it not been for the experience I gained at NASA. Furthermore, the proficiency I gained during my independent study has made me a better programmer back at NASA this summer.

## Hubble Space Telescope Bi-Stem Thermal Shield Analyses

Katherine A. Finlay

OAI Summer Intern

Electro-Physics Branch (Mentor: Kim de Groh)

7-27-04

The Hubble Space Telescope (HST) was launched April 24, 1990, and was deployed April 25 into low Earth orbit (LEO). It was soon discovered that the metal poles holding the solar arrays were expanding and contracting as the telescope orbited the Earth passing between the sunlight and the Earth's shadow. The expansion and contraction, although very small, was enough to cause the telescope to shake because of thermal-induced jitters, a detrimental effect when trying to take pictures millions of miles away. Therefore, the European Space Agency (ESA, the provider of the solar arrays) built new solar arrays (SA-II) that contained bi-stem thermal shields which insulated the solar array metal poles. These thermal shields were made of 2 mil thick aluminized-Teflon fluorinated ethylene propylene (FEP) rings fused together into a circular bellows shape. The new solar arrays were put on the HST during an extravehicular activity (EVA), also called an astronaut space walk, during the first servicing mission (SM1) in December 1993. An on-orbit photograph of the HST with the SA-II, and a close up of the bellows-like structure of the thermal shields is provided in Figure 1.

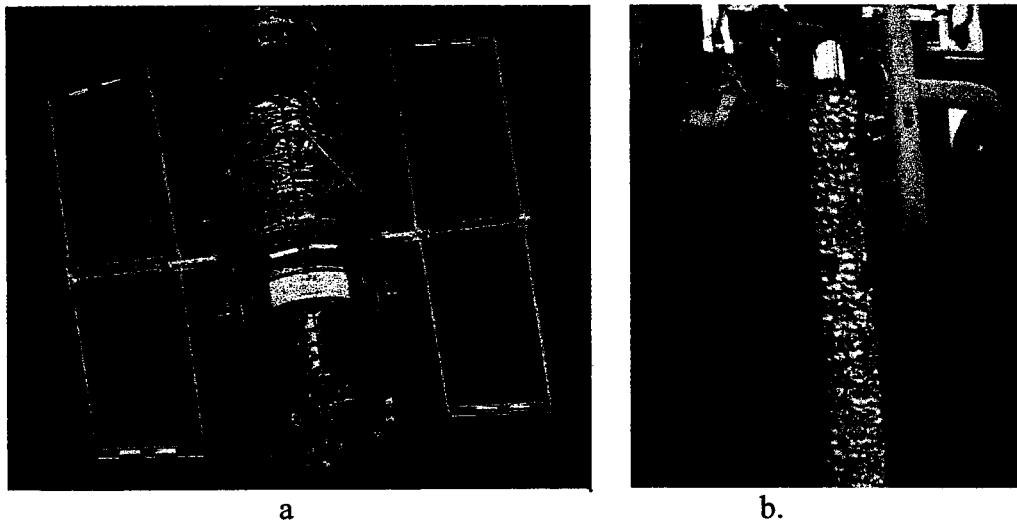

Figure 1. On-orbit photograph of the Hubble Space Telescope during SM1, a). HST with Solar Array II attached, and b). Close-up of a section of thermal shields.

While in space the bi-stem thermal shields were exposed to space phenomena such as atomic oxygen, ultraviolet (UV) radiation and electron and proton radiation (Van Allen Belt trapped particle radiation), in addition to thermal cycling and vacuum. On Earth, oxygen is a diatomic molecule, but in LEO short wavelength UV radiation breaks the diatomic bonds and forms monatomic oxygen, which is highly reactive. Therefore, when it collides with the FEP in space it will react, and can chemically erode it away, while the UV and particle radiation embrittles it. This is problematic when using the material as a long-term insulator, because it

turns the FEP from a flexible and stretchy substance into a hard brittle substance, causing it to crack and break apart, losing its effectiveness as an insulator, affecting the durability of satellite systems.

After 8.25 years in space, during the fourth servicing mission (SM3B) in March 2002, the second set of solar arrays were retrieved and replaced with a third set of arrays (SA-III). A section of the bi-stem thermal shields was provided to the NASA Glenn Research Center from ESA, so that the environmental durability of the thermal shields could be studied and compared to previously retrieved and studied insulation materials from HST. Figure 2 shows images of the as-retrieved bi-stem sample.

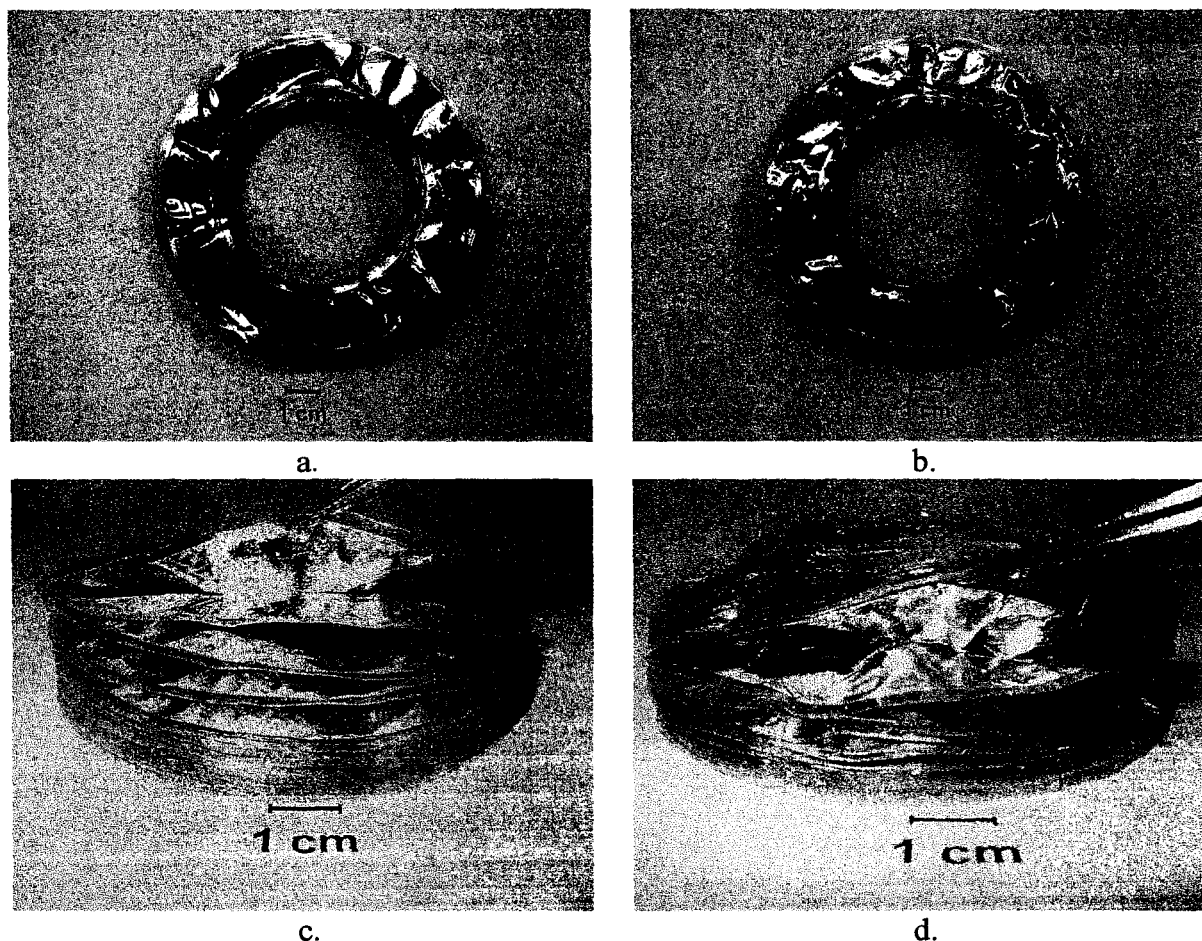

Figure 2. Post-retrieval images of the thermal shield sample provided to Glenn: a). Side A, b). Side B, c). Anti-solar side lifted to show individual welds with no cracks, and d). Solar facing side lifted to show individual welds with through-thickness cracks.

As can be seen in the pictures, the retrieved sample is severely damaged on the solar exposed side (image 2d and right side of images in 2a and 2b). It was more severely damaged than it was originally thought to be, compromising the original plans of how some tests were to be performed. Instead of laying flat as well as being reflective, the bi-stem thermal shield puckers on the solar-facing side and contains through-thickness cracks and has pieces flaking off. Between the fused rings, or welds, the solar-facing side is no longer continuously connected, and

large holes and cracks reaching from the inner weld to the outer weld exist. Images at low magnification of cracks and holes taken with an Olympus Stereo Zoom microscope are provided in Figure 3.



Figure 3. Optical microscopy images of the thermal shield sample section "Weld 3": a). Hole in weld, and b). Through-thickness cracks.

Four tests are to be completed on both pristine material, to provide a control and reference to how degraded the material is, and the space-exposed material. The first of these are tensile tests. A 38.5 cm long dog-bone shaped piece of material, with 2.5 cm in the narrowest area, is cut and then stretched by a machine until the piece breaks. Results between the pristine and space-exposed materials can then be compared as to whether changes in the mechanical properties have occurred. Large differences between the pristine and space-exposed material are expected in the ultimate tensile strength and elongation at failure. Unfortunately due to the extensive damage on the solar-facing side of the space exposed material, a dog-bone sample appears to be impossible to cut, and so a tensile test will not be completed on the solar facing side. An attempt at getting a piece as close to the solar-facing side as possible will be done, to try to get an idea of the decrease in elongation at failure.

The optical properties of the bi-stem thermal shield will also be examined. The solar absorptance and thermal emittance are to be measured on both the pristine and space-exposed material and it is not expected that the optical properties will be greatly changed. To test these properties, a keystone shape will be cut out around a ring of both the pristine and solar-exposed material and using a Lambda-19 UV/VIS/NIR Spectrophotometer the reflectance will be measured. In the damaged area of the solar exposed material, a piece as close to the size needed will be cut.

Density and hardness tests will also be completed. To measure the nano-hardness of the material, a small, approximately 0.8 x 0.8 cm square is mounted on three Atomic Force Microscope holders. It is then placed inside of a nanomechanical system that is operated in conjunction with an Atomic Force Microscope and is able to provide ultra light load indentations and can continuously measure force and displacement as an indent is made. Hardness vs. contact depth measurements are made and graphed. Preliminary tests on pristine FEP have been conducted to evaluate creep during the indentation process. It is important to unload the indenter after creep has stopped. The tests conducted indicated that a 15 second hold period is needed to minimize creep. Figure 4 shows the creep tests conducted at 500  $\mu$ N loading for 5 mil pristine

Al-FEP. The deeper the indent the softer the material; and so by comparing the indent depths and computing the hardness from the indentation area the amount of embrittlement due to UV radiation can be quantified.

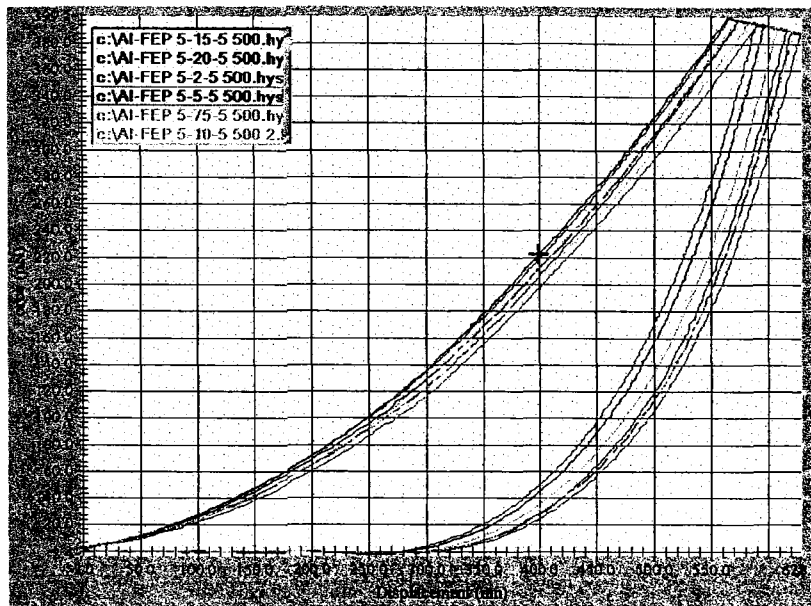

Figure 4. Nanomechanical indentation creep test data for pristine 5 mil thick Al-FEP.

Initial sample sectioning and documentation has been initiated, along with preliminary hardness testing. Tensile, optical, hardness & density tests are all planned. I hope to show the severe degradation of the space exposed Al-FEP bi-stem thermal shield throughout the testing process, and contribute to the continued research to improve materials used for space flight insulation. This information is crucial to the space community.



## **GRABER – the Duct Tape of Space and JIMO Heat Conducting Foam**

**Eleanor A. Gamble**  
Purdue University  
Materials Science Engineering  
Undergraduate, Senior  
**Mrityunjay Singh**

Crack formation in the space shuttle's heat shield during flight poses a major safety concern to everyone on board. Cracking weakens the structure of the shield and lessens the protection it offers against the high temperatures and forces encountered during re-entry. Astronauts need a way to mend these cracks while in space. This is GRABER's function; it can be 'spackled' into the cracks by an astronaut. The material then hardens, or cures, due to being in a vacuum and the heat encountered when it faces the sun.

A great deal of work and testing is necessary to create a material that will be workable in a vacuum over a wide range of temperatures, will cure without cracking, will adhere to the sides of the crack, and that can withstand the extreme temperatures of re-entry. A Brookfield PVS Rheometer is being used to characterize GRABER's viscosity at various temperatures and stirring rates. Various compositions of GRABER are being heat treated in a vacuum to determine probably curing times in space. The microstructures of cured samples of each composition are being examined using both optical and electron microscopy.

Jupiter's Icy Moon Orbiter (JIMO) will be lifting off sometime around 2013. JIMO will have more power than its predecessor, Galileo, allowing it to change orbits to circle three of Jupiter's moons. Both of the engine types being considered require large heat dissipation systems. These systems will be comprised of heat conductive tubing and plates with a liquid flowing through them. In order to maximize the speed of heat transfer between the tubes and the panels, the in-between areas will be filled with heat conductive silicon carbide foam.

Two different foam systems are being considered for this foam. Currently, experimentation is underway with adding SiC, carbon, and carbon fibers to a two part fire retardant foam. The foam is then pyrolyzed and its mass and dimensional changes are measured. The structure of the foam will be examined using optical and electron microscopy as well. Work is also planned with a foam system developed by an Italian team.

# CDF and PDF Comparison Between Humacao, Puerto Rico and Florida

Rosana González-Rodríguez

## INTRODUCTION

The knowledge of the atmospheric phenomenon is an important part in the communication system. The principal factor that contributes to the attenuation in a Ka band communication system is the rain attenuation. We have four years of tropical region observations. The data in the tropical region was taken in Humacao, Puerto Rico. Previous data had been collected at various climate regions such as deserts, template area and sub-tropical regions. Figure 1 shows the ITU-R rain zone map for North America.

Rain rates are important to the rain attenuation prediction models. The models that predict attenuation generally are of two different kinds. The first one is the regression models. By using a data set these models provide an idea of the observed attenuation and rain rates distribution in the present, past and future. The second kinds of models are physical models which use the probability density functions (PDF).

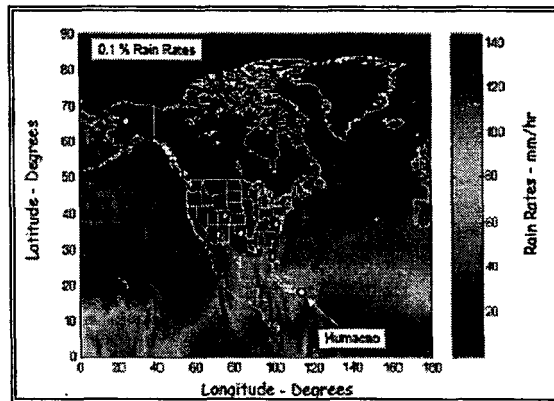

Figure 1. North America ITU-R Rain Zones

This paper presents the analysis of Humacao, Puerto Rico and Boca Ratón, Florida rain data through the development of the Probability Density Function (PDF) and the Cumulative Distribution Function (CDF). The PDF is a function of a continuous variable such that the integral of the function over a specific region yields the probability that its value will fall within the region. The CDF describes a statistical distribution. It has the value, at each possible outcome, of the probability of receiving that outcome or a lower one. The Humacao and Florida data sets are used to obtain the corresponding PDF and CDF. Humacao has 35 months of data, from July 2001 to May 2004. Florida has 46 months of data, from March 1995 to December 1998.

## EXPERIMENT DESCRIPTION

A Ka band Propagation Terminal is deployed in the roof of a building. The terminal is a 1.8 meter offset reflector antenna and weather instruments. These instruments take data for weather statistics like barometric pressure, outside temperature and relative humidity. The rain accumulation is measured with a tipping bucket rain gauge. A "tip" is a measurement of 0.01 millimeter of rain accumulation. Every time a tip occurs the instrument sends a signal to the computer data logging system which stores it in a file. The amount of rain collected from a gauge located on the roof of a building is usually lower than the amount collected from the gauge located on the ground. The difference in the catch of the gauge is caused by the air flow across the gauge [14]. Humacao rain data logging began on July 2001.

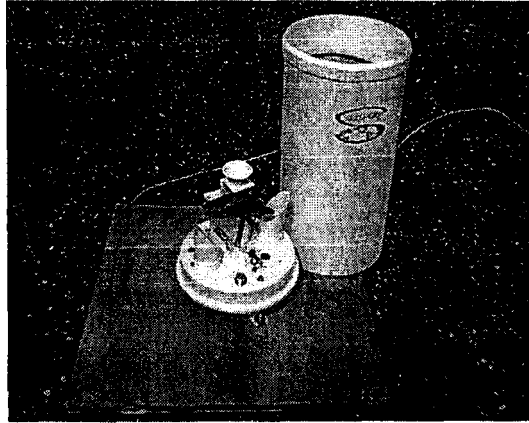

Figure 5. Tipping Bucket

| Latitude<br>Deg. | Longitude<br>Deg. | Azimuth<br>Deg. | Elevation<br>Deg. | Site<br>Altitude |
|------------------|-------------------|-----------------|-------------------|------------------|
| 18.1487          | -65.8385          | 108             | 37                | 70 m             |

Table 1. Humacao Terminal Description

#### DATA FILE DESCRIPTION

Humacao rain data file is a text archive that has seven columns and an indeterminate numbers of rows. The number of rows is indeterminate because they depend on the amount of tips recorded. The rain data file contains the following variables:

- Column 1: GMT DAY
- Column 2: Hours
- Column 3: Minutes
- Column 4: Seconds
- Column 5: Fractions of seconds.
- Column 6: Tips
- Column 7: Cumulative rain

An example of Humacao rain data file is:

```
5 22 40 13 40 .01 .0004
5 23 43 58 43 .02 .0092
6 00 02 06 02 .03 -.0008
```

The Florida rain data file is a text archive that has six columns containing the followings variables:

- Column 1: Year
- Column 2: Month
- Column 3: Day
- Column 4: Hours
- Column 5: Minutes
- Column 6: Seconds

An example of a Florida rain data file is shown below:

```
98 01 06 15 42 02.80
98 01 06 15 42 05.03
98 01 06 20 07 40.60
```

## RAIN RATE ANALYSIS

The data files need to be post-process for example, the time is change from the hours, minutes, seconds format to fraction of days as a define in equation 1 and 2. Equation 1 corresponds to the Humacao data files and equation 2 corresponds to the Florida data files.

$$t_k = A_{k,0} + \frac{A_{k,1} + \frac{A_{k,2}}{60} + \frac{A_{k,3} + A_{k,4}}{3600}}{24} \quad (1)$$

$$t_k = E_{k,2} + \frac{E_{k,3} + \frac{E_{k,4}}{60} + \frac{E_{k,5}}{3600}}{24} \quad (2)$$

The terms in equation 1 and 2 are defined as follow.  $A_{k,0}$  and  $A_{kE,2}$  correspond to the day of the year.  $A_{k,1}$  and  $A_{k,3}$  correspond to the hours.  $A_{k,2}$  and  $A_{k,4}$  correspond to the minutes.  $A_{k,3}$  and  $A_{k,5}$  correspond to the seconds and  $A_{k,4}$  is the fraction of a seconds.

To obtain the total rain fall we need to perform the sum of all tips. As previously mention the amount of water per tip is 0.01 inches. Total rainfall is defined in equation 3, where the variable Amp represents the amount of water in one tip.

$$Cum_k = \sum_{n=0}^k Amp_n \quad (3)$$

Equation 3 is redefined as equation 4 to account for the index definition used in the MathCAD software.

$$Rain\_Fall = Cum_{NP-1} \quad (4)$$

Equation 5 defines the time different of two consecutives tips. Subscript k represents the number of rows in data file.

$$\Delta 0_k = (t_{k+1} - t_k) \quad (5)$$

For eliminates two consecutive time values that are not on the same day in the data set we need to do a statement for  $\Delta 0_k$ . This statement establishes that when  $\Delta 0_k$  more than 1 the value that we need to use for  $\Delta 0_k$  will be 0.000001. In the other case ( $\Delta 0_k$  less than 1),  $\Delta 0_k$  will be  $\Delta 0_k$ .

For obtain the total time that the rain rate was between 1 mm/hr to 300 mm/hr we use a sum of all differences between the numbers of point between zero to number of point in the data file.

For calculate the rain rate in millimeters per hours we use the equation 6 that have the conversion of the rain rate in mm/hr units. If the increment in seconds and limit the max rain rate to 300 mm/hr rain rates and the min rain rate to 1 mm/hr is more than three we use that data point and we convert it in mm/hr. In the other hand, if that increment in second is less than 3 we do not use the data point for analysis purpose.

For calculate the Probability Density Function (PDF) we use the following range:

$$\begin{aligned} 0 < rr < 10 \\ 10 < rr < 20 \end{aligned}$$

$20 < rr < 30$   
 $30 < rr < 40$   
 .....  
 $150 < rr < 160$

To obtain the percent of the time the indeterminate rain rate can happen (PDF), first we add all samples that fall in a specific rain rate range, then it is divided by the total number of raw data points and the results is then multiply by 100.

$$PP_m = \frac{P_m}{P\_total} \times 100 \quad (6)$$

In equation 7 we have the add of all samples that fall in a specific rain rate range

$$P_m = \sum_{k=0}^{rows(A)-2} if(m \cdot 10 < RR_k < m \cdot 10 + 10, 1, 0) \quad (7)$$

In equation 8, we have the total of number of raw data points.

$$P\_total = \sum_{m=0}^{15} P_m \quad (8)$$

In the other hand, to obtain the Cumulative Distribution Function (CDF), first we add of all samples in a specific rain rate, then it is divided by the total number of points and the results is then multiply by 100.

$$CUM_m = \frac{CUM1_m}{CUM1_0} \times 100 \quad (9)$$

In equation 10 we have add of all samples in a specific rain rate where m is a number between zero to fifth teen.

$$CUM1_m = \sum_{k=m}^{15} P_k \quad (10)$$

## RESULTS

The Probability Density Function (PDF) for four years of data in Humacao and Florida is show in figure 2.

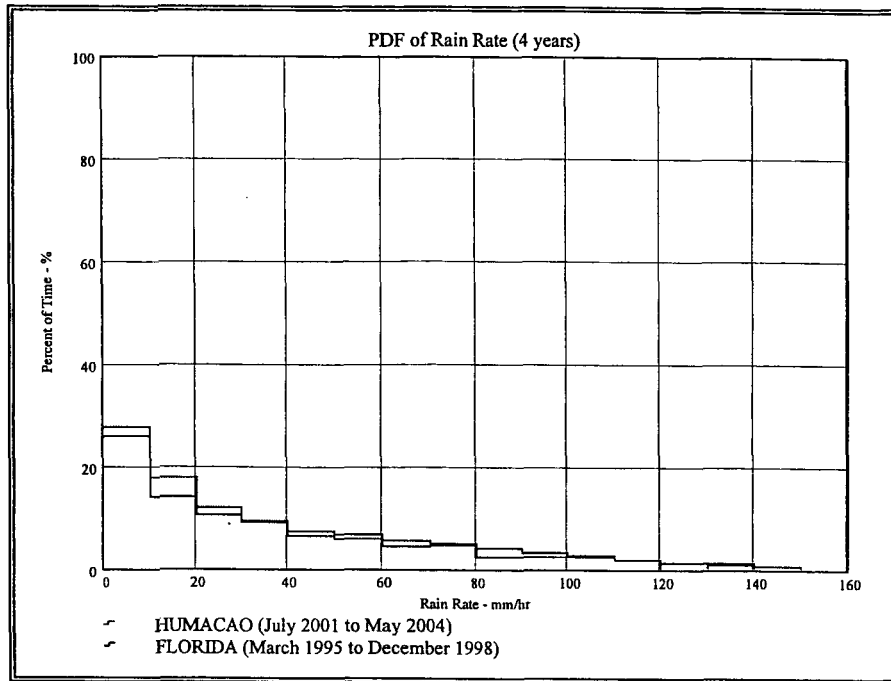

Figure 2. Probability Density Function

The Cumulative Distribution Function (CDF) for four years of data in Humacao and Florida Data is show in figure 3.

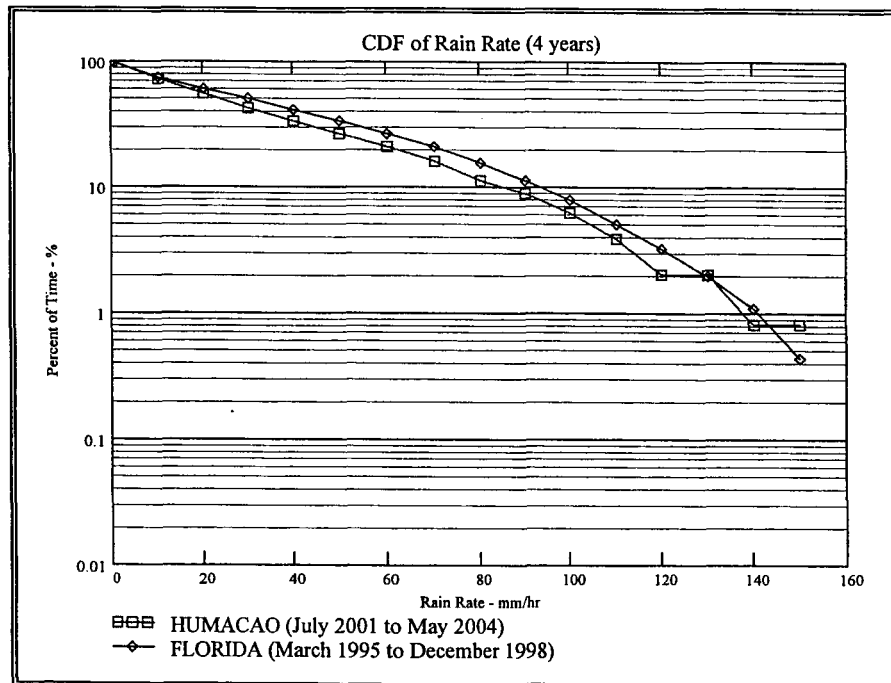

Figure 3. Cumulative Distribution Function

## CONCLUSION

The probability of rain rate between Humacao and Florida are basically the same. Humacao was bigger percent of probability than Florida in the smaller rain rates (0 to 30 mm/hr), but later it gets almost the same. In the larger rain rates (100 to 160 mm/hr) Humacao and Florida has the same percent probability for obtain that quantity of rain. The cumulative distribution function (CDF) shows that Florida has more percent of time to have a determinate rain rate in mm/hr than Humacao. Humacao has more percent of time to have the larger rain rate (between 140 to 160 mm/hr) than Florida. Humacao and Florida has the same percent of time to have a smaller rain rate (0 to 10 mm/hr). Florida has more percent of time to have a rain rate between 20 to 140 mm/hr than Humacao. Florida rain rate data shows larger rain probabilities in the range of 20 to 140 mm/hr than Humacao. The conclusions will be summary in that Florida is a worst case of rain rate than Humacao, Puerto Rico. Now the next step that we need to do is investigate is an atmospheric event occur by analyzed Florida data by month.

## REFERENCES

- 1) W.C.Y. LEE, "An Approximate Method for Obtaining Rain Rate Statistics for Use in Signal Attenuation Estimating," IEEE Transactions on Antennas and Propagation, vol. AP-27, pp. 407-413, May 1979.
- 2) J. Goldhirsh, "Slant Path Fade and Rain-Rate Statistics Associated with the COMSTAR Beacon at 28.56 GHz for Wallops Island, Virginia over a Three-Year Period," IEEE Transactions on Antennas and Propagation, vol. AP-30, pp. 191-198, March 1982.
- 3) J. Goldhirsh, "Yearly Variations of Rain-Rate Statistics at Wallops Island and their Impact on Modeled Slant Path Attenuation Distributions," IEEE Transactions on Antennas and Propagation, vol. AP-31, pp. 918-921, November 1983.
- 4) M. Juy, R. Maurel, M. Rooryck, I.A. Nugroho and T. Hariman, "Rain Rate Measurements in Indonesia," Electronics Letters, vol. 26, pp. 596-598, 26<sup>th</sup> April 1990.
- 5) E. Vilar and A. Burgueño, "Analysis and Modeling of Time Intervals Between Rain Rate Exceedances in the Context of Fade Dynamics," IEEE Transactions on Communications, vol. 39, pp. 1306-1312, September 1991.
- 6) F. Dintelmann and H. Trommer, "Year-To-Year Variability and Worst-Month Statistics of Long-Term Rain Rate Measurements in Germany," Electronics Letters, vol. 27, pp. 617-618, 11<sup>th</sup> April 1991.
- 7) J. Goldhirsh, V. Krichevsky and N.E. Gebo, "Rain Rate Statistics and Fade Distributions and 20 ad 30 GHz Derived form a Network of Rain Gauges in the Mid-Atlantic Coast over a Five Year Period," IEEE Transactions on Antennas and Propagation, vol. 40, pp. 1408-1415, November 1992.
- 8) D.G. Sweeney and C.W. Bostian, "The Dynamics of Rain-Induced Fades," IEEE Transactions on Antennas and Propagation, vol. 40, pp. 275-278, March 1992.
- 9) F. Moupfouma and L. Martin, "Point Rainfall Rate Cumulative Distribution Function Valid at Various Locations," Electronics Letters, vol. 29, pp. 1503-1505, 19<sup>th</sup> August 1993.
- 10) J. Goldhirsh, "Rain Rate Duration Statistics over a Five-Year Period: A Tool for Assessing Slant Path Fade Durations," IEEE Transactions on Antennas and Propagation, vol. 43, pp. 435-439, May 1995.
- 11) P.J.I. de Maagt, J. Dijik, G. Brussaard and J.E. Allnut, "Primary and Secondary Statistics of Rain Attenuation and Rain Rate Measured on a Satellite-to-Earth Path in Indonesia," Antennas and Propagation Conference Publication, No. 407, pp. 123-126, 1995.

- 12) J.T. Ong and C.N. Zhu, "Effects of Integration Time on Rain Rate Statistics for Singapore," 10<sup>th</sup> International Conference on Antennas and Propagation, Conference Publication No. 436, pp. 2.273-2.276, 1997.
- 13) C.N. Zhu and J.T. Ong, "Yearly Variation of Rain-Rate Statistics by a Rain-Gauge Network and Modeled Slant Path Rain Attenuation Distributions at 11 GHz in Singapore," International Conference on Information, Communications and Signal Processing, ICICS'97, pp.1719-1721, 1997.
- 14) R.K. Crane and P.C. Robinson, "ACTS Propagation Experiment: Rain-Rate Distribution Observations and Prediction Model Comparisons," Proceedings of the IEEE, vol. 85, pp. 946-957, June 1997.
- 15) J.T. Ong and C.N. Zhu, "Ku-Band Satellite Beacon Attenuation and Rain Rate Measurements in Singapore-Comparison with ITU-R Models," 10<sup>th</sup> International Conference on Antennas and Propagation, Conference Publication No. 436, pp. 2.153-2.156, 1997.
- 16) J.T. Ong and C.N. Zhu, "Rain rate measurements by a rain gauge network in Singapore," Electronics Letters, vol. 33, pp. 240-242, 30<sup>th</sup> January 1997.
- 17) J. Chebil and T.A. Rahman, "Rain rate statistical conversion for the prediction of rain attenuation in Malaysia," Electronics Letters, vol. 35, pp. 1019-1021, 10<sup>th</sup> June 1999.
- 18) C. Ito and Y. Hosoya, "Worldwide 1 min rain rate distribution prediction method which uses thunderstorm ratio as regional climatic parameter," Electronics Letters, vol. 35, pp. 1585-1586, 2<sup>nd</sup> September 1999.
- 19) K.S. Paulson and C.J. Gibbins, "Rain models for the prediction of fade durations at millimetre wavelengths," IEE Proc.-Microw. Antennas Propag., vol. 147, pp. 431-436, December 2000.
- 20) R.K. Crane, "A Local Model for the Prediction of Rain-Rate Statistics for Rain-Attenuation Models," IEEE Transactions on Antennas and Propagation, vol. 51, pp. 2260-2273, September 2003.
- 21) M. Akimoto, K. Harada and K. Watanabe, "Long-Term Changes in Rainfall Tendency and Estimation Method of One-Minute Rain Rate Distribution in Japan," IEEE, pp. 162-666, 2003.
- 22) M.S. Pontes, M.R.B.P.L. Jimenez and N.L. Damasceno, "Enlace - Analysis and Prediction of Rainfall Rate and Rain Attenuation Distribution," pp. 454-457.
- 23) J.H. Lee, Y.S. Kim, J.H. Kim and Y.S. Choi, "Empirical Conversion Process of Rain Rate Distribution for Various Integration Time."
- 24) S.K. Sarkar, M.V.S.N. Prasad, H.N. Dutta, B.M. Reddy and D.N. Rao, "Rain and Extent of Rain Cells Over the Indian Subcontinent," pp.318-321.



**Phase II – Development of the On-board Aircraft Network**  
**Mentor: Richard A. Slywczak**  
**Written By: Bryan D. W. Green and Okechuckwu A. Mezu**

**Description of Work**

Phase II will focus on the development of the on-board aircraft networking portion of the testbed which includes the subnet and router configuration and investigation of QoS issues. The testbed configuration will look like the following:

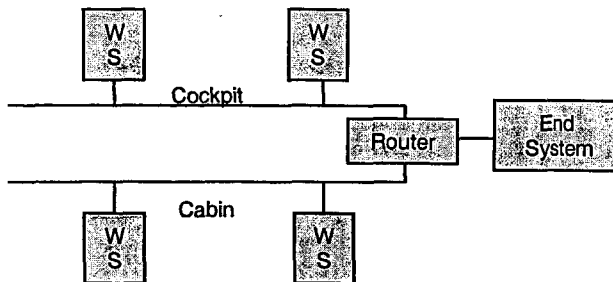

This implementation of the testbed will consist of a workstation, which functions as the end system, connected to a router. The router will service two subnets that provide data to the cockpit and the passenger cabin. During the testing, data will be transferred between the end systems and those on both subnets. QoS issues will be identified and a preliminary scheme will be developed. The router will be configured for the testbed network and initial security studies will be initiated. In addition, architecture studies of both the SITA and Immarsat networks will be conducted.

Testing Objectives

The phase II testing will accomplish the following objectives:

1. Configure the testbed for the aircraft on board configuration.
2. Perform QoS analysis based on the configuration settings in the router and IOS operating system.
3. Perform architectural studies on the SITA and Immarsat Networks to understand the configuration and operation of both systems.

### **Quality of Service Defined:**

Quality of Service is defined as a network's ability to provide consistent performance for a specified service. The purpose of the Weather Information Communications (WINCOMM) Project is to develop advance communications and information for aircraft. This involves improving the time and manner in which weather data is sent to aircraft from the ground. Since the cockpit's communication method will now work on the packet switch network, several Quality of Service issues arise. Data destined for the cockpit needs to have priority over data destined to the cabin. Data priority is an issue where specified network traffic receives preferred treatment over other traffic while traveling to its destination. The goals of Quality of Service include:

1. Dedicated bandwidth
2. Controlled jitter and latency
3. Improved loss characteristics

The testbed for the cockpit/cabin scenario consists of two workstations running both Linux Red Hat 9 and Microsoft Windows Server 2000. One machine emulates the cabin and the other machine emulates the cockpit. Both workstations are connected to a Cisco router through an eight port hub. A front end system is connected to another router through a switch. The two routers are connected for emulation through the serial interfaces. The QoS features on the first router will be used to improve service.

The Cisco's IOS has four aspects of QoS which include classification, marking, policing and shaping, and queuing. Classification is basically separating network traffic into a specified class of service. The separation of classes can be based on an incoming interface, source or destination address, or applications. Marking consists of putting some type of mark on packets that enter or leave the router according to the classification scheme. Policing and shaping is a reaction to the marked packets. This aspect of QoS controls the traffic entering or leaving the router, so that the network conditions are predictable. Finally, queuing controls how and in what order packets are allowed to enter and leave the network.

Cisco IOS offers different types of QoS tools and below are the tools relevant to our application with examples:

**Classification** – this tool is used to identify and mark flows such as Policy-Based Routing (PBR).

**Congestion Management** – Examples of these are Priority Queuing (PQ), Weighted Fair Queuing (WFQ), and Class Based Weighted Fair Queuing (CB/WFQ). The manage the network upon congestion

**Congestion Avoidance** - Congestion avoidance techniques monitor the network traffic loads in order to prevent network congestions. Some examples are Weighted Random Early Detection (WRED), and Committed Access Rate (CAR).

**Policy-Based Routing** - It was first implemented on Cisco IOS Software Release 11.1. This mechanism forwards/routes data packets based on predefined polices according to

Access Control Lists. Thus classification and marking are the QoS features provided by Policy-Based Routing.

Access Control Lists are used to classify particular traffic by implementing a sequential list of permit and deny conditions. These lists are applied to an interface on the router and can be used to filter data based on applications, protocols, port numbers, and/or IP addresses.

Policy-Based Routing also allows for the marking of the IP precedence bits located in the type of service field of the IP header. The first three bits of the TOS field represent the IP precedence field. Although there are eight possible combinations, only six classes are available.

**Priority queuing (PQ):** It is implemented in Cisco IOS Software Release 11.1 and above. It ensures that important traffic gets precedence over others. PQ can be prioritized by network protocol, incoming interface, packet size, source/destination address, etc. Packets are categorized in one of four queues – high, medium, normal, or low – based on assigned priority.

**Weighted Fair Queuing:**

Weighted Fair Queuing is implemented to overcome the limitations of the first in first out (FIFO) queuing. WFQ is implemented in Cisco IOS Software Release 11.1.

Weighted Fair Queuing separates traffic based on source and destination network or MAC address, protocol, source and destination port, and socket numbers of a particular session. The classification scheme allows network traffic to be distributed in conversation like schemes based on fair queues. Data is placed in queues based the time it takes for the last bit of each packet to arrive.

**Class Based Weighted Fair Queuing** improves WFQ by allowing user defined classes of traffic. Traffic can be classified based on matching protocols, access control lists, and/or input interfaces. Bandwidth, weight, and maximum packet limit are administered to class during congestion periods.

**Weighted Random Early Detection**

WRED algorithm is designed to avoid congestion before it becomes a problem. It combines the RED algorithm with IP precedence to provide preferential traffic handling for high priority packets. WRED can be configured to discard lower priority traffic when the interface begins to get congested.

**Committed Access Rate:**

Committed Access Rate is available in Cisco IOS Software Release 12.1. CAR performs two QoS functions.

Packet classification is accomplished by separating traffic based on physical ports, source or destination IP or MAC address, application port, or the IP protocol type as specified in the Access Control List. After the data is classified, it is marked using the IP precedence bits.

CAR also has the ability to police and shape data. This is accomplished by managing the bandwidth for a given class of traffic through rate limiting. Traffic that falls between

specified rates is transmitted. While the other data is either dropped or placed in a different priority category.

### Implementation and Architectures:

The current architecture for the aircraft IP network testbed is shown in the following diagram.

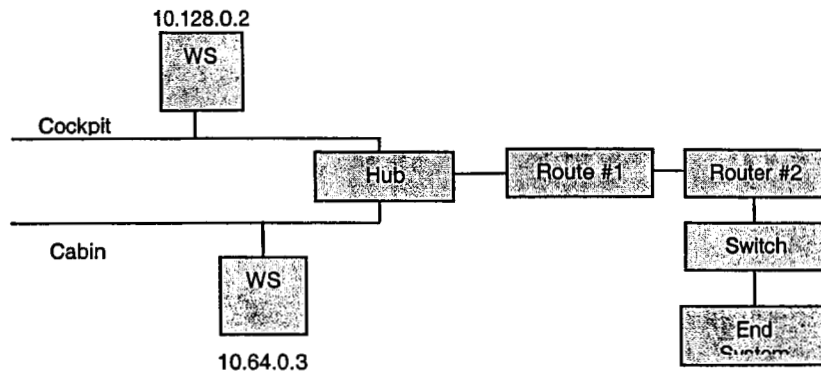

The routers used in this diagram are 2500 series routers with one Ethernet port each. The two routers are connected via the serial interfaces.

All of the tools available for QoS will work with this existing architecture. However, some of the features in these tools will only work under different configurations and architectures.

### Priority Queueing:

Implementing the priority queueing tool in the existing architecture can be accomplished via an access list and a priority list. Creating the appropriate access list and matching it with a priority list will classify the network traffic into the necessary priority queue. Only one priority list can be assigned to a specified interface.

Priority queueing also has the ability to assign priorities based on the interface packets are entering. If the cockpit and cabin have a dedicated interface for incoming traffic, the data entering the router can be classified into one priority queues. This means explicitly declaring that packets entering the interface assigned to the cockpit be place into the high priority queue. This also means using a router with more than one Ethernet interface.

### Committed Access Rate:

Implementing the committed access rate tool in the existing architecture can be accomplished by using the appropriate access list and by specifying a rate limit. Once the policy is matched with an access list the transmission rate for cockpit or cabin data can be specified.

CAR also has the ability to identify packets based on the IP precedence bits in the IP header. However, this requires QoS implementation on the source end of this scenario.

Once the bits are marked and sent through the network, the aircraft's router can use CAR to specify a rate limit for the cockpit and/or cabin.

**Policy-Based Routing:**

Policy-Based Routing allows for the setting of IP precedence, IP next-hop, and interface after matching the appropriate access list. The IP precedence bits can be used to declare priority and this tool can be used on the current architecture.

**Weighted Fair Queuing:**

Weighted Fair Queuing along with Class Based WFQ are IP precedence aware. Using this feature within this tool is the best implementation for QoS. However, configurations must be implemented on the source end of this scenario as well. This tool will work with the current architecture.

**Notes / Recommendations:**

Using routers with more than one Ethernet interface would be very beneficial to this scenario. The schemes and configurations will be more intricate allowing for the best implementation of QoS.

Access Control Lists are normally used as security features. Therefore, when using this tool to implement QoS the list must be configured carefully. If the list permits only one class of traffic all other traffic will be implicitly denied.

IP precedence and Differentiated Services Code Point both take advantage of the QoS solutions within the IP header. Both use the type of service field to mark precedence bits. These tools often times require cooperation throughout all of the networks in which the data packets are traveling.

# Development of the Planar Inlet Design and Analysis Process (PINDAP)

**Christopher R. Gruber**  
University of Notre Dame  
Aerospace Engineering  
Undergraduate, Junior  
**Mentor: Dr. John W. Slater**

## PROJECT SUMMARY

The aerodynamic development of an engine inlet requires a comprehensive program of both wind tunnel testing and Computational Fluid Dynamics (CFD) simulations. To save time and resources, much "testing" is done using CFD before any design ever enters a wind tunnel.

The focus of my project this summer is on CFD analysis tool development. In particular, I am working to further develop the capabilities of the Planar Inlet Design and Analysis Process (PINDAP). "PINDAP is a collection of computational tools that allow for efficient and accurate design and analysis of the aerodynamics about and through inlets that can make use of a planar (two-dimensional or axisymmetric) geometric and flow assumption."<sup>1</sup> PINDAP utilizes the WIND CFD flow solver, which is capable of simulating the turbulent, compressible flow field.

My project this summer is a continuation of work that I performed for two previous summers. Two years ago, I used basic features of the PINDAP to design a Mach 5 hypersonic scramjet engine inlet and to demonstrate the feasibility of the PINDAP. The following summer, I worked to develop its geometry and grid generation capabilities to include subsonic and supersonic inlets, complete bodies and cowls, conic leading and trailing edges, as well as airfoils. These additions allowed for much more design flexibility when using the program. This summer, I am working with Dr. Slater to add

---

<sup>1</sup>"Planar Inlet Design and Analysis Process (PINDAP)" John W. Slater

additional automation capabilities to PINDAP in order to make it more user-friendly so that a non-CFD expert could use PINDAP to design and analyze an inlet, duct, airfoil, etc.

The development focus for this summer is to add several "design modules" to PINDAP which would allow a designer to model an aerodynamic object without the numerous and tedious design inputs previously required. For example, a NACA 4-Digit Series airfoil design module is currently under development. This would allow a designer to input minimal geometry information such as chord length and 4-digit airfoil number in addition to other grid spacing parameters and then using that information, PINDAP would generate the airfoil geometry and grid for use with CFD simulations. Previously, a designer would have had to individually input all of the curve entities making up the airfoil shape in addition to many other grid and zone parameters. Concurrently with the airfoil design module, a supersonic inlet design module is also being developed. This module will significantly simplify the rather complex task of designing the appropriate inlet geometry as well as simplify the grid generation process for supersonic inlets. This design module could potentially be applied to current design concepts of the Supersonic Business Jet.

Following the addition of several design modules to PINDAP, I will be using the software to run through the design and analysis of an inlet (or airfoil, etc) utilizing all PINDAP components. This will be used as an example case (tutorial) for a PINDAP user's manual that is being written as the software is developed.

Dr. Slater has set the goal of an alpha release of the software to several branch members during the summer, and if all goes according to plan, the months of work on this project will culminate with a beta release to the Inlet Branch sometime in August

2004. These pre-releases will allow branch members to evaluate the software and provide additional input and suggestions prior to the release of version 1.0. A timetable has not been set for that release. Dr. Slater has also begun work on an AIAA (American Institute of Aeronautics and Astronautics) paper on PINDAP which he is planning to submit to one of the upcoming AIAA conferences.



Lucien Hertert  
NDE Group  
MS 6-1  
3-3684

### An Overview of My 2004 Summer Internship

This summer I have been working with the Non-destructive evaluation (NDE) group and NASA Glenn Research Center. As this is my second summer with the group, I was able to begin working as soon as I arrived. My first task was to develop a system to acquire an impedance analyzer. The basic setup of the system is as follows: a piezo-electric patch is attached to a sample, and a lead is attached to that patch. Another lead is attached directly to the sample, and the leads are connected to the impedance analyzer. The system then puts a voltage through the material over a range of frequencies, and the corresponding impedances are measured for each frequency. After data is collected, it can be compared to another data set, and through a series of calculations a damage parameter is produced. For the time being, we are using a correlation calculation to find the damage parameter. The hope for this project is that a baseline measurement can be taken, and then sometime later another measurement could be taken, and the damage parameter would determine how much damage had been done to the sample. To test this hypothesis, we took baseline data from a sample, and then sent it out to have a notch cut into it. When it was returned, we again took measurements on the sample, and the damage parameter was significantly lower (this signifies more damage, because a perfect correlation is 1).

Another project that I have been working on pertains to the group's newly acquired acoustography system. This system creates a full field ultrasonic signal on one side of a sample, and an acousto-optic sensor is placed on the other side of the sample.

The acousto-optic sample changes colors based on the intensity of the ultrasonic field that passes through the sample, and a camera captures pictures of the acousto-optic sensor. This system was developed by a commercial group working in conjunction with our group. Since the system was delivered, we have ported the control and analysis software from C to LabVIEW, and are currently working on optimization and improvements in both areas of the software. I worked heavily on optimizing the internal representation of images (16-bit, RGB, etc.) as well as overall program structure optimization. In the near future, I will be working on converting this system over to a real-time processing environment.

A third project I have worked on was mostly a continuation of a system I developed last summer. This system uses our thermography setup to measure the reflectance of a sample. Thermography is conceptually fairly simple: flash lamps heat up a sample and an infrared camera captures the heat profile of the sample as it cools. The idea is that the cooling rate will differ in areas that there is a structural inconsistency, such as a flaw. Measuring reflectance is a bit more complicated, but it consists of taking four sets of images: light on/no sample; light off/no sample; light on/with sample; light off/no sample. Each set of images is averaged to obtain a representative image, and calculations are done on a pixel-by-pixel basis to calculate the reflectance for each pixel. This summer, I have been adding functionality to the program that I created last year in order to better suit the needs of my mentor in the research he is currently doing.

For the rest of the summer, I will be working on various other projects, such as the real-time implementation of the acoustography system, as well as updating the data acquisition software for our groups' guided wave scanner.

## My Summer Experience as an Administrative Officer Assistant

**Janelle C. Jones**

Spelman College

Mathematics

Junior

**Mentor: Sandra Hardy**

The motto of the Safety and Assurance Directorate (SAAD) at NASA Glenn Research Center is "mission success starts with safety." SAAD has the functions of providing reliability, quality assurance, and system safety management to all GRC projects, programs and offices. Product assurance personnel within SAAD supervise the product assurance efforts by contractors on major contracts within GRC. The directorate includes five division offices and the Plum brook Decommissioning Office. SAAD oversees Glenn's Emergency Preparedness Program which handles security, hazmat, and disaster response and supervision.

The Safety and Assurance Directorate Office (8000), headed by Vernon Wessel, offers direct support to the entire directorate. It ensures the implementation of Headquarters and GRC administrative, fiscal, and human resource policies. The office sustains the Directorate managers in providing resources and expertise. During my internship, I worked in this directorate office under the administrative officer.

The administrative officer has a number of responsibilities within the directorate. She reviews and initiates action on task orders involving a full range of scientific and engineering disciplines. She evaluates the contractor task plans including statement of work, funding, and schedule requirements. She manages purchase requests for required funding, while providing fiscal year and contract funding status. She also directs and coordinates programs and projects that support the directorate, while acting as the liaison between her directorate and other within Glenn Research Center.

My main objective was to work with the financial and budgetary side of the directorate office. This included working with the entire budgets of the five divisional offices in the directorate, including risk management, Glenn safety, environmental management, quality management, and Plumbrook decommissioning office. My tasks included updating and inputting transaction data in numerous excel spreadsheets that tracked the finances of the different offices. I monitored and analyzed the travel, training, overtime, awards, and labor budgets for each of the offices. I also ran monthly reports in each of the areas to give to the division managers and the director of the Safety and Assurance Directorate. These reports would include the amount of money budgeted, the amount of money spent, the percentage through the fiscal year, and the amount of money remaining, along with other information requested from chiefs and managers. Based on my analysis of the reports and conclusions I drew from the data, division chiefs would make decisions about their office for the upcoming

weeks and months regarding the use of their budget balance. Also, there would be an itemized list giving the details of how exactly money had been spent within the office. As required by NASA headquarters our directorate is responsible for updating certain metrics that can be seen on the NASA website. I was given the job of bringing all of these metrics up to date to be approved by appropriate personnel at headquarters. To aid in the completion of my tasks I attended all relevant meeting, including staff meeting and teleconferences. Moreover, I played a big part in managing the budget of the NASA Engineering and Safety Center (NESC) Program. This program was created by Administrator O'Keefe to provide a central location to coordinate independent engineering and safety assessments across the agency. To supervise the money I met with the chief engineer and attended weekly teleconferences with individuals from all of the other centers.

These tasks were completed using a number of different software applications. One of those was the Integrated Financial Management Program. Within this program are the Core Financial and Core Financial Business Warehouse Programs. These two programs allow me to see all charges that have been made inside the entire directorate that meet the specifications that I input. They were instrumental in giving reports to division office chiefs and other managers within the directorate. Another necessary skill to complete my objectives was an in depth knowledge of Microsoft Excel spreadsheets. I often needed to create mathematical formulas and do extensive formatting to the worksheets. I had to arrange data so that it was easy for the reader to see exactly how much money remained in each budget while including enough information for the reader to see how that money had been spent. This part of my objective allowed me to work on my relationship skills because I had to interact with various personalities.

I made sure that my internship experience included more than tasks delegated to me by my mentor. I also participated in a number of different projects. One was the GRC Adopt-a-Highway Program. Glenn, as a participant in this program, is responsible for maintaining the cleanliness of a stretch of highway a short distance from the GRC facilities. A couple hours a month other volunteers and myself would venture out to the highway and pick up trash and other things left beside the road. Another project was chaperoning a group of middle school aged children in the NASA project program to the COSI museum in Toledo, Ohio. The NASA Project program is designed to motivate students to pursue higher education in the fields of math, science, and engineering. I also walked along side the NASA float in the Lorain International Parade. I was dressed in an astronaut outfit and passed out literature pertaining to NASA and educational program offered at Glenn to those attending the parade.

**Programming an Experiment Control System**

**Stuart Lange**

Princeton University  
Major: Physics  
Sophomore

**Mentor: Donald Chubb**

Paper in lieu of Research Symposium II presentation

July 16, 2004

NASA Glenn Research Center  
Photovoltaic and Space Environments Branch

As NASA develops plans for more and more ambitious missions into space, it is the job of NASA's researchers to develop the technologies that will make those planned missions feasible. One such technology is energy conversion. Energy is all around us; it is in the light that we see, in the chemical bonds that hold compounds together, and in mass itself. Energy is the fundamental building block of our universe, yet it has always been a struggle for humans to convert this energy into useable forms, like electricity. For space-based applications, NASA requires efficient energy conversion methods that require little or no fuel.

Here at the NASA Glenn Research Center, the Photovoltaic and Space Environments branch has spent years researching one such method, solar cell (photovoltaic) arrays. This summer, I worked as an intern in this branch under Dr. Donald Chubb, who is currently researching a novel application of solar cell technology, Thermophotovoltaics (TPV). A TPV system at its core contains three parts: a heater, an emitting material, and a photovoltaic array. The heater brings the emitter material up to a high temperature. The heated emitter releases electromagnetic radiation in the infrared range. This radiation is then absorbed by the photovoltaic cells, which convert the radiation energy into electricity. In order to make the TPV system as efficient as possible, the emitter and the photovoltaic array must be synchronized, that is, the emitter must emit a large amount of radiation at wavelengths that the photovoltaic cells absorb well. The system's heater can be anything that produces heat – a traditional combustion source, a nuclear reaction, or something else. This flexibility makes the TPV system adaptable to many different applications, both space-based and terrestrial.

This summer in Dr. Chubb's lab, we have been preparing an experiment that will help determine the expected usable life of a TPV system. A major limiting factor on the life of the system is the evaporation of the emitter material and its deposition on the photovoltaic cells. As the emitter material deposits on the cells, the cells become less and less efficient. Our experiment will measure the vapor pressure of some candidate TPV emitter materials, allowing us to determine how much lifespan we can expect out of a TPV system utilizing each different material.

The experiment itself takes place inside a vacuum chamber. A sample of the emitter material is heated by a filament, which carries a current delivered by a power supply. Due to the extreme heat, emitter material will evaporate and deposit onto a detector called a quartz crystal monitor (QCM). This detector determines the rate of deposition and the thickness of the deposited material based on changes in the oscillation frequency of the crystals. The rig also contains several thermocouples to monitor the temperature and a residual gas analyzer (RGA), which analyzes the composition of the extremely low-pressure atmosphere inside the rig.

My work this summer has focused on creating the computer program that will communicate with all the experimental equipment, and therefore serve as the monitor, control, and recording system for the experiment. I have done all my programming in Microsoft's Visual Basic design environment. To create the program, I first adapted some existing programs and created some new programs that talk to each piece of equipment individually. The different components communicate with the computer through three different hardware systems: the computer's COM ports, a GPIB (General Purpose Interface Bus), and a PCI (Peripheral Component Interconnect) card. In order to

communicate with the devices, I had to become familiar with the programming protocols for all three.

Right now, I am nearing completion of the first version of the experiment control program, which will display and record data from the QCM, thermocouples, power supply, and pressure gauge simultaneously. In addition, the program will allow the user to control each device. This will allow the user to set such things as the measurement units of the pressure gauge, the QCM's parameters, and the current delivered by the power supply. The program will also calculate the vapor pressure of the material being evaporated. This program will be used to monitor the initial run of the experiment, in which we will test the vapor pressure of silver. Since the vapor pressure of silver is already well known, we can compare our results to the accepted value to test the accuracy of our rig.

For subsequent runs of the experiment, in which we will be testing the unknown vapor pressures of our TPV emitter materials, I will expand the program to automatically change the current delivered by the power supply to regulate the temperature of the material. This will allow the experiment to run for days to weeks with absolutely no user input.

The data from this experiment will help us learn important information as we develop a new technology, and my program will be responsible for gathering and recording that data.



# Reducing the Cation Exchange Capacity of Lithium Clay to Form Better Dispersed Polymer-Clay Nanocomposites

Maggie Liang

The Ohio State University

Major: Biochemistry

Undergraduate, Sophomore

Mentor: Sandi Campbell

## Abstract

Polymer-clay nanocomposites have exhibited superior strength and thermo-oxidative properties as compared to pure polymers for use in air and space craft; however, there has often been difficulty completely dispersing the clay within the matrices of the polymer. In order to improve this process, the cation exchange capacity of lithium clay is first lowered using twenty-four hour heat treatments of no heat, 130°C, 150°C, or 170°C to fixate the lithium ions within the clay layers so that they are unexchangeable. Generally, higher temperatures have generated lower cation exchange capacities. An ion exchange involving dodecylamine, octadecylamine, or dimethyl benzidine (DMBZ) is then employed to actually expand the clay galleries. X-ray diffraction and transmission electron microscopy can be used to determine whether the clay has been successfully exfoliated. Finally, resins of DMBZ with clay are then pressed into disks for characterization using dynamic mechanical analyzer and oven-aging techniques in order to evaluate their glass transition, modulus strength, and thermal-oxidative stability in comparison to neat DMBZ. In the future, they may also be tested as composites for flexural and laminar shear strength.

Improving the lifetime and overall performance of its high-temperature polymer materials is of constant interest to the Polymers Branch at NASA Glenn Research Center. One technique that is currently being studied is the dispersal of clay within composites in order to reinforce various polymers. Researchers have noted improvements in strength, heat stability, and gas barrier properties of polymer-clay nanocomposites in comparison to neat polymers. Moreover, all of these improvements can be attained at a relatively low clay loading of two to ten weight percent and without alteration to the polymer's basic properties or loss of clarity in the polymer.

Not only is clay a naturally very stable substance, its structure lends itself well as an even more promising means of fortification. Natural clay is composed of impermeable clay layers stacked very closely together, approximately 1 nanometer apart. Upon dispersal, however, the layers are separated and become aligned in random directions. The result is that these exfoliated clay layers create a treacherous pathway for any permeant to penetrate through the nanocomposite. This proves to be a significant advantage since one of the major concerns when dealing with polymers is the threat of degradation, particularly due to oxidation.

X-ray diffraction and transmission electron microscopy (TEM) are typically used to analyze the extent of clay dispersal. X-ray diffraction techniques can quantitatively determine the distance of separation between the clay layers. Using the Bragg equation,  $n\lambda = 2d\sin\theta$ , the d-spacing of the clay gallery for both the unmodified and dispersed clay can be calculated and then compared. The TEM also confirms dispersal by providing a qualitative picture of the separated clay layers. Characteristics of a successful dispersal image include clearly defined, thin clay layers that are spaced far apart and lie in many different directions.

However, due to strong electrostatic forces between the layers, clay generally disperses poorly in the matrices of the polymer. In order to make the inorganic clay more compatible with the organic polymer, an ion exchange is used to displace the cations present in the clay, such as sodium or lithium, with protonated diamines and protonated alkyl amines. The diamines are added to react with the ester/acid monomers used in polymer synthesis, while the long carbon chains are inserted between the clay layers to expand the gallery; thus, the clay becomes somewhat organophilic. Also, as the clay layers are separated, the surface area of the clay layers increases and the polymer chains are better able to integrate with the clay sheets. A series of three ion exchanged clays were prepared for each heat treatment using dodecylamine, octadecylamine, or dimethyl benzidine (DMBZ) for a total of twelve samples.

This summer I am particularly interested in lowering the cation exchange capacity (CEC) of the clay so that it will disperse better within the polymer matrices. In order to accomplish this, the clay is heat treated at various temperatures. These include unheated, 130°C, 150°C, and 170°C treatments for 24 hours each. During heating the cations

migrate from exchange sites throughout the gallery space into the actual clay layers, thus becoming unexchangeable. With fewer cations present, the electrostatic forces in the clay are even further weakened. The clay initially arrives, though, containing interlayer sodium ions which are too large to facilitate this process. For that reason, the first step is to exchange the sodium ions in the clay with smaller lithium ions using lithium chloride, even before the clay is heat treated. Thus, it is the fixation of lithium after modification rather than the naturally occurring sodium cations that result in a decreased CEC.

Afterward, the CEC is determined by repeated saturation of the samples with 0.10N aqueous ammonium acetate, added drop-wise. After centrifuging the sample, the supernatant is analyzed for lithium using inductively coupled plasma (ICP). The sample is placed into a high-temperature plasma or gas. When the atoms relax, they give off light which can be separated into wavelengths by spectroscopy. This makes it possible to analyze the chemical makeup of a substance as well as quantify these values by comparing the sample to a known standard sample. Repeating this procedure a total of three times, the CEC is calculated as the total number of milliequivalents of lithium extracted in the three washings divided by the mass of the clay used. Increasing the heat treatment temperature has been observed to cause a reduction in CEC values.

All of the clay samples are dispersed in the polyimide DMBZ. The resins are then prepared for testing by pressing them into small disks. They are tested using the dynamic mechanical analyzer (DMA) for modulus strength and glass transition temperature. The glass transition generally indicates the upper limit usage temperature. Also, the thermo-oxidative stability of the samples is monitored through oven-aging at 550°F for 1000 hours. The samples may be tested as composites for other mechanical properties such as flexural and laminar shear strength. Results of these tests are in the process of being compiled, but it is the hope that certain properties will greatly improve without losing the integrity of other properties.

Already used in other industries such as automobile manufacture, polymer-clay nanocomposites show great promise for aerospace application. The polymers currently used by NASA for air and spacecraft have the potential to be reinforced with a relatively small amount of clay to enhance their performance and durability.

# **FEASIBILITY OF EB WELDED HASTELLOY X AND COMBINATION OF REFRACTORY METALS**

**Diana A. Martinez**  
University of Texas- El Paso  
Metallurgical and Materials Engineering  
Undergraduate, Senior  
**Mentor: Frank J. Ritzert**

## **PROJECT DESCRIPTION AND ASSIGNMENT**

As NASA continues to expand its horizon, exploration and discovery creates the need of advancement in technology. The Jupiter Icy Moon Orbiter's (JIMO) mission to explore and document the outer surfaces, rate the possibility of holding potential life forms, etc. within the three moons (Callisto, Ganymede, and Europa) proves to be challenging.

The orbiter itself consists of many sections including: the nuclear reactor and the power conversion system, the radiator panels, and the thrusters and antenna. The nuclear reactor serves as a power source, and if successfully developed, can operate for extended periods.

During the duration of my tenure at NASA Glenn Research Center's (NASA GRC) Advanced Metallics Branch, I was assigned to assist Frank J. Ritzert on analyzing the feasibility of the Electron Beam Welded Hastelloy X (HX), a nickel-based superalloy, to Niobium- 1%Zirconium (Nb-1Zr) and other refractory metals/alloys including Tantalum, Molybdenum, Tungsten, and Rhenium alloys. This welding technique is going to be used for the nuclear reactor within JIMO.

As my assignment, I was responsible for researching and optimizing the EB weld joint for this and other combinations of refractory metals to the HX alloy. In order to achieve this, interfacing with other engineers from GRC was a critical step in accomplishing personal goals and others set forth by my mentor Frank.

Beginning my summer here at GRC, the initial step was to educate myself on the JIMO project and what its goals were. A further understanding of the overall goals helped to direct me in the right direction for my individual goals. After discussing a strategy for my portion, initial analyses began.

Given a NASA GRC draft work plan for the project, seen below, I was able to begin to formulate my test matrix with the help of my mentor.

**NASA GRC DRAFT WORK PLAN (F.J. Ritzert)**

| Refractory metal | Alloy*     | Superalloy  | Welding process |
|------------------|------------|-------------|-----------------|
| Nb alloys        | Nb-1Zr     | Hastelloy X | electron beam   |
|                  | C103       | Hastelloy X | electron beam   |
| Ta alloys        | T-111      | Hastelloy X | electron beam   |
|                  | ASTAR 811C | Hastelloy X | electron beam   |
| Mo alloys        | Mo-47.5Re  | Hastelloy X | electron beam   |
|                  | TZM**      | Hastelloy X | electron beam   |
| W alloys         | W-25Re**   | Hastelloy X | electron beam   |
| Re alloys        | Re***      | Hastelloy X | electron beam   |

\*All alloys listed are currently on-hand at NASA GRC

\*\*TZM and W-25Re are not considered as promising candidates due to post-weld behavior. They may be included for reference because the material is on-hand.

\*\*\*Re is not considered as a top tier candidate due to the lack of historical information. It may have considerable potential plus the material is on-hand.

To begin, an evaluation of the cleanliness of the EB welding process was to be conducted. To do so, a beam was run over the surface of a material, in this case Nb-1Zr, sectioned off and analyzed for the oxygen pickup within the weld. If within the suitable range, the project was permitted to press forward.

In determining the feasibility of the EB welded HX to any of the combination of refractory metals, test coupons were developed and sent to Walt Wozniak. Test coupons (1 sq. in) were EB welded together, sectioned off around the welded region, mounted, and prepped for optical analysis. The as-received weld joint was characterized based on a number of set parameters. Interest in intermetallic formation within the welded region and oxygen pickup, along with basic structure characterization, and chemical analysis of diffusion of elements into refractory alloy was conducted.

Again, Walt Wozniak helped in the optimization of the weld beam. This was done for each individual material due to the fact that each metal reacts differently to the welding process. Discussed in our meeting July 7 of 2004, Walt explained the significance to the beam width; the tighter the beam, the faster the process can be conducted as well as the lower the heat produced. The material will experience a small area of heat affected zone. Therefore, the optimization of the electron beam will be different for HX to Nb-1Zr and HX to C103. Seen below is a schematic of what and where the heat affected zone is seen:

**Figure 1: Schematic of EB welding process**

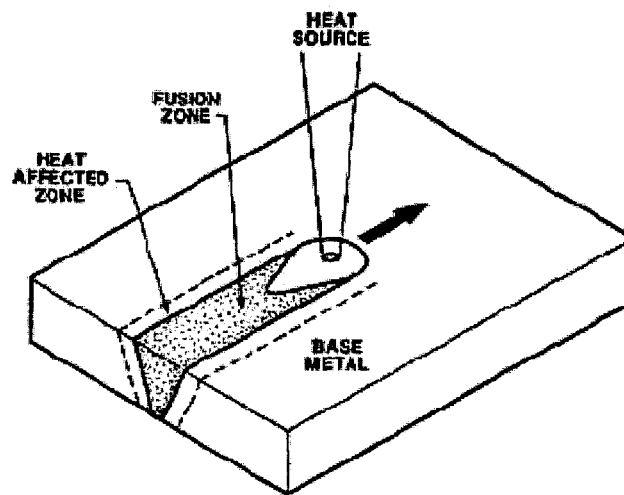

It was to be determined if having a wider electron beam would be more suitable for our overall goal, thus the optimization of the beam was key to this project.

In the case of the materials welded together, a cleaning process was done to remove any contaminants which might have caused such things as embrittlement within the welded region (oxygen pickup, etc). This was done with the help of those located in the ChemLab in Building 105.

Due to the timely process, there are no photographs to display the current analyses that have been performed to date. This is still an on-going project.

Further work to be completed in this portion of the project consists of encapsulation and aging of welded coupons at varying times. Metallographic examination and SEM analysis will be performed. Alternative joining techniques will be investigated including the bi-metal tubing concept.

## **My Work in the NASA Glenn History Office and Records Management Office**

**Robert C. Mate**  
Marquette University  
Political Science and English  
Undergraduate Senior  
**Mentor: Kevin P. Coleman**

This is my fourth summer working with my mentor, Kevin P. Coleman, who is the Center History Coordinator, Center Records Manager, and Center Forms Manager. I am working in the GRC History Office with some overlap in the Records Management Office. I have three major projects this summer. First, I am assisting in the documentation of historic facilities. Second, I am involved in a project to organize files and create an archives at Plum Brook Station. Third, I have helped the records management office with its inventory of stored records at Plum Brook. Also, I received an award this summer for research work I had done for NASA in the past.

First, my primary project is to help assemble documentation for historic facilities at Glenn. This is somewhat of an extension of my project from last summer. Last summer, I worked to compile a complete list of all of NASA's historic sites and landmarks (as designated by the National Park Service, as well as several private organizations) throughout the country. Then, I briefly researched the significance of historic designation under federal law. Finally, I put my findings into a report which was submitted to NASA Headquarters. Upon review by the NASA History Office and several center-level history officials, it was decided that NASA should work to update its documentation of its historic sites and landmarks since some of the documentation was outdated or unavailable. Until recently, many project managers and facility managers working at historic facilities were not even aware that their surroundings had been designated as historic under federal law (most specifically, the National Historic Preservation Act of 1966 and its amendments). Therefore, they were unaware of the legal obligations for historic preservation.

This summer, my project is to research some of Glenn's historic sites and landmarks in more detail. The goal is to put together a template for documenting historic NASA facilities. The hope is that this template of requirements for historic documentation of facilities (which may include records, drawings, photos, film, interviews, and a Web site) can be used agency-wide to assist center history offices in documenting historic sites and landmarks. To this end, I am working with Bob Arrighi, an archivist from InDyne, Inc., and Anne Burke, a NASA co-op, to gather and assess the historic value of records from several facilities at Glenn and Plum Brook Station. We will also work to determine the costs of each part of the template.

This project began with a meeting between Kevin Coleman, Glenn's Chief Architect Joe Morris, Bob Arrighi, and me. Joe Morris indicated that in addition to Glenn's current historic sites and landmarks, a significant section of the Center may one day be nominated as a "historic district." This possibility is not without consequence, as it would mean that all the facilities within the historic district will automatically fall under the federal laws applying to the preservation and documentation of historic

buildings. My project, which includes research of some of the buildings within this potential historic district, will impact how smooth the transition to historic status will be.

Bob Arrighi and I started off by researching and documenting the history of Building 4, the Flight Research Building (also known as the Hangar). We have taken an inventory of the photos and drawings that have been stored in the Hangar's records room. Then, we interviewed the Chief of Aircraft Operations, William Rieke, to get a sense of the significant projects and accomplishments that had occurred at the Hangar. I have also reviewed flight log books going back as far as 1943 and documenting historic material. Soon, Bob Arrighi, Anne Burke, and I will begin setting up oral interviews with retirees who worked at the Hangar. From these interviews, we will attain a complete and accurate record of the many projects that went on at the Hangar.

Other buildings at Glenn which are scheduled to be documented as part of this project include the Altitude Wind Tunnel, the Zero Gravity Research Facility, Buildings 24 and 16, and Propulsion Systems Labs 1 & 2. Bob Arrighi, Anne Burke, and I will soon begin researching the historic sites and landmarks at Plum Brook Station. The facility at Plum Brook that will be the focus of our research is the Spacecraft Propulsion Facility (B-2). B-2 is the only National Historic Landmark located at Plum Brook Station. Although it is doubtful all of these facilities will be documented before my summer internship ends, these projects will be continued by the History Office after I am gone.

Second, I am also working with Bob Arrighi and Anne Burke on a project to inventory and organize the records of Plum Brook Station. Currently, the files in Plum Brook's engineering building are unorganized. This can have serious consequences, as important records cannot always be readily accessed by researchers, NASA officials, or historians. Our job is to organize Plum Brook's files according to facility and project, put them into a logical finding system, and create a sign-out procedure for people who wish to view the records. The records will then be appropriately stored in climate-controlled rooms in order to preserve their integrity. This endeavor will require us to make weekly trips to Plum Brook. Galen Wilson of the National Archives and Records Administration will be assisting us in the project by helping to identify historically significant records among the general facility and project records.

Third, I am assisting the Glenn Records Management Office in completing its inventory of records that are stored in the bunkers at Plum Brook Station. Over the course of this summer (and the past two summers), I have worked with Suzanne Kelley and Debbie Demaline of InDyne, Inc. to complete this inventory. As there are many bunkers at Plum Brook – each of which contains thousands of boxes of files – this is a huge undertaking. This inventory is important because it will ensure the integrity of Glenn's record-keeping process. We checked to make sure that all boxes that are listed as being in a specific location at Plum Brook are in their proper storage locations. In addition to being important so that records are easily retrievable, this inventory may also have great significance in the near future as Glenn looks at moving its records from Plum Brook to another location.

Another item of interest that did not comprise a huge amount of my time this summer – yet was still significant – was my mentor's coordination of the June 9 premiere/award ceremony for the book Taming Liquid Hydrogen: The Centaur Upper-Stage Rocket 1958-2002 by Dr. Virginia Dawson and Dr. Mark Bowles. My role in the logistics of the ceremony was small, and included helping with the decorations and with



people who required assistance in the parking lot. However, after the ceremony was over, I was presented with a special award from the History Office at NASA Headquarters for my work last summer on my research of NASA's historic sites and landmarks. The award was totally unexpected, but I was happy that I had been a small part of the extraordinary NASA History Office team that is working to preserve the history of America's space program.

In conclusion, my projects this summer will be significant to the History Office and the Records Management Office in the long term. The documentation of historic buildings – and in light of the potential historic district at Glenn – is important so that NASA can stay up to date with its historic preservation obligations. The project to organize Plum Brook's records will ensure that the records will be readily accessible. Also, the inventory of Glenn's records at Plum Brook will ensure the reliability of Glenn's record storage procedures. For all these reasons, I consider this summer at NASA Glenn to have been very productive.

EDUCATION, TECHNOLOGY, AND MEDIA:  
A PEAK INTO MY SUMMER INTERNSHIP AT  
NASA GLENN RESEARCH CENTER  
IN CLEVELAND, OHIO

Giovanna E. Mignosa  
2004 NASA's Abstract

Mentor: Susan F. Gott

Senior at Ohio University, Athens, Ohio  
Major: Video Production & French  
Minor: Art & TEFL Certificate  
(Teaching English as a Foreign or Second Language)

Presented on: August 20th, 2004

“Ad aspra per aspera” derives from Latin and it translates “to the stars through difficult places.” When I was little I used to dream of reaching the stars, “of running away to sea, of curing cancer, of playing for the Pirates, of painting in Paris, of tramping through the Himalayas” (Dancing School by Annie Dillard). I always wanted to explore space and to be on a mission out of the Earth. I didn’t get to fly into space on the shuttle, but I have had the opportunity to participate in the Lewis Educational and Research Collaborative Internship Program (LERCIP) through the Ohio Aerospace Institute (OAI) and the Educational Programs Office (EPO) at NASA John H. Glenn Research Center (GRC) at Lewis Field in Cleveland, Ohio.

Many were the reasons for me wanting to participate in the LERCIP College Program such as continued development of my professional abilities, and the fact that the employees at NASA GRC treat me like a family member. I have come to NASA not knowing exactly what is that I wanted to do with my life, but through the years NASA has helped me to discover areas of interest to me. I am still in the process of figuring out more about myself, but I believe that I am on my chosen path thanks to my successful college (academic and personal success) and NASA.

For the last three years (2002-2004) I have worked in the Educational Programs Office (EPO) as the assistant of the LERCIP Program Manager, Susan F. Gott. While working in the EPO I have provided webcast support (December 17th, 2003), for a NASA webcast and videoconference entitled “12 Seconds that Changed the World.” In 2003 one of my duties involved working with a group of students, organizing, coordinating and preparing a NASA GRC Educational Video for the Annual Student/Mentor Recognition Banquet. I contributed for NASA GRC in helping out at the Cleveland 2003 Air Show, as well as in the NASA GRC 2002, 2003 and 2004 Annual Honor Awards Ceremony.

This summer I have had the honor to represent NASA GRC at the first ever International Children’s Games hosted in the USA, downtown Cleveland sponsoring some of the educational programs both for students and teachers, as well as the visitor center and NASA’s upcoming events for the year. I provided assistance to my mentor in compiling program reports; I interacted with mentors to follow-up on tracking and student evaluation forms. I coordinated various cultural and educational events such as the Annual Student/Mentor Recognition Banquet, Picnic, tours, conferences, etc., and I assisted the Program Manager in daily routines.

My internship this summer as the assistant of the LERCIP Program Manager involved some of the following:

- 1) organizing/planning activities, such as the Research Symposium I and II (college participants present the research they have been working on to NASA employees),
- 2) attending staff, program meetings,
- 3) drafting communication to staff, interns, and customers,
- 4) participating in videoconferences and webcasts,
- 5) compiling, gathering, and creating charts,
- 6) serving as a liason to the program manager/my mentor with students and mentors.

I loved what I did because I was treated not only as a staff member, but a valued part of the team. I was encouraged to participate in activites, provide input, and listened

**James Moon**  
**Senior**  
**Tennessee State University**  
**Aeronautical and Industrial Technology**

My name is James Moon and I am a senior at Tennessee State University where my major is Aeronautical and Industrial Technology with a concentration in industrial electronics. I am currently serving my internship in the Engineering and Technical Services Directorate at the Glenn Research Center (GRC). The Engineering and Technical Service Directorate provides the services and infrastructure for the Glenn Research Center to take research concepts to reality. They provide a full range of integrated services including engineering, advanced prototyping and testing, facility management, and information technology for NASA, industry, and academia.

Engineering and Technical Services contains the core knowledge in Information Technology (IT). This includes data systems and analysis, inter and intranet based systems design and data security. Including the design and development of embedded real-time software applications for flight and supporting ground systems, Engineering and Technical Services provide a wide range of IT services and products specific to the Glenn Research Center research and engineering community.

In the 7000 Directorate I work directly in the 7611 organization. This organization is known as the Aviation Environments Technical Branch. My mentor is Vincent Satterwhite who is also the Branch Chief of the Aviation Environments Technical Branch. In this branch, I serve as the Assistant program manager of the Engineering Technology Program.

The Engineering Technology Program (ETP) is one of three components of the High School L.E.R.C.I.P. This is an Agency-sponsored, eight-week research-based apprenticeship program designed to attract traditionally underrepresented high school students that demonstrate an aptitude for and interest in mathematics, science, engineering, and technology. This program

offers hands-on work experience to develop practical and theoretical knowledge, skills, and abilities in Electrical, Electronic, and Mechanical Engineering Technology. Program activities include a design project, fabrication, classroom instruction, oral presentations, and a variety of enrichment activities, such as career counseling and facility tours under the careful supervision of the High School L.E.R.C.I.P. staff.

As the Assistant Program Manager, I am responsible for managing 11 Engineering Technology Students across GRC. Inherent in my responsibilities is to communicate with management, engineering, and the technician workforce to develop student work assignments in the areas of electrical, electronic, and mechanical engineering technology. I also provided resume training, cover letter development, and the interviewing skills techniques.

I am responsible for the ordering of materials and accessories for the ETP which include: Robots, Boe-Bots, Sumo Bots, 130-in-1 labs, and soldering kits and tool kits. I coordinate weekly meetings in which the students of ETP and I analyze resumes and cover letters. We also run practice presentations to prepare each student for their final presentation in August. I am also responsible for ensuring computer access of each student prior to arrival. I participated in the Professional Development workshop. I also performed follow-up sessions with the students of the High School L.E.R.C.I.P.

My assignments have been very beneficial. I am gaining great experience in both management and education. These assignments have turned me into a more responsible and dedicated employee. I am self-starting, self-motivated, and very team oriented. I have developed professional work beliefs which are punctuality, timeliness, efficiency, and a respect for others. I am confident that where ever I shall go I will demonstrate a strong commitment to excellence in producing quality goods, services, and most importantly customer satisfaction.

Drinking Water Database  
ShaTerea R. Murray  
Graduate Student  
University of Alabama of Birmingham  
Mentor: Danielle M. Griffin

This summer I had the opportunity to work in the Environmental Management Office (EMO) under the Chemical Sampling and Analysis Team or CS&AT. This team's mission is to support Glenn Research Center (GRC) and EMO by providing chemical sampling and analysis services and expert consulting. Services include sampling and chemical analysis of water, soil, fuels, oils, paint, insulation materials, etc. One of this team's major projects is the Drinking Water Project. This is a project that is done on Glenn's water coolers and ten percent of its sink every two years.

For the past two summers an intern had been putting together a database for this team to record the test they had perform. She had successfully created a database but hadn't worked out all the quirks. So this summer William Wilder (an intern from Cleveland State University) and I worked together to perfect her database. We began be finding out exactly what every member of the team thought about the database and what they would change if any. After collecting this data we both had to take some courses in Microsoft Access in order to fix the problems. Next we began looking at what exactly how the database worked from the outside inward. Then we began trying to change the database but we quickly found out that this would be virtually impossible.

Which lead to the beginning of our own version of the database. William's strong background in computers automatically made him the leader in the computer program

aspects of the database, thus leaving me the input aspect of the database. Will would create and design different forms, tables, and reports that were needed for the database. In turn I would input the data into the database. Finally we allowed the analysis to critique the database for operational problems and clarity. We were able to finish a great amount of the database yet there are still some quirks that need to be worked out.

## Design of an EXB Probe

### Introduction

Current chemical propulsion technology cannot address the needs of some deep space missions. The amount of chemical propellant required to accomplish certain NASA's planned missions is too immense such that the spacecraft will never be able to lift off. To address this concern, electric propulsion systems have been chosen as the primary propulsion systems for some NASA's future missions, including DAWN and JIMO.

The HiPEP (High Power Electric Propulsion) engine being developed at NASA Glenn Research Center is a proposed engine for the JIMO mission, which will visit three of Jupiter's icy moons. Optimizing thruster's lifetime and efficiency are the two foci for the engineers on the Ion Team. One qualitative study of the engine's efficiency can be accomplished by examining the ratio of doubly- to singly-charged ions in the ion beam of the engine. Thrust efficiency directly relates to this ratio. The bulk of this project is to redesign and build an EXB probe to obtain this qualitative measurement. Once this probe is built, it can be installed in a vacuum tank (VF 65 in building 301) behind the exit plane of the HiPEP engine to collect data.

### Background on Ion Thruster

In order to understand the usefulness of an ExB probe, one must understand how an ion thruster works. Figure 1a shows an ion thruster built at NASA Glenn and Figure 1b below shows a schematic of an ion thruster.

Some of the main features of an ion thruster include the hollow cathode, discharge chamber, grids, and the neutralizer. Gas such as Xenon or Argon is injected into the discharge chamber. The electrons produced by the hollow cathode bombard with the neutral gas atoms, ionizing the gas in the chamber into plasma. In this plasma, two species of electrons and ions coexist. At the end of the discharge chamber is a screen grid and accelerating grid, which are at a very low potential. The ions accelerate towards the grids and create an ion beam at the exit plane of the engine, thus thrust is obtained.

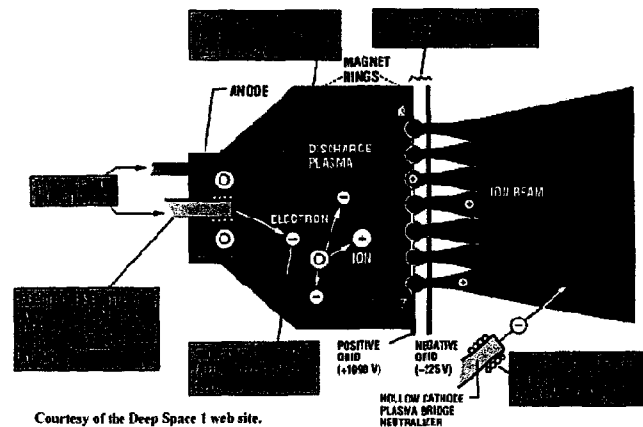
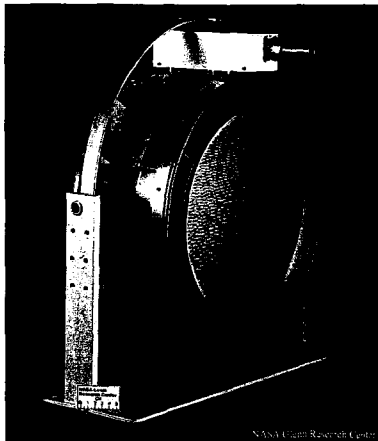

Courtesy of the Deep Space 1 web site.

Figure 1 (a) Ion engine built at NASA GRC (b) Schematic of ion engine. Courtesy of NASA-GRC



## ExB Probe Theory

The ExB probe is one application of the Lorentz force. When a particle is in both an electric field and a magnetic field, it experiences a force known as Lorentz force,

$$F = eq(E + uXB) \quad \text{Equation 1}$$

where  $F$  is the force  
 $E$  is the electric field  
 $u$  is the velocity of the particles  
 $B$  is the magnetic field  
 $e$  is charge of an electron  
 $q$  is the charge.

This relationship implies that a particle with a certain velocity in a magnetic field will deflect in a direction perpendicular to both. An electric field can be applied such that it can re-deflect the particle back to its original path. Alternately, the electric and magnetic fields can be adjusted in an ExB probe such that the particles entering the collimator must stay in a predicted manner, un-deflected from its original path. Figure 2 below is a schematic of the ExB probe.

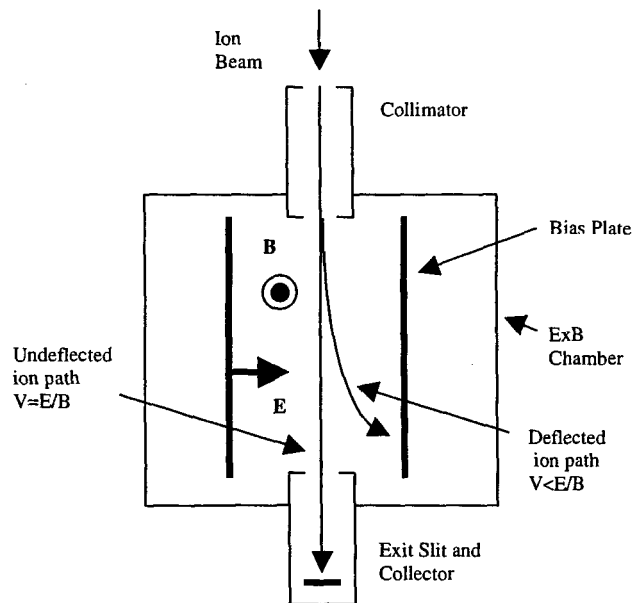

**Figure 2. ExB Probe.** Courtesy of Aaron Snyder, NASA-GRC

The main components of an ExB probe are the collimator, electrodes, magnets, and the collector. An electric field is obtained when a bias voltage is applied to the two electrodes. The main function of the collimator is to focus the beam of the ion and the collector's function is to measure the current of ions which have not been deflected.

By varying the bias voltage, thus electric field, the ion currents can be measured from the collector. Plot such as the one in Figure 4 can be obtained from the ExB probe. It is a curve of relative ion currents versus the bias plate potential. Typically, two peaks appear on the graph

and it is known that the first peak is from low energy ions and the second peak is from high energy ions based on the relation in Equation 1.

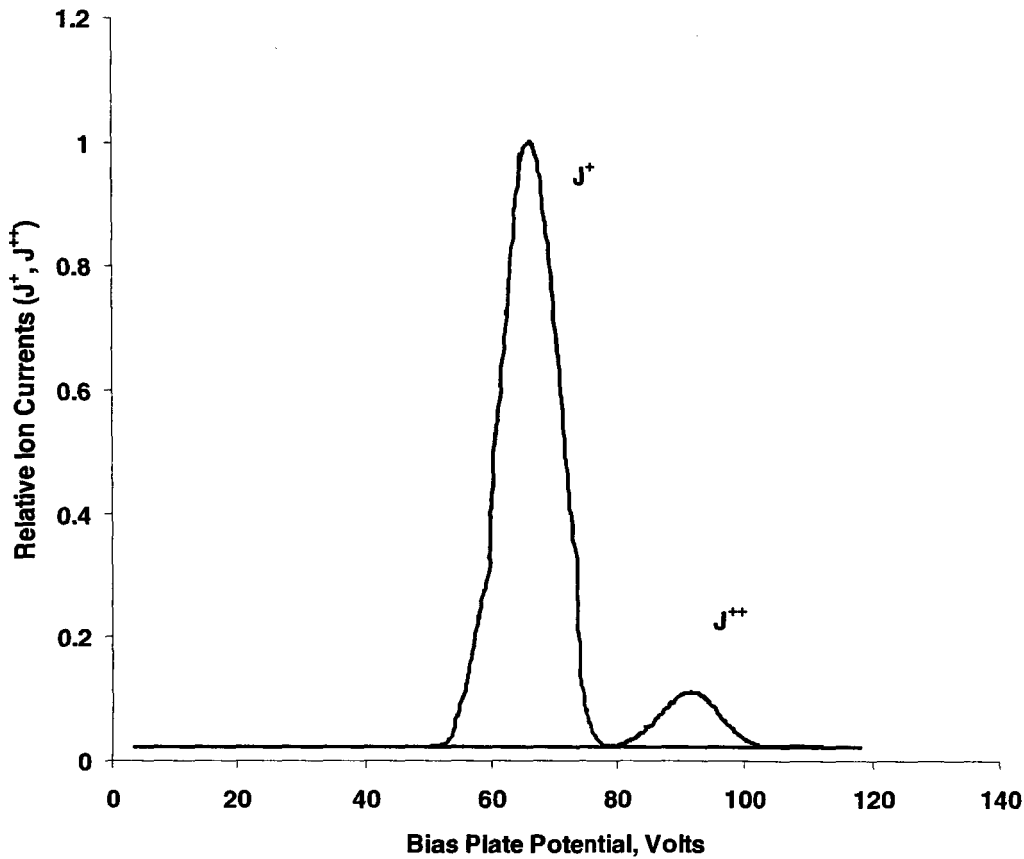

Figure 4. An example of a data collected from an ExB probe. Courtesy of Aaron Snyder, NASA GRC

### Design Considerations

For the particles to remain on its original path, the net force exerted on it must be zero. Thus, the main design is based on this relationship:

$$E=uB$$

A few key parameters were being considered before the design of the probe including the magnetic field strength, the electric field, and the distance between the electrodes. The magnetic field strength of 0.09 Tesla is obtained from an available set of magnets. With 0.09 Tesla and a given ion energy of 6700 eV, the required range of electric field is 400-500V, and this is for a gap of 2 cm. The magnitude of the electric field and the distance between the electrodes are directly related. It is desirable to separate the electrodes at 2 cm because the electric field required is within the range of the available power supplies.

## Design

The design work was done through SolidEdge. Following are some pictures illustrating the design. I have made several modifications to the existing probe to ensure proper alignment and short circuiting of the electrodes.

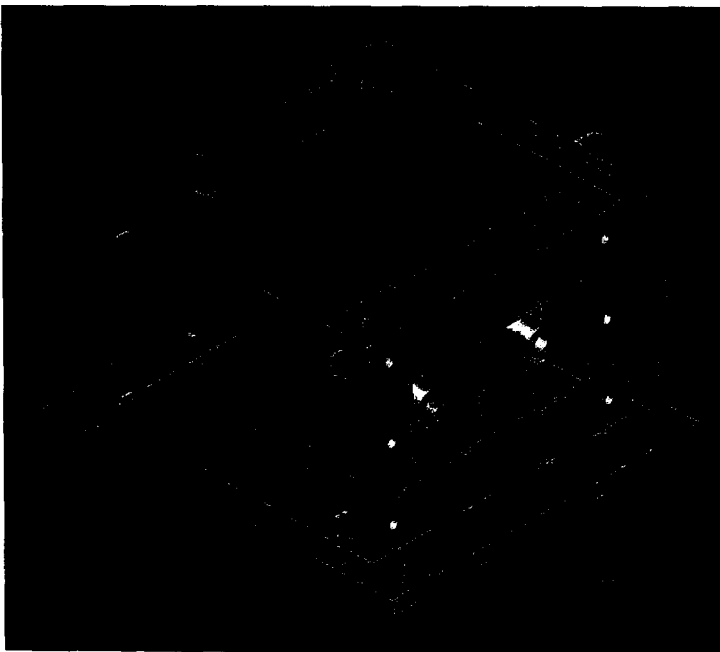

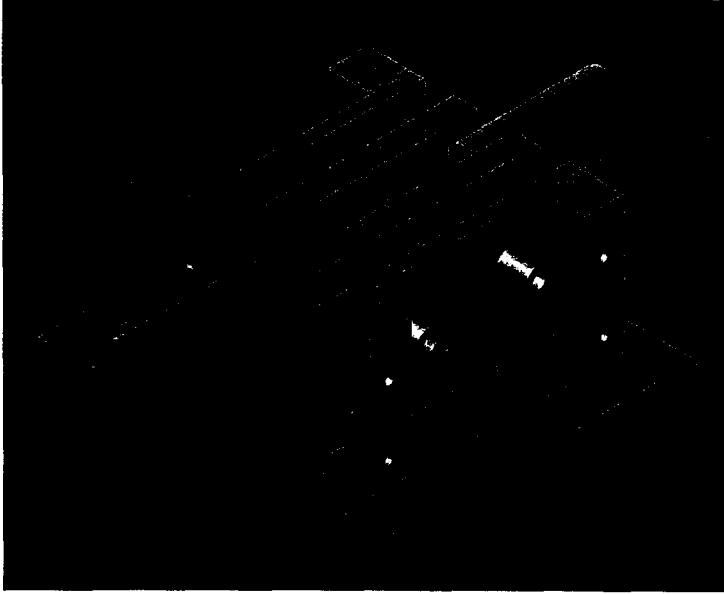

### **Conclusions**

I have modified the existing ExB probe, which will be used as part of the diagnostic tools for HiPEP engine testing. The parts are currently being machined while I am setting up the test experiment using LabVIEW. Data to be obtained from this probe will be able to qualitatively characterize the thrust efficiency of the HiPEP engine.

# TEXTURING CARBON-CARBON COMPOSITE RADIATOR SURFACES UTILIZING ATOMIC OXYGEN

**Taylor Raack**  
Northwestern University  
Integrated Science / Computing and Information Systems  
Undergraduate Senior  
**Mentor: Donald A. Jaworske**

Future space nuclear power systems will require radiator technology to dissipate excess heat created by a nuclear reactor. Large radiator fins with circulating coolant are in development for this purpose and an investigation of how to make them most efficient is underway. Maximizing the surface area while minimizing the mass of such radiator fins is critical for obtaining the highest efficiency in dissipating heat. Processes to develop surface roughness are under investigation to maximize the effective surface area of a radiator fin.

Surface roughness is created through several methods including oxidation and texturing. The effects of atomic oxygen impingement on carbon-carbon surfaces are currently being investigated for texturing a radiator surface. Early studies of atomic oxygen impingement in low Earth orbit indicate significant texturing due to ram atomic oxygen. The surface morphology of the affected surfaces shows many microscopic cones and valleys which have been experimentally shown to increase radiation emittance. Further study of this morphology proceeded in the Long Duration Exposure Facility (LDEF). Atomic oxygen experiments on the LDEF successfully duplicated the results obtained from materials in spaceflight by subjecting samples to 4.5 eV atomic oxygen from a fixed ram angle. These experiments replicated the conical valley morphology that was seen on samples subjected to low Earth orbit.

Previous Monte Carlo computer simulations of atomic oxygen impingement on such surfaces predict the conical morphology of experimentally derived surfaces. A particular two-dimensional computer model developed at NASA Glenn simulates the arrival of atomic oxygen onto a polymer substrate through a defect zone in a protective coating. This model is analogous to a Kapton substrate covered by a glass-fiber matrix with microscopic defect zones. The model is completely adjustable to simulate any kind of substrate geometry, physical behavior, and atomic oxygen impingement characteristics that the operator desires. Arrival of atomic oxygen can be from a fixed ram angle, isotropic to simulate an oxygen plasma environment, or sweeping to simulate arrival on a solar oriented surface. Energies of the incoming atoms can be selected to match low Earth orbit conditions, any other fixed energy, or energy based on a Maxwellian distribution for thermospheric atoms with respect to the orbital velocity and angular inclination. Impingement surface characteristics allow the modeler to change the reactivity and recombination probabilities for atomic oxygen on that particular surface, be it polymer or protective coating.

Modeling parameters that lead to simulated surface textures obtained experimentally in the LDEF were identified when the Monte Carlo simulator was first used. Optimal values for these parameters were obtained and simulations using these values continue to agree with the surface morphology obtained experimentally on the LDEF. Simulations show that impingement on a flat surface with fixed angle arrival of atomic oxygen increases surface roughness continuously during impingement but at a decreasing rate (non-linear.) Isotropic impingement leads to a negligible surface roughness due to the breakdown of tall cones by atomic oxygen arriving from all angles.

The model is currently being updated with a statistics package to analyze the morphology of the surface during its growth. Measurements of the cones on the eroded

surface allow the operator to identify an "aspect ratio" for the cones, which may be a good indicator of surface roughness. The cone statistics algorithm looks for cones across the entire surface of the erosion area and attempts to identify cones that have a similar aspect ratio and overall size, since experimentally the overall size of the cones and valleys of a particular morphology are relatively constant at any given time. The total surface area of the eroded polymer is also calculated. These statistics are then graphed and can be visualized immediately following the simulation, or saved for later use. Another addition to the model includes an automation feature to allow the operator to input parameters for many different simulations and let them proceed without operator intervention. Through the cone analysis and automation package developed it is hoped to identify which parameters in the model to adjust to increase and decrease cone aspect ratio, surface roughness, and surface area.

Experimental study of carbon-carbon surface texturing is continuing through operation of an end Hall thruster to impinge atomic oxygen on carbon-carbon composites. By varying the operational parameters, it is hoped that a procedure for texturing surfaces optimal for radiators can be achieved. While the Monte Carlo simulation allows for variation in many different parameters for atomic oxygen introduction, surface characteristics, and atom / surface interactions, the variables most likely to be of parametric importance are initial atomic oxygen energy and impingement time. The Monte Carlo model will be used to mimic the workings of the end Hall thruster and allow researchers to determine how best to operate it to achieve maximum surface roughness. Through computer modeling and experiment the goal is to find an optimum surface roughness for heat dissipation in future space power systems.

GEOGRAPHIC INFORMATION SYSTEMS &  
WEB PAGE DEVELOPMENT

Justin Reynolds

Mentors: Ronald Zurawski & Karl Hagelin

The Facilities Engineering and Architectural Branch is responsible for the design and maintenance of buildings, laboratories, and civil structures. In order to improve efficiency and quality, the FEAB has dedicated itself to establishing a data infrastructure based on Geographic Information Systems, GIS. The value of GIS was explained in an article dating back to 1980 entitled "Need for a Multipurpose Cadastre" which stated,

*"There is a critical need for a better land-information system in the United States to improve land-conveyance procedures, furnish a basis for equitable taxation, and provide much-needed information for resource management and environmental planning."*

Scientists and engineers both point to GIS as the solution. What is GIS? According to most text books, Geographic Information Systems is a class of software that stores, manages, and analyzes mapable features on, above, or below the surface of the earth. GIS software is basically database management software to the management of spatial data and information. Simply put, Geographic Information Systems manage, analyze, chart, graph, and map spatial information.

GIS can be broken down into two main categories, urban GIS and natural resource GIS. Further still, natural resource GIS can be broken down into six sub-categories, agriculture, forestry, wildlife, catchment management, archaeology, and geology/mining.

Agriculture GIS has several applications, such as agricultural capability analysis, land conservation, market analysis, or whole farming planning.

Forestry GIS can be used for timber assessment and management, harvest scheduling and planning, environmental impact assessment, and pest management.

GIS when used in wildlife applications enables the user to assess and manage habitats, identify and track endangered and rare species, and monitor impact assessment.



GIS can be used in catchment management operations also. It can display runoff and erosion modeling. It can aid in sedimentation and water quality studies and can help to evaluate alternative management methods.

GIS can even be beneficial in archaeology, helping to facilitate the mapping and prediction of prehistoric sites, establish site vandalism studies, and create site management studies.

Another way that Geographic Information Systems can be utilized is through the field of geology and mining. It can aid in oil, gas, and minerals exploration. It can also be activated for the purposes of geologic mapping and terrain analysis, open pit mine design and redamation, and geologic hazard mapping.

However, at NASA Glenn, Urban GIS is primarily used. But what are its applications? Urban GIS applications include the provision of utilities, management of storm water, location and allocation of critical resources such as hospitals, schools or fire stations, study of disease outbreak patterns, crime analysis, waste collection routing or hazardous waste transportation. An urban geographic information system must be capable of processing a variety of attribute information from many different sources in order to satisfy the data needs of the service delivery, management, and policy levels of government. My project, using GIS, involved underground management.

What are the advantages of GIS? Computerized information allows improvement in the efficiency of the process as well as improvement in the effectiveness of the organization as long as the computer is able to produce and process the needed information. Thus, by improving both efficiency and effectiveness, computer processing technology continues to add value to the computerized and stored information.

Another reason why computerized information is so valuable is because it can be shared with other functions within an organization if it is properly stored within a server, mainframe, or centralized computer system.

At the outset, I was given goals and expectations from my branch and from my mentor with regards to the further implementation of GIS. Those goals are as follows: (1) Continue the development of GIS for the underground structures. (2) Extract and export annotated data from

AutoCAD drawing files and construct a database (to serve as a prototype for future work). (3)  
Examine existing underground record drawings to determine existing and non-existing underground tanks. Once this data was collected and analyzed, I set out on the task of creating a user-friendly database that could be assessed by all members of the branch. It was important that the database be built using programs that most employees already possess, ruling out most AutoCAD-based viewers. Therefore, I set out to create an Access database that translated onto the web using Internet Explorer as the foundation. After some programming, it was possible to view AutoCAD files and other GIS-related applications on Internet Explorer, while providing the user with a variety of editing commands and setting options.

I was also given the task of launching a divisional website using Macromedia Flash and other web-development programs.

In addition I had the privilege of working on various intern committees, including serving as a layout-editor for the LERCIP Newsletter. All of these experiences have added to the enjoyment of my work and have provided me with a solid foundation on which to build my future professional career.

Brandi Robinson  
Susan F. Gott  
LERCIP  
July 9, 2004

#### N.A.S.A. Project 2004 Assignment for Internship

This summer I have been working with the N.A.S.A. Project at Cuyahoga Community College (Tri-C) under the title of Exploring Aeronautics Project Leader. The class that I have worked with is comprised of students that will enter the eighth grade in the fall of 2004. The program primarily focuses upon math proficiency and individualized class projects. My duties have encompassed both realms.

During the first 2-3 weeks of my internship, I worked at NASA Glenn Research Center (GRC) researching, organizing, and compiling information for weekly Scholastic Challenges and the Super Scholastic Challenge. I was able to complete an overview of Scholastic Challenge and staff responsibilities regarding the competition; a proposal for an interactive learning system, Quizdom; a schedule for challenge equipment, as well as a schedule listing submission deadlines for the staff.

Also included in my tasks, during these first 2-3 weeks, were assisting Tammy Allen and Candice Thomas with the student application review and interview processes for student applicants. For the student and parent orientation, I was assigned publications and other varying tasks to complete before the start of the program.

Upon the commencement of the program, I changed location from NASA GRC to Tri-C Metro Campus, where student classes for the Cleveland site are held. During the duration of the program, I work with the instructor for the Exploring Aeronautics class, kkkk, assisting in classroom management, daily attendance, curriculum, project building, and other tasks as needed. These tasks include the conducting of the weekly competition, known as Scholastic Challenge.

As a Project Leader, I am also responsible for one subject area of the Scholastic Challenge aspect of the N.A.S.A. Project curriculum. Each week I have to prepare a mission that the participants will take home the following Monday and at least 10 questions that will be included in the pool of questions used for the Scholastic Challenge competition on Thursdays. For at least one of these competitions, I must compile all mission and question information submitted by the staff, distribute missions to the students, and enter questions into Jeopardy formatted PowerPoint presentation.

Unique the N.A.S.A. Project are its Saturday sessions and opportunities for field trips. As a Project Leader, I am required to attend all field trips and Saturday sessions held for participants and their parent(s)/guardian(s). The Saturday sessions do not require my assistance because they are facilitated by a contracting company, Imhotep. This leaves my duties to observation unless instructed otherwise.

## 2D ANALYSIS OF IN-FLIGHT PARTICLES

Jonathan Shearer  
Purdue University  
Icing Branch, 5840

One of the primary uses of the in-flight icing research performed aboard NASA Glenn's DHC-6 Twin Otter is for Icing Research Tunnel (IRT) and icing prediction code (Lewice) validation. Using the in-flight data to establish the IRT and Lewice as accurate simulators of actual icing conditions is crucial for supporting the research done in the Icing Branch. During test flights during the 2003 and 2004 flight season, a Natural Ice Shape Database was collected. For flights where conditions were appropriate, the aircraft is flown in an icing cloud with all ice protection systems deactivated. The duration of this period is usually determined by the pilot's ability to safely control the aircraft. When safe flight is no longer possible, the aircraft is maneuvered into clear air above the cloud layer. At this point several photographs are taken of the ice shape that was accreted on the wing test section during this icing encounter using a stereo photograph system (Figure 1). The stereo photograph system utilizes two cameras located at different locations on the fuselage that are both pointed at the same location on the wing. When both cameras take photographs of the same location at the same time, the negatives can be combined digitally to generate a two dimensional plot describing the cross-section of the ice shape. After these photographs are taken, the wing de-icing boots are activated and the ice shape is removed.

In addition to the stereo photographs documenting the ice shape, many different channels of data are recorded by the aircrafts data acquisition system. Many probes and sensors record airspeed, temperature, ice presence, liquid water content, and droplet size. During post-flight data processing, the start and end times each icing encounter are identified from the flight notes. At this point, the pertinent data collected during the icing encounter can be used to generate the necessary settings for re-creating this flight using the IRT or Lewice. In the IRT, an actual Twin Otter wing section will be used with the determined conditions to accrete an ice shape which should be similar in shape to the in-flight shape documented by the stereo photographs. The accuracy and likelihood for

success of these wind tunnel tests relies heavily on the accuracy of the input data. If the data acquired in-flight is not processed correctly, these input conditions will not produce a duplicate ice shape.

Temperature, airspeed, liquid water content, and drop size are all critical inputs for any IRT test. Each of these parameters is collected by probes on the aircraft, and can be analyzed after the normal post-flight processing. Droplet size, however, is especially important for ice cloud simulation, and requires extra post-flight analysis to correctly report. Nearly all meteorological testing agencies in the United States and elsewhere use Particle Measuring System (PMS) probes to acquire the size of cloud droplets. The Twin Otter primarily uses two PMS probes drop size acquisition. For sensing drops between roughly 0-50 microns, a Forward Scattering Spectrometer Probe (FSSP) is used (Figure 2). This probe measures drop diameter from the forward scattering of laser light by the droplets passing through the probe. Larger drops, up to over a millimeter in diameter, require a different type of probe called a PMS Optical Array Probe (OAP) 2D-C Grey (Figure 3). This probe finds drop size using an array of diodes that are shadowed when droplets interrupt a laser beam exposed to the cloud. When it is determined by the flight test researchers that drops greater than 50 microns were present during an icing encounter, analysis of the 2D data from the 2D-C Grey is necessary to accurately determine the average drop size in the cloud.

This analysis process was one of my multiple tasks during this summer work session. While the data collected by the FSSP probe directly reports a distribution of drop sizes present in a cloud, the 2D Grey instead stores thousands of two-dimensional images recorded during flight. When a particle passes through the laser beam and shadows the diodes, the 2D image is presented real-time to the flight researchers, and stored for later 2D analysis. This processing requires specially authored software to interpret the 2D images and convert them into a distribution of drop sizes. Although the software is capable of analyzing the images in an automated fashion, the errors associated with such processing are very undesirable. It is important to remember that the probe records images of all particles passing through the air, and not just water droplets. Ice plates, rods, and snowflakes are all common particles that skew the droplet distribution if processed automatically due to the inability of the software to distinguish between them

and droplets. These particles do not pose a problem for the FSSP probe because in general they are much greater in size than 50 microns. In order to minimize the error for these cases, the software must be used interactively with human judgment to discern between particle types.

Each icing encounter is analyzed in one minute increments, and the distribution of drop sizes over that period is averaged to report one Median Volumetric Diameter (MVD) representing that minute. The software can be configured to aid in the interactive process by eliminating some particles automatically (Figure 4). Different calculations are made on each 2D image to determine how close to circular it is, as well as how focused. Some particles are automatically filtered by cut-offs input for these parameters. Before any particle is accepted and added to the distribution, the user is asked to verify that it is in fact a water droplet (Figure 5). Depending on probe resolution, there is still a certain amount of error in the user judgment of particles. After all particles for a particular minute increment are counted, an output file is written for later use.

Because the FSSP and 2D Grey have a certain amount of overlap in their effective size ranges, the newly processed 2D data must be blended with the FSSP to generate a representative MVD for the entire droplet spectra. A complicated series of formulas is used in Microsoft Excel to accomplish this task. Since FSSP MVD is recorded every second, a block of sixty seconds must be combined for use with the 2D data. Both probes count the number of droplets and sort them according to size in different bins. An imaginary bin is interpolated between the size ranges of each probe, with the bins closest to this interpolated bin being discarded. With the droplet distribution of each probe effectively blended together, the spectra MVD value can be reported for the one minute segment. When all one minute periods in a specific icing encounter are processed, the conditions are now ready for IRT testing.

Accurate droplet size is essential for re-creating the in-flight ice shape and validating the IRT testing conditions. Drop size has an enormous impact on the shape and size of accreted ice shapes, and ignoring drops larger than 50 microns would certainly cause differences to arise between ice shapes. With the properly processed spectra MVD data, valuable IRT testing time will not be wasted. The conditions input into the tunnel will be an accurate representation of in-flight icing.

## APPENDIX

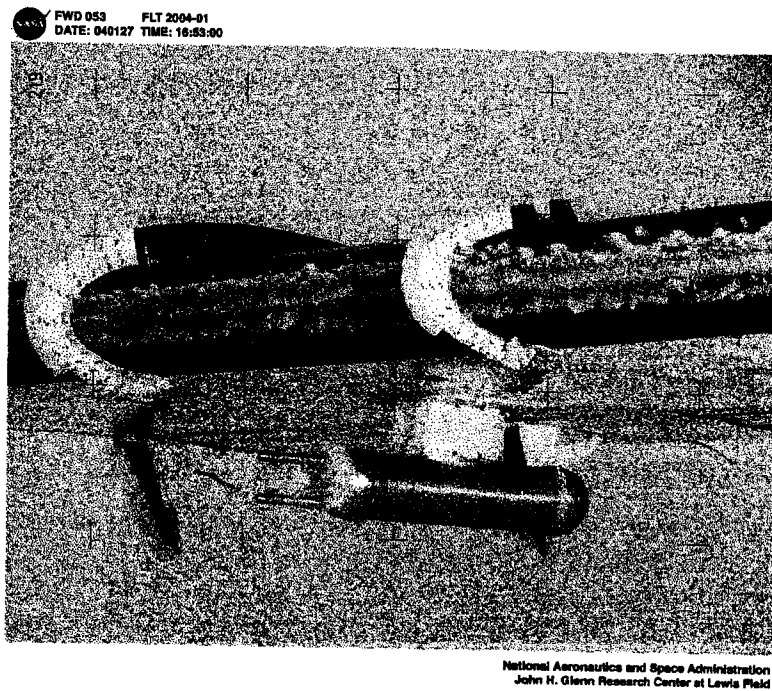

Figure 1: Stereo photograph of wing test section



Figure 2: FSSP Probe mounted on wing hardpoint



Figure 3: 2D Grey probe mounted on wing hardpoint

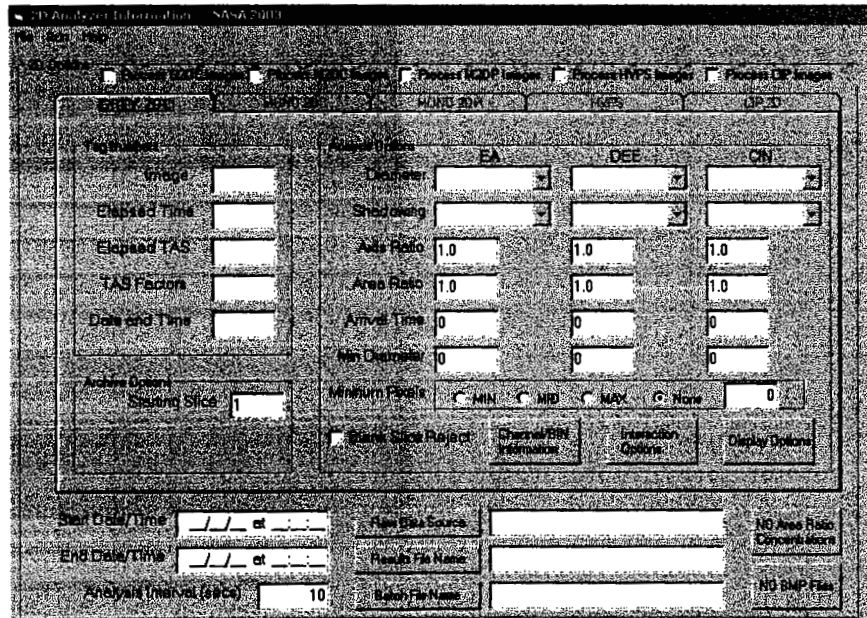

Figure 4: 2D Analyzer configuration screen



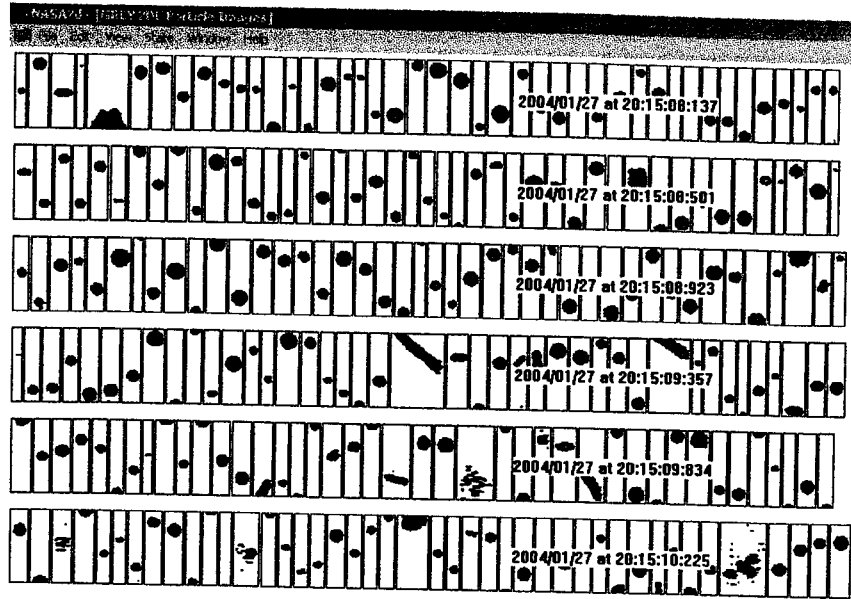

Figure 5: 2D particle images

# Working at the Ohio Aerospace Institute

*Hortenzia Szabo*  
Baldwin Wallace College  
Undergraduate, Freshman

**Mentor:** Mary E. Auzenne

## Abstract

The Ohio Aerospace Institute is a wonderful place to work. I enjoy coming to work everyday knowing that I will be surrounded by smiling faces. My mentor, Mary Auzenne, is the Program Manager of the LERCIP College Internship Program, however, I spend most of my time working with Akua Soadwa, the Assistant Program Manager. She is in charge of planning, coordinating, and managing every event that is involved with the college internship program such as the socials, picnic, banquet, workshops, and research symposium. My job is to make her job easier. I help out with the planning, coordinating, and managing of these events. When I first got on board Akua was in the process of planning the second social for the interns. The social is a way for the interns to interact with one another as well as to find out more about where the other interns are working at NASA. We ordered the food, went shopping, and set up the Guerin House for the party. I made sign-in sheets, which helped us get a rough count of the attendees. The next event was the Technical Presentation Workshop and the Professional Development Workshop. These workshops are designed to enhance skills of the interns. We were there to sign people in and direct them to the room where the presentation was to take place. I also took pictures of the workshop and provided copies for the presenters, as well as our files.

The next order of events was Research Symposium I and the Picnic, which took up all of my time. As the abstracts were turned in by the students my job was to keep track of them, type the titles in the schedule, type up the evaluations, make badges, and create the evaluator's folders. I made arrangements for refreshments and helped Akua put up signs of the schedule, and signs directing the people to the designated rooms. The picnic was a lot of fun to plan. I was in charge of keeping track of the replies for the picnic and there were days when I would receive hundreds of e-mails throughout the

day, making feel very popular. I made arrangements for renting a cotton-candy machine and a frozen drink machine, I also made arrangements with the DJ, kept track of when people were volunteering for each activity, corresponded with game leaders to find volunteers, helped Akua buy decorations, took pictures, and caught thieves trying to steal frozen drinks. The weather was not the best and it started raining towards the end, but I never had so much fun getting drenched!

The next event was the banquet. I did not have a lot of responsibilities with this event. I would like to however, give myself credit for coming up with the color combination: red and gold. I helped buy decorations and ordered the balloons. I picked up the balloons, took pictures, and worked the registration table. I would also like to give myself credit for getting a backdrop, which gave a completely different dimension to the main cafeteria.

The final event is Research Symposium II for which I have the same responsibilities as for the first one. And while doing all of this I was also helping out with the newsletter. Another assistant program manager, Giovanna Mignosa and I were responsible for three articles each week: Meet the Staff, Meet the GRC Staff, and Quote of the Week. I took the pictures of the staff and organized it in Microsoft Word, I conducted an interview with NASA GRC's Center Director, Dr. Julian Earls, and the Deputy Director, Rich S. Christiansen, and looked for inspirational quotes online. In between all of this, I was also working on the workshop summary reports, organizing the evaluations and abstracts from the first Research Symposium, sending out the evaluations to the interns, contacting interns for their follow-up sessions, helping Akua distribute paychecks, and reading all of my e-mails and answering questions that students may have had about upcoming events, etc.

This has been a wonderful experience for me. Prior to this internship I was not a very friendly person, however, this position allowed me to meet all of the interns and this has enhanced my communication skills. I learned to work with people and in return learned to listen more, and I even became much more patient and understanding. I learned that a key to success is wanting perfection. I also learned multitasking, which is very hard if you are not used to it at first. The important thing to remember is to write everything down and to prioritize!

Now I would like to take this opportunity and thank some people without whom this internship would not have been as successful. I would like to thank Beth, Catherine, Ila, Joyce, Kelly, Dave, and Mark for making my tenure at the OAI such a wonderful experience! I would also like to thank Mary for being a great mentor, and finally, Akua, with whom I have worked most closely with and who is just really fun! Never once did she get frustrated with all of the questions that I asked her and never once did she make me feel like I was not doing a good job. Thank you Akua for making me feel special!

**The New Approach to Self-Achievement (N.A.S.A.) Project 2004**

**Candace J. Thomas**  
Hampton University  
Sociology/Psychology  
Undergraduate Senior  
**Mentor: Tammy Allen**

The New Approach to Self-Achievement Program is designed to target rising seventh, eighth, and ninth grade students who require assistance in refining their mathematical skills, science awareness and knowledge, and test taking strategies. During the six week duration of the program, students are challenged in these areas through the application of robotic and aeronautic projects which encourage the students to practically apply their mathematical and science awareness accordingly.

The first three weeks of my tenure were designated to assisting Mrs. Tammy Allen in the preparation of the 2004 NASA Project. As her assistant, I was held accountable for organizing, filing, preparing, analyzing, and completing the applications for the NASA Project. Additionally, I constructed the apposite databases which contained imperative information which aided in the selection of our participants. During the latter portion of those three weeks, Mrs. Allen, various staff members, and I, interviewed the numerous first-time applicants of the NASA Project. Furthermore, I was assigned to contact the accepted applicants of the program and provide all necessary information for the initiation of the child into the NASA Project.

During the six week duration of the program, I will be working as a Project Leader at the Lorain Middle School site located in Lorain, Oh, with Mr. Fondriest

Fountain. Mr. Fountain and I will work with the eighth and ninth grade students in constructing robots, in which the students are told are made for NASA research which is being conducted on the surface of planet Mars. The robots, which are built from LEGOS and programmed through RoboLab computer software, are prepared to complete assigned Missions such as running obstacle courses; plowing and retrieving LEGOS; and scanning surfaces for intense regions of light.

As a Project Leader, I am responsible for assisting Mr. Fountain in the classroom; preparing lessons and developing curriculum conducive to the students' comprehension level; taking attendance; providing support during field trips; and maintaining an orderly and positive learning atmosphere for the students. I also assist in preparing weekly Missions in the form of a packet, which are assembled by the Project Leaders from the Cleveland and Lorain sites, that containing age and grade level appropriate information on mathematics, science, logic, NASA and NASA Glenn Research Center facts, and test taking strategies and techniques.

Throughout the week I am responsible for introducing and tutoring this information to the students. Every Thursday, the students are tested on their retention of this information by competing in a Scholastic Challenge in the form of Jeopardy PowerPoint Presentation. Upon completion of this competition, although every student is rewarded in some way, the winning team is rewarded with NASA prizes and paraphernalia.

Mr. Fountain, the Lorain, staff and myself have worked together diligently in preparing exercises; class work; and games that will strengthen the scholastic the bases of these students. The students have been rigorously been working on fractions, decimals,

geometry, multiplication, and division during these first two weeks of the program. Fortunately, there have been numerous signs of an improvement in the students' confidence and ability to execute mathematical problems that once intimidated them. Their psychological improvements, can be partial contributed to the Saturday sessions in which the student's parent's must attend, with IMHOTEP, a contracting company that focuses on reducing test anxiety and the psychological progression of students and parents in the areas of mathematics, science and test taking skills.

The NASA Project is a new and innovative way to ensure that no is left behind within the school system. Too often, many students are overlooked and not given the proper vessels and guidance to excel and compete with students who are doing well in the same course. This program is a pledge to provide every student with an equal chance to become the astronauts, engineers, technology programmer, and mathematicians of NASA near future.

## Information Technology Support in the 8000 Directorate

**William D. Wilder**  
Cleveland State University  
Computer Engineering  
Junior  
**Eli Abumeri**

My summer internship was spent supporting various projects within the Environmental Management Office and Glenn Safety Office. Mentored by Eli Abumeri, I was trained in areas of Information Technology such as: Servers, printers, scanners, CAD systems, Web, Programming, and Database Management, ODIN (networking, computers, and phones).

I worked closely with the Chemical Sampling and Analysis Team (CSAT) to redesign a database to more efficiently manage and maintain data collected for the Drinking Water Program. This Program has been established for over fifteen years here at the Glenn Research Center. It involves the continued testing and retesting of all drinking water dispensers. The quality of the drinking water is of great importance and is determined by comparing the concentration of contaminants in the water with specifications set forth by the Environmental Protection Agency (EPA) in the Safe Drinking Water Act (SDWA) and its 1986 and 1991 amendments.

The Drinking Water Program consists of periodic testing of all drinking water fountains and sinks. Each is tested at least once every 2 years for contaminants and naturally occurring species. The EPA's protocol is to collect an initial and a 5 minute



draw from each dispenser. The 5 minute draw is what is used for the maximum contaminant level. However, the CS&AT has added a 30 second draw since most individuals do not run the water 5 minutes prior to drinking. This data is then entered into a relational Microsoft Access database. The database allows for the quick retrieval of any test(s) done on any dispenser. The data can be queried by building number, date or test type, and test results are documented in an analytical report for employees to read.

To aid with the tracking of recycled materials within the lab, my help was enlisted to create a database that could make this process less cumbersome and more efficient. The date of pickup, type of material, weight received, and unit cost per recyclable. This information could then calculate the dollar amount generated by the recycling of certain materials. This database will ultimately prove useful in determining the amounts of materials consumed by the lab and will help serve as an indicator potential overuse.

Working with the Glenn Safety Office (GSO), I created a database to track all handicap parking permits (temporary and permanent) lab-wide. Information stored in the database can be queried to check for available and expired parking locations.

Two weeks were spent in July archiving over 2000 paper documents to an electronic filing format. Each individual document was filed based on content and can be searched by key words. Also during July, the GSO underwent a modular furniture upgrade which required certain offices to be emptied. In order to maintain the efficiency of employees affected by this upgrade, network connections were rerouted to available offices and conference rooms allowing work to be continued during this time.

I created fact sheets detailing and documenting some key processes that I have been responsible for over the summer. This will allow other employees to continue using

the same practices and procedures taught to me by my mentor well after my internship is complete.

This summer has been a great experience. The staff of the EMO and GSO made sure that I felt like part of the team as my opinion was sought on numerous occasions. I was given the opportunity to work with minimal supervision and my efforts were always greatly appreciated.

# THE MORRISON BEARINGLESS SWITCHED RELUCTANCE MOTOR

**David S. Wong**

University of Michigan  
Computer Science Engineering  
Senior

**Mentor: Carlos R. Morrison**

## About the Motor:

Switched reluctance motors typically consist of pairs of poles protruding outward from a central rotor, surrounded by pairs of coils protruding inward from a stator. The pairs of coils, positioned a short distance from opposing sides of the rotor, are connected in series. A current runs through the coils, generating a magnetic flux between the coils. This attracts the protruding poles on the rotor, and just as the poles on the rotor approach the coils, the current to the coils is inverted, repelling the rotor's poles as they pass the coils. This current switching, back and forth, provides a continuous rotational torque to the rotor.

Traditional switched reluctance motors possess many positive traits, including reliability, durability, low cost, and operation in adverse environments such as high temperatures, extreme temperature variations, and high rotational speeds. However, because rotors are often manufactured with minute flaws due to imperfections in the machining process, traditional switched reluctance motors often suffer from substantial amounts of vibration. In addition, the current in the coils imparts a strong radial magnetic force on the rotor; the continuous alternating of the direction of this force also causes vibration. As a result, switched reluctance motors require bearings that, run at high speeds, can require lubrication apparatus and are subject to problems with heat and wear.

My mentor's recent invention, the "Bearingless" Switched Reluctance Motor, actually uses magnetic bearings instead of traditional physical bearings. Sensors are used to continuously determine the position of the rotor. A computer reads the position sensor input, performs calculations, and outputs a current to a set of extra coils (in addition to the coils rotating the rotor). This current provides a magnetic force that counters and damps the vibration.

The sense-calculate-update loop iterates more than thirty thousand times per second. For now, our goal is to have the rotor rotate at about 6000 rpm, and at that speed, the magnetic bearing is adjusting the rotor's position more than 300 times per rotation.

It is hoped that this new invention will increase load-carrying capacity, stiffness, and vibration-suppression capacity for the switched reluctance motor.

## **My Work:**

While my mentor's invention has been patented, it has not yet been fully, successfully implemented. I have been working closely with my mentor to help get his motor operating. In the lab, I have been providing my input on various general troubleshooting tasks.

At the beginning of the summer, our focus was on the motor alone; the magnetic bearing part of the code in the computer was deactivated entirely. After making some changes in the code and tweaking the positions of some of the sensors, along with a variety of other hardware adjustments, the motor successfully ran, but, at this point, only on mechanical bearings.

Next, we activated the magnetic bearings, and attempted to levitate the rotor between the bearings, without the motor running. For a time, this was completely unsuccessful. We delved into the code, looking for some sort of error that could be causing our problems, but no error could be found. We finally brought in a hardware analyzer, which created a simulated sensor signal that was inputted into the control system. The analyzer also accepted the output, and this was compared with the known input to determine whether the output was reasonable. We ultimately determined that our problem was something related to the hardware input. This was quickly solved. A few tweaks to the control program's settings later, and the motor was both levitated and running.

Up to this point, the motor has run, levitated, as fast as 4000 rpm. We continue to make both hardware and software adjustments in an effort to push that number higher. Also, we plan to take various measurements, including torque measurements, to help determine more clearly the full capabilities of the motor.

Additionally, throughout the summer, I have been working on converting my mentor's code and control system, written in a fairly old DOS format, to a more professional and modern dSpace/MATLAB/Simulink solution. If successful, this would likely allow substantially more robust control of both the motor and the magnetic bearings, lowering the control program's loop time by as much as two-thirds. It would also allow us to design a cleaner user interface for adjusting the control program's settings.

## **References:**

Morrison, Carlos R. 2004, *Bearingless Switched Reluctance Motor*, US Patent 6,727,618 B1.

## **Acknowledgements:**

My mentor, Carlos Morrison, has, along with various colleagues in our branch (Dexter Johnson and Gerald Brown), provided guidance and insight throughout my efforts here this summer.

# **Modification of Bushing Test Rig and Research of Variable Inlet Guide Vane Bushings For Further Development of PM304 Bushings**

Anne Yanke  
Masters Candidate  
Case Western Reserve University  
L.E.R.C.I.P. Summer 2004

PS304 is a high temperature solid lubricant coating comprised of a nickel-chrome binder, chrome oxide hardener, barium-calcium fluoride high temperature lubricant, and silver as the low temperature lubricant. This coating is used to lubricate Oil-Free Foil Air Bearings as they experience friction and wear during start up and shut down. The coating deposition process begins with undercutting the shaft. This area is then sandblasted to provide a rough surface for the coating to adhere to. The coating powder is then sent through the plasma spray gun and a reasonably thick layer is applied to the undercut area of the shaft. The coating is then ground down even with the surface of the shaft and gets a nice polished finish.

The foil air bearings use the solid lubricant, as mentioned above, during start up and shut down. During normal operating conditions, generally above 2000RPM, the bearings utilize air as their lubricant. Foil air bearings are comprised of a thin top foil and a corrugated bump foil. They have an interference fit with the shaft before operation. As the air gets "trapped" between the top foil and the shaft, it presses the top foil against the bump foil, in turn compressing the bumps. As the bumps compress, it allows for the air to separate the top foil from the shaft, therefore, utilizing the trapped air as its lubricant.

The coating has proven to sustain over 100,000 start/stop cycles at temperatures ranging from ambient to 650°C.

Since PS304 comes initially in powder form, we are able to use it for other applications as well. For example, PM304 bushings can be made from the material through conventional powder metallurgy methods. The powder is fed into the die, and is then cold pressed. Finally, the pressed piece is hydrogen sintered at 1100°C for 20 minutes.

A test rig has been developed to determine the sliding characteristics of the PM304 bushings, such as friction and wear. During the preliminary testing, it was discovered that the bushings require a break in period at high temperatures to obtain a lubricating glaze on the surface of the shaft. Without this break in period, the bushings would disintegrate not far into the test. After the break in period, the PM304 bushings, just like the PS304 coating, not only are able to withstand temperatures up to 540°C but also perform better with increasing temperature.

These bushings are currently being used in industrial furnace conveyors, and they have been working very well compared to the previously used bronze bushings. Another application the bushings should perform well in is variable inlet guide vanes (IGVs) and variable stator blades. The bushing test rig is under modification to simulate the appropriate operating conditions of variable IGVs and variable stator blades to begin testing and analysis. This will ensure the bushings are in fact capable of operating in such conditions.

The maximum temperature for the furnace being used is 1000°C, which will allow very high temperature testing to be done, potentially opening the door for use of these bushings in the hotter areas of the engine. With the modifications, the tests performed can include full rotation of the shaft at speeds up to 400RPM or an oscillatory motion up to 45°, which could be easily modified for a larger angle of rotation, if desired.

The PM304 bushing test rig modifications and the resulting data will be the focal point of my master's thesis. I will be studying the bushings under conditions similar to current variable IGV and variable stator blade conditions. My goal is to determine if the PM304 bushings are an alternative to the bushings currently in use and have the data to backup my conclusion.

## **Changes in Hardware in Order to Accommodate Compliant Foil Air Bearings of a Larger Size**

**Michelle Zeszotek  
Purdue University  
West Lafayette, Indiana**

Compliant foil air bearings are at the forefront of the Oil-Free turbomachinery revolution of supporting gas turbine engines with air lubricated hydrodynamic bearings. Foil air bearings have existed for almost fifty years, yet their commercialization has been confined to relatively small, high-speed systems characterized by low temperatures and loads, such as in air cycle machines, turbocompressors and microturbines. Recent breakthroughs in foil air bearing design and solid lubricant coating technology, have caused a resurgence of research towards applying Oil-Free technology to more demanding applications on the scale of small and mid range aircraft gas turbine engines.

In order to foster the transition of Oil-Free technology into gas turbine engines, in-house experiments need to be performed on foil air bearings to further the understanding of their complex operating principles. During my internship at NASA Glenn in the summer of 2003, a series of tests were performed to determine the internal temperature profile in a compliant bump-type foil journal air bearing operating at room temperature under various speeds and load conditions. From these tests, a temperature profile was compiled, indicating that the circumferential thermal gradients were negligible. The tests further indicated that both journal rotational speed and radial load are responsible for heat generation with speed playing a more significant role in the magnitude of the temperatures.

As a result of the findings from the tests done during the summer of 2003, it was decided that further testing would need to be done, but with a bearing of a larger diameter. The bearing diameter would now be increased from two inches to three inches. All of the currently used testing apparatus was designed specifically for a bearing that was two inches in diameter. Thus, my project for the summer of 2004 was to focus specifically on the scatter shield put around the testing rig while running the bearings. Essentially I was to design a scatter shield that would be able to accommodate the three inch bearing and that would also meet all safety requirements. Furthermore, the new scatter shield also had to house a heater, used for high-speed and temperature testing. Using Solidworks, a computer aided modeling program, I was able to



accomplish the task set out for me and designed the new scatter shield. Furthermore, I also guided the fabrication process.

As a result of this containment shield being designed, the Oil-Free turbomachinery team now has the ability to test bearings of larger diameters. Finally, it is expected that these tests will provide information useful for the validation of future analytical modeling codes.