



Robotic Access to Planetary Surfaces Capability Roadmap

**RAPS Team
June 3, 2005**



Agenda



0930-1000	Introduction	Mark Adler
1000-1045	Atmospheric Transit	Neil Cheatwood
1045-1100	Break	
1100-1130	Surface Mobility	Samad Hayati
1130-1200	Accommodation of Instruments and Access to Samples	Steve Gorevan
1200-1300	Lunch	
1300-1345	Aerial Flight	Henry Wright
1345-1415	Cross-Cutting	Joe Parrish
1415-1445	Facilities and Conclusions	Bobby Braun
1445-1500	Margin	



Capability Roadmap Team



- **Co-chairs**
 - Mark Adler, JPL
 - Bobby Braun, GaTech
- **NASA**
 - Debora Fairbrother, GSFC
 - Claude Graves, JSC
 - Samad Hayati, JPL
 - Dean Kontinos, ARC
 - Tom Rivellini, JPL
 - Brian Wilcox, JPL
 - Henry Wright, LaRC
- **Academia**
 - Dave Miller, MIT
- **Industry**
 - Ben Clark, Lockheed-Martin
 - Steve Gorevan, Honeybee Robotics
 - Joe Parrish, Payload Systems
 - Al Witkowski, Pioneer Aerospace
- **Coordinators**
 - Harley Thronson, NASA HQ SMD
 - Carl Ruoff, APIO



Capability Description



- **Land, Fly, Rove, Dig**
 - Operating on (and under) planetary surfaces and in planetary atmospheres
 - Includes aerocapture
 - Includes planetary protection
- **On Large Solar System Bodies**
 - Moon, Mars, Venus, Titan, Europa, Gas Giant atmospheres
 - Earth landing for sample returns
 - (not small bodies, asteroids, comets)



Capability Breakdown Structure



Robotic Access to Planetary Surfaces 6

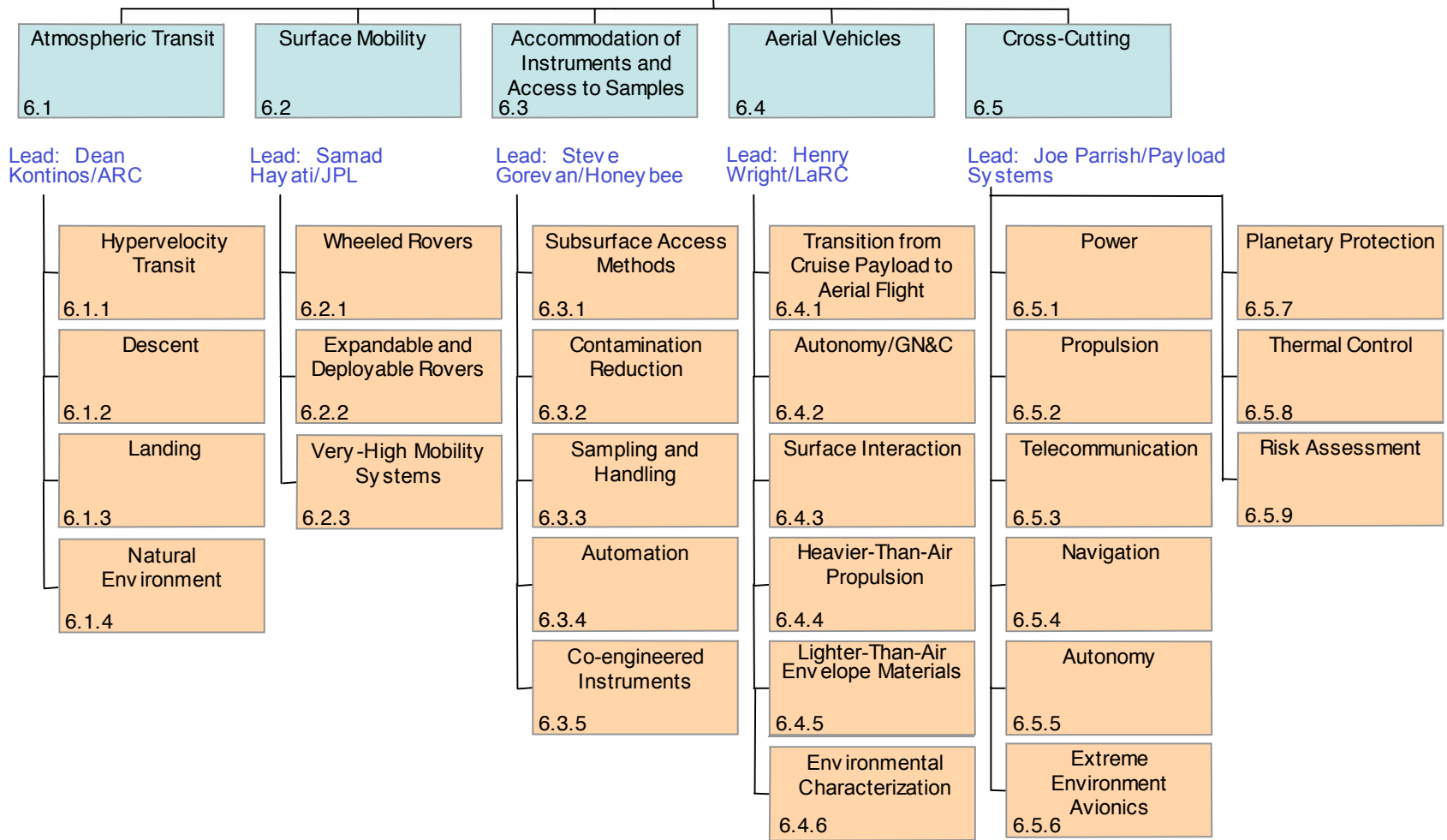



“Roads? Where we’re going, we don’t need roads.”

**Dr. Emmett L. Brown (Christopher Lloyd) in
*Back to the Future***



Strategic Roadmaps



- **Robotic Access directly driven by and supports:**
 - **Solar System Exploration Roadmap**
 - **Mars Exploration Roadmap**
 - **Lunar Exploration Roadmap**



Other Capability Roadmaps



- **Scientific Instruments and Sensors**
 - RAPS brings the instruments to the samples and the samples to the instruments
 - SIAS provides integrated instruments, e.g. down-hole
- **Human Planetary Landing Systems**
 - Continues EDL evolution from RAPS
- **Autonomous Systems and Robotics**
 - Provides high-level autonomy for surface robots
- **Communication and Navigation**
 - Provides relay communications and radio-location services
- **High Energy Power and Propulsion**
 - Provides nuclear power sources for in situ vehicles
- **In-space Transportation**
 - Provides in-space systems for sample returns
- **In situ Resource Utilization**
 - ISRU can provide propellant for very-long-range traverse



Coverage Assumptions



- **Human mission drivers**
 - Robots as assistants to humans in space and on planetary surfaces (Human Exploration Systems and Mobility)
 - ISRU and resource extraction (In situ Resource Utilization)
- **High-level autonomy (Autonomous Systems and Robotics)**
 - Automated planning and sequencing — flight and ground
 - On-board science analysis
 - Proximity cooperation of multiple surface assets
 - Machine perception, including vision to support pinpoint landing and hazard avoidance
 - Mobility and articulation goal seeking
- **Robotic sample-return capabilities (In-space Transportation)**
 - Planetary ascent
 - Autonomous rendezvous and capture
- **Communications and Navigation (High-capacity Telecom and Information Transfer)**
 - Surface relay communication and radio location determination
 - Proximity communication between surface assets
 - Approach navigation, including optical data types
 - EDL and other critical event communication
 - Post-entry EDL navigation aids (orbital and surface)



Roadmap Process



- 1. Define scope of roadmap, Oct 14, 2004**
- 2. Select team members to cover scope, Nov 1, 2004**
- 3. Conduct public session to solicit input, Nov 30, 2004**
- 4. Conduct three workshops with invited experts**
 - 1. Dec 15-17, 2004, JPL**
 - 2. Feb 2-4, 2005, ARC**
 - 3. Mar 3-4, 2005, Georgia Tech**
- 5. Construct roadmap messages (3rd workshop)**
- 6. Detail roadmap actions (April)**
- 7. Executive Summary (May)**
- 8. *External Review (June)***
- 9. Final Report (July)**



Roadmap Approach



- **Define scope and preliminary reference missions**
 - Establish relations with other roadmaps
- **Canvas community for capability status, plans, and hopes**
 - Significant overlap with HPLS in atmospheric transit, held common workshops
- **Construct roadmap messages**
 - What we think NASA should do, action-oriented
- **Fill in details of the actions**
 - Metrics
 - Applicable reference missions, or push missions
 - Current and required capability readiness (descriptive)
 - Key resources, e.g. facilities
 - Rough cost and schedule estimates
- **Lay out a representative implementation plan**

Europa Ldr





NASA Strategic Objectives (first 3 of 18):

- 1. Undertake robotic and human lunar exploration to further science and to develop and test new approaches, technologies, and systems to enable and support sustained human and robotic exploration of Mars and more distant destinations. The first robotic mission will be no later than 2008.**
- 2. Conduct robotic exploration of Mars to search for evidence of life, to understand the history of the solar system, and to prepare for future human exploration.**
- 3. Conduct robotic exploration across the solar system for scientific purposes and to support human exploration. In particular, explore the moons of Jupiter, asteroids, and other bodies to search for evidence of life, to understand the history of the solar system, and to search for resources.**

All require robotic access to planetary surfaces



The Real Justification





Design Reference Missions (1)



- **Derived from:**
 - Solar System Strategic planning
 - Mars Exploration Program planning
 - Robotic Lunar Exploration planning
- **Subset of conceived missions chosen:**
 - To involve the scope of this roadmap
 - To drive capability developments in time
 - Does not include all applicable missions, only schedule drivers
- **Pathways**
 - Missions on separate pathways are included in the capability development to enable the choice
- **Schedule**
 - Assumed capability readiness required in all cases four years before launch



Design Reference Missions (2)



- **Lunar Precursor Lander 2011**
- **Mars Sample Return 2016**
- **Titan Explorer (airship) 2018**
- **Europa Astrobiological Lander 2018**
- **Mars Deep Drill 2020**
- **Mars Astrobiological Field Laboratory 2020**
- **Venus Surface Explorer 2020**
- **Jupiter Atmospheric Probes 2020**
- **Neptune Orbiter (aerocapture) 2023**



Top-Level Roadmap

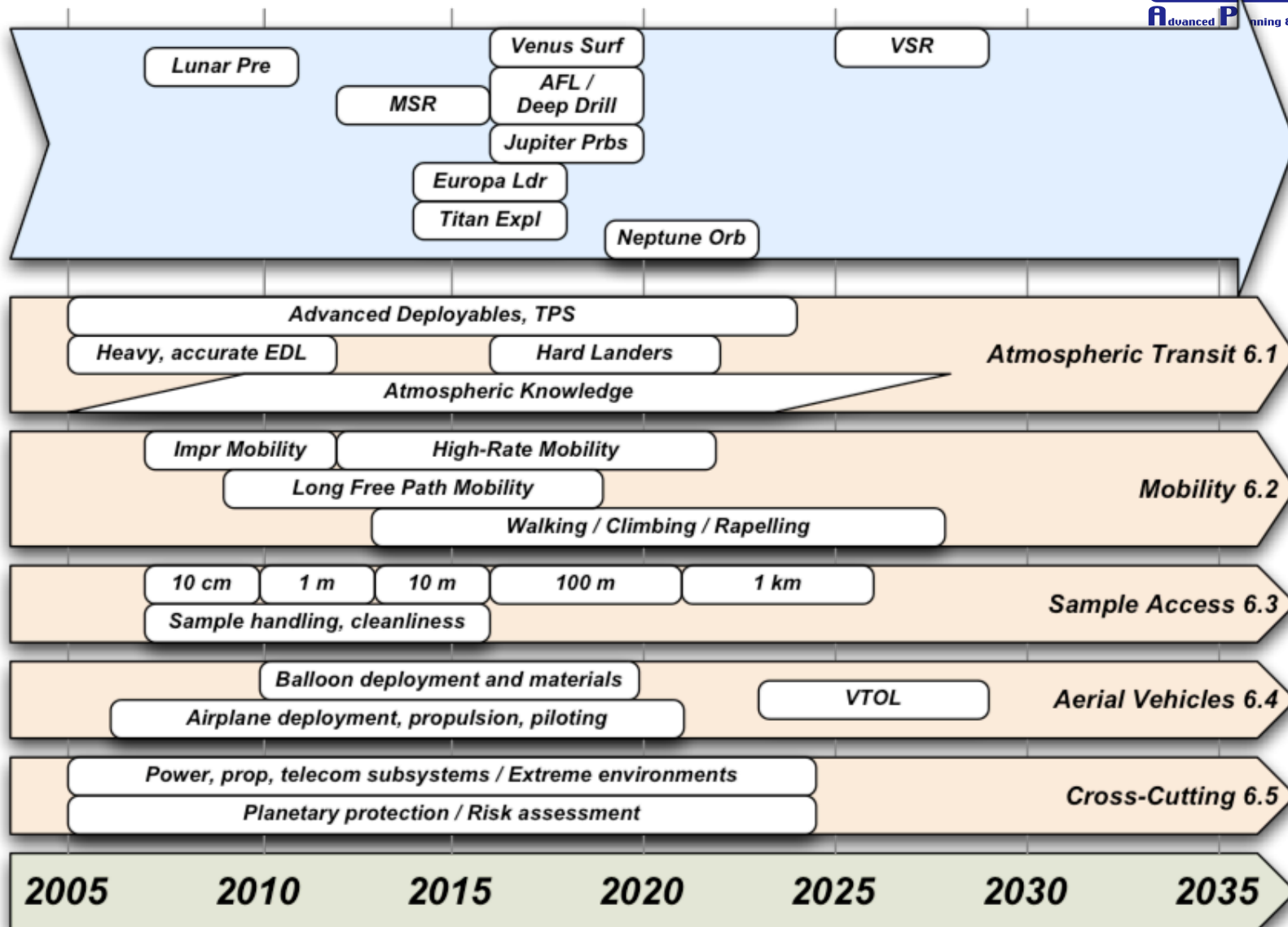



Key Architectural Decisions



Key Architecture/Strategic Decisions	Date Decision is Needed	Impact of Decision on Capability
Decision to launch Mars Sample Return.	9 years before the intended launch.	Latest date to start planetary protection, Earth entry, heavy Mars EDL, advanced mobility, and sample handling capabilities.
Decision to launch an in situ life-detection laboratory to Mars, either rover-borne or on a fixed platform deep drill.	7 years before the intended launch (though see next row).	Latest date to start contamination reduction and sterilization, and complex sample handling.
Decision to launch a deep drill life-detection laboratory to Mars.	8 years before the intended launch.	Latest date to start an autonomous deep drill, and down-hole instrumentation.
Decision to continue the exploration of Titan with a long-lived airship capable of surface sampling.	8 years before the intended launch.	Latest date to start airship materials, guidance and control, propulsion, and surface interaction.
Decision to explore the Venusian surface with a long-lived laboratory.	7 years before the intended launch.	Latest date to start extreme environment survival system studies and component development.
Decision to deliver deep atmospheric probes to Jupiter, or decision to conduct an aerocapture at Neptune.	12 years before the intended launch.	Latest date to start thermal protection materials, refurbish test facilities, and analysis capabilities.



Cost and Schedule



- **Cost estimates have been provided where available**
 - All are considered to have an uncertainty of a factor of three in the up direction, unless otherwise stated
 - Many areas require further definition since the cost is strongly dependent on the requirements of the capability, or the duration of the maintenance of a capability
 - The costs are provided for top-level conceptual planning only. Detailed cost estimates should be requested from providing organizations. Your mileage may vary.
- **Schedule estimates are shown in the roadmap graphics**
 - Similarly, detailed schedule estimates should be requested, given more detailed scope definitions



6.1 Atmospheric Transit

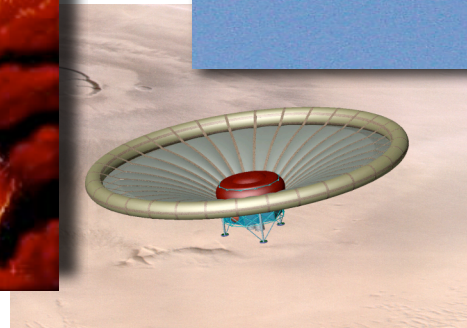
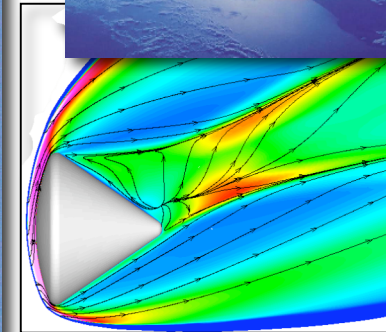
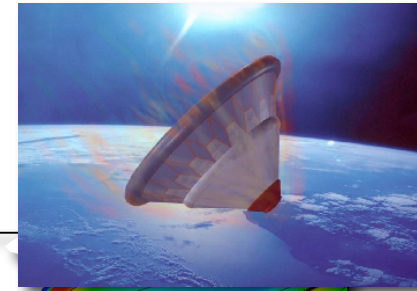
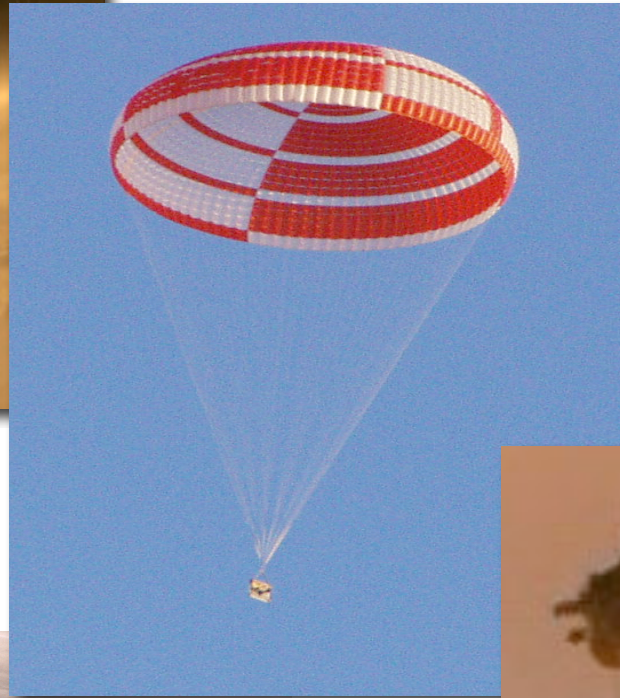
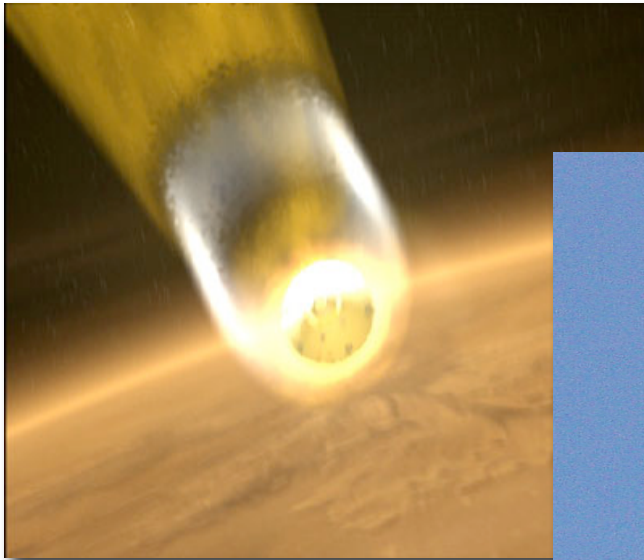



6.1 Atmospheric Transit



- **Entry, descent, and landing**
- **Entry: thermal protection and controlled hypersonic flight in atmospheres, guidance in hypersonic flight for precision landing and aerocapture**
- **Descent: non-thermal supersonic and subsonic deceleration and control in atmospheres, guidance for pinpoint landing**
- **Landing: sensing and reaction for hazard avoidance and controlled surface impact, structure and mechanisms for surface impact survival and stability**
- **Descent guidance and landing also apply to bodies without atmospheres**



6.1 Benefits



- **Placement of instrument packages and vehicles on planetary surfaces**
 - Landers / stations
 - Rovers
 - Sample returns (both ends)
- **Atmospheric measurements and sampling**
 - Atmosphere probes
 - Atmosphere samplers (hyperbolic exit for return)
- **Deployment of aerial vehicles in the atmosphere**
 - Vehicles covered in 6.4
- **Aerocapture of orbiters**



6.1 State of Practice



- **Mars entry and descent (Viking, Pathfinder, MER)**
- **Legged soft landing (Surveyor, Apollo, Viking)**
- **Airbag rough landing (Pathfinder, MER)**
- **Atmospheric probes (Pioneer Venus, Galileo)**
- **Earth return (Apollo, Genesis, Stardust en route)**
- **Other countries:**
 - **Luna landers at the Moon (USSR)**
 - **Luna sample returns to Earth (USSR)**
 - **Mars 3 lander? (USSR)**
 - **Vega 1/2 landers at Venus (USSR)**
 - **Vega 1/2 balloon deployments at Venus (USSR/France)**
 - **Huygens atmosphere and surface probe at Titan (ESA)**



6.1 Driving Mission Assumptions



- **Assume sky crane technology developed for MSL**
- **Large (> 1 mt) payloads to Martian surface**
- **Moon and Mars precision and pinpoint landing**
- **Gas giant atmosphere probes and aerocapture**
- **Venus atmosphere probes and surface landers**
- **Titan aerial vehicle delivery to pre-deployment conditions**
- **Europa landing**
- **Earth landing for Mars Sample Return**
 - **With very high reliability**



6.1 Atmospheric Transit Roadmap

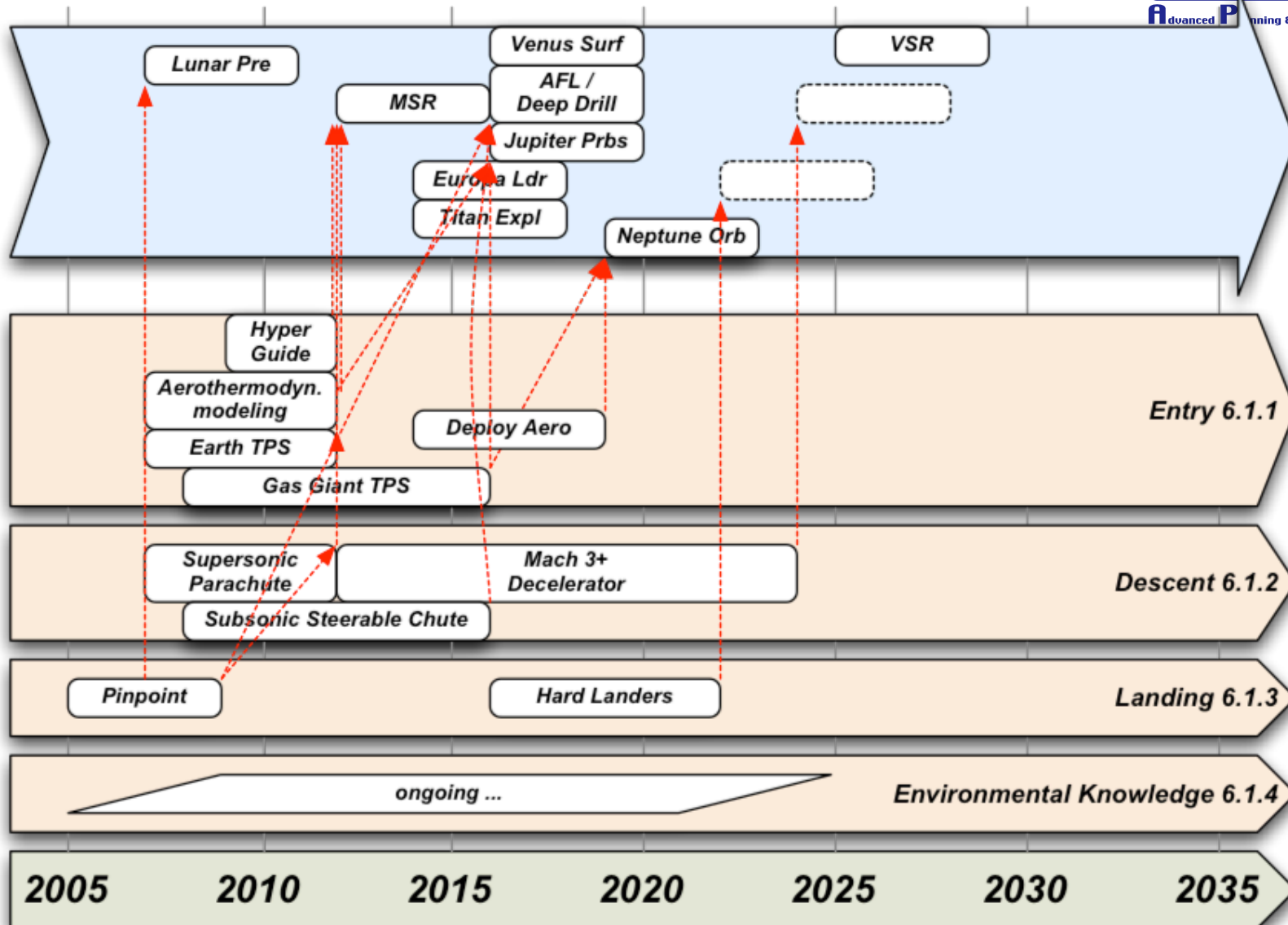



6.1.1 Atmospheric GN&C



- **Advanced GN&C algorithms must be brought from the simulation & analysis realm to flight readiness with sufficient reliability to enable precision (< 10 km) landing, pinpoint (< 100 m) landing and aerocapture.**
- **Derivatives of Apollo GN&C algorithms exist but have not been flight proven for aerocapture. Advanced GN&C algorithms offer significant performance and robustness advantages.**
- **Metrics: Landing precision, software complexity, compute time and robustness**
- **Resources: GN&C expertise within NASA, industry and academia.**
- **Applicable at multiple planetary destinations (Mars, Venus, Titan, Neptune, Earth).**
 - MSL, MHP, MSR, AFL
- **Cost: \$10M**



6.1.1 Aerodynamics



- **Retain aerodynamic performance prediction capability.**
 - Knowledge of static aerodynamics to within 3% and dynamic aerodynamics to within 10% will allow reduced design margin and high reliability atmospheric transit.
- **Aerodynamics expertise exists within the Agency and in industry. Facilities for aerodynamic testing are operated by NASA and are under threat of closure. Little to no flight data for validation.**
- **Metrics: Aerodynamic coefficient uncertainty**
- **Resources: NASA LaRC Hypersonic Complex, Transonic Dynamics Tunnel, and Vertical Spin Tunnel, Eglin and ARC Ballistic Ranges**
- **All missions with trans-atmospheric flight: Mars, Venus, Sample Return, Titan, Gas Giants**
 - MSL, MHP, MSR, AFL
- **Cost: \$40M**



6.1.1 Aerothermodynamic Modeling



- **Accurate prediction of entry heating environments for TPS sizing, mission design, and risk management.**
 - Understand radiating shock layer uncertainty to within $\pm 50\%$, boundary layer transition time to seconds, shock-boundary layer heating predictions to $\pm 25\%$, while reducing simulation time for multi-physics interactions to hours.
- **Expertise resides primarily within NASA.**
 - Currently able to predict forebody convective heating to $\pm 15\%$ and forebody turbulent heating to $\pm 25\%$. Radiative heating $\pm 300\%$, transition to turbulence time (minutes), aft-body heating $\pm 100\%$, and ablative shock layers $\pm 200\%$. Insufficient flight data to validate models.
- **Metrics: Aerothermodynamics uncertainty and computational time**
- **Resources: LaRC Aerothermodynamics Laboratory, ARC shock tube and ballistic range, Calspan-University of Buffalo Research Center LENS facility, Cal Tech T5, Supercomputing Facilities, high-fidelity CFD analysis/codes**
- **All missions with trans-atmospheric flight: Mars, Venus, Sample Return, Titan, Gas Giants: MSL, MHP, MSR, AFL**
- **Cost: \$25M**



6.1.1 Ablative TPS



- **Develop reliable mid/high-density ablative TPS for specific entry and aerocapture environments.**
 - **Reduce mid-density TPS mass fractions from 25-30% to 15-20%.
Reduce high-density TPS mass fractions from 50-100% to 30-50%.
High fidelity TPS response modeling: surface temperature to within 100 deg C, in-depth temperatures to within 10% and 10 s, surface recession to within 20%, char thickness and depth to within 10%.**
- **Few existing, poorly characterized mid-density ablative materials. Heritage high-density materials needed for Gas Giants no longer manufactured, recipe lost**
- **Metrics: TPS mass fraction and thermal response prediction**
- **Resources: ARC and JSC arc-jets, ARC Giant Planet Facility (reconstituted) for Gas Giants.**
- **Sample return missions (Mars, Lunar), aerocapture missions (Venus, Neptune), entry probes (Venus, Saturn, Jupiter)**
 - **MSR, Moonrise**
- **Cost: \$30M for mid-density, \$30M high-density**



6.1.1 Deployable Decelerators (Inflatable Hypersonic)



- **Develop deployable entry systems that package on existing launch vehicles and experience extremely low entry heating (1-10 W/cm²).**
- **Current planetary program relies on rigid aeroshells and ablative thermal protection systems. The Russians have flown, unsuccessfully, an inflatable system. In the US, system studies for deployables and inflatables are ongoing.**
 - **Key challenges are materials, deployment, aerostability, and control.**
- **Metrics: Materials characterization, aerostability, integration**
- **Resources: NASA LaRC Hypersonic Complex and Transonic Dynamics Tunnel, High altitude balloon flight testing (NASA WFF), Sounding rocket flight testing (NASA WFF, strategic assets), Super-computing facilities for dynamic aero-thermal-structural simulation.**
- **Applicable to Venus, Titan, and Neptune aerocapture, Heavy Mars landers and Earth return.**
- **Cost: \$75M to \$150M**



6.1.2 Supersonic Parachute



- **Develop supersonic parachute to support Mars entry masses ~4000 kg, Mach 2.5 deploy**
- **Currently limited to Viking heritage, ~1000 kg entry mass, Mach 2.1 deploy**
 - **Have been living off of the Viking parachute qualification for over 30 years**
- **Metrics: drag area, deploy Mach, mass, stability**
- **Resources: High altitude balloon flight testing (NASA WFF), NASA LaRC TDT, NASA GRC 10x10, Sounding rocket flight testing (NASA WFF, strategic assets)**
- **Needed for MSR, AFL, Deep Drill**
- **Cost: \$140M (within 30%)**



6.1.2 Deployable Decelerators (Inflatable Supersonic)



- **Develop supersonic deployable drag device for enabling large entry mass (> 4000kg) to Mars.**
- **Parachute systems are prohibitive due to size and Mach number constraints. Numerous studies and experiments of inflatable supersonic decelerators. Devices are not flight tested, and will require additional subsonic decelerator for adequate performance.**
- **Metrics: drag area, deploy Mach, mass, stability**
- **Resources: High altitude balloon flight testing (NASA WFF), NASA LaRC TDT, NASA GRC 10x10, ARC NFAC, Sounding rocket flight testing (NASA WFF, strategic assets), Supercomputing facilities**
- **May be applicable to MSR, AFL, MHP**



6.1.2 Subsonic Parachute



- **Develop subsonic parachute to support large Mars entry mass > 4000 kg. Guidance enhancement enables wind drift compensation for pinpoint landing**
- **One test in relevant environment of single ringsail with no steering**
- **Metrics: drag area, mass, stability, L/D**
- **Resources: High altitude balloon flight testing (NASA WFF), NASA LaRC TDT, NASA GRC 10x10, ARC NFAC, Sounding rocket flight testing (NASA WFF, strategic assets), Supercomputing facilities**
- **May be applicable to MSL, MSR, AFL, MHP**
- **Cost: \$20M (within 30%)**



6.1.3 Landing Airbags



- **Develop low mass (60-80 kg), high reliability, rock-tolerant airbag systems for MER class Mars landing.**
- **MER and Pathfinder used Vectran bags (125 kg). Zylon and its variants offer potential mass savings but no work has been done to explore its applications to airbags.**
- **Metrics: Airbag system mass, reliability**
- **Resources: NASA Glenn Research Center Plum Brook Station (Space Power Facility and B2 vacuum chambers)**
- **Applicable to Mars Scout or MER-class and lunar missions.**
- **Cost: \$20M**



6.1.3 Terrain Sensing



- **Develop high performance terrain sensing customized for the unique requirements of spacecraft landing.**
- **Recent lander missions have used modified military radars with limited performance. Advanced technologies are in development, but not ready for flight qualification**
- **Metrics: Acquisition altitude, Velocity error, Map resolution**
- **Resources: Industry**
- **Applicable to Mars Scout, MSL, MSR, AFL, Europa lander, lunar landers, Venus lander, Venus sample return, Titan explorer, small body/comet sampling and rendezvous missions.**



6.1.3 Descent Propulsion



- **Develop a high reliability, throttleable descent propulsion system**
- **Current technologies are variants of 1960's technologies and span a limited thrust range. Pulse-mode work arounds add control interaction complexity and risk.**
- **Metrics: Control authority, thrust range**
- **Resources: Industry**
- **Applicable to MSL, MSR, AFL, Europa lander, lunar landers, Venus lander, Venus sample return, Titan explorer, small body/comet sampling and rendezvous missions.**



6.1.3 Surface Penetrators



- **Develop low mass, high reliability, single-stage entry to impact system capable of penetrating at least 1-3 m below Mars surface**
- **Space exploration application limited to DS-2 Mars Microprobe (failed), Soviet mission (failed), Japanese mission (postponed). Extensive military application of penetrators.**
- **Metrics: System mass, impact depth & g's, terrain type**
- **Resources: Sandia National Laboratory air guns and test facilities.**
- **Applicable to Mars, Lunar and small body missions**
- **Cost: \$30M**



6.1.4 Atmosphere Characterization



- **Develop planetary atmosphere modeling capability that yields predictions of density within 10% and a credible basis for wind and atmospheric opacity estimation.**
- **Flight through a planetary atmosphere is complicated by our lack of atmospheric knowledge (density, winds and dust content) at hypersonic maneuvering (20-60 km) and terminal descent altitudes (0-10 km).**
- **Metrics: Atmospheric uncertainty, Quantifiable entry system margin reduction.**
- **Resources: Atmospheric science expertise within Agency and academia. May require atmospheric observer orbiter, probe or network science (micro probe) missions as well as instrumentation reqts for all entry systems.**
- **Applicable to MSL, MSR, AFL, Venus sample return, Titan explorer, Gas Giant entry missions**
- **Cost: \$10M per project for entry instrumentation, unknown cost for atmospheric instrumentation piggyback or on dedicated orbiter**



6.2 Surface Mobility

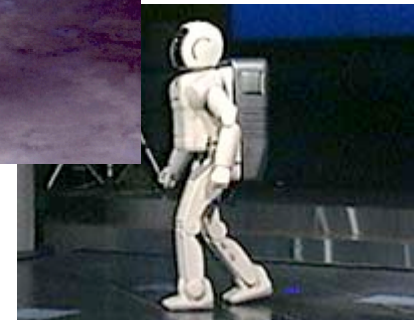
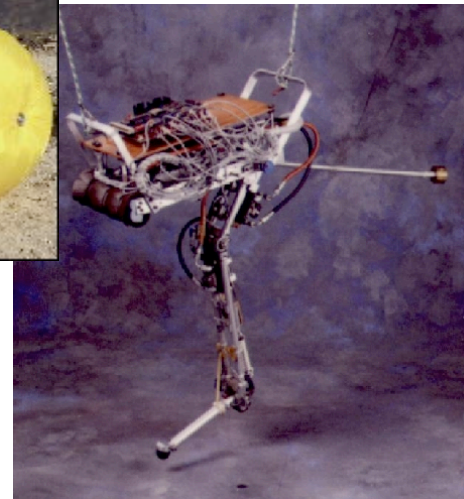



6.2 Surface Mobility



- **Mobile platforms on planetary surfaces**
 - Traversal over the surface
- **Wheeled vehicles**
- **Expandable deployed vehicles**
- **High-mobility non-wheeled vehicles**
 - (Swimming considered but not covered in this roadmap due to number of decades away and lack of characterization of potential environments)



6.2 Benefits



- **Access to features away from landing location (a la Opportunity in Eagle crater)**
- **Exploration of multiple geological units**
- **Access across and beyond landing ellipse**
- **Combined with precision/pinpoint landing and high-mobility, access to any selected point on the surface**



6.2 State of Practice



- **Apollo lunar rover (human operated)**
- **Sojourner rover on Mars**
- **Mars Exploration Rovers**
- **Other countries:**
 - **Lunakhod, teleoperated on the Moon (USSR)**



6.2 Driving Mission Assumptions



- **Mars Sample Return**
 - Rapid sample collection and delivery
- **Mars Astrobiological Field Laboratory**
 - Long traverse, increased autonomy
- **Lunar Precursor Lander**
 - New terrain for our robotic rovers



6.2 Mobility Roadmap

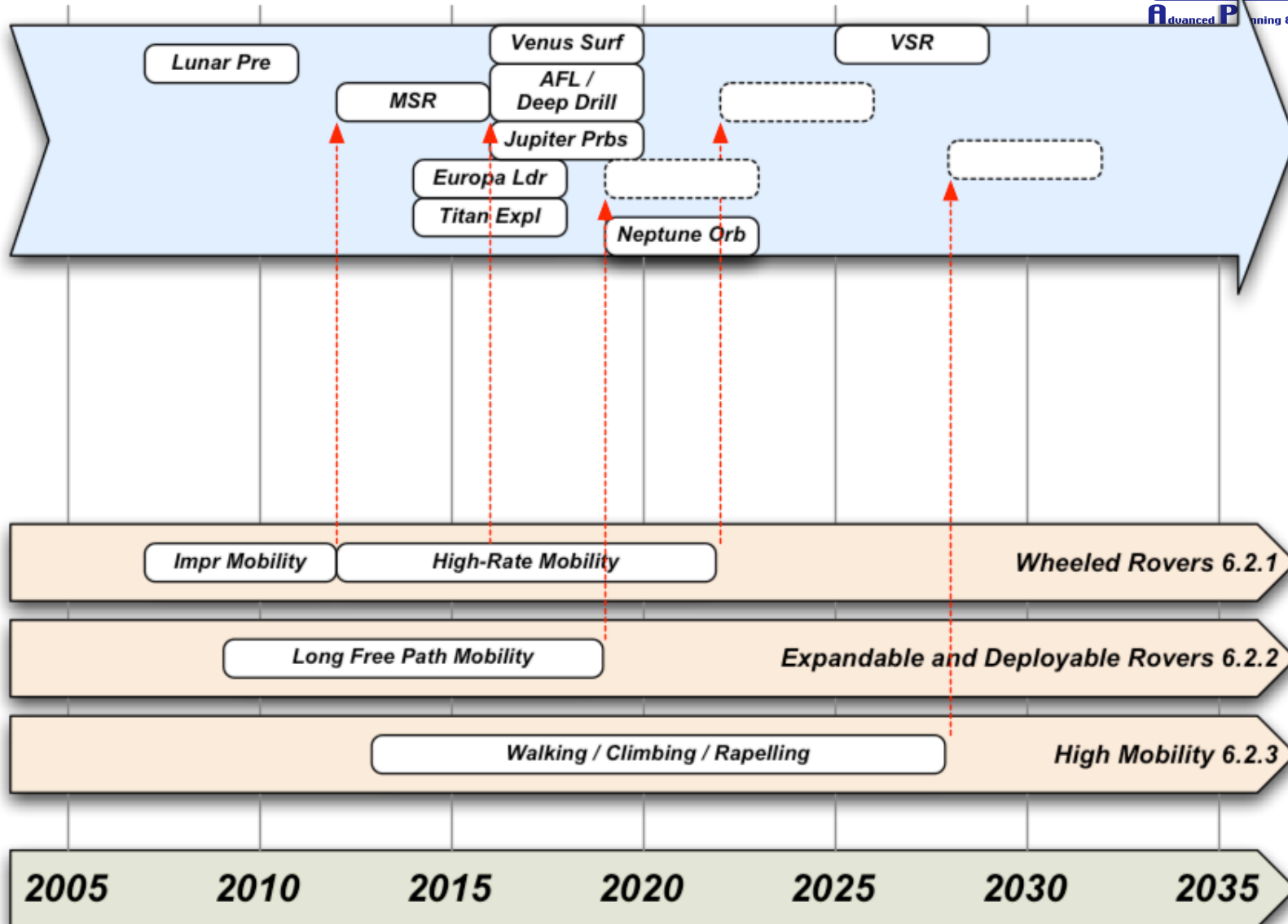



6.2.1 Wheeled Rovers



- **Develop more capable wheeled rovers (longer life, modular architectures, increased computer throughput, and robust navigation sensors)**
- **Currently limited to MER capabilities; i.e, heavy dependency on human-in-the-loop and designed for 90 sols (cannot be guaranteed to operate for several years)**
- **Metrics: Long life, modularity, and increased navigation and compute power (to accommodate more autonomous operation)**
- **Resources: NASA (JPL and ARC), university testbeds**
- **Needed for MSL, MSR, and AFL**
- **Cost: \$2M/yr for technology and \$1M/yr for maintenance of testbeds, for the next 5-15 years**



6.2.2 Expandable and Deployable Rovers



- **Develop rovers that have high vertical climb to stowed ratio (increase from 0.3 to 0.8) and ability to traverse steeper slopes (increase from 30° to 60°)**
- **Currently limited to MER capability of ~0.3 and ~30°**
- **Metrics: Vertical climb to stowed ratio. Traverse on steep slopes**
- **Resources: Some component technologies and materials exist. Non flight-like prototypes have been developed**
- **Needed for Mars scouts and Mars, Solar System, and Lunar SRMs**
- **Cost: \$1-2M/yr for 10 years**



Expandable Rover Capabilities



inflate-demo movie



Expandable Rover Deployment

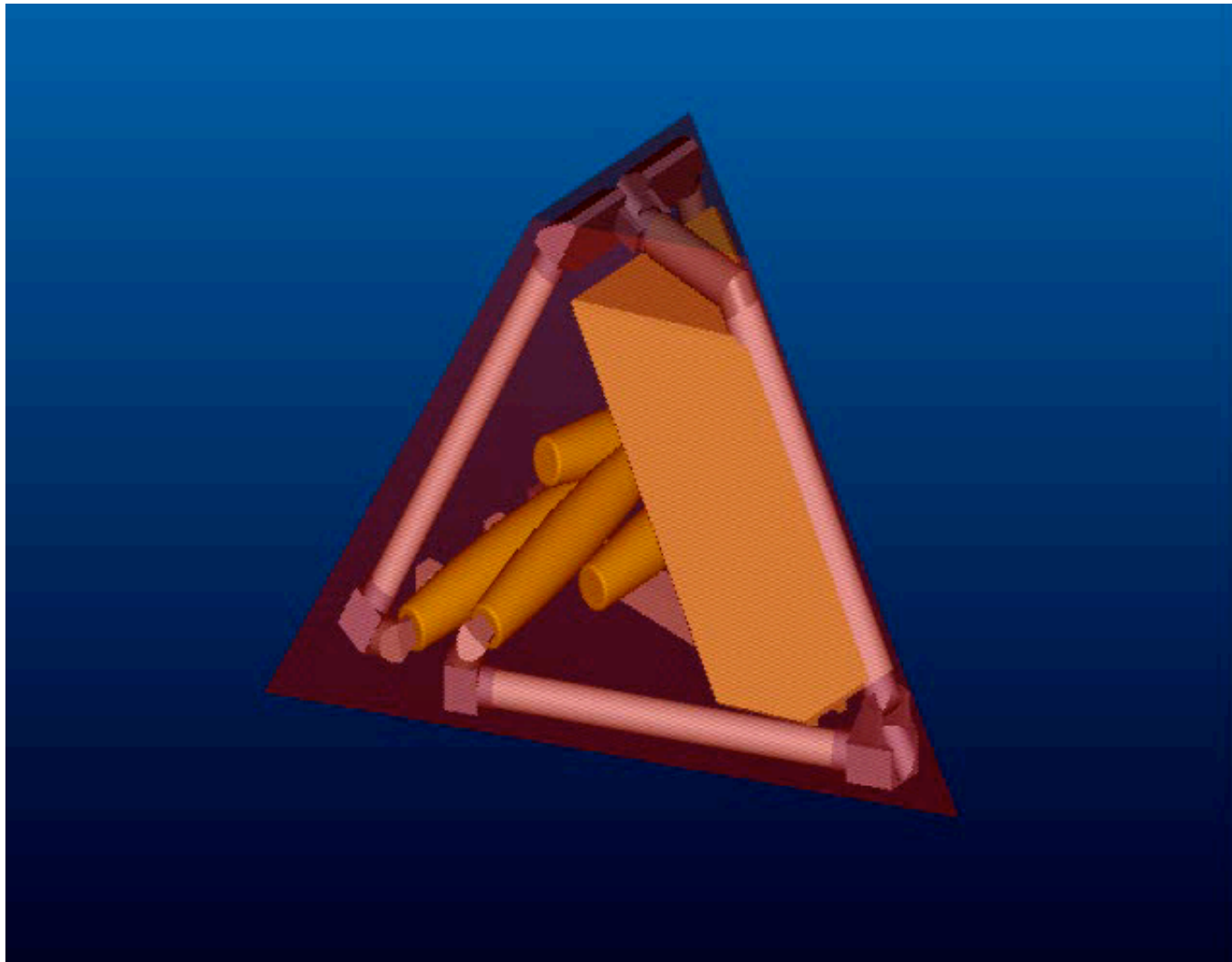



6.2.3 Walking, Rappelling, Hopping



- **Develop mobility systems that are capable of exploring very difficult to access regions (gullies, cliffs, and very rough terrain)**
- **Currently limited to MER capability; moderate terrain roughness, no capability to explore cliffs or gullies**
- **Metrics: Terrain roughness and slope**
- **Resources: Technologies in an early stage of development exist at universities and NASA**
- **Will enable missions in Lunar, Mars and Solar System SRMs**
- **Cost:**
 - **\$1M/yr first 5-year, \$2M/yr 2nd 5-year, \$3M/yr 3rd 5-year**



Climbing Mobility



climber-demo movie



6.3 Accommodation of Instruments and Access to Samples

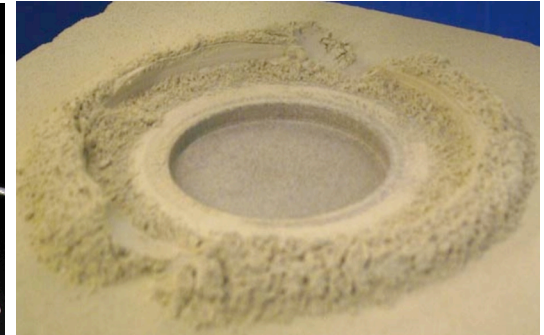
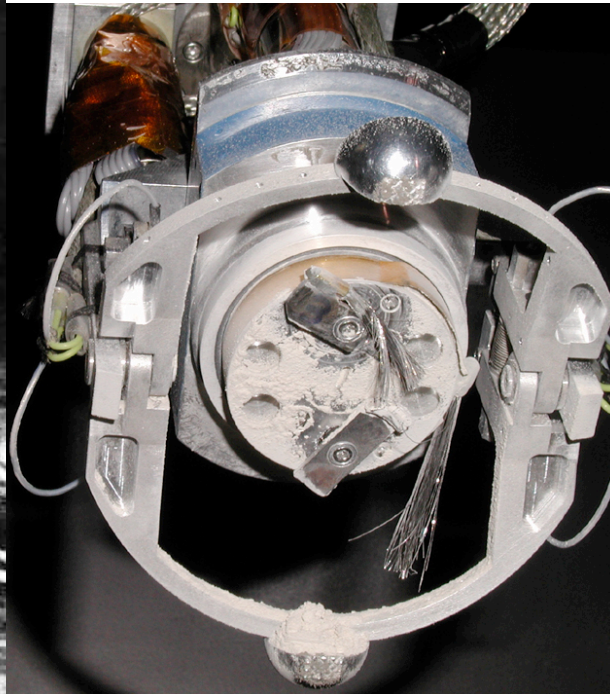
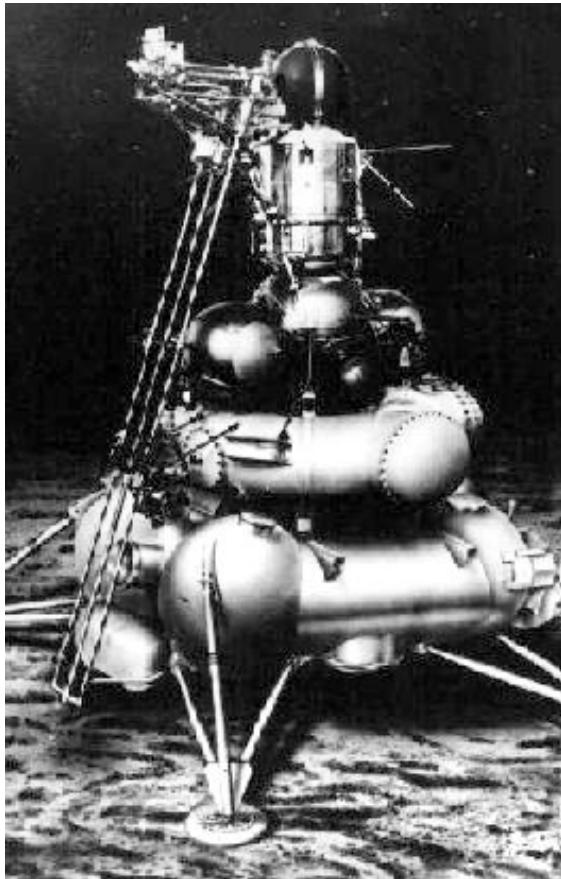



6.3 Accommodation of Instruments and Access to Samples



- **Access to subsurface (mm to km)**
 - Grinding, digging, drilling, melting
- **Sample contamination avoidance**
- **Acquisition and transfer of samples to instruments or containers for return**
 - Processing and preparation of samples for instruments
- **Automation of sample access sensing and control**
- **Integrated design of sensors with access approach**



6.3 Benefits



- **Access older samples below newer surfaces**
- **Access material protected from environment and contamination**
- **Access different geological units at depth**
- **Access pristine samples**
- **Transfer samples to laboratory instruments**
- **Transfer samples to container for sample return**
- **Enable operations on irregular natural objects of unknown composition with reactive automation**
- **Integrate instruments into access devices**



6.3 State of Practice



- **Apollo drill (human operated and powered)**
- **Viking scoop**
- **Mars Exploration Rover rock abrasion tool**
- **Mars Exploration Rover trenching**

- **Other countries:**
 - **Luna, Venera, Vega drills (USSR)**



6.3 Driving Mission Assumptions



- **Mars Sample Return**
- **Mars Deep Drill**
- **Europa Astrobiological Lander**
- **Venus Sample Return**



6.3 Sample Access Roadmap

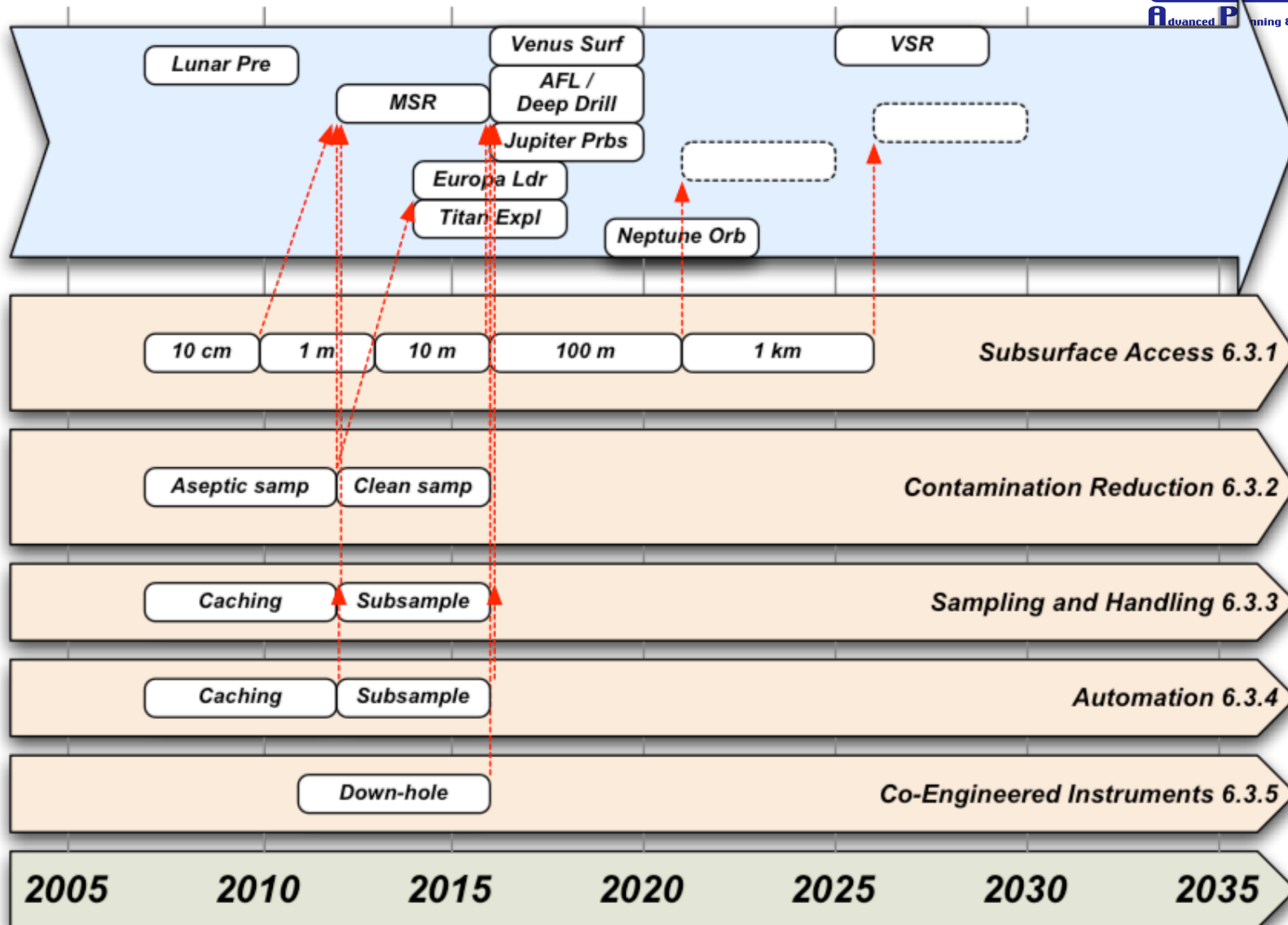



6.3.1 Subsurface Access



- **Reliable, flexible, and repeatable access from millimeter to kilometer range in rocks, ice, ice mix, and regolith.**
- **Currently limited to MER RAT (1-13 mm), shallow trenching using wheels or scoops, and past Lunar drills.**
- **Metrics: Depth of penetration, mass, power, and volume**
- **Resources: Capabilities exists mostly at industry. NASA and universities have some capabilities.**
 - **Unfortunately, very little can be leveraged in this area from terrestrial drilling technologies**
- **Needed by Mars (MSL, MSR, AFL, Deep Drill), Solar System (Venus In-situ and Surface Explorer missions), and Moon Reference Lander**
- **Cost: 10 cm - \$7M, 1 m - \$10M, 10 m - \$20M, 100 m - \$45M, 1 km+ \$130M**



6.3.2 Contamination Reduction



- **Develop forward and cross contamination control, localized barriers, in situ sterilization, and hermetic seals capabilities for sample return canisters**
- **Capabilities in an early stage of development exist at NASA and industry**
- **Metrics: PPM of containment in samples, bio-load vs. non-organic contaminants**
- **Resources: NASA, university, and industry to a limited extent.**
- **Needed by MSR, greater degree by Mars AFL/Deep Drill and Europa lander**
- **Cost: \$5M**



6.3.3 Sampling and Handling



- **Develop capabilities to acquire precision samples (powder, solid, soils, and fluids), preserve ingredients, and manipulate, process, and transfer samples**
- **Sample handling and transport systems have been demonstrated in laboratory settings**
- **Metrics: Number of transfers (hand-offs of sample)**
- **Resources: Industry leads. NASA is developing systems, universities to lesser degree**
- **Needed by all reference missions**
 - **MSL is now struggling with complex sample handling requirements, in retrospect more such development should have been done earlier**
- **Cost: \$20M**



6.3.4 Automation



- **Develop capabilities to autonomously operate sampling systems safely and efficiently in a highly unstructured environment**
- **Current capability is at the level of laboratory demonstration for various technologies. Significant new capabilities are required.**
- **Metrics: Number of ground loops required, hours of continuous operations**
- **Resources: Industry, NASA, and universities**
- **Needed by almost all missions in Mars and Solar System SRMs**
- **Cost: \$15M**



6.3.5 Co-engineered Instruments



- **Develop capabilities for sub-surface instrument access via integrated and embedded instruments into subsurface access systems**
- **Current capability is at the level of laboratory demonstration, not yet in flight-like configurations**
- **Metrics: Mass, volume, power, allowable vibration level, and instrument sample requirements**
- **Resources: Industry, NASA, and universities**
- **Needed by almost all missions in Mars and Solar System SRMs**
- **Cost \$15M (highly dependent on requirements)**



6.4 Aerial Flight

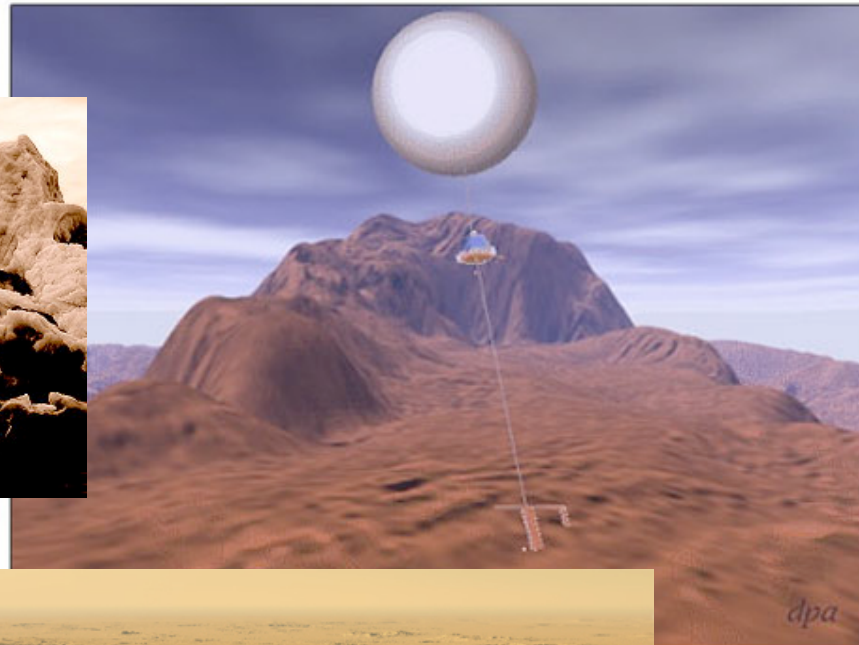



6.4 Aerial Flight



- **Heavier than Air Systems**
 - Airplanes
 - Gliders
- **Lighter than Air Systems**
 - Balloons
 - Airships



6.4 Benefits



- **Aerial vehicles fill a unique planetary science measurement gap, that of regional-scale, near-surface observation, while offering a new perspective for potential discovery.**
 - **Regional-scale science (hundreds to thousands of km)**
 - **In-situ atmospheric measurements in the near-surface planetary boundary layer**
 - **Atmosphere-surface interactions (photochemical sources/sinks)**
 - **High-spatial resolution**
 - **Flight over inaccessible surface terrain**



6.4 State of Practice



- **Heavier than Air Platforms:**
 - No planetary flight experience
 - Today’s airplane technology is sufficient to enable “first flight” on another planet.
 - Inertially propagated navigation uncertainty is the limiting factor for autonomous aerial flight.
 - Four critical technology investment areas: Transition, Autonomy, Surface Interaction, and Propulsion.
- **Lighter than Air Platforms:**
 - Balloon flight has been successfully demonstrated on Venus
 - Specific technologies for flight at Mars or Titan require development.
 - Key technology issues for airships and balloons revolve around the trade between mission endurance and payload capacity.
 - Four critical technology investment areas for extended duration flight: Transition, Autonomy, Surface Interaction, and Envelope Materials.



6.4 Driving Mission Assumptions



- **At the current time, NASA's core science missions do not include aerial vehicles.**
- **Design Reference Missions**
 - Titan Explorer: the NRC Decadal survey recommended consideration of an aerial exploration of Titan as a follow-on to the Cassini-Huygens mission.
 - Venus In Situ Explorer
 - Venus Sample Return
- **Science teams from around the country are intrigued with the potential for observations of Mars and Venus via aerial vehicles.**



6.4 Aerial Flight Roadmap

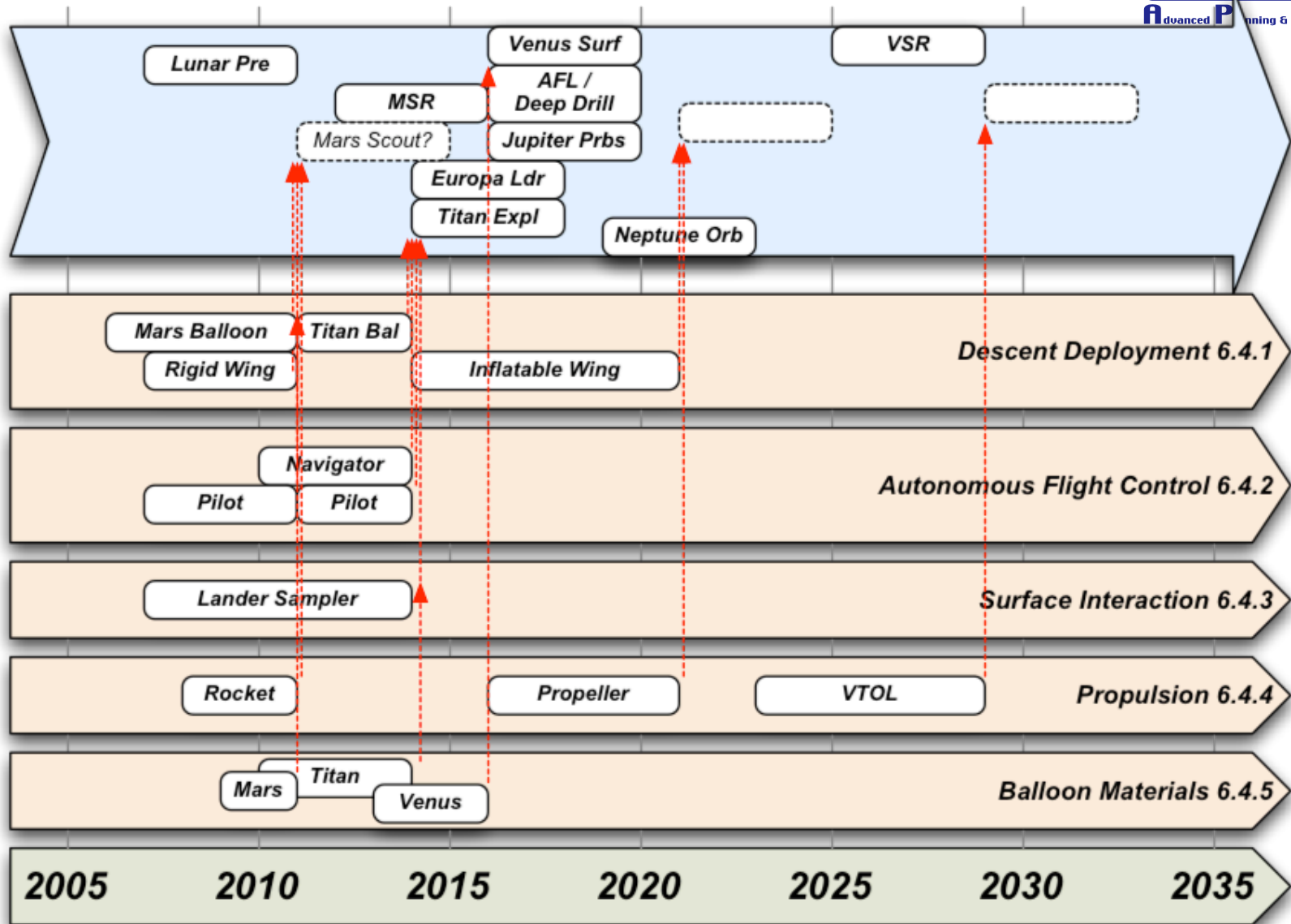



Potential Capability Timeline



Destination	Today	+10 Years	+20 Years	+30 Years
Mars	<ul style="list-style-type: none"> • Rocket Airplane (500 – 800 km) • Glider (40–100 km) 	<ul style="list-style-type: none"> • Propeller Airplane (10,000 km) • Balloon – 90 days 	<ul style="list-style-type: none"> • Propeller Airplane (global) • Balloon (global) • VTOL 	<ul style="list-style-type: none"> • Airplane (unlimited range) • Airplane (local reconnaissance)
Venus	<ul style="list-style-type: none"> • Balloon (100 hours – high altitude) 	<ul style="list-style-type: none"> • Rocket Airplane • Balloon (global) • Balloon (low altitude) 	<ul style="list-style-type: none"> • Propeller Airplane • Airship (global) 	
Titan	<ul style="list-style-type: none"> • Balloon 	<ul style="list-style-type: none"> • Airship (90 days) 	<ul style="list-style-type: none"> • Airship (global) • VTOL 	<ul style="list-style-type: none"> • Airship (unlimited range)



6.4.1 Transition



- **Develop reliable strategies for mid-air transition from a stowed payload to a flying platform**
- **Current HTA vehicle transition methods rely on rigid wings and empennages with hinges, latches, and energy absorbing devices, demonstrated with high-altitude balloon Earth-based testing. LTA flight has been demonstrated on Venus (Soviet Vega) and in high-altitude balloon Earth-based testing.**
- **Metrics: Reliable/repeatable deployments, mass**
- **Resources: High altitude balloon flight testing (NASA WFF and industry), NASA LaRC TDT, NASA GRC Large Vacuum Chamber**
- **Applicable to Venus, Mars Scout and Titan missions**
- **Cost: \$10M rigid wing, \$20M inflatable wing, \$8M Venus/Titan balloon, \$10M Mars balloon**



6.4.2 Autonomous Navigation



- **Improve long term navigation knowledge to < 1 km, enabling exploration of unique science features.**
- **IMU propagation errors limit near-term flights to a few hours duration. Promising navigation solutions include: use of orbital assets for 2-way range and Doppler tracking, feature recognition, and reduced power radar or laser altimeters .**
- **Metrics: Position knowledge, Mission duration**
- **Resources: Captive carry testing and integrated low altitude flight testing - NASA and Industry; Integrated High Altitude Flight Testing - NASA WFF and Industry**
- **Applicable to Venus, Mars Scout and Titan missions**
- **Cost: RF \$5M, optical \$9M, active \$5M**



6.4.2 Autonomous Flight Control



- **Development of a robust flight control architecture which allows self-diagnosis and problem resolution will allow long duration (> 10 days for HTA, >30 days for LTA) aerial flight.**
- **Terrestrial systems have demonstrated end-to-end autonomy. Soviet Vega balloon demonstrated autonomous mission. High altitude flight testing on Earth in relevant environment have demonstrated precursor GN&C methods.**
- **Metrics: Flight control robustness, aerial mission duration**
- **Resources: High altitude balloon flight testing (NASA WFF and industry), NASA LaRC TDT, NASA GRC Large Vacuum Chamber**
- **Applicable to Venus, Mars Scout and Titan missions**
- **Cost: \$12M first flight, \$25M long duration**



6.4.3 Surface Interaction



- **Develop reliable strategies to survive planetary (Mars) surface landing.**
- **Dropping a science package while in flight is current state of the art. Technologies for soft landing under study include hazard detection and avoidance, precision navigation, and airplane propulsion.**
- **Metrics: Surface approach speed and terrain type, mass, acquisition altitude**
- **Resources: NASA and industry**
- **Applicable to Venus, Mars Scout and Titan missions**
- **Cost: package drop \$5M, airship touch \$12M, airplane one soft landing \$15M, airplane multiple landings \$30M (Mars)**



6.4.4 Heavier than Air Propulsion



- **Improve aerial traverse range (to 10,000 km) and duration (to days).**
- **Current systems are limited to rocket powered vehicles with ranges up to ~1000 km and 90 minutes duration. Propellers and turbo-jets provide the highest near term promise for improving conversion efficiency to enable longer duration flight. Reducing the mass and increasing the robustness of the gearbox between the motor or engine and the propeller is an additional enabling technology.**
- **Metrics: Aerial performance: range and duration**
- **Resources: High altitude balloon flight testing (NASA WFF and industry), NASA LaRC TDT, NASA GRC Large Vacuum Chamber, NASA ARC NFAC**
- **Applicable to Venus, Mars Scout and Titan missions**
- **Cost: rocket \$3M, propeller \$18M, VTOL \$20M**



6.4.5 Lighter than Air Materials



- **Develop low mass, strong and reliable materials for LTA vehicles**
- **Materials selection must balance toughness, pliability and mass. Floating over Mars drives the need for lightweight materials which are resistant to UV degradation with mild cryogenic conditions. Risk mitigation drives system design to multi-layer materials with higher strength. For Titan, there is a need for cryogenic materials; whereas materials for Venus are driven towards elevated temperature characteristics and sulphuric acid resistance.**
- **Metrics: Aerial mass, longevity in extreme environments, abrasion and tear resistance**
- **Resources: High altitude balloon flight testing (NASA WFF and industry), NASA GRC Large Vacuum Chamber**
- **Applicable to Venus, Mars Scout and Titan missions**
- **Cost: Venus \$7M, Titan \$10M, Mars \$4M**



6.4.6 Atmosphere Characterization



- **Develop planetary atmosphere modeling capability that yields predictions of density within 10% and a credible basis for wind and atmospheric opacity estimation.**
- **Flight within a planetary atmosphere is complicated by our lack of atmospheric knowledge (density, winds and dust content) at aerial traverse altitudes (0-5 km).**
- **Metrics: Atmospheric uncertainty, Quantifiable margin reduction.**
- **Resources: Atmospheric science expertise within Agency and academia. May require atmospheric observer orbiter, probe or network science missions as well as instrumentation reqts for all entry systems.**
- **Applicable to Venus, Mars Scout and Titan missions**



6.5 Cross-Cutting Systems

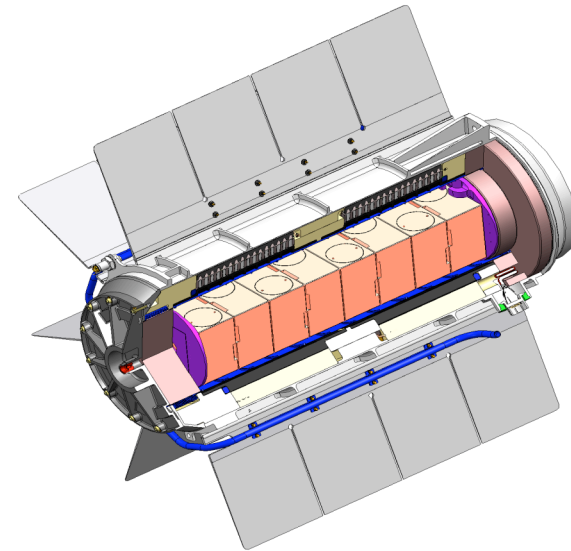



6.5 Cross-Cutting Systems



- **Subsystems and generic vehicle requirements for atmosphere and surface operations**
 - Power
 - Propulsion
 - Telecom
 - Navigation
 - Autonomy
 - Extreme Environments
 - Planetary Protection
 - Thermal Control
 - Risk Assessment
- **Interfaces with other capability roadmaps**



6.5 Benefits



- **New throttled liquid propellant engines for sample returns**
- **Small radioisotope power systems for small explorers**
- **Black box for hard impact data return**
- **Extreme environments capabilities required for Venus and Europa surface missions**
- **Planetary protection and risk assessment capabilities required for Mars Sample Return**
- **Higher performance subsystems enable existing and new mission concepts**



6.5 State of Practice



- **Solar power at 23% efficiency**
- **Nuclear radioisotope power at 6% efficiency**
- **Solid propellant and pulsed liquid thrusters**
- **Survival in Martian, Titan surface environments**
- **Planetary protection forward contamination at class IVA**
- **Autonomous waypoint surface navigation**



6.5 Driving Mission Assumptions



- **Mars Sample Return**
 - Planetary protection
- **Venus Surface Explorer**
 - Extreme environments
- **Europa Astrobiological Lander**
 - Extreme environments
 - Planetary protection
- **All landers**
 - Propulsion



6.5 Cross-Cutting Roadmap

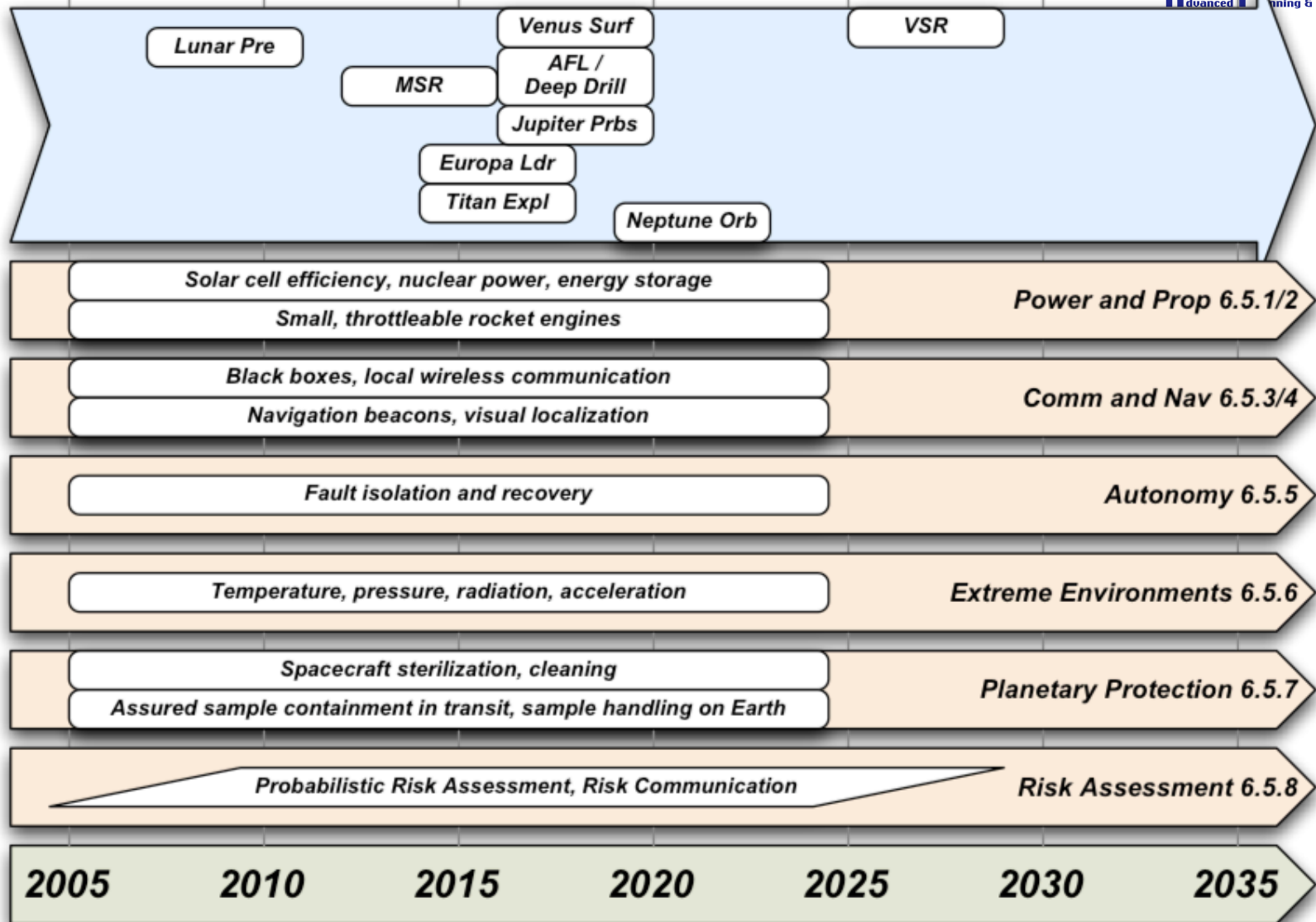



6.5.1 Solar Power



- **Develop crystalline cells with efficiency $\geq 45\%$, thin-film cells with efficiency $\geq 15\%$ for longer mission durations**
- **Status: Triple junction crystalline cells limited to 27% efficiency, thin film cells $<10\%$; no dust mitigation**
- **Metrics: efficiency, output degradation, mass**
- **Resources: Plum Brook Testing Facility**
- **Needed for: small Mars landers**
- ***Power and Propulsion CRM should cover***



6.5.1 Radioisotope Power



- **Develop small (~1-10 We) radioisotope power systems for small spacecraft and planetary surface missions, use in hard landers**
- **Status: Current systems have ≥ 100 We output and mass ≥ 20 kg**
- **Metrics: Power output, mass, impact G survival**
- **Needed for: small, long-life landers at any body, surface network missions**
- ***Power and Propulsion CRM should cover***



6.5.1 Power Storage



- **Develop primary (non-rechargeable) power storage with energy densities ≥ 500 W-hr/kg; secondary (rechargeable) energy density ≥ 200 W-hr/kg**
- **Status: primary energy density is 250 W-hr/kg; secondary is 90 W-hr/kg. Other advanced technologies have been infrequently utilized.**
- **Metrics: Energy density; safety**
- **Enhancing for all missions**
- ***Power and Propulsion CRM should cover***



6.5.2 ISRU-based Mobility



- **Develop capabilities for using propellants produced in situ from local resources for local transport**
- **Status: No existing capability**
- **Metrics: transport system mass vs. range**
- **Needed for multiple sorties of very long range on any body**



6.5.2 Chemical Propulsion



- **Develop small throttleable rocket engines for sample return ascent**
- **Status: Throttleable rocket systems have been used (Surveyor, Viking), but capability needs to be rebuilt, non-trivial development**
- **Metrics: maximum thrust, Isp, minimum thrust fraction**
- **Needed for: Mars, Venus Sample Return**
- ***In Space Transportation CRM should cover***



6.5.3 Wireless Telecom



- **Develop high-data-rate wireless communication through liquid and solid materials to enable exploration of extremely remote regions**
- **Status: ELF (80Hz) to LF (100kHz) and blue-green laser communication used with submarines; seismic or acoustic communication is possible in solid media**
- **Metrics: Depth of transmission; data rates**
- **Needed for: deep subsurface/ice missions at Mars or Europa**



6.5.3 Black Box



- **Develop robust, survivable onboard data storage and playback for post-mission data delivery to avoid data loss (black box)**
 - Depending on the application, a challenge will be how to communicate through wreckage or extract self from wreckage
- **Status: Aircraft use robust black boxes; no dedicated data relay subsystems available for space mission planners**
- **Metrics: G-level endurance, data storage; data return bandwidth, mass**
- **Enhancing for aerial missions without landing capability, failure diagnosis for landed missions**



6.5.4 Navigation Beacons



- **Develop high precision (10 cm, 1 degree), low mass, short range (~ 100 km) navigation beacons that offer both range and bearing information**
- **Status: Radio beacons and VHF Nav Systems (VOR) used terrestrially to provide both range and bearing information. ~15 nautical mile range**
- **Metrics: range and bearing precision, beacon mass/operational range, required power, lifetime**
- **Enhancing for landed missions returning to the same site, e.g. surface rendezvous MSR**



6.5.5 Autonomous Localization



- **Develop autonomous localization capability using locally-sensed surface features, thus reducing mission infrastructure requirements**
- **Status: Localizing current rover systems requires significant interaction with ground controllers, reducing mission throughput**
- **Metrics: Location estimation accuracy, time**
- **Enhancing for all mobile surface and aerial missions**
- ***Autonomous Systems and Robotics CRM should cover***



6.5.5 Autonomous Fault Handling



- **Develop Capabilities for On-Board Autonomous Fault Detection, Isolation, and Recovery**
- **Status: Current systems require either interaction with ground controllers or react in a pre-scripted manner**
- **Metrics: Percentage of S/C faults addressable through autonomous FDIR**
- **Enhancing for all missions**
- ***Autonomous Systems and Robotics CRM should cover***



6.5.6 Extreme Temp. Components



- **Develop actuators and avionics capable of operating under extreme temperatures to enable missions in extreme temperatures (down to -270C or up to +460C)**
- **Status: Most ruggedized components are suitable for MIL-SPEC temperature range of -40 to +85°C, which is unsuitable for most planetary applications.**
- **Metrics: Flight-allowable storage and operating temperature ranges, lifetime**
- **Needed for: Venus Surface Explorer, Venus Sample Return, Titan Explorer, Jupiter Probes**



6.5.6 Extreme G Avionics



- **Develop avionics capable of operating under extreme (1,000 G to 100,000 G) deceleration levels, to enable penetrator missions for subsurface access**
- **Status: Avionics ruggedness is generally limited to 10s or 100s of Gs; Some high-G DoD applications**
- **Metrics: survivable acceleration levels and profiles**
- **Needed for: Jupiter Atmospheric Probes, Penetrators**



6.5.6 High Radiation Avionics



- **Develop avionics capable of operating in extreme radiation environments (> 180 krad/day) to enable Jupiter atmospheric probe and icy moon missions**
- **Status: Radiation-rugged COTS devices exist, but are typically for nuclear events, not total dose**
- **Metrics: total dose storage survival, total dose operating survival, error-free operation dose rate**
- **Needed for: Jupiter Atmospheric Probes, Europa Lander**



6.5.6 Extreme Pressure Avionics



- **Develop avionics capable of operating under extreme (>100 bar) pressure to enable long-duration missions, such as probes, to planets with high atmospheric pressure**
- **Status: Significant technology available for terrestrial applications (e.g., oil exploration); limited space flight qualification**
- **Metrics: Pressure, temperature tolerance, lifetime, mass**
- **Needed for: Venus Surface Explorer, Jupiter Atmospheric Probes, Venus Sample Return**



6.5.7 Spacecraft Sterilization



- **Develop Forward Planetary Protection Capabilities for Whole-Spacecraft Sterilization and Cleaning**
- **Status: Viking-level capability decommissioned. New facility must account for sensitive avionics and instruments**
- **Metrics: Spacecraft size; spores or bio-remnants per unit area; decades of reduction, cost impact to spacecraft to use components qualified to the process**
- **Resources: Whole-Spacecraft Sterilization Facility**
- **Needed for: Mars Sample Return, Mars AFL/Deep Drill, Europa Lander**
- **Cost: \$15M for selective cleaning and transport analysis approach, if viable. If not, \$60M for whole-spacecraft sterilization process qualification and facility**



6.5.7 Assured Containment



- **Develop back planetary protection capabilities for assured containment of returned samples ($\leq 10E-6$ loss of containment risk) to enable sample return missions**
- **Status: Technology development underway; not yet flight qualified**
- **Metrics: Probability of containment loss**
- **Needed for: Mars Sample Return, other Class V return missions**
- **Cost: \$46M technology development + > \$20M Earth Entry vehicle flight test**



6.5.7 Returned Sample Handling



- **Multidirectional containment/contamination control for returned samples to permit returned sample analysis and to prevent sample contamination**
- **Status: Limited technology development underway for clean sample handling; Sample Receiving Facility (SRF) architecture design, etc.**
- **Resources: Sample Receiving Facility**
- **Needed for: Mars Sample Return, other Class V return missions**
- **Cost: \$120M for basic capabilities and facility, another \$240M for outfitting facility with instruments, facility operations, and separate curation facility and its operations (within 30%)**



6.5.8 Thermal Control



- **Increase capability for insulation and active thermal control (heating) for missions to cold environments; temperature tolerance and heat rejection (cooling) for missions to hot environments**
- **Status: Limited capability for Mars missions - inefficiency drives large power requirement**
- **Metrics: Heat transfer, heat rejection**
- **Needed for: Venus Surface Explorer, Mars Sample Return, Astrobiology Field Lab, Europa Lander**



6.5.9 Risk Assessment



- **Increase capability in risk assessment to permit more rigorous, consistent design trades**
- **Status: Probabilistic Risk Analysis, experience, and other methods are used in projects**
- **Metrics: Statistical accuracy and consistency of risk assessments across projects**
- **Resources: Expertise spread across academia, industry and NASA**
- **Needed for: All missions**
- ***Systems Engineering CRM should cover***



Facilities





Required Resources (Facilities and Human Capital)



- **Robotic access technology development and flight system qualification requires access to numerous unique facilities across the country as well as support of the resident engineering talent that has honed a unique skill set.**
- **A small set of facilities exist which are vital for RAPS applications.**
- **Most of these same facilities also have direct application to the Human Planetary Landing Systems Capability Roadmap #7.**



Required Resources (Facilities and Human Capital)



- **No ground-based facility exactly replicates high energy flight conditions. Instead, individual facilities have been developed that replicate a particular aspect of hypervelocity flight.**
- **When combined with analysis and flight test capabilities (e.g., sub-orbital balloon and sounding rocket programs), these ground-based facilities anchor robotic access technology development and flight system qualification.**



Ground-Based Facility Type and Use (1 of 6)



- **Wind-tunnels** achieve fluid dynamic similarity to flight. These facilities are used to obtain aerodynamics across a large range of relevant Mach number regimes, patterns of heating to the vehicle, and the behavior of transition to turbulence for the specific vehicle shape. Because these facilities do not replicate the energy of the flow, flight heat transfer conditions are not obtained.

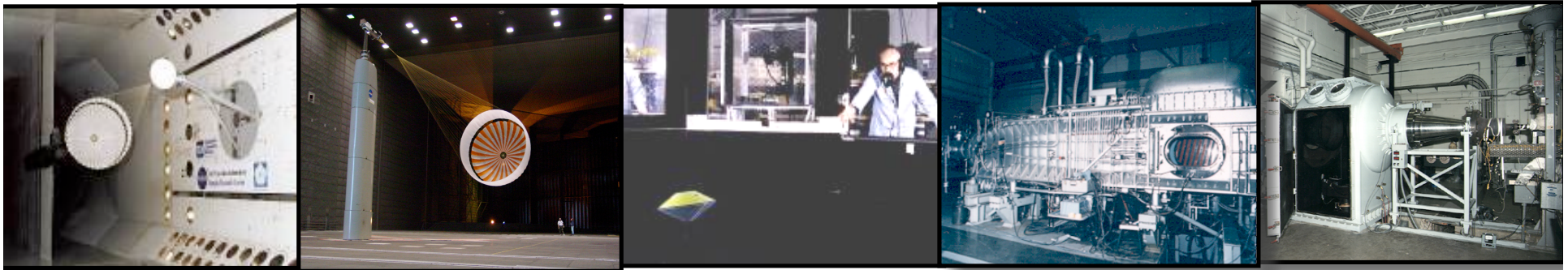

- Subscale parachute testing in the LaRC TDT
- Full scale parachute testing in the Ames NFAC
- Entry stability testing in the LaRC VST
- Entry system aerodynamic characterization in the LaRC Aerothermodynamics Complex (2)



Ground-Based Facility Type and Use (2 of 6)



- **Arc-jets** are used to understand thermal protection system response during hypersonic entry. These facilities can deliver flight-like heat rate, temperature, heat load, and shear to a test sample. In this manner, the thermal response of flight hardware can be determined.

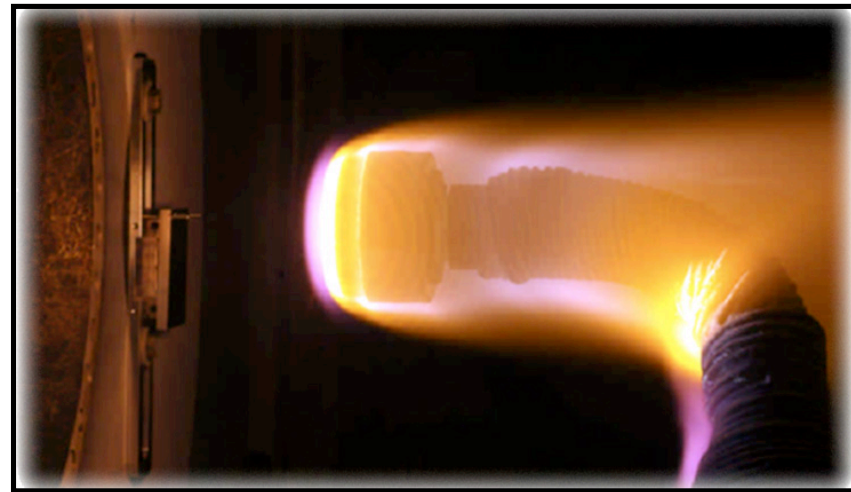

- The existing ARC facilities are required for qualification of Mars entry and Earth return thermal protection systems. For missions to the gas giants, the Giant Planet Facility, a leg on the ARC arc-jet complex which is no longer operational would need to be refurbished.



Ground-Based Facility Type and Use (3 of 6)



- **Ballistic range** facilities operate by firing a small projectile into a test chamber. Such testing is useful for determining aerodynamic stability and transition characteristics.

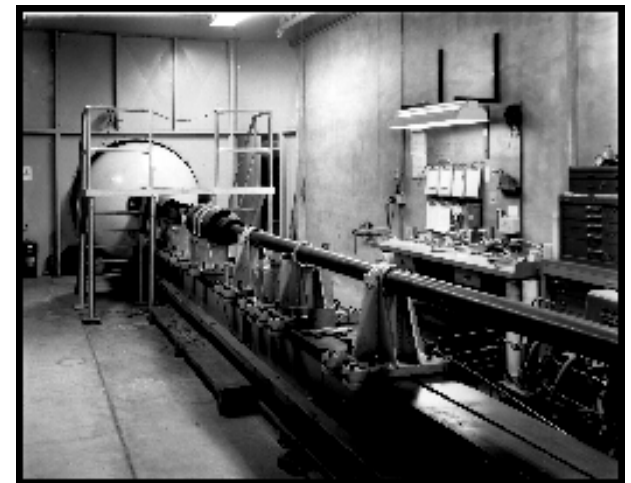
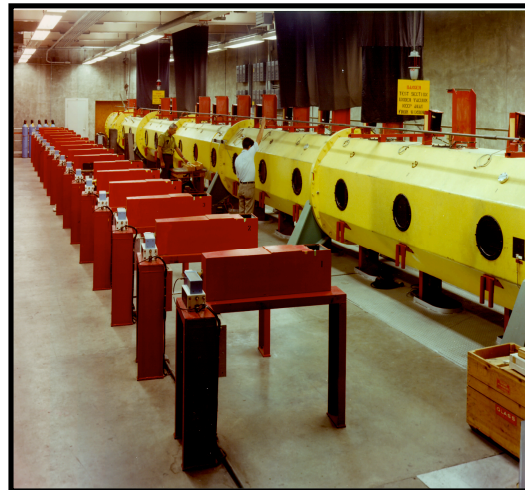
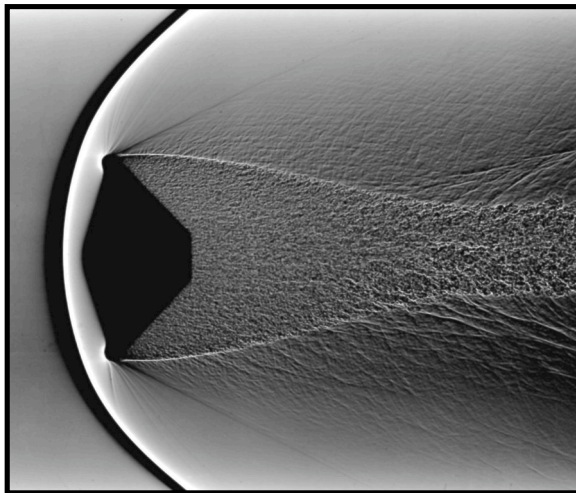

- The Eglin AFB ballistic range is typically used by current robotic Mars and Earth programs. The ARC ballistic range offers the advantage of controlling the gas composition and pressure, albeit for smaller models.



Ground-Based Facility Type and Use (4 of 6)



- **Shock tunnels** can combine fluid dynamic and energy similarity in some cases.

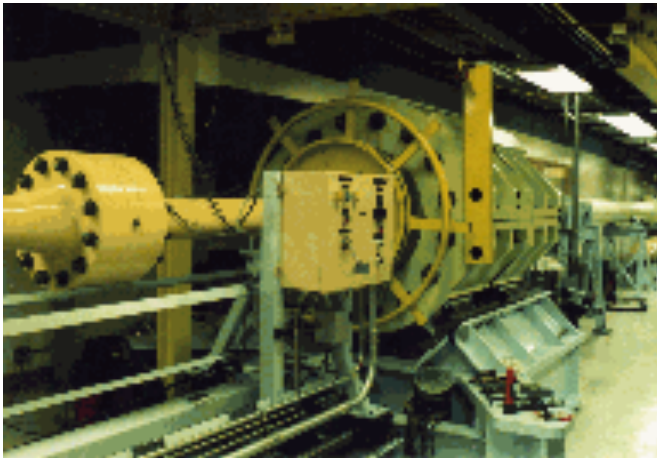

- The T5 facility at Cal Tech and LENS at University of Buffalo Research Center can be used to understand hypersonic convective heating and transition to turbulence.



Ground-Based Facility Type and Use (5 of 6)



- **Shock Tubes** are used to understand the high temperature atomic, chemical kinetic, and gas dynamic behavior of the atmospheric gases at high temperature, which is essential for shock layer radiation modeling.

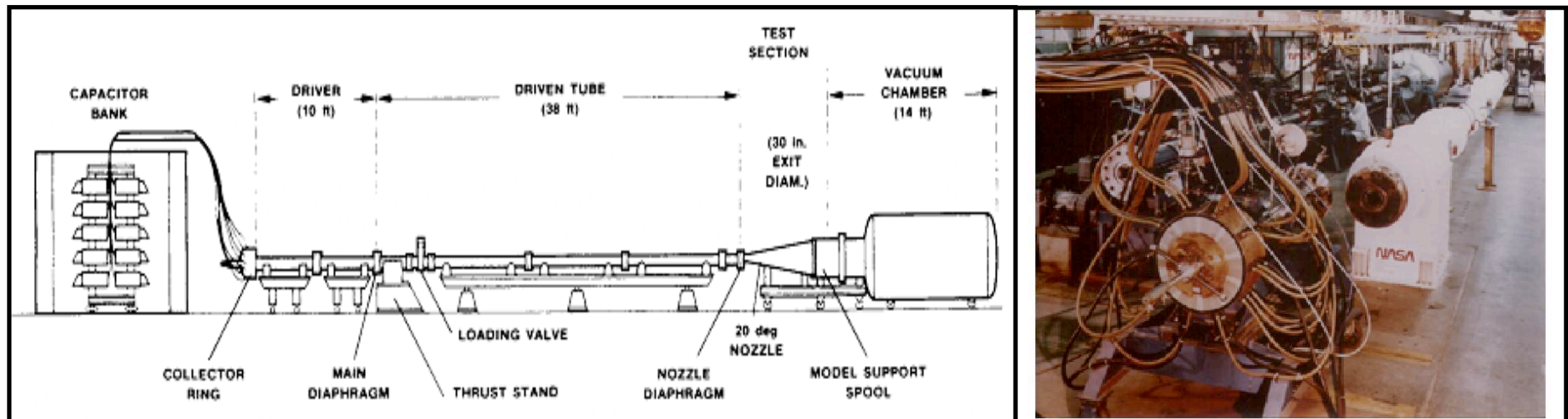

- The ARC Electric-Arc Driven Shock Tube is the sole remaining facility of its kind in NASA.



Ground-Based Facility Type and Use (6 of 6)



- **Relevant Environment Structural Test Facilities** are used to replicate the relevant environment for structural design and qualification

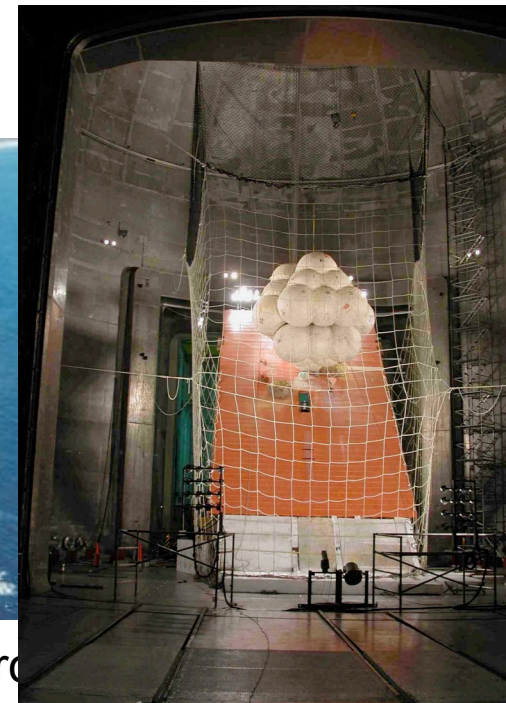

- The National Science Balloon Facility, WFF Sounding Program, and the Large Space Environment Vacuum Chamber are unique national assets.



National Aerothermodynamic Capabilities



National Aerothermodynamic Capabilities

- NASA Centers with Aerothermodynamic Ground Test or Flight Test Capabilities
- AEDC Aerothermodynamic Facilities
- Non-governmental organizations with Aerothermodynamic capabilities

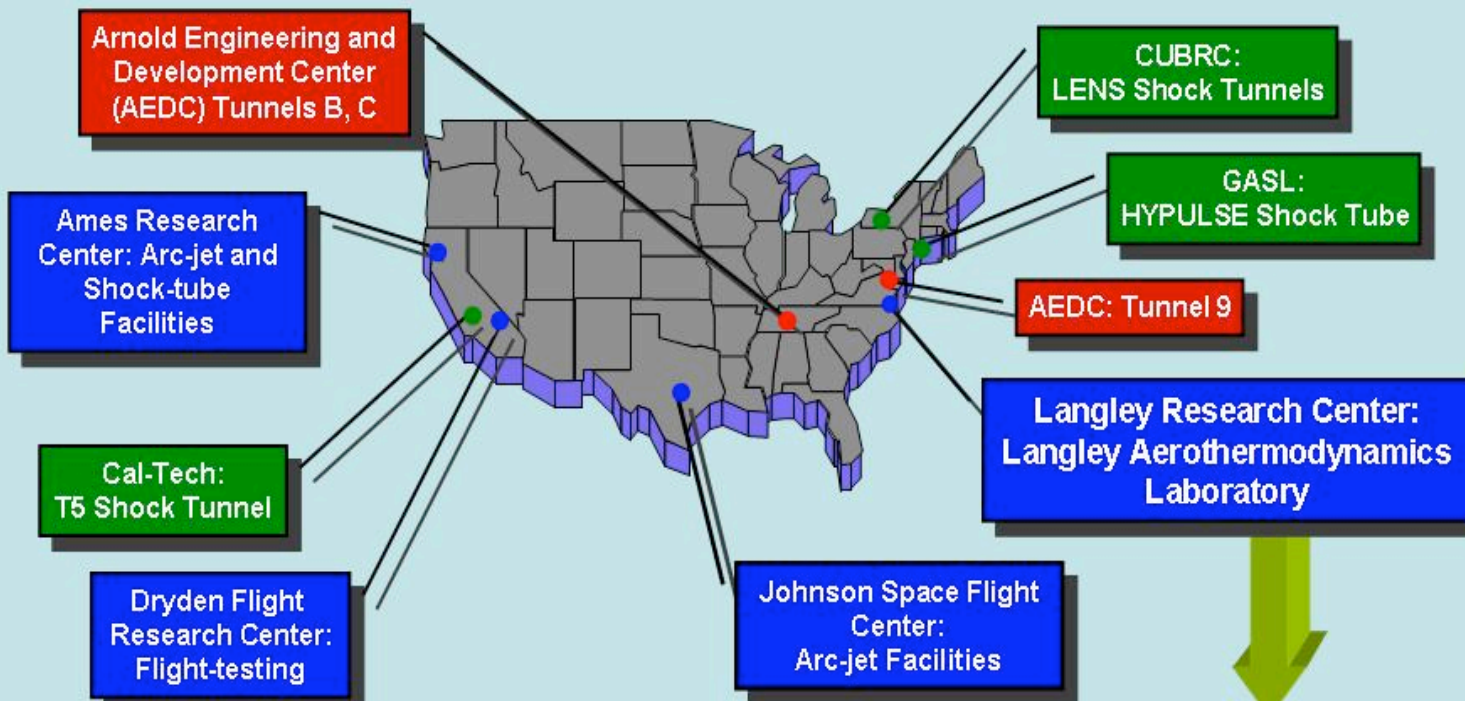



Required RAPS Ground-Based Facilities (1 of 2)



Facility	Location	Role
Aerothermodynamics Complex	NASA LaRC	Understanding hypersonic aerodynamics and convective heating, including transition to turbulence
Aeroballistic Research Facility	Eglin AFB	Gather free-flight aerodynamic data using shadowgraph and laser interferometry
Arc-Jet Test Facility	NASA ARC	Development and qualification of TPS under flight-like thermo-structural conditions.
Transonic Dynamics Tunnel (TDT)	NASA LaRC	Perform sub-scale developmental testing of supersonic decelerators and planetary aerial platforms in relevant conditions
National Full-scale Aerodynamics Complex (NFAC)	NASA ARC	Perform full-scale load testing at representative loads and Reynolds number for Mars & Titan supersonic decelerators and full-scale testing of Mars airplane propeller drive systems.
National Science Balloon Facility (NSBF)	NASA WFF (Palestine TX)	Perform high altitude balloon drop testing essential for scaled flight testing at relevant conditions (Mach and Reynolds Number) for supersonic decelerators. NASA suborbital balloon and sounding rocket programs mitigate risk for planetary aerial platforms.



Required RAPS Ground-Based Facilities



Facility	Location	Role
Plum Brook Facility (Vacuum Chamber)	NASA GRC	Allow full-scale testing of landing systems at Mars surface pressures. Allows scale testing of balloons and airships at representative (Mars and high-altitude Venus) pressures.
Vertical Spin Tunnel	NASA LaRC	Perform sub-scale testing of entry systems and planetary aerial platforms to investigate subsonic stability characteristics.
T5 facility	Cal Tech	Understand hypervelocity convective heating, including transition to turbulence
LENS	CUBRC	Understand hypervelocity convective heating, including transition to turbulence
Ballistic Range	NASA ARC	Gather free-flight aerodynamic data using shadowgraph and laser interferometry. Quantifying transition effectiveness of ablated materials.
Electric-Arc Driven Shock Tube	NASA ARC	Understand the high temperature atomic, chemical kinetic, and gas dynamic behavior of the atmospheric gases at high temperature for developing radiative heating models.
Arc-Jet Test Facility	NASA JSC	Development and qualification of TPS under flight-like thermo-structural conditions.



Facility Costs



- **Facility cost information can be obtained from the appropriate point-of-contact at each facility**
- **Because of the range of cost assumptions in use by these facilities, cost information is not provided herein**
- **Additional information on these and other test facilities can be obtained at:**
 - <http://wte.larc.nasa.gov/>
 - <http://facility.hq.nasa.gov/>
- **Recommendation: NASA should form a test facilities team to develop a uniform cost basis for these facilities. Because of the critical nature of the test facilities and the resident expertise, this cost information is vital for planning RAPS (and other Capability Roadmap) technology development.**



Wrap-Up





Long-Term Breakthrough Concepts



- **We identified some ideas not included in the roadmap, but worthy of system studies:**
 - **Micro-probes system design (incorporating high-G, small RPS capabilities outlined here)**
 - **Lightweight, low-power, high-capacity, reconfigurable avionics**
 - **High-capability Tele-operated Robotic Explorers for Mars with Virtual Presence (for global Mars access by human explorers)**
 - **Melter/Drill for Mars and Europa**
 - **Swimmer for Europa**



Conclusions (6.1, 6.4)



- **The capabilities for entry, descent, and landing are complex and interrelated at the system level, and will require significant coordination as mission plans change, including the coordination of developments between robotic and human planetary landing systems**
- **Small landers can be enabled with high-G systems and small nuclear power sources, to permit consideration of networks of landers**
- **A modest amount of Earth testing of aerial systems as part of an organized program can open up new ways to take advantage of planetary atmospheres for regional and global observation**
- **EDL and aerial vehicle development depend heavily on NASA test infrastructure and expertise — special attention is needed to determine how to maintain that infrastructure and develop new infrastructure, and how that will be funded**



Conclusions (6.1, 6.4 cont'd)



- **For both landed and aerial missions, precursor environmental observations will enhance and possibly enable the design and test of viable systems for those environments. The performance of systems in those environments need to be well-characterized to reduce risk for subsequent missions.**
 - **This must be considered at the program level so that instrumentation for these purposes can be incorporated in orbiters and landers, and so that requirements can be imposed for performance measurements of key systems so that each mission can feed into the next**
 - **Analogous to the telecomm infrastructure, we need a sustained Mars atmosphere observation infrastructure**
 - **These objectives should be balanced against the design margin alternatives to reduced uncertainty**



Conclusions (6.2, 6.3)



- **New surface mobility systems should be developed to access difficult and treacherous terrain, and would need to be coordinated with developments for human exploration robotic assistants – this long-term investment will enable a new class of missions not currently envisioned**
- **Sampling capabilities will initially be driven and developed by missions. However, deep drilling and down-hole instrumentation will require considerable development and demonstration before mission applications can be considered**



Conclusions (6.5)



- **Radioisotope power systems need to be scaled down in size for use in small systems – rovers, ground penetrators, etc.**
- **Extreme environment systems are essential for the envisioned strategic missions, yet there is no comprehensive program in place to develop them. An organization needs to be assigned this task, and the system engineering trades performed for these missions to define the requirements**
- **More robust means of communication are required – to provide data from, e.g., post-landing events, deep subsurface (liquid and solid)**
- **New degrees of contamination control for both science and planetary protection is required for life-detection missions (e.g. MSR), but is currently at a low capability level**
- **Assured containment may be the single most vexing requirement Mars Sample Return faces, for which a chain of events can all be drivers, and for which most have no qualified capabilities at this time**



Summary



- **A set of robotic access to planetary surfaces capability developments and supporting infrastructure have been identified**
 - Reference mission pulls derived from ongoing strategic planning
 - Capability pushes to enable broader mission considerations
 - Facility and flight test capability needs
- **Those developments have been described to the level of detail needed for high-level planning**
 - Content and approach
 - Readiness and metrics
 - Rough schedule and cost
 - Connectivity to mission concepts



Review Objectives



- 1. Are the products connected in a logical progression and are they linked to credible missions or mission classes?**
- 2. Was the proper set of capabilities identified to address the mission needs? Are there any alternative approaches that were not considered?**
- 3. Does the capability roadmap provide a clear pathway to (or process for) technology and capability development?**
- 4. Are technology development decision points identified, described and justified?**
- 5. Does the roadmap describe competently the products planned for the technology development? Is the roadmap written and presented in a manner understandable to the non-specialist?**
- 6. Are proper metrics for measuring the advancement of technical maturity included?**
- 7. Is there a clear and correct understanding of the technical risks, 1/2 order of magnitude costs, and schedule estimates to within a year?**