

Kelly Bunzeluk
Ruey Chao
Julien Coyne
Hervé Denoual
Serina Diniega
Cari Goulard
Margot Hair
Alexander Ivanov
Munir Jojo Verge
Jaffer Khan
Michael Klicker
Oliver Laughton
Juan Merino
Gilbert Nesamani
Gregory Ott
Dawn Owens
Nicolas Parent
Bhavini Patel
Dinesh Patel
Chris Roden
Elizabeth Rogers
Elias Roussos
Bhalamurugan Sivaraman
Nicholas Skytland
Douglas Smith
René Steiner
Oliver Teynor
Esa Vilenius
David Vivanco



HUMAN MISSIONS TO EUROPA AND TITAN - WHY NOT?

FINAL REPORT

MSS '04

HUMAN MISSIONS TO EUROPA AND TITAN — WHY NOT?



FINAL REPORT

Human Missions to Europa and Titan — Why Not?

Student Team Project Final Report

April, 2004



International Space University

Master of Space Studies 2004

© International Space University. All Rights Reserved.

The 2003/2004 Master of Space Studies Team Project work was conducted at the ISU Strasbourg Central Campus.

Cover description: One man, Theseus, represents the unified strength of our team and our ability to draw upon our collective resources to overcome the labyrinth of barriers standing in our path. Upon his shoulders rests the weight of the worlds of Europa and Titan, illustrating the magnitude of the task set before us — that of enabling a human mission to Europa and Titan — and the literal destination of our endeavour. The orbital band encircling the entirety of the moons represents both the physical journey and the metaphorical path we have taken in producing our report.

Additional copies of the Executive Summary and the Report may be ordered from the International Space University Headquarters.



**International Space University
Strasbourg Central Campus
Attention: Publications/Library
Parc d'Innovation
1 rue Jean-Dominique Cassini
67400 Illkirch-Graffenstaden
France**

Publications:

Tel. +33 (0)3 88 65 54 32

Fax +33 (0)3 88 65 54 47

E-mail: publications@isu.isunet.edu

The Executive Summary, information on how to order a Report, and an order form may also be found on the ISU web site at <http://www.isunet.edu>.

In acknowledgement of NASA's sponsorship and its continued dedication to human spaceflight exploration. Building the bridge of international cooperation, we build on the strengths and skills of all of our representative nations as we map our path to the stars.



This project is dedicated to all space explorers past, present and future.
To those who have gone ahead, paving a pathway to the stars,
To those who have made the ultimate sacrifice,
To those not yet born and their bright futures unknown,
And to all who dream...

Acknowledgements

The members of TP2: Theseus would like to express their sincere gratitude by gratefully acknowledging the assistance of those who donated their invaluable time and expertise, and in doing so, contributed to the success of this report.

ISU FACULTY ADVISOR

Hugh HILL

ISU RESIDENT FACULTY

Philippe ACHILLEAS

John FARROW

Tetsuichi ITO

Walter PEETERS

Isabelle SCHOLL

Nikolai TOLYARENKO

SPONSOR

National Aeronautics and Space Administration (NASA)

INDIVIDUALS

Oleg ATKOV	<i>Russian State Medical University</i>
James BURKE	<i>NASA Jet Propulsion Laboratory</i>
James DATOR	<i>University of Hawaii</i>
Theodore W. HALL	<i>Chinese University of Hong Kong</i>
Nick KANAS	<i>Human Interactions in Space</i>
Jean-Pierre LEBRETON	<i>ESA</i>
John LOGSDON	<i>George Washington University</i>
Chris MCKAY	<i>NASA Ames Research Center</i>
Irina NELSON	<i>NASA Academy, Goddard Space Flight Center</i>
Nicolas PETER	<i>International Space University</i>
Philip Petit HUMAN	<i>Interactions in Space</i>
Muriel RIESTER	<i>International Space University</i>
Christopher RUSSELL	<i>University of California</i>
Michael RYCROFT	<i>International Space University</i>
Brant SPONBERG	<i>NASA Headquarters</i>
Harley THRONSON	<i>NASA Headquarters</i>
Sylvia VIVANCO	<i>Freelance Graphic Designer</i>
Robert WINGLEE	<i>University of Washington</i>
Tyler WOODBURN	<i>University of Victoria</i>

Kelly BUNZELUK		Canada
Ruey CHAO		Canada
Julien COYNE		France
Hervé DENOUAL		France
Serina DINIEGA		USA
Cari GOULARD		USA
Margot HAIR		USA
Alexander IVANOV		Belarus
Munir JOJO VERGE		Spain
Jaffer Ali KHAN		France
Michael KLICKER		Austria/Germany
Oliver LAUGHTON		UK
Juan MERINO		Spain
Gilbert NESAMANI		India
Grégory OTT		France
Dawn Brooke OWENS		USA
Nicolas PARENT		France
Bhavini PATEL		UK
Dinesh PATEL		UK
Chris RODEN		USA
Elizabeth ROGERS		Canada/UK
Elias ROUSSOS		Greece
Bhalamurugan SIVARAMAN		India
Nicholas SKYTLAND		USA
Douglas SMITH		UK
René J. STEINER		Austria
Oliver TEYNOR		Germany
Esa VILENIUS		Finland
David VIVANCO		Spain

Abstract

This report describes a long-term development plan to enable human exploration of the outer solar system, with a focus on Europa and Titan. These are two of the most interesting moons of Jupiter and Saturn, respectively, because they are the places in the solar system with the greatest potential for harboring extraterrestrial life. Since human expeditions to these worlds are considered impossible with current capabilities, the proposal of a well-organized sequence of steps towards making this a reality was formulated. The proposed Development Plan, entitled Theseus, is the outcome of a recent multinational study by a group of students in the framework of the Master of Space Studies (MSS) 2004 course at the International Space University (ISU). The Theseus Program includes the necessary development strategies in key scientific and technological areas that are essential for identifying the requirements for the exploration of the outer planetary moons. Some of the topics that are analysed throughout the plan include: scientific observations at Europa and Titan, advanced propulsion and nuclear power systems, in-situ resource utilization, radiation mitigation techniques, closed life support systems, habitation for long-term spaceflight, and artificial gravity. In addition to the scientific and technological aspects of the Theseus Program, it was recognized that before any research and development work may begin, some level of program management must be established. Within this chapter, legal issues, national and international policy, motivation, organization and management, economic considerations, outreach, education, ethics, and social implications are all considered with respect to four possible future scenarios which enable human missions to the outer solar system. The final chapter of the report builds upon the foundations set by Theseus through a case study. This study illustrates how such accomplishments could influence a mission to Europa to search for evidence of life in its subsurface oceans. The future remains unpredictable, as does the realization of any of these possibilities. However, projects such as this remind us that the final frontier for humans is truly outer space, and only our imagination will determine where the frontier stops. We can dream of visiting other planetary systems and perhaps even galaxies, but we must begin closer, and considering the scope of our known universe, Europa and Titan are very close indeed.

Faculty Preface

Some anonymous wag once defined an expert as: "One who travels a long distance and shows slides." This definition is inadequate in the context of the members of our Team Project 2 (TP2): "Human Missions To Europa and Titan - Why Not?". It is true that the twenty-nine men and women have come to study at ISU from far and wide. However, their expertise and knowledge of their chosen TP far exceeds the ability to show a few slides as part of a magic lantern show. At the close of TP2, the group has gained a mature, interdisciplinary appreciation of the profound problems associated with a human mission to the outer solar system.

Europa and Titan are of unique importance in the solar system as they harbour chemical compounds associated with the origin of life. By studying these icy moons, we can gain insight into the origin of life on Earth and elsewhere in the cosmos. However, a human mission to Europa and Titan is impossible with today's technology. But would such a mission be possible in fifty years? If so, how does one develop a plan for such a mammoth venture? To their credit, TP2 has produced what could be described as, "a classic ISU TP". They have wrestled with this complex project and have been cognisant of the University's famous '3I' credo: Interdisciplinary, International, Intercultural. This report presents an original Development Plan to enable human exploration of the outer solar system. They have identified technological and other important topics that have been neglected in previous studies by space agencies and academics. Finally, the Team presents a novel Case Study describing a complete human mission to Europa.

While the final ISU TP reports and presentations are expected to be scholarly and comprehensive, it is worth remembering all such ventures are, first and foremost, exercises in interdisciplinary, international, and intercultural teamwork. As any 'survivor' of an ISU TP can tell you, this is extremely challenging! It is taxing as one must work with a veritable spectrum of teammates. However, if one is open-minded and willing to learn, the overall experience can be precious.

It just remains for me to congratulate TP2 for their solid work and their commitment to the team spirit.

Associate Professor Hugh Hill on behalf of the Resident Faculty.

Student Preface

People explore. It is a desire inherent in our blood. For example, if you are like the members of our University, you travel halfway around the world to study in an international and interdisciplinary environment. Of course, this is not where the journey ends. We choose to continue exploring. We choose to expand our understanding and discover the foreign worlds of Europa and Titan.

This report is our contribution toward achieving these goals. Twenty-nine students from eleven different countries have participated in building the foundations for making this dream a reality. The Development Plan proposed herein begins today and outlines a series of milestones that must be accomplished before we can safely send humans to the outer reaches of our solar system. It includes not only technical and scientific aspects, but also considers the legal, socioeconomic, and political contexts.

We are proud to offer this report of our vision, which is the culmination of months of teamwork, group discussions, meetings, and battles. We hope that our work will motivate all those who share a similar desire to explore.

*The ones who are crazy enough to
think they can change the world are
the ones who do.*

Anonymous

Contents

1. Introduction	1
2. Requirements	3
2.1. Introduction	3
2.2. Technology	3
2.3. Science Priorities	6
2.4. Space Life Sciences	10
2.5. Conclusion	12
3. Theseus: A Road Map for Technological and Scientific Issues	13
3.1. Introduction	13
3.2. Theseus Program Overview	13
3.3. Accomplishments	17
3.4. Additional Technologies	45
3.5. Conclusion	48
4. Theseus: Program Management	51
4.1. Introduction	51
4.2. Legal Issues	53
4.3. Possible Future Scenarios	55
4.4. Outreach and Education	71
4.5. Ethics and Social Implications	74
4.6. Cost of the Development Plan	75
4.7. Conclusion	77
5. Case Study: Mission to Europa To Trace for Life's Existence (METTLE)	81
5.1. Introduction	81
5.2. Spacecraft Design	83
5.3. Preparation for METTLE	87
5.4. METTLE: Mission to Europa to Trace Life's Existence	89
5.5. Conclusion	103
6. Conclusions	107
A. Ice Penetration Calculation	109

B. Advanced Mission Cost Model: Input Description and Results for Jovian Missions	111
C. Acronyms and Abbreviations	115
Bibliography	119

List of Figures

2.1. Escape Velocities at Saturn and Jupiter.	4
2.2. Europa's Surface.	7
2.3. Titan seen by Voyager 1.	8
2.4. Relative temperature and radiation conditions.	12
3.1. Chart of the road map.	16
3.2. Proposed design for a Mars aerial explorer (Entomopter).	22
3.3. A cutaway of the proposed VASIMR design.	26
3.4. Flow chart describing the development of propulsion technology.	27
3.5. Basic steps in order to utilize nuclear power systems.	28
3.6. Technology road map for ISRU and drilling.	30
3.7. Schematic of the MELiSSA loop.	32
3.8. Closed ECLSS, artificial gravity and the Habitation Module development.	33
3.9. Short radius centrifugation.	34
3.10. Different approaches to provide artificial gravity.	35
3.11. The proposed design for the Transhab.	38
3.12. Deflection of the solar wind by a dipole.	42
3.13. Strategy for radiation shielding	43
3.14. The cutaway of a supposed cylindrical module.	43
3.15. A robotic 'mule'.	46
3.16. The Energia-2 concept	48
4.1. ISS Schematic	60
4.2. Organizational chart of FEOM	62
4.3. Schematic showing a possible international outreach program.	73
5.1. Spacecraft design.	82
5.2. Spacecraft design.	83
5.3. Crew quarters.	85
5.4. Habitat Ring Dimensions.	85
5.5. Fitness module.	86
5.6. Transfer to Jupiter.	89
5.7. Return from Jupiter.	90
5.8. Medical care module.	91
5.9. Hydroponic space of the spacecraft	92

5.10. Maintenance Robot Assistant.	94
5.11. Submarine for subsurface activities.	96
5.12. The descent vehicle with submarine.	98
5.13. Separation of submarine for ascent.	99
5.14. Communication architecture for subsurface activities.	99
5.15. Melting time.	100
5.16. Hydrothermal vent.	102
5.17. Hydrobot design for European subsurface activities.	103
5.18. Communication architecture.	103

List of Tables

3.1. Options for different propulsion systems.	23
3.2. Comparison between VASIMR and MPD.	25
3.3. Different solutions to provide artificial gravity.	36
4.1. Summary of possible future scenarios.	56
4.2. Advantages and barriers of international cooperation.	59
4.3. Advantages and disadvantages of worldwide collaboration.	63
4.4. Cost estimations for major technological projects.	78
5.1. Mass breakdown of the suggested spacecraft design.	84
5.2. Technologies incorporated from the Theseus Program.	104
B.1. Cost estimation for Theseus' mission to Jupiter.	113

As for the future, your task is not to foresee it, but to enable it.

Antoine de Saint-Exupery

1. Introduction

Over the past thirty years, there has been a notable lack of consensus among members of the scientific, technical, and political communities regarding the meaning and direction of space programs. This deficiency has hindered progress and damaged public trust, resulting in a human exploration program trapped under a 400-kilometer ceiling. In addition, a lack of clear and compelling mission plans have made it difficult to raise resources for human space exploration. This strain on key players due to shifting resources and inconsistent support can sometimes result in fatal outcomes, the most recent example being that of NASA's Space Shuttle *Columbia* tragedy on February 1, 2003. Similar to the earlier Space Shuttle *Challenger* disaster in which launch limits were exceeded yet ignored, the *Columbia* accident was the result of years of increased constraints on resources, fluctuating priorities, schedule pressures, and lack of a common vision for human spaceflight (Columbia Accident Investigation Board, 2003).

Now, however, governments and space agencies are beginning to look beyond Low Earth Orbit (LEO) and are working together to face the challenge of putting humans onto other planetary bodies. Last October, China became the third country to send a human into space and has revealed plans to put taikonauts onto the Moon. Since 2001, ESA has been working toward the Aurora Programme, a long-term plan for implementing robotic and human exploration of the solar system, with particular focus on bodies that potentially have past or current evidence of life (European Space Agency, 2004). At the beginning of this year, US President Bush announced a new vision for NASA, involving the development of a long-term human and robotic program to explore the solar system, beginning with a return to the Moon and enabling future exploration of Mars (NASA, 2004b).

Hopefully, these enterprising ideas will help end the impasse of past decades by establishing new objectives within clearly stated priorities and boundaries. More importantly, despite increased mission complexity, cost, and risk due to the inclusion of humans, these new visions satisfy both the pursuit of scientific knowledge and the inherent human need to explore. Thus, they provide some of the background and guiding framework for our answer to the challenge: *Human Missions to Europa and Titan — Why Not?*

Our team, composed of twenty-nine students from eleven countries, began with identifying the main obstacles of a mission to Europa and Titan. This led to a definition of the necessary requirements that need to occur if humans are to move from the current scientific, technical, societal, and political environment to one in which a human mission to the outer solar system is possible. After analyzing these milestones, the Theseus Program (also referred to as the 'Development Plan') was created to enable such a future. It is divided into two parts: a

1. Introduction

roadmap involving space- and ground-based research as well as precursor missions, and program scenarios encompassing possible visions of the future that would enable the creation of supportive political and economic infrastructures. Finally, a sample mission to Europa is outlined, building upon the multidisciplinary foundations created through the Development Plan. This mission provides an illustration of how the results of our roadmap and scenarios can be utilized in a mission to the outer solar system.

This document reflects our collective vision of a possible future, one in which a project of this magnitude and complexity will be considered feasible and essential to the advancement of humankind. Mapping out this potential route toward that future, it is our hope that it will be viewed as accessible, and work will be done to make it a reality. Although developments and events will naturally occur differently than suggested here, ideally this document will provide the basic groundwork to be expanded further as others also ask the question of *Why Not?* It is the beginning of an iterative process that will eventually allow this 'future' to become 'the present', and change the question from *Why Not?* to *When?*.

*It is difficult to say what is impossible
for the dream of yesterday is the hope
of today and the reality of tomorrow.*

*Robert Goddard, father of American
rocketry*

2. Requirements

2.1. Introduction

As briefly mentioned in the report introduction, this chapter outlines the foremost technological and scientific requirements to be met in enabling the progress of human exploration to the outer solar system. The topics within represent the key elements (Propulsion, Power, Science Priorities, Life Support, Artificial Gravity, Habitation and Radiation) that have been identified through an extensive literature review, consultation with experts, months of course work, and lengthy team discussions. In each case, the requirements have been determined due to their perceived importance and to a significant gap between current and envisioned aptitude. No doubt there are multiple areas in addition to the items presented that merit enhanced understanding and competency, yet are perhaps less urgent inadequacies that can be addressed secondarily. Some of these are touched upon in the sections of the next chapter. The requirements serve as the primary rationale behind the steps proposed in the Development Plan (Chapter 3) and embody what we consider to be a credible enhancement of spaceflight capabilities in light of our goal.

2.2. Technology

2.2.1. Propulsion

The current physical limits in chemical propulsion technology forces the scientific community to seek out and develop other means of spacecraft propulsion. Fusion, Variable-Specific-Impulse Magneto-plasma Rocket (VASIMR), Nuclear-Thermal Propulsion (NTP), Nuclear-Electric Propulsion (NEP), and Magneto-Plasma Dynamic (MPD) are a few of the concepts examined for the near future (for complete list of the acronyms, refer to Section 3.3.3). In order to accomplish a mission to the outer solar system, the propulsion subsystem should fulfil the following requirements:

Providing the spacecraft with a velocity change (ΔV): Approximately 60 km/s. A significant percentage of this ΔV has to be assigned for the “escape” manoeuvre from the Jovian or Saturnian gravitational fields, which are much stronger than that of Earth. The required velocity changes are discussed in more detail in Chapter 5. See also Figure 2.1.

2. Requirements

A variable thrust and specific impulse (I_{sp}) for the same engine : This will provide the best efficiency in every phase of the mission. Relatively high thrust (low I_{sp}) will be more attractive for the escape and capture manoeuvre to/from Earth, Jupiter and Saturn. High I_{sp} (and therefore more efficient propellant consumption) will be used for optimizing the interplanetary trajectory.

Advanced power and thermal control subsystems: This should satisfy operational demands for the propulsion system in an efficient manner.

A simple and robust design: This will not only reduce the cost and the operational complexity of the propulsion subsystem, but it will also simplify the integration with the rest of the spacecraft subsystems.

Enhanced operational lifetime for long-duration missions: According to the NASA HOPE mission study (human mission to Callisto), the estimated total mission duration is less than three years (Touman et al., 2003). This sets a reasonable lower limit of four to five years for the operational lifetime of the engine. For missions to the Saturnian system, this limit has to be set to at least seven years.

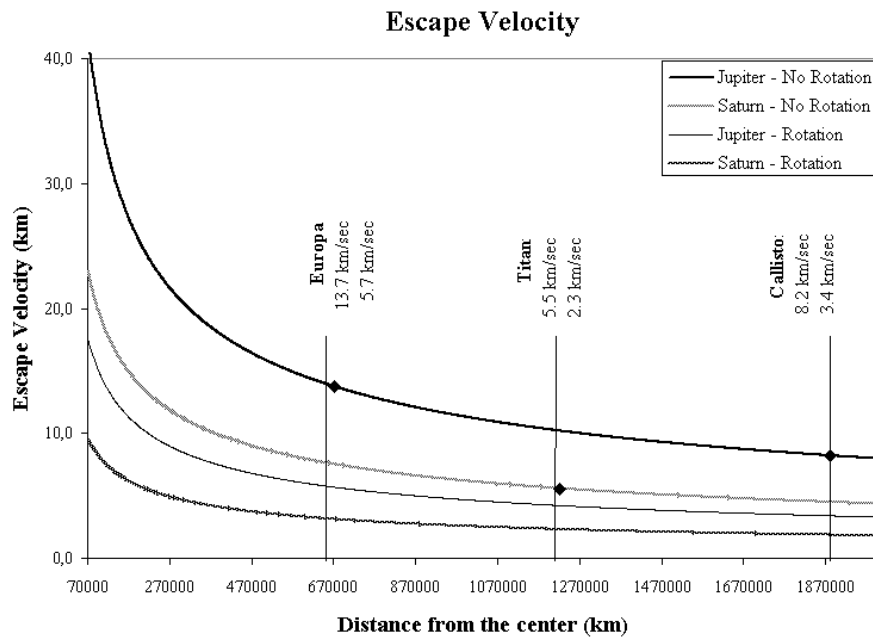

Figure 2.1.: The escape velocity from Jupiter and Saturn, at the altitudes of Europa, Callisto and Titan. The required escape velocity is greatly reduced due to the orbital velocity of these moons around their home planet.

2.2.2. Power

Increasing spacecraft sophistication and mission duration have been accompanied by an ever-growing requirement for generating power on-board the spacecraft. The choices available as prime power sources in space are limited to three: nuclear, chemical, and solar. However, in a mission such as we are facing, nuclear fission power systems are indispensable as a power supply, as no other means of power generation are available so far from the sun (except as-of-yet undeveloped nuclear fusion power systems). The necessary requirements for nuclear power sources are:

- **Higher efficiency and scaling of the current available nuclear power systems for space applications to higher power levels:** It is estimated that for a human mission to the outer planets, at least a few Mega-Watts (electrical) MW_e will be needed.
- **Reliability of machinery and redundancy:** Failure of the power subsystem can be considered as a single-point failure for the mission since all of the critical subsystems - propulsion, life support, communications, radiation protection (if an active system is used) etc. - are dependant upon its successful operation.
- **Ensured human and environment safety:** Protection should be provided against operational radiation emissions or potential failure of the power subsystem.
- **Political consent and public outreach:** While the use of nuclear power sources on spacecraft is not a new concept (mostly in robotic missions), the large-scale reactors that would probably be used might generate public criticism with respect to safety.
- **Effective lifetime for the power system:** The lifetime of the power system needs to be at least five years.
- **Effective thermal management:** The thermal management system should include more efficient radiators.
- **Effective transformation of thermal energy to electrical energy:** The efficiency of this subsystem should be in the region of 20-35%

2.2.3. In Situ Resource Utilization

So far, humans venturing in space have completely relied on supplies carried from the Earth - most commonly referred to as an open loop system. This strategy is manageable for travelling in Earth's orbit or even for a short stay on Moon. However, to "live-off the land", in situ resource utilization (ISRU) is a necessary method for living long periods on the Moon or other planets. In situ resources

2. Requirements

could be utilized for many applications from supporting life to rocket propellant production. The advantages of using in situ resources include significant savings in mass, time and cost, and providing the mission with enhanced autonomy and flexibility. In brief, the requirements for ISRU are:

- Prior knowledge of the availability and properties of resources on Jupiter, Saturn, and their moons.
- The processing equipment should be simple and reliable.
- The equipment should be robust enough to work in the extreme conditions of the outer planets and their moons (low temperatures, high radiation environments etc.)
- Versatility of equipment is necessary. For example, drilling equipment used to extract resources should also be able to drill for setting the base for a habitation module.

2.3. Science Priorities

The scientific observations that could be performed on the Jovian and Saturnian systems are numerous. However, in the context of a development plan towards the human exploration of the outer planets, practical science (engineering) and exciting science (motivation and outreach) investigations should be the priority. Therefore most of the Galilean moons and Titan are the main focus of our planning.

2.3.1. Surface studies

Surface studies include observations of planetary moons, either from orbit, or directly from the surface (see Figure 2.2). A combination of both techniques will be needed in order to fulfil the following requirements:

- **Global mapping of the surface morphology, topography and composition of the Galilean moons and Titan:** This information, apart from its scientific value, can be used for the selection of landing sites and ISRU base sites.
- **Surface in situ observations:** These observations should provide data on basic surface and subsurface properties (e.g. hardness, ice structure, crustal dynamics, and compositional chemistry on a microscopic scale). This information will be very useful for the design of ISRU facilities, as well as for defining the specifications for ice drilling systems that would penetrate the surface of Europa.

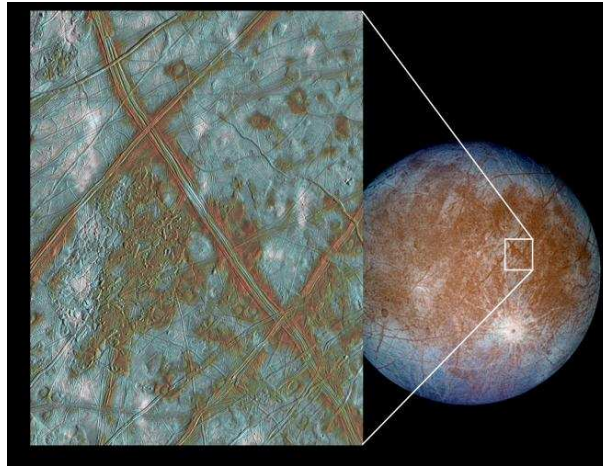

Figure 2.2.: A region of Europa, as it was observed by the Galileo spacecraft. The dark material around the cracks is believed to have upwelled by the subsurface ocean, and might contain interesting organic compounds. Image Courtesy of NASA/Galileo.

- **Characterize the surface radiation environment:** Radiation is one of the possible showstoppers for a human mission, especially for the Jovian system. The magnitude and the variability of the radiation levels at the surface and the surrounding environments of Europa and Callisto must be measured.

2.3.2. Subsurface - Ocean studies

Much of the scientific interest in the Galilean moons and Titan is derived from the recent findings of the Galileo mission, regarding the possibility of subsurface ocean presence in Europa, Callisto and Titan (Moore and Makris, 2003; England, 2003). The theory about hydrocarbon lakes or oceans on Titan is also an interesting case that needs to be examined (Matson et al., 2002).

- **Check the hypothesis of a subsurface ocean on the icy Galilean moons:** Basic properties, such as ocean depth and crustal composition and thickness, should be measured.
- **Ocean in situ observations (only for Europa):** Tidal energy from Jupiter might be able to drive the internal dynamics of the European ocean (Moore and Makris, 2003). This fact makes the ocean of Europa a place that could host life. In situ observations at the ocean should measure its basic properties (temperature, pressure, viscosity, composition etc.) and map its structure.

2. Requirements

2.3.3. Atmospheres

Titan's atmosphere is one of the most interesting physical systems in our solar system. Understanding its dynamics is not only important for science, but also for the design of a human mission (see Figure 2.3). The dim atmosphere of Europa could also prove useful for the design of human or robotic missions (Hall et al., 1995). The following requirements need to be met prior to attempting such missions:

- **Characterize the atmospheric properties of Europa:** Europa possesses a very thin oxygen atmosphere that could be an alternative source for in situ propellant resources.
- **Characterize the dynamics of Titan's atmosphere:** This is important for future missions to Titan. Atmospheric dynamics are involved in critical activities such as re-entry, and atmospheric navigation (for balloons, robotic helicopters, small aeroplanes, etc.)
- **Define the composition of Titan's atmosphere:** This information is crucial for ISRU applications and for the design of spacecraft structure, EVA space-suits, and remote-sensing instruments.

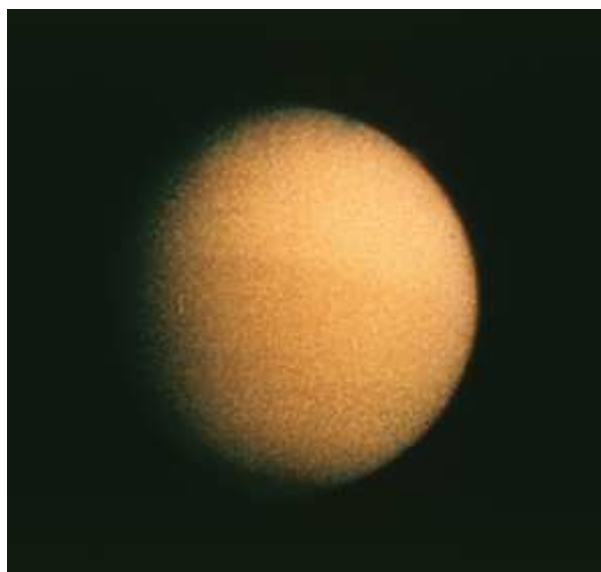

Figure 2.3.: Picture of Titan from the Voyager 1 probe, one of the best available today. The atmosphere of the moon is completely opaque to the visible sunlight, as it can be easily seen. Courtesy of NASA/JPL.

2.3.4. Astrobiology

Astrobiology is one of the scientific areas which should be emphasized in the development plan, since the question of life beyond Earth is one of the most in-

spiring and fundamental that needs to be answered. The following is a list of requirements which need to be addressed in the area of astrobiology:

- **Map biologically interesting compounds on the surface and subsurface of Europa:** The most interesting areas are close to the “cracks” of the crust, where up-welling material from the ocean appears to be present. (Space Studies Board, 2003; Figueroa, 2004).
- **Characterize the effects of Jovian radiation:** Studies should be carried out on the stability of organic molecules on Europa. (Space Studies Board, 2003; Figueroa, 2004).
- **Observe the presence of organics on Titan:** The distribution and composition of organic molecules in the atmosphere, on the surface, and the subsurface of Titan should be mapped (Gershman, 2002).
- **Study the dynamics of Titan’s chemistry:** The role of geological and geophysical processes, as well as surface-atmosphere interactions, in the prebiotic chemistry of Titan should be studied (Gershman, 2002).

2.3.5. Other Scientific Issues

The Jovian and Saturnian systems are very complex. The Galilean moons and Titan represent only a small part of the interesting targets that exist there and need to be observed more carefully. Some of the additional issues that need to, or could be resolved with the proposed development plan, are stated below:

- **Characterize the evolution of the Io-Jovian magnetosphere system:** This will help us to understand the role Io plays in the observed variability of the radiation levels in the orbits of the rest of the Galilean satellites (Russell and Luhmann, 1997).
- **Study the surface of the Saturnian moon Iapetus:** Iapetus has two very distinct hemispheres, one very bright and the other very dark (England, 2003). This implies a complex surface chemistry that could be potentially significant for in situ resources.
- **Perform close observations of the Saturnian moon Enceladus:** Enceladus seems to have many similarities with Europa (England, 2003). If this is confirmed, Enceladus could be chosen as an alternative location for astrobiological studies, if the radiation problems on Europa cannot be mitigated. The radiation levels at Saturn are of the same magnitude as they are in the magnetosphere of the Earth.

2.4. Space Life Sciences

The requirements for enabling long-duration human exploration to the outer solar system have been identified in the following categories: closed life support systems, artificial gravity, habitation, and radiation mitigation. These are defined as particular areas that must experience significant advancements for a mission of this magnitude to be rationally justified. A basic existing competence in each will serve as a benchmark or critical point in the development of these capacities.

2.4.1. Closed Environmental Control and Life Support System - Closed ECLSS

As a solution for extended habitation, scientists and engineers have been carrying out research for years on regenerative life support systems that can provide humans with all the nutritional, energy and gaseous needs while recycling waste and using in situ resources. This approach is far superior to today's method of completely stocking a spacecraft with the necessary supplies before launch or continual re-supply. The ECLSS should meet the following requirements:

- Grow a variety of crops while maintaining minimal mass, volume, power, waster and trace gas emissions.
- Be self-sufficient with minimum crew maintenance.
- In addition to providing all the required nutrients, the food produced must be interesting and tasty enough to support the well-being of the crew.
- The food system needs to be integrated into the appropriate life support system, including habitability, water recovery, human factors, biomass, air revitalization, solid waste management, and thermal control (ESA, 2004).
- The closed ECLSS should be able to function at both zero-g and artificial gravity environments, since the gravity environment might change at different phases of the mission.
- The ECLSS should operate with an extremely high level of reliability.

2.4.2. Artificial Gravity

Due to the absence of both an orbital platform and the corresponding space qualification of artificial gravity in human spaceflight, many difficult requirements exist. Ground based research regarding human tolerance and adaptation to rotating environments has provided crucial evidence and reason to believe this mechanism could possibly be an effective countermeasure. Basic requirements to be satisfied in order to utilize artificial gravity in human spaceflight are:

- **Verify the exploitation of artificial gravity produced by a short-radius centrifuge:** This could provide an alternative to large-scale rotating structures.
- **Characterize various artificial gravity techniques:** This would be used to determine which are most effective, in terms of the required technology (structural issues etc.), operations (maintenance, artificial-gravity duration, spin, de-spin), and crew considerations (induced gravity exposure rate etc.). For example, stabilizing and understanding the ramifications of rotating elements and subsystem synergies should be the first parameters outlined.
- **Expand our basic comprehension of continuously rotating structures in the microgravity environment:** This should be with a focus on easily scalable concepts.
- **Continued commitment to ground based investigation.**

2.4.3. Habitation

The design and development of truly liveable crew quarters is essential to ensure productive and flourishing outer planetary missions. Professionals from virtually every aspect of space exploration will be vital to the creation of a space habitats capable of supporting confined human activity for prolonged periods of time. Several of the major requirements are:

- Drastic reduction in the artificial and monotonous nature of current space hardware, requiring a shift in focus from technically driven design restrictions towards human needs and desires.
- Thorough recognition and appreciation for the social and psychological implications of habitat design.
- Integration of multiple subsystems such as life support and physiological and psychological countermeasures. Committed research, on Earth and in orbit, that furthers our knowledge and understanding of all aspects associated with habitable environments. This research should aggressively evaluate the use of inflatable/expandable structures, while also taking the liberty to introduce elements previously considered as unnecessary luxuries.

2.4.4. Radiation

Three types of radiation are of particular interest for human spaceflight in the outer solar system: solar energetic particles (mostly protons), high-energy Galactic and Cosmic Rays (GCR), and high-energy particles in the Jovian radiation belts that surround Io, Europa, and Ganymede (see Figure 2.4). The most energetic radiation comes from Galactic Cosmic Rays (GeV energies). While the GCR background is not immediately fatal, the integrated dose over long (>1 year) missions

2. Requirements

will approach or exceed the recommended maximum allowable whole-body radiation dose, and also may result in other significant health problems to the crew (Landis, 1991).

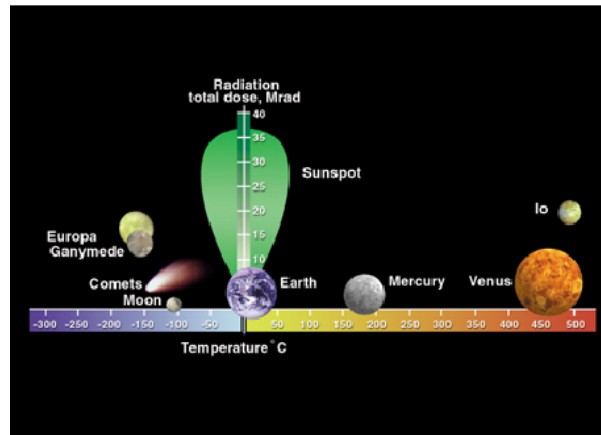

Figure 2.4.: Relative temperature and radiation conditions in the space environment. Courtesy of NASA.

The radiation protection techniques should limit the total radiation dose to the crew, keeping it well below fatal levels (Cucinotta et al., 2003; Wilson et al., 1997). In case that passive radiation shielding is not adequate, active radiation shielding techniques should be introduced. In brief, the requirements for sufficient shielding are:

- **Study side-effects of active radiation shielding methods:** Since active shielding requires the use of magnetic and electrical fields (Landis, 1991), the interaction with the crew and the various subsystems should be carefully considered.
- **The production of advanced materials for the spacecraft structure;** This should further reduce the amount of radiation that reaches the inhabited area after penetrating the active radiation shielding.
- **Explore the possibility for medical countermeasures:** Possible solutions could be pharmacological methods or radiation adaptability studies.

2.5. Conclusion

Having identified the fundamental abilities we feel are required to send humans on such a mission the following chapter contains our proposed solutions. Taking into account current international space activity and initiatives our intentions are to provide fresh and relevant insight as to how these requirements can be achieved. As you read through the road map bear in mind the driving requirements that have been outlined here.

Destiny is not a matter of chance. It is a matter of choice. It's not a thing to be waited for - it is a thing to be achieved.

William Jennings Bryan

3. Theseus: A Road Map for Technological and Scientific Issues

3.1. Introduction

The previous chapter highlighted the most crucial hurdles to be overcome before a human mission to the outer planets can be realized. The technical requirements will entail extensive research and development programs spanning decades before they are space qualified and reliable enough for crucial aspects of the mission. The scientific knowledge that must be obtained prior to such a challenge will require several missions to the outer planets, taking many years of planning and operation. Therefore, due to the large and detailed number of tasks that must be performed before attempting this mission, this chapter will provide a road map of the major technical and scientific programs that should occur. It will give details on specific candidate technologies that should be studied and developed, and once accomplished, would satisfy the requirements and provide the following:

- **Technology:** A plan is given detailing the development steps that are required to mature the necessary technology.
- **Science:** It is necessary to determine what missions are needed to perform scientific analysis to enable a human mission.
- **Development Plan:** A proposed sequence of steps for the Development Plan is included, as well as what be learned from them that will enable the requirements to be met.

The name adopted for the Development Plan is “Theseus.” In Greek mythology, Theseus was a hero who found his way out of the Minotaur’s labyrinth thanks to Ariadne’s ball of thread. In a similar way, our Development Plan represents “Ariadne’s ball of thread,” as it is a potential solution for a complex task. The “escape from the labyrinth” will enable the human exploration of planets beyond Mars.

3.2. Theseus Program Overview

The starting point for the Theseus Program is marked by the Cassini/Huygens mission to Saturn and Titan (planned arrival in July 2004), and by the Jupiter Icy

3. *Theseus: A Road Map for Technological and Scientific Issues*

Moons Orbiter Mission (JIMO) to the three icy Galilean satellites (planned for launch 2011-2015). These missions play a significant role in the overall plan. Saturn has only been visited by three spacecraft, and even these only conducted fast flybys of the planet. Cassini will provide us with detailed observations from orbit for four years and will most likely change our perspective of the entire Saturnian system. Huygens will give the first detailed data from one of the most enigmatic moons of our solar system, Titan (Matson et al., 2002). JIMO is going to be the first of a new generation of space missions to the outer solar system, introducing new technologies that will significantly increase the quality of science obtained (Figueroa, 2004).

However, these two missions are only the first step toward human exploration of the outer planets. Many of the requirements (see Chapter 2) will still not be satisfied after these two missions have been accomplished. The proposed Development Plan describes the major accomplishments that must be met before a human mission to the outer planets is attempted. Each accomplishment is reached through a series of space missions, as well as continuous Earth-based research (see Section 3.3). In terms of science and technology, nine crucial accomplishments have been identified according to the requirements stated in Chapter 2. In short, these accomplishments are:

- **Jovian and Saturnian system:** Much practical science has to be performed before sending humans to Europa, Titan, and possibly Callisto. A series of robotic missions is proposed to accomplish this (see Sections 3.3.1,3.3.2).
- **Advanced propulsion:** Current propulsion systems are not adequate for interplanetary human spaceflight. VASIMR or MPD engines are the candidate solutions, and the development steps are discussed in Section 3.3.3.
- **Nuclear power:** Nuclear systems seem to be the best way to provide the Mega-Watt levels of power that are needed for human missions to the outer planets (see Section 3.3.4).
- **In Situ Resource Utilization (ISRU):** The exploitation of in situ resources adds the necessary flexibility to the overall mission design of human (or even robotic) missions to the outer planets, while also simplifying the spacecraft design. The steps needed to utilize ISRU are discussed in Section 3.3.5.
- **Closed Environmental Control and Life Support System (closed ECLSS):** A closed life support system is the only way to support the crew during the whole mission, since resupply capabilities for outer planetary missions are remote. The steps proposed to develop a closed ECLSS are described in Section 3.3.6.
- **Artificial gravity:** The use of artificial gravity is the most comprehensive countermeasure against the long-term effects of microgravity (see Section 3.3.7).

- **Habitation module:** Since a mission to the Jovian or Saturnian system would last several years, the habitation module of the spacecraft should not be constructed just as a working area, as has been the situation up until now. The steps toward a solution are discussed in Section 3.3.8.
- **Radiation protection:** Currently, only passive radiation protection techniques are used for human spaceflight. For missions to the outer planets, the development of effective, active radiation protection in combination with passive techniques is the best solution (see Section 3.3.9).

It has to be specified that each accomplishment does not represent a point where a development of a certain technology or the exploitation of a scientific issue stops. Each accomplishment determines the point upon which no further critical development is needed.

The sequence in which the aforementioned accomplishments have to be reached is summarized in a Gantt chart (see Figure 3.1). Radiation protection is set to be one of the last accomplishments. Before we finalize the research on active radiation protection techniques, we should first prove that we are able to physically transport a spacecraft and a crew from Earth to the outer planets. This means that propulsion and advanced power techniques should begin development in the first phases of the program. This will also enable us to construct very large structures that would adequately test and space qualify artificial gravity techniques, closed ECLSS, ISRU, as well as integrate all of these into habitable spacecraft designs. Scientific exploration is also ongoing throughout the Development Plan. The proposed robotic missions will serve as testbeds for many technologies of the Theseus Program (such as ISRU, radiation protection, advanced propulsion, and power).

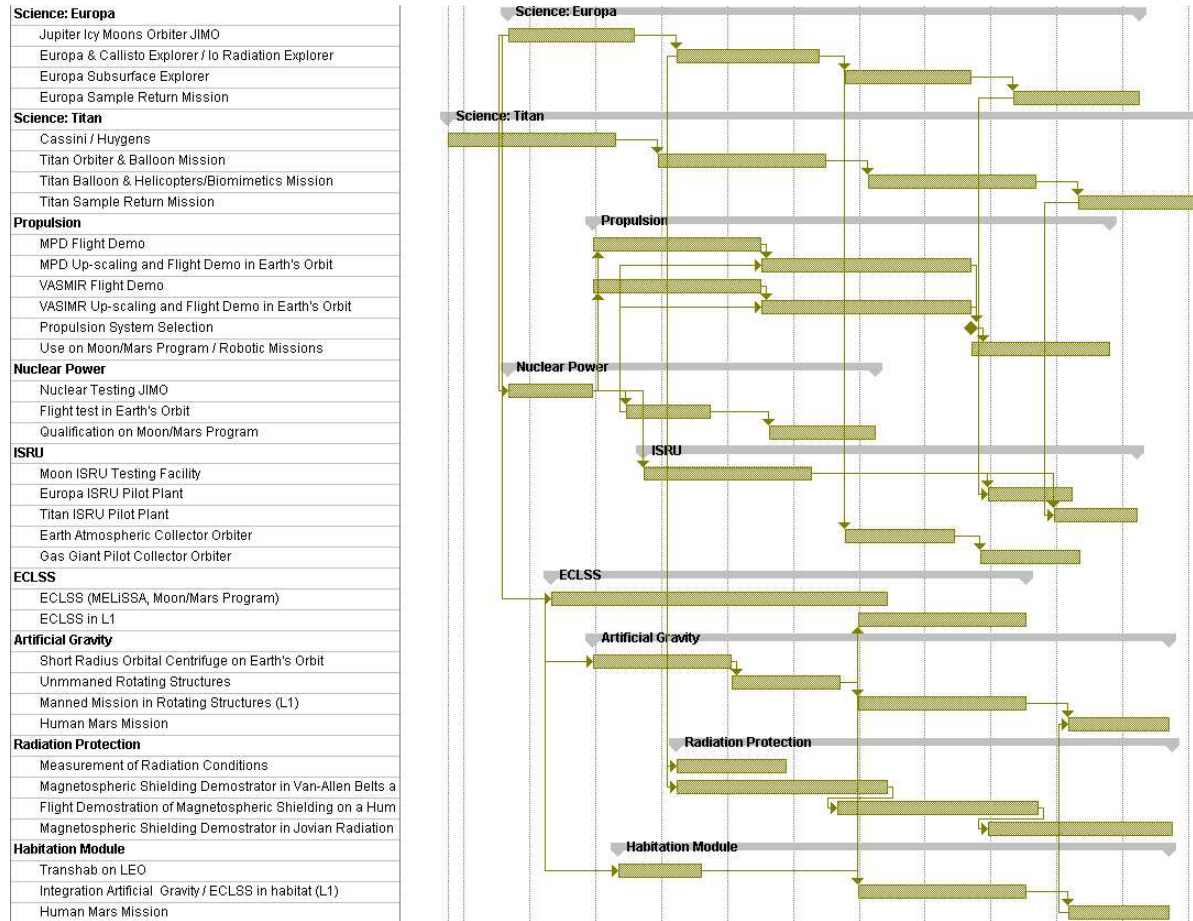

Figure 3.1.: Gantt chart of Theseus: The “space segment” of the development plan is highlighted, however, all of these steps are accompanied by research on the Earth.

Most of the scientific missions in the Theseus Program are directed to Europa, Callisto, and Titan. While the successful completion of the Development Plan will enable human exploration of the outer planets and their satellites (Jupiter and Saturn alone have 92 moons in total, as of April 2004 (Sheppard, 2004)), the focus is set on these three moons for reasons discussed in Section 2.3. Besides Europa, Callisto is chosen among the rest of the three Galilean moons, mainly due to the harsh radiation environment around Io, Europa and Ganymede. If radiation shielding techniques prove inadequate for the European environment, humans could be sent to Callisto and perform activities on Europa through tele-operations, as originally proposed in NASA's HOPE study (Touman et al., 2003).

What is also significant for the Theseus Program is the role of human missions to the Moon and Mars. Two programs are currently ongoing in the United States and Europe (Aurora) (Messina and Onarro, 2003; NASA, 2004c). The road maps for these programs include enhanced scientific and technological research in areas that are identified as "accomplishments" in our proposed plan. While nobody can predict whether the US initiative or the Aurora Programme will become reality, it is reasonable to assume that humans will first go to Mars before attempting a mission to the outer planets. Both programs in this case are a good indication of the technologies that need to be developed (and in what sequence) to enable human missions to the Moon and Mars. This is seriously taken into account in the analysis of each accomplishment in Section 3.3.

One element that is missing from the road map is a time scale as there are a number of factors that lead to large uncertainties in time estimation. Development duration can differ for each technological accomplishment for reasons such as differences in funding, social-political environment, and level of innovation. In Section 4.6, where costing of the Theseus Program is discussed, the duration of various different technology projects can be seen in Table 4.4.

A rough idea about the duration of Theseus can be given with respect to the scientific elements of the program as we expect these to be completed concurrently. It is currently understood that successive missions to the outer solar system would have a gap of at least fifteen years (J. P. Lebreton, personal communication, 2004). Taking into account the scientific planning for the Jovian system (Section 3.3.1), we could expect approximately a sixty year duration for the completion of all proposed missions. Future developments in advanced propulsion and power (see Sections 3.3.3, 3.3.4) could probably reduce the duration to approximately fifty years. However, a lot of uncertainty still exists (mission success, level of funding, etc.), so a fifty to seventy year duration is a more reasonable estimation.

3.3. Accomplishments

As discussed in Section 3.2, eight points are mainly defined as critical for the Theseus Program. Each accomplishment is approached in a different way: while a series of space missions is proposed for the scientific elements of Theseus, the

3. Theseus: A Road Map for Technological and Scientific Issues

rest of the defined achievements (mainly relating to technology and space life science research), suggest an overall strategy is comprised of both ground and space research. The following sections give a more in-depth description of the ideas proposed for achieving these goals.

3.3.1. Jovian System / Europa Science

A Europa Sample Return Mission marks the end of the scientific investigations of the Jovian system for the Theseus Program. Obviously, the scientific requirements cannot be satisfied with just one mission. The Europa Sample Return Mission is the end-result of a number of steps and scientific investigations that have to take place. The necessary steps identified, mostly in terms of robotic missions, leading to the final Europa Sample Return Mission, are presented below.

JIMO Mission

JIMO will be launched by NASA between 2011 and 2015 and will orbit the three icy Galilean moons - Callisto, Ganymede, and Europa. For a more comprehensive review of the scientific objectives of the JIMO mission, as well as for the proposed methods to meet these objectives, refer to the "Report of the NASA Science Definition Team for JIMO" (Figueroa, 2004). It is expected that the follow-up missions to JIMO would take advantage of the key technologies that will be introduced in this mission, as well as from technologies that would be available according to the Theseus Program (mainly: advanced power units, advanced propulsion techniques, and ISRU technologies). This will enable the use of large-scale robotic spacecraft, with increased payload capabilities. The following missions, are concepts originally proposed for our plan:

The Europa & Callisto Explorer mission

This mission will consist of one orbiter and two small landers. The orbiter will observe Callisto and Europa and will deliver a lander to the surface of the two moons. The orbiter will also serve as a telecommunications relay for the landers. In total, the scientific objectives of the mission will be:

1. Investigate the radiation levels on Europa and Callisto (peaks, periodicity) to prepare the future equipment for human protection on the surface and in orbit around these moons. This can be done using ion spectrometers or plasma analysers.
2. Perform astrobiology studies to search for existence of life (present or past) on Europa. Mass spectrometers on the landers could be used to analyse surface and subsurface samples for biological signatures.
3. Determine the properties of the ice on the surface of the two moons from orbit and in situ observations. Ion mass spectroscopy and thermal infrared

sensors can be used for this activity. Analysis of soil from shallow depths could also be completed. This data can also be used for the design of ISRU technologies (see Section 3.3.5).

4. Perform seismological and acoustic sounding techniques from the landers for more accurate ocean depth estimation on Europa and Callisto (if it exists) and for subsurface feature detection.

The Io Radiation Explorer Mission

The plasma from Io's volcanic activity is the main driver of the magnetospheric dynamics at Jupiter (Russell and Luhmann, 1997) and the source of the high radiation levels observed along the orbits of Io, Europa, and Ganymede. The Io Radiation Explorer Mission will operate at the same time as the Europa & Callisto Explorer Mission, and its main objectives will be:

1. Observe the volcanic activity on Io and detect any periodicities that may exist.
2. Measure radiation extremes and relate them to volcanic activity.
3. Make simultaneous radiation measurements with the Europa and Callisto Explorer Missions at the orbits of Europa and Callisto. These measurements will be related to the observed radiation activity at Io in order to understand the radiation propagation mechanisms.

The Europa Subsurface Mission

This mission will consist of a Europa orbiter (mostly to act as a communications relay) and a large lander. The lander will deploy a melting probe at the surface of Europa, at a landing site carefully selected according to data from previous missions. The probe will melt the ice of Europa's crust, enter the ocean, and perform autonomous operations as a hydrobot. The technology of melting probes is already under investigation by DLR and NASA, and tests are being performed in laboratories and at Lake Vostok in Antarctica (Biele et al., 2002). This study will be the last and most important mission preceding the Sample Return Mission. Three topics will be studied:

1. The ocean composition will be determined.
2. A map of the ocean's bottom close to the entry location will be developed using suitable sonar on the melting probe / hydrobot.
3. More detailed astrobiology will be done in this second mission to Europa. The instruments taken on-board the lander will be more suitable, considering the results of the first mission.

Europa Sample Return Mission

The Europa Sample Return Mission will duplicate the previous mission, differing only in that it will collect samples for return to Earth. Samples will be collected from both the lander and the ocean probe. It will also demonstrate the use of ISRU technologies (refer to Section 3.3.5) in the environment of Europa, with the lander producing propellant from Europa's surface. The propellant will be used to deliver the canister with samples to the orbiter and to eject the spacecraft out of Jupiter's gravitational influence. Analysis of these samples will greatly assist in the astrobiological studies of Europa, while also improving the quality of ISRU technologies.

3.3.2. Saturnian System / Titan Science

Scientific investigation of the moons of Saturn will consist of several missions designed with a progressive geographical focus. The first mission will provide global coverage of Titan, with the second performing more specific science on limited areas of the surface. Finally, a mission will be dedicated to a sample return from the most promising sites of Titan. Briefly, the proposed steps toward this achievement are:

Cassini/Huygens Mission

The Cassini/Huygens mission will start orbiting the Saturnian system in July 2004 and will greatly aid for our understanding of Saturn and its moons (especially Titan) (Matson et al., 2002). The following missions concepts have been originally developed for our plan. As in the case of the proposed Jovian mission, they are expected use the technologies enabled with the JIMO mission:

Titan Orbiter & Balloon Mission

The follow-up mission to Cassini/Huygens will be dedicated to Titan. It will consist of an orbiter and an atmospheric balloon. The Titan atmospheric model (based on Cassini/Huygens results) is expected to be accurate enough for the planning of an atmospheric probe, allowing further investigation of the atmosphere. The orbiter will also serve as a telecommunication relay for the balloon, which will navigate in the atmosphere to cover the moon's surface (Aaron et al., 2002). Scientific instrumentation will be located on the top of the balloon and on a small mobile platform tethered to the balloon. Instrumentation on the tether can operate at optical wavelengths, since the atmospheric opacity will be less than that from the orbiter. More specifically, the objectives of the mission will be:

1. High resolution mapping of the surface in order to produce a Digital Elevation Model (submeter resolution with a lidar) and high-resolution maps (submeter resolution) for any future surface operation missions.

2. Analysis of the surface composition with an imaging spectrometer and instrumentation based on standoff Laser Induced Breakdown Spectroscopy (LIBS) (refer to Section 3.4). Raman Spectroscopy can map the surface composition with a rough sampling grid for the whole surface (about 50 m) and at higher resolution for selected sites (down to a few meters).
3. Atmospheric studies could be performed from instruments on the tether. A gas chromatograph would directly sample the atmosphere at various altitudes and the wind force and the atmosphere density could be monitored. Instruments based on Doppler LIDAR and LIBS could provide a detailed analysis of the atmosphere composition and dynamics around the balloon. The atmosphere layer above the balloon could be studied with instruments on top of the balloon and on-board the orbiter.
4. Mapping of the plasma environment by the orbiter (using ion spectrometers) and radiation profiles in the atmosphere will give the necessary overview of the radiation environment for any future human mission to the surface of Titan.

Titan Balloon and Helicopter/Biomimetics Mission

This mission will provide an in depth study of Titan. It will consist of a small orbiter (for telecommunication purposes), an atmospheric balloon, and several small helicopters. It will focus on astrobiology and atmosphere/surface interactions, as well as identify the most promising sites for astrobiology, geological studies, and ISRU. The balloon will serve as the mother platform for the helicopters and it will also have an advanced laboratory. The helicopters will map selected sites at a very high resolution (down to a few cm). They will also gather samples and bring them back to the balloon's laboratory for analysis. The instrumentation could be similar to that of the previous mission, with greater capability in data collection and analysis. An alternative solution to helicopters would be the use of "biomimetics". Biomimetics are aeroplane-like structures (refer to Picture 3.2) that imitate insect aerodynamics on Earth, generating lift by the continuous formation and shedding of vortices on their wings (Aaron et al., 2002).

Titan Sample Return Mission

The interesting sites selected by the previous mission will be a direct input for this mission. Main objectives of this mission would be to precisely characterize what astronauts will encounter during a future mission to Titan, and make detailed astrobiological studies. It is a critical step for ISRU, habitation, and scientific instrumentation development, as well as for landing site selection. The mission profile could be similar to the one described for the Europa Sample Return Mission (see Section 3.3.1), however some significant differences exist: the stronger

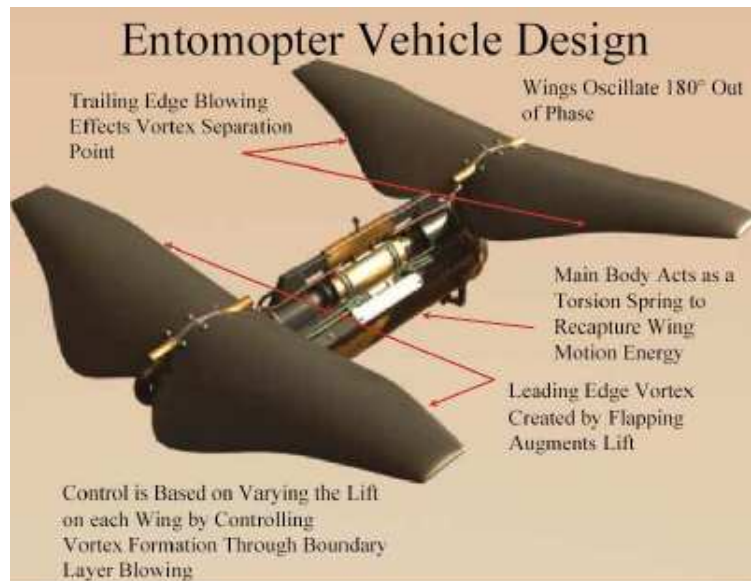

Figure 3.2.: The image shows the proposed design for a Mars aerial explorer (Entomopter). Such a design could be easily modified for the exploration of planets or moons with an atmosphere, such as Venus, the gas giants, and Titan. From (Aaron et al., 2002).

gravity of Titan, the larger distance from the Earth compared to Jupiter, the presence of a dense atmosphere, and the different available resources for propellant production.

Additional Opportunities

The proposed missions offer additional opportunities for science in the Saturn system. Enceladus, known for its resemblance to Europa, and Iapetus is interesting because of its intriguing dark and bright faces, represent examples of targets in the Saturnian system (England, 2003). Any of the proposed missions could be designed as JIMO-type missions so that an orbiter can also visit at least one of these two moons, in addition to Titan. Another possibility would be to send the orbiters into an extended mission phase after completion of their primary tasks.

3.3.3. Advanced Propulsion

To go to the outer solar system in 1 – 1.5 years requires innovative propulsion systems capable of delivering a ΔV of 60 – 80 km/s. A brief analysis for the required amount of ΔV is discussed in Chapter 5. No current system is capable of this achievement, but the most promising candidate propulsion techniques are listed in Table 3.1. As none of the propulsion systems listed have been space qualified, no choice can be made now, although technical superiority of fusion based systems over fission-based systems is generally accepted.

	Fusion MCF	Fusion ICF/MTF	NTP	NEP+MPD	NEP+VASIMR
I_{sp} [s]	200 000	50 000	800–1200	<10 000	2 000–3 0000
Status	Experimental, mostly conceptual	No lab test, theoretical concept	Developed and tested in USSR and USA	Flown in pulsed mode, lab tests continue	Tested at NASA JSC, needs to be upscaled
Pros	Enormous I_{sp} continuous mode operations, usable as power source	Enormous I_{sp}	Better than chemical engines, high thrust	More existing experience and higher thrust than VASIMR	Variable I_{sp} , longevity, lightweight components
Cons	Hard to develop	Hard to develop	I_{sp} low, lifetime low	Component wear, waste heat removal	I_{sp} variability questionable
Spec. Power [kW/kg]	1 – 20	5 – 20	17	0.5	0.76
Spec. Thrust [N/kW]	1.8	0.5	0.22	0.02	0.04
ΔV [km/s]	230–2300	230–2300	8.8	~ 50	~ 50
Utilization Time	Unknown, continuous	Unknown, pulsed mode	100 hrs as engine 10 yrs for power	Hours at high thrust	Unknown, but assumed very long

Table 3.1.: Typical parameters of different propulsion options, data from (Demjanko et al., 2001), (Manteniaks and Myers, 1993), (Tajmar, 2004), (Kammash, 1997) and (Schaffer, 2000). For explanations of the acronyms see Appendix C.

3. *Theseus: A Road Map for Technological and Scientific Issues*

Fusion propulsion is intimately linked to the development of fusion power systems from a technological point of view. From a systems engineering point of view however, power and propulsion systems cannot be separated from each other as fusion plasma is used for direct propulsion application, whereas plasma induced currents provide electrical power (Piefer, 2000).

The envisioned mission requirements lead to the conclusion that NTP systems do not provide enough efficiency and require too much fuel to be top candidates. Although Table 3.1 would suggest that NTP is very effective, it should be emphasized that the values in this table refer only to the engine itself. They do not take into account the needed propellant mass to accomplish a mission.

Instead, we suggest aiming directly for high-efficiency systems like the NEP versions with MPD or VASIMR (see Figure 3.3), since they do not only offer far better I_{sp} , but, in the case of VASIMR, also moderate thrust capability. Fusion power/ propulsion is not a prerequisite for going to the outer solar system (fission based system offers sufficient power density and high-power capabilities for such missions) and will most likely be developed well after NEP systems. Nuclear fission systems would easily fit into current mission design habits (use and discard-type spaceships). Fusion-based systems have an enormous inherent complexity. To justify the construction effort, the development and building of spaceships for multiple missions and an operational lifetime greater than ten years would be suggested. A more detailed comparison of advantages and disadvantages of the preferred systems (MPD and VASIMR) is presented in Table 3.2.

It is difficult to judge which of the engine concepts is better; however, the VASIMR has a unique advantage of low or non-existent component wear. This would be crucial on a mission with very little chance to conduct repairs or replacements. A number of steps have been identified in order to qualify the designs and select the most appropriate solution for our mission and further development:

- **MPD:** The MPD concept is being actively researched at the Jet Propulsion Laboratory (JPL), MAI (Moscow Aviation Institute), University of Stuttgart, and Princeton University. The Japanese Institute of Space and Astronautical Science (ISAS) flew a quasi-steady MPD as part of the Electric Propulsion Experiment (EPEX), but no steady state thrusters have yet been flown. Low power models of the VASIMR engine also exist in the Johnson Space Center (JSC). Ground development should continue in the direction of prototyping and upscaling for space flight. Upscaling is especially important for the VASIMR engine, which requires a very heavy power generation unit.
- **Space qualification:** With the attachment of relevant propulsion modules to the ISS, space qualification tests of these engine types could be performed. These modules could perform orbital maintenance and attitude control functions. An alternative would be to test these propulsion modules in modified versions of the newly proposed Crew Exploration Vehicle (CEV) by NASA for the human exploration of Moon and Mars (NASA, 2004c). This solu-

3.3. Accomplishments

	MPD Engine	VASIMR Engine
Advantages	<ul style="list-style-type: none"> • Has been in development longer than the VASIMR, well understood concept • Power Processing Unit (PPU) lighter than in the VASIMR design • Less physics issues than the VASIMR • Has the highest absolute thrust of any electric propulsion method so far • Cathode rod probably replaceable • Simple and robust design 	<ul style="list-style-type: none"> • Variable specific impulse and thrust (see Table 3.1) • No direct contact between plasma and structure (increased component longevity) • Lightweight components
Disadvantages	<ul style="list-style-type: none"> • Component wear, especially the cathode component and/or if thrusters operate on a corrosive fuel • Need to remove heat (40% of power is converted to heat and needs to be removed: $\sim 2 \text{ kg/kW}_t$ (thermal control systems needed)) 	<ul style="list-style-type: none"> • Variability of the I_{sp} is questionable, may need several engines optimized for a particular specific impulse range • No such engine has flown yet in space, hence true performance characteristics are yet unknown • Entire system is still in the early testing phase • Heavy PPU system, almost 2times the weight of the engine itself • Probably not repairable in space

Table 3.2.: Comparison between MPD and VASIMR engine concepts. For explanations of the acronyms see appendix C.

3. Theseus: A Road Map for Technological and Scientific Issues

tion would be most probable if none of the propulsion systems are space qualified by the end of the ISS lifetime (estimated at 2015-2020).

- **Propulsion uses:** Both of the propulsion methods are considered as viable solutions for the Aurora Programme which means that we could expect these two type of engines to be developed and used for human missions to Mars (Andrew, 2001). This also increases the possibility that these propulsion systems will be used in the CEV design.

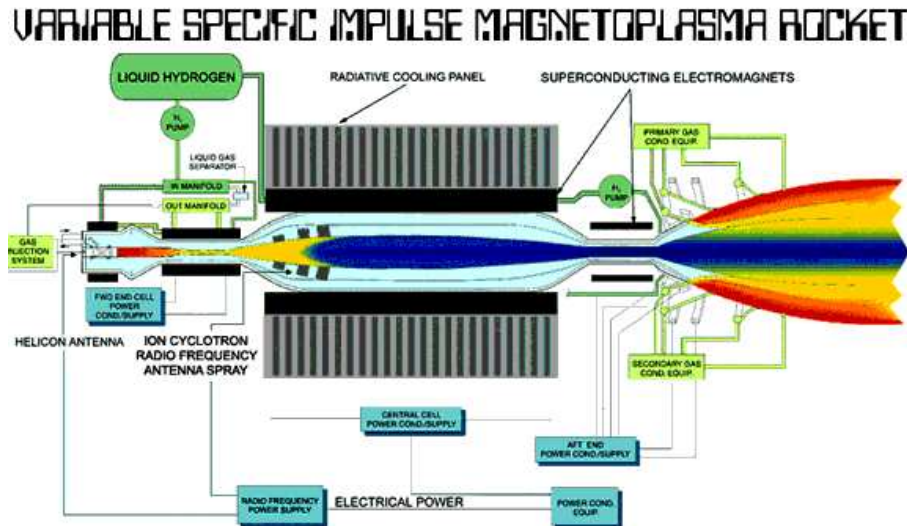

Figure 3.3.: A cutaway of the proposed VASIMR design. An electric power source ionizes fuel into plasma. Electric fields heat and accelerate the plasma while the magnetic fields direct the plasma out of the engine creating thrust for the spacecraft. Courtesy of NASA/JPL.

It is expected that advanced propulsion systems will be mainly evaluated through the Moon and Mars programs. By the time human Mars missions occur, a choice could be made whether MPD or VASIMR engines are better for outer planetary missions. Beyond this point, the chosen propulsion system could be continuously improved and used for various missions, throughout the Theseus Program (artificial gravity missions, scientific robotic missions, etc.), or for other applications utilizing this technology.

3.3.4. Nuclear Power

Radioisotope generators were used for a long time on outer solar system probes, including Pioneer, Voyager, Galileo, and Cassini, but these units are small. NASA's standard Radioisotope Thermoelectric Generator (RTG) module generates 300 W_e. NASA also makes extensive use of its probes of 1 W_e radioisotope heating units, which keep spacecraft instruments at temperatures within optimal

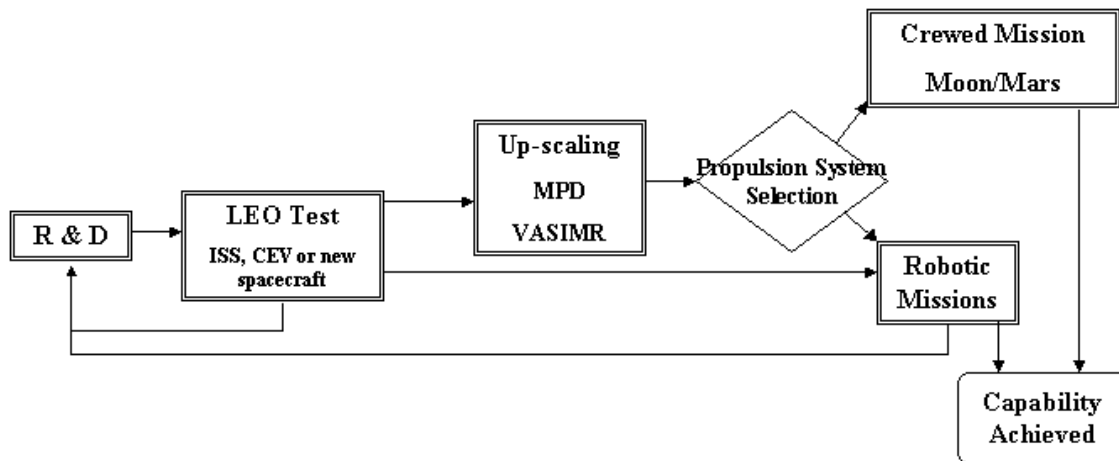

Figure 3.4.: Flow chart describing the development of propulsion technology.

operational limits. Exploring the outer solar system efficiently and systematically will require much more power than this (on the order of magnitude of tens of MW_e).

The following technological developments must be accomplished to fulfil these power requirements (Schaffer, 2000):

- Radiation and corrosion resistant alloys
- High power and high temperature power conditioning units (PCUs)
- Restartable nuclear reactors in space
- Heat rejection systems for MW_t level reactors
- Exchange of fuel elements in a liquid metal nuclear reactor
- Storage and disposal of fuel elements and defunct reactors during or after the mission
- Launch safety
- Improvements of power-to-weight ratio

As the flow chart (see Figure 3.5) shows, the necessary steps toward using nuclear power in human spaceflight are:

- **Definition of base technologies to build and develop multi MW_t nuclear thermal reactors:** This should be accomplished through the integration of results from ground based testing, simulations, and data from robotic missions to the Moon, Mars, or the outer planets. A number of important on-going programs should also be supported:

3. Theseus: A Road Map for Technological and Scientific Issues

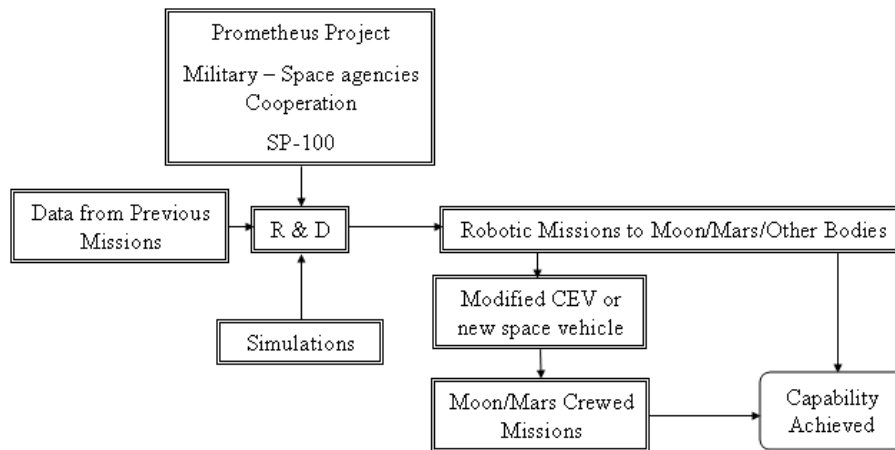

Figure 3.5.: This simplified flow chart shows the basic steps required in order to utilize nuclear power systems on human spacecraft. As seen often in the Theseus Program, the importance of robotic missions (e.g JIMO) and their role in human missions to the Moon and Mars is evident.

- The Prometheus Project is an established program in order to develop technology and conduct advanced studies in the areas of radioisotope power systems, nuclear power, and propulsion for the peaceful exploration of the solar system (Wood et al., 2004).
 - The SP-100 Power Source Project, which has a goal of demonstrating the technology for space nuclear reactor power systems that can provide power for a wide range of space missions, especially for those using electrical propulsion (Armijo et al., 1991).
 - It is expected that the military will continue support the research of nuclear power. Forming synergies and collaborative projects, space agencies could tap into this valuable resource.
- **Continued research:** These programs would help build a prototype reactor and test it in a closed environment on the ground.
 - **Considerable improvements on power-to-weight ratio:** These are expected to be made in the context of above-noted research programs.
 - **Other Sources of Nuclear Power Research:** Nuclear power techniques are strongly considered for the Aurora Programme (Messina, 2001). Also, it is likely that nuclear power would be evaluated as part of CEV research and development. It is logical that human missions to Mars would take advantage of this technology, which, as these projects illustrate, would propel research in the field.
 - **Proposed scientific robotic missions to the outer solar system:** These missions could utilize or test nuclear power as a major subsystem. Most likely,

this would be accomplished in connection with engine tests and other necessary technology demonstrations. JIMO is the first step towards this, and the best example of what could potentially follow.

The nuclear reactors must also to be tested for extreme operating conditions to increase reliability and durability. Nuclear reactors should also be tested for contamination effects on the space environment.

3.3.5. In Situ Resource Utilization

Propellant and life support systems represent major drivers in the mass budget of a long-term crewed mission. Often, the large amounts of hydrogen, oxygen, and water required for a human mission constitute major drawbacks for mission feasibility. However, in the case of planetary exploration, obtaining these materials from in situ resources can considerably reduce spacecraft mass.

This is the case of the outer planets' moons as their surfaces contain a considerable amount of ice. Once extracted and processed, this resource could potentially generate enough water, liquid oxygen (LOX), and liquid hydrogen (LH) to support the mission. After arrival to the moons, these compounds could be used to support life, shield from radiation, support base and field operations, propel ascent and descent vehicles, perform interlunar trips, and provide impulse for sample and crew return.

However, ice is not the only valuable resource. Observations by the Hubble Space Telescope (HST) have revealed that Europa possesses a dim atmosphere of oxygen, produced mostly by the interaction of the surface with the Jovian radiation belts (Hall et al., 1995). Exploration probes and HST have shown considerable abundances of methane, hydrogen, and other hydrocarbons in Titan's atmosphere (Beatty et al., 1999). Jupiter and Saturn's atmospheres are other possible sources of hydrogen.

Estimation of the resources and their characterization will take place with the proposed scientific missions discussed in Sections 3.3.1 and 3.3.2. These missions will identify resources and characterize the physical and chemical properties. The sample return missions will significantly improve our understanding of the local resources.

ISRU development is being considered for the Aurora Programme and a 2001 Mars sample return mission (Andrew, 2001), (MSR Team and Messina, 2003). It is still too early to say whether these plans will materialize that quickly, but it is quite likely that by 2020 ISRU would be part of robotic and/or human missions to Mars.

A number of missions dedicated to ISRU development would also have to be performed in to fully develop ISRU technologies and techniques. In brief:

- **Earth Atmospheric Collector Orbiter:** This mission will feature an orbiter around the Earth which will demonstrate the low-pressure gas collector technology. The orbiter will circle the Earth at a very low circular orbit

3. Theseus: A Road Map for Technological and Scientific Issues

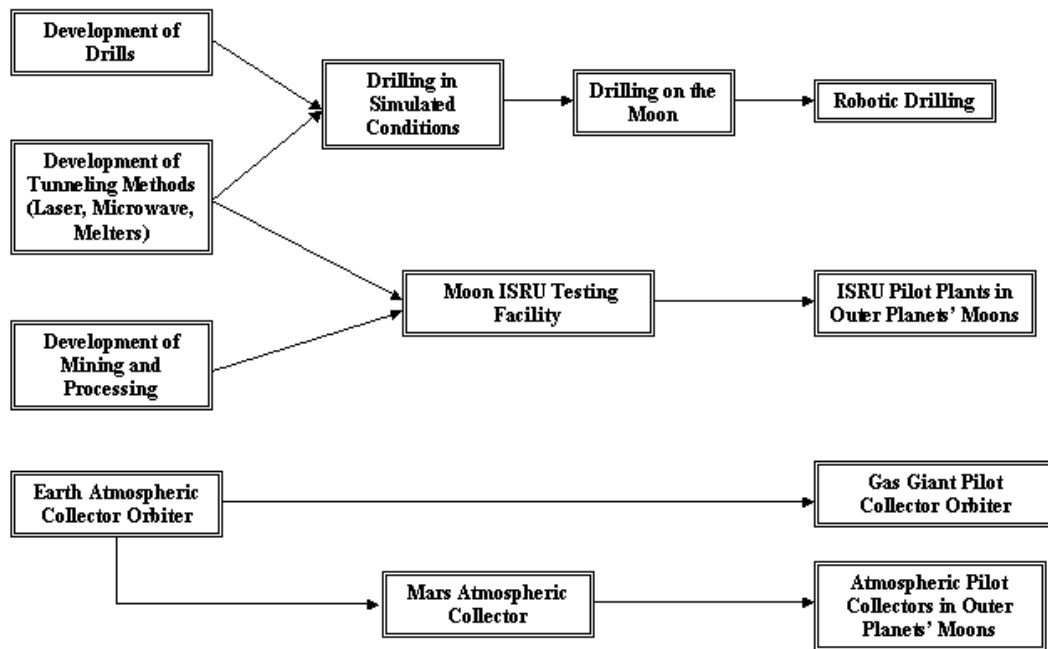

Figure 3.6.: Technological road map for ISRU and drilling: Several options, on the surface or in the atmosphere, exist in the Jovian and Saturnian systems.

(less than 300 km), where the planet's ionosphere has a considerable density. The satellite will employ a gas collector that would gather oxygen from the ionosphere and a processing unit that would liquefy the gas and convert it into propellant. The orbiter, which would normally enter the Earth's atmosphere within a few days or weeks (depending on the satellite mass and effective drag area), will use the produced propellant for orbit maintenance. Within a mission that could last from a few months to a few years, it will test the efficiency of the low pressure atmospheric collectors in space, the efficiency of the on-orbit propellant processing unit, and the degradation, lifetime, and reusability of this technology.

- **Mars Atmospheric Collector:** The technology evaluated in the previous mission could be used as a payload in a robotic mission to Mars (as part of the Mars exploration program). A standard technique used on both the Mars Global Surveyor and the Mars Odyssey missions, is that of the aerobraking. Both spacecraft started from a highly elliptical orbit around Mars and through a series of fast passages through the planet's atmosphere, they achieved a low altitude, circular orbit. The atmospheric collector could be tested in similar conditions to demonstrate its ability to work efficiently in short duration periapsis passes through the Martian atmosphere. After the orbiter achieves the circular mapping orbit, it could use a similar technique to that of the Earth Atmosphere Collector Orbiter. In this way, the working orbit can be as low as 150 km, and thus allow very detailed observations.

- **Moon ISRU Testing Facility:** This facility would aim to test various alternative technologies for all processes involved in ISRU (extraction, loading, hauling, crushing and grinding, storage, processing, dumping, etc.) to provide expertise in the application of these technologies in outer space. It also would be possible to simulate conditions and properties of resources from other celestial bodies.
- **Pilot Plants in Outer Planets' Moons:** These facilities would test all aspects related to ISRU from extraction to processing, including different mining techniques and atmospheric collectors. The different properties of the various moons would demand a unique mission for each moon. Differences include: Resource types, environmental conditions, and ore properties. For example, the disparity in atmospheric pressure compositions between Titan and Europa and the varying acidity of the surface ice present on Europa and Callisto both require individual techniques for their analysis (Clark, 2004). These plants would provide information regarding the reliability, efficiency and durability of these ISRU facilities. They would also produce enough propellant to support later robotic missions such as the sample return missions (see Sections 3.3.1 and 3.3.2).
- **Gas Giant Pilot Collector Orbiter:** Evolution of previous missions will lead to collection of gases from the outer layers of the atmospheres of celestial bodies. Gas Giants have in their atmospheres mainly Hydrogen (H) and Helium (He), which may represent an interesting location of resources. The technology will not be much different from the one used by the Earth Atmospheric Collector Orbiter.

3.3.6. Closed Environmental Control and Life Support System (ECLSS)

As space missions increase in duration, the supply load gets heavier and resupply becomes prohibitive. It is therefore essential to recycle consumables and to introduce regenerative life support systems for future long-duration space missions (Eckart, 1994).

The daily consumption of oxygen, water, and food in an open loop system is approximately 12 kg per person per day (Messerschmid and Bertrand, 1999), or 4.2 t per person per year. From a practical and economical point of view, for a long-term mission with several crewmembers, the amount of resupply to the system should be as small as possible, reducing the amount of stowage volume. Hence, closed loop life support systems are desirable. Using regenerated physico-chemical systems, the water and oxygen loops can be closed (Eckart, 1994).

The only missing loop is the carbon loop. Food could be produced on-board during a long-term mission, by setting up a bioregenerative life support system. The water and oxygen loops would be part of a bioregenerative system. Food production requires water; fortunately, plants produce oxygen and contribute to

3. Theseus: A Road Map for Technological and Scientific Issues

water purification, air revitalization, and waste processing. Presently, NASA is developing this kind of closed loop system (National Aeronautics and Space Administration, 2002). Methods to evaluate the safety and reliability of a bioprocess should be developed. For this, ESA has a program called Aurora Life Support System Simulator (ADERSA et al., 2002). NASA is also planning long-duration human testing in a ground-based facility between 2008 and 2016. A 95% closed food production loop and 95% waste recovery are the ambitious goals set by NASA for the year 2016. ESA's Micro-Ecological Life Support System Alternative (MELiSSA) is developing technologies for a 1000-day Mars mission around 2030. Figure 3.7 shows the loop of a MELiSSA system using five compartments. Currently, 70% waste recovery is achieved (Lobo and Lasseur, 2003). Experiments at the Russian Bios-3M test facility have shown that to fully supply one human with oxygen, water and 30-40% of food, the sufficient plant area is 13 – 14 m² (cucumbers, tomatoes, peas, beans, carrots, radish, potatoes, etc.) under the flux of photosynthetically active radiation with an intensity of about 150 W/m² (SB RAS, 2004).

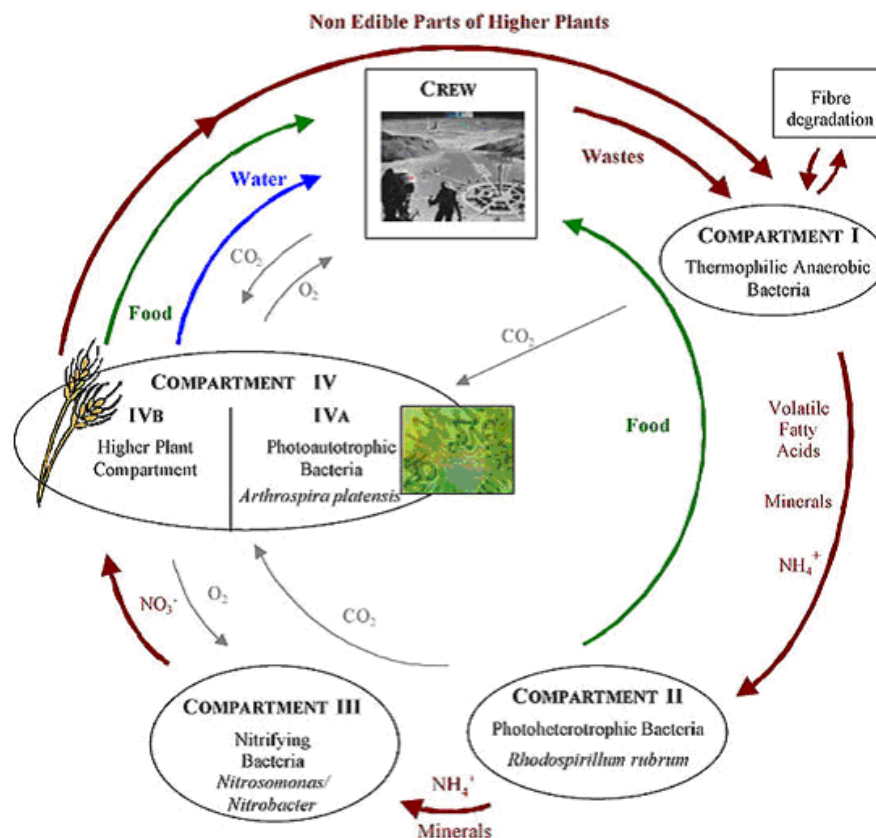

Figure 3.7.: Schematic of the MELiSSA loop. The compartments are: C1 liquefying compartment, C2 phototrophic anoxygenic compartment, C3 nitrifying compartment, C4 photosynthetic compartment. (Lobo and Lasseur, 2003).

A human mission to the moons of Jupiter or Saturn might involve periods of artificial gravity (interplanetary flight) and microgravity (orbital phase around the target moon); so, functionality of the ECLSS under both conditions would be achieved. The ECLSS also would need to perform independently of mission duration, especially for missions to Saturn, as the total flight time can be more than six years.

One or more missions could be dedicated for artificial gravity research in the latter parts of the Theseus Program. A rotating structure with a habitable module and an ECLSS facility could be constructed at Earth / Sun Lagrange Point 1. In this region of space there are no day-night cycles, which gives a simulation of the “visual” environment for an interplanetary trip. For details on rotating structures refer to Section 3.3.7. This structure or small space station would work in both artificial gravity and microgravity conditions, in a crewed or robotic mode, and continuously for several years. After the completion of a full test of the ECLSS facility, a new updated version could be attached to this module and undergo similar testing. A number of techniques could be tested. For example, new methods to transform inedible plant parts into edible materials. This could be accomplished by Biotechnological processing or genetic engineering, or by feeding the inedible parts to fish or various invertebrates (National Aeronautics and Space Administration, 2002; Salisbury et al., 1997). In situ maintenance and environmental monitoring to preclude hazardous conditions (e.g., fire, build-up of toxic contaminants etc.) would be part of the research conducted on the station. The objectives of this space station would be different if artificial gravity techniques prove infeasible, or if the short radius centrifuge proves adequate for human missions to the outer planets (see also Section 3.3.7). In this case, the mission would mainly test ECLSS lifetime.

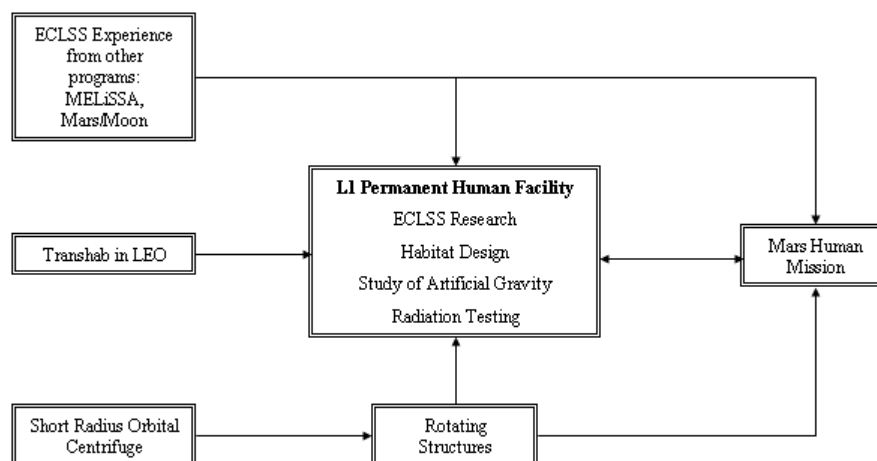

Figure 3.8.: The strategy for the closed ECLSS, Artificial Gravity and the Habitation Module Development.

3.3.7. Artificial Gravity

Some variation of an induced gravity environment has been identified as a critical point in the Development Plan first as it seems to be the most promising short term solution to the host of physiological deficiencies experienced in microgravity, and secondly, because it also represents a solution and vision for an extended and eventually permanent human presence in space. Following this theory from its initial enumerations by Tsiolkovsky and Ganswindt, it is clear that much knowledge has been gained. However, no single structure with this capacity has ever been launched. There are many arguable difficulties associated with this technology, such as subsystem alteration, mass, power demand, spacecraft stability, and human tolerance to rotating environments. Still, not one of these points deem artificial gravity infeasible (Hall, 1994), (Queijo et al., 1998). In fact, all the materials and technology required to commence the space qualification of this technique already exist. The only question now would be how to select the steps that help to develop our on-orbit competencies. The natural progression of investigation then proceeds in a phased structure beginning with short radius centrifugation (SRC) and working toward the development of a continually rotating truss, tethered, or torus structures.



Figure 3.9.: Short radius centrifugation termed the Human-Powered Centrifuge. Courtesy of NASA.

The first phase of this program should focus on the production of an SRC space platform (see Figure 3.9). It is not unreasonably difficult to launch either a new on-orbit platform or utilize the ISS to investigate short radius centrifugation. Utilization and investigation could be implemented in as little as three to five years. Ground based studies show promise as an effective physiological countermeasure, combined with the human ability to adapt to high rotational rates. Hecht, Brown, and Young recently demonstrated human capacity to assimilate to 23 rpm

exposure. Contrary to contemporary views, there were no side effects on 1 g functioning, additionally a transferred adaptation to altered environment and hardware suggest the same response could be expected in space (Hecht et al., 2002). A space platform serves as a crucial step to investigating and understanding vestibular adaptation and otolith function in microgravity. Quantification of the medical aspects such as exposure rate and duration, g-levels, transition between artificial gravity and microgravity, and complete spacecraft integration shall be the targeted goals of this phase.

With the permanent habitation of space in mind, the follow-up phases should focus on the development of truss/tether techniques and torus structures respectively. Table 3.3 briefly displays the advantages and disadvantages of different approaches to continually rotating structures:

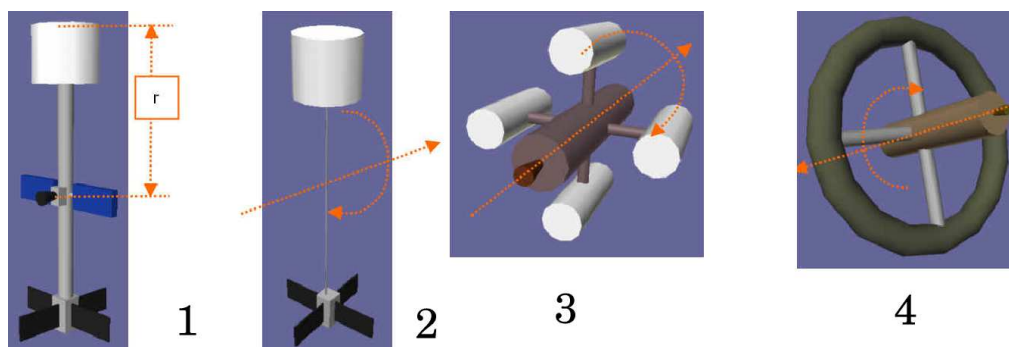

Figure 3.10.: Different approaches to provide artificial gravity; 1: Rigid Truss, 2: Tethered system, 3: Rotating dumbbell structure, 4: Rotating torus.

Proposals such as the Tethered Artificial Gravity Satellite (TAGS) Program would be carried out and significantly expanded on in the future (Hoffman and Mazzoleni, 2003). The characterization of inflatable structures represents a particularly applicable, yet difficult, challenge in controlling a truss or tethered structure. During the second stage, difficulties like changing counter weight mass and spin-up/spin-down dynamics would be encountered. The suggested phases should be conducted in conjunction, rather than independently. Valuable knowledge about large-scale rotational mechanics in microgravity, for example, would be acquired in phase one, and carried over to benefit the other phases. Flight hardware and testing of an operational craft would be the optimal target to be met in subsequent phases.

A committed mission substructure for the development of artificial gravity could potentially be assigned a twenty-year timeline. The second and third phases (development of tethered and rigid rotating structures) would take substantially longer, but given adequate priority, their completion is feasible within a fifteen-year period. For our purposes, the development of a rotating torus would be the most desirable outcome to the program. Other, techniques could be used to mitigate the microgravity effects; however, the rotating torus would also provide a solution to habitation issues, a major concern for long-duration spaceflight.

3. *Theseus: A Road Map for Technological and Scientific Issues*

System	Description	Advantages	Disadvantages
Rigid truss (see Figure 3.10, Item 1)	Habitat linked to a counterweight by a rigid truss structure	<ul style="list-style-type: none"> • Dynamic behaviour well understood • Stability control system less complex than for tethered systems • Spin- up/down operations easier 	<ul style="list-style-type: none"> • ~6 times the mass of a tethered system • Potential vibrational problems
Flexible tether (see Figure 3.10, Item 2)	A simpler design replaces the rigid truss with a tether; a “rope”, essentially, holding the two rotating elements together. This design eliminates still more weight and allows for very long rotational arms (and thus, very slow rotational rates, which minimize Coriolis forces and gravity gradients).	<ul style="list-style-type: none"> • High g-levels possible with slow rotational rates • Mass penalty only 10-20% • Stability good once spun up 	<ul style="list-style-type: none"> • Stability poor during spin-up/down • Dynamics of system problematic if mass distribution changes • Risk of catastrophic tether break • on-orbit testing expensive
Torus/Dumbbell structure (see Figure 3.10, Items 3 and 4)	Composed of an outer rim, using modules (axial or in-plane) at the ends of the “spokes.” This design sacrifices some volume for later expandability to a full torus (if in-plane modules are used).	<ul style="list-style-type: none"> • Large habitable volume • Good stability in all situations • Segmented torus very benign for crew safety 	<ul style="list-style-type: none"> • Very massive • Very expensive • Only on-orbit assembly possible • Requires multiple EVA and launches

Table 3.3.: Different solutions to provide artificial gravity.

While no combination of current countermeasures produce an optimal physiological mitigation strategy, a logical way forward undoubtedly must continue to synergize medical efforts into the development of artificial gravity. Applicable pharmacological methods should be given adequate focus such that the countermeasure efficiency of artificial gravity is maximized. The most applicable area where pharmacological methods are being researched is that of musculoskeletal systems, yet little progress has been made in the past ten years. Based on missions to ISS and Mir, crew lose 1% to 3% of bone density per month and approximately ten to 20% of muscle mass during short missions. Muscle loss exceeding 20% would be highly probable during extended missions (Clement, 2003). Specific examples currently being studied include the use of amino acids to increase protein synthesis and decrease muscle loss, and drug therapies that suppress the accelerated bone reabsorption (University of California, 2004).

Another interesting area of study is that of the hibernation of the black bear. Over a seven-month period of hibernation, the bear loses approximately 25% of the muscle strength a comparable bed bound human would lose and approximately 17% of the muscle protein (Coghlan, 2004). It is also able to provide a mechanism to recycle calcium to prevent bone loss (Nowak, 2004). If the bear's ability to conserve muscle and bone could be replicated, drug therapies could be produced to counteract the effects of muscle and bone loss during a long flight. Should it be fully understood over the next decades, the science fiction of suspended animation could become reality. A regime of seven months in hibernation-like state followed by one month of rehabilitation could be implemented, and this might lessen the psychological strain on the crew during long periods between destinations. Also the mass of consumables that must be carried on-board the spacecraft could be drastically reduced.

In addition, this program should be substantially interwoven with the technical and engineering development steps throughout the Theseus Program. One particularly interesting area of synergy is that of crew habitation. The conjoined investigation and development of a crew module and artificial gravity could provide an innovatively rapid mechanism to solving these issues. This approach would involve experts from almost every aspect of space exploration, including psychology, sociology, machine interface dynamics, nutrition, medicine, and engineering.

3.3.8. Habitation

Habitat design is a fundamental aspect of long duration missions, as the crew will have to endure unprecedented amounts of time in a liveable space. This is contrary to the survivable modules found on the ISS and all previous space stations. Future habitats must be conducive to quality physical and mental health maintenance. In addition to the inherent stress and danger of space flight, long-duration crews will be required to perform challenging and repetitive tasks. Two aspects of habitation that have been largely neglected and require specific atten-

3. *Theseus: A Road Map for Technological and Scientific Issues*

tion are sociological and psychological. To ensure the success of any crew, the monotonous and artificial components of current space structures would have to be significantly diminished. Shifting from a technological (mass reduction) design perspective toward a more balanced approach. This design should emphasize human factors and elements more carefully and will enhance the productivity and success of extended missions (Harris, 1996). For a mission to the outer planets, the time spent transferring to and from the destination is about 98% of the entire mission duration. Hence, the majority of the habitat design should be focused on the transfer spacecraft (in-flight) rather than a surface module



Figure 3.11.: The proposed design for the Transhab, that was originally designed to be part of the International Space Station. It is comprised of three main sections that provide different capabilities to the crew. Courtesy of NASA.

There are no major technological barriers standing in the way of building a habitat interior designed for improved quality of on-board living for long duration missions. The limiting factors remain the mass and power barriers of launching large modules into space and then propelling them to their destination. Otherwise, the habitat could easily be much larger, providing spacious personal crew quarters and communal areas for eating, relaxing and exercise. Therefore, with current launch technology, an emphasis on modules that can be expanded from their launch volume by inflating or using shape memory metals may provide a viable alternative to launching large and heavy structures. The Transhab proposal

was an ideal developmental step toward proving an inflatable habitat concept, and would satisfy many of the requirements for a mission to Europa or Titan. Its design addressed many of the psychological and sociological problems that had been neglected previously, as well as providing many new technical solutions. It would also be possible to link more Transhab-like modules together with nodes to achieve a larger volume. In addition to the inflatable concept behind Transhab, a prototype module was built for Russia's Mir space station in the 1980s using shape memory materials to expand from a diameter of 4 m to 12 m (N. Tolyarenko, private communication, 2004). The technology exists to build these modules; they just need to be space qualified. The advanced habitat design specifications are outlined below:

- Produce several habitat configurations and designs. These should be representative of different cultures, nationalities (if international mission), ages, and genders.
- Perform ground isolation tests using mock-ups of the different designs using groups representative of the size and makeup of the potential crew.
- Perform parabolic flight tests of specialized equipment that has been designed for use in microgravity (Susmita, 1997; Volger, 2000).
- Research, develop, and space-qualify new technologies for habitat modules: Inflatable structures that autonomously deploy and consolidate back to their original non-deployed configuration and shape-memory deployable habitats should also be researched.
- Combine designs to generate a preferred habitat, which should then be built and flown in LEO, as Transhab was to be tested docked to the ISS. This will prove its functionality in a microgravity and space environment, so that all features can be easily used and accessed by the crew.
- Use the feedback from habitat modules used in human missions to the Moon and Mars to design an improved version for longer duration missions, such as to Europa and Titan. Habitability is a major research element for the Mars development programs. For the Aurora Program, this would be considered to be a milestone (Andrew, 2001).
- Conduct studies and take experience from Mars missions to determine how many different habitats will be necessary for the mission; i.e. Are separate habitats better than one multi-function habitat?
- Methods of artificial gravity should be designed into the habitat module, as this is a crucial aspect of sustaining the life of the crew. A short arm centrifuge could be easily integrated into the habitat for use during exercise, work, or sleep. For testing tethered systems, more research is necessary before test flights on the scale of a habitat module could occur. In this case,

3. *Theseus: A Road Map for Technological and Scientific Issues*

the proposed small space station at L1 for closed ECLSS studies (see Section 3.3.6), could be used to test the habitation module and the ECLSS in a artificial gravity environment.

- Finally, the habitat could be used on human missions beyond Mars, such as orbital missions to the moons of Jupiter, before landing on Europa or Titan.

Several of the steps needed to prove technologies and gain knowledge to make design decisions could be done on precursor missions to the Moon and Mars that would be necessary to meet other science objectives and test other technologies.

In addition to the major steps mentioned above, there should be a continuous process of testing new designs and concepts of habitats on human missions, and analysing how much they mitigate psychological problems. The crucial factors are the volume and the available mass of the habitat, since larger crew quarters and communal areas have a positive influence on the psychological state of the crew (Kennedy and Capps, 2000). Better facilities and more luxuries could be included in the habitat. However, there are several other features of the habitat that require improvement before they can be regarded as liveable for a long-duration mission. These include beds, showers, noise reduction, sensory stimulation, and in general a continual increase in habitable volume. Several studies have suggested new designs for showers and beds, attempting to make them more comfortable, thereby reducing stress levels (Volger, 2000). Additional recommendations have been made concerning the separation of hygienic and exercise areas from communal and sleeping quarters in an attempt to further the creation of Earth-like setting.

Once functional and comfortable elements have been created, the crewmembers should also be able to experience many of the sensory stimulations that are available on Earth, such as smells, sights, sounds, tastes, and touch. More specifically:

- **Sound:** Rather than the continuous humming of fans, relaxing music could be played, such as ocean or wildlife sounds.
- **Smell:** Instead of the stale smell of an enclosed space, the air could be infused with fragrances recreating the smells and experiences of a forest, the sea, or flowers - smells that are common on Earth but absent in space.
- **Touch:** As an alternative to the uninspiring plastic and metal surfaces that normally cover habitat interiors, the senses of touch and sight could be stimulated by wood, felt, carpet, or even grass on appropriate surfaces.
- **Sight:** The walls could be covered in murals or pictures for the crew to enjoy. With the advent of flat screen TVs there is the possibility of having “windows to the Earth” that would continuously project views from Earth of beaches, mountains, the view from the window of a crewmember’s home, or function simply as a television. This also raises the possibility of interactive visual effects during exercise and could easily be done with current

technology. The progression of virtual reality in the near future, will make this possible to be in 3D, and quickly adaptable to recreate many situations.

- **Variation:** It is also vital that the living environment does not remain the same for the entire journey. A static environment becomes boring after a while, resulting in the behavioural deficiencies mentioned previously. There should be variation in daily routine, lighting conditions, noise, and communication with the ground. For instance, the lights can be made to automatically mimic the natural cycle of sunlight illumination (Bedini, 2003).

It would be beneficial from a psychological point of view to integrate some aspects of the closed ECLSS into the habitat design. For instance, if the food production areas were spread around the communal and individual areas this could lift the spirits of the crew because they can see greenery and other forms of life surviving and growing (Myers, 2002). As well, other living creatures, such as fish, which may be taken on the mission for scientific reasons, or even for food, can also help give a psychological boost to the crew.

Finally, communication with Earth is crucial for such a long-duration mission. The crew should have access to television shows and movies for relaxation, as these will not be greatly affected by the transmission delay time. Virtual reality using recorded messages will hopefully provide more intimate interaction between the crew and their loved ones back home to overcome the problem of delay time.

3.3.9. Radiation Protection

Without adequate radiation protection, human missions beyond Mars could be greatly inhibited, restricting destination decisions. Radiation mitigation techniques would enable a more flexible mission architecture. The duration of mission operations on the Jovian system would be increased, and if advanced protection techniques prove feasible, direct human presence on Europa (or any other moon within the radiation belts of Jupiter) might be possible.

There are a number of solutions to mitigate the effects of radiation. While none of these independently are adequate enough to fully protect the crew, a combination could be used to provide the required mitigation. In brief, the solutions proposed are:

- The use of carbon nanofibers (hydrogen enriched) for the spacecraft structure. These materials are very lightweight and in the same time very resistant to radiation; however, in extreme environments (Europa) or for Coronal Mass Ejection events (CMEs), their capabilities are limited (de Angelis et al., 2003).
- Injecting plasma in a magnetic field creates a small magnetosphere, which is larger and stronger than an individual magnetic field (Winglee et al., 2002). This magnetosphere could extend a few hundred kilometres and protect

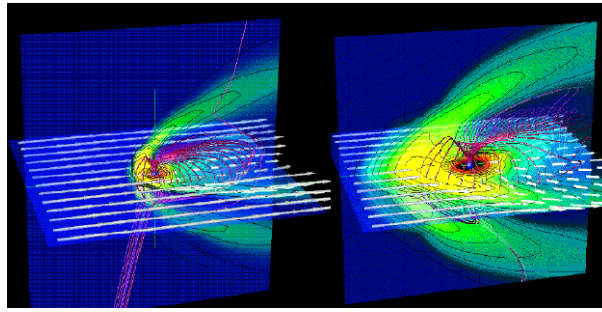

Figure 3.12.: The illustration on the left shows the deflection of the solar wind by a single dipole, while the picture on the right shows how this interaction is modified if the magnetic field is inflated by plasma. The radiation shielding capabilities of this configuration are obvious. Picture taken from (Winglee et al., 2001)

the astronauts in a way similar to the protection by the Earth's magnetosphere. This concept was originally proposed as an advanced propulsion technique (Mini - Magnetospheric Plasma Propulsion — M2P2) (Winglee et al., 2000). However, because of the large currents that would be needed to create a strong magnetosphere (C. T. Russell, personal communication, 2004), we propose the use of superconducting magnets in conjunction with the plasma injection. In addition, for surface operations, the ground will absorb a large percentage of the injected plasma, so a strong magnetic field will be needed to counter the incoming radiation. Computer simulations have shown that these techniques might shield the spacecraft from GeV energies of cosmic rays (Landis, 1991).

- It has been demonstrated that some humans living in very high natural radiation areas have acquired highly adaptive responses to external radiation. Therefore, it is suggested that for a deep-space mission, the adaptive response of all potential crewmembers be passively measured, and those with enhanced response should be given selection preference (Mortazavi et al., 2003).
- As far as pharmacological countermeasures are concerned, in areas such as side effects from low dose rate radiation exposure during long-term spaceflight, little is known. Chemicals such as Aminonpropyl-aminoethyl thio-phosphoric acid (APAETF) have been shown to decrease the side effects by a factor of three, but it is unlikely that medical advances (at least in the next twenty to thirty years) will yield drugs which will completely mitigate the effects of exposure. Pharmacological intervention alone will probably not provide adequate protection to solve all the radiation problems associated with a mission to the outer planets. It will have to be used in combination with other techniques such as shielding, diet, exercise, and possibly even genetic engineering, to mitigate the effects of long-term exposure of the hu-

man body to the radiation environment.

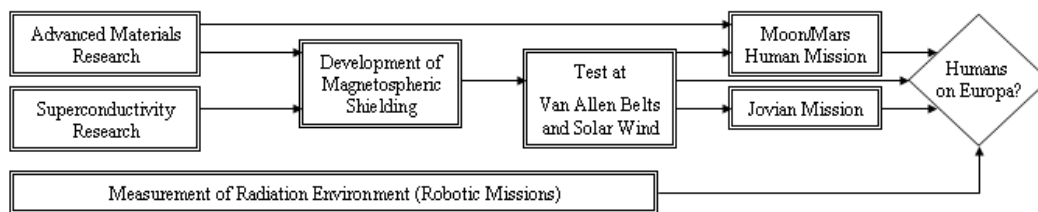

Figure 3.13.: The strategy for radiation shielding: A series of tests in Earth and space will prove whether we will be able to directly explore Europa with humans

The main strategy against radiation would be the magnetospheric shielding. However, this involves long-term exposure of humans to strong magnetic fields. To avoid interference, layers of material with high magnetic permeability (ferromagnetic) could be used on the walls of the inhabited region of the spacecraft. In Figure 3.14, the circular domain represents a cutaway of a supposed cylindrical module. The walls of the module are simulated to have a magnetic permeability 10,000 times greater than the region to which the dipole field is applied. Typical ferromagnetic materials are nickel, iron, cobalt, and their alloys. However, the astronauts would be directly exposed to the magnetic field during EVA, and this issues must be resolved.

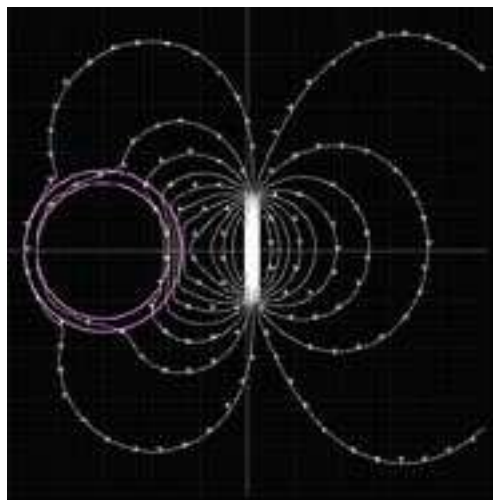

Figure 3.14.: In this simple representation, it is evident that the magnetic flux is increased on the cylindrical domain, which is comprised of ferromagnetic materials, and reduced (by about four orders of magnitude) in the internal area. The strengthened magnetic field on the walls will also be effective in deflecting particles that manage to penetrate the magnetic dipole field.

3. *Theseus: A Road Map for Technological and Scientific Issues*

The necessary steps that must be taken to qualify the shielding techniques include:

- NASA has an active research program toward the research of passive radiation techniques (with materials) (Schimmerling, 2003; Wilson et al., 1997). Research should continue, with more emphasis on hydrogen enriched carbon nano-fibers. Adaptive studies should be ongoing throughout the *Theseus* Program. Experiments can take place with rats on the ground and in space (e.g. International Space Station).
- Continue laboratory simulations of the M2P2 and emphasize more the aspects of magnetospheric shielding. For more information on the current laboratory simulations, refer to (Winglee et al., 2001).
- Large areas on Mars and the Moon are dominated by surface magnetic anomalies (Connerney et al., 2001). The radiation levels of these regions should be studied, as they represent a good analogue of the proposed magnetospheric shielding. There are already some positive results from the Martian Radiation Environment Experiment (MARIE) experiment on Mars Odyssey (Alves and Baptista, 2004). In addition, the radiation environment of Ganymede should also be explored, as it has a magnetosphere that lies within the Jovian radiation belts (Kivelson et al., 1998). This will likely be investigated by JIMO (see Section 3.3.1).
- Space-qualify M2P2 and magnetospheric shielding using a mission that tests the performance of M2P2 within the Van Allen Belts (slightly similar to the radiation belts of Jupiter) and in the solar wind. The magnetosphere can be produced by injection of plasma to a single dipole field or to a configuration of more than one dipoles. The spacecraft electronics and communications subsystems should be designed in a manner so to accommodate the strong magnetic and plasma fields. Increased power of the radiofrequency (RF) signal should compensate for the plasma environment. The possibility that harmful radiation belts for the crew would be created within the magnetosphere should also be examined.
- Introduce superconductive magnets to the magnetospheric shielding technique: While superconducting magnets are now standard technology, research should take place in order to produce superconductors with high magnetic strength to weight ratio. Enabling high temperature superconductors will also increase the simplicity of the spacecraft design (Landis, 1991).
- Should the initial results of magnetospheric shielding prove promising, space-qualify this method for human spaceflight. Tests could take place in LEO missions or human missions to the Moon or Mars. The interaction of humans with magnetic fields should be carefully considered before these demonstration missions take place.

- Test the magnetospheric shielding method at the radiation environment of Europa using a robotic mission. This will be crucial in deciding whether humans can be sent directly to Europa or if such a mission should be avoided. The mission can also take advantage of the propulsion that is produced on the mini-magnetospheres in order to reach Jupiter. The I_{sp} of M2P2 is estimated to lie between 30000 – 80000 s and has a thrust of a few Newtons (Winglee et al., 2000). The spacecraft will enter in orbit around Jupiter, at the altitude of the European orbit. It should employ radiation instrumentation that would measure levels in the surrounding environment. The magnetosphere should be rotated in various directions to detect the optimal geometry for the radiation belt-magnetosphere interaction.

This test would prove whether the proposed shielding techniques are adequate for direct exploration in the extreme radiation environment of Europa. If the results are negative, the only solution for the exploration of Europa by humans would be the establishment of a base on Callisto and the implementation of tele-operated robotic missions on the surface and the subsurface of Europa. For the exploration of the Saturnian system, it is expected that the proposed shielding techniques would be sufficient; however, this can only be verified after extensive testing with the suggested road map.

3.4. Additional Technologies

The accomplishments defined in the development plan include research in seven main areas of technology: advanced propulsion and power, ISRU, ECLSS, artificial gravity, habitation, and radiation protection techniques. This does not imply that these are the only critical technologies for human missions to the outer solar system. An additional number of technologies are also significant; however, it is expected that these would be adequately developed for other space applications, such as remote sensing, Mars exploration, telecommunications, etc. A brief outline of these technologies is presented below:

Autonomous Robotics

Due to the time lag for any signal sent from the Earth to Jupiter or Saturn, the robotic missions to Europa and Titan would need to be almost fully independent from Earth. The Earth-based control center should only provide the robotic probes and orbiters mid-term and long-term information. This level of autonomy is still in its development phase; an example of the research is the DARPA Grand Challenge, which aims for the development of autonomous vehicle technologies (Defense Advanced Research Projects Agency, 2004). This technology is also expected to develop within future Mars Sample Return missions.

Robotic Assistance

The capabilities of any human mission rely on the degree of synergy between the crew members and their robotic assistants (Landis, 2003). This is particularly true in hostile environments such as Europa. A broad range of activities will require specific capabilities like drilling, mining, scouting, and driving. Hence, the need for robots is obvious. Telerobotics seem very promising for the remote exploration of an extreme environment (especially if the radiation shielding techniques prove inadequate), or simply minimize dangerous crew tasks to the greatest extent possible. The current Robonaut project at NASA is one example of the possibility of robots replacing humans for EVAs (National Aeronautics and Space Administration, 2004a).

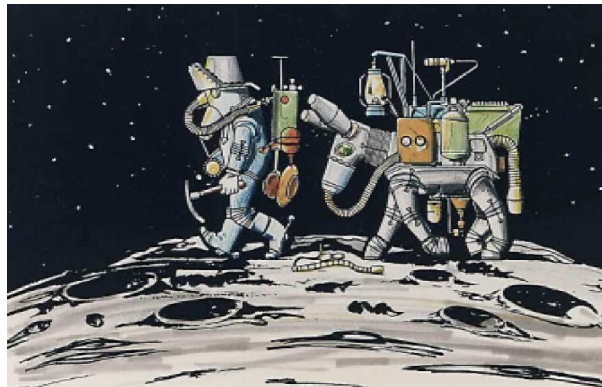

Figure 3.15.: ‘The robotic mule’: Follows astronauts with equipment, could extend the capability of humans prospecting space in the same manner that mules provided support for gold prospectors and precious minerals in the American Wild West (cartoon by NASA, courtesy D. Linne and G. A. Landis, extracted from (Landis, 2003)).

Ground-based and near Earth-based astronomical instrumentation

The scientific return of a dedicated mission is still several orders of magnitude higher than direct observation from the Earth, although some efforts have been made to gather useful data with existing instruments, such as the Goldstone and Arecibo radio telescopes (10m mapping of Venus, in the 1970’s and 1980’s (Herrick, 2004)) and the ESO Very Large Telescope (200 km resolution imaging of Titan in February 2004, (Coustenis et al., 2004)). However there are more than one hundred moons in the outer solar system and only a few of them have been imaged using adequate resolution. Sending probes to all of them is not feasible. Current developments in astronomical instrumentation will lead to bigger and better telescopes and interferometers (such as the Planet Imager project at NASA (National Aeronautics and Space Administration, 2004b)). Although it is not their main purpose, such facilities will be able to provide the scientific community with high-resolution mapping (down to a few meters) of the Jovian and

Saturnian moons.

Laser Remote Sensing

Scientific instrumentation based on laser technology, such as Laser Induced Breakdown Spectroscopy (LIBS) and Raman spectroscopy look very promising. (Wiens et al., 1997), (Wang et al., 1998). Large effective optics, high-powered lasers and high-performance gratings will soon be state of the art. However, they will still need to be integrated together to implement a remote laser sensing system. Orbiters would then be able to complete most scientific objectives previously dedicated to landers, such as soil characterization and surface astrobiology. In addition, during the interplanetary transit of proposed missions, close flybys of asteroids or comets could possibly occur, creating greater opportunities for scientific observations.

Medical systems

Any signal sent from Earth will take about one hour to reach Jupiter, making telesurgery infeasible. However, several other types of telemedicine remain feasible. The time lag could easily be taken into account when designing specific medical procedures, such as medical check-ups or psychological interviews. The current trend in telemedicine development will lead to a good understanding of the potential application of this technology to a human mission to the outer solar system. The likelihood of surgery during a long-term trip is not negligible. Performing surgery in microgravity or in a low gravity environment is highly complicated. Therefore, a few crew members must be trained as surgeons, and specific medical equipment must be designed. Accordingly, the medical and technological basis for such hardware would be developed in the frame of any human mission to Mars. They will then probably need to be scaled up and slightly improved to account for the longer duration of a trip venturing toward the outer solar system.

Telecommunications

The communications system is a key part of any human mission. A constant connection to the Earth can be easily implemented using two Geostationary Earth Orbit (GEO) satellites. It is also expected that future developments in telecommunication technology will provide an adequate data rate to the spacecraft. Optical communications or high power Radio Frequency (RF) communications would likely be part of future robotic and human missions.

Heavy Launch Vehicles

Human missions to Mars and the outer planets are expected to rely on heavy launch capabilities. The alternative would be the use of multiple twenty to thirty

3. Theseus: A Road Map for Technological and Scientific Issues

tonne launches, however the ISS project has proven that this is not the most efficient method. We expect that a heavy launch capability will be enabled for missions to Mars. As such, heavy launch vehicle development will not be a part of the Theseus Program. Time will tell whether or not these launch vehicles (LV) will be reusable (RLV), expendable (ELV), or a combination. The Saturn-V (approx. 100 t. in LEO), the Energia (approx. 100 t. in LEO), and the Vulcan LV (approx. 170 t in LEO) could give us some idea about how a heavy ELV might look. The Energia-2 (see Image 3.16) is one of the few heavy RLV ideas that has been studied extensively, as well as the Shuttle-C concept (Wade, 2004). The technology of these vehicles will not be much different from that of today's LVs, unless legal barriers preventing the use of nuclear sources are removed.

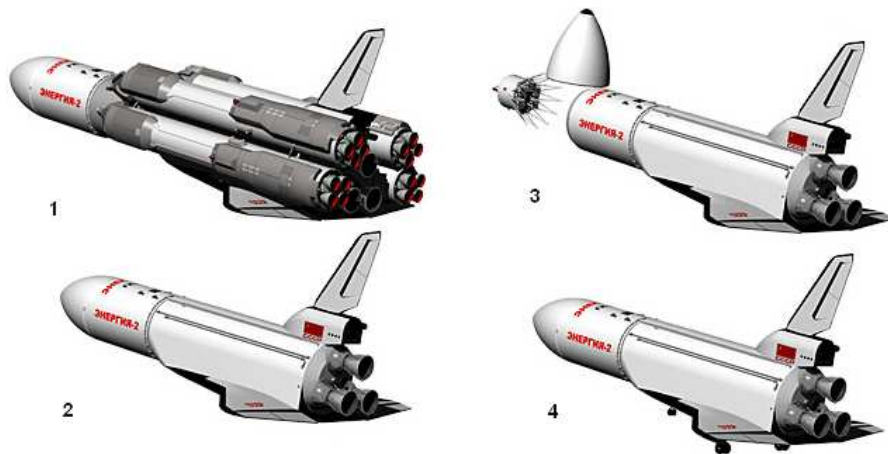

Figure 3.16.: The Energia-2 concept, one of the few concepts studied for RLV with heavy lift capabilities (Lukashevich, 2004).

3.5. Conclusion

In this chapter, the road map for the Theseus Program was presented. The plan describes our suggestions and ideas regarding space missions, ground research, and strategies that must be adopted in seven areas of science and technology. These steps would pave the way for the human exploration of the outer planets. The plan focuses mainly on the exploration of Europa and Titan, however numerous capabilities are enabled through Theseus. The technology and the knowledge that will be the outcome of the development plan can be used for the planning of missions in Callisto, Ganymede, and many of Saturn's icy moons.

It is envisioned that this plan can be completed in a time frame of fifty to seventy years. However, the duration of Theseus will be dependent upon the timing of the first human mission to Mars. It is reasonable to assume that such an event will occur before any attempt to explore the outer solar system. However, in the same time, the developments for Mars missions are expected to have significant value, especially in technological areas. Two already existent strategies, the

US Initiative for Space Exploration and ESA's Aurora Programme, have helped us identify key technologies that will be significantly developed for the human exploration of Mars.

The successful completion of the Development Plan marks the point after which the design of a human mission to the outer planets is enabled - the preparation of which will take several years. Additionally, numerous other issues will have to be resolved as they relate to mission design (for example, crew selection, training, spacecraft configuration, etc.). These issues are discussed in Chapter 5.

In any case, an attempt to create a Development Plan enabling human missions to the outer planets is not an easy task. It is a complex undertaking, which, like space mission design, has many alternative solutions. However, we believe that the Theseus Program is an effective and realistic solution to this problem, and could reflect the future of the space exploration.

3. Theseus: A Road Map for Technological and Scientific Issues

[The] day will come when we put men on Mars or accomplish some other feat where the human factor makes it possible to achieve something that technology, no matter how brilliant and advanced, cannot.

Gene Kranz

4. Theseus: Program Management

4.1. Introduction

Before humans can journey to the outer solar system, many advances are needed in both technical and program-based areas. In many development plan reports, the technological and scientific work is examined in great detail, as this is the nature of science and engineering. However, often the less rigorous and more abstract fields of policy, economy, and sociology are covered only briefly. Despite the fact that developments in these fields are far more difficult to foresee, the foundations upon which technological advancement and utilization are enabled is infrastructure, legal sources, and funding. Some level of program management must be established before even the most simple research and development work may begin. Thus, in this chapter, the following elements are analyzed with respect to a goal of enabling a human mission to the outer solar system:

- Legal issues
- National and international policy
- Motivation
- Organization and management
- Economic considerations
- Outreach and education
- Ethics and social implications

Most of the above points are considered as they relate to four different program management scenarios, outlined below. Legal issues, however, merits its own section as there are some general points that need to be independantly discussed. Outreach and ethics are also dealt with seperately after the scenarios, as these two areas are relatively independant of the organizational, financial, societal, and political environments that may exist.

The scenarios represent different possible futures determined by a variable world environment, especially as it relates to organizational structures, political frameworks, and economic situations. It is impossible to predict exactly how the world may change in upcoming years, and it is for this reason that this approach

4. *Theseus: Program Management*

was chosen. For example, consider the world events of the last twenty-five years: The USSR disintegrated, contributing to the end the Cold War; saw a number international conflicts occurred as well as a new rise in terrorism; witnessed the unification of most of Europe; the Space Shuttle, Mir, and International Space Station sent into orbit; and China showed incredible economic growth.

Another reason for using this approach is the high level of innovative development and overall complexity of the proposed plan. As an analogous situation, consider the evolution of transportation in the past century. People have gone from traveling on primitive roads in horse and buggy to routinely flying internationally in a matter of hours. Now consider this all from the viewpoint of the first inventors and science-fiction writers: some of their wildest fantasies have been surpassed, while other ideas have been too difficult or even impossible to implement. While it is safe to assume that similar technological advances in transportation and space technology will occur in the upcoming 100 years, it is impossible to make concrete predictions.

Third, the Theseus Program is dissimilar enough with respect to all past projects - space related or not - that the use of parametric or analogous program management planning is not feasible on its own. For example, some might consider that our Development Plan could be likened to that of NASA's Apollo Program. However, as this program occurred at the very beginning of the age of spaceflight, everything had to be invented from the ground up, including the spacecraft, engineering processes, and public-relations guidelines. This is not the case with our proposed plan; although many new ideas need to be developed and modified, the basic foundations from past space programs are already in place. In addition, the political environment under which Apollo was conceived will likely be quite different than the environment under which Theseus and subsequent missions to Europa and Titan would occur.

It is possible to envision an endless number of future scenarios and it is impracticable to try to account for them all. This section attempts to describe four of the most likely scenarios based on potential world situations at the time of program implementation. It is not suggested that the future will necessarily follow one of these situations exactly or even at all. However, the scenarios represent a variety of situations and demonstrate how political, financial, legal, and social implications may affect each accordingly. The scenarios are outlined as follows:

- **Publicly Funded, International:** One nation initially heads a collaboration of the space agencies of all interested nations. Each participates and finances the project to according to its interest and/or capability. Eventually, an International Space Consortium is formed to better facilitate international cooperation for human missions to space.
- **Non-Profit Organization:** Run by a private non-profit organization, this scenario allows several nations to share space competence. Public space agencies, private organizations, and individuals cooperate together in order to succeed.

- **Privately Funded:** Space commercialization explodes, resulting in a major increase in launches, international cooperation, and drastic advancements in technology. Public interest and overall access to space increase dramatically, and space exploration is primarily profit-driven.
- **Major Societal Shifts:** Large scale shifts in society's perception have occurred, changing the motivation for space exploration. In the first situation, a new space race is in progress and space travel is exploited as an arena for technological advancement and demonstration, as well as national achievement and pride. In the second case, extraterrestrial life has been discovered, changing the general public's views of mankind's place in the universe.

A program management infrastructure is useless unless it can be intimately connected to other project aspects. Efforts were made to link these scenarios to the events outlined in the Theseus Program, described in the previous chapter, as well as to the starting point of the Case Study, outlined in the following chapter.

This chapter concludes with a section describing the overall cost of the Theseus Program. As is explained, figures were computed for the scientific missions involved in the development plan, but no definite amount is given for the cost of the overall plan. Instead, a rough calculation is made, the best estimation available at this time due to the large timescale and complexity, as well as the strong dependence on how policy, motivation, and organization will evolve in reality.

4.2. Legal Issues

In terms of a legal framework for the Development Plan, the existing documents are largely acceptable. However, there are certain areas that should be modified to allow such a plan to take place, particularly if it is to be pursued via international cooperation.

Outer Space Treaty (OST): Adopted by the General Assembly and entered into force on 10 October 1967, with ninety-eight ratifications and twenty-seven signatures (UN COPUOS, 1967), (ISU, MSS 04, 2003). The OST provides a good basis upon which to develop a comprehensive set of legal tools relating to space exploration. However, a number of the terms are still vague or ambiguous, leaving the entire document open to interpretation. For example, the term 'peaceful purposes' is unclear. Does it refer to 'non-aggressive' or 'non-militarization'? These terms must be defined or a more clear set of legal documents must be developed before proceeding too far with the Development Plan.

Rescue Agreement: Adopted in 1968 (UN COPUOS, 1968), (ISU, MSS 04, 2003). This agreement provides a good framework, but requires a few revisions. For example, the term 'launching authority' is currently defined as 'the State responsible for launching.' This phrase is rather vague and should be more exact, as it is possible to have two or more launching States (Jasentuliya, 1999).

Furthermore, procedures for search and rescue operations need to be outlined. The Rescue Agreement would not likely apply to a human mission to Europa or

4. *Theseus: Program Management*

Titan as it would be very difficult, if not impossible, to rescue astronauts at such great distances. New provisions need to be written to provide guidelines for accident or distress, or in the event of an emergency landing, whether on Earth or another planetary body. Would such a rescue operation be worth the added risk, cost, and effort? As seen here, legal issues cannot be considered independently of other aspects; they inevitably spill over into the realms of ethics and philosophy.

Liability Convention: Adopted in 1972 (UN COPUOS 1972), (ISU, MSS 04, 2003). The Liability Convention is a good document with respect to ownership and responsibility of spacecraft and their component parts. Unfortunately, it is not appropriate when humans are included in missions. Prior to the Europa/Titan mission, efforts would have to be made to ensure that all crewmembers are covered by the same legal directives and are subject to the authority of the spacecraft commander. Therefore, a central and task-specific group should be formed to design a set of applicable procedures, which would most likely come in the form of bilateral agreements.

When considering possible collaboration between countries, the difficulty naturally lies in harmonizing the different standards. For example, when drafting the Code of Conduct for the ISS, multiple legal concepts defining harassment needed to be considered. In the end, to accommodate the multiple views, the Code of Conduct simply calls for the need to “maintain a harmonious and cohesive relationship among the crew and assure an appropriate level of mutual confidence and respect” (Farand, 2002).

Criminal jurisdiction on interplanetary missions must also be considered. On the ISS, as specified in the Intergovernmental Agreement (IGA), each nation may exercise criminal jurisdiction over their respective nationals. On an interplanetary mission, it is possible that such a system could also be used. However, due to the long duration and the fact that all elements and crewmembers are set before launch, it would be possible and far more useful, to create one consistent set of rules regarding the overall jurisdiction of both the craft and crew.

Registration Convention: Adopted in 1975 (UN COPUOS, 1975, (ISU, MSS 04, 2003). This convention would provide an efficient means by which to monitor the objects launched into space and ensure that participating countries comply with all regulations of the venture.

Moon Agreement: Entered into force on 11 July 1984, with ten ratifications and five signatures (UN COPUOS, 1979), (ISU, MSS 04, 2003). With so few signatures, the importance of this agreement shall depend on the States involved. If none are party to the agreement, the OST shall be the only relevant convention.

If some or all of the States are party to the Moon Agreement, modifications must be made. This applies especially to Article IX, the Planetary Protection Clause. The law only states that a conscientious effort should be made to avoid as much contamination as possible, both of celestial bodies by Earth sources, and of Earth by extra-terrestrial sources. Of course, contamination is impossible to completely prevent, but steps should be taken to minimize human effects on planetary bodies. However, until more information is available about the possible types of contamination from Europa and Titan, it is difficult to precisely define ways in

which back contamination may occur (Spacelawstation, 2004).

Nuclear Testing: As stated in Section 3.3.4 of the report, we have long used nuclear generators on probes to the outer solar system, including Pioneer, Voyager, Galileo and, most recently, Cassini. However, there is still some hesitance in using nuclear propulsion for human spaceflight. In order to overcome the apprehension, the necessary steps include:

- **Base technologies:** A serious definition of the base technologies required to build multi-MW_{th} nuclear thermal reactors and develop them is needed.
- **Projects:** Advocating projects such as Prometheus, the SP-100 Power Source Project, and ITER will improve societal perception.
- **Development and testing:** Prototype reactors can be built and tested prior to committing to a final design.
- **Robotic Missions:** Further testing of nuclear power on proposed scientific robotic missions, e.g. JIMO, will increase public support.

The “Principles Relevant to the Use of Nuclear Power Sources In Outer Space” recognizes that for some missions in outer space, nuclear power sources are particularly suited or even essential due to their compactness, long life, and other attributes (United Nations Office for Outer Space Affairs, 2004). Therefore, as long as the correct safety procedures are followed during the testing of nuclear technologies for our mission, this declaration should not greatly affect our development plan and venture.

4.3. Possible Future Scenarios

As previously mentioned, for this mission, program management describes various plausible scenarios of the future, which are summarized in Table 4.1. Suggesting several possible schemes that could fit into various potential future environments was determined to be more valuable than describing a single scenario. Each considers issues such as technological advancements, changes in government structure, and shifting space priorities. The scenarios given are based on a publicly funded mission, an international foundation, a fully commercial operation, and major societal changes. A discussion of the policy, motivation, organizational structure, and financial considerations, as well as any additional particularities follows.

Scenario	International Publicly-Funded	Non-Profit Organization	Private Foundation	Major Societal Shift A: New Space Race	Major Societal Shift B: Discovery of Life
Policy	National Security; Technology transfer; Sustainability	Collaboration between public and private sectors	Possibility and likelihood of profit	National and Political Prestige	Global Endeavour; study and/or contact other file forms
Motivation	Research; Exploration; Science; Int'l cooperation	Research Exploration; Science	Financial return	Prove national superiority	Education; Science; Religion; Social
Organization	Int'l Space Consortium (ISC) initially led by dominant organization	Sahred venture between public and private sectors	Modeled after the X-Prize Foundation	Space agencies and military support	Int'l, non-governmental organization
Finance	Similar to ISS	Public funding with private sector investments	Organizations; Fortune 500 companies; individuals	Public funding	Scientific and philanthropic organizations; religious groups; military; individuals
Legal Issues	New agreements based on existing	Regulations regarding the foundation	Non-appropriation; property rights	Militarization of space and appropriation	Need regulations on the extent of study of foreign organisms

Table 4.1.: Summary of possible future scenarios.

4.3.1. International, Publicly Funded

Scenario

This scenario starts with the recent US Space Initiative by President Bush calls for a redirection of resources while shifting priorities to human missions to the Moon and Mars. NASA assumes an initial leadership role, with several other agencies participating on varying levels. While it is possible that by the time the actual mission is conceived, there will be several countries capable of taking on a leadership position. However, currently NASA is the most likely candidate for this responsibility. During the first phase, NASA is responsible for outlining and managing the overall plan, with other countries taking on secondary and tertiary roles depending on their needs and/or capabilities. This is similar to the existing ISS agreement, in which NASA is accountable for most aspects and decisions of the station, with other countries' responsibilities dependent on the amount of money and resources that they contribute.

Policy

History has shown that creating a space policy to support the development of human missions beyond LEO is an arduous task, as past space endeavors have been linked to larger foreign policy issues that revolve around complex national agendas. A policy supporting the Theseus Program would undoubtedly be subjected to similar unforeseen issues. In addition, the long time scales considered would cause progress to be plagued with short-term administrative changes and a shifting global politico-economic atmosphere. In the United States, each administration since President Eisenhower has issued a unique space policy statement (Hastings, 2004), thus continuously altering NASA's focus and making their direction unclear.

It is without question that developing a concrete space policy is a daunting task, yet a starting point has been provided by the previously-mentioned US Space Initiative given on 14 February 2004. The policy lays down logical steps for a vision that is compelling, affordable, achievable, and most importantly, focused (NASA, 2004c). Additionally, international cooperation is stressed in order to strengthen partnerships between the US, Russia, Europe, as well as other space-faring nations. Global space policy needs to be extended to encompass a truly international environment. All nations involved would need to align their national space interests with the goals of the international vision.

There exists not only the need for innovative technologies, knowledge, and infrastructures, but there are also several factors that must be given consideration:

- **Sustainability:** Both public interest and political support of space activities must exist for the entire duration.
- **National Security:** No single nation will agree to jeopardize their security, even in the name of space exploration. Initiatives to create national protec-

4. *Theseus: Program Management*

tion while fostering international cooperation must be considered in order to ensure success of the mission.

- **Technology Transfer:** Similar to concerns about national security are those associated with technology transfer. Countries tend to be competitive and are wary about sharing such information as might allow other countries to gain equal competencies in a given arena, such as military or space.
- **National Prestige:** Participation in historic events is associated with national prestige. Countries want to partake in a program that will bring them honor and respect, whether it be within their own country or the international arena. Their future cooperations and standing are often based upon their past accomplishments.

Although these four issues represent daunting challenges to developing a viable policy, they can be mitigated by ensuring that each item receives the necessary attention.

Motivation

The primary driver of a publicly-funded mission would be scientific exploration; inability to provide sole support and furthering international relations are motivations for making it an international endeavor. As a result, established policy would need to be able to exploit the special benefits that space technologies can deliver in support of every nation's policies and objectives. More specifically, it will need to encourage economic growth, job creation, industrial competitiveness and sustainable development, and security and defense. The advantages and disadvantages of international collaboration are summarized in Table 4.2.

Organization and Management

Space endeavors over the past forty-five years have generally been undertaken by single nations, with a few notable exceptions such as the Apollo-Soyuz Test Project. More recently however, space activities have become more international. To date, the most successful venture of this kind space endeavor has been the International Space Station, in which sixteen countries participate. The IGA for the ISS involves the US, Russia, Europe, Canada, and Japan, and governs the responsibilities of construction and use of the station. Memorandums of understanding (MOU) also exist between NASA and the other agencies for specific components of the ISS (Jasentuliyana, 1999). These and other international space agreements will serve as a starting point for cooperation on future international missions.

The organizational framework for expanded international missions is already in place; we must learn from past experiences in order to increase international collaboration in the future. Once the Development Plan is progressing smoothly, NASA will be relieved of its overall management responsibilities by the creation of an international organization, the International Space Consortium (ISC). The

Advantages	Barriers
<ul style="list-style-type: none"> • Reduced cost burdens • Broader sources of know-how and expertise • Increased operational effectiveness • Aggregation of resources • Promotion of foreign policy objectives • Good for developing countries who cannot afford independent programs • Confidence-building measures • Model for international cooperation for disease and population control, as well as environmental research 	<ul style="list-style-type: none"> • Export control barriers • Technology transfer issues • Increase in bureaucratic and administrative costs • Cultural differences • Changing national policy of involved nations • Logistics of international concurrent design • National security • Conflicting national prestige and pride

Table 4.2.: Advantages (National Research council, 2004; Eligar, 2004) and barriers (US congress Office of the Technology Assesment, 1991) of international cooperation.

ISC will promote international missions to the outer solar system and be responsible for establishing the governing body that will determine priorities, set objectives, allocate roles and responsibilities, and outline budgets. Its scope must embrace research and development, infrastructure development, and services and technology, and it should be reviewed and updated regularly. Establishment of the ISC would evolve in two phases: the first implements the activities covered by the previously-discussed US space initiative. The second phase starts with the creation of the actual international consortium, with the expectation of establishing space as a shared competence among all Member States. This body of highly-qualified individuals, representing all involved countries would meet regularly to determine the various functions of the Development Plan as a whole. Initially spearheaded by NASA, this international organization would research and deliberate the effects of new technology breakthroughs, changing political factors, and numerous other issues.

Economic Considerations

Accomplishing this plan will require an increase in overall public expenditure to support research and develop technology applications and infrastructure. Therefore, each country will need to allocate appropriate resources to the needs of the international project. Financial and resource support would be indicative of each nation's commitment to the mission, calculated in accordance with each country's

4. Theseus: Program Management

gross national product.

Legal Issues

The ISS has sixteen partners (Figure 4.1); it is likely that a larger mission such as the one proposed will incorporate even more, especially new space-faring nations. Involving new nations will require further cooperation between all partners, with more concessions, more regulations, and more collaboration. This will become even more important after the initial phase, once NASA may no longer hold the leading role. Part of the legal agreements made must include provisions for deciding, among other items, a new leader, duration of post, and term-limits (if any). A provision similar to Article XVI of the ISS's IGA Cross Waiver of Liability is necessary as it settles the responsibility of damage prior, during, and after the mission with respect to both the space vehicle and the human participants.

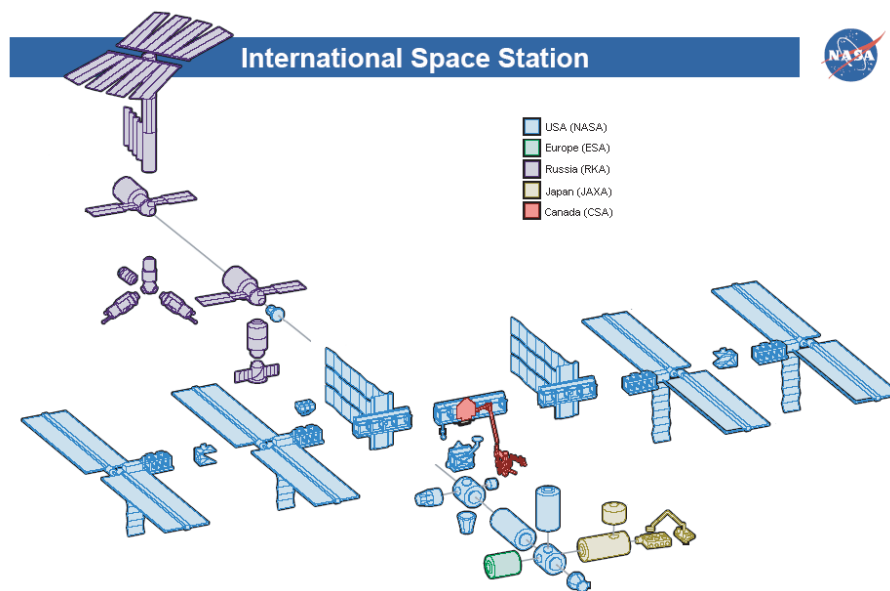

Figure 4.1.: Schematic of the ISS depicting the contributions of each of the international partners. Picture from (National Aeronautics and Space Administration, 2004c).

4.3.2. Non-Profit Organization

Scenario

In the second scenario, a single government agency proves unable to carry out such a large project on its own, and international public collaboration is insufficient in raising adequate funding. The public wants to become involved in space projects, but not at the governmental level. Individuals and companies want to ensure that they have control over exactly where their money is spent and be able

to direct what they have contributed into specific programs that are of personal interest. There is still some public and governmental push to advance space technologies, but these policies are fulfilled through coordination between the private and public sectors. This results in the establishment of an international, non-profit organization to coordinate public and private space exploration efforts.

Policy

In order to build upon the support of governments, there should be collaboration between the public and private sectors through the inclusion of both for-profit and non-profit companies and organizations. This cooperation in space will have several advantages, namely, the improvement of international relations and the stimulation of new ideas by sharing varied experiences and perspectives (ISU, MSS 04, 2003). These partnerships will be coordinated and managed by a non-profit organization specifically charged with exploring the outer solar system on an international level.

Motivation

The motivations behind such a mission will differ depending on the source. For example, the main organization's chief incentives will be research, science, and exploration. Additional government agencies may choose to contribute to the program for reasons such as garnering public support, improving national technologies, and staying involved in the latest 'news'. Private companies and individuals may wish to profit through construction or support contracts. They may also contribute donations to the organization for the purpose of establishing clear community connections. Finally, private companies would be interested in assisting with the development of resources or technology, providing them with the expertise that could result in direct or indirect profit.

Organization and Management

For this situation, the ideal organizational structure is a shared venture between the public and private sectors. The overall program will be run and managed by a non-profit research institute established with the purpose of traveling beyond Mars; for example, the Friends for Exploring the Outer Moons (FEOM). FEOM would be international in scope, with a volunteer board of directors (see Figure 4.2). It would be responsible for raising and distributing funds, managing research projects, and allocating contracts. The majority of investments into the organization will be put toward intellectual capacity: providing access to researchers, outreach and education, research and development, production of equipment (probes, computers and robotics, scientific machinery, etc.), and mission design.

As FEOM will most likely be unable to raise sufficient support through individual and corporate donations, the organization will also be responsible for accepting and directing space agency funds and resources. This will generally be for

4. Theseus: Program Management

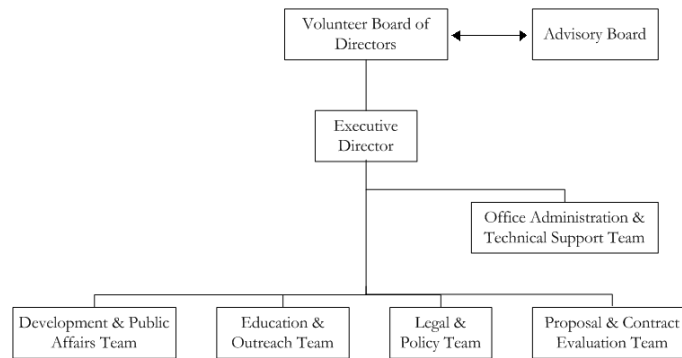

Figure 4.2.: Organizational chart of FEOM

'big ticket' items such as spacecraft design, launch facilities, and deep-space communication networks. This collaboration between the public and private sectors will ensure that a maximum number of individuals become involved, whilst encouraging international efforts and research. It will also be able to receive public funding outside of the space sector, for things such as the development of related technologies and public education/outreach programs. Some of the advantages and disadvantages to such an organization are shown in Table 4.3.

Economic Considerations

It is likely that there will be a growth in space activities and complexity due to such motivations as the recently-announced US Space Initiative, the X-Prize, and ESA's Aurora Programme. In such a case, there is an increasing need for hybrid public-private arrangements, thereby sharing the cost rather than leaving the governments to deal with the large pricetag of such missions on their own. It is clear that in the public domain a project is appealing if it is perceived as necessary, noble, and relevant, whereas attractiveness in the private sector centers more around the ability to generate returns that exceed initial investments (ISU, MSS 04, 2003).

All funding under this plan will be directed by FEOM. The organization will be responsible for all fundraising obligations, including obtaining money from individuals, companies, corporations, foundations, governments, and space agencies. The following factors may also be enacted to encourage participation:

- **Tax legislation:** A change in tax legislation to enable bonuses to individuals and companies involved would encourage participation.
- **Non-space government aid:** Further participation could be helped through the acquisition of government money outside of the space sector, i.e., for the development of curricula, technology programs, spin-off potential, international collaboration, search for life, etc.
- **Sponsorship levels:** Benefits for corporate donors through a series of sponsorship levels would be an incentive by appealing to their public image.

Advantages	Disadvantages
<ul style="list-style-type: none"> • Eliminate duplication of operation costs, facility use, personnel, etc. • Information sharing • Gathering of some of the most knowledgeable people in the world • Technology union and standardization • Important for establishing and maintaining positive international relations • Easier to sell to the public if all receive the same benefits as in a unilateral project, but with reduced cost • Competition - promotes cost reduction • Non-profit organizations can accomplish tasks at a lower cost than governmental agencies • Encourages public involvement 	<ul style="list-style-type: none"> • Potential unwanted technology transfer and competition between countries and/or companies • Concern that one country may drop out or not be able to fulfill its obligations • Language and cultural barriers • Unpredictable and dynamic economic, political, and social situations • Differing public agendas and policies • National security issues • Challenge of attracting private funds

Table 4.3.: Advantages and disadvantages of worldwide collaboration through a non-profit organization.

4. *Theseus: Program Management*

- **Media exposure:** If donations to the organization will increase their exposure, then companies (and individuals) are more likely to contribute.

The private sector would be involved through working on specific missions or for the development of certain aspects of a mission (for example, the development of the propulsion system for a particular mission). Using this kind of partnership, private companies and universities will be able to offer their resources and intellectual capacity. The public sector would then be able to offer funding in kind. That is to say, the public sector agencies would offer the use of their launch vehicles, testing areas, etc. Some advantages to guaranteeing public support in such a venture are that it offers an authority and power of government, a high degree of flexibility in operations, management, legal, financial, and procurements aspects. As well, there is the ability to perform the appropriate governmental functions, and increased relief from binding regulations (McCullough, 2000).

Finally, FEOM will also be responsible for marketing and advertising functions. Such an agency will promote not only corporate and individual donations, but government agencies will also be able to engage in sponsorship and self-promotion via the private entity that is collaborating with them (McCullough, 2000).

Legal Issues

As previously mentioned, in terms of the legal framework it is thought that the current framework that exists is largely acceptable with a few modifications, especially if it is to be pursued via international cooperation. Specific regulations regarding the organization will have to be considered. These would differ depending on the country in which the foundation is registered, including, terms of reference and governance issues, issuance of tax receipts, marketing, sponsorship levels, and incentive regulations. There are also rules for coordination between participants to be considered, as in the level of international participation, avoiding favoritism and nepotism, company collaboration, etc.

4.3.3. Exclusively Privately-Funded

Scenario

The third scenario involves a major change in the way the public perceives space activities. Space commercialization undergoes rapid development, resulting in a major increase in launches, international capability, and technology. Flights to LEO, the Moon, and perhaps even Mars are almost routine events. Vacationers have a choice between flying to exotic Earth locations or to extraterrestrial settings, and permanent settlements and private enterprises have been established on the Moon. All technological developments that will enable human missions to the outer solar system will be carried out solely by the private sector. Tourism, transportation, mining, energy, material manufacturers, and pharmaceutical companies will be among some of the key developers of space-age technology.

Policy

A completely commercialized approach is built on two main premises. First, there must exist the possibility and likelihood of profit, or at least some intangible benefit, such as enhancing the public image. Without this element, private companies will be unlikely to become involved. Secondly, the companies must be interested in and completely supportive of the mission goals. The manner in which such a program is managed must reflect the most efficient process for achieving these goals. While making a profit serves as the main driver for private involvement in such a process, it must be guaranteed early on that the profit potential of the enterprise does not compromise the space program. Care must be taken to ensure the success of both objectives.

Motivation

Companies require a financial return to ensure their continuous involvement in a particular investment. However, return is not the only decision factors considered by companies; risk and timing of the return are also part of the investment decision. Space projects will be undertaken by private entities if sufficient returns with acceptable risk and timing can be achieved. While true that traditionally, this has not been the case, it is likely that privately-funded cheap and reliable access to space will change the situation, making space a perfect market for investments.

As space markets develop and diversify, others will increase, attracting investors. These might range from services rendered to research and development. A potential sequence of industry involvements and space developments is proposed:

1. Tourism and entertainment industries would be the first to invest in developing space technologies related to habitation modules, life support systems, and artificial gravity. The development of these technologies would enhance the competitive advantage of the companies involved as they would be able to provide better services, attracting more customers. As an example, it is quite possible that, once space tourism markets are solidly established, thinner spacesuits would be developed by companies desiring to specialize in EVA (Extravehicular Activity) tourism.
2. Manufacturing companies would follow. Their contributions would be the production of energy, materials, and biomaterials in Earth's orbit. The label "Made in Space" would appear for the first time. These initial space-borne facilities would provide a knowledge base about industrial production in space and related aspects such as large-scale transportation systems, efficiency of processes, behavior of equipment, corrosion of materials, maintenance, and service.

4. *Theseus: Program Management*

3. By this time, a private initiative to promote transportation to the Moon would be established with a format similar to the X-Prize. Once transportation capability is developed, tourism would then be expanded to include visits to the Moon. Base and habitat designs to support hotels and recreation facilities would be implemented by private industries. The market associated with the transportation of tourists and related supplies would likewise open a market for ISRU. Installed, by space-mining companies to support the traffic between Earth, Moon, and possibly beyond, ISRU would, in effect, be the first “gas stations” of space.
4. After some time, another private transportation-driven competition would provide alternative designs to reach Mars. Achieving this would require implementing new propulsion techniques that would reduce the trip to a few weeks. Comfort and safety requirements would lead to the development of radiation protection and refined artificial gravity, as well as closed life support systems.
5. The drive to colonize Mars would develop new ISRU technologies using low-pressure atmospheres and ice reserves. Nuclear power and local resources, such as geothermal, would be commonly used by private energy providers.
6. By this time, *Theseus*, with all the technologies necessary for its success, would be developed exclusively by private funds. The decision of going beyond Mars would not have its foundation in tourism as before, but rather in mining and pharmaceutical companies. Mining companies would reach the asteroid belt and pharmaceutical companies would be interested in discovering new organic compounds. Potentially, research and scientific institutes, as well as philanthropic organizations, would fund a mission to the icy moons of the outer solar system.

Organization and Management

Undoubtedly, the biggest challenge associated with a completely commercialized approach is the organizational structure under which the project is managed. Initially, it is plausible that the organization could be modeled after the X-Prize Foundation or similar, learning from their knowledge and experience in the completely commercial realm.

Due to the lack of governmental bureaucracy, the organization as a whole possesses the potential for great flexibility. It does not have to contend with budget approval by the parliament after elections, for example. As the program is not dependent on the favor of the party in power, even a change in government will have less affect on the project than if it were publicly-funded. In addition, the organization will be established from the viewpoint of what is in the best interest of the company, not any one particular nation. Eliminating national interests allows for a highly mobile organization, which can then choose a location (or mul-

multiple locations) from which to operate based on economic considerations, such as cheaper workforce, better infrastructure, regional technical expertise, etc.

However, as with everything, there are several drawbacks to this organizational structure. Factors that should be addressed include:

- **Initial organization:** All members need to perceive their role as significant, yet not overpowering.
- **Leadership:** The selection process of the leader of the company must be conducted with careful consideration of who is in charge, for how long, with what powers, and by what processes. There is a tendency to base the decision on financial involvement by individual contributors or companies; however, this creates monopoly problems and begins to imitate a government system.
- **Power distribution:** The number of people involved and the proportions in which the executive, judiciary, and legislative powers of the company are distributed is extremely important. Yet, who makes these decisions? As with any money-making effort or organization, there always exists the danger of a power struggle between significant players. This is a potentially huge danger for an organizational approach such as this. It is not likely that smaller companies would join the project unless there were incentives for such a 'piggy-back' approach. In developing the organizational structure, several areas need to be taken into account. In particular, measures will have to be implemented that consider the following:
 - **Rotation:** The amount of time assigned to each position and frequency of regularly scheduled meetings must be determined. Also, provisions for partners joining or leaving the organization between sessions must be determined.
 - **Emergency Action Items:** A list must be compiled of issues deemed important enough to merit emergency action. Possible provisions for a 'sleeper body' to step in and take over if problems escalate to a pre-determined level are also to be considered.

Economic Considerations

International cooperation between independent commercial enterprises offers the possibility of multiple financial sources ranging from disparate organizations and private companies to high net-worth individuals, venture capitalists, and Fortune 500 companies. Countries previously bound by nationalistic agendas can now work together in the commercial realm to achieve joint results far beyond the scope of their individual involvement in such projects.

There are some noteworthy thresholds that will need to be crossed in order for such a mission as the one proposed to be successful from a financial standpoint.

4. *Theseus: Program Management*

The long-term profit return poses a severe barrier for companies to join; the Development Plan spans decades, well outside of the scope of most profit-driven ventures. Unless the program can offer a financial return with low risk and within a reasonable amount of time, it will be stopped before it even begins. As is usually the case with a solely-private approach, there will be no government funding to bridge gaps in budget.

Even with the market driving space research and development, there would still be critical technologies that would not be carried out voluntarily by the private sector because of the low potential of immediate benefits. Incentives should be offered to facilitate their development. Organizations or foundations, such as the X-Prize Foundation, could entice private companies to develop space technologies by encouraging philanthropic donations, exploiting brand-name association, and promoting competitions. Several companies would donate funds just to have their company logo or brand name associated with the space mission or on the spacecraft, for example. As a result of these types of competitions, new technologies would be introduced into the space community. This could lower transportation prices, making space an attractive market for investments.

4.3.4. Major Societal Shifts

For this fourth scenario, the assumption has been made that we are no longer exploring for exploration's sake, but rather has been influenced by a major shift in societal perception. While there are many, we have chosen to concentrate on two of the more likely possibilities:

1. China (or another nation) has become a major space power and has successfully reached the Moon and Mars. Other nations want to be part of the Development Plan to prove their ability in technology and space.
2. Discovery or contact with life on Europa, Titan, or elsewhere in the solar system.

4.3.5. New Space Race

Scenario

The first scenario considers the possibility that China has achieved its goal of a human lunar landing and put taikonauts on Mars, as well. This has all been accomplished without international cooperation due to tensions between the US and China (and their respective partners); to date, the United States has blocked China from being allowed access to the International Space Station (Moltz, 2004). In addition, there is a considerable lack of transparency between these two countries, especially regarding technology transfer (Martel and Yoshihara, 2003). Under these circumstances, a mission of such magnitude and complexity could be done as an example of ability, to prove who really is the space (and technological) leader.

Policy

As during the US/Soviet Moon Race of the 1960's, this mission would be closely tied to national and political prestige. The goal would not be exploration, but simply proof of technical ability, making science a secondary objective. Additional benefits include strategic advantages or technological spin-offs gained from the mission. However, as with the Moon Race, the efforts of many nations and the strong political overtones would increase general interest in the Theseus Program, and in space exploration in particular.

Motivation

The drive to prove national superiority in space will be the main motivation for this scenario. National pride will also be a factor, as each nation strives to be the first to discover, land, explore, etc. Space would provide the battleground for the unarmed combat of national superiority. The Theseus Program will be a vehicle for developing high-technology capabilities within each nation or alliances of nations. Therefore, it is highly desirable and beneficial for the successful nation's workforce and their resultant productive economies. Technology transfers are extremely difficult and nearly impossible due to each country's close relationship with their respective defense departments.

Organization and Management

The space powers of the world will be divided into at least two sectors. Organization and management will be conducted within the framework of a space agency, with significant influence and interface with the defense sector. The development program will be driven by military needs and requirements. However, the project will be headed by the civilian branch due to political considerations. This provision will allow for some cooperation and also serve to provide some protection of the nation's primary mission goals.

Economic Considerations

The mission will be funded solely by the public sector, particularly defense and strategic agencies. Allied countries will potentially make nominal contributions.

Legal Issues

The legal framework will not be significantly affected in this scenario. There is no benefit or driver to change the existing legal framework from a nationalistic point of view. Science will be the primary selling point to the public, and on this basis, the existing legal framework is sufficient. However, militarization and appropriation of celestial bodies would need to be allowed to strengthen the potential strategic advantage of journeying to the outer solar system. Potentially, the US and/or China may choose to secede from the Outer Space Treaty.

4.3.6. Discovery of Life on Europa and/or Titan

Scenario

If life is discovered on either Europa, Titan, or elsewhere at some point during implementation of the Theseus Program, the policy and organization could change drastically. Depending on what is actually discovered (intelligent life, microbes, fossils, etc.), people from all over the world may want to take part to contact or study this new life. Scientists, religious groups, and the general public may all wish to become involved in such an experience. This discovery would change the way humankind thinks about itself and how civilization functions.

Policy

The policy statement for such a mission in this scenario would have to be very international and encompass all countries, people, and organizations. It would have to include the following issues:

- The need for this to be a global endeavor
- Policy for dealing with intelligent or higher lifeforms
- Distribution of scientific information
- Planetary protection (forward contamination)
- Earth protection (backward contamination)

Many of these issues have ethical implications and it would be the responsibility of all those involved to ensure a policy that is ethically sound and accepted overall.

Motivation

The motivation for this mission is simply to study and potentially make contact with the new life. If the discovered life is a simple organism, then the motivation would be purely educational to study non-Earth life and determine if we are somehow related. If a higher life form is discovered, the motivation may be to make contact, learn from, and study them for scientific purposes, as well as to ensure our safety.

Organization and Management

A mission to take humans to the outer solar system to either contact or study other life forms would involve all agencies, countries, religious groups, and any other interested parties. Therefore, an international non-governmental organization would be set up to ensure everyone's involvement. Perhaps the structure could be part of the United Nations. This governing body would have to oversee

all of the financial issues, determine the policy and mission objectives, and ensure that international law was followed. There would also be many ethical issues to be debated including how the discovery will affect society.

Economic Considerations

The financial difficulties for this scenario could be potentially less challenging than for situations previously discussed. This could be due to an overall increase in motivation for an outer solar system mission following discovery and confirmation of life. As mentioned, many different types of parties and organizations would want to be involved and therefore, it would be easier to raise the required funds. Scientific and philanthropic organizations, religious groups, military, Fortune 500 companies, and individuals could possibly donate money to contribute to this quest for knowledge.

Legal Issues

The only additional legal considerations for this mission are the planetary protection laws, which also would include any life found on celestial bodies. Therefore, care would have to be taken to ensure no harm is done to the discovered life during study or contact. Laws would need to be created regarding how to deal with extraterrestrial life, both simple and intelligent.

Ethical Issues

There will be people who will be strongly against contacting or studying life outside of Earth, and there will be those who can not wait to learn and explore. It is unlikely that exploration and contact will not take place, but at some point it will need to be decided how far one can go. As mentioned above, a policy statement would have to include decisions on ethical issues. This would have to be compiled by all those involved to reflect the interests of all affected people. Most likely our governmental leaders will be called upon to make decisions for each State, and from there an international ethical agreement would have to be made. There will be strong motivation and support for this mission, but there will also be a lot of opposition.

4.4. Outreach and Education

Outreach and education efforts for such a large-scale and innovative mission will need to be directed at people from every age group, culture, and discipline. Such measures are imperative as global awareness of the project will promote overall education and inspire the general public, as well as provide vital public support for this high-profile, expensive, and complex plan.

4. *Theseus: Program Management*

Thus, a certain portion of the Development Plan and the mission's budget shall be directed toward public affairs, outreach, and education of the mission, as well as of the space agencies themselves. For a Development Plan as large-scale and as this, it is best to use a variety of methods to meet these goals.

To begin, politicians and scientists from each country should be made to feel involved, as this will enhance their level of commitment. Ensuring that these two groups support the mission and are knowledgeable about its benefits will help make certain that the Development Plan and eventual human mission receive the adequate support. It will also reduce complications associated with technology transfer and intellectual property.

Depending on the scenario, developing nations should be fully integrated into the mission, regardless of their financial resources, technological capability, or educational level. The final decision of the amount of participation of such countries can be determined on a nation-by-nation basis. Regardless, any sort of interest and international cooperation is something that should be highly encouraged.

Space agencies should also join efforts with other government and non-profit agencies, such as existing museums and schools. For example, NASA loans and donates many items, including actual spacecraft, to the Smithsonian Air and Space Museum in Washington, D.C., other museums, and universities.

One approach would be to create an outer space analogous environment on Earth by designating cities around the world as 'space places.' These space places would serve as space, science, and technology educational and inspirational centers. For example, Stockholm could be Saturn, with a large-scale physical model of Saturn built in the city. Stockholm would then also house a museum of information and artifacts associated with Saturn specifically and with outer space in general. The various centers would be linked together utilizing high-technology communication systems further promoting international unity and pride. Less populated and economically marginalized areas could also be included through travelling versions of these space place exhibitions and displays. For instance, if Cairo is Mars and has a large-scale physical model of the planet, a smaller version could be constructed, complete with exhibitions and external links, and transported to nearby communities that are unable to take full advantage of the larger museum. These traveling models would serve as an inspiration for scientific research and discovery, and foster a sense of connection both intra- and internationally.

In addition, tutorials, activities, and lessons about the mission and other space-related areas should be posted on the Internet for easy access by educators. The materials can be made available in a variety of languages and therefore accessible by teachers worldwide and incorporated into their curriculum.

Public interest can be gained by incorporating some fun approaches, such as a vehicle-naming contest and solar system maps. Contests to name a spacecraft are common procedures; providing names to the four space shuttle orbiters, three US Mars rovers (National Aeronautics and Space Administration, 2004*d*), and others. People could also be provided with solar system maps to allow them to

chart the progress of the mission within the solar system based on coordinates given monthly through local newspapers or on the Internet. Not only will this help individuals stay interested and up-to-date on the vehicle's progress, but it may also interest and educate the public about orbital mechanics and general solar system facts.

Personal accounts are also helpful and tend to go far in capturing public interest. Letters from the ISS posted on the web by American astronauts, as well as those from the aquanauts of the NASA Extreme Environment Mission Operations (NEEMO) 5 project, have been very popular (National Aeronautics and Space Administration, 2004e). For the Theseus Program, it may be possible to post similar letters on the web from crew members in training, mission control, or scientists working on various aspects of the plan. A forum could be set up to answer questions from the public, and educational tours of the facilities could be arranged upon request.

Another possible method of capturing public interest is through exploitation of the current fascination with reality television shows. Such entertainment shows have the potential to serve as a good general education tool, as they provide a unique opportunity to broadcast the progressive efforts of the program to an international audience that would not normally be considered space enthusiasts. Famous celebrities and renowned scientists could also work together to promote both the science and relevancy of the Development Plan and proposed missions.

Outreach and education at the university level could take place through research on sponsored projects. Interns could be provided with hands-on experience while working on state-of-the-art projects, allowing the associated companies to both educate and utilize the upcoming workforce at a low cost.

Most space agencies already have an outreach program, so this mission would not necessarily require the creation of new offices, merely the implementation of coordinated efforts among current locations, fostering new relationships and building upon existing ones. Figure 4.3 below is a schematic that outlines a method that could be used to coordinate international efforts.

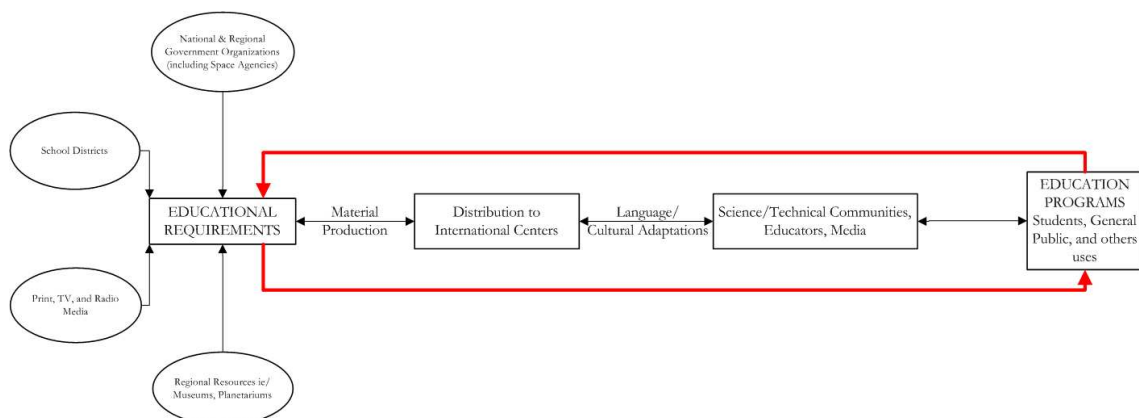

Figure 4.3.: Schematic showing a possible international outreach program.

4. *Theseus: Program Management*

The scope, reach, and focus of outreach and public education for the Theseus Program will change according to the future that develops. If a space race is the driving force for this mission, the geographical focus of outreach would be national with the emphasis placed on national pride and prowess. If international cooperation enables this plan, all countries and people should be included in the program, focusing on international cooperation and international unity. The different scenarios can utilize the same methods for education and outreach, with slight changes made to focus and implementation methods as necessary.

4.5. Ethics and Social Implications

For a Development Plan that culminates in a successful human mission to Europa and Titan, one must ask whether this mission is important enough to incur such a risk to human life. It is obvious that a huge amount of political will and public support would have to be generated in order to fund the mission. Having said this, the public would also have to be educated and informed about the high risk of the mission, so as to keep up morale and public support throughout its duration. The general public would have to be taught that spaceflight is dangerous and that the risk of human loss is always a possibility.

It is suggested that a Code of Ethical Principles be drafted. This document would act as a set of major guidelines for all decisions. In order to guarantee the high moral level of this code, it should be drafted by an independent coalition of ethical experts. This would provide an objective and highly valuable set of guidelines for such an endeavor, independent of individual agendas. The code should include topics such as:

- Radiation limits
- Risks to Earth (e.g. nuclear technologies)
- Planetary protection
- Code of Ethics for the crew onboard the spacecraft
- One-way ticket issues
- Conflict of interest
- Crew composition (national background, male/female/mixed, sex in space)
- Genetic alteration/modification

4.6. Cost of the Development Plan

4.6.1. Introduction

An accurate estimate of the cost for the entire Development Plan is not feasible. This is due to many reasons, one of which is the long time-scales associated with Theseus. The uncertainty involved with any forecasting of the changes in overall world environment within even a short time period is high enough that any attempt can and should be dismissed.

From communications with various experts, it was suggested to attempt a cost estimation for the first 15-20 years of the Development Plan, as beyond that time span, there is a lot of uncertainty. This method is also used in the Aurora program and in the US Initiative for Space Exploration. The approach of cost estimation for the first years of these two “Mars Development Plans” is reasonable, however it is impractical for our plan. The reasons for this are summarized below:

- Human missions to the Moon and Mars are short-term goals, compared to human missions to the outer planets. In addition, similar concepts have been studied extensively and the technologies considered for these are much more visible and well understood, than those we propose. Therefore, the individual steps in these plans can be defined in significant detail to allow a logical cost estimation for the next 15-20 years. This is not valid in our case.
- Parts of the technological progress in the first 15-20 years of Theseus progress will probably be linked to the Mars development programs, so this cost will not be allocated to our plan. As for the scientific missions, due to the large distance of Jupiter and Saturn from Earth, JIMO is still expected to be in operation after 15 years (Figueroa, 2004). Cassini/Huygens will be completing its mission in 2008-2010 (Matson et al., 2002), and by 2015 the Titan Orbiter and Balloon (Mission described in Section 3.3.2) will probably be launched. In total, we see that for the next 15-20 years, only a very small percentage of the proposed Development Plan will occur, making it impractical to provide a cost estimation for this period.

4.6.2. Rough Order of Magnitude (ROM) Estimates

Despite difficulties, we will try to approach the problem in a simplified way in order to estimate at least an order of magnitude cost for Theseus.

First method: Scientific and Technological elements

The Development Plan (see also Chapter 3.3) consists mainly of nine major milestones that can be divided in two categories: scientific and technological. The approach for each category is different.

4. *Theseus: Program Management*

Scientific Elements: The scientific milestones obviously refer to the exploration of the Jovian and Saturnian moons. Steps required to reach these milestones in terms of robotic missions are more clearly defined compared to other milestones. In this case, a parametric approach has been chosen. For the cost estimation of each element, the Advanced Mission Cost Model of NASA is used (NASA, 2004). The input parameters to this model, together with the results are presented in Table B.1, in Appendix B, for the missions to Jupiter.

In total, a cost of approx. 60B USD (economic year 2004) is estimated for the missions to Jupiter (see Section 3.3.1). It is reasonable to assume that the series of robotic missions to Saturn and Titan (refer to Section 3.3.2) will have a total cost that lies in the same range with that of the Jovian missions, despite the fact that the proposed missions to Saturn are less than those proposed for Jupiter. For comparison, the Galileo mission cost approximately 1.6B USD, while the Cassini/Huygens cost approximately 3.3B USD. This leads to a total cost for the scientific elements of Theseus of approximately 120B USD.

Technological elements: Unlike the scientific elements of the Development Plan, the steps for the completion of the technological milestones are not defined simply as space missions. They are instead considered a combination of more generally defined methods, including space missions as well as ground research and development, making a parametric approach for costing, almost impossible.

For this reason, for estimating the cost of the technological developments we have used an analogy method. Different, large-scale technology projects, relating to the various different scenarios discussed in this chapter have been considered. These projects are the Saturn V rocket, the Space Shuttle, the Energia/Energia project, the Ariane 5, and the CEV. Taking into consideration every one of the above projects listed in Table 4.4 and multiplying its cost by seven, which is the total number of technological advances in the Theseus development plan, we could expect that that the technology development costs could vary from 100B USD to 350B USD, depending on the future scenario. This estimation does not include the cost for operating these technologies in the various space missions or applications of our Development Plan. In any case, this cost estimation approach can only show that the total amount of money that is needed to make the Development Plan possible is huge, and thus the plan needs to be definitely expanded in a large time period.

In conclusion, since the cost for the scientific plan, as discussed in the previous section is estimated to be 120B USD, this sets a total cost for the scientific missions and the development of technologies that can range from 220B–470B USD (economic year 2004), for a 50-70 year duration of the Theseus Program.

Second Method: Apollo Program Analogy

The second approach used for the estimation of the Theseus total cost is more simple. The Apollo program, through which every single technology was prepared from the beginning in order to enable human missions to the Moon, cost

90B USD (economic year 2004), according to data derived from (NASA, 2004a). The Apollo program lasted 11 years in total, so for an estimation of around seventy-years duration of Theseus, we find that the total cost could be around 470B USD, by applying a knowledge factor of 5% per decade. There is still a lot of uncertainty in this value, since the Theseus Program is much more difficult and complex than the Apollo program, however this estimation shows us that the lower limit of 220B USD with the previous method is probably not very realistic.

4.7. Conclusion

Program management is an integral part of any Development Plan, yet it is an area that is often overlooked due to its ambiguous and unpredictable nature. However, this area that encompasses the political, economic, societal, and ethical environments requires as much attention as any other aspect of the Development Plan. In this section, we attempt to describe the elements that are most pertinent to forming the infrastructure required for a human mission to Europa and Titan. These include: national and international policy, motivation, organization and management, financial considerations, legal issues, outreach and education, and ethics and social implications.

These elements were considered in four possible scenarios, which were selected as possible futures. The first is an international, publicly funded program, where international government agencies eventually combine to form a coalition. The second is an international, public/private partnership in which the mission is managed by a non-profit foundation and the space agencies of several nations, as well as private companies and individuals. The third is a purely private enterprise, comprised solely of private companies and without the support of government agencies. Again, this is on an international scale, and occurs in a situation in which commercialization of space has begun to be profitable. The final scenario describes factors that could cause major societal shifts in motivation for the mission, such as a new space race, the discovery of life elsewhere in the Solary System, or the possible destruction of human civilization.

Taking into account the amount of coordination required, the technological advances necessary, and other factors, the proposed Development Plan spans about seventy years. This long time-scale makes it impossible to predict the total required funding, which is on the order of hundreds of billions of dollars. However, this is indeed an important point that must be considered, and it was not disregarded in this chapter. A reasonable estimation has been provided for the next ten years, after which the cost becomes dependent on so many different factors that it is impossible to even give a rational number.

Many different aspects are involved in the Development Plan of a mission. It is vital to the success of each and every part of that plan, and of the resulting missions, that all aspects be taken into account. The program management aspects may not be as concrete and definite as others, but it is important not to overlook them. It is hoped that this chapter has provided some insight into not only the

4. Theseus: Program Management

Project	Development Period	Political-Social Environment	Other aspects	Development cost [B USD, economic year 2004]
Saturn 5 LV	1955-1967	<ul style="list-style-type: none"> • Space race • Strict deadline (<i>"before the end of the decade"</i>) 	<ul style="list-style-type: none"> • The cost of all Saturn V precursors (Saturn 1-C, Saturn 4 etc.) is included 	35-45
Space Shuttle	1971-1981	<ul style="list-style-type: none"> • National approach • Military involvement 	<ul style="list-style-type: none"> • 5 Space Shuttles were built • 1 aerodynamic flight model was built 	35-50
Energia LV/Buran	1971-1987	<ul style="list-style-type: none"> • National approach • Military involvement 	<ul style="list-style-type: none"> • 5 Buran shuttles were built, only two completed • 1 aerodynamic flight model was built • Energia LV could launch independantly from Buran 	<ul style="list-style-type: none"> • 10-15 for the launcher • 20-25 total
Ariane 5 LV	1988-1996	<ul style="list-style-type: none"> • Intern. cooperation • Driven by commercialization 	<ul style="list-style-type: none"> • Initial failures increased the total development cost 	15-20
Crew Exploration Vehicle	2004–2010	<ul style="list-style-type: none"> • National approach • <i>Columbia</i> tragedy Impact • Successful Mars Rovers 	<ul style="list-style-type: none"> • No launch vehicle allocated yet • First tests expected in 2008-2010 • Announced Modifications significantly increase development cost 	<ul style="list-style-type: none"> • 15-20 • estimation only

Table 4.4.: Cost estimations for major technological projects. All cost data is derived from (Wade, 2004; NASA, 2004a).

areas that are central to the success of the program-based aspects of the Development Plan, but some of the possible scenarios that could provide an enabling environment for a human mission to the outer Solar System.

4. *Theseus: Program Management*

5. Case Study: Mission to Europa To Trace for Life's Existence (METTLE)

5.1. Introduction

5.1.1. Rationale

The Theseus Program focuses on the scientific, technological, and management barriers that need to be overcome in order to enable human missions to the outer solar system. Building upon this foundation, this chapter provides an illustration of how such accomplishments could influence a mission to Europa to search for evidence of life in its subsurface ocean. It should be noted that this case study focuses particularly on an area generally disregarded in similar studies, such as NASA's HOPE mission (Trouman et al., 2003). At the same time, it expands upon aspects that are not directly related to Theseus, but closely linked to mission design issues, including crew selection, habitat design, mission operations, etc. However, it should be noted that this case study will not provide a detailed technical breakdown of each subsystem, as this is not possible given the time frame under consideration.

With this case study, we wish to share our ideas of the steps beyond Theseus by exploring one of many possible solutions which would enable a human mission to Europa.

5.1.2. Assumptions

Formulating a case study requires a series of assumptions in terms of available technologies and political climates present at the time of the proposal. This includes the assumption that all necessary Europa science missions and enabling technological developments have been completed, as well as the following:

- **The political situation surrounding this mission is that of a new space race, Section 4.3:** The economical and political conditions are favorable to support and fund METTLE. Furthermore, as a national program, the problems of cooperation between nations are greatly reduced. The mission start date is set for 2070. It should also be noted that, since the Theseus Program only addresses the basic technology and requirements, this case study could still apply to a number of different future scenarios.

5. Case Study: Mission to Europa To Trace for Life's Existence (METTLE)

- **A crew of six was selected to partake in this mission:** This is based on previous studies of the outer solar system
- **Mars exploration by humans has taken place:** This means that the initial research and testing has occurred on a number of levels, proving the superiority of the VASIMR engines over MPD, resulting in the use of VASIMR on our spacecraft (see table 3.2).
- **Spacecraft construction occurs in LEO:** The spacecraft is constructed in a space yard, to which the elements are transported via a heavy-lift launch vehicle capable of carrying several hundred tons of payload into orbit.
- **Breakthroughs have occurred in radiation protection measures:** Magnetospheric shielding has been space qualified, protecting crews from harmful radiation, and a torus is proven effective in generating artificial gravity (refer to sections 3.3.9 and 3.3.7).

5.1.3. Mission Scenario

METTLE, a mission to the outer solar system, will investigate the existence of life in Europa's subsurface ocean, based on the competencies obtained through the Theseus Program. To illustrate the overall mission architecture of METTLE, a block diagram has been constructed (see Figure 5.1). The mission operations are explained in section 5.4.

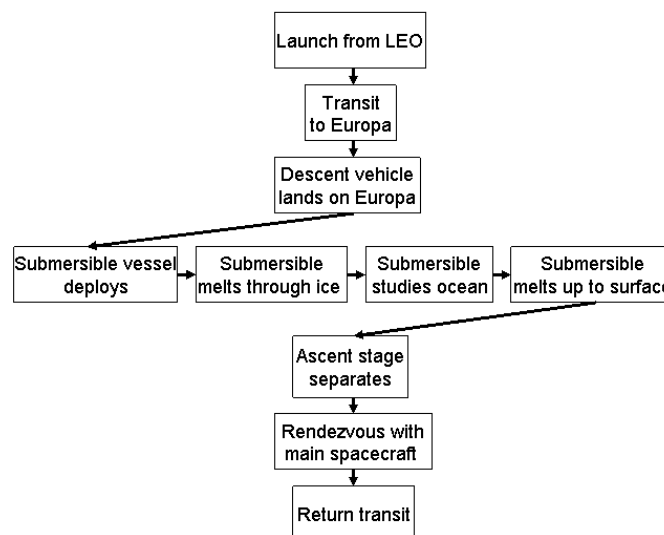

Figure 5.1.: The overall mission architecture of METTLE.

5.2. Spacecraft Design

The spacecraft for METTLE has an overall length of approximately 200 m and a habitat ring with an outer radius of 45 m. It consists of multiple sections, the position and design of which are largely driven by the need to protect the crew from radiation and effectively manage the heat produced by the various onboard systems (see Figure 5.2).

The central hull of the spacecraft is responsible for supporting the engines. This section has eight 2.5 MW VASIMR engines mounted in four pairs (see table 3.2 for the advantages of such a design). The space between engines provides room for the radiator units, which draw heat away from the actual engines. Each engine unit contains its own PPU, while the center hull leading to the engines stores several fuel tanks and contains power lines coming from the reactors. The reactor elements are mounted on a support boom, which also houses the super-conductive magnets coupled with plasma injectors used to generate a protective magnetosphere around the spacecraft. The magnets can be rotated to reorient the poles and optimize the shielding geometry (see Figure 5.2).

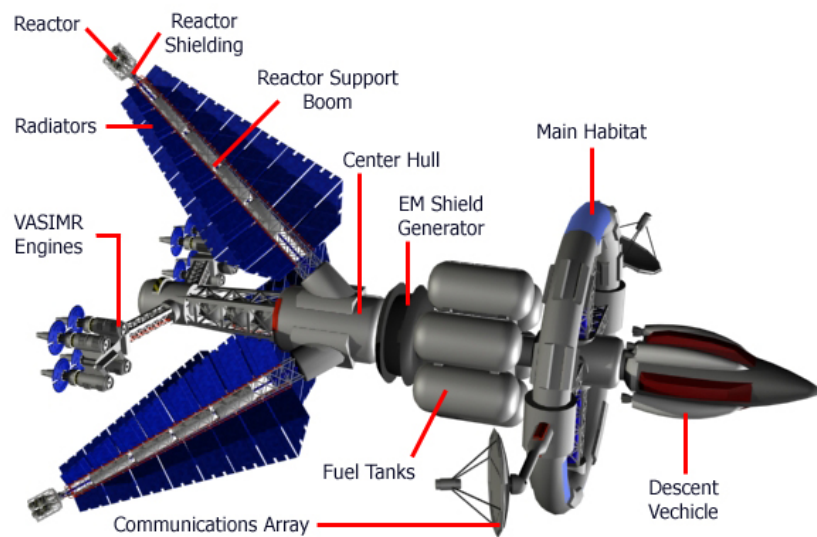

Figure 5.2.: METTLE's spacecraft design for interplanetary flight.

Due to safety and heat dissipation concerns, we have included three booms. On

5. Case Study: Mission to Europa To Trace for Life's Existence (METTLE)

Element	Mass [t]
Habitat ring	300
Descent vehicle	300
Remaining S/C	1400
Total	2000

Table 5.1.: Mass breakdown of the suggested spacecraft design.

each boom is mounted two reactors and should have a minimum total power generation of 5 MW_e . Mission success depends on only four reactors, so if one boom is damaged, the mission can still continue. Assuming 25% reactor efficiency, the spacecraft needs to dissipate 15 MW_t of heat from each of the reactors. This is accomplished using double-sided radiators on each boom; mounting reactors in pairs allows for an efficient radiator in a more compact design. The parts of the reactors that face the habitat module are shielded to minimize radiation effects on crewmembers. Following the reactor mount support unit are six Argon fuel tanks used to store the propellant for the VASIMR engines.

The type of nuclear reactor employed is not of critical concern for this case study, as long as the specifications for the operation of the VASMIR engines have been met (see Chapter 2).

Next, is torus habitat ring, the spin of which produces artificial gravity. This has the advantage of simplifying trajectory optimization during transit while allowing for the conduction of safer EVAs (see Table 3.3). Finally, on the forward section of the center hull is mounted the descent vehicle used to deliver the submarine to Europa's surface.

5.2.1. Main Habitat Ring

The habitat ring is sufficiently large (radius of 45 m) to provide an acceleration of $0.45 g$ when rotating at 3 rpm. The ring consists of twenty-four modules, providing a habitable surface of approximately 1000 m^2 (43 m^2 per module, as shown in Figure 5.4). The greater number of modules allows us to have redundancy in the functions of each module, and each module can be isolated from the others in case of emergency (depressurization or fire, for example). The structure can be rearranged and crew movement is facilitated by the use of corridors spanning the ring (see Figures 5.3 and 5.2).

Two crewmembers share one module, as shown in Figure 5.3, and sufficient space is provided in the habitation modules for:

- Sleeping
- Stowage of operational and personal equipment
- Dressing and undressing
- Computer work and communications

- Trash stowage
- Personal grooming
- Medical equipment and supplies
- Off-duty activities

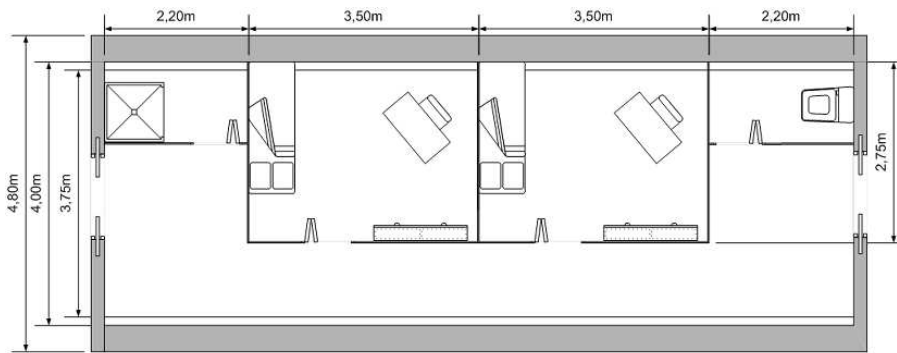

Figure 5.3.: Design proposal for the crew quarters.

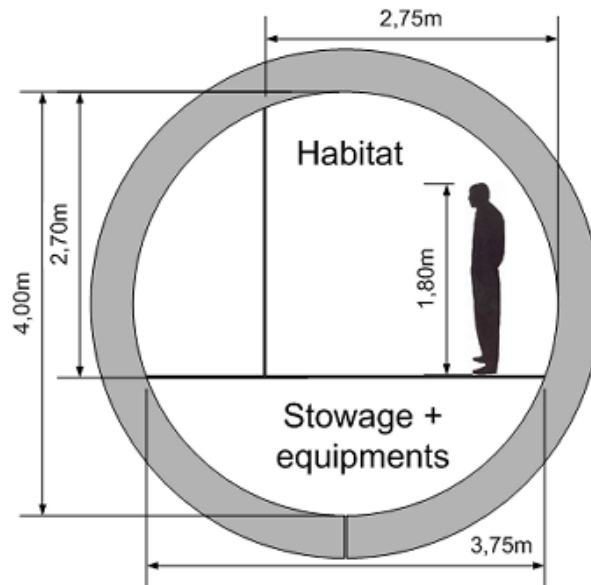

Figure 5.4.: Dimensions of the habitat ring.

Crewmembers are provided with controls that allow them to adjust the atmospheric parameters according to their preferences. The same atmospheric control systems also monitor and eliminate both organic and artificial contamination.

5. Case Study: Mission to Europa To Trace for Life's Existence (METTLE)

Due to the long mission duration, the need for privacy and space is vital to the psychological well-being of the crew. Therefore, the internal dimensions of the habitat are designed to sufficiently and comfortably accommodate even the largest crewmember, with the ability for each person to individualize certain portions of their environment. For example, adding a flat screen to the wall to display favorite pictures from family and friends or landscapes from Earth adds a personal touch while improving psychological conditions and boosting morale. However, not all of the habitation modules have been designed for privacy; a few have been created for communal gatherings, such as for group dining.

Comfortable accommodation is not the only concern, there also exists the need for hygienic practices. Wet wipes are sufficient for short-duration missions, but showers are a vital part of personal hygiene for longer flights. Therefore, a shower and sauna have been designed into the spacecraft. These facilities are as easy to use as one on the ground, while considering the varying gravity environments, mass restrictions, and water reclamation needs. Finally, a washer and dryer capable of operating under micro and hypogravity conditions are deemed necessary.

Recreational environment on spacecraft

Crew members will need generous amounts of time for recreation. Gazing out the window during interplanetary flight will not be as interesting as in Earth orbit, therefore individual and group recreational activities are included. Computers can provide digital entertainment such as games, electronic books, music, movies, and education, allowing crewmembers to pass the time as well as acquire new skills during transit.

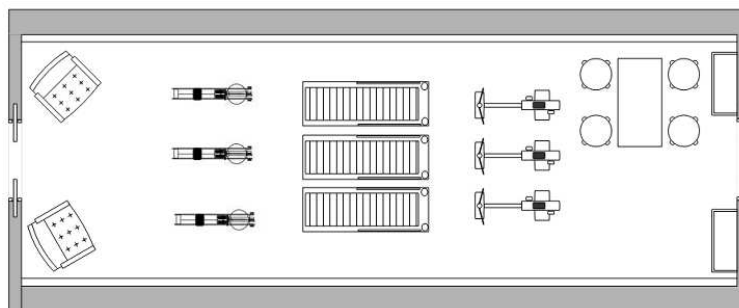

Figure 5.5.: Fitness and training module onboard the spaceship.

Exercise is also a means of recreation and helps to maintain crew fitness and morale. Appropriate facilities are included in the design, and contain a variety of both strength-training and aerobic exercise equipment. A screen placed in front of each treadmill or ergometer will show an animated 3D simulation of an environment chosen by the exercising crewmember. As these facilities are noisy and generate vibrations, they will be isolated from crew quarters and concentrated in dedicated modules. Additionally, cool potable water will be available through

dispensers and a climate control panel will provide adequate and adjustable airflow.

All of the subsystems create a certain amount of noise and the overall result, especially on extremely long missions, can be annoying at best and harmful at worst. To minimize any detrimental effects, a low level of ambient noise in the habitat environment will be maintained using absorbent panels, equipment isolators, and sound absorbers. Additionally, active control of noise will be accomplished by introducing interference shock absorbers to generate one or more secondary more pleasant sounds, significantly reducing the original disturbance.

Workstation arrangement on spacecraft

With respect to crew workstations (see Figure 5.3), a traditional approach makes sense when work is physically confined to a particular location (blood chemistry in the sick bay for example). Workstations with traditional screen displays and keyboards are provided in most modules.

Control of the station is done via a combination of mouse, voice, and gesture-based interfaces. Heads-up displays are made to appear in front of the crewmembers at a comfortable viewing distance, and head movements are used to expand the display and control area. Thus, the information systems are kept to a very small volume, increasing the productivity and flexibility of crewmembers. All controls can be operated by a pressure-suited astronaut if necessary. Additionally, all crew interfaces are standardized and consistent.

A two-way audio, visual, and data internal communications system is provided between crew quarters and other modules. The system will also be used to alert occupants to emergency situations.

5.3. Preparation for METTLE

The transition from the precursor missions to the one proposed will involve a substantial reorganization of ground operations, necessitating a rearrangement so that the focus is aligned with the mission's objective. This will involve not only a substantial amount of time devoted to preparatory work, but also a focus on crew selection and training.

At present, astronauts are categorized as pilots, mission specialists, or payload specialists. Their duties are specified accordingly and are closely followed. However, for the METTLE mission, the crew must be versatile in multiple tasks. Therefore, the following list identifies the basic skills required of the astronauts:

- Pilot
- Engineer
- Geologist

5. Case Study: Mission to Europa To Trace for Life's Existence (METTLE)

- Exo-biologist/astrobiologist
- Medical doctor with skills in psychology, dentistry, and surgery
- Life support specialist / biologist

Since all of the above mentioned skills are necessary during the mission, an intensive training program will need to be established. This training will include physical fitness, as well as classroom exercises in a broad selection of categories, including spacecraft systems, basic science and technology, mathematics, geology, meteorology, guidance and navigation, oceanography, orbital dynamics, astrophysics, astronomy, astrobiology, material science, medicine, and psychology. Training will be provided in different proportions depending on the crewmember's area of expertise; however, all will need to exhibit a basic competency in all areas in order to maximize scientific return and maintain adequate safety of the crew during mission operations.

Apart from the topics mentioned above, the astronauts will require a high tolerance to extreme radiation environments, as identified in section 3.3.9. This would be a precautionary measure in the event that the magnetospheric shielding falls below 100% operational efficiency.

Rehearsal Missions

To test spacecraft subsystems and maximize safety, communication, and other activities, requires short-duration rehearsal missions. One such mission is to go to Mars using the same system that will be used to go to Europa. After a total mission time of about one year, the overall system will have to go through a final system review to check for degradation and errors. This will provide the operations center with the opportunity to make minor modifications on some of the systems.

Not only do the spacecraft systems need to be checked, but ice melting techniques must also be tested using a scaled model. One possible test location is that of Lake Vostok in Antarctica, as suggested in chapter 3. While conducting the tests, the temperature and gravity conditions on Europa must be taken into account. The entire system will be initially robotic, followed by a human mission upon successful completion of the test. This should provide an adequate level of checks and measures to ensure success while on Europa, paving the way for METTLE.

5.4. METTLE: Mission to Europa to Trace Life's Existence

5.4.1. Transit

METTLE will launch from LEO, travel to the outer solar system, conduct valuable subsurface research and exploration on Europa, and then return to LEO where the crew and samples will be transported back to Earth. To perform the orbital transfer, the spacecraft must initially escape the Earth's gravitational field; this is done with the use of the onboard VASIMR engines, which apply a continuous thrust. This results in an outgoing spiral around the Earth until the spacecraft has reached the required Jupiter transfer velocity. This may take several weeks, but will provide the necessary time for system checks. Once escaped from Earth's gravitational pull, the spacecraft will be on its outbound journey to Europa, with the transit time dependent on the spacecraft's final ΔV . Note that the ΔV requirements in Figure 5.6 are calculated for an impulse burn approach and not a constant thrust, as is the case here. Therefore, an additional margin of ΔV of 20–30% should be added to overcome any gravitational losses.

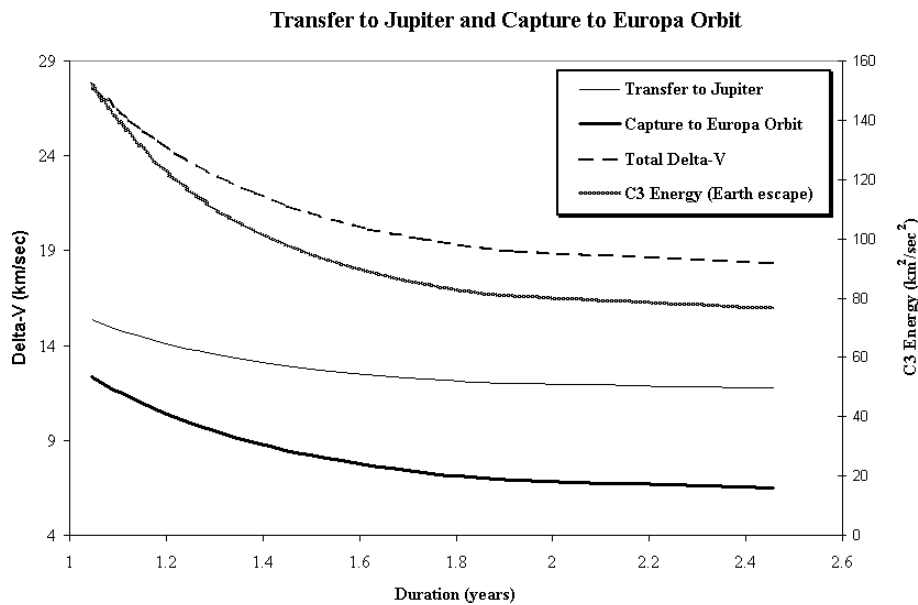

Figure 5.6.: Duration of the transfer to Jupiter and capture to Europa orbit, where $C3$ signifies the square value of the hyperbolic escape excess velocity.

Upon arrival at Europa, the spacecraft will brake by rotating the spacecraft and using the same VASIMR engines and will enter into orbit around the little moon. After part of the crew has spent approximately sixty days below Europa's surface for scientific studies, they will rejoin their compatriots and the entire crew will return to Earth on a hyperbolic trajectory requiring a similar sequence of events for as used in the outward journey. The time of flight on the return trip is

5. Case Study: Mission to Europa To Trace for Life's Existence (METTLE)

dependent again on the ΔV , as shown in the Figure 5.7. For this case we intend to select a ΔV of approximately 14 km/s on the outbound journey and a ΔV between 15 – 18 km/s on the return journey, giving a total flight time of 2.7–3.9 years.

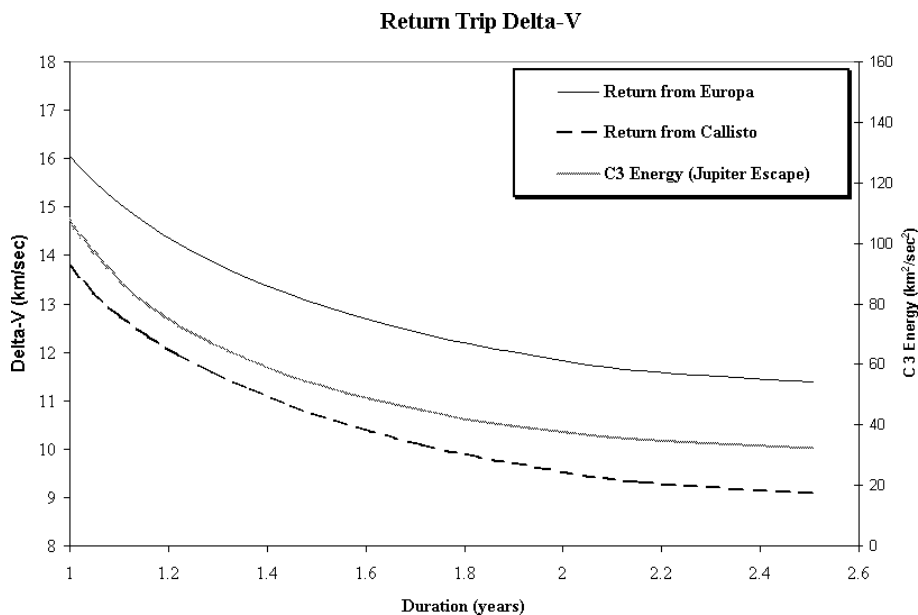

Figure 5.7.: Duration for the return flight from the Jovian system. See Figure 5.6 for explanation of $C3$.

The spacecraft will dock with the space yard upon arrival in LEO at an altitude of 1000 km, and the crew will be transferred to Earth and quarantined for medical observation. There will be a post-landing procedure to help integrate the crew back into society.

The selection of ΔV for the transfer trajectory also has psychological implications. A transfer trajectory which passes Mars and the asteroid belts is likely to be preferred by the crew, as window watching has been proven to have positive effect on crew morale and will certainly give them some interesting scenery, as opposed to a continuous background of stars.

5.4.2. Onboard medical care

When planning any mission, medical care must be taken into account. Therefore, a Health Maintenance System (HMS) is included to provide two main functions:

In-flight preventive, diagnostic, and therapeutic medical care: In real-time situations, an expert system will warn of changes in a crewmember's condition, and be able to identify a complex or rare case. It will also help to formulate likely diagnoses based on the patient's data. To eliminate inconsistencies, the system

5.4. METTLE: Mission to Europa to Trace Life's Existence

checks for errors and omissions from a database of existing treatment plans. The same system is also used to prescribe medications, monitor potential drug interactions, and assist with clinical image interpretation.

Patient stabilization and transport for serious medical situations: Medical evacuation to Earth is generally impossible during interplanetary missions and communication delays will make support from the ground unfeasible. As such, the emergency medical system will have to become autonomous, intelligent, and reliable. This means that the HMS will require access to numerous medical consumables and advanced diagnostic tools and treatment equipment, including software, hardware, and consumables. At a time of critical injury, the crewmember will require stabilization for transport to the medical sickbay, with initial necessary first aid performed with the assistance of the HMS.

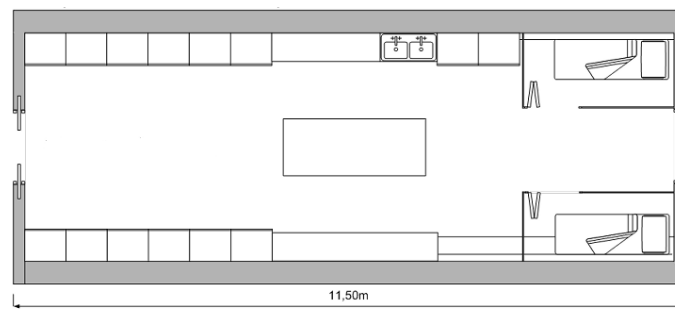

Figure 5.8.: Medical care onboard spacecraft.

5.4.3. Coping with Psychological Issues

Due to the long mission duration, any potential psychological problems will be largely intensified and new psychological issues may arise. To handle these challenges effectively, crewmembers will utilize general stress-reduction methods such as relaxation, autosuggestion, meditation, and biofeedback. Crew families will also be trained to increase their sensitivity to psychological issues and will provide regular support throughout the mission.

The affects of a possible death of a crewmember have to be taken into account. Learning about the psychological and physical burdens experienced by people in analogous situations (for example, Naval crews or Antarctic expedition teams), would help prepare the crew and alleviate psychological stress. Besides direct human interaction, the following are deemed as necessary for providing good psychological support during the mission:

5. Case Study: Mission to Europa To Trace for Life's Existence (METTLE)

Expert Systems

To help with the monitoring, expert systems will be placed to analyze crew movement and keep constant watch over mental performance, circadian rhythm, emotional state and behavioral health, and interpersonal relationships. To reduce stress and anxiety, sensory stimulation through simulated Earth views and sounds projected on large video screens and emanating from speakers provided. These screens will be located in private quarters as well as in public recreational areas.

Food and Drinks

Food and drinks are also seen as important tools for maintaining psychological well being. The crew will make their own menus according to personal and cultural tastes, with access to many types of foods such as fruits, vegetables, meat, and drinks. Food packaging is extremely important for freshness, storability, and preparation.

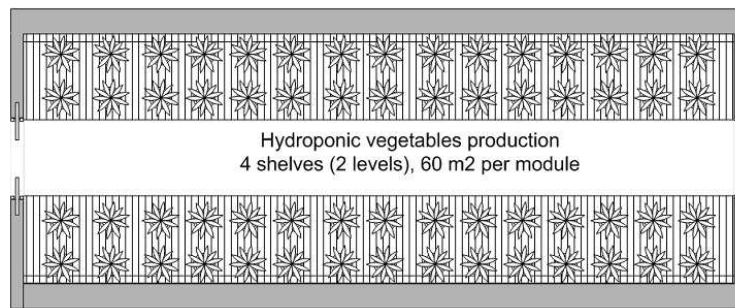

Figure 5.9.: Hydroponic space of the spacecraft

This long-duration mission cannot rely on resupplies of fresh food from Earth. Moreover, non-perishable food cannot provide sufficient nutrition alone to adequately support the crew and the amount of frozen food that can be taken is restrictive. Thus, the spacecraft will include several growth chambers for plants to provide fresh food. Up to six modules of the habitat ring can be devoted to this purpose, each sheltering 60 m^2 of flora on four shelves. The processing equipment for this system is highly automated and safe, is suitable for use in microgravity or hypogravity as well as in hermetically-sealed habitats, and is a vital part of the ECLSS system. Crewmembers will realize both nutritional and psychological benefits from consuming fresh hydroponically grown crops (potatoes, soybeans, etc.). To prevent contamination from microbial organisms in the hydroponic bays, they will be isolated from the rest of the spacecraft.

Communication

The large distance between the Earth and Europa results in a communications delay of approximately one hour, therefore preventing real-time communication.

5.4. *METTLE: Mission to Europa to Trace Life's Existence*

Procedures are required to regulate communications on a store-and-forward basis, and will include full-motion video, audio, and computer-based modes. Also, computer-to-computer transmissions (e-mail up and downlink, telemetry, text, graphics, and video) are required. This system is autonomous, choosing the best moments to transmit and receive data. The main transmissions will be made up of:

- Regular news from the Earth (science, sports, cultural events, etc.)
- Regular, private, and secure crew-to-family and friends communications (e-mail or one-way audio/video transmission)
- Regular, private, and secure medical/psychological counseling sessions (e-mail or one-way audio/video transmission)
- Regular crew communications for public outreach and education where astronauts share their experiences (e-mail or one-way audio/video transmission)
- Regular crew-to-scientist communications

Sleep Quality

Spacecraft design, habitability, and work cycle design will support normal sleep periods to prevent disruption of the crewmembers' circadian rhythms. Work and sleep cycles will be regulated by zeitgebers, environmental signals including sources of sun-like light, sounds, and alarm clocks.

Scheduling

Precisely-timed schedules for crew work can be problematic during long-duration missions. The present approach is to use standard duty schedules that permit regular personal time and rest days. Crewmembers will have some authority to determine or modify their schedules. In order to balance overload and underload of crew schedules and to decrease boredom, rotating duties to maintain crew skills are provided. Refresher training and performance assessment will also be included throughout the flight.

5.4.4. Maintenance Operations

Technologies for system repair are essential. The complexity of the spacecraft, the long mission duration, the high probability of equipment failure, the communication time, and the impossibility of resupply make a complete maintenance system one of the most critical components of the mission. This requires both maintenance within the spacecraft itself, as well as external.

5. Case Study: Mission to Europa To Trace for Life's Existence (METTLE)

Intravehicular Maintenance System (IMS)

The internal maintenance operations will mainly be achieved by the crewmembers keeping a constant watch over a network of sensors that monitor subsystem activity. The IMS will include replacement parts, hoses, wire, connectors, supplies, procedures for mocking up integrated circuits (ICs) through programmable ICs, decision support and expert systems, troubleshooting drawings and procedures, and other electronic tools. A preliminary design consideration is to have uniform materials; repair materials should be carefully selected to ensure that uniform materials are used throughout the vehicle, making it easier to replace and manufacture parts during flight.

Extravehicular Maintenance System (EMS)

The three main duties of the external inspection, fault detection, diagnosis, and maintenance system are:

- Visual inspection of exterior of spaceship surfaces, path planning, and coverage planning
- Automated and early anomaly detection and interpretation in subsystems: the detection process needs to determine that the system is in fault state and describe the fault, including determination of the type, location, time, and magnitude of the fault
- Change-out of components, repair works, and accessing obstructed components.

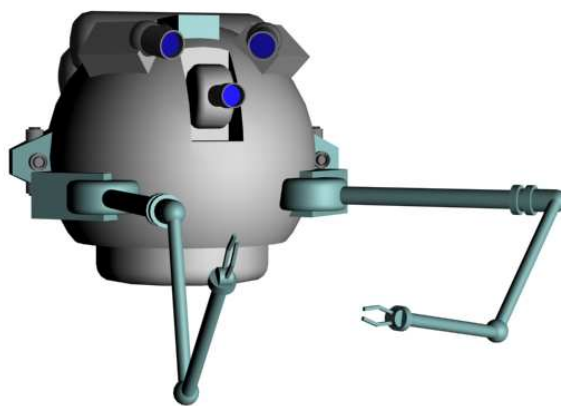

Figure 5.10.: Maintenance Robot Assistant (MRA).

For extravehicular activities, the main element of this maintenance system is an autonomous (or supervised autonomous) and free-flying Maintenance Robot

5.4. *METTLE: Mission to Europa to Trace Life's Existence*

Assistant (MRA) with robotic arms, cameras, and sensors, as well as the ability for intelligent interpretation of collected data as shown in Figure 5.10. It will be:

- Able to understand the complex spacecraft environment, plan paths in three dimensions, recognize locations and objects, deal with nominal and non-nominal situations, and interact with people and other automated agents
- Sent outside to perform dangerous operations; for example, repair of nuclear reactors
- Designed to transport, connect and disconnect, screw and unscrew, weld, replace components, and perform assembly sequences (assembling small structures)
- Capable of performing tasks in a high radiation environment without affecting its circuitry
- Provide assistance to crewmembers during EVA by monitoring environmental factors, documenting events, detecting failures, and helping with maintenance operations (for example by reading and managing checklists for an astronaut doing a manual procedure or reaching tools and spare parts, recognizing astronaut emotional and physical condition, responding to natural language, gestures).

5.4.5. Science During the Flight

The trajectory of a flight to Jupiter has to first cross the asteroid belt. While traversing this region, a close flyby of an asteroid might be achieved, with a possibility of collecting samples and data so as to help understand their geological evolution and surface variability.

A tiny supervised autonomous probe can be sent from the crewed spaceship to land on a nearby asteroid or dormant comet, to collect samples and perform in-situ analysis. On the asteroid, the probe can make several one-second touch-and-go contacts to collect samples from its surface. A second technique to collect material would be to use a hovering probe similar to the way a hummingbird gathers pollen from flowers. Thirdly, a high-speed drill could be extended into the asteroid's surface, capturing fragments and storing them in small chambers for analysis.

On a dormant comet, the probe can drill through the comet's gravel-like shell to reach the ice beneath. Then, a tube will descend into the drilled hole, and, using heat from onboard RTG or fuel cells, slowly melt the ice, pumping the liquid into a tank. The data will be transmitted back to the spacecraft for further analysis and studies. Unfortunately, this option would require a substantial amount of ΔV unless the asteroid is in the exact same orbit as the spacecraft. Therefore, an alternative option would be to analyze the asteroid using LIBS (see Section 3.4).

5. Case Study: Mission to Europa To Trace for Life's Existence (METTLE)

Along with asteroidal research, space provides perfect conditions for astronomical observations. Throughout the months spent in interplanetary space, the crew can make observations using telescopes, radar, and LIDAR.

5.4.6. Submarine Design

The METTLE crew will be on Europa for a period of sixty days due to the limitations of the life support system. Accommodating human life and supporting the collection of scientific data necessitates the placement of a habitat structure in the European ocean, below an ice sheet several kilometers thick. The ice not only provides a means to shield the crew from the harsh radiation, but the ocean below is an ideal environment for astrobiological research. A few of the factors affecting the design of both the habitat and the ascent/descent vehicle, is crew size, required operations, weight, and economic considerations. Accordingly, a crew of three will travel to Callisto to rendezvous with the others sixty days later, after the Europa-bound crewmembers have explored the underwater environment on Europa. To accomplish this, a submarine will be used for its proven ability to withstand high pressures and maneuver in the ocean.

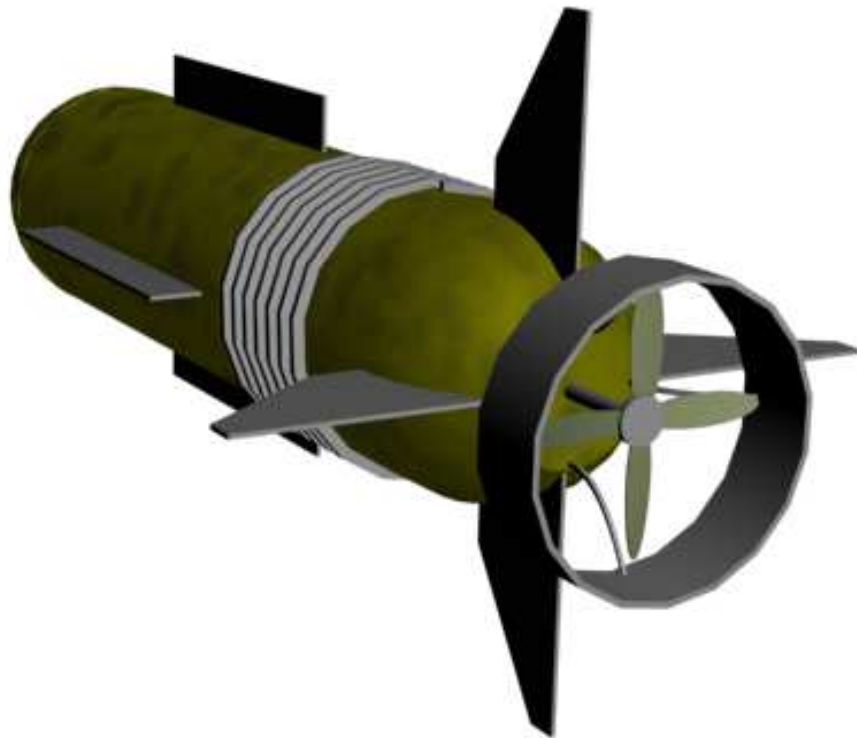

Figure 5.11.: Submarine for subsurface activities.

For the purpose of habitation, living quarters have been allocated on the sub-

5.4. *METTLE: Mission to Europa to Trace Life's Existence*

marine. This space will provide the necessary room for bedding, dining, and entertainment-related activities. Other segments of the submarine include the following: a scientific laboratory; a nuclear reactor extending 10 m from the front and weighing 100 t; an ascent stage consisting of fuel tanks to store 75 t of hydrogen; compartments for probes; an engine room; under floor storage for food in the laboratory; and living quarters. This will give the submarine a total length of approximately 30 m and mass of 200 t. The reactor will be placed in the forward compartment to maximize heat rejection when melting through the icy surface of Europa.

Under the ocean, there will likely be perpetual darkness. Therefore, the submarine will be equipped with very powerful lights for the crew to view their surroundings and perform tasks requiring visual information.

5.4.7. Descent and Ascent Vehicle Design

Upon arrival into European orbit, multiple ice penetration probes will be launched in the vicinity of the landing site in order to obtain data on the characteristics of the ice and ensure that no obstacles are present in the ice sheet. Based on the outcome of data gathered, the descent vehicle will fly to the confirmed landing site and begin operations.

The descent vehicle, capable of transporting 200 t to the surface, will convey the crew of three in the submarine to the surface of Europa. This vehicle will be an expendable component of the excursion and will remain on the surface. The ascent stage is incorporated into the submarine, which will return the crew along with the forward portion of the submarine to the spacecraft (see Figure 5.12 and figure 5.13). This allows for mission flexibility by providing the freedom to launch and dock to the orbiting spacecraft from any location on Europa. It also has the additional advantage of eliminating the need to track the submarine below the ice for rendezvous with the descent vehicle as well as the complications associated with reconnecting the submarine prior to ascent.

To allow the submarine to penetrate the ice to provide vertical stability, the descent vehicle will be designed such that the lower conical portion opens to allow the submarine to be lowered. Once the lower conical section is opened, the submarine will be released slowly, allowing the nose to touch the ice and begin the melting process. When enough of the submarine has penetrated the ice, the clamps will be released. The submarine will then continue to melt the ice until it reaches the ocean. When the vessel reaches the ocean, it will turn to a horizontal position and start behaving like a normal submarine.

To protect the crew from the hazardous radiation during landing, lift-off, and operations on Europa, magnetic shielding will be used. Superconductive magnets and plasma injectors deviate any radiation particles, including those with the magnitude of several GeV (see Section 3.3.9). To protect the crew from the resulting magnetic field, the submarine will be lined with nickel, a material of high magnetic permeability.

5. Case Study: Mission to Europa To Trace for Life's Existence (METTLE)

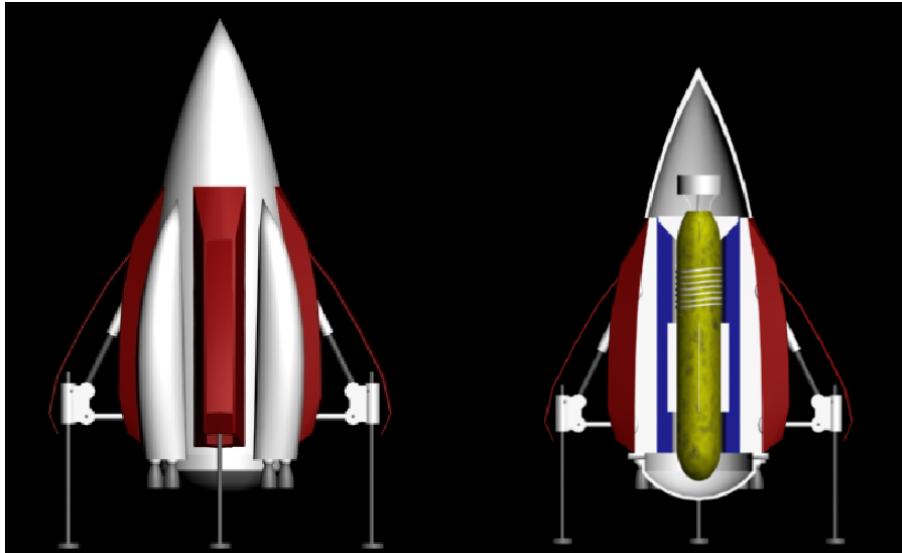

Figure 5.12.: Descent vehicle with submarine/ascent vehicle inside and cutaway view.

For simplicity, the majority of subsurface activities will take place in the equatorial regions, such that the ascent will place the submarine in the equatorial plane for rendezvous with the spacecraft. This mission design does not leave the nuclear reactor on Europa, preventing contamination and thereby adhering to the Planetary Protection principles (see Section 4.2).

In-situ resource utilization will be used to fuel the ascent vehicle within the submarine by splitting the water from the European ocean into hydrogen and oxygen. The hydrogen is stored and a small proportion of the oxygen is used for the life support system.

Throughout its subsurface exploration studies, it will be necessary to communicate through the ice with the spacecraft on Callisto. This task is extremely difficult, and if there are salts present in the ice, the microwave frequencies will be greatly attenuated. To overcome these challenges, a series of small buoys will be ejected every 300 m, which will hold onto the ice (see Figure 5.14). In the event that one probe is inoperational, the others can communicate with ones above or below it.

A nuclear power source onboard the submarine is necessary to melt the ice sheet, shield from radiation, and provide fuel for ISRU. The nuclear reactor will have the additional benefit of providing constant power throughout its long submergence. Specifically, the nuclear reactor used here is similar to a scaled up version of the SAFE-400, providing a power output of 30 MW_t (ISU, MSS 04, 2003). It is also assumed that reactor efficiency has been so developed as to have increased by a factor of two by the time of the mission. In addition, the reactor will operate at high power levels during the ice melting process and revert to lower power levels in the ocean. Typically the specific impulse of these systems is in the region

5.4. METTLE: Mission to Europa to Trace Life's Existence

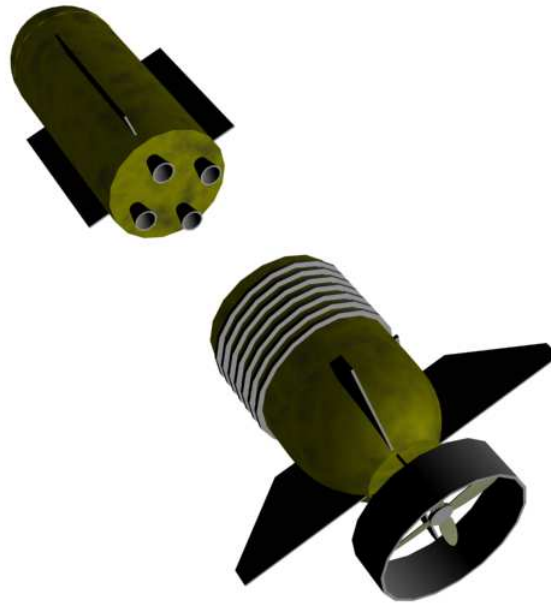

Figure 5.13.: Separation of submarine for ascent (rear).

of 900 seconds, requiring fuel of approximately 75 t for attaining altitudes in the range of 100 – 1000 km.

The surface temperature on Europa is between 85 K and 125 K, and only 50 K at the poles (Biele et al., 2002). The ice is hard, with thickness estimates ranging from 2 km to 50 km. It is probably thinnest near equatorial latitudes due to tidal heating effects caused by Jupiter and the other large moons (ISU, MSS 04, 2003).

Many difficulties stand in the way of success. The first is when drilling through the ice, the tunnel walls of a long hole would buckle. The second difficulty is that of keeping the hole open in spite of possible movements of Europa's ice crust. Also, the drilled ice should be somehow removed. Furthermore, when drilling

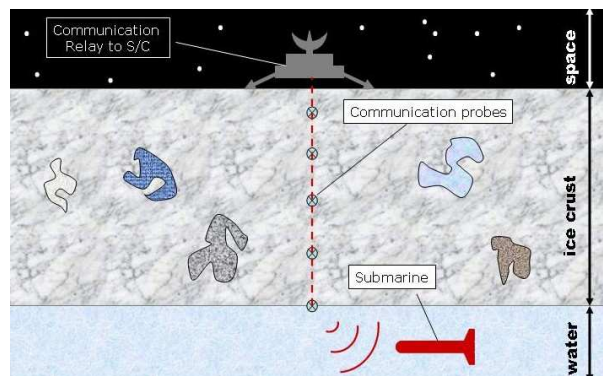

Figure 5.14.: Communication architecture for subsurface activities using small relay probes released during melting.

5. Case Study: Mission to Europa To Trace for Life's Existence (METTLE)

from a fixed machine on the surface, hole diameter decreases with depth and the reduced gravity (compared to the Earth) decreases drilling efficiency. Finally, the ocean's surface may be supercharged with gases, in which case water is forced towards the surface and making descent to the ocean difficult (C. McKay, personal communication, 2004).

An alternative approach to this challenge is to melt through the ice with a "cryobot," a vessel which melts the ice in front and allows it to refreeze behind. Melting through ice requires a lot of energy, but there is enough heat energy to melt the ice under the nose cone when the submersible is in a vertical position. With hot water injected under the cone, and the help of gravity, the submersible will melt the ice. The melted water then rises on the rim to the back of the submarine, and refreezes behind it (Biele et al., 2002).

In order to calculate the power and time required for the melting procedure, the temperature profile and the melting temperature of ice must be known (see Appendix A). The melting time is directly proportional to ice thickness. Figure 5.15 shows melting time as a function of vessel diameter for three different heating power levels. A 20% margin for heat loss has been taken into account, and along with a submarine diameter of 3.5 m, an ice thickness of 3 km, and the available heating power including losses 30 MWt, the time required to melt through the ice is approximately 160 hours.

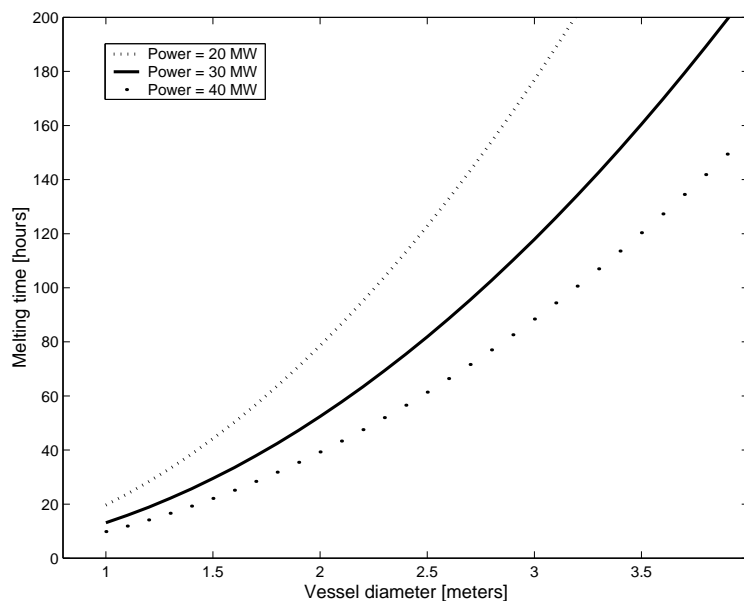

Figure 5.15.: The melting time as a function of the vessel diameter at three different heating power levels for an ice thickness of 3 km.

The ice is not homogeneous. It may have voids, cracks, and sediment layers. Because of its shape, the vessel must have an active attitude control system to avoid it from leaning and toppling over. The attitude control is based on controlling the heating power by means of heat pipes and valves (Biele et al., 2002),

so that the heat distribution can be automatically set to avoid deviations from the vertical direction.

5.4.8. Subsurface Activities

The purpose of carrying out subsurface activities is to find out whether life currently exists or has existed previously in the ocean of Europa. If present or past life is found, one of the major questions that would need to be answered is if life is different from that on Earth (i.e. based on twenty left-handed amino acids) and if so, in which ways does it differ. For this, the following goals have been set:

- Structural and compositional analysis of organics (e.g. mass spectrum of molecules of size up to 10000 amu) in order to identify possible biological patterns
- Determination of the elemental and isotopic compositions relevant to past or present biological productivity (e.g. C_{12}/C_{13} and N_{14}/N_{15} ratios)
- Determination of the abundance of anions, cations, and volatiles (e.g. CO_2 , CH_4 , O_2)

The science instruments required to achieve these goals are (Gershman et al., 2003; Biele et al., 2002):

- Aqueous chemistry unit, including sensors for pH, salinity, electrical conductivity, and reduction-oxidation potential
- Environmental sensors to give standard data on the environment, such as temperature and pressure
- Microscope
- Visible/near-IR point spectrometer, Raman spectrometer, fluorescence spectrometer, and micro-biophotometer : detailed analysis of aqueous solutions and biological agents
- Gas chromatographer/mass spectrometer unit to analyze the mass spectrum of molecules
- Differential scanning calorimetry to investigate the effects of heating molecules
- Oxygen microelectrodes to provide a direct measure of oxygen concentration.

If signs of chemical evolution (e.g. amino acids and nucleotides) are detected in the ocean, the next step will be to investigate water samples to see if they contain microbes. If so, they need to be imaged through a variety of biochemical tests, characterized, and analyzed in comparison to Earth samples. This experiment will involve three steps (Chela-Flores, 2002):

5. Case Study: Mission to Europa To Trace for Life's Existence (METTLE)

1. Introduction of a microorganism in a previously prepared solution of ions
2. Alteration of the concentration mechanically
3. Inspection of the changes in cell polarization.

Difficulties typical of remote control are not easy to solve in these types of electrophysiological experiments. Human field scientists are necessary to conduct the complex experiments and make adjustments as new data and interesting results emerge.

In addition to the instruments mentioned above, the hydrobots shown in figure 5.17 will carry sonar to map the ocean bed and to conduct studies. For example, they may be used to take samples of the ice, water and the ocean bed, with particular emphasis on possible hydrothermal vents (see figure 5.16). That life exists here is considered a viable possibility due to the known existence of extremophiles (microbial organisms) flourishing under extreme conditions on Earth. In order to reach an ocean bed of more than 100 km deep (ISU, MSS 04, 2003), the hydrobots must withstand high pressures, on an order of magnitude of 10^8 Pa (1000 atm).



Figure 5.16.: Hydrothermal vent investigated by a hydrobot. Courtesy of NASA/JPL and Caltech.

The hydrobots will contain an integrated vision system. Accurate motion will be provided by two side motors that will have two degrees of freedom, allowing them to rotate along an axis parallel to their main longitudinal axis. They can be controlled from the submarine, or may run autonomously to avoid obstacles and collect objects. For communication purposes, the hydrobots will contain two systems: an acoustic communication system and a laser-based communication. These systems are known to reach over 2000 – 3000 m in distance. Due to limitations of communication, for deep ocean observation, the hydrobots must operate autonomously.

To perform further studies of the European ocean, a fleet of 0.2 m^3 spherical probes with a diameter of 10 cm will be released from the main submarine. Each



Figure 5.17.: Hydrobot design for European subsurface activities.

sphere will contain microsensors to measure temperature, salinity, pressure, acidity, and radiation; one microfuel cell with an operational life-time of the submergence duration; a nanoprocessor and microemitter-receiver will send and receive all data to a minimum of three fixed relay buoys which to pass on the data to the main submarine using acoustic telemetry technology. Figure 5.18 shows the communication architecture. The probes will also contain positioning systems based on the three fixed buoys that can be used to determine the characteristics of ocean currents.

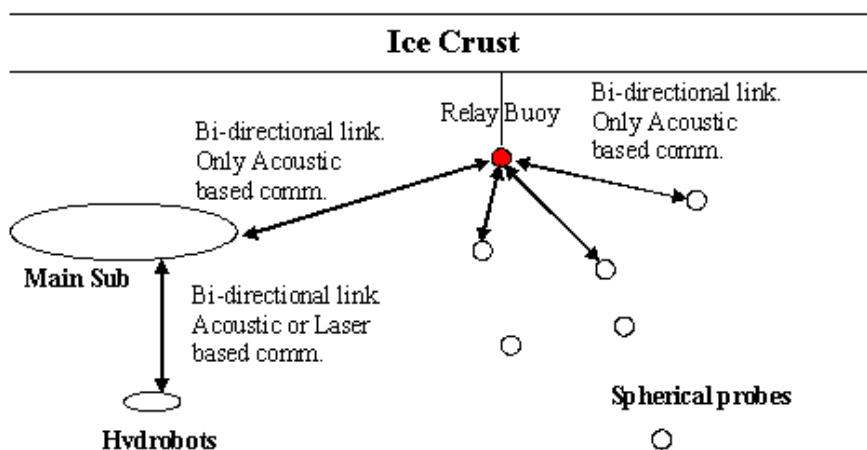

Figure 5.18.: Communication architecture for subsurface European activities.

5.5. Conclusion

METTLE outlines the vision our team has of a mission, using technologies made available through the Theseus Program. It illustrates where and how these technologies are used during the mission and provides a global view of what the

5. Case Study: Mission to Europa To Trace for Life's Existence (METTLE)

team is trying to encompass. Although Titan has not been addressed in this case, it should be noted that while it is a moon of significant interest for its atmospheric properties, the probability of life is greater on Europa.

METTLE, a four year mission incorporating a two month subsurface study on Europa, involved the design of a spacecraft capable of transporting six crewmembers in a partial gravity environment of 0.45 g. The spacecraft consists of many psychologically mitigating designs maximizing crew comfort. To perform subsurface exploration of Europa, a descent vehicle was designed to transport a crew of three within a submarine. Here, it would melt through an ice sheet 3 km thick and perform the necessary investigations before melting its way up. Upon reaching the surface, the ascent vehicle will detach itself from the submarine and rendezvous with the spacecraft for a return journey to Earth. See Table 5.2 for a summary of the technologies used during this mission.

Critical milestones of the Theseus Program influencing mission design	Technologies adopted for the mission	Method of incorporation
Propulsion	VASIMR	Eight 2.5 MW Ar fuelled VASIMR engines for spacecraft
Power	Nuclear fission reactors	Six reactors with 5 MW _e power requirement
ISRU	LOX/LH production	Submarine uses electricity from the nuclear reactor to produce LH for ascent
ECLSS	ECLSS	The torous ring provides the necessary space for bioregenerative life support system
Artificial Gravity	Torus ring	Torus ring of 45 m outer radius with a revolution of 3 rpm
Habitation	Modularized within the torus ring	The habitat ring has a diameter of 4.5 m and a habitable surface of 1000 m ² based on the psychological concerns from the Development Plan
Radiation	Magnetospheric shielding	Superconductive magnets coupled with plasma injectors for spacecraft and submarine radiation protection were placed in the center of both

Table 5.2.: Technologies incorporated from the Theseus Program during the mission design.

In addition to incorporating the necessary technologies to enable this human mission, the case study has incorporated aspects on crew selection, habitability with particular to psychological concerns and maintenance, and subsurface studies not addressed by previous exploration programs beyond the Moon, such as NASA's HOPE study and ESA's Aurora Programme.

The team would like to further emphasize the effects of the political and economical climate on the overall mission design, since the choice of trajectory, habitation design, and spacecraft design are all closely coupled together based on the circumstances present at the time. This is only one possibility, and it is anyone's guess as to what the future may hold.

5. *Case Study: Mission to Europa To Trace for Life's Existence (METTLE)*

*We shall not cease from our
exploration, and at the end of all our
exploring, we shall arrive where we
started and know the place for the first
time.*

T. S. Eliot

6. Conclusions

Throughout history, there have been many grand gestures, moving speeches, and convincing promises with regards to space exploration. Fortunately, sometimes these come to fruition and programs such as Apollo, Mir, Galileo, and the ISS are the results. However, none of these space endeavors would have occurred had it not been for the imagination and unwavering resolution of determined individuals to see the visions become reality.

The challenge proposed to our team of twenty-nine individuals from around the world, *Human Missions to Europa and Titan – Why Not?* is another such vision, one which stirs the imagination and inspires a belief that the seemingly impossible can be achieved. However, before anything of this magnitude and complexity can be realized, advances and changes in the scientific, political, technical, economic, and societal arenas are required. Thus, it was necessary to map out each of the above aspects, beginning from the present day, and hypothesizing about what the future might hold. The recent US Space Initiative and ESA's Aurora Programme provided many potential resources, as much of the work done to send humans to the Moon and Mars can be applied to a mission to the Jovian or Saturnian systems. Additionally, the in-progress Cassini/Huygens mission and the planned robotic mission, JIMO, were also incorporated into our timeline of events.

It can be acknowledged that it is unrealistic to plan a human mission to the outer solar system in the immediate or very near future due to certain necessary lacking competencies. Identifying these deficiencies was the first step of the process. Before attempting to send humans, these obstacles must be overcome. Next, potential solutions were presented in the form of precursor ground- and space-based missions. Descriptions were given of the technological and scientific aspects of the Theseus Program, as our Development Plan is called. Decisions such as using nuclear propulsion and active radiation shielding techniques were determined to be the most viable solutions, based upon current knowledge and in anticipation of possible future advancements. Likewise, habitation, psychological, and physiological concerns were addressed, with suggested solutions such as the creating artificial gravity through the rotation of a toroidal-shaped habitation module. Program management aspects of the Development Plan were also covered, including four scenarios that discuss possible future conditions which would enable such a monumental undertaking. The scenarios consist of an international, publicly-funded venture, a non-profit organization, a privately-funded venture, and one in which major shifts in societal perception of human missions are defined. Finally, a case study, METTLE, is given as an example of how a human mission to Europa could be enabled by the Theseus Program.

6. Conclusions

This mission is a challenge, far beyond the reach of most current competencies. As such, it will likely be met with incredulity by many. However, incredulity is nothing new for those who work in the space sector; Robert Goddard's theories about rocketry were attacked by the New York Times on 13 January 1920 for lacking "the knowledge ladled out daily in high schools" (Cooper, Jr., 2004). By listening to detractors, we succeed only in diminishing our goals, but by listening to our hearts, we are capable of accomplishing incredible feats. Unfortunately, great achievements do not often come without great sacrifice. Space exploration must continue despite setbacks, injuries, and loss of life; it is in our very nature to seek out new frontiers, to satisfy our curiosity for the unknown. Likely, when a plan such as the Theseus Program is initiated, humankind will be surprised not only by what is discovered about the solar system, but also about itself. It is a dishonor to all those who have given their blood, sweat, and lives in pursuit of the dream of space exploration if we do not continue to strive beyond the impossible — to answer the challenge of *Why Not?*

A. Ice Penetration Calculation

The temperature of a thermally-conductive layer is given by (Biele et al., 2002)

$$T(z) = T_s \exp\left(\frac{z}{b}\right), \quad (\text{A.1})$$

where T_s is the surface temperature at $z = 0$ and parameter b is

$$b = \frac{h}{\ln\left(\frac{T_b}{T_s}\right)}, \quad (\text{A.2})$$

where h is the ice thickness, and T_b is the temperature at the ice base, which is close to 270 K. If the landing site has a surface temperature of 100 K, then parameter b is approximately equal to h . The melting temperature depends on the pressure of the ice. For pure water, an empirical formula is (Biele et al., 2002)

$$t_F = 0 - 0.00076p - 1.32 \times 10^{-6}p^2, \quad (\text{A.3})$$

where t_F is the melting temperature in °C and p is the pressure in bars for $0 < p < 2000$ bar. The pressure is $p = \rho gh$, where ρ is the density of ice (920 kg/m³) and g is the gravitational constant on Europa (1.32 m/s² (Rogers, 1995)). For a 10 kilometer thick ice layer the pressure at the bottom of the layer is approximately 120 bars (or atm). At this pressure equation A.3 gives a deviation from 0 °C, which is less than 0.2 °C, so it can be neglected in this calculation. The melting point will also be lower if there are salts present in the ice. If the heating power without losses is P , then the melting speed V at depth z is (Biele et al., 2002)

$$V(z) = \frac{P}{A\rho(c_p(T_F(z) - T(z)) + L_v)}, \quad (\text{A.4})$$

where A is the cross-sectional area of the vessel, c_p is the specific heat capacity of ice (ranging from 1.5 kJkg⁻¹K⁻¹ to 2.2 kJkg⁻¹K⁻¹), T_F is the local melting temperature, and L_v is the heat of fusion of the ice (330 kJ/kg). The hole that is melted has to be bigger than the diameter of the vessel to permit the flow of melted water. That and the conductive heat losses in the surrounding ice increase the power required to achieve speed V by 20%. Using equations A.4 and A.1, the time t required to melt through the ice is

$$t = \int_0^h \frac{dz}{v(z)} = \frac{Ah\rho}{P} \left(c_p T_F + L_v - c_p \frac{T_b - T_s}{\ln \frac{T_b}{T_s}} \right) \quad (\text{A.5})$$

A. Ice Penetration Calculation

assuming that T_F is constant. If a typical surface temperature of 100 K is used, the equation becomes

$$t = 1.39 \times 10^5 \times \frac{Ah}{P}, \quad (\text{A.6})$$

where t is in hours, A in square meters, h in meters, and P in Watts. The melting time is directly proportional to the ice thickness.

B. Advanced Mission Cost Model: Input Description and Results for Jovian Missions

This is a simple online advanced missions cost model (AMCM) that provides a useful method for quick turnaround, rough-order-of-magnitude estimating. The model can be used for estimating the development and production cost of spacecraft, space transportation systems, aircraft, missiles, ships, and land vehicles (NASA, 2004) . The input parameters for this cost model are described below:

Quantity The quantity is the total number of units to be produced. This includes prototypes, test articles, operational units, and spares.

Dry weight The dry weight is the total empty weight of the system in pounds, not including fuel, payload, crew, or passengers.

Mission type The mission type classifies the type of system by the operating environment and the type of mission to be performed.

IOC Year The IOC is the year of Initial Operating Capability. For space systems, this is the year in which the spacecraft or vehicle is first launched.

Block Number The block number represents the level of design inheritance in the system. If the system is a new design, then the block number is 1. If the estimate represents a modification to an existing design, then a block number of 2 or more may be used. For example, block 5 means that this is the 5th in a series of major modifications to an existing system.

Difficulty The difficulty factor represents the level of programmatic and technical difficulty anticipated for the new system. This difficulty should be assessed relative to other similar systems that have been developed in the past. For example, if the new system is significantly more complex than previous similar systems, then a difficulty of high or very high should be selected.

Table B.1 summarizes the inputs and the results for the Jovian missions (Section 3.3.1).

Assumptions for the model

B. Advanced Mission Cost Model: Input Description and Results for Jovian Missions

1. The estimation of the spacecraft dry mass is calculated with respect to the JIMO mission. The specifications set the payload mass to 700 kg. The JIMO Science Definition Team has requested that the payload be doubled (Figueroa, 2004), suggesting that the spacecraft mass (taking into account the advanced propulsion and power capabilities) could have a mass of approximately 3t. The spacecraft(s) for the Europa Sample Return mission are expected to have significantly larger mass, due to the increased complexity of the mission. The prediction of the launch dates for each mission is discussed in Section 3.2.
2. Three prototypes are considered for each unique spacecraft used in the different missions.
3. The cost model does not take into account any technology development that might be required for each mission or the cost for mission operations. The JIMO mission has at least \$2B USD allocated from the Prometheus program for the incorporation of nuclear fission in the spacecraft design (Wood et al., 2004). Using the JIMO mission as a guideline, we could assume that approximately an additional \$2B USD would be required for each mission to take advantage of new technologies.
4. Due to the complexity and the long duration of any planetary mission, mission operations could increase the total cost by at least 10%. In addition to that, because of the large uncertainty in dry mass and mission design, a 30% margin was considered in the estimation of the total cost. This leads to a total cost of approx. 60B USD.

Mission	Mission Type	Dry mass [t]	IOC Year	Difficulty	Technical Innovation	Total Cost [B\$, economic year 2004]
JIMO	Orbiter	3.0	2011	Very high	Nuclear fission	9.0
Europa and Callisto Explorer	Orbiter +2 Landers	2.0 1.0	2025	High Very High	–	6.0
Io Radiation Explorer	Orbiter	1.0	2025	Average	–	1.5
Europa Subsurface Explorer	Orbiter Lander	1.5 1.0	2035- 2040	Very high Very high	melting probes and hydrobots	11.0
Europa Sample Return Mission	Orbiter Lander	2.5 2.0 ¹	2050- 2055	Very high Very high	ISRU	17.0

Table B.1.: Cost estimation for the development (phase-A to launch) of Theseus' scientific missions to Jupiter, using the Advanced Mission Cost Model from NASA (NASA, 2004).

B. Advanced Mission Cost Model: Input Description and Results for Jovian Missions

C. Acronyms and Abbreviations

A

AMCM Advanced Missions Cost Model
APAETF Aminonpropyl-aminoethyl thiophosphoric acid

B

C

CCD Charge Coupled Device
CEV Crew Exploration Vehicle
CLSS Closed Life Support System
COPUOS (UN) Committee on Peaceful Uses of Outer Space
COSPAR (UN)Committee on Space Research

D

DARPA Defense Advanced Research Projects Agency
DLR Deutsches Zentrum für Luft- und Raumfahrt (German Aerospace Center)

E

ECLSS Environmental Control and Life Support System
EM Electromagnetic
EMS Extravehicular Maintenance System
EPEX Electric Propulsion Experiment
ESA European Space Agency
ESO European Southern Observatory
EVA Extravehicular Activity

F

FEOM Foundation for Exploring the Outer Moons

G

GCR Galactic Cosmic Radiation
GEO Geostationary Orbit
GNC Guidance, Navigation and Control

H

HMS Health Maintenance System

C. Acronyms and Abbreviations

HOPE	Human Outer Planet Exploration
<u>I</u>	
IC	Integrated Circuit
ICF	Inertia Confinement Fusion
IGA	Inter-Governmental Agreement
IMS	Intravehicular Maintenance System
IOC	Initial Operating Capability
IR	Infrared
ISAS	Institute of Space and Astronautical Science
ISC	International Space Consortium
ISOC	Integrated Space Operation Centre
I_{SP}	Specific Impulse
ISRU	In-situ Resource Utilization
ISS	International Space Station
ISU	International Space University
ITER	International Thermonuclear Experimental Reactor
ITU	International Telecommunications Union
<u>J</u>	
JIMO	Jupiter Icy Moons Orbiter
JSC	Johnson Space Center
<u>L</u>	
LEO	Low Earth Orbit
LH	Liquid Hydrogen
LIBS	Laser Induced Breakdown Spectroscopy
LOX	Liquid Oxygen
LSS	Life Support System
LV	Launch Vehicle
L1	Lagrangian Point (of the Earth-Moon system) 1
<u>M</u>	
MAI	Moscow Aviation Institute
MARIE	Martian Radiation Environment Experiment
MCF	Magnetic Confinement Fusion
MELISSA	Micro-Ecological Life Support System Alternative
METTLE	Mission to Europa To Trace for Life's Existence
MOU	Memorandum of Understanding
MPD	Magneto-Plasma Dynamic
MRA	Maintenance Robot Assistant
MSR	Mars Sample Return
MSS	Master of Space Studies
MTF	Magnetized Target Fusion

MW_e MW electrical (power)
MW_t MW thermal (power)
M2P2 Mini-Magnetospheric Plasma Propulsion

N

NASA National Aeronautic and Space Administration
NEEMO NASA Extreme Environment Mission Operations
NEP Nuclear-Electric Propulsion
NTP Nuclear-Thermal Propulsion

O

OST Outer Space Treaty

P

PCU Power Conditioning Unit
pH Acidity
PPU Power Processing Unit

R

RF Radio Frequency
ROM Rough Order of Magnitude
RTG Radioisotopic Thermoelectric Generator
R&D Research and Development

S

SAFE Safe Affordable Fission Engine
SRC Short Radius Centrifuge

T

TAGS Tethered Artificial Gravity Satellite

U

UN United Nations
US United States
USD United States Dollar
USSR Union of Soviet Socialist Republics

V

VASIMR Variable-Specific-Impulse Magnetoplasma Rocket

C. Acronyms and Abbreviations

Bibliography

- Aaron, M. K., K. M. Baker, M. K. Heun, K. T. Nock, A. A. Pankine, S. R. Schlaifer, C. J. Wyszowski, A. P. Ingersoll, R. Lorenz and J. Jones (2002), Planetary Science from Directed Aerial Robot Explorers (DARE) NIAC Phase I Final Report, Technical Report GAC 510-09911-003, Global Aerospace Corporation for NIAC.
- ADERSA, (France)., (France). EADS LV, (Spain). EA Internacional, (Belgium). EPAS, (France). LGCB and (France). Schneider-Electric (2002), Evaluation of Life Support Strategies, ESTEC contract 16213/02/NL/PA, ESA ESTEC, Noordwijk, The Netherlands.
- Alves, E. I. and A. R. Baptista (2004), Rock Magnetic Fields Shield the Surface of Mars from Harmful Radiation, *in* '35th Lunar and Planetary Science Conference'.
- Andrew, W. (2001), Technologies for Exploration, Aurora Programme Proposal Annex D, Technical Report SP-1254, ESA.
- Armijo, J. S., A. T. Josloff, H. S. Bailey and D. N. Matteo, eds (1991), *SP-100 progress. AIAA, NASA, and OAI, Conference on Advanced SEI Technologies, Cleveland, OH, Sept. 4-6, 1991.*
- Beatty, J. K., C. C. Petersen and A.. Chaikin (1999), *The New Solar System*, 4th edn, Sky Publishing Corporation and Cambridge University Press, USA.
- Bedini, D. (2003), 'Humans in Space', MSS class lecture.
- Biele, J., S. Ulamec, A. D. Morse, S. Barber, I. Wright, H. Tug, T. Mock and J. Garry (2002), Melting probes at Lake Vostok and Europa, *in* 'Proceedings of the First European Workshop on Exo-Astrobiology', University of Graz, Austria, pp. 253–260.
- Chela-Flores, J. (2002), Can Evolutionary convergence be tested on Europa?, *in* H. Lacoste, ed., 'Proceedings of the Second European Workshop on Exo/Astrobiology, Graz, Austria, 16–19 September 2002', ESA Special Publications, SP-518, University of Graz, ESA, Graz, Austria, pp. 337–340.
- Clark, R. N. (2004), The Surface Composition of Europa: Mixed Water, Hydronium, and Hydrogen Peroxide Ice, *in* 'Workshop on Europa's Icy Shell: Past, Present and Future'.

Bibliography

- Clement, G. (2003), *Fundamentals of Space Medicine*, Microcosm Press.
- Coghlan, A. (2004), 'Strong arm tactics', <URL:<http://www.newscientist.com/news/news.jsp?id=ns9999455>>.
- Columbia Accident Investigation Board (2003), Columbia Accident Investigation Board Report, Technical report, NASA, Washington, DC.
- Connerney, J. E. P., M. H. Acuña, P. J. Wasilewski, G. Kletetschka, N. F. Ness, F. H. Rème, R. P. Linn and D. L. Mitchell (2001), 'The Global Magnetic Field of Mars and Implications for Crustal Evolution', *Geophysical Research Letters* **28**(21), 4015–4018.
- Cooper, Jr., Peter. (2004), 'Robert Goddard's Relevance Today', <URL:<http://users.wpi.edu/~pcooper/school/suff/paper.pdf>>.
- Coustenis, A., M. Combes, E. Gendron, O. Lai, M. Hirtzig, T. Fusco, L. Mugnier, P. Rannou, L. Vapillon, J.-P. Veran and J. Woillez (2004), 'Images of Titan in the near-infrared with adaptive optics', <URL:http://www.lesia.obspm.fr/planeto/Titan/Web_OA_Titan.htm>.
- Cucinotta, F. A., H. Wu, M. A. Shavers and K. George (2003), 'Radiation Dose-mentry and Biophysical Models of Space Radiation Effects', *Gravitational and Space Biology Bulletin* **16**(2), 11–18.
- de Angelis, G., M. S. Cloudsley, J. E. Nealy, R. C. Singleterry, R. K. Tripathi and J. W. Wilson (2003), Radiation Shielding Analysis for Deep Space Missions, in 'Space Technology and Applications Int. Forum — Staif 2003. AIP Conference Proceedings, Volume 654', pp. 972–983.
- Defense Advanced Research Projects Agency, DARPA. (2004), 'DARPA Grand Challenge', <URL:<http://www.darpa.mil/grandchallenge/>>.
- Demjanko, U. G., G. V. Konjuhov, A. S. Koroteev, E. P. Kuzmin and A. A. Paveljev (2001), *Nuclear Rocket Engines*, OOO "Norma-Inform", Moscow.
- Eckart, P. (1994), *Life Support and Biospherics: fundamentals, technologies, applications*, Herbert Utz Publishers.
- Eligar, S. (2004), 'Human Mission from planet Earth: Finding a Rationale for exploration of Moon and Mars.', <URL:<http://www.space.edu>>.
- England, C. (2003), Are there Oceans Under the Ice of Small Saturnian and Uranian Moons?, in 'American Astronomical Society, DPS Meeting #35,#15.02'.
- ESA, ESTEC. (2004), 'Evaluation of Life Support Strategies', ESTEC contract 16213/02/NL/PA, Presentation by ADERSA, EADS LV, EA International, EPAS, LGCB, SCHNEIDER ELECTRIC.

- European Space Agency (2004), 'Aurora Programme', <URL:<http://esamultimedia.esa.int/docs/AuroraProgrammeExecutiveSummary.pdf>>.
- Farand, A. (2002), 'The Code of Conduct for International Space Station Crews', *ESA Bulletin* **105**, 451–463.
- Figuroa, O. (2004), 'Report of the NASA Science Definition Team for the Jupiter Icy Moons Orbiter (JIMO)', <URL:<http://ossim.hq.nasa.gov/jimo>>.
- Gershman, R. (2002), Concepts for a Titan Organics Explorer (Poster), in '4th IAA International Conference on Low-Cost Planetary Missions'.
- Gershman, R., E. Nilsen and R. Oberto (2003), 'Europa Lander', *Acta Astronautica* **52**, 253–258.
- Hall, D. T., D. F. Strobel, P. D. Feldman, M. A. McGrath and H. A. Weaver (1995), 'Detection of an Oxygen Atmosphere on Jupiter's Moon Europa', *Nature* **373**, 677.
- Hall, T. W. (1994), The Architecture of Artificial Gravity Environments for Long-Duration Space Habitation, PhD thesis, University of Michigan.
- Harris, P. R. (1996), *Living and Working in Space - Human Behavior, Culture and Organization*, 2nd edn, John Wiley & Sons, USA.
- Hastings, D. E. (2004), '16.891J/ESD.129 space Policy Seminar', <URL:<http://ocw.mit.edu/ocwweb/index.htm>>.
- Hecht, H., E. L. Brown and L. R. Rount (2002), Adapting to Artificial Gravity (AG) at High Rotational Speeds, in "'Life in Space for Life on Earth", 8th European Symposium on Life Sciences Research in Space, 23rd Annual International Gravitational Physiology Meeting'.
- Herrick, R. (2004), Venus, Technical report, Lunar and Planetary Institute, Universities Space Research Association. <URL:<http://www.lpi.usra.edu/science/herrick/ESCI214/Venus.html>>.
- Hoffman, J. H. and A. P. Mazzoleni (2003), Investigation of Tethered Satellite System For Generating Artificial Gravity, in 'American Institute of Astronautics, Joint Propulsion Conference, , Huntsville, Al.'.
- ISU, MSS 04 (2003), Human Missions to Europa and Titan — Why Not? A Literature Review , Isu mss team project report, International Space University.
- Jasentuliya, N. (1999), *United Nations*, Martinus Nijhoff.
- Jasentuliyana, N. (1999), *International Space Law and United Nations*, 1st edn, Kluwer Law International.

Bibliography

- Kammash, T. (1997), 'A Fusion Propulsion Vehicle for Man's Exploration of Mars and the Solar System', FTP Server, University of Michigan.
- Kennedy, J. K. and S. D. Capps (2000), Designing Space Habitation, *in* 'Space 2000: Proceeding of Space 2000 - seventh international conference and exposition on engineering, construction, operations, and business in space'.
- Kivelson, M. G., J. Warnecke, L. Bennett, S. Joy, K. K. Khurana, J. A. Linker, C. T. Russell, R. J. Walker and C. Polansky (1998), 'Ganymede's magnetosphere: Magnetometer overview', *Journal of Geophysical Research* **103**(E9), 19936–19972.
- Landis, G. A. (2003), Robots and Humans: Synergy in Planetary Exploration, *in* 'AIP Conference Proceedings, Vol 654(1)', pp. 853–860.
- Landis, L. A. (1991), Magnetic Radiation Shielding: An Idea Whose Time Has Returned?, *in* 'Space Manufacturing volume 8: Energy and Materials from Space (AIAA)', pp. 383–386.
- Lobo, M. and Ch. Lasseur (2003), MELiSSA Final report 2002 activity, Technical report, ESA.
- Lukashevich, V. (2004), 'Buran Shuttle', <URL:http://www.k26.com/buran/Info/Energia_HLV/energia_fly_back_booster.html>.
- Mantieniaks, M. A. and R. M. Myers (1993), 100-kW Class Applied -Field MPD Thruster Component Wear, Technical memorandum 106023, NASA Lewis Research Center.
- Martel, W. and T. Yoshihara (2003), 'Averting a Sino-U.S. Space Race', *The Washington Quarterly* **26**(4), 19–35.
- Matson, D. L., L. J. Spliker and J. P. Lebreton (2002), 'The Cassini/Huygens Mission to the Saturnian System', *Space Science Reviews* **104**, 1–58.
- McCullough, S. (2000), Financing a Manned Mission to Mars, *in* '2000 Mars Society Convention, Toronto, Ontario, Canada'.
- Messerschmid, E. and R. Bertrand (1999), *Space Stations: Systems and Utilization*, Springer-Verlag.
- Messina, P. (2001), European Status on Nuclear Systems for Space Exploration. <URL:<ftp://ftp.estec.nl/aurora>>.
- Messina, P. and F. Onarro (2003), 'Aurora - The European Space Exploration Programme', *ESA Bulletin* **115**(-), 34–39.
- Moltz, J. C. (2004), 'Moonstruck: What's Up with U.S. Space Policy?', <URL:<http://cns.miis.edu/pubs/week/040202.htm>>.

- Moore, W. B. and N. Makris (2003), Understanding Active Processes at the Surfaces of Jupiter's Icy Moons, *in* 'American Geophysical Union, Fall Meeting 2002'.
- Mortazavi, S. M. J., J. R. Cameron and A. Niroomand-Rad (2003), 'Adaptive Response Studies may help choose astronauts for long-term space travel', *Advances in Space Research* 31(6), 1543–1551.
- MSR Team, CDF. and P. Messina (2003), Mars Sample Return Study Overview - Final Presentation ESTEC. <URL:ftp://ftp.estec.nl/aurora>.
- Myers, T. (2002), Space Station 3D. Film. Presented by Lockheed Martin in cooperation with NASA.
- NASA, HQ (2004a), 'NASA Headquarters, Apollo Program Cost Data', <URL:http://history.nasa.gov/SP-4029/Apollo_18-16_Apollo_Program_Budget_Appropriations.htm>.
- NASA, HQ (2004b), 'The vision for space exploration', <http://www.nasa.gov>.
- NASA, HQ (2004c), 'The Vision for Space Exploration'. NASA NP-2004-01-334-HQ.
- NASA, JSC (2004), 'NASA JSC Advanced Mission Cost Model', <URL:http://www.jsc.nasa.gov/bu2/AMCM.html>.
- National Aeronautics and Space Administration, NASA. (2002), Advanced Life Support Project Plan, Technical Report CTSD-ADV-348 Rev C, JSC 39168, Johnson Space Center.
- National Aeronautics and Space Administration, NASA. (2004a), 'Robonaut', <URL:http://robonaut.jsc.nasa.gov/>.
- National Aeronautics and Space Administration, NASA. (2004b), 'Origins - Missions', <URL:http://origins.jpl.nasa.gov/missions/missions.html>.
- National Aeronautics and Space Administration, NASA. (2004c), 'ISS Core Schematic', <URL:http://www.hq.nasa.gov/osf/ISS_Core_Program.pdf>.
- National Aeronautics and Space Administration, NASA. (2004d), 'Mars Rovers Name Competition', <URL:http://www.lego.com/rovers>.
- National Aeronautics and Space Administration, NASA. (2004e), 'Letters to Home', <URL:http://www.jsc.nasa.gov/people/astronotes.html>.
- National Research council, NRC. (2004), 'Issues and opportunities of reading the US Space Program', <URL:http://www.nap.edu>.

Bibliography

- Nowak, R. (2004), 'Bear bones hint at osteoporosis treatment', <URL:<http://www.newscientist.com/news/news.jsp?id=ns99994421>>.
- Piefer, G. (2000), 'Advanced fusion for Space Application', NEEP 602 course material, College of Engineering, University of Wisconsin-Madison.
- Queijo, M. J., A. J. Butterfield, W. F. Cuddihy, C. B. King, R. W. Stone, J. R. Wrobel and P. A. Garn (1998), Subsystem Design Analyses of Rotating Advanced-Technology Space Station for the Year 2025, Technical Report NAS1-18267, The Bionetics Corporation.
- Rogers, J. H. (1995), *The Giant Planet Jupiter*, Cambridge University Press, Cambridge, United Kingdom.
- Russell, C. T. and J. G. Luhmann (1997), Jupiter Magnetic Field and Magnetosphere, in J. H. Shirley and R. W. Fainbridge, eds, 'Encyclopedia of Planetary Sciences', Chapman and Hall, USA, pp. 372-373.
- Salisbury, F. B., J. I. Gitelson and G. M. Lisovsky (1997), 'Bios-3: Siberian Experiments in Bioregenerative Life Support', *BioScience* **47**(9), 575.
- SB RAS, Institute of Biophysics. (2004), "'Bios-3M" Closed Ecological System for Life Support', <URL:<http://www-sbras.nsc.ru/sicc/cooper10.htm>>.
- Schaffer, M. J. (2000), Considerations for Steady-State FRC-Based Fusion Space Propulsion, in 'Proc. of NASA Advanced Propulsion Workshop on Fusion Propulsion, Huntsville, Alabama'.
- Schimmerling, W. (2003), 'Overview of NASA's Space Radiation Research Program', *Gravitational and Space Biology Bulletin* **16**(2), 5-10.
- Sheppard, S. (2004), 'The Jupiter Satellite Page', <URL:<http://www.ifa.hawaii.edu/~sheppard/satellites>>.
- Space Studies Board, National Research Council. (2003), *National Research Council, New Frontiers in the Solar System, an integrated exploration strategy*, National Academy Press.
- Spacelawstation (2004), 'Planetary Protection Clause', <URL:<http://www.oosa.unvienna.org/SpaceLaw/moontxt.html>>.
- Susmita, M. (1997), Design Concepts for Zero-G whole body cleansing on ISS Alpha, Isu mss individual project report, Interantional Space University.
- Tajmar, M. (2004), 'Advanced Space Propulsion', Lecture given at the Technical University of Wien.

- Trouman, P. A., K. Bethke, F. Stillwagen, D. Caldwell, R. Manvi, C. Strickland and S. A. Krizan (2003), Revolutionary Concepts for Human Outer Planetary Exploration (HOPE), in 'Space Technology and Applications International Forum - STAIF 2003: Conf. On Thermophysics in Microgravity; Commercial/Next Generation Space Exploration; Human Space Exploration; AIP Conference Proceedings', Vol. 654, pp. 821–828.
- United Nations Office for Outer Space Affairs (2004), 'Nuclear Testing', <URL: <http://www.oosa.unvienna.org/SpaceLaw/nps.html>>.
- University of California (2004), UCSF/Baylor team uses new method to measure bone loss in astronauts flying long mission. <URL:<http://www.spaceref.com/news/viewpr.html?pid=13794&from=astrowire.com>>.
- US congress Office of the Technology Assesment, US. (1991), Exploring the Moon and Mars:choices of the Nation, US Congress Technology Assesment OTA-ISC-502, US Government printing office.
- Volger, A. (2000), Micro-G Architecture - A transdisciplinary education, research and product development project for engineers and architects, in 'SAE-ASME-AIAA international Conference on Environmental Systems, Toulouse, France'.
- Wade, M. (2004), 'Encyclopedia Astronautica', <URL:<http://www.astronautix.com>>.
- Wang, A., L.A. Haskin and E. Cortez (1998), 'Prototype Raman Spectroscopic Sensor for In Situ Mineral Characterization on Planetary Surfaces', *Journal of Applied Spectroscopy* **52**(4), 477–487.
- Wiens, R. C., D. A. Cremers, J. D. Blacic, H. O. Funsten and J. E. Nordholt (1997), Stand-off planetary surface analysis using laser-induced breakdown spectroscopy and laser-induced plasma ion mass spectrometry, in 'In Situ Resource Utilization (ISRU II) Technical Interchange Meeting'.
- Wilson, J. W., J. Miller, A. Konradi and F. A. Cucinotta, eds (1997), *Shielding Strategies for Human Space Exploration (NASA Conference Publication 3360)*.
- Winglee, R., J. Slough, T. Ziemba and A. Goodson (2000), Mini-Magnetospheric Plasma Propulsion (M2P2): High Speed Propulsion Sailing the Solar Wind, in 'AIP Conference Proceedings, Volume 504', p. 962.
- Winglee, R. M., T. Ziemba, J. Slough, P. Euripides and D. Gallagher (2001), Laboratory Testing of Mini-Magnetospherici Plasma Propulsion (M2P2) prototype, in 'Space Technology and Applictions International Forum — 2001. AIP Conference Proceedings Vol. 552, Edited by Mohamed S. El-Genk, American Institute of Physics', pp. 407–412.

Bibliography

- Winglee, R. M., T. Ziemba, P. Euripides and J. Slough (2002), Radiation Shielding Produced by Mini-Magnetospheres, *in* 'Proceeding of Space Radiation Technology Workshop'.
- Wood, R. T., J. S. Neal, C. R. Brittain and J. A. Mullens (2004), Autonomous Control Capabilities for Space Reactor Power Systems, *in* 'American Institute of Physics Conference Series', pp. 631–638.