

Combustion Device Failures During Space Shuttle Main Engine Development

Otto K. Goetz
NASA

Marshall Space Flight Center (Retired)

Jan C. Monk
NASA

Marshall Space Flight Center (Retired)

5th International Symposium on Liquid Space Propulsion
Long Life Combustion Devices Technology

Chattanooga, Tennessee
October 27-30, 2003

The Beginning

The SSME Full Scale Development Program was initiated in April 1972

- First Fully Reusable Cryogenic Rocket Engine
- First US Staged Combustion Cycle Engine
- Performance Characteristics
 - Rated Power Level (RPL) (100%) - 470,000 lbf vacuum
 - Full Power Level (FPL) (109%) - 512,300 lbf vacuum
 - Throttle Range - 109% to 50% Thrust
 - Mixture Ratio - 6.0
 - Initial Mixture Ratio Range - 5.5 to 6.5
- Life - 55 Missions
- First Flight - April 1981

Space Shuttle Main Engine

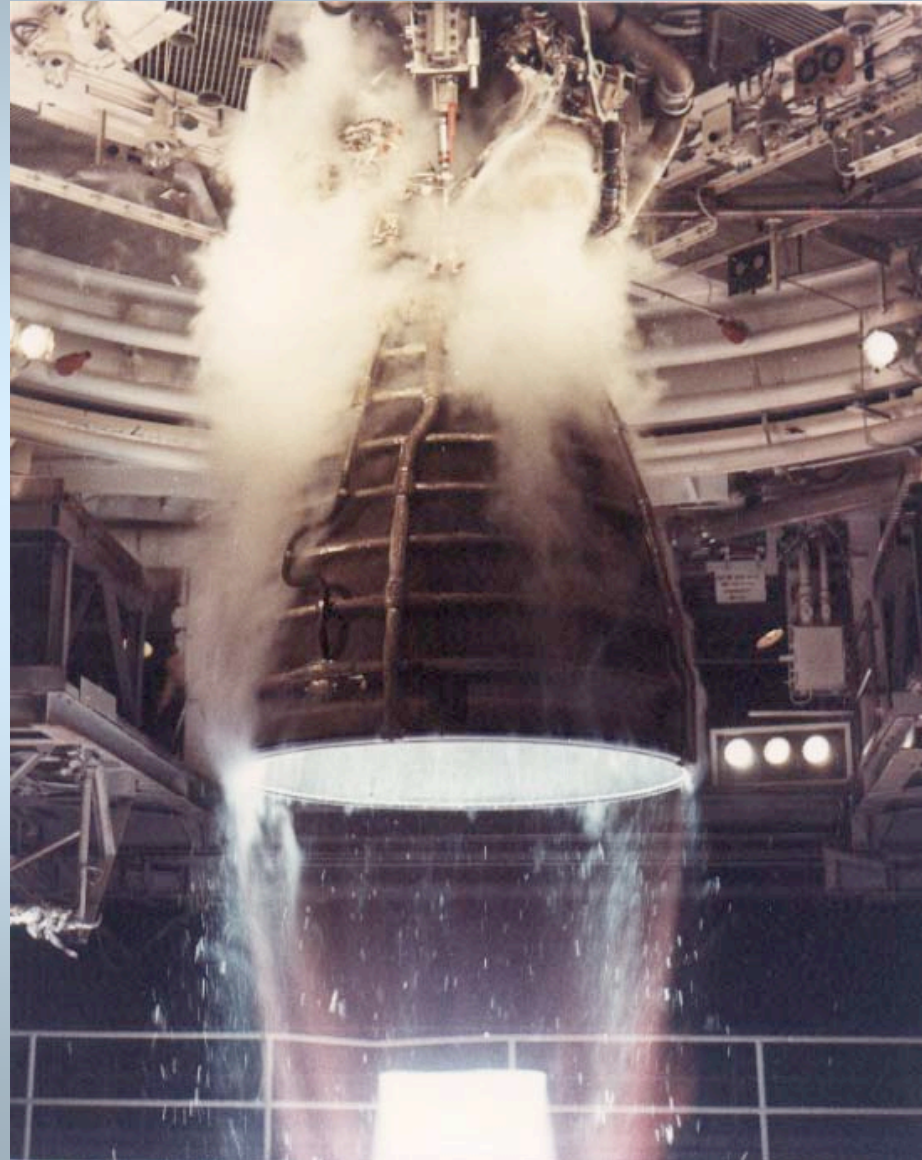

Flow Schematic

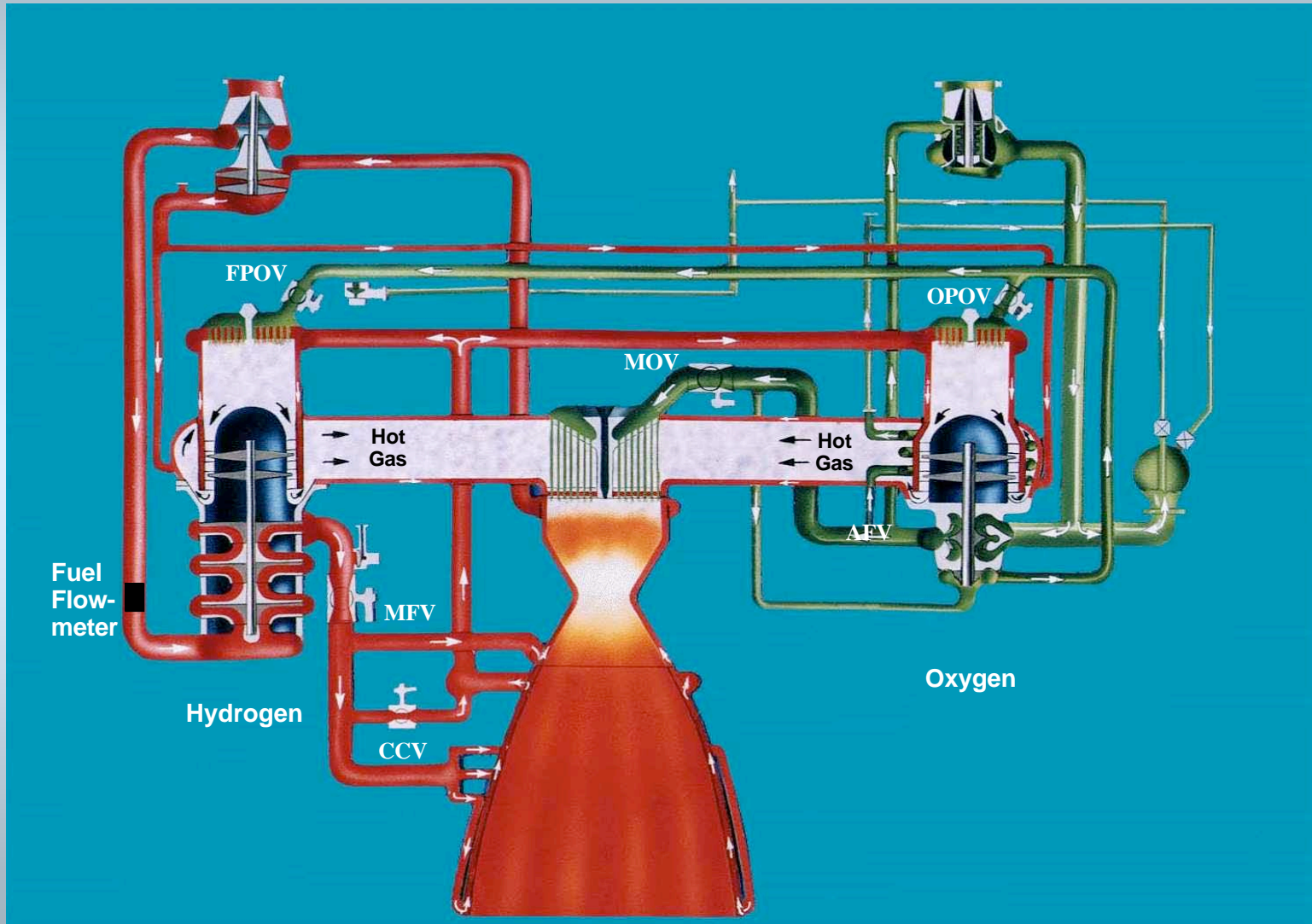

Powerhead Component Arrangement

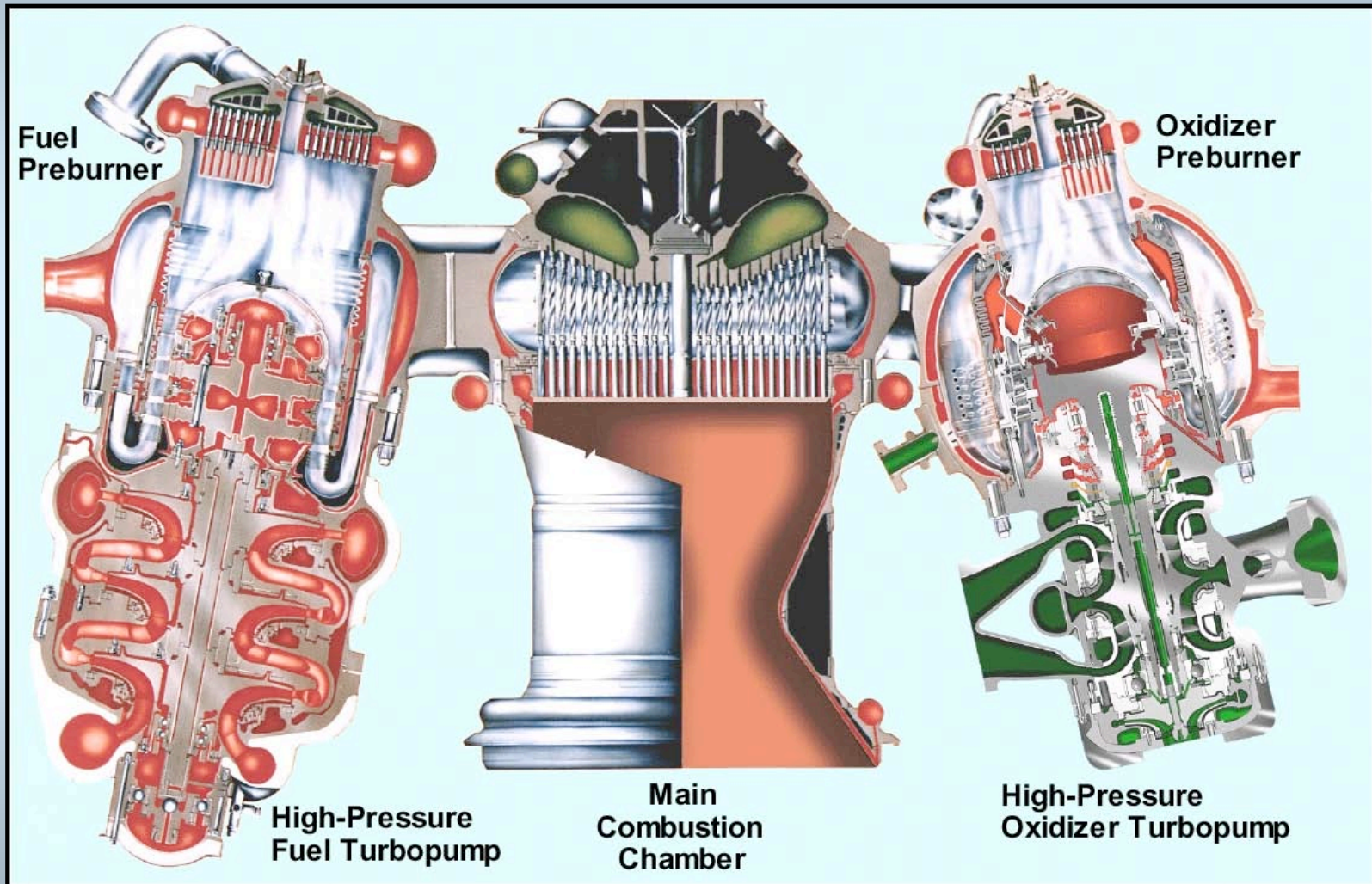

Combustion Device Major Failures

Date	Test Number	Failure	Engine S/N
August 27, 1977	901133	① Fuel PB Burnthrough	0004
March 31, 1978	901173	② Main Injector Lox Post Failure	0002
June 5, 1978	901183	③ Main Injector Lox Post Failure	0005
May 14, 1979	750041	④ Nozzle Steerhorn Failure	0201
November 4, 1979	MPTA SF06-3	⑤ Nozzle Steerhorn Failure	2002
December 6, 1978	901222	⑥ HX Failure	0007
July 12, 1980	MPTA SF10-1	⑦ FPB Burnthrough	0006
July 23, 1980	902198	⑧ Main Injector Lox Post Failure	2004
July 30, 1980	901284	⑨ MCC Lee Jet	0010
January 28, 1981	901307	⑩ FPB Lox Injector Posts	0009
July 14, 1981	902244	⑪ FPB Lox Injector Posts	0204
July 15, 1981	901331	⑫ Main Injector Lox Post Failure	2108
September 2, 1981	750148	⑬ Main Injector Lox Post Failure	0110
September 21, 1981	902249	⑭ HPFTP Blade Failure*	0204
February 12, 1982	750160	⑮ FPB Fuel Supply Blockage - Ice	0110F
February 4, 1985	901468	⑯ FPB Manifold Crack (Instr. Boss)	0207
March 27, 1985	750259	⑰ MCC Outlet Neck Blow	2308
July 1, 1987	902428	⑱ OPB Injector Braze	2106
August 27, 1997	901933	⑲ Nozzle Turbe Rupture	0524
June 6, 2000	902772	⑳ FPB Fuel Manifold Contamination	0523

* Induced by Deactivated FPB Lox Posts

Combustion Devices Major Incident Chronology

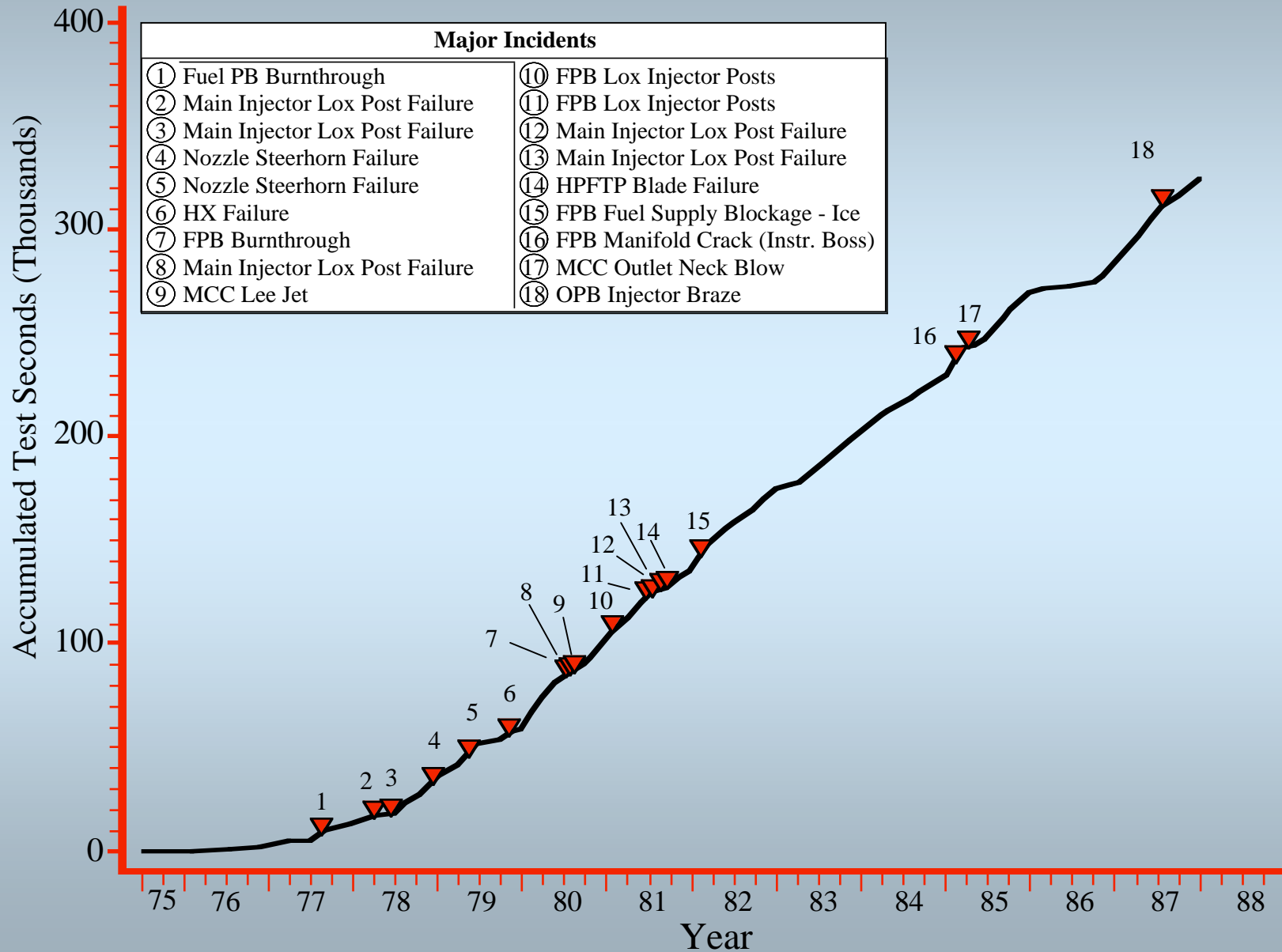

Combustion Device Failures

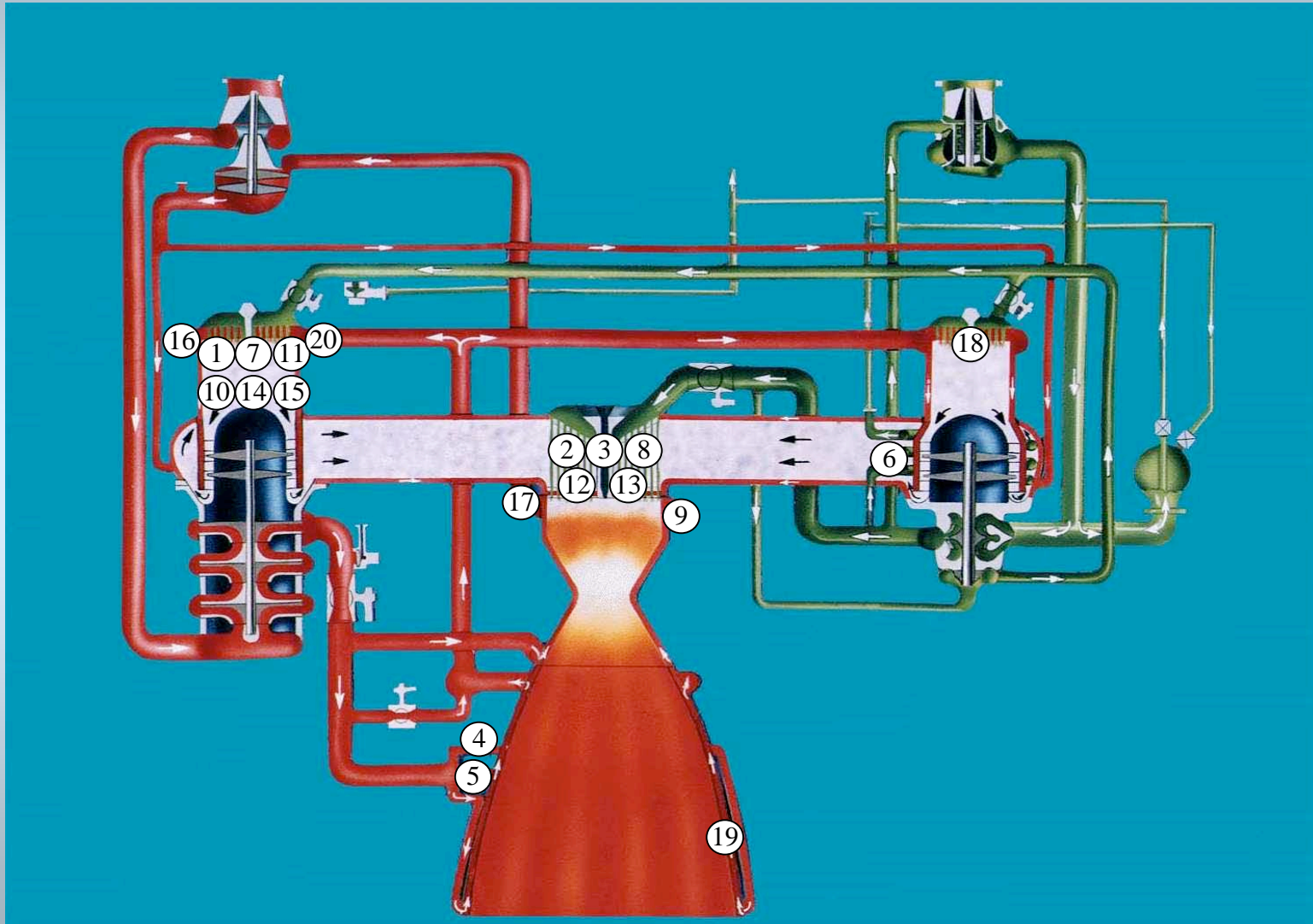

Oxidizer Preburner Failure

Engine 2106, Test 902428, July 1, 1987

Failure: Interpropellant braze joint

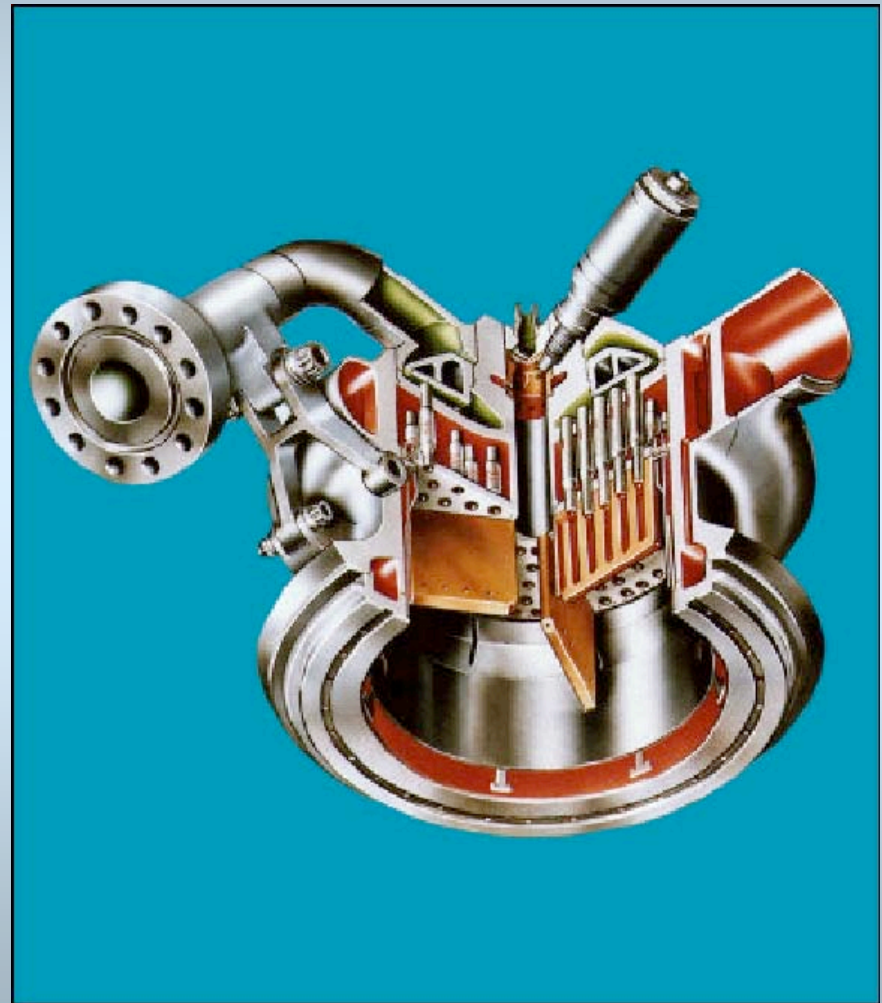

Oxidizer Preburner Failures

Engine 2106, Test 902428, July 1, 1987

Failure: Interpropellant braze joint

Incident Description: Test 902428 proceeded normally until 163 seconds when the High Pressure Oxidizer Turbopump (HPOTP) turbine discharge temperature channel A began to increase without any increase in channel B. These changes indicated a hot streak in the Oxidizer Preburner (OPB). The data showed an increasing loss of turbine power beginning at 167 seconds and continuing to 188 seconds. Subsequent to 188 seconds, the overall engine power level decreased until the fuel turbine temperature lower limit was violated at 204.12 seconds and the test was terminated.

Post test inspections revealed moderate erosion in one quadrant on the OPB faceplate and a hole through the HPOTP turbine inlet sheet metal. Leakage tests of the OPB interpropellant plate conducted on the engine revealed leak at baffle number 2, row A pin (2A).

Cause: Poor quality braze joints (greater than 90 percent porosity) at row A baffle pin to interpropellant plate joint. The large porosity was related to poor process control techniques used in the laboratory furnace. The poor quality braze joint failure was most probably due to low cycle fatigue.

Oxidizer Preburner Failures



Test 902428, Engine S/N 2106

Fuel Preburner Failures

Engine 0004, Test 901133, August 27, 1977

Failure: Fuel Preburner Body Burnthrough

Engine 0006, Test MPTA SF10-01, March 31, 1978

Failure: Fuel Preburner Body Burnthrough

Engine 0009, Test 901307, January 28, 1981

Failure: Fuel Preburner Injector Erosion

Engine 0204, Test 902244, July 14, 1981

Failure: Fuel Preburner Injector Erosion

Engine 0204, Test 902249, September 21, 1981

Failure: High Pressure Fuel Turbopump turbine blade failure

Engine 0110F, Test 750160, February 12, 1982

Failure: Fuel Preburner Fuel Supply Blockage - Ice

Engine 0207, Test 901468, February 4, 1985

Failure: Fuel Preburner Instrumentation Boss Crack

Engine 0523, Test 902772, June 6, 1997

Failure: Fuel Preburner Fuel Manifold Contamination

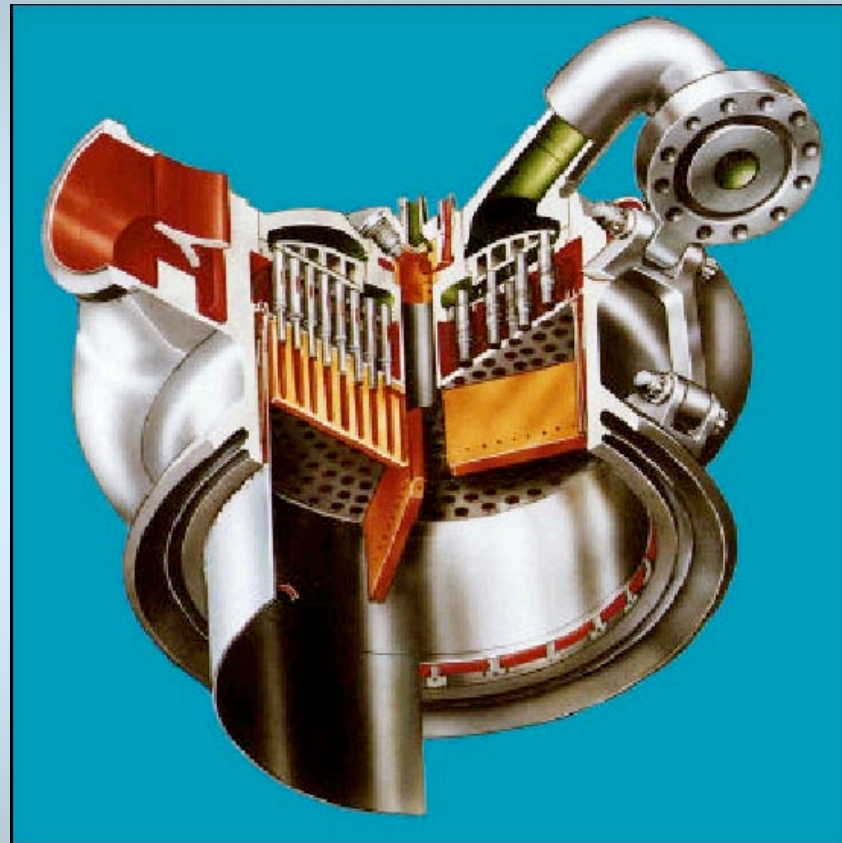

Fuel Preburner Failures

Engine 0004, Test 901133, August 27, 1977

Failure: Fuel Preburner Body Burnthrough

Incident Description: Test 901133 proceeded normally until 35 seconds when burnthrough occurred in the Fuel Preburner (FPB) body. Test was terminated by observer at 48 seconds due to external fire in the fuel preburner area.

Cause: Localized recirculation of Lox from the corner element, causing, burning of the nearby acoustic cavity, which acted as fuel to propagate the burning.

Engine 0006, Test MPTA SF10-1, July 12, 1990

Failure: Fuel Preburner Body Burnthrough

Incident Description: Test SF10-1 was prematurely terminated at 106.6 seconds when fire detectors and hazardous gas detectors triggered in the aft fuselage, and the fire detect redline observer terminated the test.

Cause: Individual element Lox posts were not concentric with the fuel annuli, causing a fuel restriction on the outboard side of the outer row elements.

Fuel Preburner Failures

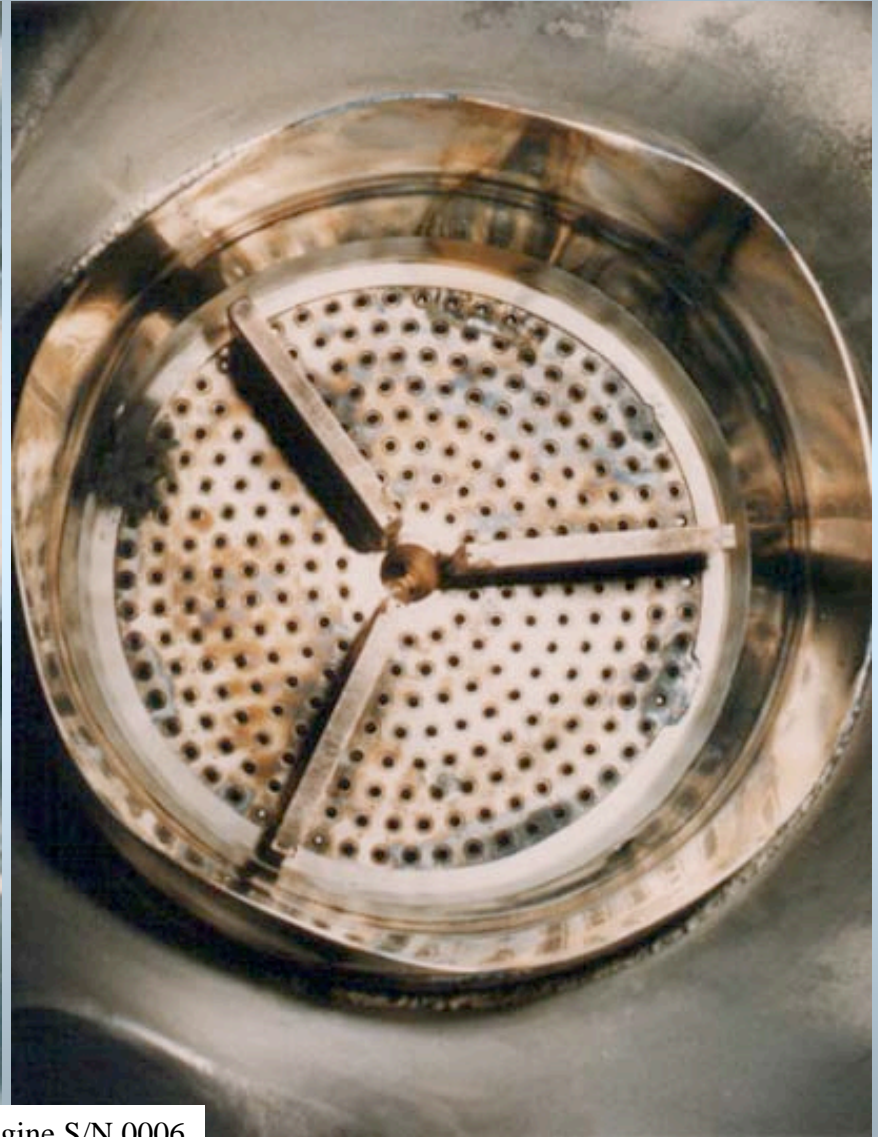

Test SF10-1, Engine S/N 0006

Fuel Preburner Failures

Engine 0009, Test 901307, January 28, 1981

Failure: Fuel Preburner Injector element erosion

Incident Description: Test 901307 proceeded through programmed shutdown. A metallurgical examination revealed a crack in one Lox post in the fuel preburner. Fuel mixes with Lox through the crack, ignites, and burns the Lox post tip. GH2 backflows into the Lox dome through the damaged element after shutdown has been initiated. The recirculating GH2 ignites with residual Lox and causes additional injector damage.

Cause: High Alternating stresses resulting from combined mainstage mechanical vibration and flow induced vibration associated with element hydrogen flow.

Fuel Preburner Failures

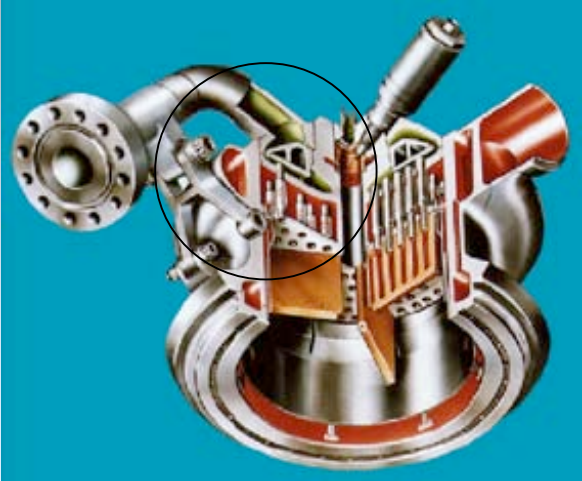

Test 901307, Engine S/N 0009

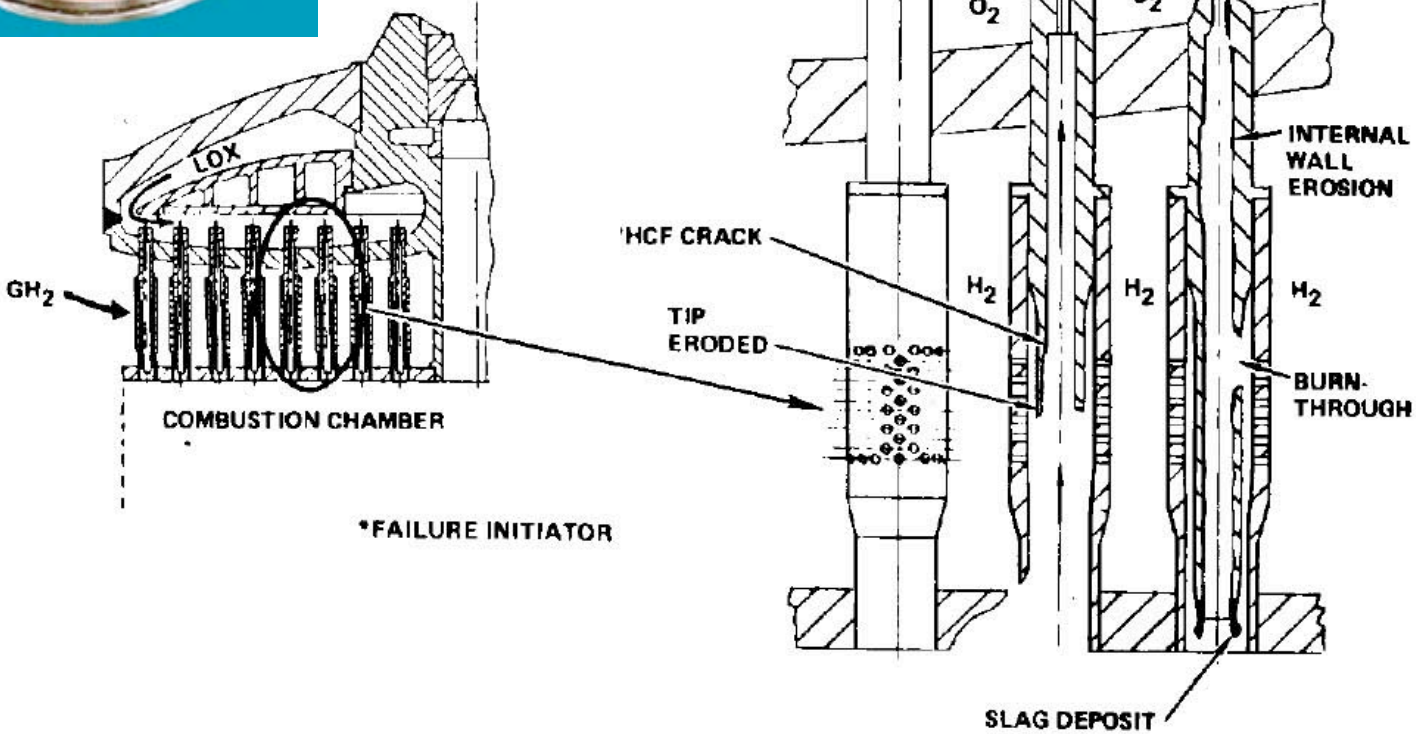

Fuel Preburner Failures

Engine 0204, Test 902244, July 14, 1981

Failure: Fuel Preburner Injector Element Erosion

Incident Description: Test 902244 proceeded through program duration. Post test inspection revealed erosion and slag deposits on inside of posts.

Cause: High cycle Fatigue (HCF) induced failure in FPB Lox post fillet radius. GH2 flows into Lox post through crack, ignites and erodes Lox post tip. Damage self limiting during mainstage operation. GH2 back flows into Lox dome through damaged element during shutdown. Recirculating GH2 ignites with residual Lox in dome causing remaining damage.

Engine 0204, Test 902249, September 21, 1981

Failure: High Pressure Fuel Turbopump (HPFTP) turbine blade failure

Incident Description: Test 902249 was terminated at 450.58 seconds when the HPFTP accelerometer measurements exceeded the redline value. Posttest inspection of the engine revealed a section of the HPFTP inlet volute missing, severe damage to the Main Combustion Chamber (MCC) and Main Injector, the nozzle, HPFTP and HPOTP turbine sections, the heat exchanger and the Hot Gas Manifold. The missing section of the HPFTP inlet volute caused the loss of all of the fuel from the engine leading to a highly oxygen rich shutdown.

Cause: FPB injector face had experienced damage during a prior test and had been repaired by plugging several oxidizer posts in one quadrant resulting in a circumferential temperature gradient in the preburner. Localized high temperature streaking caused disbonding of the first stage turbine tip seals; excessive rubbing of the blades caused blade failure, sudden rotor speed decay and resulting HPFTP inlet volute rupture and Lox rich shutdown.

Fuel Preburner Failures

**PINNED LOX POSTS –
LEGEND**

- STANDARD
- POST 902-244
- ▲ POST 902-246
- POST 902-248

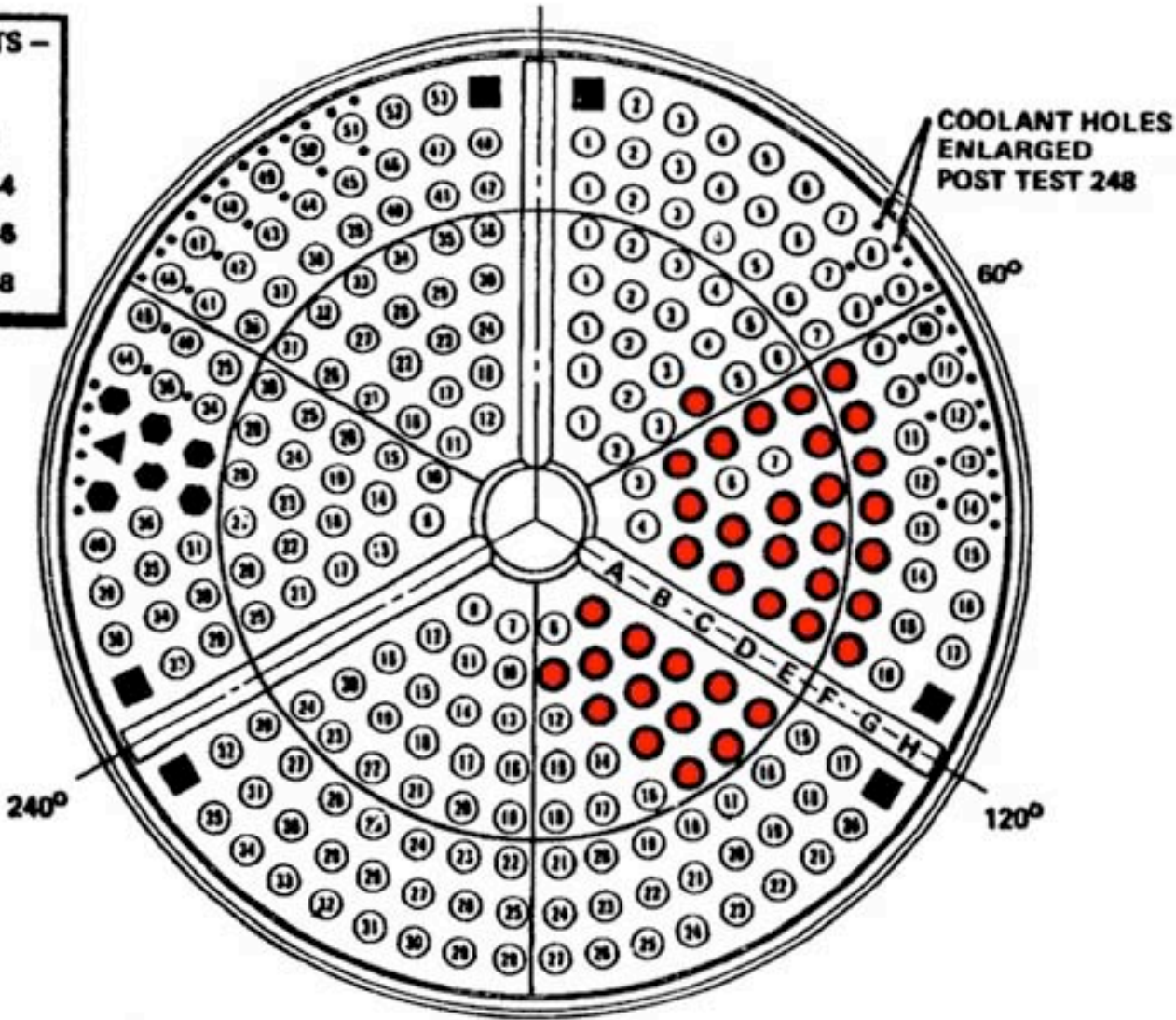

Fuel Preburner Failures



Test 902249, Engine S/N 0204

Fuel Preburner Failures



Test 902249, Engine S/N 0204

Fuel Preburner Failures

Engine 0110F, Test 750160, February 12, 1982

Failure: Fuel Preburner Fuel Supply Blockage - Ice

Incident Description: Test 750160 was prematurely terminated at 3.16 seconds by the HPFTP Turbine discharge temperature redline. Posttest hardware inspection revealed severe erosion damage to the high pressure fuel and oxidizer turbines, main injector, MCC, nozzle, and hot gas manifold. A hole burned through the left side transfer tube resulting in a rupture of the Fuel Preburner Oxidizer Valve actuator hydraulic line and an external fire.

Cause: Data analysis, hardware condition and supporting laboratory tests identified the cause of the incident as EDM water contamination of the fuel system upstream of the fuel preburner. The formation of ice during engine start resulted in fuel flow restriction in some fuel preburner elements. This restriction produced one or more abnormally high temperature combustion gas zones which cause turbine blade erosion and/or failure. The resulting decay in fuel flow to the engine produce excessive combustion gas mixture ratio and subsequent erosion damage.

The primary objective was to evaluate the turning of a combustion gas stream tube during its passage from the preburner, through the turbine and into the hot gas manifold. Ten FPB face coolant holes were enlarged to lower the local combustion gas temperature. An array of 16 thermocouples in the HGM would then be used to locate the cool zone after passage through the turbine. The EDM process used to enlarge the holes produces water into the engine. Normal drying procedures were used and required in excess of 2.5 times the typical time necessary to reach the dryness requirement.

Fuel Preburner Failures

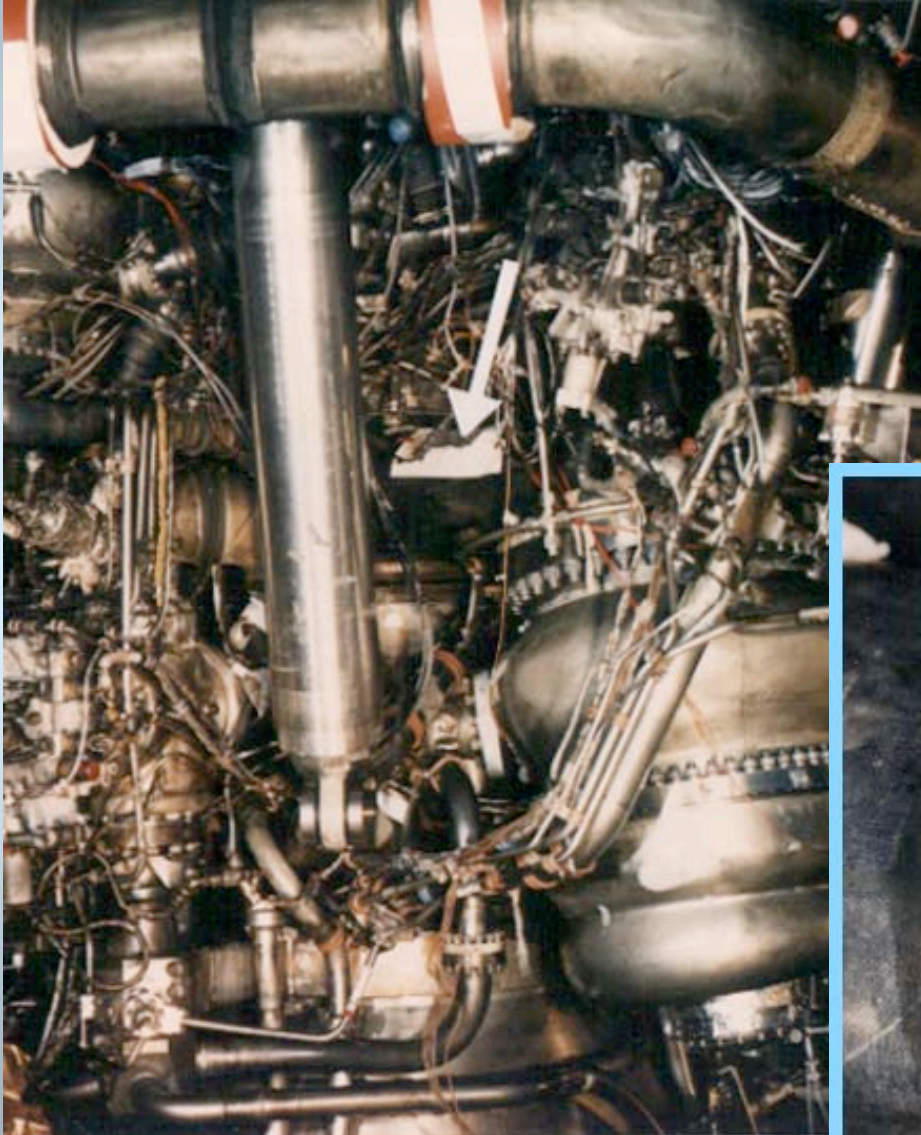

Test 750160, Engine S/N 0110F



Fuel Preburner Failures



Test 750160, Engine S/N 0110F

Fuel Preburner Failures

Engine 0207, Test 901468, February 4, 1985

Failure: FPB Instrumentation Boss Crack

Incident Description: Test 901468 was prematurely terminated at 203.86 seconds when the external powerhead temperature redline was exceeded. Visual inspection revealed a crack in the weld forward of the stub to the joint flange.

Cause: High cycle fatigue of welded in port. Not flight configuration and only power head in service with welded in instrumentation ports.

Engine 0523, Test 902772, June 6, 2000

Failure: High Pressure Fuel Turbopump (HPFTP) Turbine erosion

Incident Description: Test 902772 was prematurely terminated at 5.18 seconds when the HPFTP Turbine Discharge Temperature redline was exceeded. Posttest inspection of the engine revealed FPB liner erosion; MCC hot gas wall forward end had flame spray, slag, and numerous dings and dents; and the HPFTP turbine sustained erosion damage to the turbine housing, struts and blades.

Cause: Tape contamination was introduced into the fuel system during engine assembly. The tape entered the fuel manifold of the FPB causing localized high mixture ratio. The resulting hot streak impinged on the turbine inlet housing struts and first stage vanes. A vane segment burned through and the inner section fell into the first stage blades causing rotor imbalance and significant turbine and pump damage.

Fuel Preburner Failures

Engine Survey

Fuel Preburner Manifold

Welded Bosses

Engine S/N 0207 (One of Nine
Powerheads)

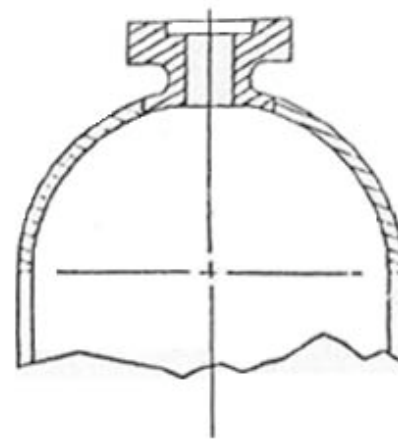

Integrally Machined Bosses

Powerhead 0007 and subs

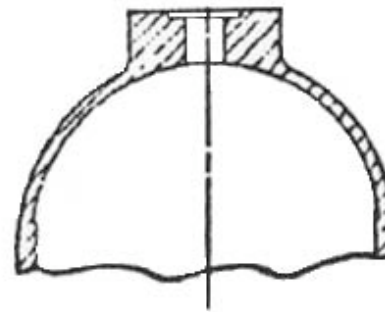

Bosses Eliminated

Powerhead 2004 and subs

All Flight Engines

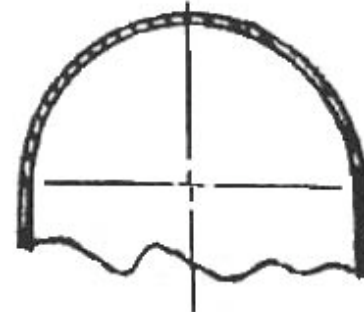

Main Injector Failures

Engine 0002, Test 901173, March 31, 1978

Failure: Lox injector post crack

Engine 0005, Test 901183, June 5, 1978

Failure: Lox injector post crack

Engine 2004 Test 902198, January 28, 1981

Failure: Lox injector post crack

Engine 0110 Test 750148, July 2, 1981

Failure: Lox injector post crack

Engine 2108 Test 901331, July 15, 1981

Failure: Lox injector post crack

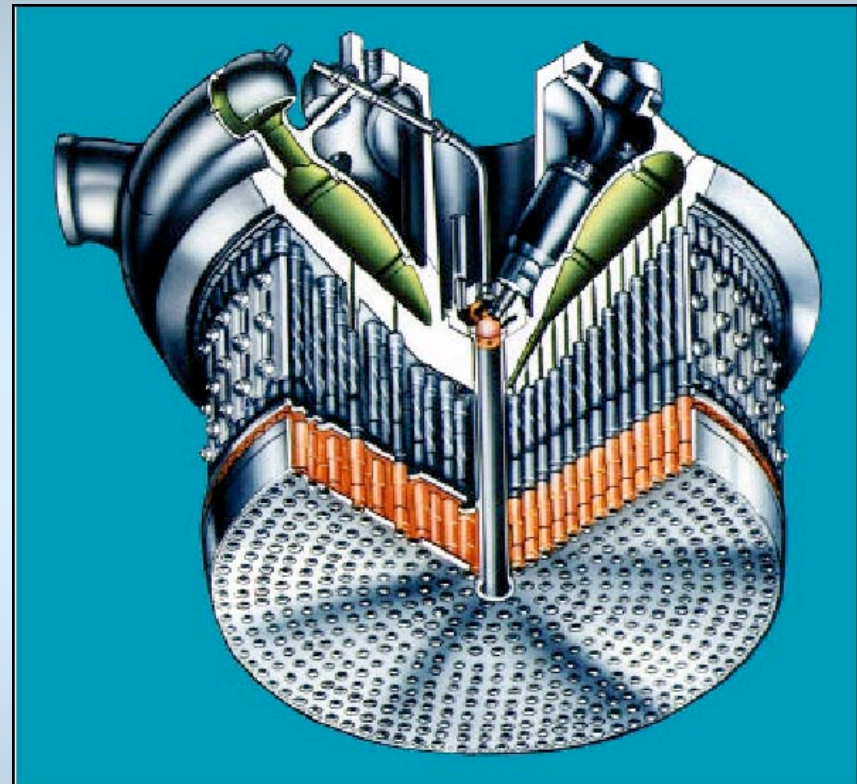

Main Injector Failures

Engine 0002, Test 901173, March 31, 1978

Failure: Lox injector post crack

Incident Description: Test 901173 was terminated at 201.17 seconds when the HPFTP turbine discharge temperature redline was exceeded. At approximately 200.7 seconds, Lox post 10, Row 13 cracked through at the tip radius between the primary and secondary faceplates. Hot gas flow into the lox post ignited and burned out the post. Lox pouring into the face coolant manifold cause burn through of primary and secondary faceplates. Ejection of burned debris caused severe nozzle tube ruptures (46 tubes). Fuel loss couple with engine control reactions to maintain MCC pressure increased the HPFTP turbine temperature to increase until the redline was exceeded.

Cause: High cycle fatigue of the Lox post due to flow and mechanical vibration.

Engine 0005, Test 901183, June 5, 1978

Failure: Lox injector post crack

Incident Description: Test 901183 was terminated at 51.1 seconds by the HPFTP accelerometers because of an unrelated problem. At approximately, 24 seconds, failure of a group of Lox posts began. The condition appears to have limited itself and engine operation stabilized. 15 Lox posts were eroded back to the secondary faceplate and a section of the primary faceplate was burn away. The MCC hot gas wall received minor scalding and the nozzle had a failed saddle patch at one location.

Cause: High cycle fatigue of the Lox post due to flow and mechanical vibration.

Main Injector Failures

Engine 2004 Test 902198, January 28, 1981

Failure: Lox injector post crack

Incident Description: Test 902198 proceeded normally until 5.5 seconds when data indicated an unscheduled decrease in MCC pressure. At this same time, other engine parameters also indicated anomalous engine behavior and that the problem was localized to the MCC injector. The engine system continued to degrade until cutoff was initiated at 8.52 seconds after the HPOTP turbine discharge temperature exceed the redline value.

Posttest hardware inspection and disassembly revealed that the MCC injector was partially damaged, the MCC had slight erosion between two acoustic cavities, and the nozzle had several tubes dented and/or ruptured from the injector debris exiting the engine. No other hardware was damaged.

Cause: The cause of the failure was high cycle fatigue of the Lox post due to flow and mechanical vibration. Metallographical examination of the disassembled injector in rows 13, 12, and 11 revealed that 62 posts were cracked. A cross section of the fillet area of post 61 in row 12 revealed longitudinal wavy lines indicative of the type of cold working accompanying HCF. Visual observation earlier in the disassembly of the injector indicated that post 61, row 12, was the failed post. Post 61 had the most uniform burning with molten metal and slag 360°. The high cycle fatigue of the Lox posts was caused by mechanical vibration of the powerhead and flow induced vibration from the hot gas combined with high steady-state stresses.

Main Injector Failures

ENGINE FAILURES IN THE THREAD AREA

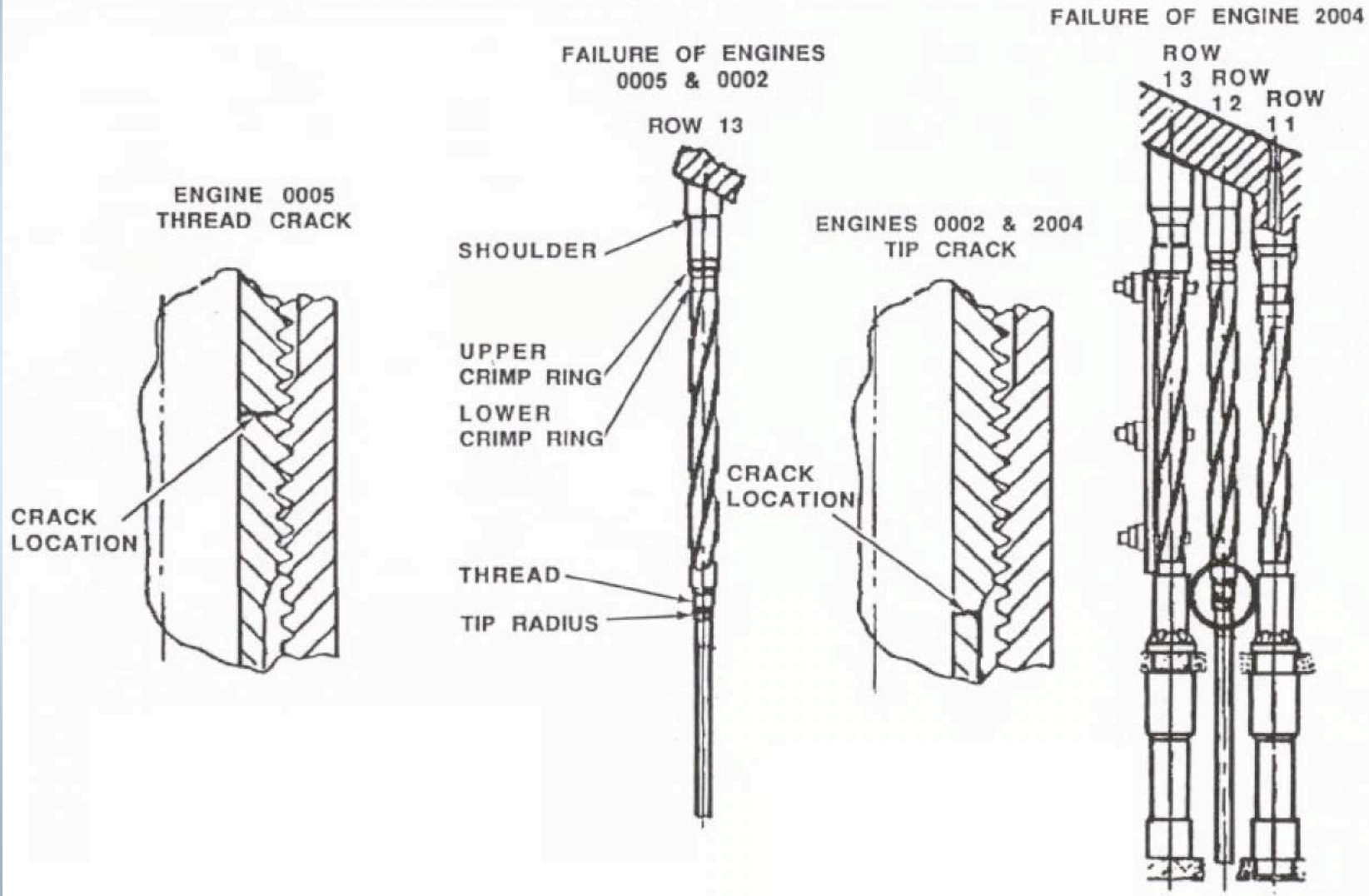

Main Injector Failures

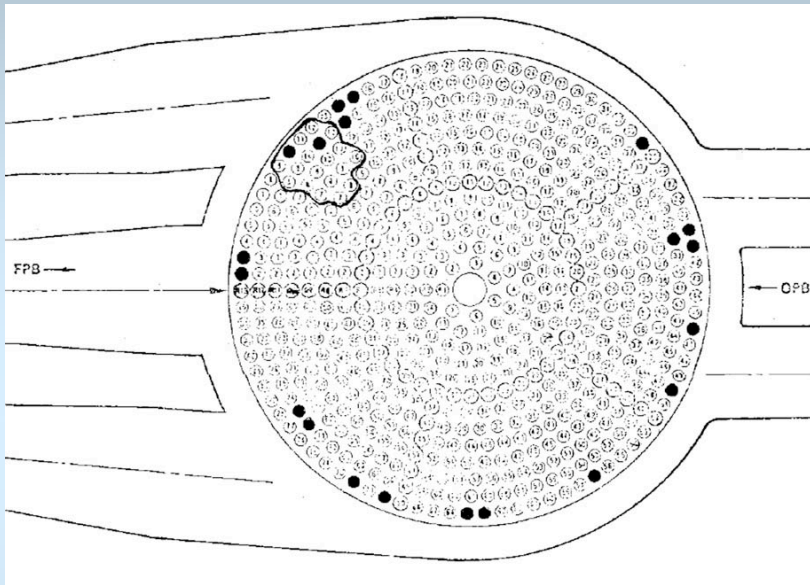

Location of Cracked Posts
and Burnout Area

Test 901173, Engine S/N 0002

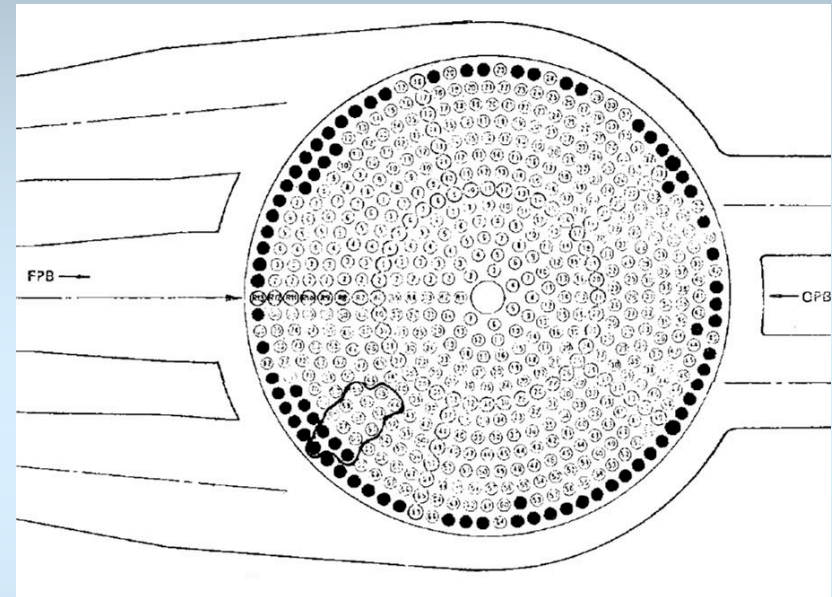

Location of Cracked Posts
and Burnout Area

Test 901183, Engine S/N 0005

Main Injector Failures

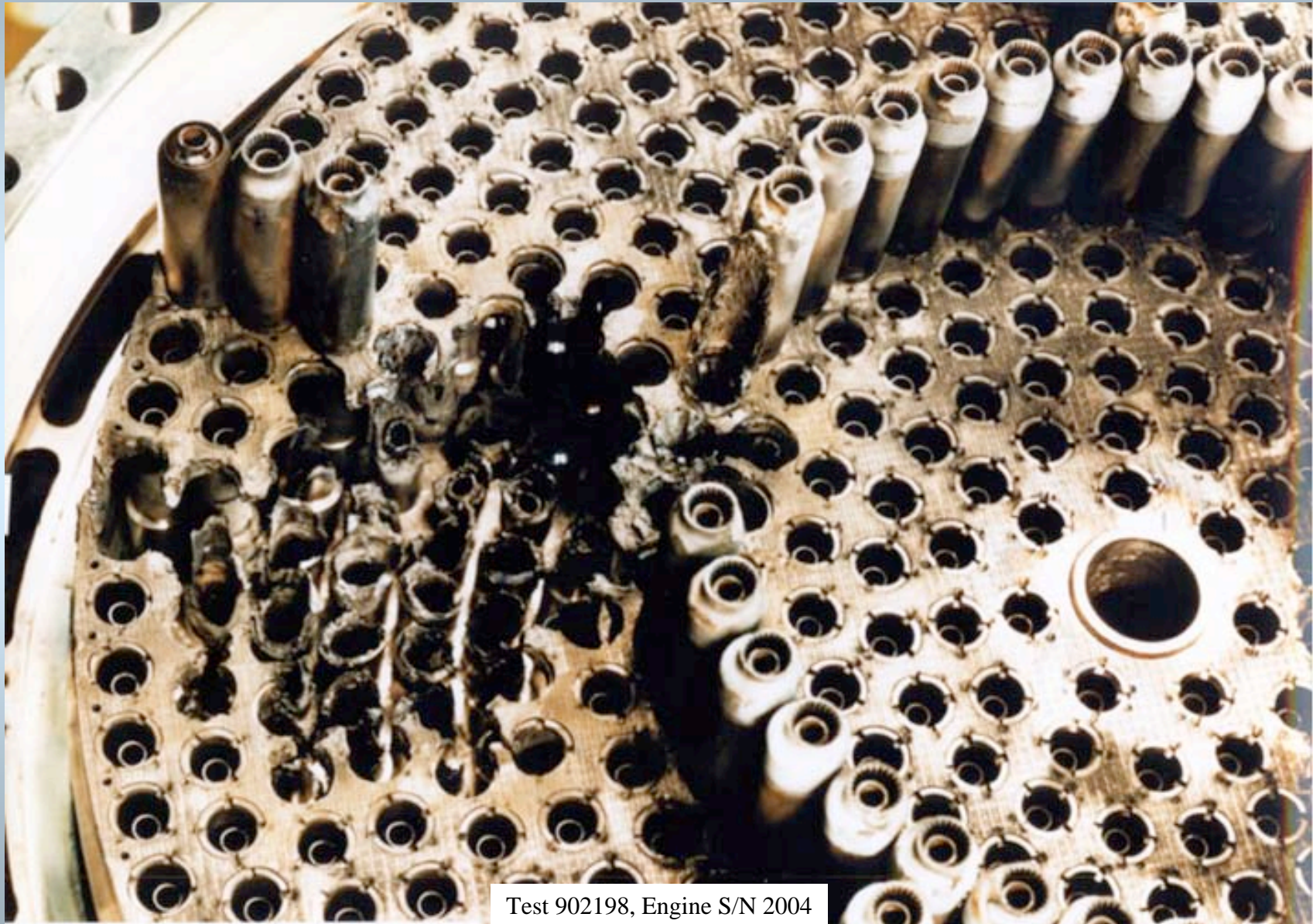

Test 902198, Engine S/N 2004

Main Injector Failures

Engine 0110 Test 750148, July 2, 1981

Failure: Lox injector post crack

Incident Description: Test 750148 proceeded normally until 16.0 seconds when the HPOTP turbine discharge temperature exceeded the redline value.

Inspection of the engine revealed extensive damage of the fuel preburner side of the main injector with burn-through of 149 Lox posts, erosion of the primary and secondary face plates, and erosion of the interpropellant plate. The nozzle sustained shrapnel damage to approximately 150 tubes and the MCC suffered erosion damage.

Cause: High cycle fatigue of Lox post caused by random mechanical vibration of the powerhead and flow induced vibration from the hot gas combined with high steady-state stresses. The damage pattern of the injector indicates the failure occurred at the inertia weld of post 12, row 13. However, the posts in this vicinity were largely consumed by the fire, including the fatigue crack where the failure initiated. Post 12, row 12, which is very near the indicated failure location, had been reworked and the acceptance requirements relaxed, making this post a credible candidate as the failure initiation point. 5. All evidence points to high cycle fatigue near a Lox post inertial weld as being the single cause.

Main Injector Failures

Engine 2108 Test 901331, July 15, 1981

Failure: Lox injector post crack

Incident Description: Test 901331 proceeded normally until 233.14 seconds when the High Pressure Oxidizer Turbopump turbine discharge temperature exceeded the redline value.

Inspection of the engine revealed extensive damage on the fuel preburner side of the main injector with burnthrough of 169 Lox posts, major erosion of the primary and secondary faceplates, major erosion of the interpropellant plate, and six Lox post shields damaged. The nozzle sustained shrapnel damage to approximately 60 tubes, and the MCC acoustic cavity suffered erosion damage.

Cause: Lox post number 79 in row 13 failed in the 316L material at the inertial weld (which joins a 316L post to an INC0718 interpropellant plate stub) . The post failure was caused by high cycle fatigue. There was a much larger increase in flow induced vibration in going from RPL to FPL; than had been estimated in life calculations. Furthermore, the modifications which had been made in the high pressure fuel pump to adapt it to FPL operation increased the severity of the flow induced vibrations at all power levels.

Main Injector Failures

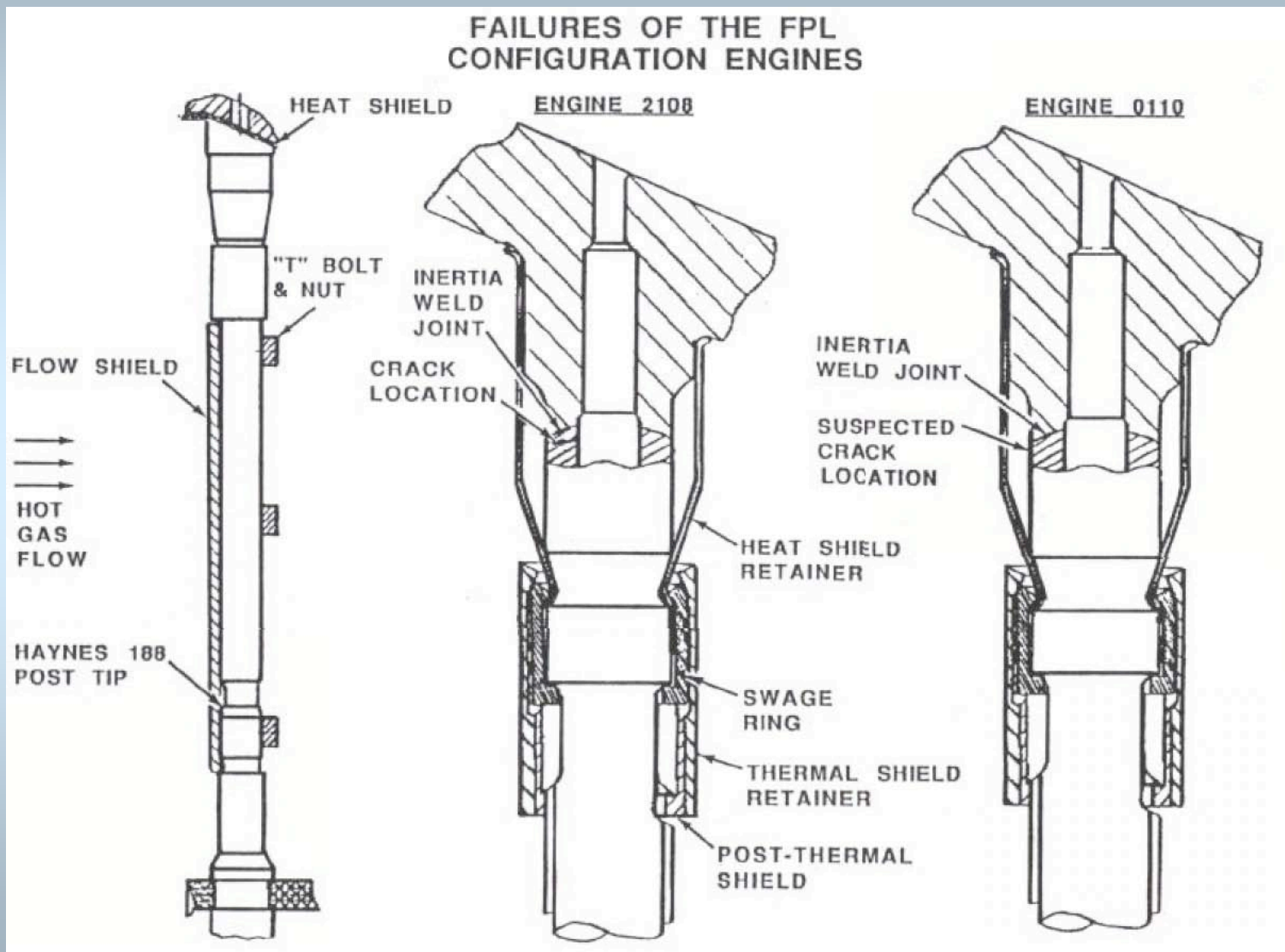

Main Injector Failures



Test 901331 Engine S/N 2108

Main Injector Failures

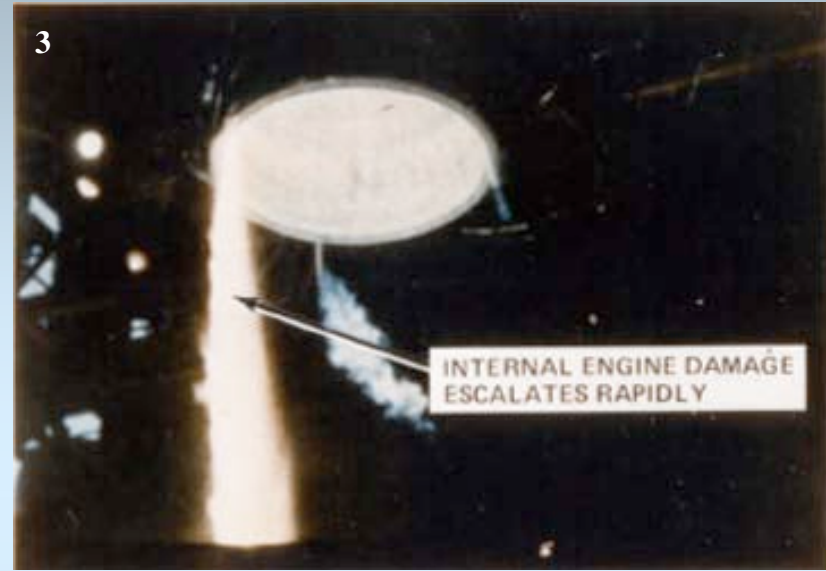
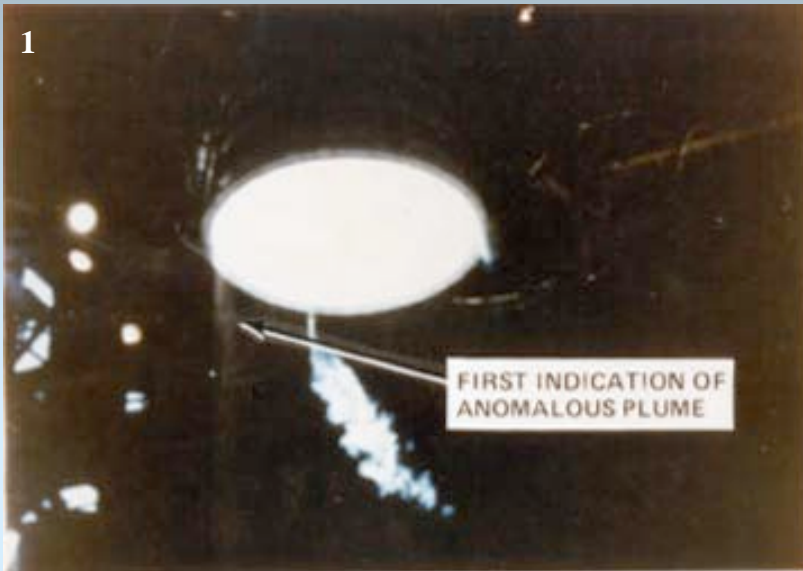

Main Injector Failures

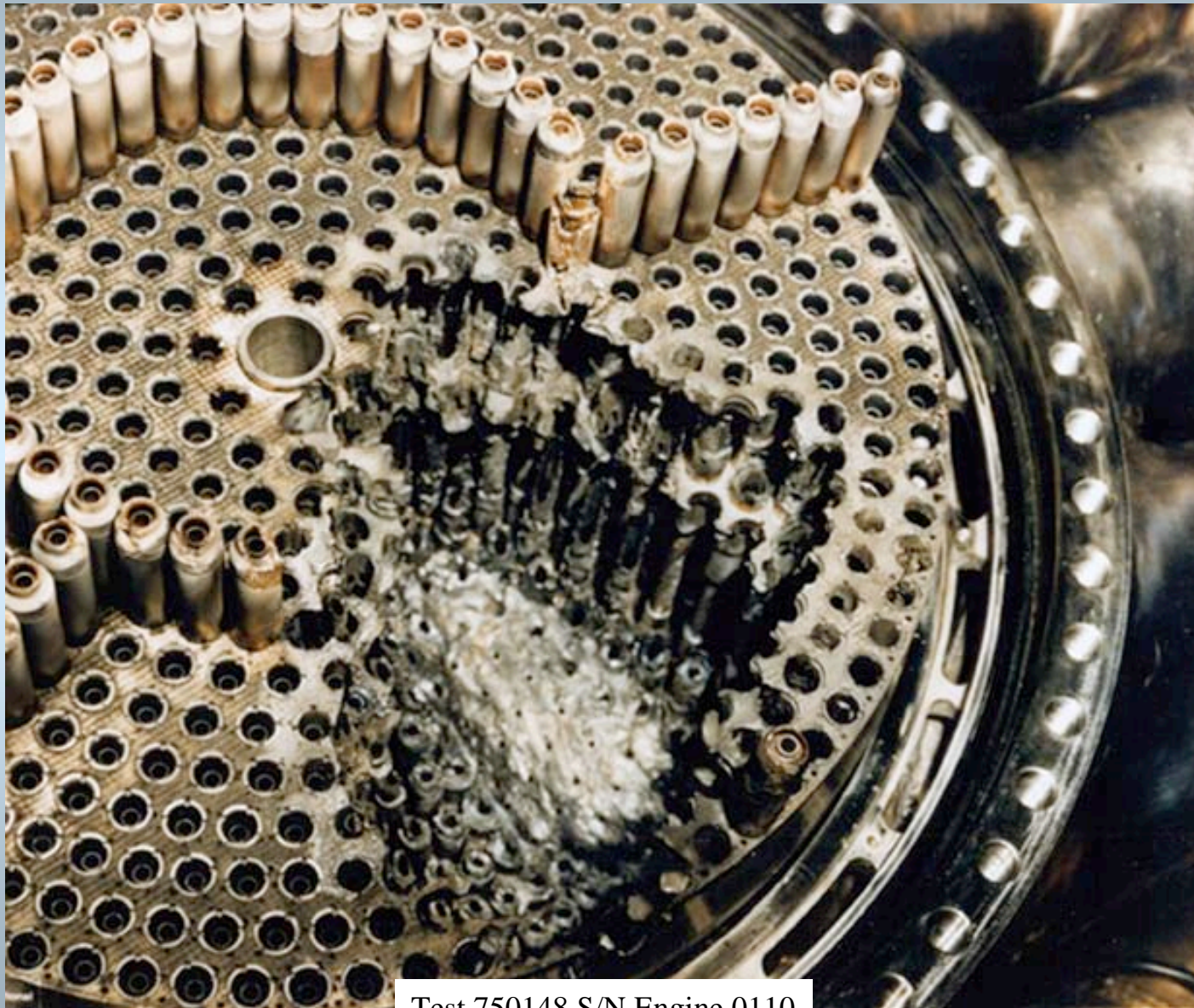

Test 750148 S/N Engine 0110

Nozzle Failures

Engine 0201, Test 750041, May 14, 1979

Failure: Fuel feed duct (Steerhorn) rupture

Engine 2002, Test MPTA SF06-03, November 4, 1979

Failure: Fuel feed duct (Steerhorn) rupture

Engine 0524, Test 902933, August 27, 1997

Failure: Nozzle coolant tube rupture



Nozzle Failures

Engine 0201, Test 750041, May 14, 1979

Failure: Fuel feed duct (Steerhorn) rupture

Incident Description: Test 750041 was automatically terminated at 4.296 seconds when the HPFTP turbine discharge temperature exceeded the redline value. The engine sustained considerable damage internally due to the loss of hydrogen flow during shutdown. Review of the motion picture film and data evaluation indicates that there were actually two incidents in this test. The first incident was the hot start which resulted in an high initial temperature spike in the high pressure fuel turbopump turbine discharge temperature. When the engine reached steady state the temperature again exceeded the redline value and shutdown was initiated. The second incident was the failure of the hydrogen feed line (steerhorn) to the nozzle. This occurred as the engine preceded through shutdown. This caused loss of hydrogen to the engine and the resulting damage. Damaged hardware included extensive overheating and erosion of both HPFTP and HPOTP turbines, extensive overheating and massive tube ruptures in the nozzle, extensive erosion of the main injector (not repairable), extensive slag deposited on the MCC, erosion of the fuel preburner liner and body, and extensive erosion of the hot gas manifold liner (fuel side).

Cause: A small crack was found in the failed steerhorn which was the initiation point of the failure. Metallurgical analysis of the failed area indicated that all of the damage may have been accumulated in this one test. Engineering analysis of this test however, could not identify any loads high enough to fail the steerhorn in this one test. It was postulated that the steerhorn could have accumulated damage from previous testing without cracking. Strain gages were place on engines being hot fired and previously unidentified 200-400 Hz oscillations were found during the start and shutdown transients. The loads from these oscillations had not been included in the design of the steerhorn. Utilizing data obtained with strain gages from eleven tests gives a projected life of 44 tests for minimum fatigue properties. The nozzle from engine 0201 had accumulated 12,109 seconds of test time during 48 tests.

Nozzle Failures

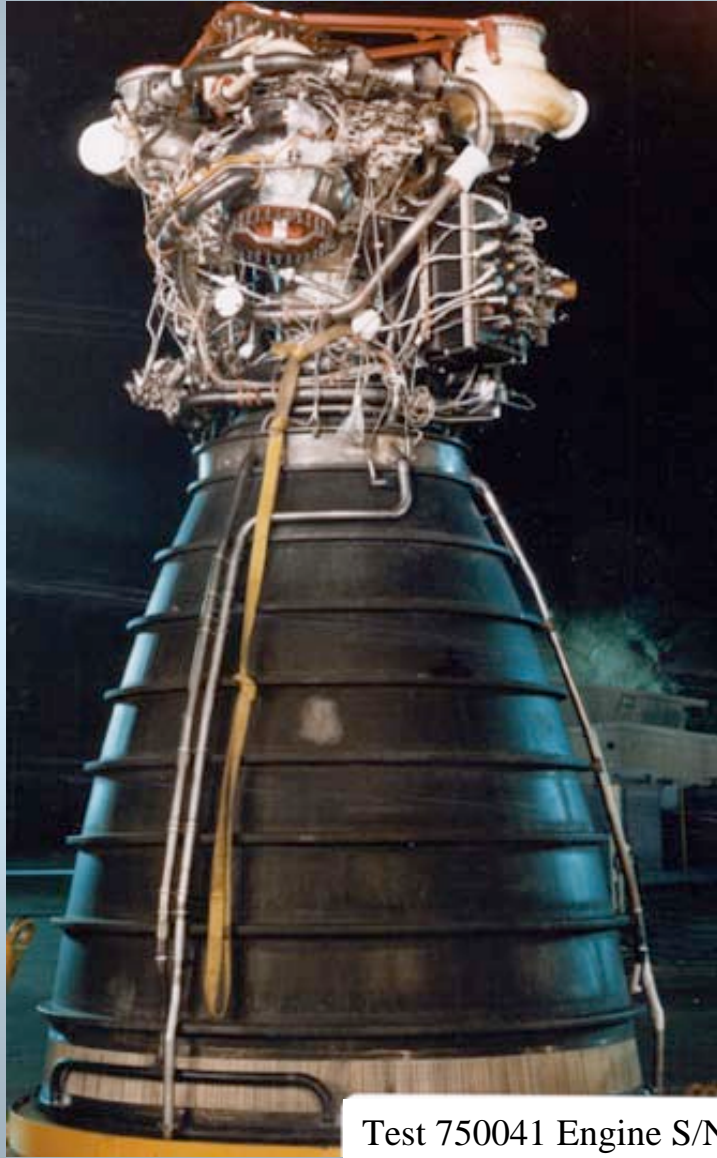

Test 750041 Engine S/N 0201

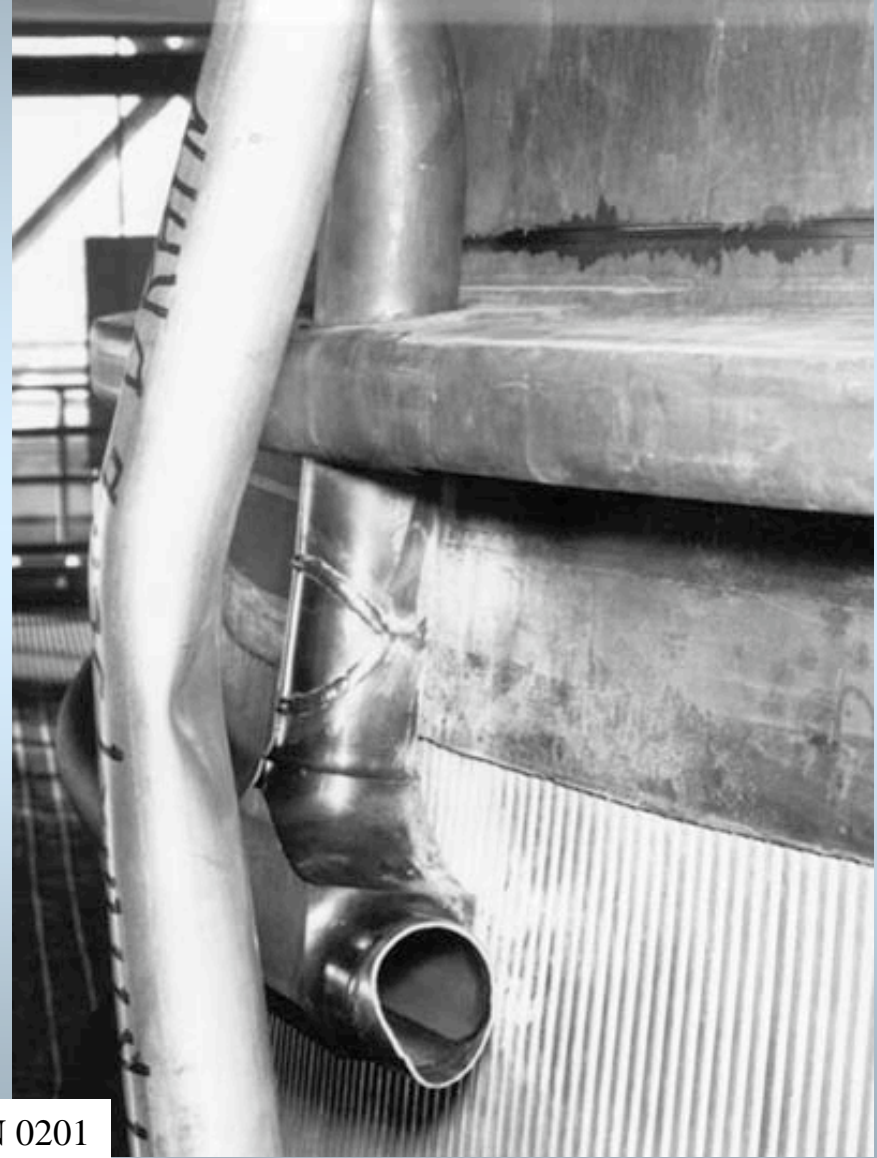

Nozzle Failures



Test 750041 Engine S/N 0201

Nozzle Failures

Engine 2002, Test MPTA SF6-03, November 4, 1979

Failure: Fuel feed duct (Steerhorn) rupture

Incident Description: Test SF6-03 was automatically terminated at simulated liftoff (To plus 4.848 seconds when the HPOTP secondary seal cavity pressure on Engine Position 3 (Engine S/N 0006 exceeded the maximum redline value. During the shutdown sequence, the nozzle steerhorn on Engine Position 1 (Engine S/N 2002) failed. The resulting loss of fuel following the failure caused extensive internal damage due to overheating. Damaged hardware included extensive overheating and erosion of both HPFTP and HPOTP turbines, extensive overheating and massive tube ruptures in the nozzle, extensive erosion of the main injector (not repairable), extensive erosion of the MCC (not repairable), and extensive erosion of the Hot Gas Manifold liner (fuel side).

Cause: The steerhorn failure occurred during the period of maximum nozzle deflections due to exhaust plume separation; however, the data obtained from strain gage measurements located on the steerhorn were below the levels necessary to fail the steerhorn. Subsequent investigations revealed that improper weld rod material was utilized in the fabrication of the steerhorn which significantly reduced the load carrying capability of the assembly.

Nozzle Failures



Camera Time: 10:29:31.425



Camera Time: 10:29:31.430



Camera Time: 10:29:31.435



Camera Time: 10:29:31.440



Camera Time: 10:29:31.445

Test SF6-3, Engine S/N 2002

Nozzle Failures



Test SF6-3, Engine S/N 2002

Nozzle Failures

Engine 0524, Test 901933, August 27, 1997

Failure: Nozzle Coolant Tube Rupture

Incident Description: Test 901933 was terminated at 567.96 seconds when the HPFTP turbine discharge temperature and the MCC Chamber pressure versus Pc Reference delta exceeded redline values. Posttest inspection revealed extensive damage to the HPFTP turbine, severe erosion to the Main Injector, the MCC and the nozzle hot wall. The damage resulted from the Lox-rich conditions in the engine following the nozzle rupture.

Cause: The cause of the nozzle tube rupture was an external overpressurization of these tubes due to cold wall tube leakage of hydrogen into the tube/jacket interface. This overpressurization resulted from the inability to vent an increasing amount of cold wall leakage due to fatigue crack initiation and propagation in these tubes. The cold wall leakage was the result of tube-to-jacket braze discontinuities in an area of the nozzle that experiences steady-state and transient loading. Because of the transient loading, circumferential low cycle fatigue cracks were initiated above the aft edge of the nozzle jacket.

Oxygen Heat Exchange Failure

Engine 0007, Test 901222, December 6, 1979
Failure: HEX coil leakage

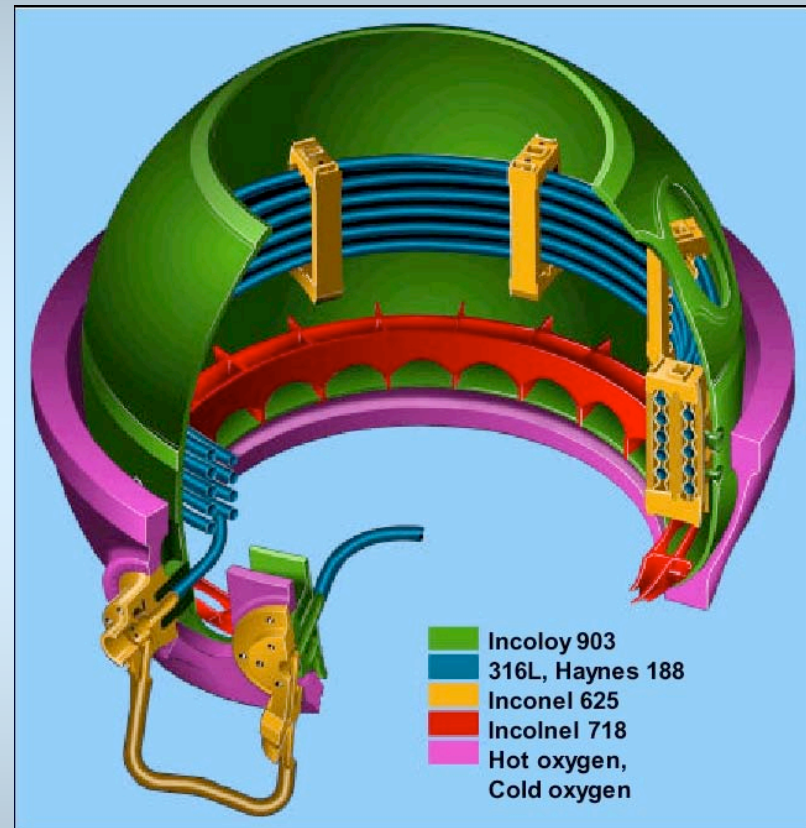

Oxygen Heat Exchanger Failure

Engine 0007, Test 901222, December 6, 1979

Failure: HEX coil leakage

Incident Description: Test 901222 was terminated at 4.34 seconds by the heat exchanger outlet pressure minimum redline. Simultaneously, external fire was observed in the area of the oxidizer preburner. Extensive occurred to the heat exchanger coil, oxidizer turbine discharge area gas manifold, main injector and heat exchanger discharge line.

Cause: It was concluded that the incident could have been caused by one of two possible failure modes. One possible cause is undetected damage to the inlet tube during failure modes. One possible cause is undetected damage to the inlet tube during manufacturing. Following welding of the inlet, the small diameter inlet passage is reamed to remove weld drop-through. If the reaming operation penetrates past the planned depth or is performed off center, extensive damage may occur to the internal surface of the coil. The key supporting rationale for this failure mode is evidence of reaming penetration. Another possible cause is associated with a heat exchanger bracket welding operation. The No. 1 bracket was weld-repaired near the outlet, in the general area where the failure apparently originated. The exchanger bracket welding operation was conducted after the final proof pressure test. The grounding method -- to the bowl rather than directly to the bracket -- may have caused high frequency current arcing between bracket and tubing, damaging the tubing.

Heat Exchanger Failure



Test 901222, Engine S/N 0007

Main Combustion Chamber Failures

Engine 0010, Test 901284, July 30, 1980

Failure: Lee Jet failure

Engine 2308, Test 750259, March 27, 1985

Failure: Failure: Outlet neck rupture



Main Combustion Chamber Failures

Engine 0010, Test 901284, July 30, 1980

Failure: Lee Jet failure

Incident Description: Test 901284 was prematurely terminated at 9.82 seconds when pneumatic shutdown was initiated due to loss of the engine controller.

An erroneously high reading combustion chamber pressure caused the Controller to close the Oxidizer Preburner Oxidizer Valve to reduce Pc to the desired value. A few milliseconds later, the Controller calculated a mixture ratio of 9.0 and commanded the Fuel Preburner Oxidizer Valve full open in an attempt to reduce the MR to 6.0. The immediate result of the Controller actions, based on an erroneous Pc, was operation in an abnormal mode, characterized by high fuel flow and low turbine temperature. The HPOTP turbine inlet temperature fell below a value which led to freezing of water in the turbine gases. The ultimate result of the Controller actions was a fire in the HPOTP at about 9.7 seconds due to rubbing in the area of the Lox primary seal. The rubbing was caused by a high axial load which displaced the rotor assembly toward the pump end of the HPOTP housing.

Cause: Two unrelated events caused this failure to prorogate to a catastrophic failure. First, Channel B of the Engine Controller cut itself off at 3.25 seconds because of failure of electronic components in the facility power supply. Secondly, at 3.9 seconds, the Lee Jet orifice, used to purge the Channel A Pc transducer passage, became dislodged and caused the Pc transducer to sense MCC coolant flow pressure instead of Pc. The reason for the Lee Jet orifice dislodging was a poorly machined Lee Jet housing that went undetected. It was out of specification and should have been noted.

Main Combustion Chamber Failures

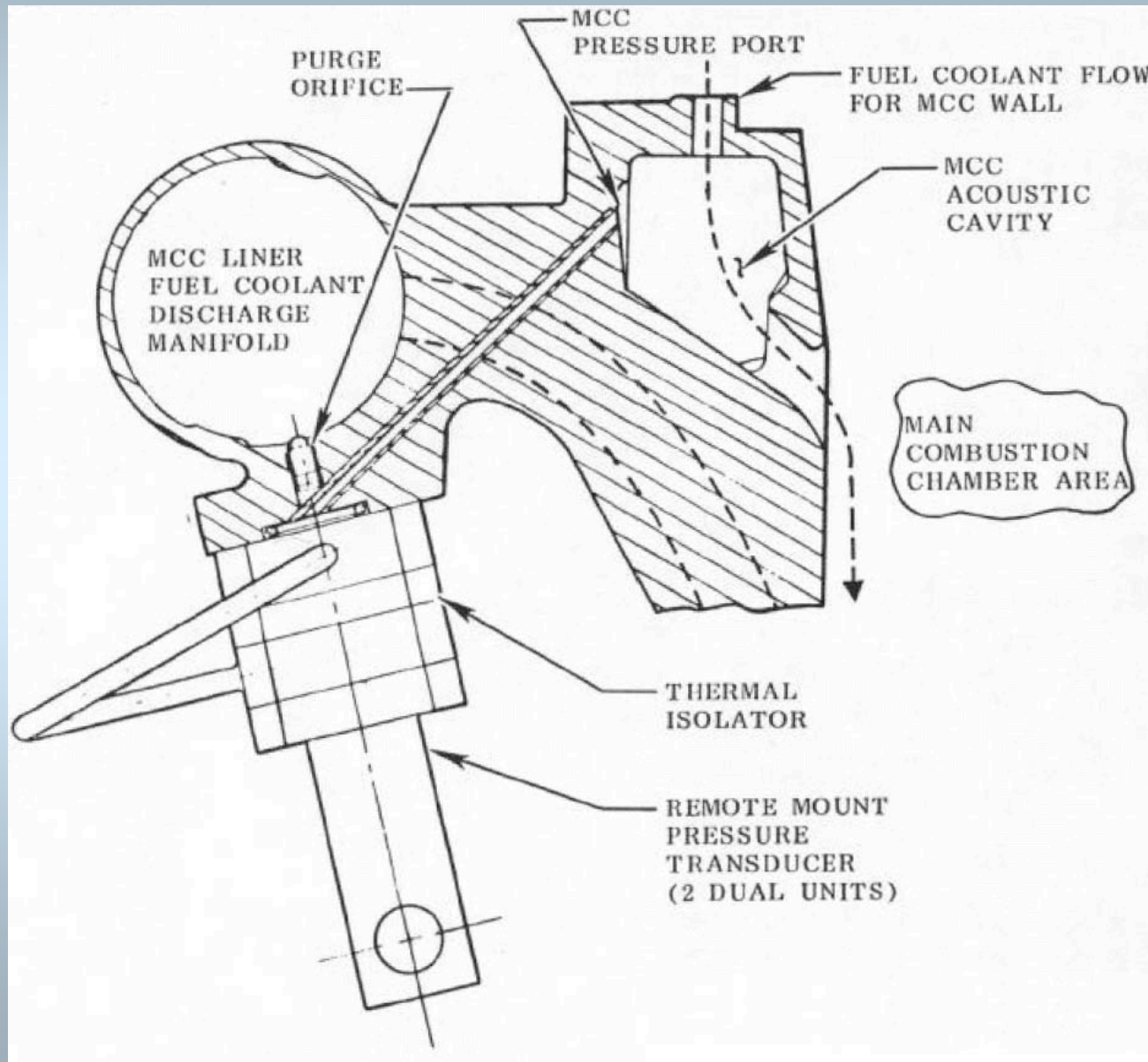

Main Combustion Chamber Failures

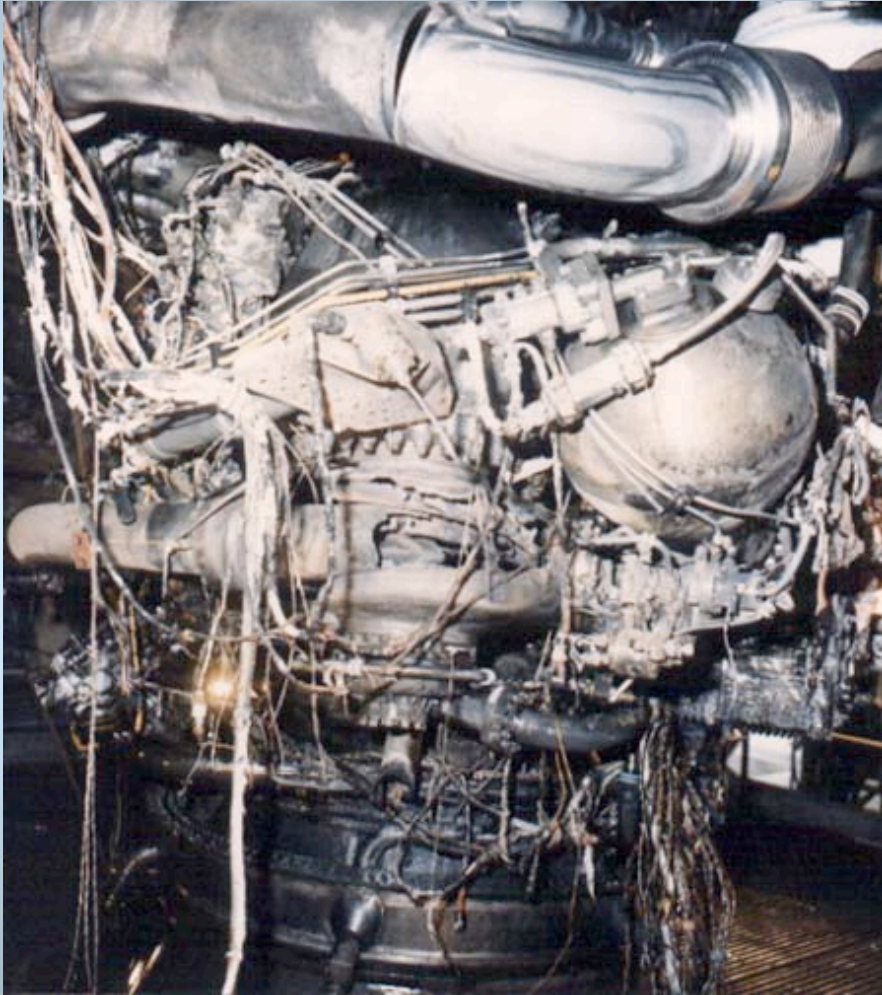

Test 901284, Engine S/N 0010

Main Combustion Chamber Failures

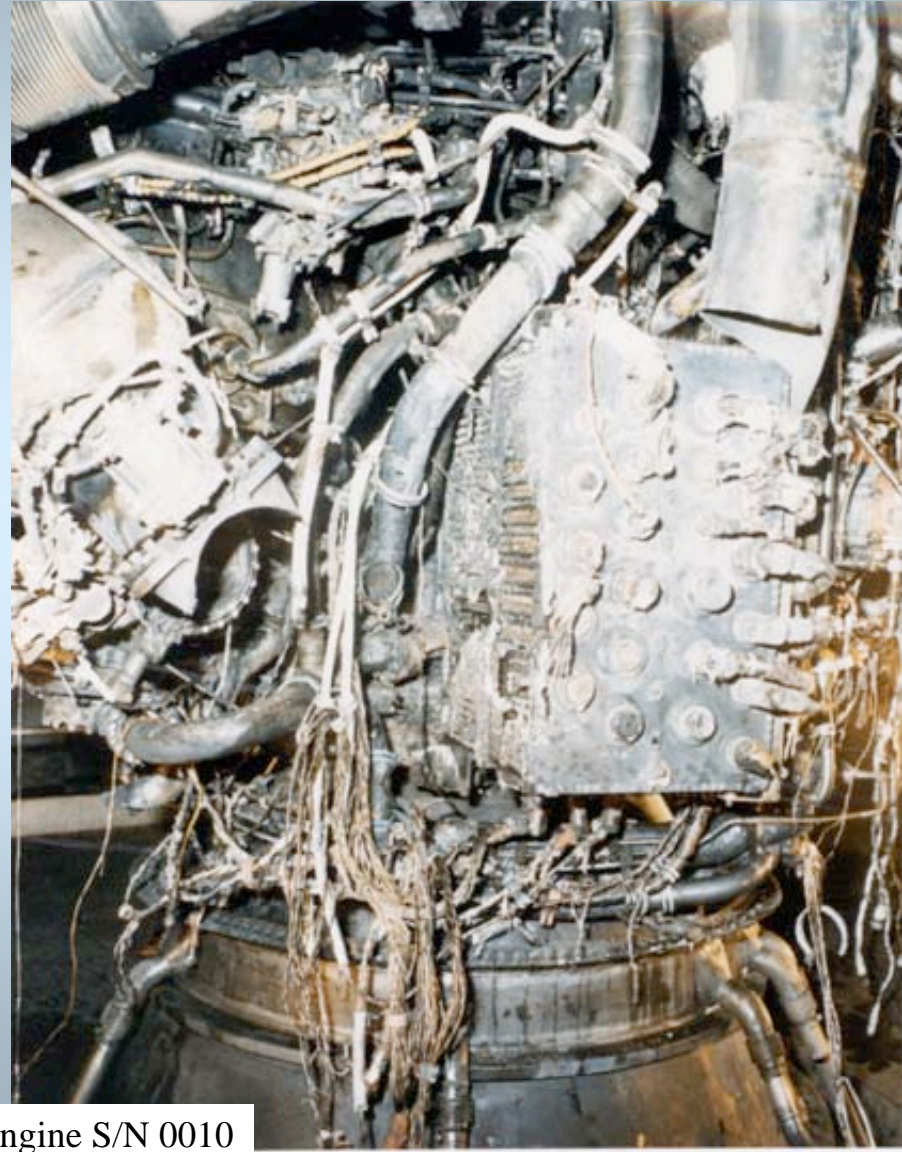

Test 901284, Engine S/N 0010

Main Combustion Chamber Failures

Engine 2308, Test 750259, March 27, 1985

Failure: MCC Coolant Outlet Manifold neck rupture

Incident Description: Test 750259 was prematurely terminated at 101.5 seconds by the HPFTP accelerometer redline. In the incident, the engine was severed from the test stand as a result of an oxygen rich fire and came to rest in the stand spillway.

Catastrophic failure of Engine 2308 was caused by rupture of the MCC outlet manifold neck which resulted from an initial fatigue crack that grew to instability. In response to the rupture, the low-pressure fuel turbopump rapidly decayed in speed, further indicating the source of the leak to be in the MCC outlet system. The speed drop rapidly reduced discharge pressure (inlet pressure to the high-pressure pump) and the high-pressure fuel pump went into deep cavitation. As a result of deep cavitation, the high-pressure fuel pump speed increased to a value 30% over FPL nominal, rapidly increased pump vibration which exceeded the vibration redline, and led to a cutoff command. Following cutoff, the fuel cavitation condition resulted in reduce engine fuel flow and a severe oxygen-rich condition. Burnout of the turbines, burn-through of the hot-gas manifold and severe erosion of the gimbal bearing produced conditions leading to separation of the engine below the low-pressure pumps.

Cause: The precise origin and initiation mechanism for the failure was not established. Fatigue or an undetected defect were both postulated as potential failure modes for welds No. 1, 2, or 11 of the MCC outlet neck. The most probable cause of failure was determined to be fatigue (endurance) crack initiation at splitter welds No. 1 or 2.

Main Combustion Chamber Failures

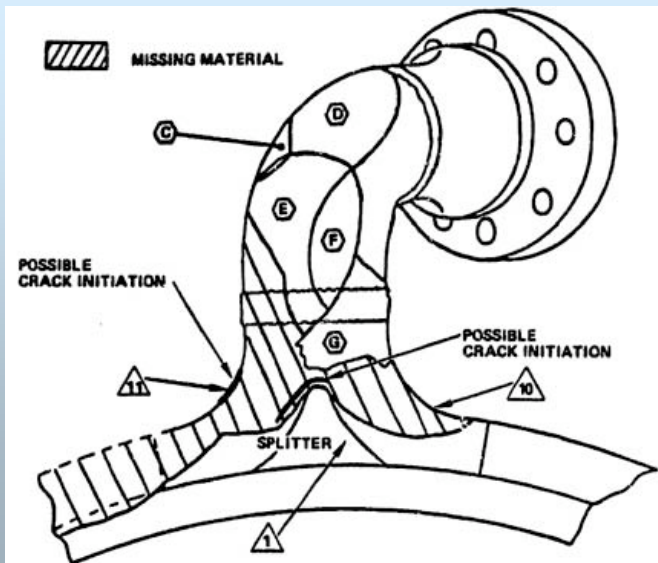
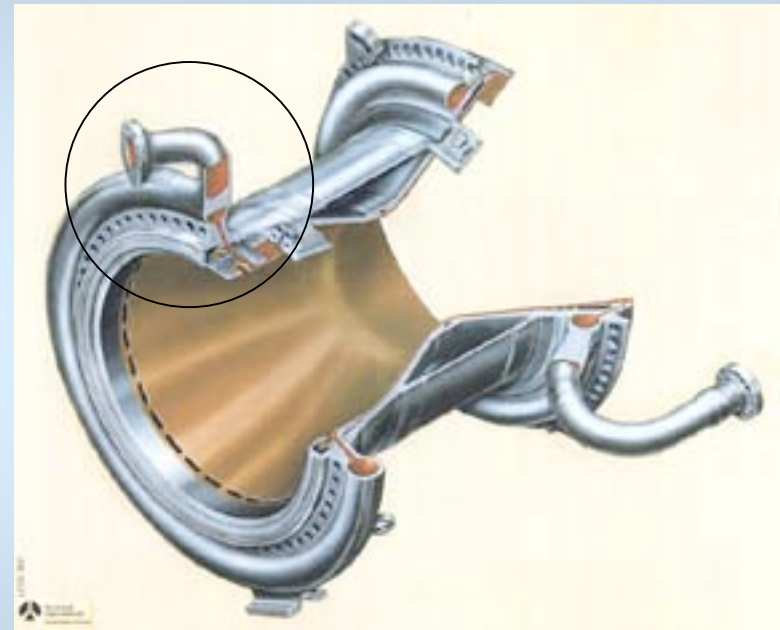
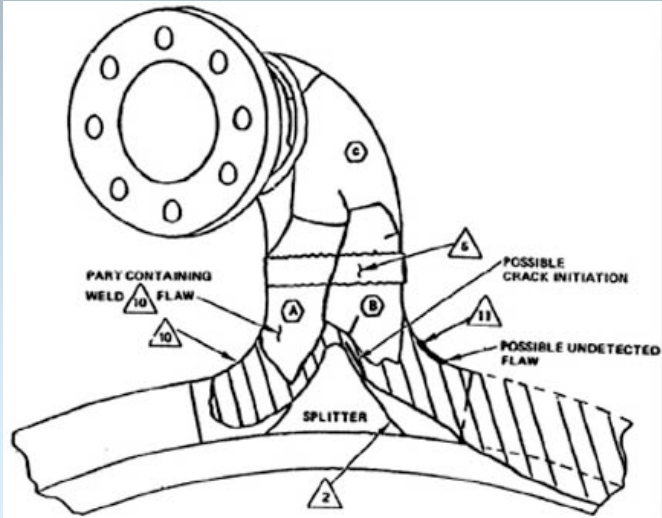

Test 7502594, Engine S/N 2308

Main Combustion Chamber Failures



Test 750259, Engine S/N 2308

Main Combustion Chamber Failures

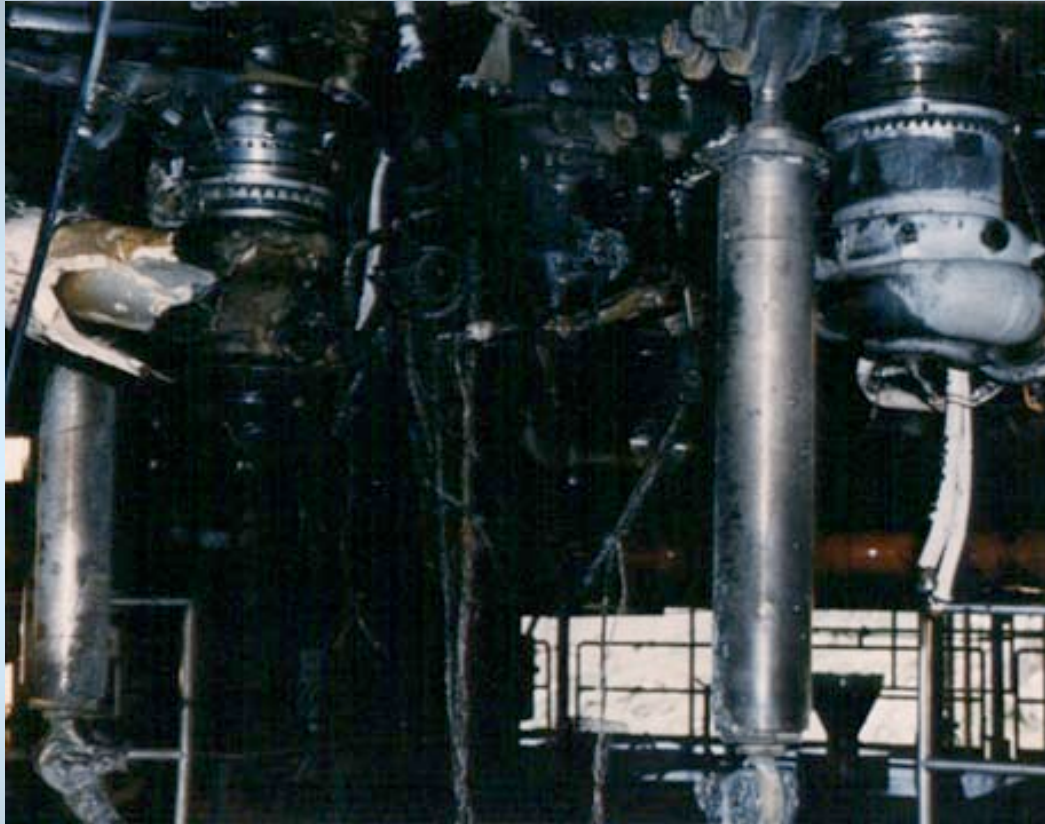

Test 750259, Engine S/N 2308

Combustion Device Failures Summary

Major Causes

- Limited Initial Materials Properties
- Limited Structural Models - especially fatigue
- Limited Thermal Models
- Limited Aerodynamic Models
- Human Errors

Limited Component Test

- High Pressure
- Complicated Control

The SSME was designed and developed 30 years ago when computational tools were still rather primitive

Space Shuttle

