



Transient Mathematical Modeling for Liquid Rocket Engine Systems: Methods, Capabilities, and Experience

Authors: David C. Seymour, ERC, Inc. (NASA retired)
 Michael A. Martin, NASA MSFC
 Huy H. Nguyen, NASA MSFC
 William D. Greene, NASA MSFC



***Fifth International Symposium on Space Propulsion
Chattanooga, Tennessee, USA***



Who we are...

National Aeronautics and Space Administration (NASA)



George C. Marshall Space Flight Center (MSFC),
Huntsville, AL



Space Transportation Directorate



Vehicle and Engine Systems Development Department



Systems Analysis Group



Engine and Motor System Analysis Team

We Are Here!

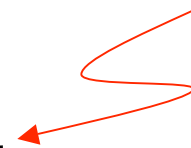



Fifth International Symposium on Space Propulsion Chattanooga, Tennessee, USA



Engine and Motor System Analysis Team: Recent Liquid Rocket Engine Experience

Space Shuttle Main Engine (SSME)

- Lox-Hydrogen Staged Combustion
- Contractor: Rocketdyne and Pratt & Whitney
- Operational – large experience base

RS-83

- Lox-Hydrogen Staged Combustion
- Contractor: Rocketdyne
- Completed study

COBRA

- Lox-Hydrogen Staged Combustion
- Contractor: Pratt & Whitney
- Completed study.

Integrated Powerhead Development (IPD)

- Lox-Hydrogen Full-Flow Staged Combustion
- Joint NASA and US Air Force project
- Contractor: Rocketdyne and Aerojet
- Component testing underway

RS-84

- Lox-Kerosene Ox-Rich Staged Combustion
- Contractor: Rocketdyne
- Component testing underway

TR107

- Lox-Kerosene Ox-Rich Staged Combustion
- Contractor: Northrup-Grumman / TRW
- Ongoing study contract

MC-1 (Fastrac)

- Lox-Kerosene Gas Generator
- Contractor: in-house project
- 6 engine tests



Fifth International Symposium on Space Propulsion Chattanooga, Tennessee, USA



Introduction: Liquid Rocket Engine Transient Modeling

- Liquid rocket engine development is expensive under the best of circumstances.
- The “Test-Fail-Fix” method is not the best of circumstances.
- Analytical modeling, specifically transient system modeling, is a means to overcome this.
- Over the past two decades, MSFC has dedicated significant resources to the development of our transient modeling capabilities.



- Space Shuttle Main Engine (SSME) was developed in the mid-1970's.
- It took about 50 tests, lots of hardware, and a year of effort to get the SSME through a repeatable start transient.
- In the 1990's, the MSFC-developed MC-1 engine benefited from the involvement of transient systems modeling in the development process.



Transient Modeling and Design Considerations

- Typical rocket engine design practice is based primarily on steady-state performance (with some allowance made for surge pressures)

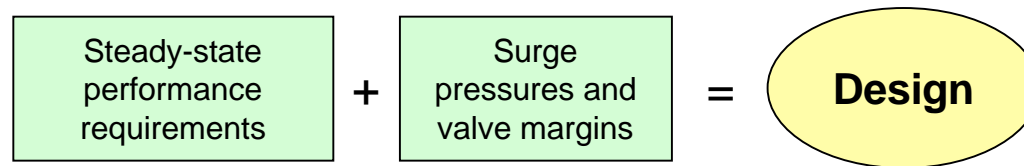

- It is thus often the task of the transient modeling analyst to figure out how to start and shutdown the engine safely with the hardware as given.
- A better approach is to involve transient analysis as a part of the development program early in the process.

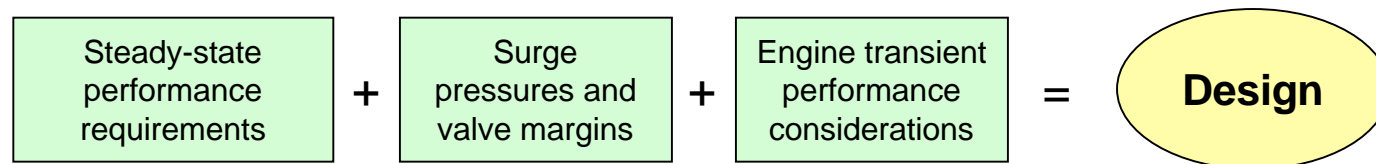

- Examples:
 - IPD – spin-assist start
 - MC-1 – addition of rotary damper to valves



Fifth International Symposium on Space Propulsion Chattanooga, Tennessee, USA



Operations and Failure Considerations

- One thing that definitely cannot be explored, even if a program did have an infinite budget, is the full territory of engine failure modes.
- Instantly catastrophic failures are an inherent element of liquid rocket engine development, but not all failures fall within this category.
- Only through the use of a transient model can “what if” scenarios be explored.
 - What if pump or turbine performance is suddenly degraded?
 - What if ignition of a combustion chamber fails?
 - What if there is a deviation from the scheduled valve sequence?
- The goal is always to avoid a catastrophic situation if at all possible.
 - How can an off-nominal situation be identified?
 - How can a safe shutdown be implemented from these conditions?
 - Are there situations in which shutdown itself causes a catastrophic condition?
(Example: SSME shutdown during start transient)



Failure Scenario Considerations: **SSME Example**

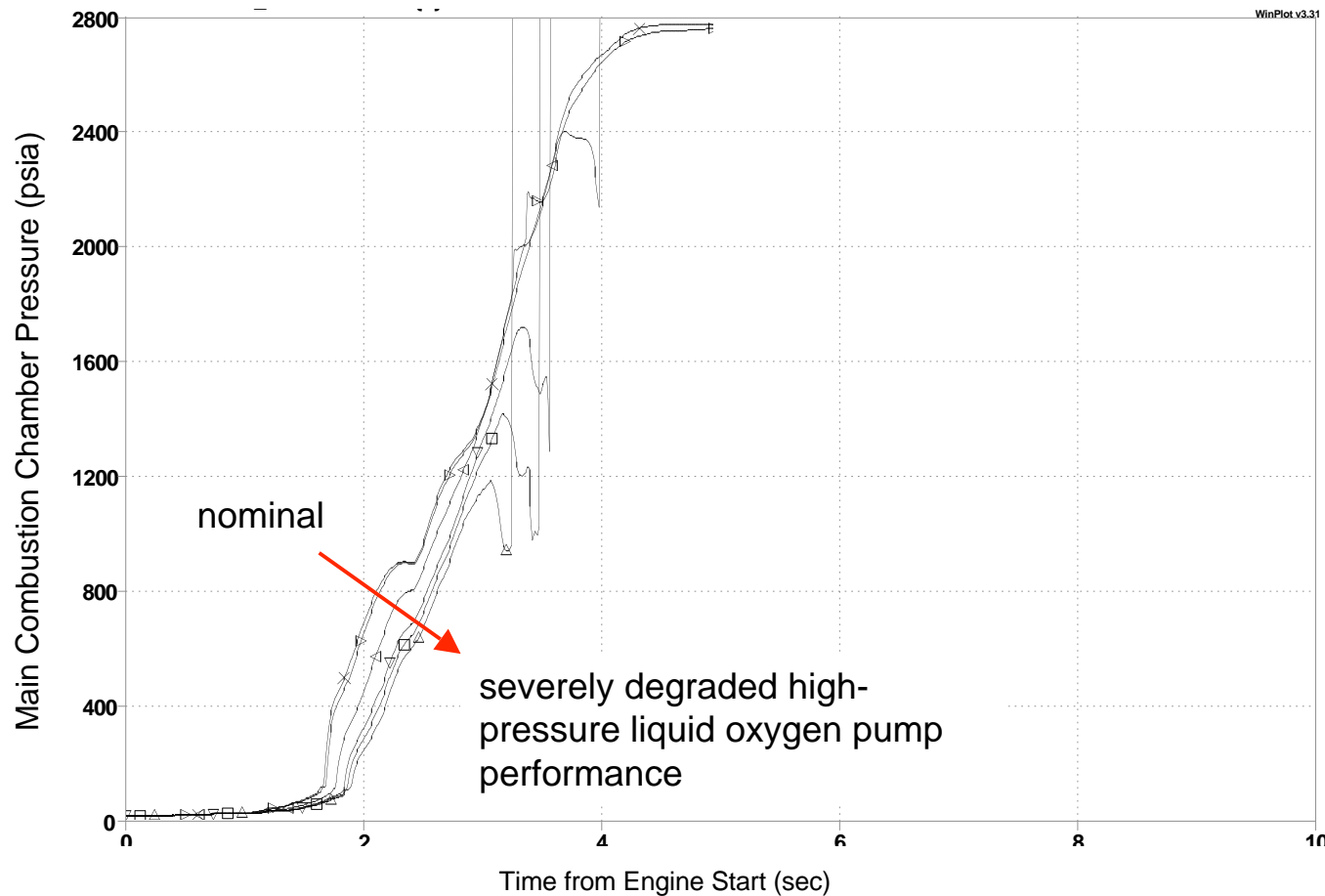



Fifth International Symposium on Space Propulsion
Chattanooga, Tennessee, USA



Failure Scenario Considerations: **SSME Example (continued)**

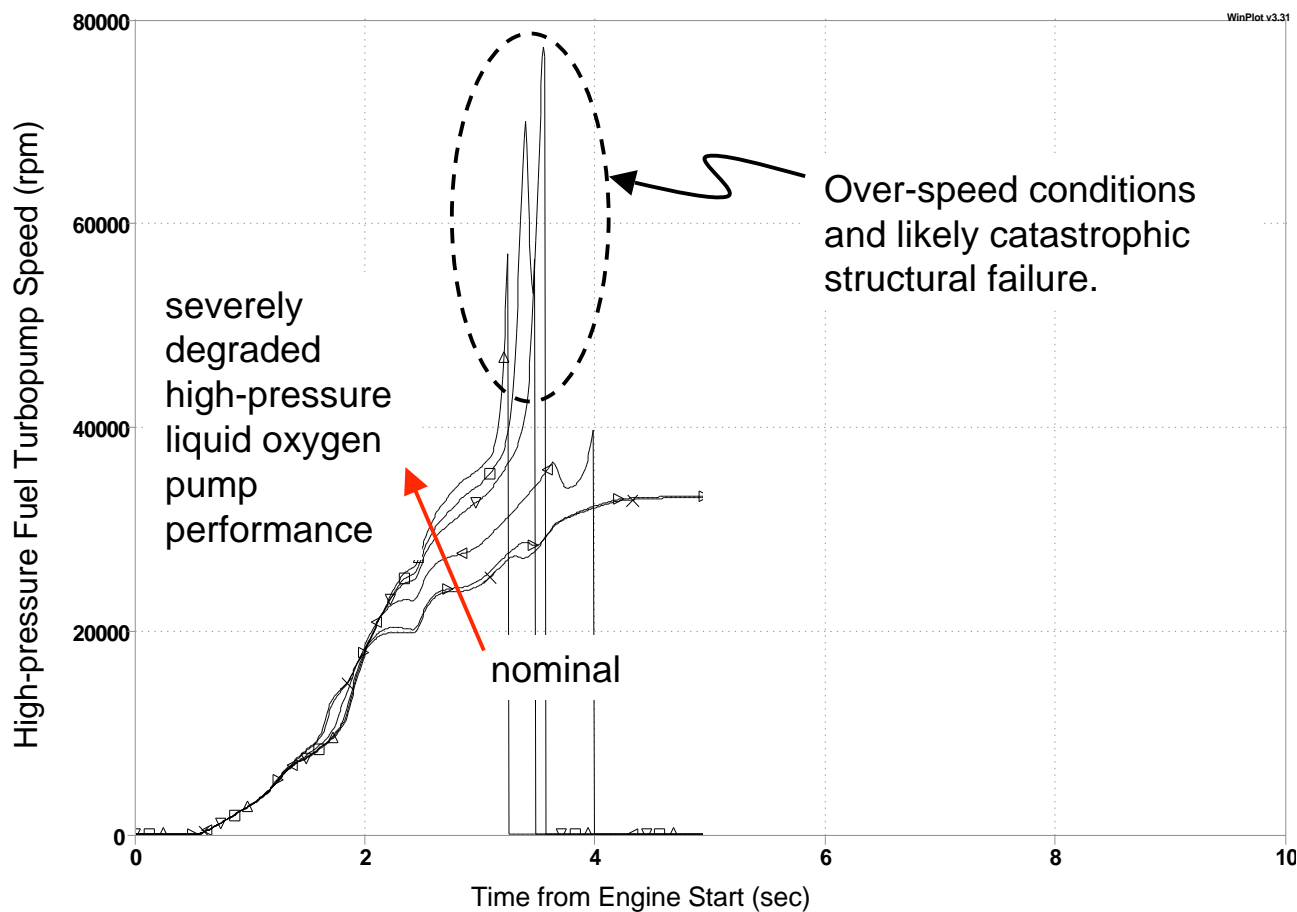



Development Testing and Design Verification

- When engine design requirements cannot be verified by test, then analysis must be used to fill the void.
- However, analysis cannot stand alone. It must be informed by the testing that is performed at the component, subsystem, and system levels.
- Further, the analytical models continue to be informed by engine performance throughout the mission life of the engine. (Example: [SSME DTM – MSFC derived](#))

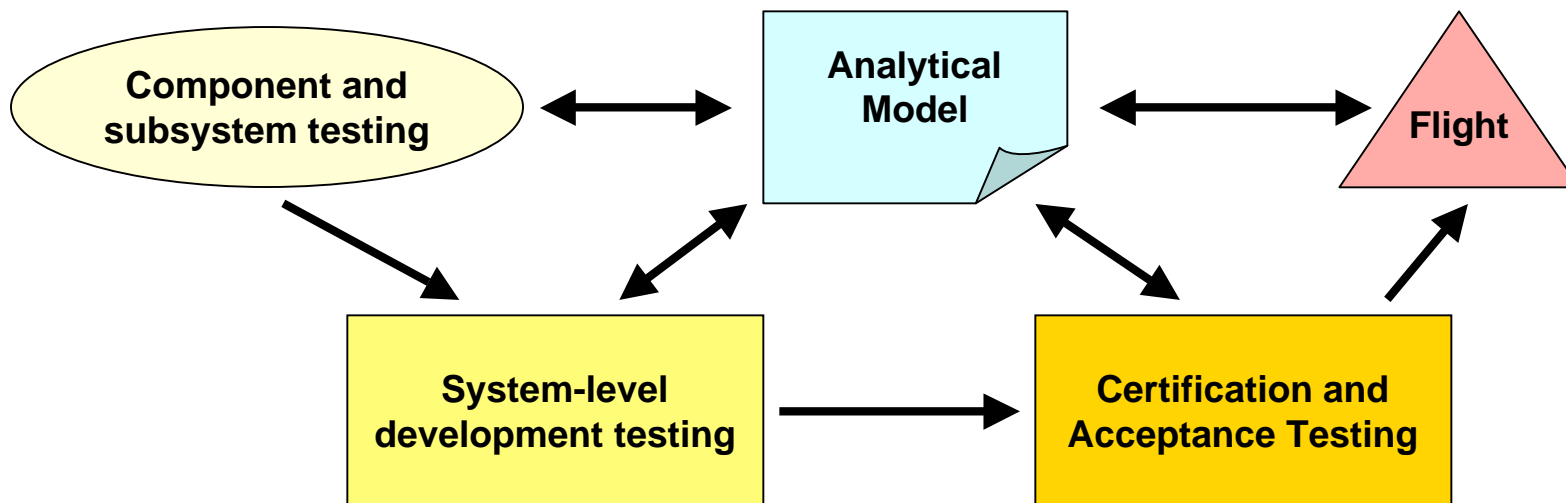



Transient Modeling Overview

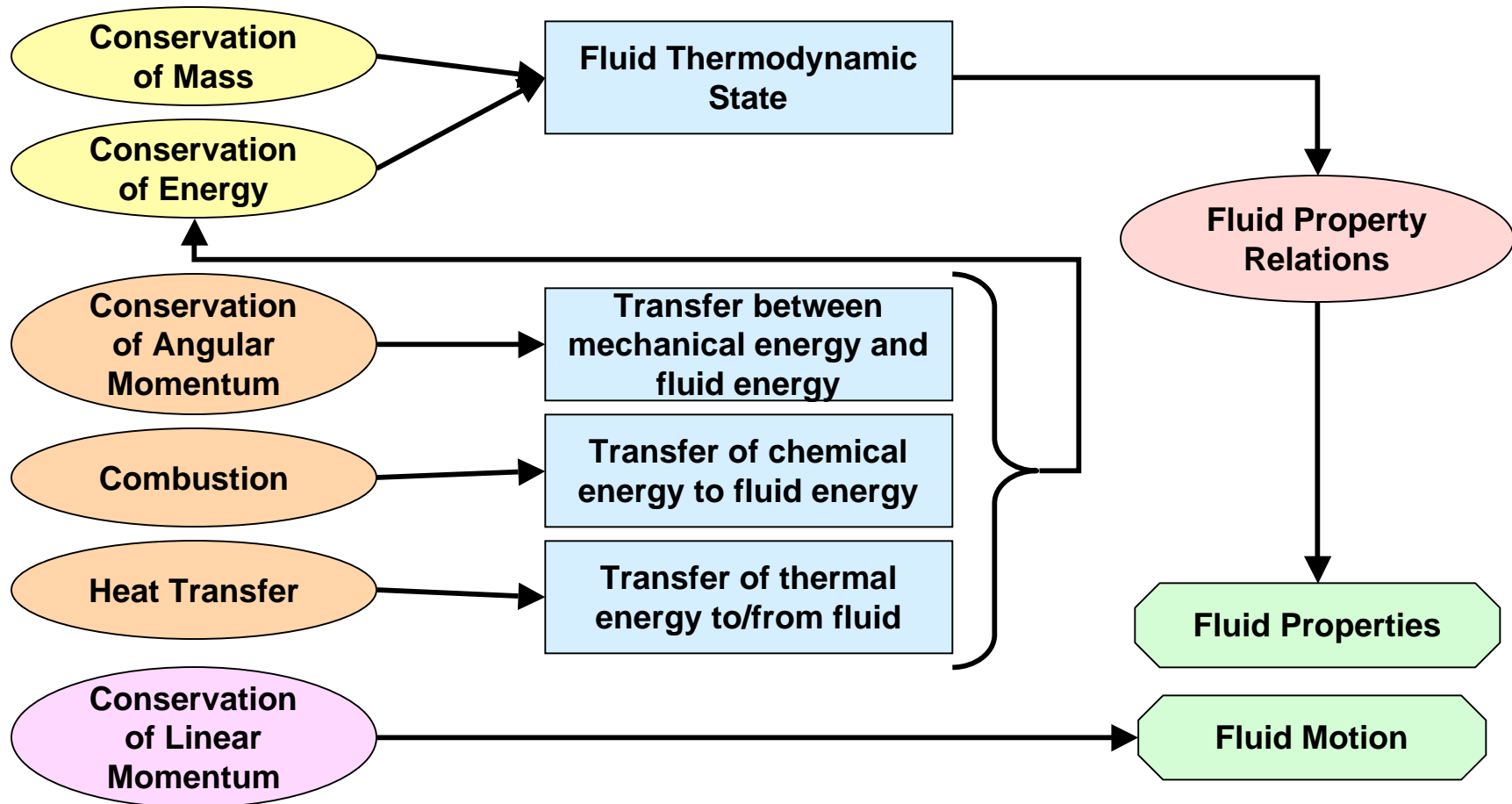



Place of Engine System Modeling within the Community

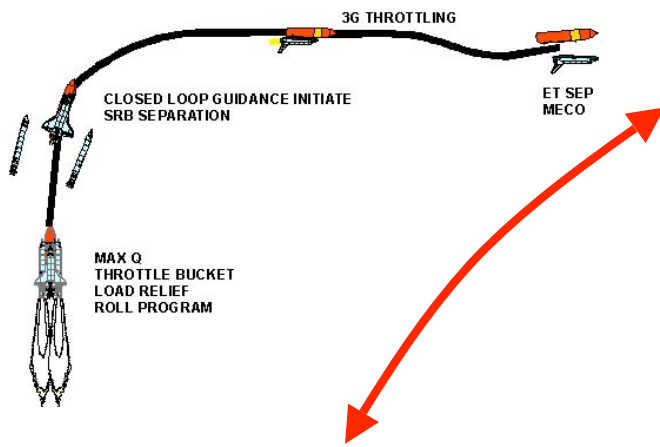

Engine System Modeling (Also called "Lumped-Parameter" Modeling)

- Engine environments at the homogeneous volume level
- Moderate fidelity
- Scope is the engine system
- It is not:
 - Method of characteristics modeling
 - Incompressible fluids modeling
 - Fluid phase-volume modeling

Mission Analysis

- Mission environments
- Low fidelity (w/ regards to engines)
- Global scope

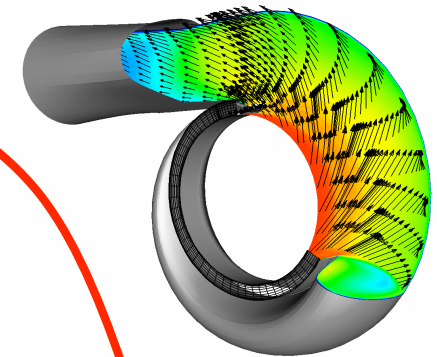
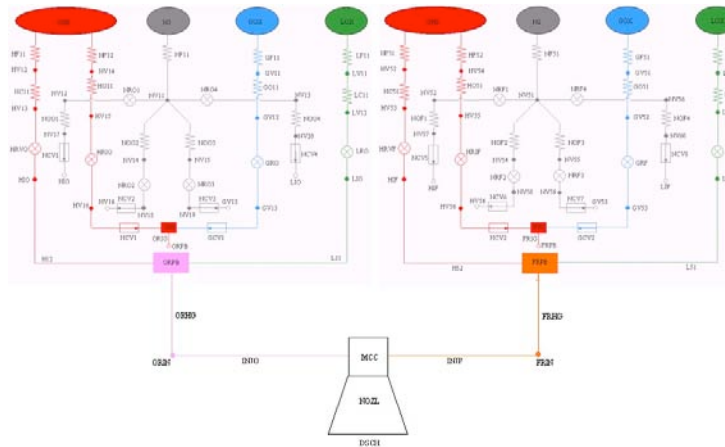

Computational Fluid Dynamics

- Local environments
- Very high fidelity
- Limited scope



Conservation of Mass and Energy

Homogeneous Control Volume: Conditions within the volume determine the fluid state.

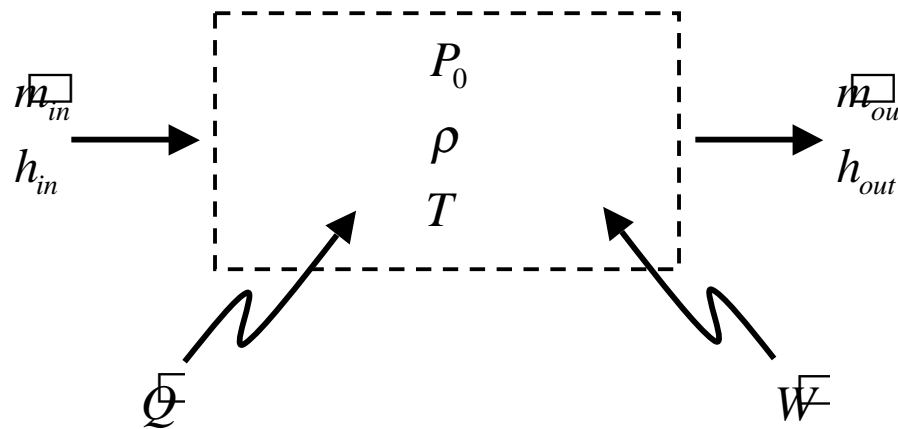

$$\frac{\partial \rho}{\partial t} = \frac{1}{V} (\sum \dot{m}_{in} - \sum \dot{m}_{out})$$

$$\frac{\partial u_{CV}}{\partial t} = \frac{\sum (\dot{m} h_0)_{in} - \sum (\dot{m} h_0)_{out}}{\rho_{CV} V} + \frac{W_{net} + Q_{net} - u_{CV} (\sum \dot{m}_{in} - \sum \dot{m}_{out})}{\rho_{CV} V}$$



Conservation of Linear Momentum

Flow Circuit: Series of homogeneous volumes represented as nodes within a circuit connected by elements of flow resistance and flow inductance.

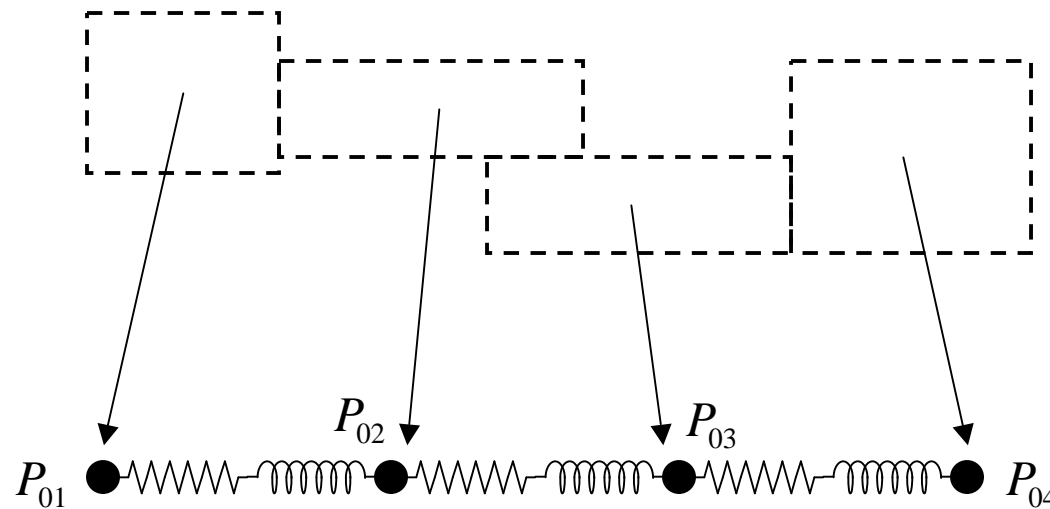

$$\frac{\partial \bar{m}_{ij}}{\partial t} = \frac{A}{L} \left[(P_{0i} - P_{0j}) - \frac{R \bar{m}_{ij}^2}{\rho} \right]$$

One form of many for describing
flow between volumes



Conservation of Angular Momentum

Rotating Machinery: Typically consisting of a turbine element and a pump element.

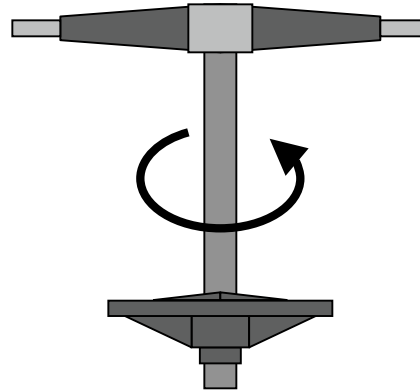

$$\frac{\partial N}{\partial t} = \frac{\sum T_{turbine} - \sum T_{pump}}{I}$$

Also, for turbomachinery performance maps are necessary to form a complete system of equations.



Combustion Devices

*Special Homogeneous Volume -- Combustion Zone:
 Mixing of several constituents and often inert purge
 gases plus the addition of chemical energy to the flow.*

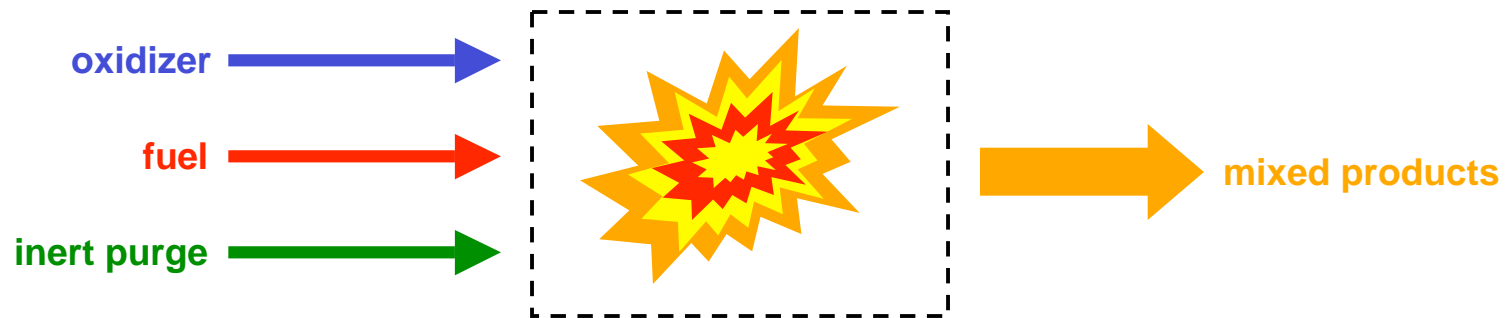

$$OFR = \frac{M_{ox}}{M_{total}} = \frac{M_{ox}}{M_{ox} + M_{fuel}}$$

$$\frac{\partial(OFR_{CV})}{\partial t} = \frac{(\sum \dot{m}_{ox_{in}} - \sum \dot{m}_{ox_{out}})}{M_{total}}$$

$$OFR_{CV} \frac{(\sum \dot{m}_{total_{in}} - \sum \dot{m}_{total_{out}})}{M_{total}}$$

To the usual Conservation of Mass and Energy considerations must be added a description of mixed fluid composition. Oxidizer fraction (OFR) is the factor.



Fluid Properties

- Fluid property relations are the connection between mathematics and actual fluids.
- In order to run efficient analyses, property tables are used.
- MSFC has developed means of automatically generating these tables to a specified level of interpolation error.

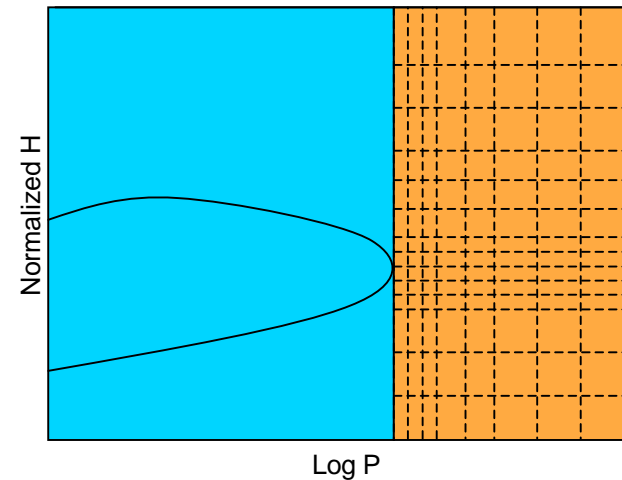
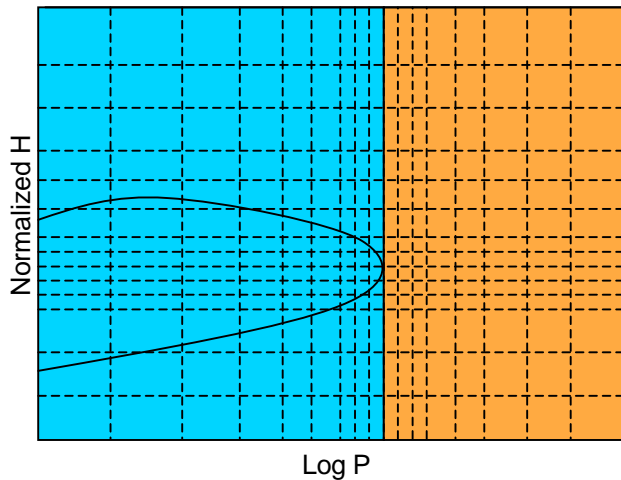
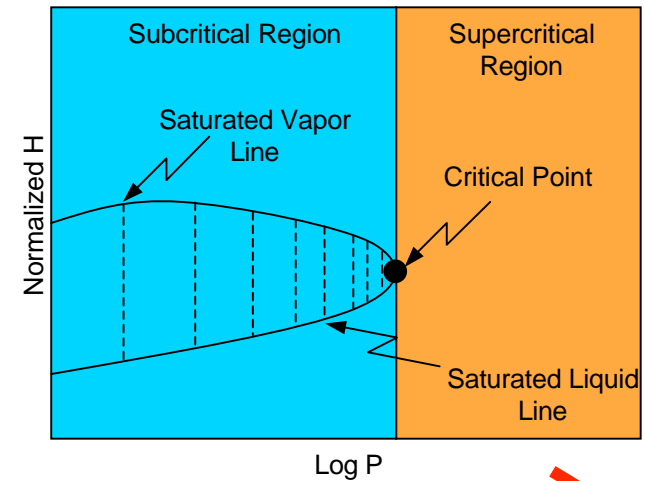



Fluid Properties (continued)

- One tricky aspect of creating propellant tables is dealing with the phase-change dome.
- MSFC has developed interpolation methods for handling these cases where points of interest straddle the phase-change line.

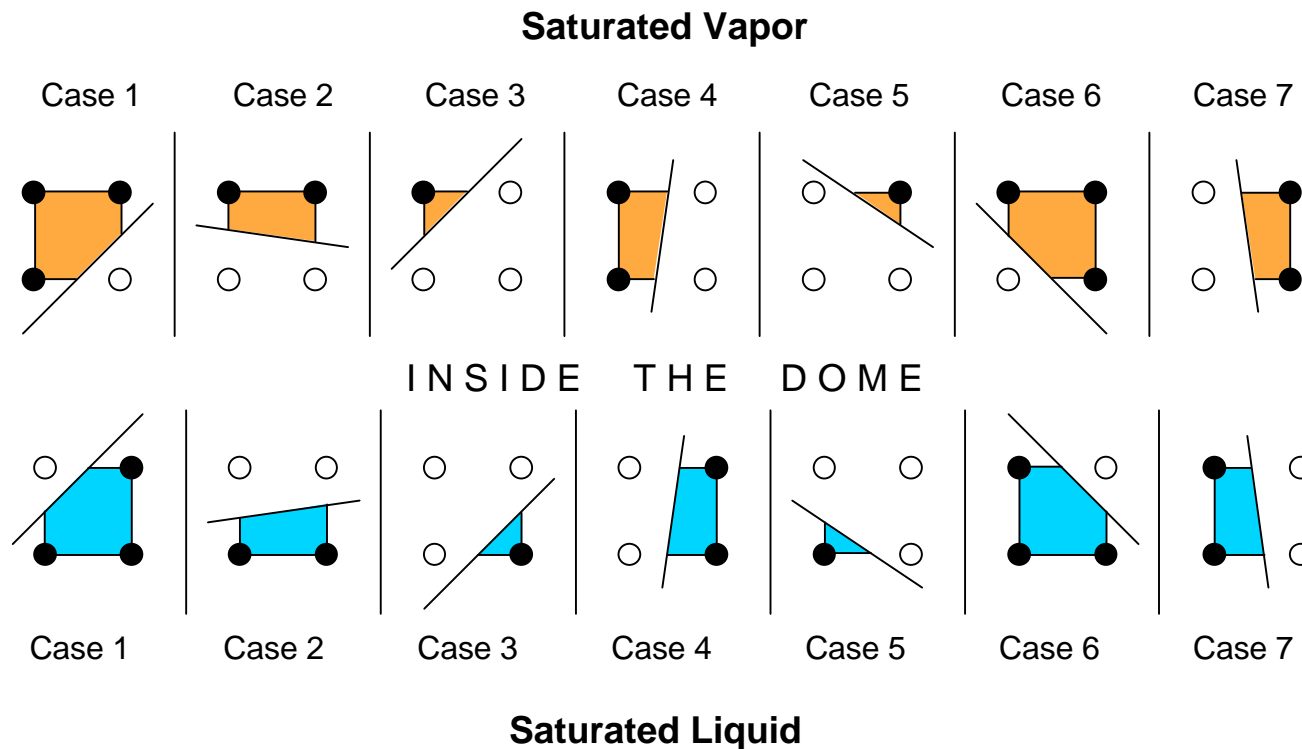



Fifth International Symposium on Space Propulsion Chattanooga, Tennessee, USA



Numerical Issues and Integration

- Engineers at MSFC most commonly use implicit integration for rocket engine transient modeling.
 - Allows larger time step but requires an iteration at each time step
 - Overall more efficient because the number of iterations is automatically variable as the solution proceeds. Equivalent methods of varying the explicit integration time step are not available.
- Current practice is to use a multivariable Newton-Raphson iteration method in conjunction with the Broyden technique of Jacobian evolution during solution progression.
 - Iteration independents are normalized pressure and fluid enthalpy.
 - Iteration dependents are the normalized deviations of the states from the implicit integrated values.
 - To avoid infinite slopes within the Jacobian, flow rate equations are linearized near zero pressure differential conditions.



Fifth International Symposium on Space Propulsion Chattanooga, Tennessee, USA



Future Work

- Upgrades to ROCETS (ROCKET Engine Transient Simulation) code – nonproprietary code open to U.S. Government agencies and U.S. companies.
- Usability improvements
 - Development of a graphical users interface for model creation and results interpretation.
- Modeling improvements
 - Development of a Generalized Combustion (GCOMB) approach to handle complex control volumes in a combustion zone.
 - GCOMB handles arbitrary mixtures of reactants, combustion products, and inert purge fluids.
- Numerical scheme improvements
 - Working with a number of partners on improved computational and mathematical approaches to solving nonlinear sets of equations.
 - Includes line back-search applied to Newton-Raphson-Broyden, simulated annealing, embedding procedure for parametric solutions, and various genetic algorithms.

Transient Mathematical Modeling for Liquid Rocket Engine Systems: Methods, Capabilities, and Experience

Michael A. Martin, Huy H. Nguyen, and William D. Greene
NASA Marshall Space Flight Center, Huntsville, AL

David C. Seymour (NASA-retired)
ERC, Inc., Huntsville, AL

Abstract

The subject of mathematical modeling of the transient operation of liquid rocket engines is presented in overview form from the perspective of engineers working at the NASA Marshall Space Flight Center. The necessity of creating and utilizing accurate mathematical models as part of liquid rocket engine development process has become well established and is likely to increase in importance in the future. The issues of design considerations for transient operation, development testing, and failure scenario simulation are discussed. An overview of the derivation of the basic governing equations is presented along with a discussion of computational and numerical issues associated with the implementation of these equations in computer codes. Also, work in the field of generating usable fluid property tables is presented along with an overview of efforts to be undertaken in the future to improve the tools use for the mathematical modeling process.

Nomenclature

dt	Time increment	L	Length
h_0	Total Enthalpy	M	Mass
\dot{m}	Mass Flow Rate	MR	Mixture Ratio
t	Time	N	Rotational Velocity
u	Internal Energy	OFR	Oxidizer Fraction
\hat{u}	Fluid Velocity	P_0	Total Pressure
A	Area	\dot{Q}	Heat Transfer
CV	Control Volume	R	Fluid Resistance
\dot{E}	Energy Flux	T	Shaft Torque
F	Force	V	Volume
I	Moment of Inertia	\dot{W}	Work
		Y	Generic Fluid Property
		ρ	Density
		τ	Time Constant

This is a work of the U.S. Government and is not subject to copyright protection in the United States. Foreign copyrights may apply.

Introduction

The development of complex and expensive machinery such as liquid propellant rocket engines within the real world of limited budgets requires that analytical tools be used to facilitate the process as much as possible. Rocket engine project managers expect and plan to have detailed engine transient analysis available early in their development program. Because building hardware and conducting testing is exorbitantly expensive, they typically budget only a few tests to develop the engine start and shutdown sequences and they do not plan for the possibility of major hardware damage as part of the process. They can do this because the U.S. rocket engine community has actively developed analytical tools to take advantage of the tremendous increase in computer power over the last twenty years.

At the NASA Marshall Space Flight Center (MSFC), engineers recognized about two decades ago that new ways of rapidly developing moderately detailed models of new engines was needed. Although monetary resources have been very limited, engineers have continued to pursue this goal and today possess very powerful tools to offer the prospective liquid rocket engine program manager.

Despite all of the work to date, however, rocket engine transient analysis remains a very challenging discipline. While steady-state tools have evolved almost to the point that any engineer can use them, transient analysis still requires dedicated specialists experienced in transient analysis to get useful results. The transient analyst must develop and manage a large amount of input data, describe complex physics, and deal with challenging computational and numerical issues. All mathematical modeling requires the utilization of some level of approximation and selecting

the right approximation to the complex physics involved in transient analysis is critical and often unique to the model being developed. The tools developed at MSFC allow the specialist to choose between common generic approximations or generate and implement their own versions.

Having detailed, reliable transient analysis available during the design phase, prior to hardware testing is enormously valuable. For example, the initial design and testing of the Space Shuttle Main Engine (SSME), shown in Figure 1, did not benefit significantly from such analysis. About a year of time, the accumulation of approximately fifty tests, and a significant amount of engine hardware were required to get the engine through a reasonable and repeatable start transient. This was not the fault of the transient analysts, they were exceptionally capable, but rather due to the very limited computer power available at the time.



Figure 1, Space Shuttle Main Engine (SSME)

Subsequent engine development programs, such as the MSFC-developed MC-1 (also called Fastrac), shown in Figure 2, although few in number and of simpler designs, have demonstrated dramatically lower development costs in part due to advances in engine transient modeling analyses and the computers to drive them. Further, this approach of emphasizing transient model development early in the engine design period has become the standard process followed for the next generation of rocket engines being pursued through the NASA Next Generation Launch Technology Program.



Figure 2, MC-1 (Fastrac) thrust chamber assembly being tested at MSFC

Design Considerations

Typical design practice for liquid rocket engines dictates that with the exception for surge pressures and valve margins, most engine components are designed to meet steady-state performance requirements. Thus, most engine elements are not been designed with start and shutdown transient environments in mind. Thus, it becomes the task of the transient analyst to take given component capabilities and find start and shutdown sequences that are safe for the

components and still meets all other performance requirements.

During the preliminary design phase, engine system analysis may be required to set basic engine requirements. For example, in the joint NASA and Air Force Integrated Powerhead Development (IPD) engine program, transient system analysis showed that an engine start sequence based on tank pressure head alone was a risky proposition. This analysis was used to justify the inclusion of provisions for turbopump spin-assist into the engine and facility development.

For most engine development programs, as the engine design matures so does the model detail and fidelity. Model sensitivity analyses can point to component characteristics most critical to successful, repeatable starts and shutdowns.

An example of this can be found during the MC-1 development. Early flow tests of the main propellant valves showed that the valves were “jerking” open instead of opening in a smooth, controlled manner. Simulating this valve behavior in the engine transient model showed that this was an undesirable condition. The quickly opening valves, combined with a helium spin-start on the turbine, resulted pump cavitation. Using the same codes that are used for engine transient models, a detailed transient model of the pneumatic valve itself was able to duplicate the phenomenon. One potential fix was to add a rotary damper to the valve. This fix was added to the valve model to verify the results prior to testing. After adding the rotary damper to the actual valve, the valves opened smoothly. Thus, the model aided in the design of the valve prior to engine hot-fire testing. The model was used not only to show the effects of the valve design on the engine system, but was also used in fixing the design flaw.

The transient system mathematical model predictions are key inputs into the initial engine system test plan and are a vital part of post-test analysis. Final engine start and shutdown sequences are, of course, verified by test. However, some off-nominal start or shutdowns may be impossible, impractical, or unsafe to demonstrate with actual engine hardware and must be verified by the transient model alone.

Design Verification and Operation

When meeting the engine design requirements that cannot be verified by test, it is standard practice to use analysis to fill the void. The transient engine model is anchored to the available test data, specifically for conditions as close as possible to the verification condition, and then used to predict the engine operation at the verification condition.

This approach was taken for SSME to verify safe engine flight shutdown under liquid oxygen depletion conditions. Several attempts to simulate the zero-g flight engine feedline conditions on a ground test stand were made. However, none were judged to satisfactorily simulate the behavior of the saturated liquid oxygen in the feedline and its effect on the low-pressure liquid oxygen pump performance. The transient analysis on this issue performed by Rocketdyne, the SSME prime contractor, was a vital part of the SSME shutdown performance verification for flight.

Verification of safe shutdown at any point in time during engine operation is another area that usually requires analysis. Such an analysis was not formally performed for the SSME during engine development. After about twenty years and several thousand engine tests, a redline engine cut occurred in a ground test during the engine start sequence at a slightly different time than previously tested. This shutdown resulted in a control valve

exceeding its operating limit. The valve was commanded to close but failed to do so under the conditions and the result was extensive engine damage. Because of this engine failure, the software controlling the SSME shutdown sequence was modified to avoid such a situation in the future. Subsequent transient analyses verified the inherent danger in the original sequence and have been used extensively to examine all other points throughout the mission profile.

Failure Scenario Considerations

For liquid rocket engines, many hardware failure modes are classified as inherently catastrophic and are not extensively analyzed. The power unleashed and the speed at which the failures occur are so great that they preclude any possibility of mitigation or minimization. This is simply the nature of the field. However, there are a very large number of failure modes that are not inherently catastrophic but could lead either to an engine shutdown or to engine performance sufficiently off nominal as to prevent the vehicle from fulfilling mission objectives. Many of these failures are too costly or too risky to verify by test and must be assessed by engine system transient analysis.

Some examples from the SSME program include degraded control valve actuator performance, propellant or combustion gas leaks, check valve leaks, flow restrictions due to contamination, and degraded turbopump performance.

The specific example of an engine start being attempted under the conditions of severely degraded turbopump performance is shown in Figures 3 and 4. In this case, the performance of the SSME high-pressure liquid oxygen pump is degraded to differing degrees over a series of transient model runs. After a certain amount of performance degradation, the pump

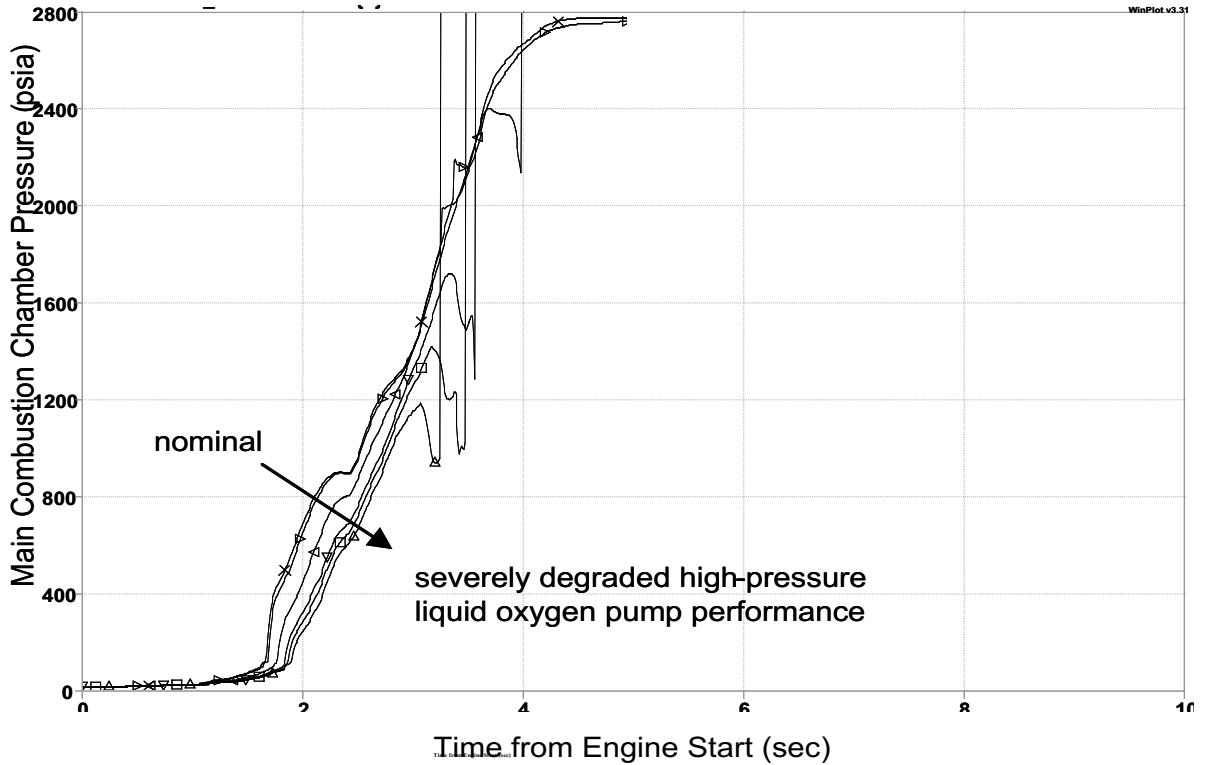

Figure 3, SSME main combustion chamber pressure during the start transient with varying levels of high-pressure oxidizer pump performance degradation.

Obviously, this is not a scenario that would be desirable to actually test with engine hardware. It is, however, a scenario for which controls must be built into the system to prevent. So this is the kind of analysis that is used to derive redline conditions used throughout the start sequence as Go/No-Go gates to proceed with the start sequence. In this case, a redline is set on the main combustion chamber pressure to ensure that sufficient back-pressure is maintained on the high-pressure fuel turbine thereby preventing an over-speed condition.

Engine Development Testing

A transient model of a liquid rocket engine can be a very important tool in determining design considerations for the engine, even very early in the program. Although many design details may not be known, the model can still be used to get a top-level idea of how the engine will behave during start and shutdown. As the design progresses, the transient will evolve into a more accurate representation of the actual final engine design.

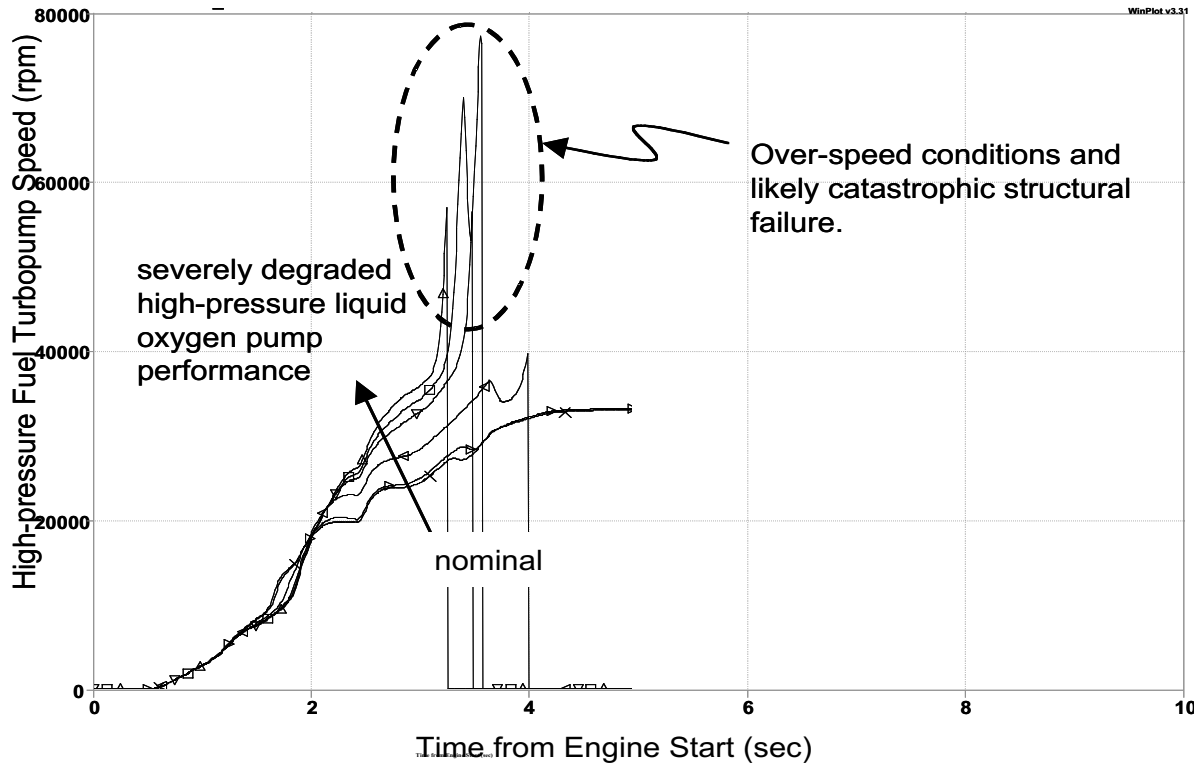

Figure 4, SSME high-pressure fuel turbopump speed during the start transient with varying levels of high-pressure oxidizer pump performance degradation.

Typically, component tests are performed prior to full engine testing to determine operating characteristics and design margins of the individual components in a more benign environment. A transient model can be used at this level as well, though usually component test facilities are not able to perfectly duplicate engine conditions during start and shutdown. Facility-specific sequences are required to keep the components within their acceptable ranges of operations. A transient model of the component test facilities, many times, can yield important clues about how to start the full engine, as well as how to keep the components safe during the tests. Even at this level, model anchoring through detailed post-test data analysis is a vital part of transient system model development.

When the engine finally gets to system-level development testing, the importance of the transient model becomes more critical, especially for the more complex cycles such as staged combustion where multiple control valves must be precisely choreographed to yield a safe start and shutdown. Despite the application of best practices and best efforts, however, unknowns about the complex interactions of the components during the transient operation can still make the transient model less than perfect. This is often illustrated while attempting the initial few tests of an engine. It is incumbent upon the analysts to keep up with the latest test data and attempt to reconcile differences between test data and model predictions. Many times, the model becomes critical in understanding this test data. As development testing continues,

the model should become more refined and consistently accurate.

Once the engine is well into development testing, the model can be used to refine the start and shutdown sequences in an attempt to minimize damaging characteristics of the transients. Examples of this are the minimization of thermal ignition spikes in combustion devices and pressure surges in lines. It is the responsibility of the analyst to recommend ways to improve the operational sequences in order to optimize the start and shutdown. This process continues even as the engine enters the flight program since the transient model becomes a primary tool in the understanding of sequence change impact and the resolution of anomalous situations.

A good example of a transient model utilized and maintained long after an engine has been demonstrated in flight is the SSME Digital Transient Model (DTM). This model is kept under configuration control and is used to resolve transient performance issues after over twenty years of successful flight use. It is used to validate proposed changes to the baseline start and shutdown sequences and to evaluate real and hypothetical anomalous situations.

Thus, a transient model of a liquid rocket engine is important through all phases of an engine program. In fact, as the modeling tools become better and more sophisticated in the future, their importance is likely to increase.

Transient Modeling Physics and Basic Modeling Strategy

Transient modeling of a liquid propellant rocket engine system is typically based upon the assumption of approximating the engine as a series of homogenous control volumes. Within each volume the principles of the conservation of mass and energy are applied.

This includes the incorporation of thermal analysis, where appropriate, when temperature changes in the hardware itself is influencing the fluid conditions. Further, these volumes are connected to create a fluid flow network to which the principle of the conservation of linear momentum is applied as a governing equation to determine the transport of fluid from one volume to another.

Finally, because of the unique aspects of liquid typical, high-power rocket engine systems, special considerations must be made for the inclusion of rotating machinery and the existence of combustion zones. Rotating machinery, otherwise called turbomachinery, is included within the solution process via the use of the conservation of angular momentum. Combustion zones, called combustion devices, require the additional consideration of the addition of chemical energy into the system and the change in the chemical content of the working fluids.

All of this together constitutes the complete system that must be accurately modeled through mathematical and computational analysis.

Conservation of Mass

For a control volume as pictured in Figure 5, the transient form of the conservation of mass equation begins with the definition of density.

$$\rho = \frac{M}{V} \quad (1)$$

By differentiating this equation, the familiar form of the conservation of mass can be derived. This is fundamentally a statement that mass can be transported or accumulated but can neither be created nor destroyed.

$$\frac{\partial \rho}{\partial t} = \frac{1}{V} (\sum \dot{m}_m - \sum \dot{m}_{out}) - \frac{\rho}{V} \frac{\partial V}{\partial t} \quad (2)$$

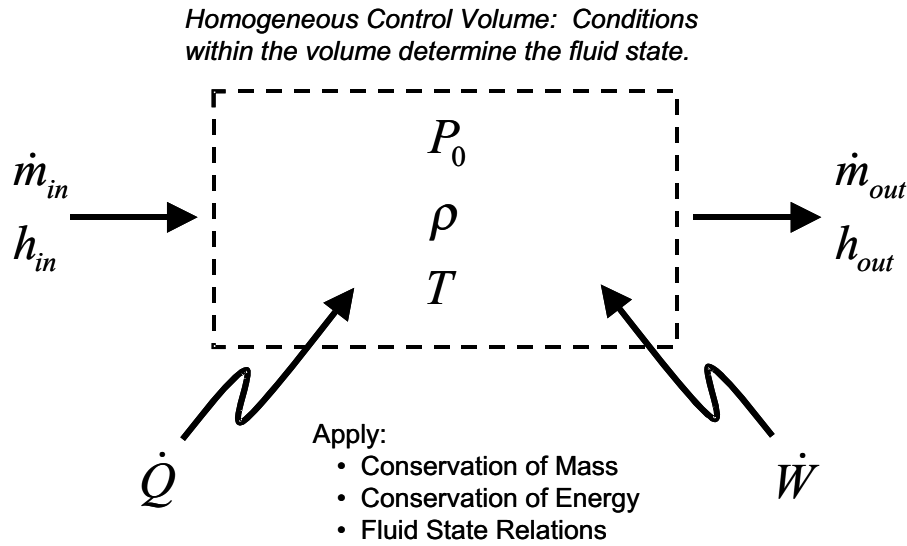

Figure 5, Homogeneous control volume with inputs and outputs.

Equation 2 is the form of the conservation of mass equation most useful for transient modeling. For most applications of this equation, the volume is fixed and, therefore, the equation simplifies to:

$$\frac{\partial \rho}{\partial t} = \frac{1}{V} (\sum \dot{m}_{in} - \sum \dot{m}_{out}) \quad (3)$$

This equation gives one the current rate of change of density based on the current values of flowrates entering and leaving a control volume. This is the first state equation.

Conservation of Energy

The second state equation applicable to the control volume pictured in Figure 5 is derived from the first law of thermodynamics. Just as with mass, the statement of conservation of energy is that the rate of flow of energy into a control volume minus the rate of flow of energy out equals the rate of energy accumulation. Energy is neither created nor destroyed. In mathematical terms this becomes,

$$\frac{\partial E_{CV}}{\partial t} = \dot{E}_{in} - \dot{E}_{out} + \dot{W}_{net} + \dot{Q}_{net} \quad (4)$$

Typically, potential energy in the form of elevation effects is ignored and kinetic energy in the form of fluid velocity is included within the formulation of total enthalpy terms. This leads to the form used for transient analysis,

$$\frac{\partial u_{CV}}{\partial t} = \frac{\sum (\dot{m} h_0)_{in} - \sum (\dot{m} h_0)_{out}}{\rho_{CV} V} + \frac{\dot{W}_{net} + \dot{Q}_{net} - u_{CV} (\sum \dot{m}_{in} - \sum \dot{m}_{out})}{\rho_{CV} V} \quad (5)$$

Within the term \dot{Q}_{net} exists the possibility of heat transfer between the fluid and the engine hardware. This is an important factor for transient analysis, particularly when dealing with cryogenic propellants.

Equation 5 is the state equation for the internal energy of the control volume. Combined with Equation 3, these two derivative equations allow for the determination of two

independent states of the fluid, from which any other required thermodynamic properties can be determined.

Conservation of Linear Momentum

So far, only the state of the fluid can be determined from the equations derived. Motion of the fluid from volume to volume is based upon Newton's Second Law formulated for a control volume.

$$\frac{d(m\hat{u})}{dt} = \sum F \tag{6}$$

This is a statement of the conservation of linear momentum, which is simply that the momentum of fluid will remain unchanged unless acted upon by a force. Within the context of transient analysis, the forces typically acting upon the fluid are pressure and viscous effects.

There are a number of different flow processes

that can be modeled. The most common and the most general is the flow through a network represented by a series of homogeneous control volumes. A simple representation of this is shown in Figure 6 where the volumes act as nodes in the network. Solution of this network involves the transformation of Equation 6 into an analogy of electrical circuit solution methods.

$$\frac{\partial \dot{m}_{ij}}{\partial t} = \frac{A}{L} \left[(P_{0i} - P_{0j}) - \frac{R \dot{m}_{ij}^2}{\rho} \right] \tag{7}$$

Where *i* and *j* represent two nodes within the network and the variables *A* and *L* represent effective cross-sectional area and node-to-node linear distance. For many problems such as flow in a duct these parameters have obvious values but for problems involving complex flow geometry situations, determining the appropriate values for these factors can become problematic. The engineer must often depend upon experience,

Flow Circuit: Series of homogeneous volumes represented as nodes within a circuit connected by elements of flow resistance and flow inductance.

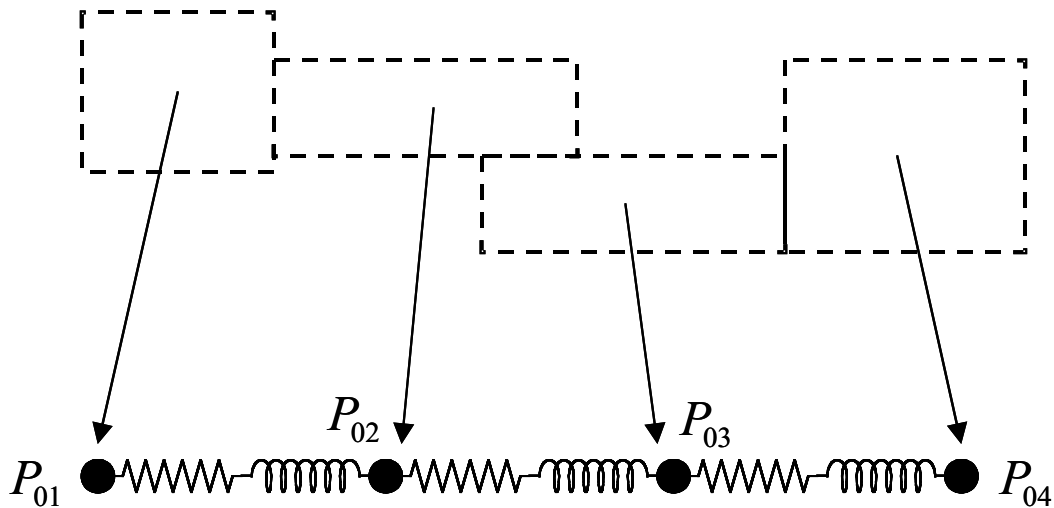

Apply:
 • Conservation of Linear Momentum

Figure 6, Modeling representation of a fluid flow circuit

reasonable approximation, and even empirical data to come to truly representative values for these parameters.

For a steady state problem Equation 7 simplifies to the situation of flow being driven by pressures and being resisted by viscous and friction forces represented by the variable R and called flow resistance, in keeping with the analogy to the electrical circuit. For the case of transient flow, the inertia of the fluid itself must be taken into account unless the fluid is so light that this is a negligible factor as is often the case for gases. For liquid flow, and again in keeping with the electrical circuit analogy, this fluid inertia factor can be thought of as an effective inductance term.

By combining Equation 7 for node-to-node fluid transfer with the fluid state determination represented by Equations 3 and 5 applied to each node in circuit, we now have a solvable transient flow circuit.

It should be noted that formulation of the conservation of linear momentum as shown in Equation 7 does not fully encompass all of the various flow regimes existing within a rocket engine. For example, specialized formulations for compressible gas flow through orifices and converging-diverging nozzle are also used when appropriate. However, regardless of the specific formulation all node-to-node flow calculations are intrinsically rooted in the principle of the conservation of linear momentum.

Combustion Devices

As with the rest of the engine system represented by homogeneous volumes, the concepts of the conservation of mass and energy must be applied to locations within the engine system that have reacted propellant as well. Equations 3 and 5 derived above still apply to these areas, but more information is

needed to determine the properties associated with a chemical reaction.

Equation 3, the conservation of mass equation, applies only to the total flow. The mass of the various combustion reactants and products is, of course, not conserved in the case of chemical reaction. However, combustion properties are a function of the relative amounts of fuel and oxidizer brought together. There are many ways to state the relative of amounts of fuel and oxidizer. Mixture ratio is usually the term of choice. Mixture ratio is defined as the mass of oxidizer divided by the mass of fuel.

$$MR = \frac{M_{ox}}{M_{fuel}} \quad (8)$$

For transient modeling purposes, this term is not convenient numerically because MR can assume a value of infinity. A better way to express this quantity is in terms of fraction of total propellant. Typically used is oxidizer fraction, OFR .

$$OFR = \frac{M_{ox}}{M_{total}} = \frac{M_{ox}}{M_{ox} + M_{fuel}} \quad (9)$$

For modeling purposes, the value of OFR during transient operation can be determined from the differential form of Equation 9:

$$\frac{\partial(OFR_{CV})}{\partial t} = \frac{(\sum \dot{m}_{ox_{in}} - \sum \dot{m}_{ox_{out}})}{M_{total} - OFR_{CV}(\sum \dot{m}_{total_{in}} - \sum \dot{m}_{total_{out}})} \quad (10)$$

Equation 10, representing the time rate of change of the oxidizer fraction, provides the final piece of data needed to calculate combustion properties. By knowing how much oxidizer is leaving and entering the control volume, the rate of oxidizer accumulation can be determined. This information can then be fed into a standard

Rotating Machinery: Typically consisting of a turbine element and a pump element.

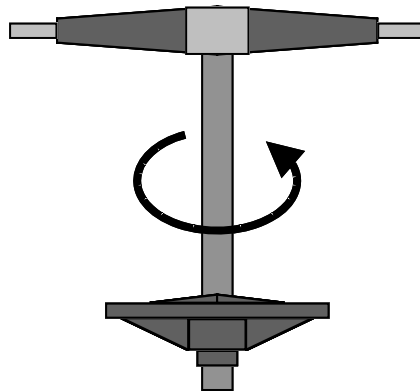

Apply:

- Conservation of Angular Momentum
- Pump and turbine relationships between fluid work and shaft torque

Figure 7, Modeling of rotating hardware element of turbomachinery

chemical equilibrium routine [Gordon, 1971 and 1984] to determine the properties of resultant high-energy chemical reaction products.

Turbomachinery

The other piece of hardware that is typical in high-power liquid rocket engine systems that requires special attention is turbomachinery. The energy transfer accomplished by this machine can be modeled through a focus on the rotational acceleration of the shaft connecting the turbine to the pump. This is illustrated in Figure 7. The angular acceleration of a shaft is determined from the application of the conservation of angular momentum.

$$\frac{\partial N}{\partial t} = \frac{\sum T_{turbine} - \sum T_{pump}}{I} \quad (11)$$

In order to determine the summation of torque moments applied to the shaft, the model must

additionally have information relating fluid property and flow parameters in both the turbine and the pump to values of torque. These are collectively referred to as turbomachinery maps. The determination of these maps is largely an empirical matter the details of which are left to the component developers.

Integration and Solution

With all of the necessary governing equations derived for the various elements of the engine system, the next step becomes the generation of a numerical means of solving these equations.

Upon first impression, performing an explicit Eulerian integration of the state equations would appear to be the most straightforward way of completing the transient analysis. This would consist of stepping through time using the conditions of the previous time step to drive the calculations in the current time step.

However, in practice, the time step used for such an integration scheme must be very small. Larger time steps can be taken by using implicit methods. One such approach is the trapezoidal integration as represented in Equation 12.

$$(12)$$

Other similar schemes are also considered. It should be noted that an iteration loop is required as the part of such a scheme because the value of the state at the new point is a function of the derivative evaluated at the current point, which requires knowing the value of the state at the new point. For this reason, the state is iterated until the guessed value is equal to the predicted value.

It has been found that using density and the fluid internal energy, the two most obvious

choices, as the iteration parameter can be numerically unstable. Instead, pressure and enthalpy are used as the iterated state variables. This scheme works so long as density and internal energy can be determined from pressure and enthalpy. However, because pressure and enthalpy are independent properties, this obstacle is easily overcome.

Fluid Properties

A critical element of transient modeling of liquid rocket engines is the utilization of accurate fluid properties. Through the derivation of the governing conservation equations all of the various fluid properties existing as variables within the equations remain generic with no tie to actual propellants. It is through the use of accurate fluid property routines that the transient model is transformed from a mathematical exercise

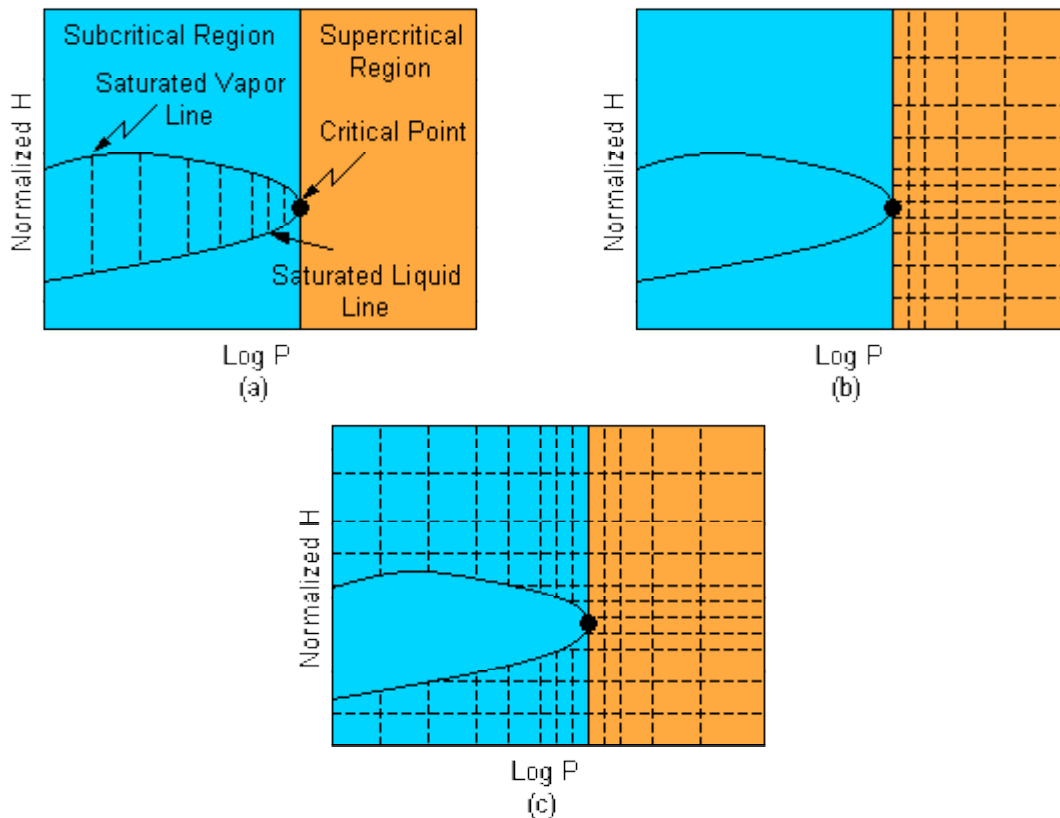

Figure 8, The creation of a grid across the state space for a fluid

to a representation of an actual engine. With this in mind, a great deal of effort has been spent, and continues to be spent, in the creation of efficient and accurate and usable property routines. This section describes a recent effort in which property tables in and around the region of propellant phase change were developed in a unique way.

Real fluid properties were generated using the widely available GAPAK (© copyright Cryodata Inc.) routine by using pressure and enthalpy as input values. Other available routines besides GAPAK could be utilized in the process, such as GASP [Hendricks, 1975] for example, since the process itself is generic even if the generated tables are quite specific. The fundamental goal of this effort was to minimize the number of pressure-enthalpy values necessary to generate property tables that fully described the fluid. To accomplish this, a program was created which indirectly allows the user to determine how many pressure-enthalpy pairs are necessary in order to achieve a prescribed interpolation error. Thus, the desired accuracy of the results across the region of fluid properties considered is used to determine the expanse of the tables generated.

First, the program goes through saturated liquid and vapor lines to determine the necessary number of pressure points and their values so that the interpolation error would be within the specified error. This is illustrated in Figure 8a. The property data is divided into two regions: sub-critical and supercritical. After obtaining the pressure values for saturated lines, the program then determines pressure-enthalpy values for the supercritical region as shown in Figure 8b. For the sub-critical region, the pressure values are the same as the pressure values of the saturated lines, and likewise the enthalpy values were the same as the enthalpy values of the supercritical region as in Figure 8c.

For the supercritical region, a regular linear interpolation routine can be used to retrieve property data from the property tables; however, for the sub-critical region, a special interpolation routine is required for cases where one or more data points were inside the phase-change dome. A new interpolation routine was derived to handle both sub-critical and supercritical regions. Figure 9 shows fourteen possible cases near the saturated lines where the special interpolation routine is

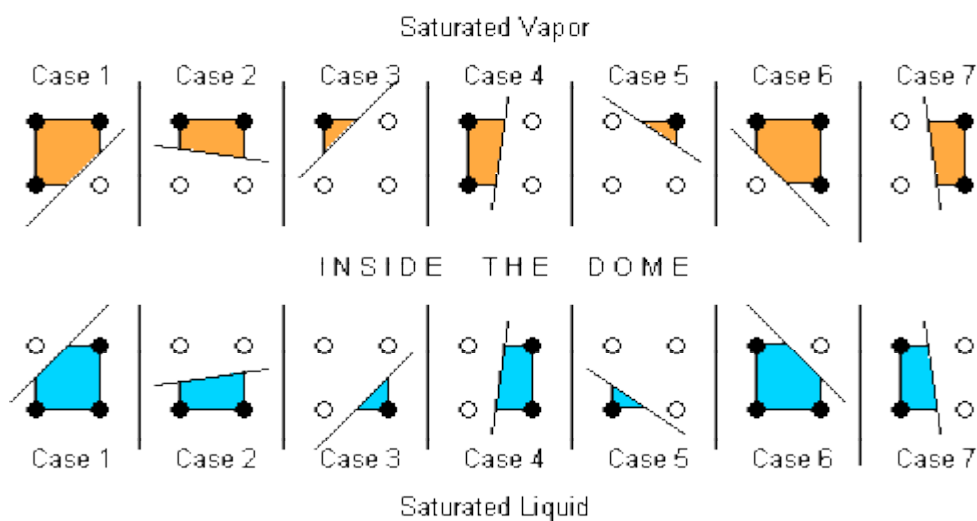

Figure 9, Special interpolation situations around the liquid and vapor saturation lines

required in order to retrieve reasonable property data from the generated tables. For example, Case 2 represents situation straddling the saturated vapor line. The bottom 2 data points within the interpolation rectangle (unshaded) lie inside the phase-change dome; therefore, they will not be used in the interpolation process. Instead, only the top 2 data points (shaded) are used along with data along the saturated vapor line. In this manner the inherent errors associated with using linear interpolation around a zone of discontinuity can be avoided.

Numerical Solution Issues

The application of the conservation equations and the first law of thermodynamics as described above results in a system equations that must be solved in order to define the state of the engine at each point in time. The method currently used at NASA MSFC for doing this is based on the Newton-Raphson scheme as applied to a system of non-linear equations. Newton-Raphson requires the generation of a Jacobian matrix – a collection of the slopes of the equations with respect to each parameter being iterated. These derivatives are determined analytically by individually perturbing each variable and measuring the response of the system of equations to that perturbation. This Jacobian matrix is then used by the solver to iterate the variables until convergence. The theory of Newton-Raphson is well documented; however, in practice, several problems can arise.

One such problem is that the Jacobian is only valid at the initial values of the independents. As the solution progresses, the Jacobian matrix will change. Evaluating the Jacobian is costly in terms of computational resources. For this reason, reevaluation of the Jacobian as the solution progresses is not feasible. This problem is overcome by making use of the

Broyden technique [Broyden, 1965]. This is a technique to evolve the Jacobian matrix during solution progression.

In order to overcome issues of numerical stiffness, convergence of the system is determined based on percent errors, not absolute errors. This in turn creates a problem when the variable being used in the denominator of the percent error equation approaches zero. In practice, this obstacle is overcome by using normalizers. A normalizer is essentially a limit placed on the denominator to prevent it from going to zero. However, when a normalizer value is invoked, the percent error starts to approach an absolute error, as opposed to a percent error so this process must be invoked with considerable care.

When modeling a transient fluid network, progress in the solution through time is made using a time step, or dt . If the dt is too small, the solution takes an excessive amount of time to progress. However, if the dt is too large, the iterations may fail or the results may contain errors. Thus, a balance must be struck between these two extremes. However, even after recognizing this need for balance there exists the problem that the required dt may change depending on what is happening at that time (valves opening/closing, ignition events, etc.). There are no rigorous methods to determine to optimum dt . However, one method used to gauge the time step relative to the system is the concept of the time-constant. The time-constant of a control volume is the mass stored in the volume divided by the flow rate through the volume ($\tau = M/\dot{m}$). This term is a rough approximation of the time a fluid particle resides within the control volume. It is also a measure of how quickly the volume responds to changes. The time constant can be employed to determine if the dt is within the correct order of magnitude. If the time constant of a control volume is much

smaller than the time-step being used, this implies that the changes to the control volume may not be sufficiently captured by the time-step. Another technique is automatic dt reduction. When a solution begins to experience convergence problems, the code automatically reduces the time-step to attempt to obtain a converged solution.

Another common problem occurs when flow rates approach zero. Since flow rate is proportional to the square root of the pressure differential, the slope of changes in flow rate as a function of differential pressure approaches infinity when the differential pressure approaches zero. This large slope creates havoc on the Newton-Raphson solution methodology. Typically, to overcome this issue, the flow rate equation is linearized near zero flow (in other words, near zero differential pressure) to create a finite and constant slope in this region.

Future Work

The process of improving transient mathematical modeling capabilities in the future falls into three basic categories:

- Improvements of the usability of the modeling tools
- Improvements to the approximations used in the modeling to represent complex systems
- Improvements to the numerical schemes used to solve the derived equations and developed computer code.

The task of assembling a complete mathematical model of a complex liquid rocket engine system is a time-consuming process. The use of a modular format for pieces of modeling code that apply to particular hardware elements is well established and is of great utility. However, the text-based format currently used at NASA

MSFC for the assembly of these modules is not easy or quick. To overcome this limitation, work has begun on the development of a graphical users interface (GUI) for this initial assembly procedure. It is hoped that the use of GUI will cut down the basic assembly time and allow analysts to spend a greater amount of time dealing with the more technical aspects of their modeling tasks.

The complex environments contained within liquid rocket engine components require that the analyst make approximations of reality in order to generate a solvable problem. One area where improvements are being made to this approximation is in the combustion devices. Engineers at NASA MSFC are developing a Generalized Combustion (GCOMB) approach that can determine the effective mixed properties of multiple constituents within a volume. This is of particular importance in volumes potentially containing combustion reactants, combustion products, and inert gas purge flows. This overcomes many limitations of previous methods wherein artificial volumes were sometimes added to account for purge flows and real fluid properties could not be used throughout the transient operation regimes being modeled.

And finally, work is being pursued in the area of using more advanced computational and mathematical techniques in the solution of the nonlinear sets of equations used to represent the liquid rocket engine system. In coordination with industry partners and experts from academia, and with support from our Air Force partners, NASA MSFC engineers are examining a number of advanced methods. These include line back-search applied to the currently used Newton/Broyden method [Press, 1986] (pictured in Figure 10), simulated annealing,

NUMERICAL EXPERIMENTS

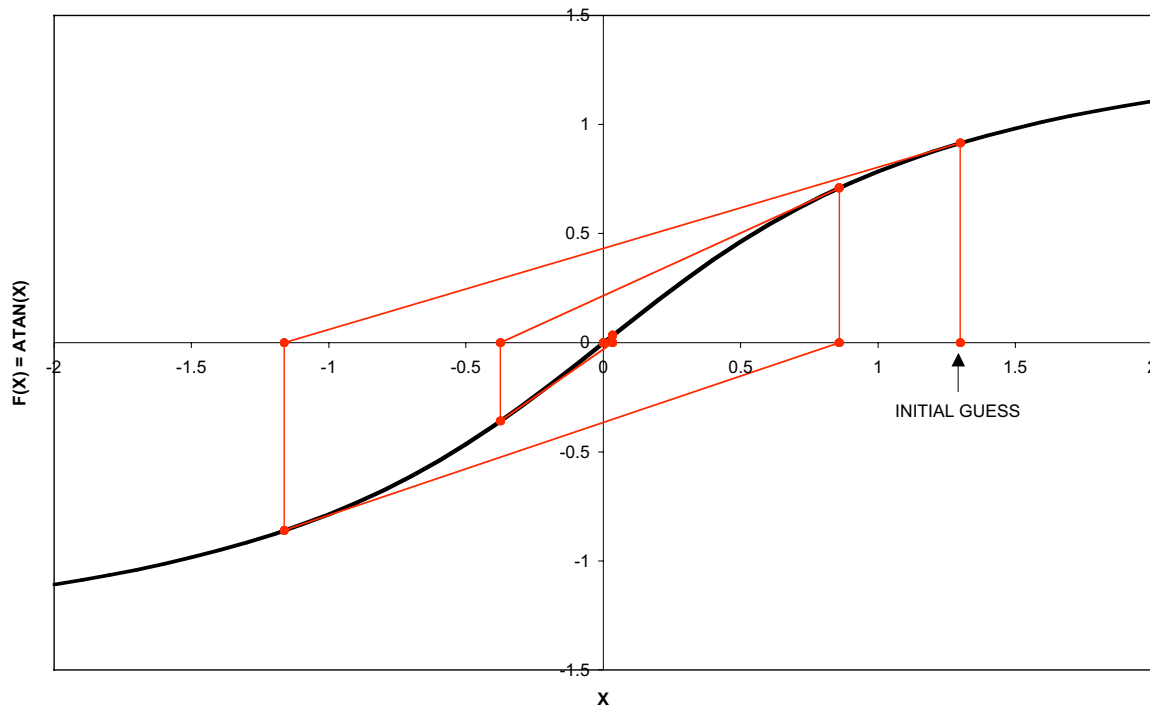

Figure 10, Line back-search method (backtracking) applied to Newton/Broyden method

embedding procedure for parametric solutions, and various genetic algorithms.

Summary / Conclusions

The subject of liquid rocket engine system transient modeling could, if covered in detail, fill several entire textbooks. The reader is directed to the Additional Reading section for just such treatments. It was the purpose of the authors here to present some of the basic principles and some clear rationale why this subject is such a vital aspect of liquid rocket engine development and utilization. Whereas rocket engines are designed to perform at steady state conditions, the only way to get to and from that point is through the potentially treacherous processes of engine start and engine shutdown.

In the past, before the widespread use of high-speed computers, many liquid rocket engine

programs relied on the process of trial and error in developing start and shutdown sequences. Obviously, this approach can work but it is costly, time consuming, and can often result in multiple hardware failures. Further, such an approach cannot fully explore all of the hypothetical failure scenarios that might be lurking just on the edges of nominal performance. Only through the use of transient simulation can these shortfalls be overcome.

However, even with the use of high-speed computers and even with the basic physics of the problem well established, the task of the analyst is hardly straightforward. Every system is unique and presents special challenges. Because any mathematical modeling task is intrinsically a process of making reasonable approximations of reality, the analyst must constantly reevaluate the sufficiency and completeness of his

approximations. This is most effectively accomplished through the analysis of available test data to properly ground the model developed. Further, the analyst must pay attention to the intrinsic limits of the numerical algorithms used and the solution schemes employed.

As the liquid rocket systems of the future are proposed and developed, the task of transient modeling of these systems will likely become more and more important. The process of improving the tools used for this task is an ongoing project being undertaken by the engineers at NASA MSFC.

Acknowledgments

The authors would like to sincerely thank Mr. Bruce Tiller for his invaluable input and oversight regarding this paper.

References

Broyden, C.G., 1965, "A Class of Methods for Solving Nonlinear Simultaneous Equations," Mathematics of Computation, Vol. 19, pp. 577-593 (American Mathematical Institute, 1965).

Gordon, S. and McBride, B.J., "Computer Program for Calculation of Complex Chemical Equilibrium Compositions, Rocket Performance, Incident and Reflection Shocks, and Chapman-Jouquet Detonations," NASA SP- 273, 1971.

Gordon, S., McBride, B.J. and Zeleznik, F.J., "Computer Program for Calculation of Complex Chemical Equilibrium Compositions and Applications Supplement I -Transport Properties," NASA Technical Memo-86885, Oct. 1984.

Hendricks, R.C., Baron, A.K., and Peller, I.C., "GASP - A Computer Code for Calculating

the Thermodynamic and Transport Properties for Ten Fluids: Parahydrogen, Helium, Neon, Methane, Nitrogen, Carbon Monoxide, Oxygen, Fluorine, Argon, and Carbon Dioxide," NASA Technical Note D-7808, Feb. 1975.

Press, W.H., Flannery, B.P., Teukolsky, S.A., and Vetterling, W.T., Numerical Recipes, The Art of Scientific Computing (Cambridge University Press, 1986).

Additional Reading

Blevins, R.D., Applied Fluid Dynamics Handbook (Keiger Publishing Company, 1992)

Hodge, B.K., Analysis and Design of Energy Systems (Prentice-Hall, Inc., 1990).

Huzel, D.K., and Huang, D.H., Modern Engineering for Design of Liquid-Propellant Rocket Engines (American Institute of Aeronautics and Astronautics, 1992).

Sutton, G.P., Rocket Propulsion Elements: An Introduction to the Engineering of Rockets (John Wiley & Sons, Inc., 1992).

White, F.M., Fluid Mechanics (McGraw-Hill Book Company, 1979)