

Using CFD as a Rocket Injector Design Tool: Recent Progress at Marshall Space Flight Center

Kevin Tucker, Jeff West, Robert Williams, Jeff Lin, Francisco
Canabal, Marvin Rucker, Bryan Robles, Robert Garcia
NASA

Marshall Space Flight Center
Huntsville, AL

James Chenoweth
CRAFT Tech
Huntsville, AL

**FIFTH INTERNATIONAL SYMPOSIUM
ON LIQUID SPACE PROPULSION**

Long Life Combustion Devices Technology

Chattanooga, Tennessee

October 27-30, 2003

- **Background on Issues Related to using CFD as an Injector Design Tool**
- **MSFC Vision for CFD as an Injector Design Tool**
- **How Do We Accomplish this Vision for Injector Design?**
 - **Parallel Efforts in Program Support & Technology Development**
 - **Key Roadmap Concepts**
- **Simulations for Program Support**
- **Validation Process**
 - **Issues**
 - **Current Data Acquisition Efforts**
- **Summary**



Why Use CFD as an Injector Design Tool?



**The NGLT Program is focused on improved hardware reliability
& reduced costs**

Requires better understanding of environments

- Historical tools focus on:
 - Performance first
 - Environments second (typically 1-d)
- Environments are almost always multi-dimensional
- **American designers are inexperienced with NGLT engine cycle**
 - Empirical tools based on historical databases
 - These tools/databases apply only marginally to NGLT injector concepts

Meeting NGLT goals requires new injector design tools



What Are the Major Obstacles to Using CFD as an Injector Design Tool?



1. Inability to model details of the physics and geometry

- Ideal gas, simple chemistry and turbulence assumptions are typical
- Most solutions are axisymmetric
- Very few 3-d, multi-element solutions

2. Slow solution turnaround time

- Many solutions must be accomplished early in the design phase
- For injectors, a few single element solutions are done in this time frame

3. Lack of demonstrated accuracy

- There is no agreed upon validation process
- Very little quantitative validation work has been done
- Relevant data at appropriate conditions is scarce



Injector design tools are in a transitional period between exclusive use of empirically-based tools and extensive reliance on CFD. Currently--

- Legacy tools are still overwhelmingly used
- CFD is not typically in the original design plan, budget or schedule
- CFD is mostly used for qualitative trend analysis focused on a specific issue
- CFD is sometimes used in the "there is no other option" mode
- Occasionally CFD is used to provide improved inputs to classical analysis tools (e.g., combustion stability)



Overall MSFC/TD64 Vision for use of CFD in Combustion Devices Design:

To enable the use of CFD for Simulation of Preburners, Ducting, Thrust Chamber Assembly and Supporting Infrastructure in terms of Performance, Life, and Stability so as to affect the design process in a timely fashion.

•Injector design is the heart of this overall goal

- Injector design details and physical processes occurring here govern:
 - Performance
 - Environments in the entire combustor or TCA
- Large parametric spaces for both single and multi-element injector issues must be explored to insure a reliable robust design

Generic CFD-Based Single Element Injector Design & Optimization Process

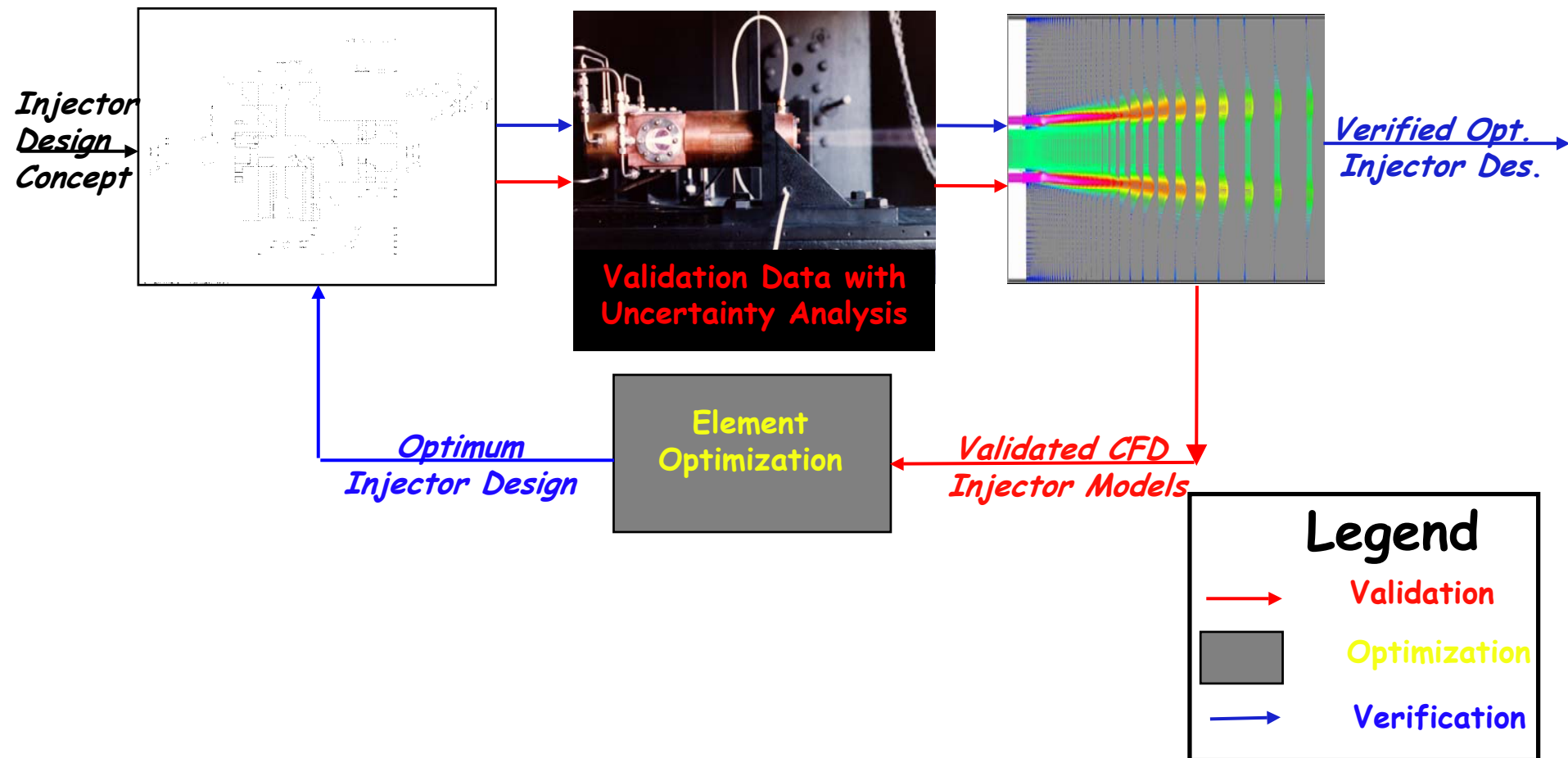

- Marshall is a Space Flight Center, so we must support Programs with the current, albeit limited capability for injector design
- Concurrently, CFD simulation capability improvements must be made in at least 3 areas:
 1. **Fidelity**-the ability to model the key details of the physics and geometry
 2. **Robustness**-solution turnaround must be sufficient to cover a large parametric space of independent design variables and operating conditions
 3. **Accuracy (demonstrated)**-we must be able to quantify accuracy; both current and threshold level for design

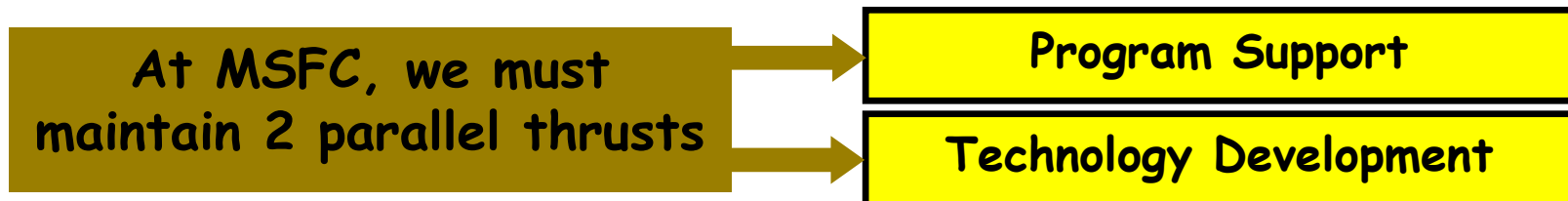

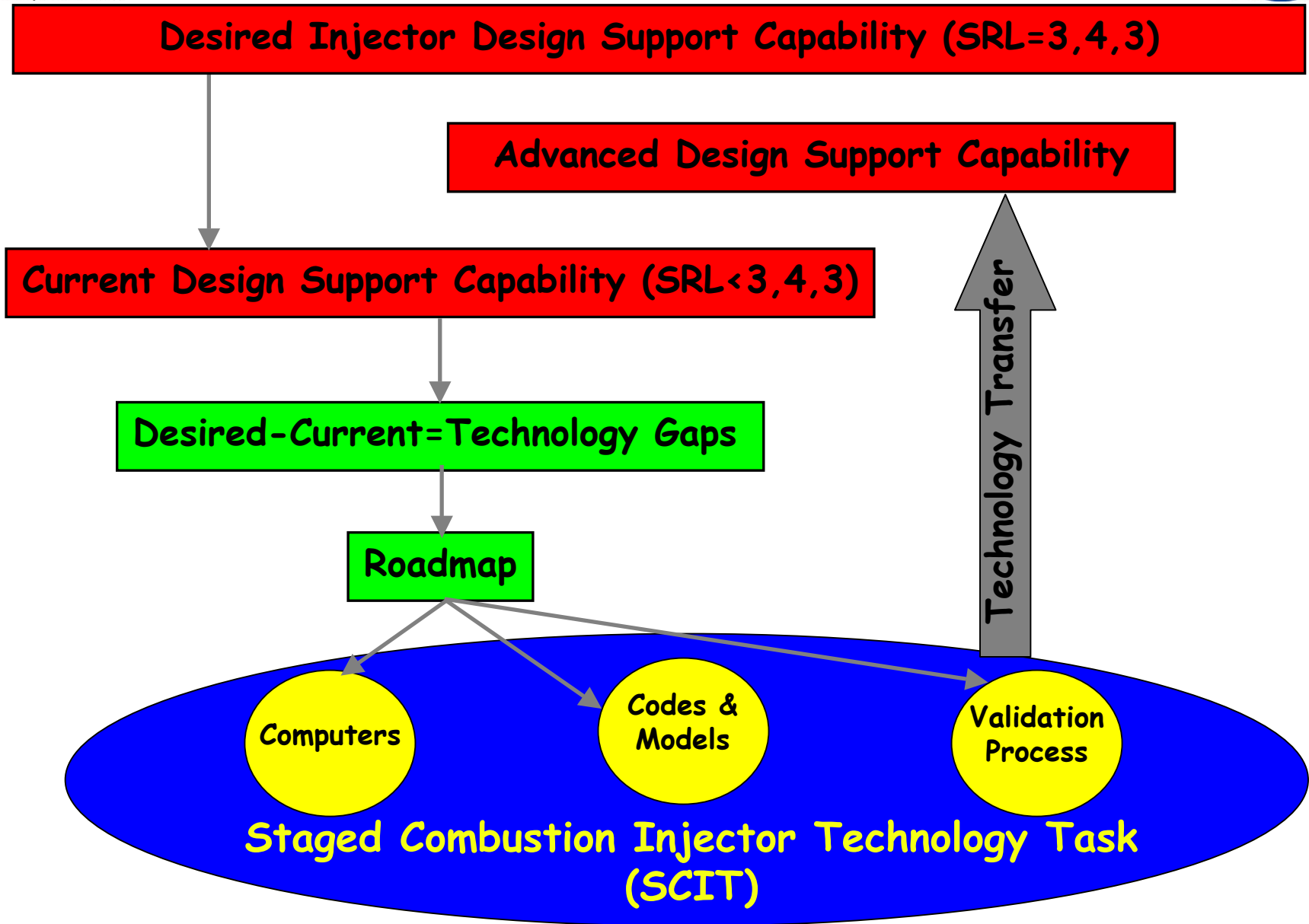



CFD-Based Single Element Injector Design & Optimization Process-Including Technology Inflow



CFD-Based Single Element Injector Design & Optimization Process

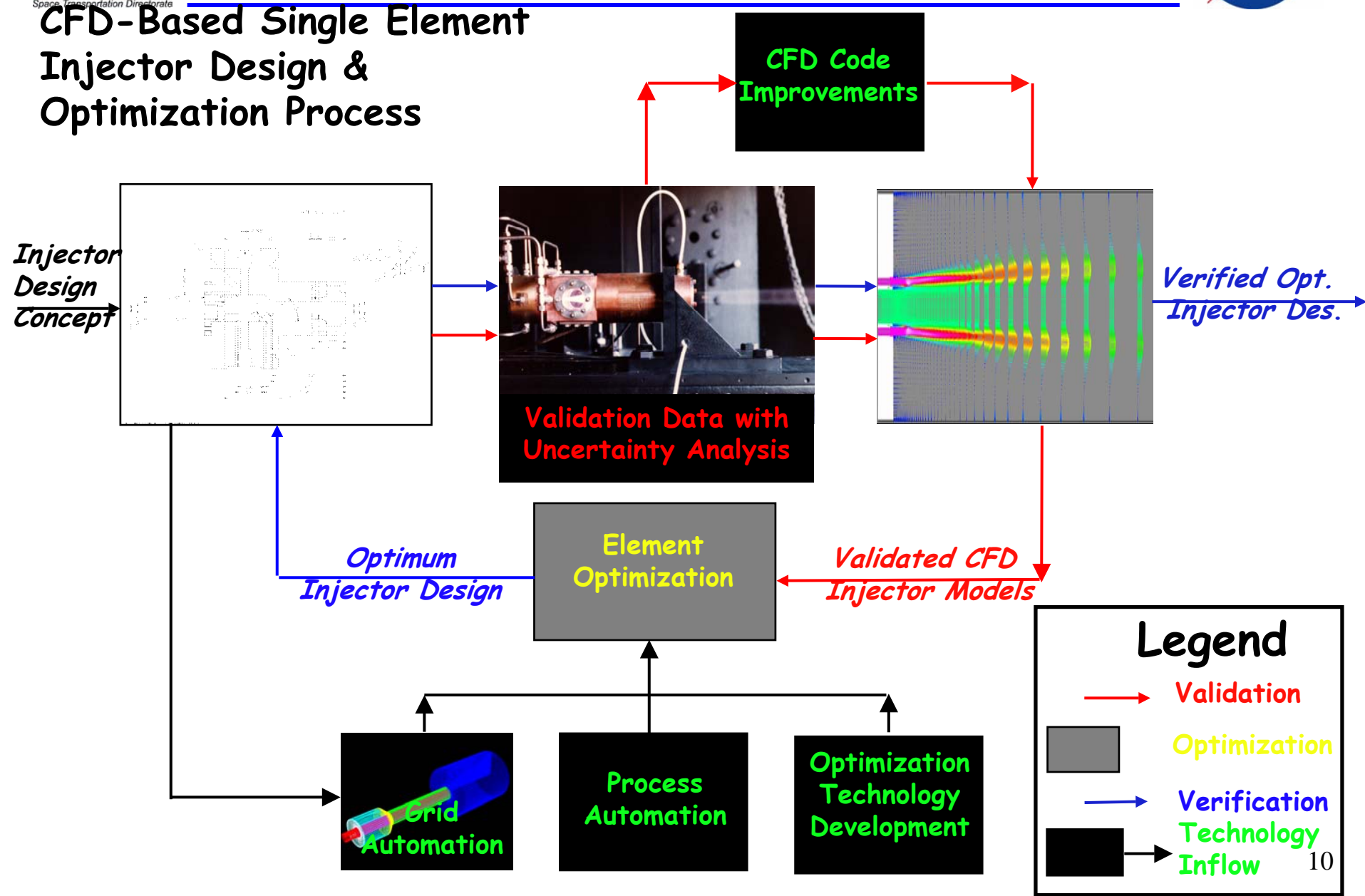

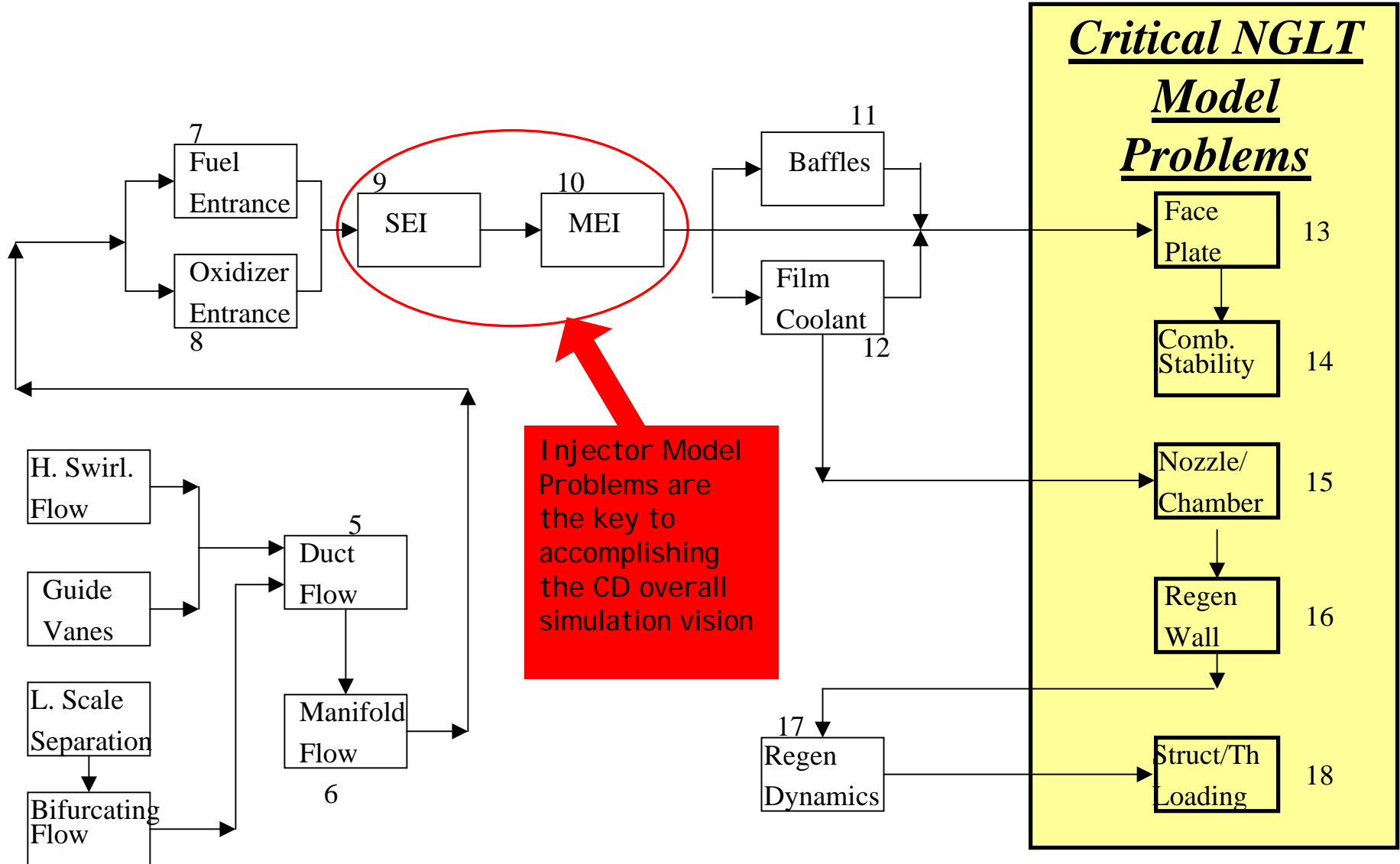

9.1 Steady

9.1.1 Supercritical reactants

9.1.1.1 H₂/O₂

9.1.1.1.1 Shear Coaxial*

9.1.1.1.2 Swirl Coaxial*

9.1.1.1.3 Impinger

9.1.1.2 RP-1/O₂

9.1.1.2.1 Shear Coaxial*

9.1.1.2.2 Swirl Coaxial*

9.1.1.2.3 Impinger

9.1.1.2.4 Hybrid *

9.1.1.3 RP-1(cracked)/O₂

9.1.1.3.1 Shear Coaxial

9.1.1.3.2 Swirl Coaxial

9.1.1.3.3 Impinger

9.1.1.4 JP-N/H₂O₂

9.1.1.4.1 Shear Coaxial

9.1.1.4.2 Swirl Coaxial

9.1.1.4.3 Impinger

9.1.2 Subcritical reactants

9.2 Unsteady

9.3 Transient

* Areas of Current Work

Simulation Readiness Level (SRL) SRL=(f,r,a)

Level	Fidelity	Robustness	Accuracy
0	Extremely simple physics, boundary conditions and geometry	Have not completed any simulations	Not evaluated other than historical quality of simulation tool
1	Reasonably precise geometry and boundary conditions, extremely simple physics	Have completed some simulations	Qualitative agreement with existing results of related problems
2	Reasonably precise physics with extremely simple boundary conditions and geometry	Simulations with proven convergence and conservation	Quantitative agreement with existing results of related problems
3	Reasonably precise physics, boundary conditions and geometry **	Simulations with proven convergence, conservation and grid independence	Qualitative agreement of relevant measures for one representative problem **
4	Reasonably precise physics, completely precise boundary conditions and as-built geometry	Fire and Forget (95%+) simulations with convergence, conservation and grid independence **	Qualitative agreement of relevant measures over parametric space of actual problems
5	Completely precise physics, completely precise boundary conditions and as-built geometry	Fire and Forget (95%+) simulations with convergence, conservation and grid independence plus the ability to complete 100 or more problems within 3 weeks	Quantitative agreement of relevant measures over parametric space of actual problem

**** Minimum level for significant design impact**

Current Areas of Program Support

- **Integrated Powerhead Demonstrator**
 - Single Element
 - Multi-Element
- **NGLT ORSC Cycle**
 - TR-107 (single element)
 - RS-84 (single element)

Full Flow Staged Combustion Cycle (H_2/O_2)

- All propellants flow through preburner
- Propellants are gaseous as they enter Main Injector
- Faceplate environment concerns stem from:
 - Faceplate coolant is relatively hot gas
 - Combustion occurs closer to faceplate with gaseous propellants

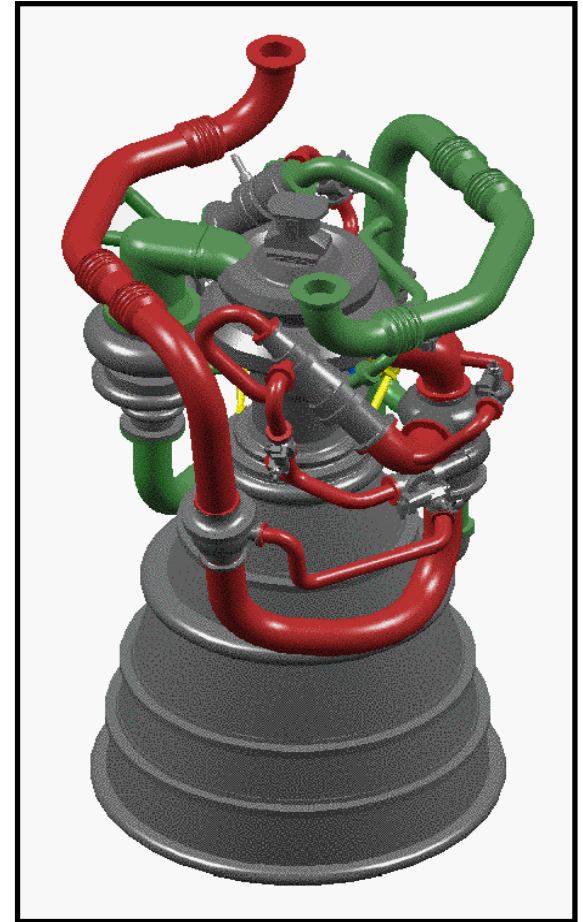

IPD Engine

OBJECTIVE

Starting with a baseline concept, optimize a GO_2/GH_2 element for performance and life (Model Problem 9.1.1.1)

APPROACH

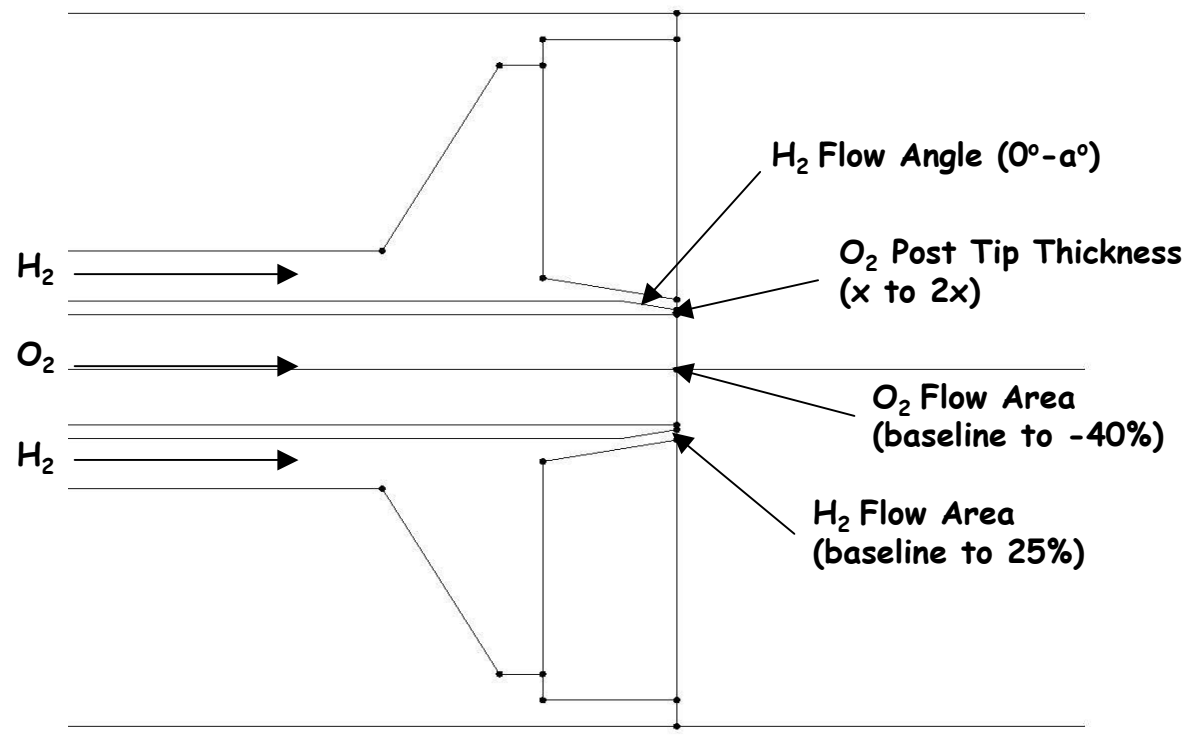

- Generated DOE matrix
- Ran 54 cases
- Constructed Response Surfaces
- Conducted optimization trades with performance & life

RESULTS

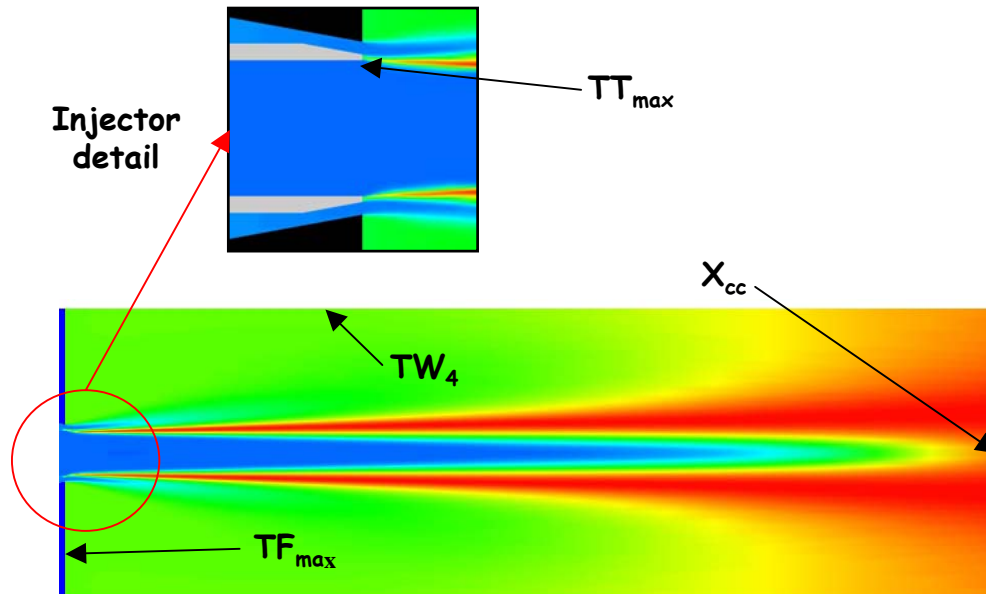

The Boeing Company, US patent 6253539

Simulation Readiness Level

Fidelity-3

➤ Axisymmetric assumption is good

Robustness-5

➤ 54 cases run in one week

Accuracy-1

➤ Qualitative agreement on a similar problem

- All temperatures are life indicators
- The combustion length, X_{cc} , is a performance indicator
- The multi-variable optimization resulted in a different element design than any of the single element optimizations
- Robust design **requires** all relevant independent variables to be modeled early in the design process

OBJECTIVE

Construct a model to evaluate Main Injector and Chamber Wall Environments (Model Problem 10.1.1.1.1)

APPROACH

- Use full scale geometry
- Model must be:
 - Representative
 - Computationally tractable
 - 2 to 4 M grid points

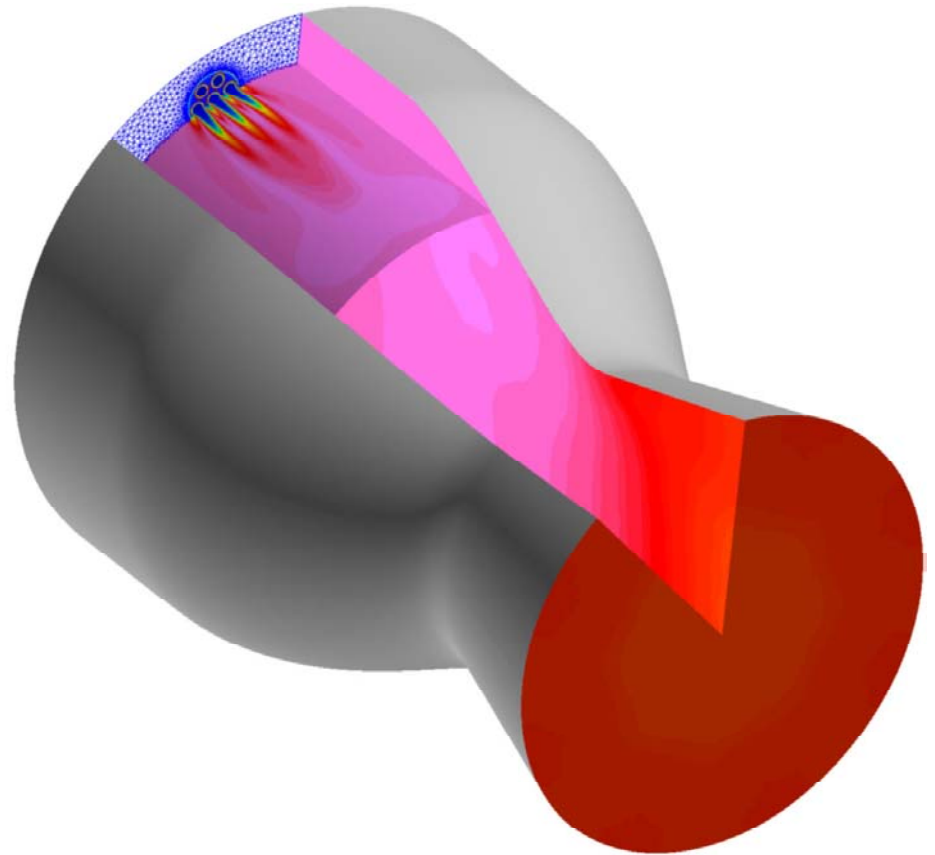

IPD Multi-Element Simulation

RESULTS

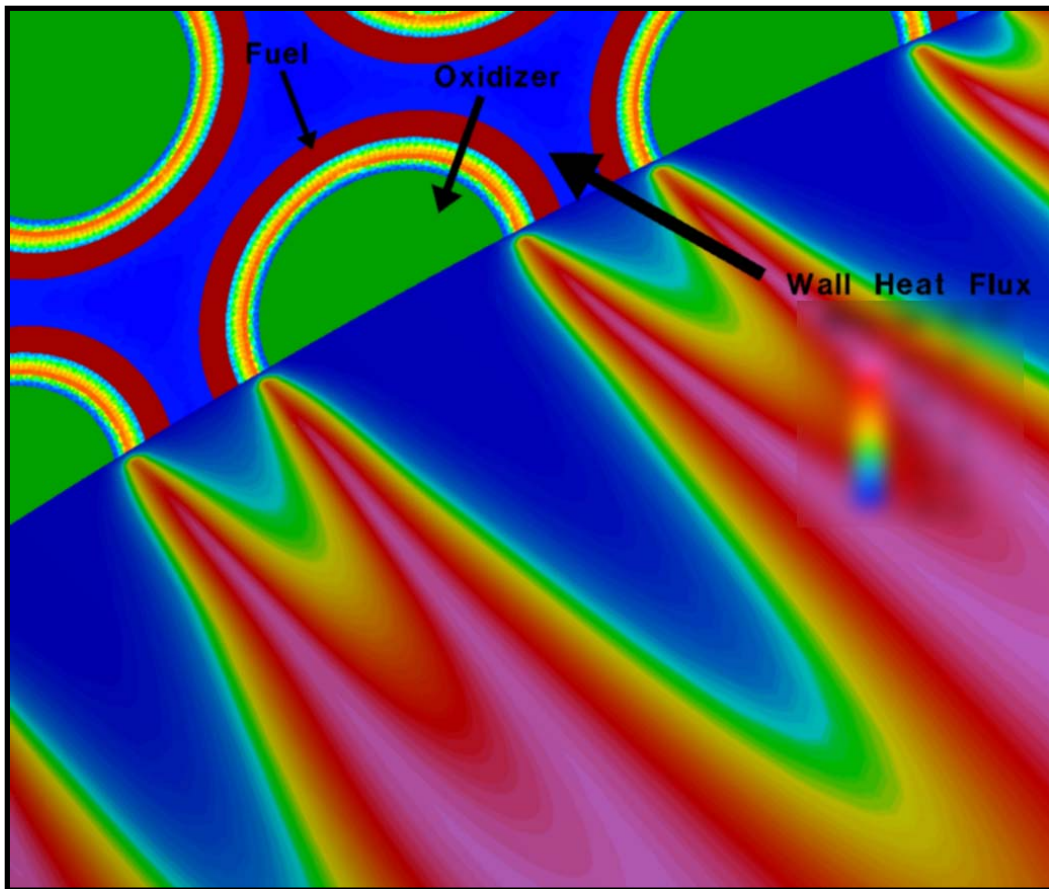

IPD Injector Heat Fluxes and Hot Gas Temperature Field

Simulation Readiness Level

Fidelity-1

- Geometry & BC's extremely simple

Robustness-1

- Only a few cases have been run

Accuracy-0

- No evaluation of accuracy to date

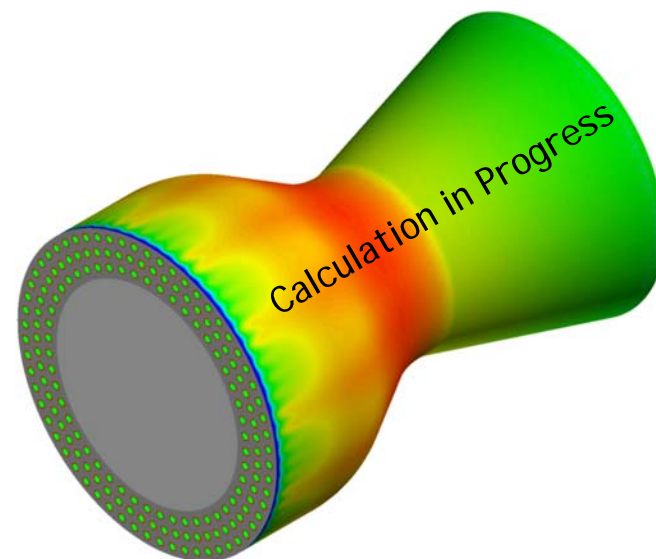



OBJECTIVE

- Construct subscale models to be validated for simulation of large scale combustors
- Use these models to evaluate thermal environments
- Model Problem 9.1.1.2.4

APPROACH

- Start with Single Element, axisymmetric geometry
- RP-1 modeled as ideal gas
- Finite rate multi-step chemistry

RESULTS

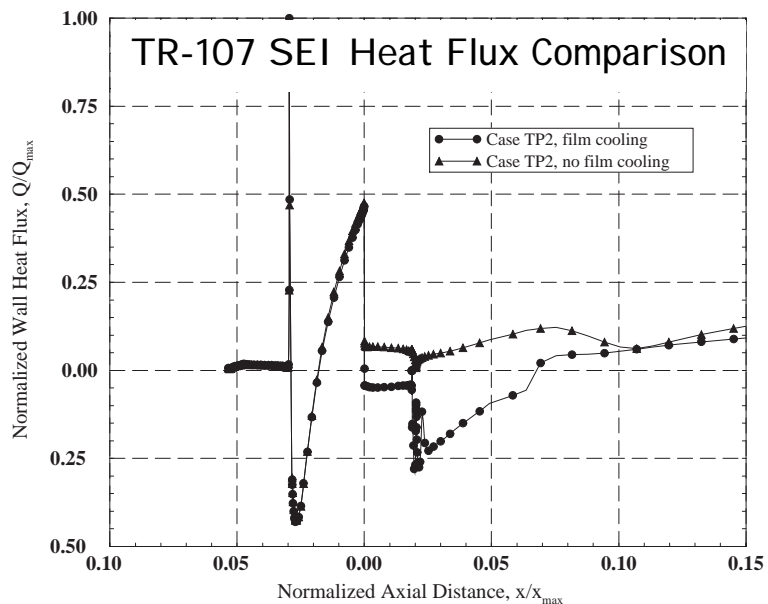

Simulation Readiness Level

Fidelity-0

➤ Geometry & Physics extremely simple

Robustness-3

➤ Many good quality solutions completed

Accuracy-0

➤ No evaluation of accuracy to date

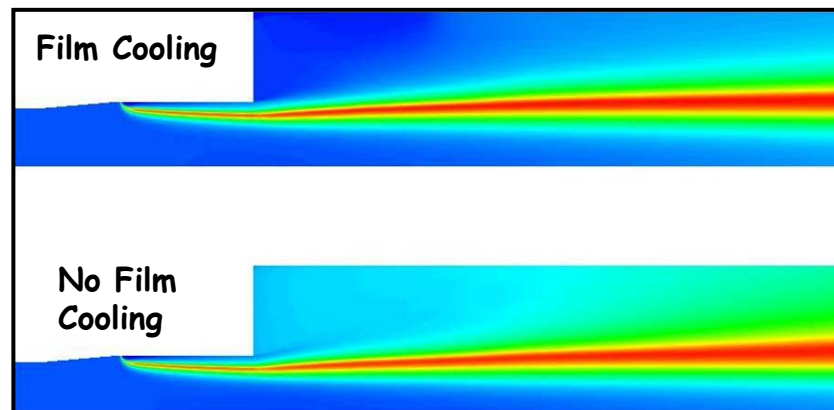
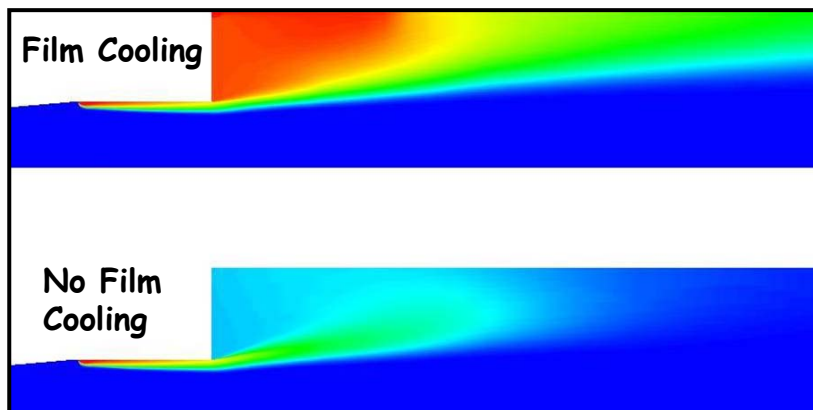

RP-1 Contours

Temperature Contours

OBJECTIVE

- Mitigate design risk by better characterization of thermal environments on baffle elements and on chamber wall
- Model Problem 9.1.1.2.4

APPROACH

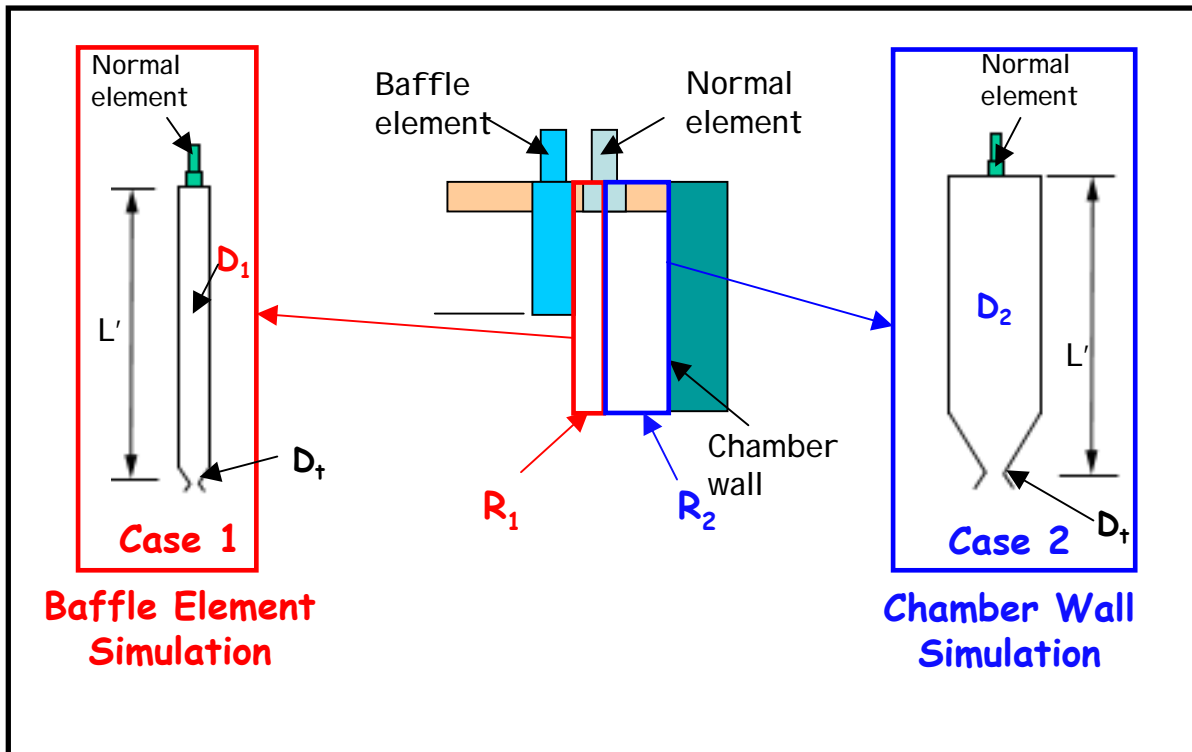

- Start with Single Element, axisymmetric geometry
- RP-1 modeled as ideal gas
- Finite rate multi-step chemistry
- Evaluated different GOX injection schemes
- Evaluated different turbulence models

RESULTS

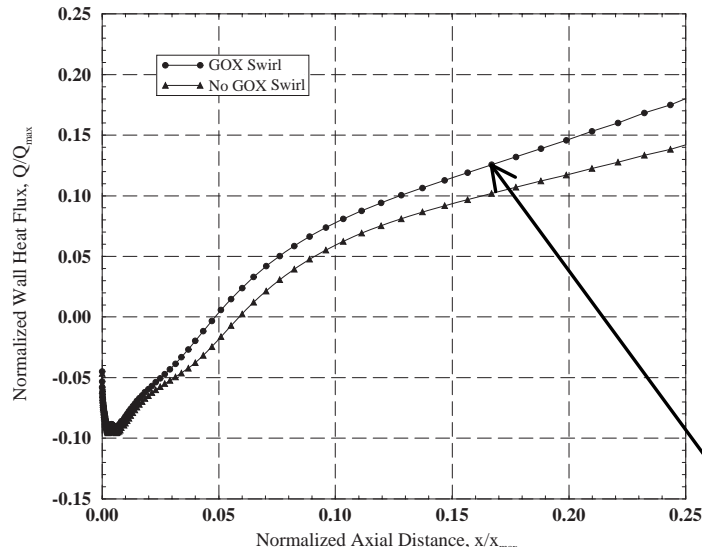

RS-84 SEI Heat Flux Comparisons

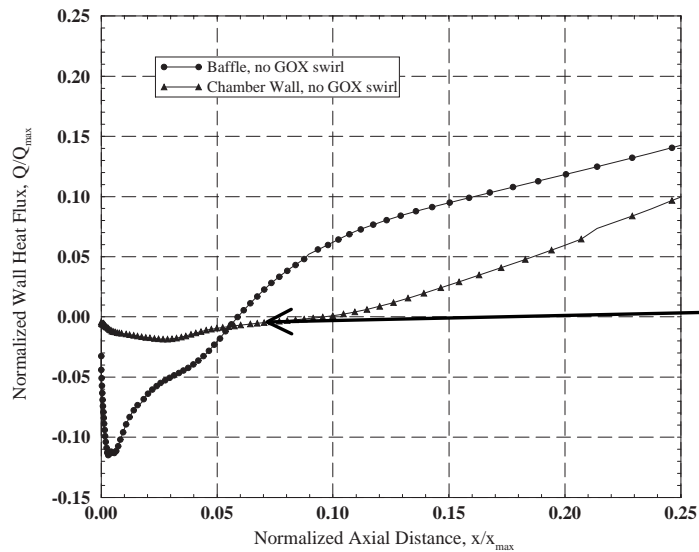

Simulation Readiness Level

Fidelity-0

- Geometry & Physics extremely simple

Robustness-3

- Many good quality solutions completed

Accuracy-0

- No evaluation of accuracy to date

•GOX swirl promotes mixing , thus increasing the near-injector wall heat flux

•Large recirculation zone in the larger chamber mixes gases causing a flat heat flux profile in the near injector region

- At MSFC we can produce injector solutions that:
 - Are grid independent
 - Satisfy the conservation equations

• What next??

- MSFC continues to work to improve codes and acquire computer resources. However--
- Validation of codes to **demonstrate** accuracy for injector flows is the most pressing issue identified to date

Impact of Turbulence Model on RS-84 Heat Flux Results

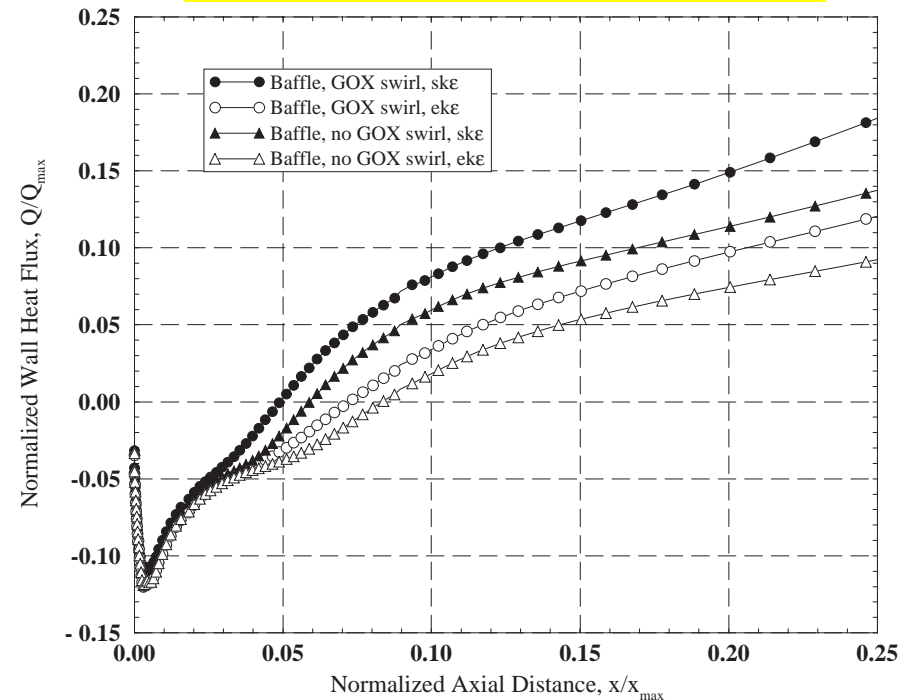

Spread between GOX swirl & no GOX swirl is the same order as between the standard $k\epsilon$ and extended $k\epsilon$ models

Code Validation is a Process

1. Use existing data from related problems (demonstrate accuracy up to level of 2)
2. Acquire additional data (demonstrate accuracy up to level of 5). This requires:
 - Careful experimental planning-including focused CFD analysis
 - Careful experimental execution
 - Use of the new data to demonstrate increased accuracy

In the Experimental Planning Phase --

- CFD must be used to simulate test conditions
- If the code is to be used for design, the experiment must be conducted over a relevant range of independent geometry variables

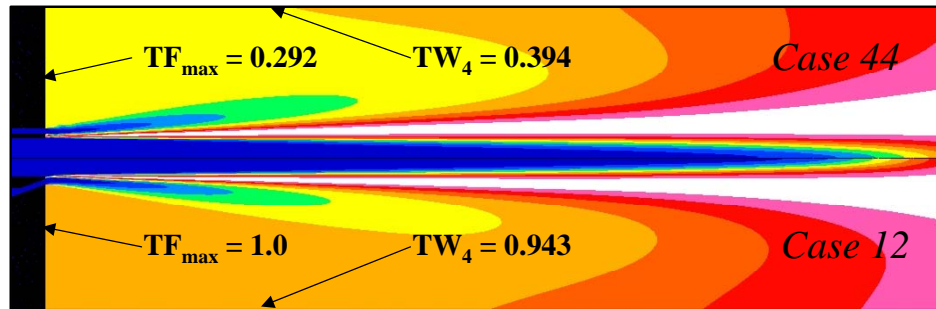

Case 12 performed well, but had the highest wall and injector temperatures

- CFD analysis during planning phase must be used to assess dependent variable ranges in order to select and place instrumentation
- Formal uncertainty analyses of both the facility and the rig must be done to understand, and where necessary, improve data accuracy

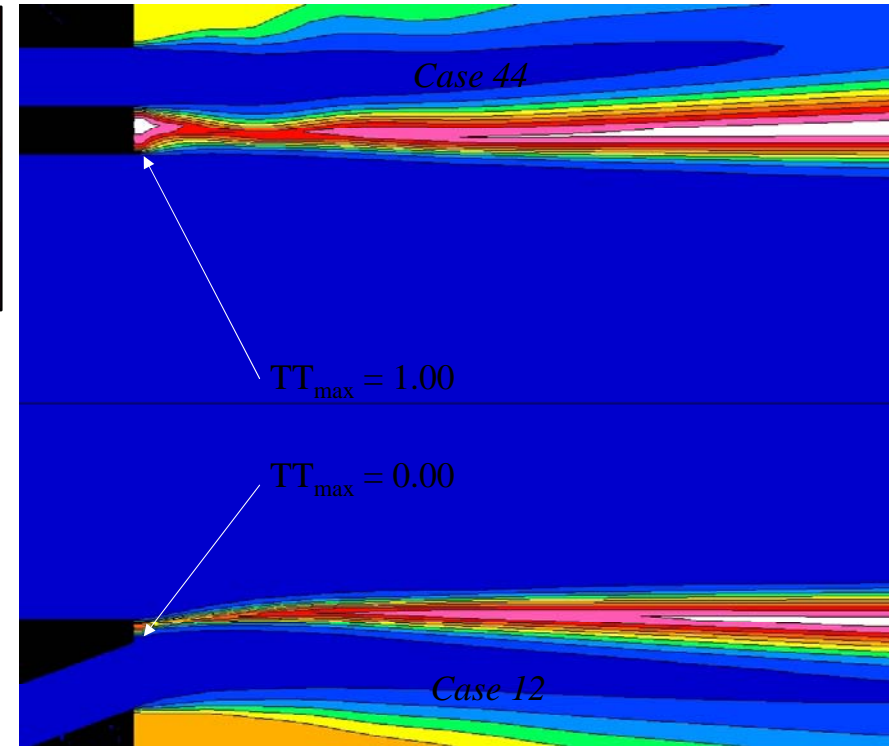

Case 12 also had the lowest injector tip temperature

OBJECTIVE

- To acquire data to validate codes for coaxial GO_2/GH_2 elements (Model Problem 9.1.1.1.1)
- To verify validated CFD codes and optimization techniques

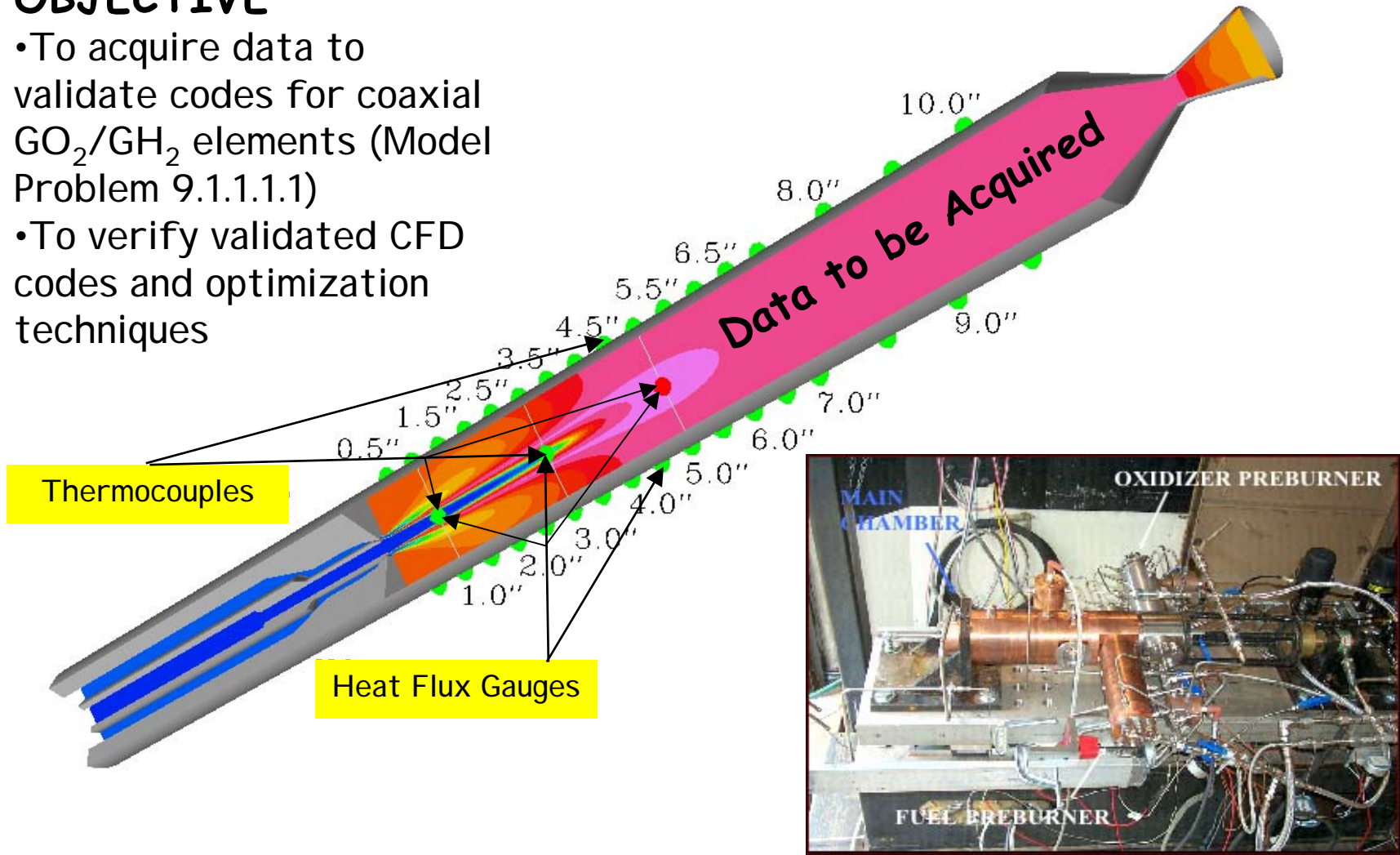

Test Rig at Penn State

Pre-Test CFD Temperature Fields for 5 Different Tip Locations

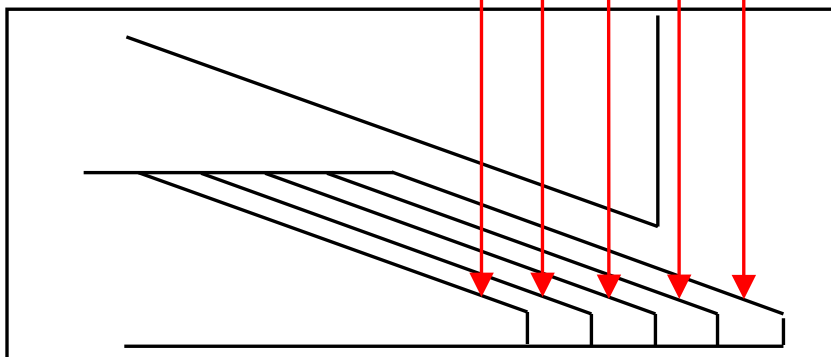
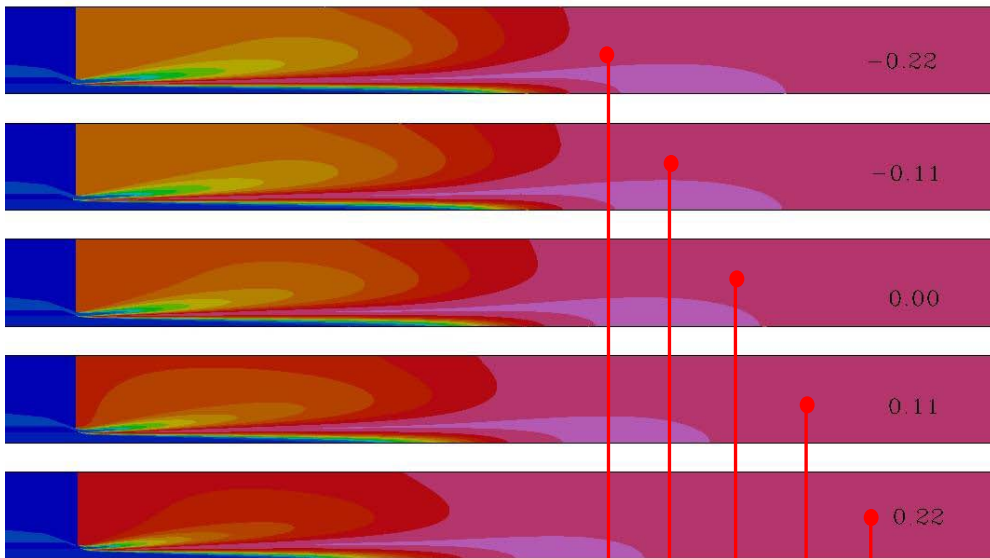

as-built tip geometry



Wall Temperature Profiles for 5 Different Tip Locations

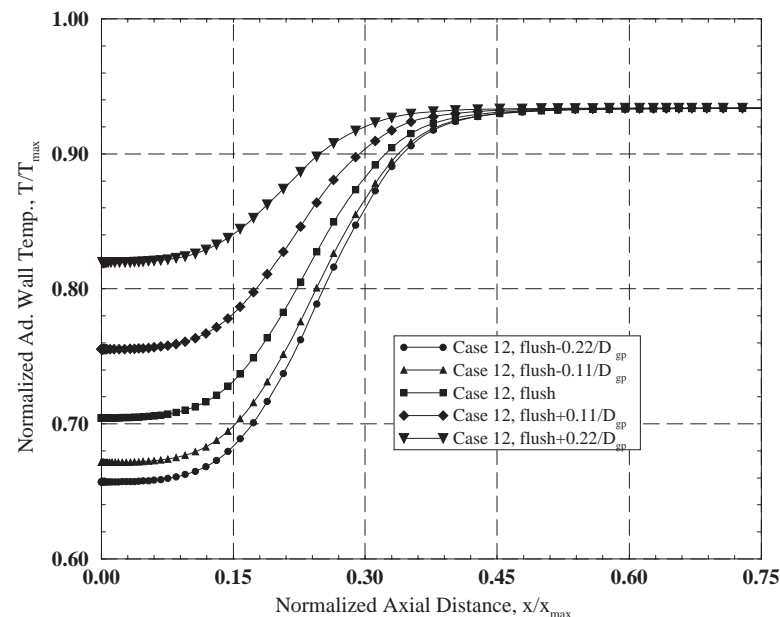

• Demonstrates importance of pre-test simulations

• Also shows knowledge of tip location to be critical

OBJECTIVE:

To acquire data to validate codes for multi-element coaxial LO₂/LH₂ injector (Model Problem 10.1.1.1)

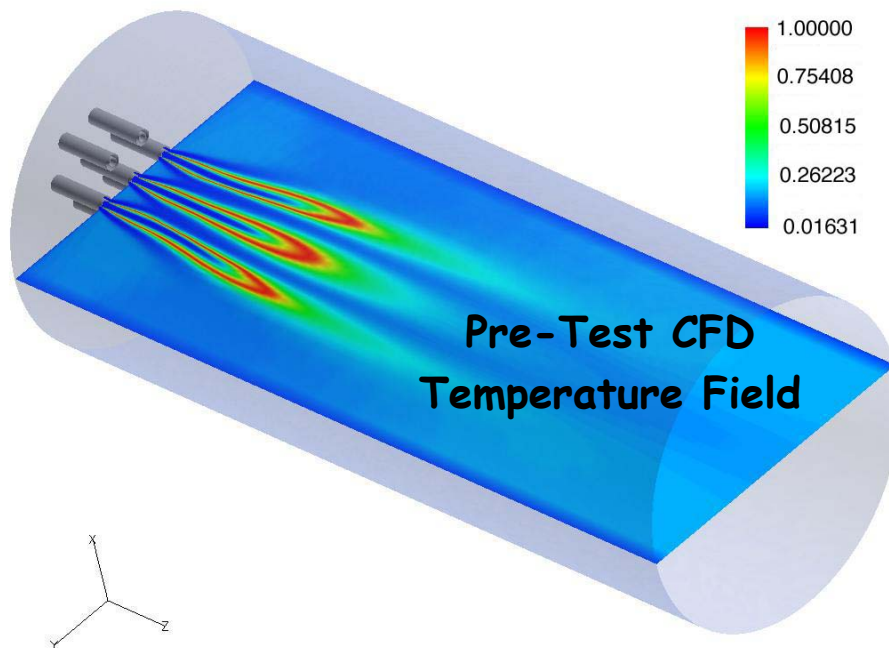
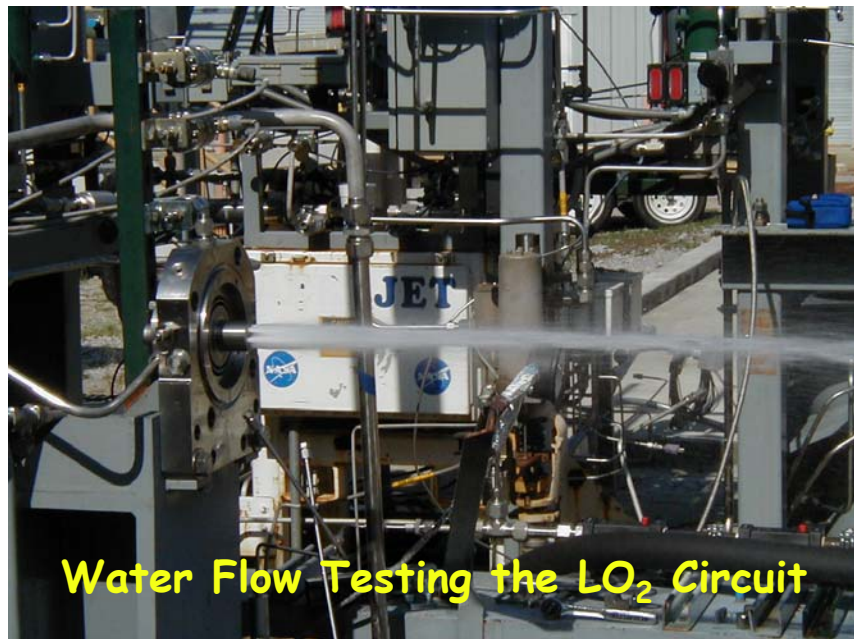

CAD Model of MCTA-One TC Ring Configuration

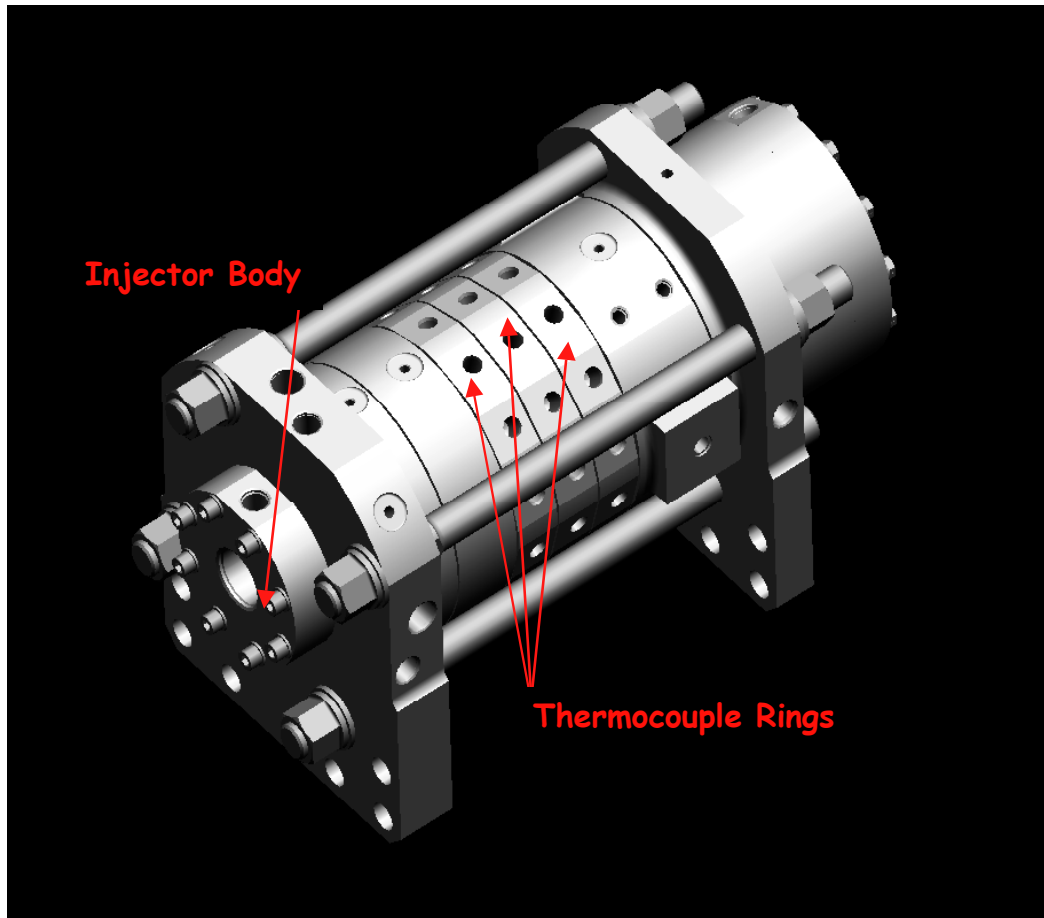

Data to be Acquired

- Spatially resolved temperature field via multiple TC ring configurations
- Shadowgraph near injector
- Wall Heat Fluxes (with calorimeter spool)
- Downstream species and temperatures in chamber and/or plume
 - Emission spectroscopy-Boeing
 - Raman Spectroscopy-Vanderbilt University
- High speed pressure transducers

OBJECTIVE:

To acquire data to validate codes for single -element $GO_2/RP-1$ injector (Model Problem 9.1.1.2.4)

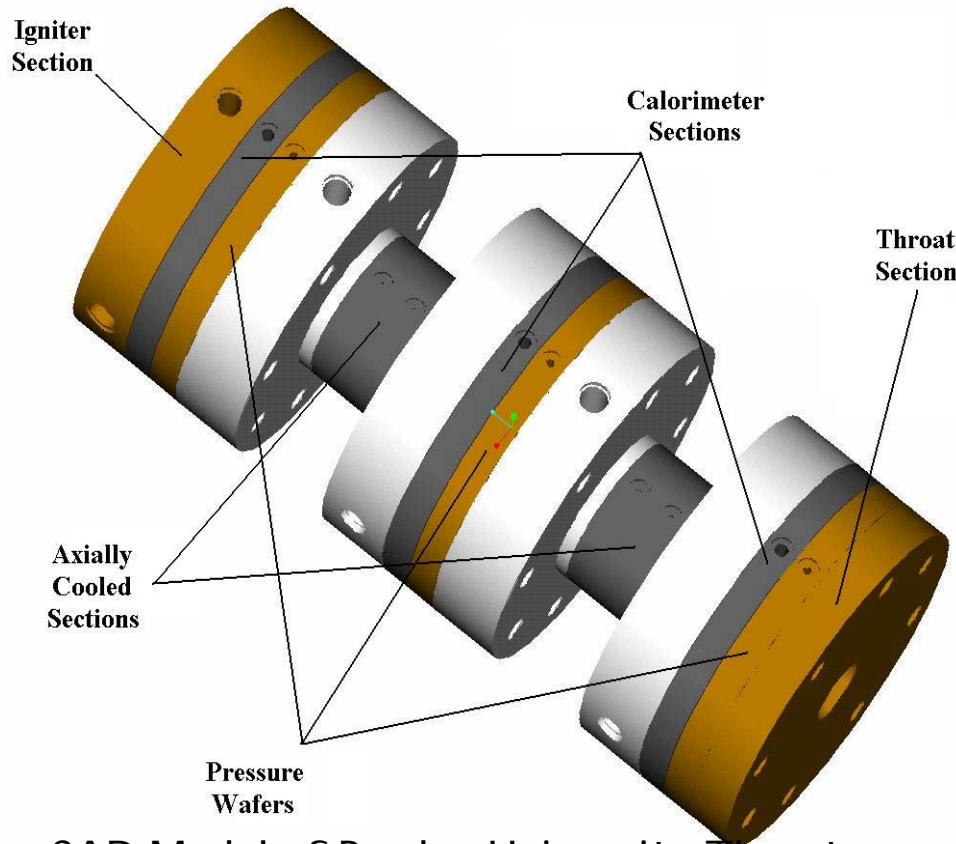

CAD Model of Purdue University Thruster

Data to be Acquired

- Propellant temperatures and pressures
- Near-injector heat flux
- Chamber barrel section heat flux
- Near-injector temperatures
- Chamber axial pressure profile

GO_2

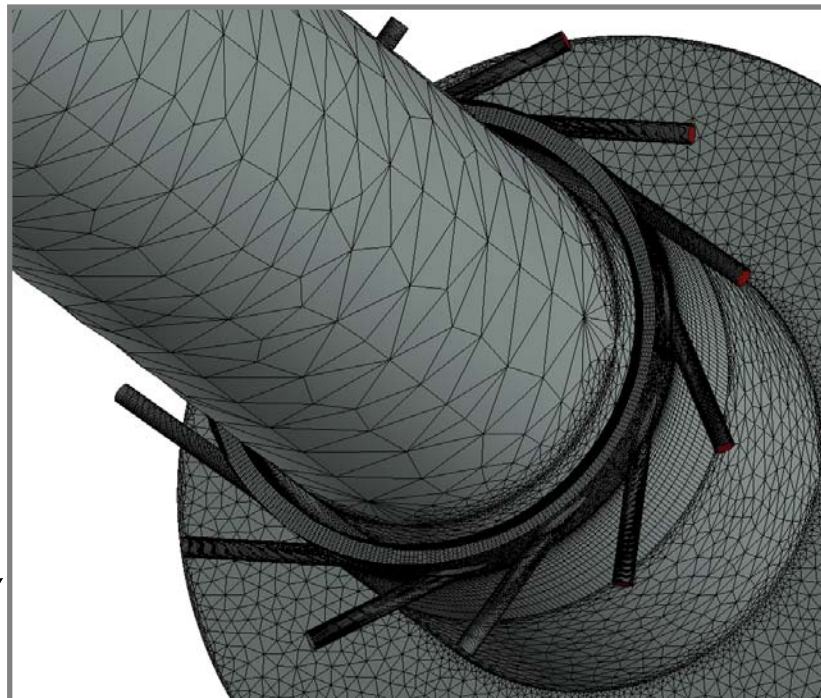

Close-up of RP-1 inlet detail

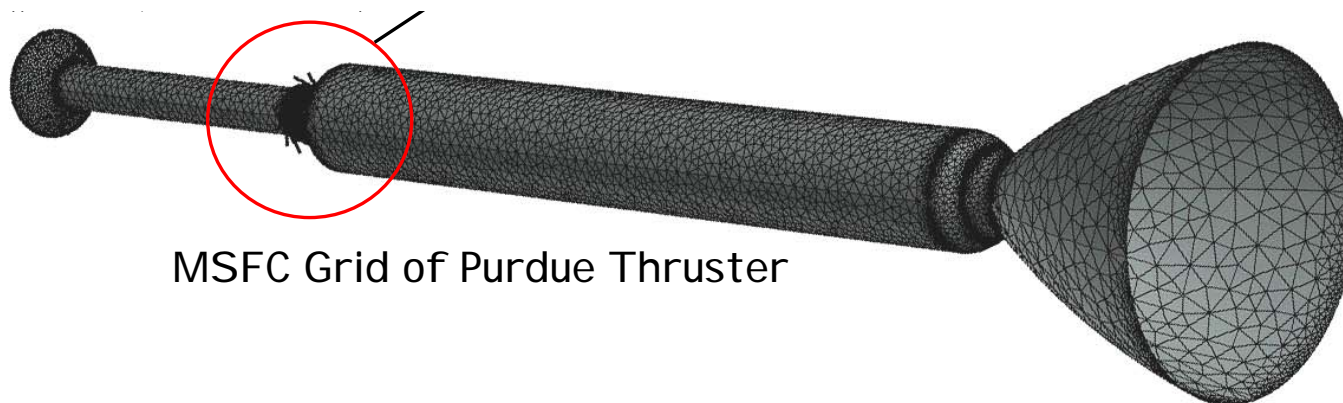

MSFC Grid of Purdue Thruster

- **New programs have generated new design requirements for costs and reliability**
- **Meeting these new requirements demands higher environmental resolution early in the hardware design phase**
- **MSFC has established a vision to meet the need with improved CFD tools**
 - Results in concurrent efforts along two parallel paths
 - Program support
 - Technology development and integration via SCIT Task
 - These two paths are connected by the MSFC CD Simulation Capability Roadmap

- **MSFC is supporting IPD, TR-107 and RS-84 with current capability**
- **SRL's of these efforts indicate a critical need for code validation**
 - MSFC has begun to formulate a validation process
 - MSFC will initiate efforts to use existing data to demonstrate accuracy up to a level of 2
 - Three validation efforts involving new experiments are underway to extend accuracy levels to 3 and above
 - Lessons learned to date include--
 - Good experimental design requires significant CFD support in the planning phase for instrumentation selection, placement, etc.
 - Single design point experiments are not suitable to validate codes that will be used for injector design
 - Uncertainty analysis must be performed on the facility and the test article to quantify and improve the data quality

USING CFD AS A ROCKET INJECTOR DESIGN TOOL: RECENT PROGRESS AT MARSHALL SPACE FLIGHT CENTER

Kevin Tucker, Jeff West, Robert Williams, Jeff Lin, Marvin Rocker, Francisco Canabal, Bryan Robles and Robert Garcia

NASA
Marshall Space Flight Center,
Huntsville, Alabama 35812

James Chenoweth
CRAFT Tech
Huntsville, Alabama

ABSTRACT

The choice of tools used for injector design is in a transitional phase between exclusive reliance on the empirically based correlations and extensive use of computational fluid dynamics (CFD). Without commitment to a focused effort, completion of this transition is several years away at best. The Next Generation Launch Technology (NGLT) Program goals emphasizing lower costs and increased reliability have produced a need to enable CFD as an injector design tool in a shorter time frame. This is the primary objective of the Staged Combustor Injector Technology Task currently under way at Marshall Space Flight Center (MSFC).

The documentation of this effort begins with a very brief status of current injector design tools. MSFC's vision for use of CFD as a tool for combustion devices design is stated and discussed with emphasis on the injector. Long solution turnaround times and questionable accuracy are noted as the primary obstacles to widespread reliance on CFD for injector design. The concept of the Simulation Readiness Level (SRL), comprised of solution fidelity, robustness and accuracy, is introduced and discussed. This quantitative measurement is used to establish the gap between the current state of demonstrated capability and that necessary for regular use in the design process. Current examples of CFD calculations for injector design are presented and evaluated in terms of the SRL. The resultant technology gaps are examples of information used to develop the Combustion Devices CFD Simulation Capability Roadmap. Highlights of the injector portion of the Roadmap process are noted along with key concepts used in its development.

The Roadmap process, augmented by the SRL evaluations, highlights the critical need for code validation for injector flows. MSFC's view of the validation process is presented and issues associated with obtaining the necessary data are noted and discussed. Three current experimental efforts aimed at generating validation data are presented. The case for extensive CFD analysis during the design of the experiment is made and examples of MSFC-generated CFD solutions are presented for each effort. The importance of uncertainty analysis to understand the data quality is also demonstrated.

INTRODUCTION

The Next Generation Launch Technology (NGLT) goals focus design efforts on reducing costs and improving hardware reliability. The two efforts are related since increasing reliability typically reduces operational costs. Rocket engine component reliability can be increased in the design phase by a better understanding of the environments, both thermal and pressure, that will be imposed on critical parts during operation. It is known that the details of the injector design govern not only injector performance, but also environments in the entire thrust chamber assembly. Historically, design tools focus primarily on performance and evaluate environments secondarily, generally in a one-dimensional sense. Environments in the actual hardware are almost always multi-dimensional. Additionally, the NGLT goals have driven cycle selection to an oxygen-rich staged combustion (ORSC) cycle with which designers in the United States have very little experience. The historical design tools apply only marginally to the accompanying injector concepts. Therefore, meeting the NGLT goals will require a new tool that evaluates performance along with multi-dimensional environments with the design goal being to maintain a threshold performance level while generating environments conducive to reliability and long life. Also, robust injector designs require that significant numbers of design evaluations be accomplished over a parametric space during the time frame of the conceptual and preliminary portions of the design phase.

Computational fluid dynamics (CFD) is the tool on the near term horizon most capable of successfully addressing these issues. Theoretically, CFD can be used to determine injector performance and multi-dimensional environments as functions of injector design details. However, CFD has typically not been included in the injector design process. There are at least two fundamental reasons. First, solutions have been time consuming to generate. At best, a few single element solutions may be generated during the early phase of the design cycle. Multi-element solutions have been almost out of the question in this time frame. Secondly, lack of code and model validation has caused injector designers to rightly question whether CFD solutions are of sufficient accuracy to positively impact the injector design. Both of these issues must be addressed before CFD can contribute significantly to improved injector design.

The natural tendency of designers in private industry, enforced by tight budgets and aggressive schedules, is to continue using tools with which they are experienced. This reality dictates that government entities lead the effort to move CFD to the point of acceptance as a reliable injector design tool by the rocket propulsion community. The Marshall Space Flight Center (MSFC) Staged Combustor Injector technology (SCIT) Task has, over the last two years, served to focus technology at MSFC to enable CFD as a reliable and useful tool in an injector design methodology capable of addressing the goals of the NGLT and future propulsion programs. This paper attempts to document both the process developed to meet and the progress made toward achieving the vision for CFD as an injector design tool.

First, a brief status of current injector design tools is provided as context for the current effort. Next, the MSFC vision for using CFD as an injector design tool is stated. Implementation of this long-term goal produces a requirement to evaluate injector CFD capability in terms of both current and desired states. The measuring stick to facilitate this evaluation, Simulation Readiness Level, is presented and discussed in terms of solution fidelity, robustness and accuracy. A generic CFD-based injector design methodology is also outlined and briefly discussed.

Since Marshall is a Space Flight Center, engineering line organizations must provide support for existing and new programs. In the case of the line organization tasked with providing CFD analyses, there must also be technology development and implementation in terms of tools. This is especially true relative to injector CFD analyses. There must then be a parallel effort to prudently use CFD within its current limitations for program support in terms of injector design and analysis while concurrently working technology efforts to improve its capability and usefulness in those areas. Three areas where MSFC is using injector CFD analyses for program support will be discussed. These include the Integrated Powerhead Development (IPD) engine which uses hydrogen and oxygen propellants in a full flow staged combustion (FFSC) cycle and the TR-107 and the RS84 engine both of which use RP-1 and oxygen in an ORSC cycle. The solutions presented facilitate the discussion of current capability. The gaps between current and desired capability serve to motivate the following sections on technology development.

Next, addressing the technology gaps via roadmap development and implementation is discussed. The necessary partitioning and classification of the combustion devices problems into Model Problems is presented. Then, for the model problems, current and desired capability is quantified in terms of Simulation Readiness Level. The gaps thus identified are inputs to the roadmap where they are used to generate and prioritize specific technology tasks.

One of the key areas that emerges from the technology roadmap development process is the critical need for high quality validation data for every propellant combination. So, the status of current MSFC-sponsored validation efforts is presented. Lessons learned from recent experience and attempts to incorporate them into the current efforts are noted. The importance of using CFD to help design the experiment is discussed.

Finally, an attempt is made to objectively summarize what progress has been made at MSFC in enabling CFD as an injector design tool.

SUMMARY STATUS OF CURRENT INJECTOR DESIGN TOOLS

The tools used for injector design are in a transitional period between exclusive use of the empirical tools and extensive reliance on CFD. Although injector designers have begun to use CFD on a limited basis, empirical design tools continue to be used the great majority of the time. The empirical correlations that support the historical tools were developed by extensive use of previously gathered experimental data for similar designs,

propellant combinations and flow conditions. Some of these methodologies also require additional experimental data as input (e.g., drop size distribution, oxidizer core length, etc.) for a specific design. All are necessarily rooted in and bounded by their respective historical databases. Accordingly, these methodologies are not easily extended to address novel design concepts as required by programs like NGLT. These tools focus primarily on performance, with one-dimensional environments a secondary consideration. CFD, as noted earlier, has the potential to evaluate advanced injector concepts both in terms of performance and multi-dimensional environments. Unacceptably long solution turn-around times and questionable accuracy are the main issues that currently limit use of CFD for injector design.

The legacy tools are still overwhelmingly used. In most current injector design programs, CFD is usually not in the original design plan in terms of budget or schedule. The main use of CFD is to evaluate discrete design issues as they arise. Oftentimes this use is a last resort because no other analytical technique is applicable and/or there is no time or money for testing. Since the models are largely unvalidated, the results are typically used qualitatively for trend analyses. There are also occasional uses of CFD results as inputs to historical methods such as for combustion stability. It is primarily the need for new injector concepts driven by new programs that has begun to force the still very limited use of CFD for injector design.

MSFC VISION FOR CFD AS AN INJECTOR DESIGN TOOL

Advancing CFD from the current state of occasional use, often in the ‘there is no other option’ mode, to the primary tool in injector design requires a goal. At MSFC, a long-term goal for using CFD for combustion devices design has been established. That goal is to enable the use of CFD for simulation of preburners, thrust chamber assemblies, and supporting ducting and infrastructure in terms of performance, life and stability so as to affect hardware design in a timely manner. Extensive use of CFD for injector design is the heart of this vision since the physical processes that occur at the injector govern performance and environments in the entire combustor or thrust chamber assembly. Realizing even the injector portion of this vision will require that CFD demonstrate the capability to evaluate large parametric design spaces in both the single- and multi-element contexts in the early portion of the design. These notions have become part of the MSFC Combustion Devices CFD Simulation Capability Roadmap and will be discussed in more detail later.

Pushing CFD into the forefront of injector design requires solution improvement in at least three major areas. In addition to the previously noted issues of solution time and accuracy, the other area requiring attention is solution fidelity, both in terms of geometry and physics. Since this aspect has direct influence on the other two, it will be discussed first. The details of the injector design govern both performance and environments, so the design details must be modeled faithfully. Depending on the design, some single element simulations can be axisymmetric while others must be three-dimensional. All meaningful multi-element injector simulations must be three-dimensional. In terms of physical

processes, the major issues are chemistry treatments, propellant thermodynamic and phase modeling, and the ability to appropriately model heat transfer to and through solid surfaces.

Another solution aspect that must be addressed is robustness. In the design context, robustness refers to the ability to complete simulations of a given fidelity level in terms of convergence, mass conservation and grid independence. Since a large number of simulations must be completed, robustness also involves the ability to pre-process, execute and post-process this large number of solutions in a time frame that fits the design cycle.

The last major area of concern is solution accuracy. There must be quantitative solution capability if CFD is to be more extensively used for injector design. The degree of solution accuracy must be known in order to evaluate its usefulness. It will be shown later that the current degree of demonstrated accuracy is generally very low. This gives rise to the issue of code validation. What do we actually mean by code validation? How do we acquire the data that will be useful for code validation? These and other relevant questions regarding validation will be addressed later.

Quantified levels of simulation fidelity, robustness and accuracy are shown in Table 1. The use of these metrics will be demonstrated in the subsequent sections on program support and the Roadmap where current and desired capabilities are accessed.

Assuming that progress is made in improving CFD capability in the injector design area, some thought must be given to the process in which a useful CFD tool would be an integral part. Figure 1 depicts an embryonic notion of such a CFD-based design optimization process. This process produces an optimized design and then verifies that design by testing. Robust designs require that a range of design parametrics be evaluated. Some optimization capability is needed to help the designer efficiently manage the large amounts of data that will be generated. Since designs will be produced as the CFD capability evolves, Figure 1 also indicates some of the areas where development and integration of technology into the existing capability is required.

The single element design process is one in which issues such as orifice sizes, post tip thickness, cup details, etc. would be evaluated. The initial loop through the process accomplishes the validation and optimization. The green arrows in Figure 1 depict this part of the process. Here, the first step in the single element portion of the process is generation of one or more initial concepts. Next, if it does not already exist, suitable validation data is acquired to validate the CFD model to the required level. If the code to data comparison is not good enough, code improvements will be necessary to increase the accuracy. When the comparisons are good enough, the validated model can then be exercised to provide data for the single element optimization. Independent design parameters are selected over an applicable range to build a design of experiments (DOE) matrix. Based on the DOE matrix, the grids are generated, cases set up, run and post-processed. Process automation in terms of preprocessing is very important because of the time saved in setting up a large number of cases and the need to minimize human error in

Table 1. Quantification of Fidelity, Robustness and Accuracy for Simulation Readiness Level.

Level	Fidelity	Robustness	Accuracy
0	Extremely simple physics, boundary conditions and geometry	Have not completed any simulations	Not evaluated other than historical quality of simulation tool
1	One of reasonably precise geometry or boundary conditions or physics	Have completed some simulations	Qualitative agreement with existing results of related problems
2	Two of reasonably precise geometry or boundary conditions or physics	Simulations with proven convergence and conservation	Quantitative agreement with existing results of related problems
3	Reasonably precise physics, boundary conditions and geometry	Simulations with proven convergence, conservation and grid independence	Qualitative agreement of relevant measures over a parametric space of a representative model problem
4	Reasonably precise physics, completely precise boundary conditions and as-built geometry	Fire and Forget (95%+) simulations with convergence, conservation and grid independence	Quantitative agreement of relevant measures over parametric space of model problems
5	Completely precise physics, completely precise boundary conditions and as-built geometry	Fire and Forget (95%+) simulations with convergence, conservation and grid independence plus the ability to complete 100 or more problems within 3 weeks	Quantitative agreement of relevant measures over parametric space of actual problem

the case set up. The dependent variables extracted from the CFD solutions are some measure of performance, and environmental information relevant to the particular design, like injector face temperature, tip temperature, chamber wall temperature, etc. Here again, because of the large amounts of data involved, automation of the post processing is important. Each independent variable is then correlated in terms of the dependent variables and fed to an optimizer. The optimizer allows the designer to deal objectively with the inherent tradeoffs of injector design in the context of multiple independent and

dependent variables, large amounts of data and often-competing trends. Reliable optimization techniques that make efficient use of the available data are essential to the process. The optimum design will likely be a compromise having performance that is acceptable and environments that are conducive to long life. This optimum single element design is then verified with additional single element testing as shown by the blue arrows in Figure 1.

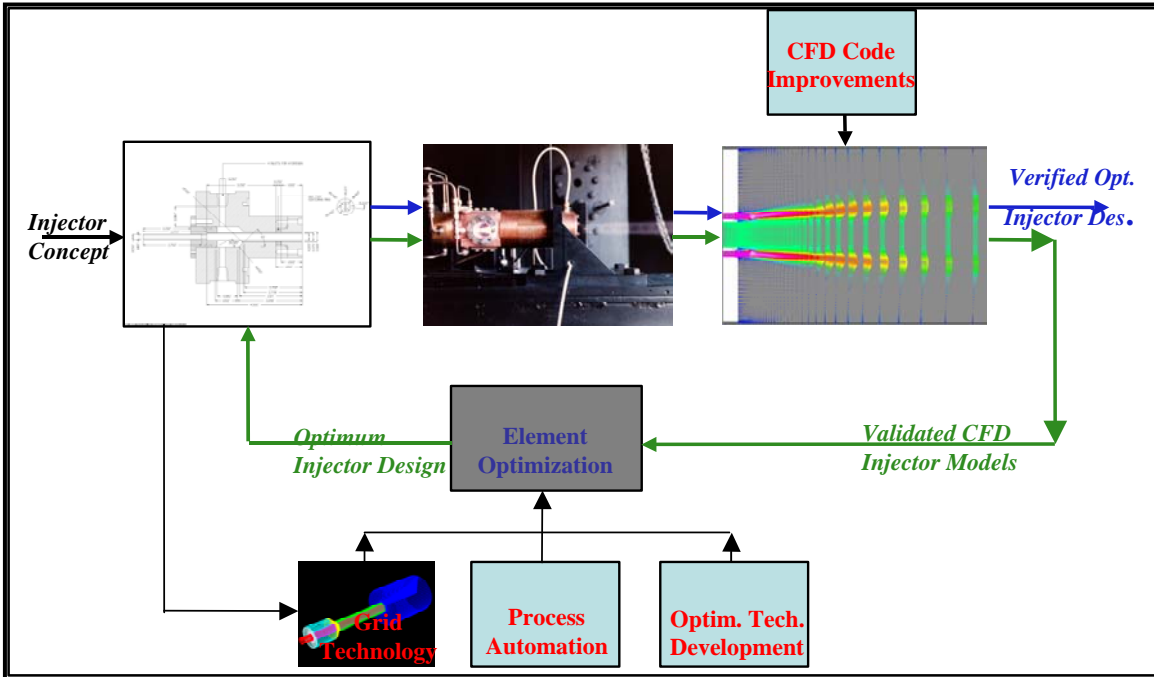

Figure 1. Generic CFD-Based Injector Design Optimization Process.

This optimum single element design would then be used to generate a subscale multi-element design concept that would be carried through a similar process. Here, independent variables such as element spacing, patterns, film cooling, etc. would be evaluated.

CURRENT EXAMPLES OF PROGRAM SUPPORT

MSFC is providing CFD support to main injector design and analysis for three programs. First, MSFC has single and multi-element simulation efforts under way in support of the main injector for the Integrated Powerhead Demonstrator (IPD) Program. The IPD burns O₂ and H₂ in a full flow staged combustion (FFSC) cycle. MSFC is also conducting single element simulations to support main injector designs for both the TR-107 and RS-84 engines in the NGLT Program. The TR-107 engine is a Northrop Grumman Corporation concept while the RS-84 is a Boeing Corporation (Rocketdyne Propulsion and Power Division) concept. Both engines consume O₂ and RP-1 in an oxygen-rich staged combustion (ORSC) cycle.

INTEGRATED POWERHEAD DEMONSTRATOR

In the IPD FFSC cycle, all of the propellants go through preburners before being fed to the main injector. Hence, both the oxygen and hydrogen propellants are gaseous as they enter the main injector. In addition to the general environment issues that accompany any new injector design, there is concern that the IPD main injector faceplate may be hotter than normal since the fuel used to cool it is warm gas and not a cold liquid. Also, the gaseous propellants do not have to atomize and vaporize thus allowing combustion to occur closer to the injector face and increasing the potential for even harsher environments. An initial single element optimization has been completed and a multi-element model of the full-scale main injector is underway at MSFC.

IPD-Single Element

A scaled IPD element is part of validation work that is ongoing at Penn State University. Since validation data is forthcoming, the decision was made to start with the baseline concept and attempt an optimization of that element. The idea was to model performance and environmental indicators as functions of an array of independent geometry variables. The independent geometry variables considered are shown with ranges of interest in Figure 2.

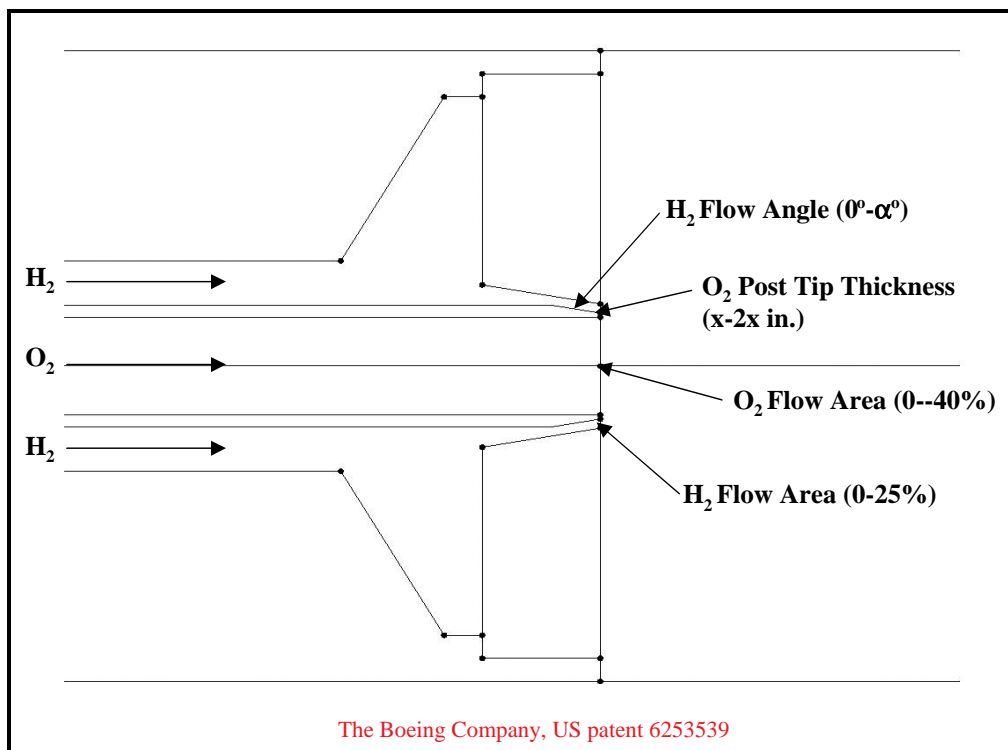

Figure 2. Independent Variables for Element Optimization.

From an initial concept baseline, both propellant flow areas were modified; the H_2 flow area being increased by up to 25% and the O_2 flow area decreased by up to 40%. The O_2 post tip thickness was increased by as much as 100% from the baseline. The H_2 flow angle was modified over a range of plus and minus 100% of the baseline flow angle. A design of experiments matrix was constructed yielding a total of 54 cases to be run.

The sample solution in Figure 3 highlights the dependent variables. Here the combustion length, X_{cc} , is taken to be a measure of combustion efficiency with shorter combustion lengths indicating more efficient designs. Three temperatures, all calculated as adiabatic wall temperatures for this effort, were taken as environmental indicators. The maximum temperature on the O_2 post tip, TT_{max} , the maximum temperature on the injector face, TF_{max} , and the wall temperature two inches from the injector face, TW_3 , all have direct bearing on life. For this relatively crude optimization, the objective was to trade performance (better performance occurring when the combustion length is shorter) versus life of the various parts (longer part life occurring when the part temperature is lower).

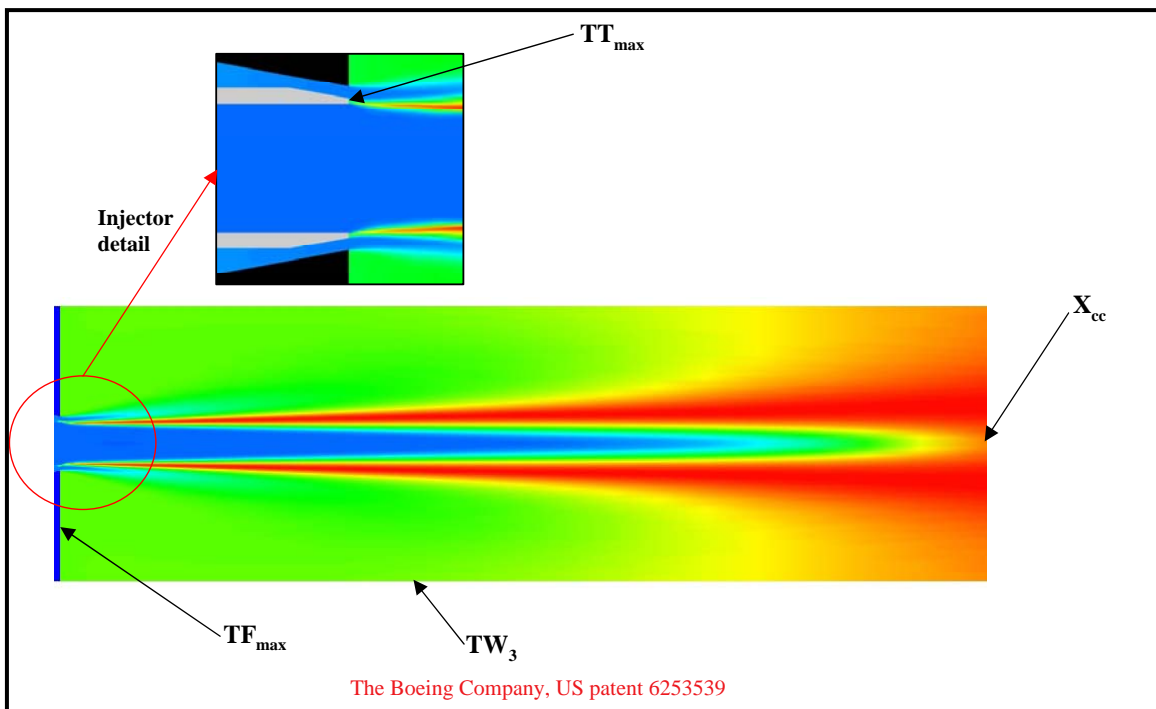

Figure 3. Sample Results and Dependent Variables.

Grids for the 54 cases were generated from a database in less than an hour. The cases were set up and run on a local PC cluster, with each case being run on a single CPU. All cases were completed in approximately five days. The results were post processed to extract the data of interest, which was then used to generate response surfaces (usually quadratic polynomials) for each dependent variable. During this process, problems were noticed with the quality of the polynomial fit for the combustion length. Investigation of the situation indicated insufficient grid resolution at the end of the flame region. New individual solutions were run until grid independence was achieved. The new grid density

was used to regenerate the grids for the 54 cases all of which were then rerun. The new combustion length correlation was much improved.

Before continuing, it should be noted that a significant amount of effort went into automating both the pre and post processing of these cases prior to the optimization. Reducing the amount of “hand labor” via process automation accomplishes two important things. First, when running large numbers of cases concurrently, there must be an efficient and verifiable process that is used to set up, run and post process the cases. It is infinitely easier and surer to verify a good process than it is to individually check to ensure that all the grids, input files and initial conditions are accurate and in the proper directories. Secondly, automation saves significant amounts of time in getting to the point where the results can be used for engineering.

After the individual response surfaces were generated, they were linked together into a composite surface so that multi-variable optimizations, which enable the performance versus life trades, could be accomplished. Both single and multi-variable optimizations were performed. Single variable optimizations were performed mainly to test the optimizer, since the individual dependent variable minimums were known. The optimizer worked well for these simple cases. One result of note was that each single variable optimization resulted in a different element geometry. The multi-variable optimization allows some or all of the dependent variables to be optimized simultaneously. This is the mode most useful to injector designers. Here, the dependent variables can be weighted either equally or unequally depending on the design priorities. Notably, when the multi-variable optimization was done with all dependent variables equally weighted, the design producing that result was different than that for any of the single variable optimizations. The clear message is that design of a robust injector that performs well and promotes long component life requires that as many of the relevant independent variables (i.e., the design details) be included and modeled as early in the design process as possible. Simply put, this requires an efficient, validated CFD code, sufficient computer resources to run the simulations and an optimizer to enable the designer to objectively manage the large amounts of data generated.

Completion of this initial design optimization was valuable in terms of experience gained in managing the process. However, evaluation of the CFD calculations in the context of the SRL concept reveals the additional work required before this process can have a significant design impact. The fidelity level of the single element simulations is approximately 3. The element is designed to be axisymmetric so the two-dimensional axisymmetric assumption is reasonable here. Both propellants are gases and the chamber pressure is such that the ideal gas assumption is also reasonable. The robustness level is 5. Convergence, mass conservation and grid independence have all been demonstrated. Fifty four cases were assembled and run in less than two weeks so 100 cases in three weeks could be done comfortably assuming processor availability. The accuracy level of the simulations is 1. Qualitative agreement has been obtained on a similar problem that used ambient propellants. Thus the key issue here is lack of proven accuracy at a level that could quantitatively affect design.

IPD-Multi-Element

Since the environments seen on the injector face and the near-injector chamber wall are functions of not only the element design, but also the number of elements, element spacing, injector pattern, etc., a three dimensional model is required to provide these environments. The initial focus of this model is environments with a lesser emphasis on performance.

A fifteen-degree slice of the main injector and main combustion chamber was modeled. The key assumption in the model is that the thermal environment at any point on the injector face or chamber wall is significantly affected only by the elements in the immediate area. Thus, the remaining elements are assumed to have only an indirect effect through the bulk flow in the chamber. This bulk flow is modeled by assuming that outside the area where the elements are modeled in detail, the flow is assumed to be completely mixed at equilibrium conditions. These assumptions permit the generation of a discrete mesh of a manageable size (i.e., approximately 2-4 million grid points). According, seven elements were simulated to model the propellant mixing and combustion in detail, while the remainder of the flow field is modeled as equilibrium bulk flow. The faceplate is modeled as a solid so the transpiration cooling is not part of this simulation. Figure 4 shows the domain modeled and the calculated temperature field. Typical results for the heat flux on the injector are shown in the close-up in Figure 5.

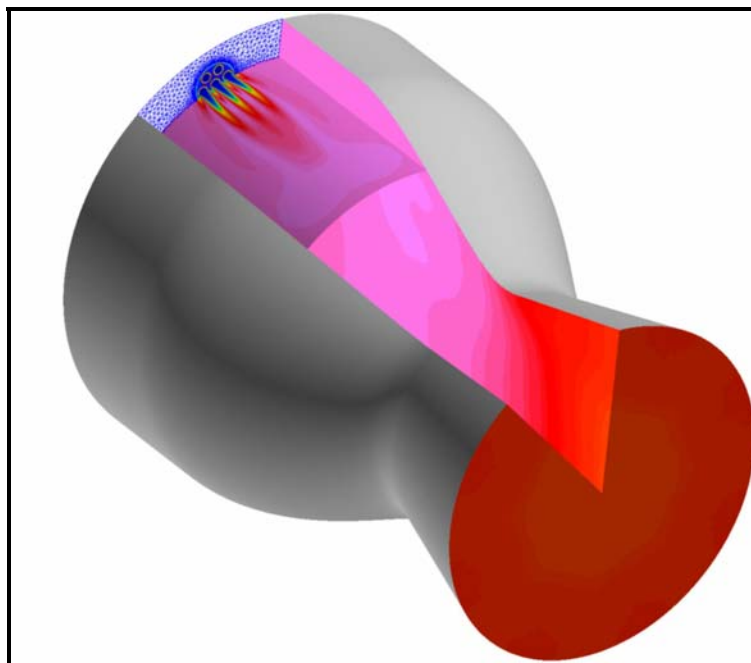

Figure 4. IPD Main Injector Temperature Contours.

Another simulation of the IPD main injector and main chamber is currently underway. The outer three element rings are simulated to give a better indication of the environments on the wall. Again, the remainder of the injector flow is assumed to be

completely mixed and is modeled as equilibrium bulk flow. Main chamber wall heat flux contours from this developing solution are shown in Figure 6.

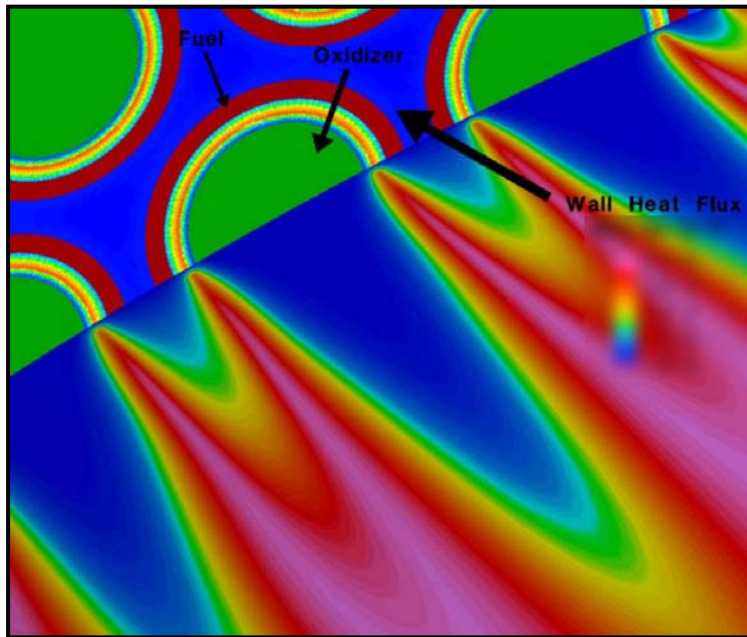

Figure 5. IPD Injector Face Heat Fluxes and Gas Field Temperatures.

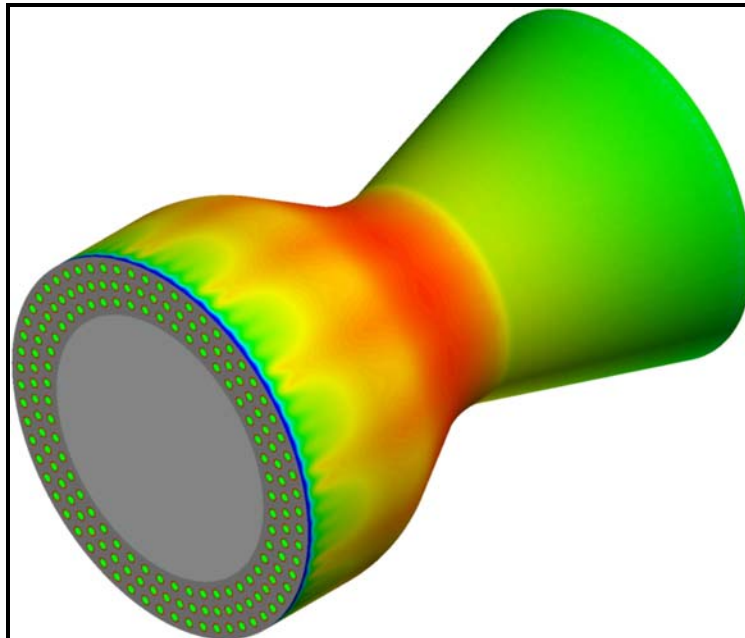

Figure 6. Developing Heat Flux Contours on the IPD Main Chamber Wall.

This ongoing effort represents the first attempt at MSFC to model the three-dimensional details of a multi-element injector. The level of immaturity of this type of calculation is revealed in the SRL evaluation. Since the geometry and boundary conditions are extremely simple, the fidelity is approximately one. Only a few calculations have been completed so the robustness level is also about one. The accuracy level has not been evaluated at all resulting in a demonstrated accuracy level of zero.

NEXT GENERATION LAUNCH TECHNOLOGY

Because of the increased emphasis the NGLT program places on engine life, the thermal environments generated by the TR-107 and RS-84 main injectors have taken on a higher priority than usual. The injector-generated thermal environments imposed on the injector and main chamber wall need to be at low levels relative to past programs to address the NGLT goals for long life. That means environmental dependencies on injector design details must be well understood and appropriately characterized. Since American designers are relatively inexperienced with the ORSC cycle, there is very little existing data that can be applied to the current designs. Ill characterized thermal environments in the near-injector area lead to designs that are likely to fail to meet at least one of the design requirements. If the thermal environments used for the design are too high, more fuel than actually necessary will be used to cool the wall and other solid surfaces in the near injector part of the chamber. This results in poor injector performance. If the thermal environments used for the design are too low, insufficient fuel coolant will be used likely causing some of the parts of the TCA to fail to meet life requirements. CFD is thus being used in an attempt to gain more insight into the problem.

Northrop Grumman TR-107

The TR-107 is an ORSC cycle engine concept using RP-1 and oxygen propellants in the NGLT program. Support of the TR-107 main injector is provided through a government task agreement (GTA) with the Northrop Grumman Corporation. The objective of the analyses is to validate a CFD tool to accurately predict performance and environments for main injectors ranging from subscale test articles to the full-scale injector. A single element test program will be conducted that will provide data for the code validation.

Numerous two-dimensional axisymmetric cases have been set up to model the uni-element test article. This represents a compromise since the propellant injection scheme is actually three-dimensional. All cases run thus far use an ideal gas assumption for both propellants. Wall temperatures have been fixed so that convective heat fluxes can be calculated. Cases have been run with and without film coolant, with different film coolant levels, at different propellant flow rates and mixture ratios and with varying cup depths. Cases with and without film cooling were run to judge the effectiveness of the film coolant. Figure 7 shows the static temperature distributions for Case TP-2 with and without the film cooling just downstream of the injector. Figure 8 shows the fuel mass fraction profiles for both cases. These cases were run to help judge the film coolant effectiveness. The wall heat flux profiles for both cases are shown in Figure 9. They are

identical up to the end of the cup where the film coolant is introduced for one case. The initial large spike at $x/x_{\max}=0.03$ is where the combustion is initiated at the injector fuel inlet. The fuel between the flame and the wall is warmed by the wall very briefly until heating by the flame causes the near wall gas temperature to rise, thus causing the heat flux to increase fairly sharply until the end of the cup is reached. As the corner is turned to the injector face, the heat flux falls off rapidly for both cases, though the film coolant injected at the face causes that heat flux for that case to be lower. The heat flux for the case with film coolant rises to meet that of the no film coolant case at $x/x_{\max} = 0.11$, thus indicating the end of its effectiveness.

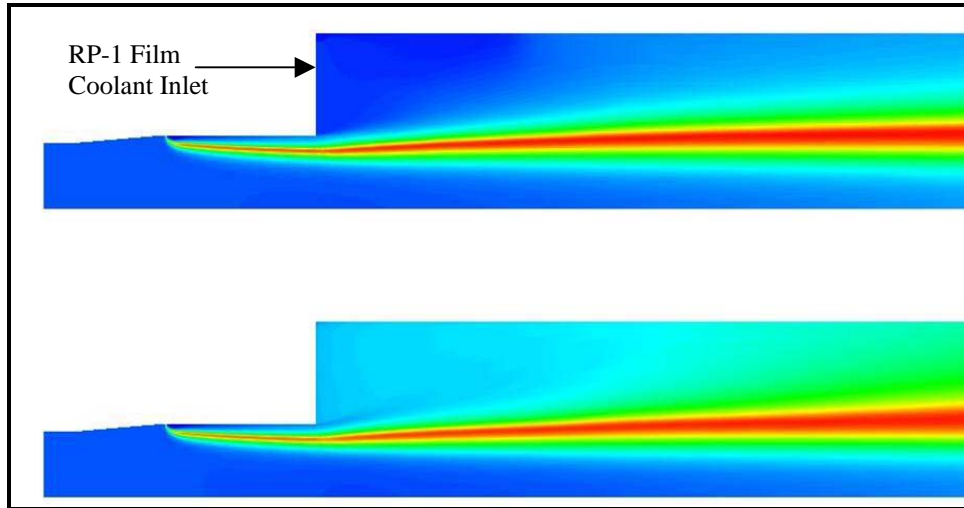

Figure 7. Static Temperature Contours for Case TP-2 with and without Film Coolant.

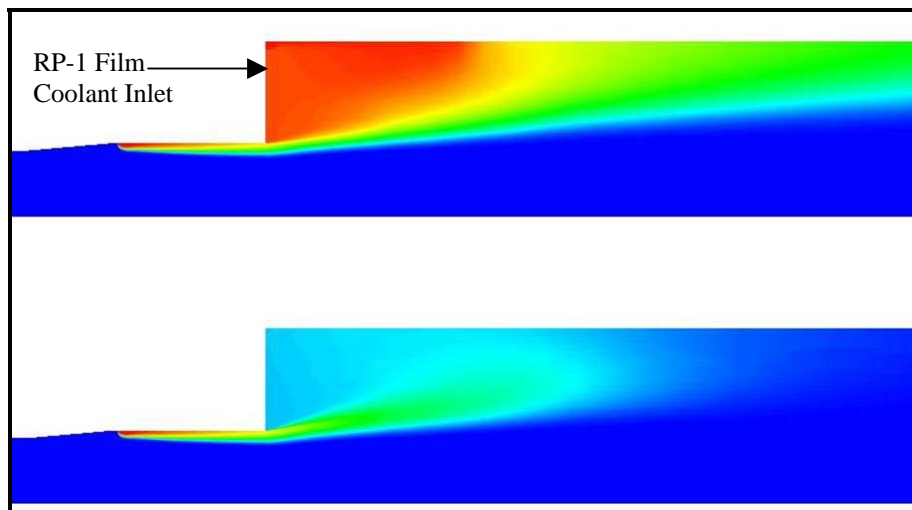

Figure 8. RP-1 Mass Fraction Contours for Case TP-2 with and without Film Coolant.

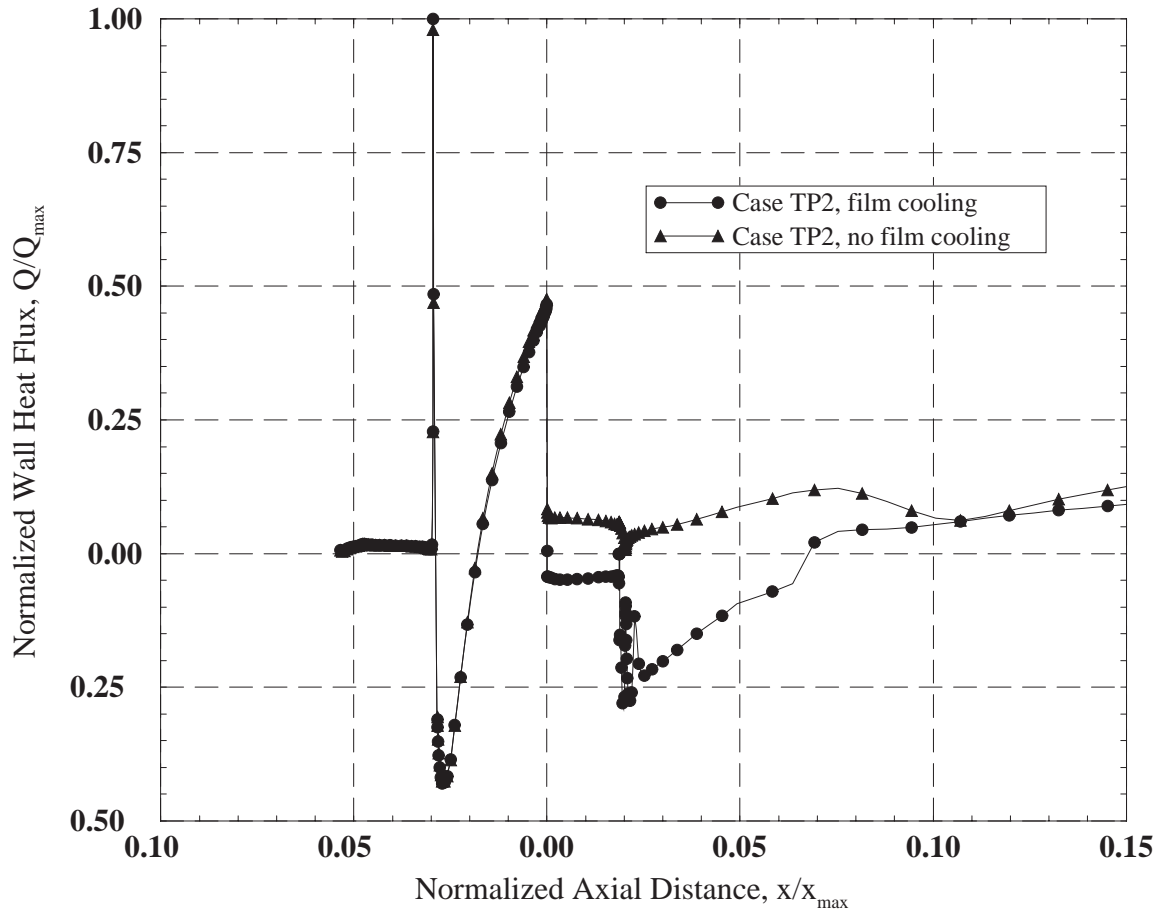

Figure 9. Wall Heat Flux Profiles for TR-107 Case TP-2 with & without Film Cooling

Again, there are several issues with the calculations that are identified in the context of the notion of SRL. In terms of the fidelity, the level is essentially zero since both the geometric and physical representations are extremely simple. However, it should be noted that an RP-1 decomposition model was employed (for some cases) to account for cracking as the film coolant heats up. A three dimensional grid slice of the problem has been generated and is currently running.

The robustness level of the two dimensional, axisymmetric simulations is approximately at level three. Numerous solutions have been completed with convergence both from a residual standpoint and with temperature probes inserted at key points in the flow field. Both overall mass conservation and plane-by-plane species balances have been achieved. Also, grid independence has been demonstrated.

There have been no validations of the code with similar problems. The accuracy level is therefore essentially zero.

Boeing (Rocketdyne Propulsion and Power) RS-84

The RS-84 engine is an NGLT concept that uses the oxygen-rich staged combustion (ORSC) cycle with oxygen and RP-1 as propellants. The objective of the RS-84 CFD injector design support is to mitigate risk by better characterizing the injector-generated thermal environments on the baffle elements and on the chamber wall. Two-dimensional axisymmetric single element representations of both situations were developed. For the baffle element simulation, the distance from a typical element centerline to the baffle element wall is taken to be the single element chamber radius. For the chamber wall simulation, the distance from an outer row element centerline to the chamber wall was taken to be the chamber radius. The single element chamber radius for the chamber wall simulation is the larger of the two chambers. These situations are represented notionally in Figure 10.

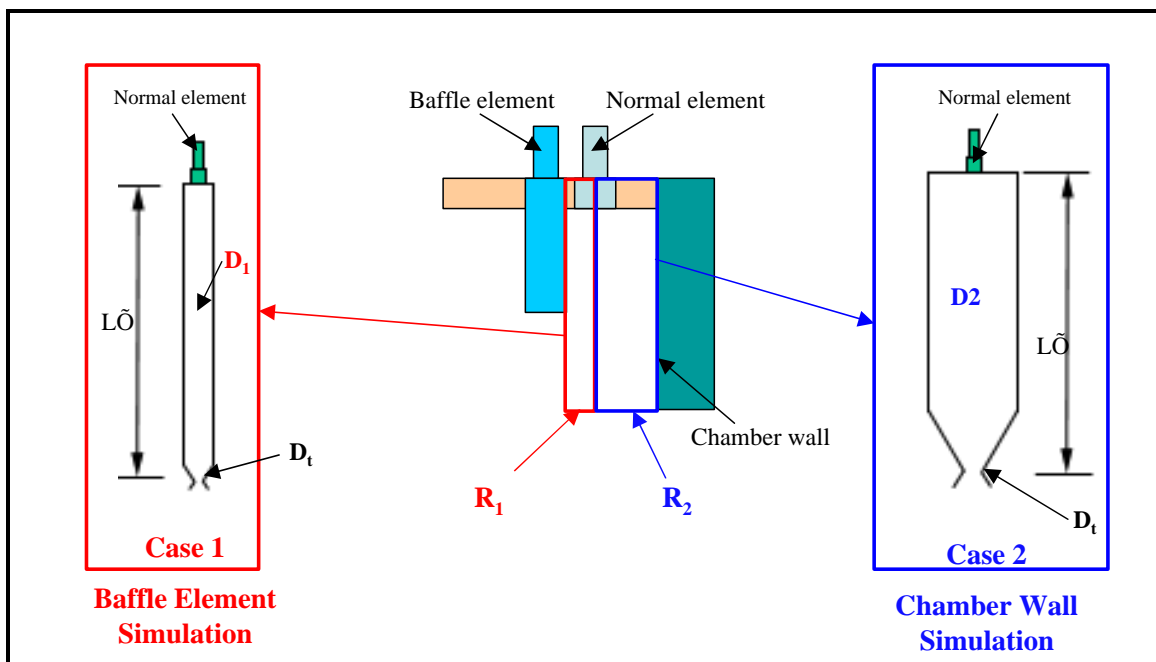

Figure 10. Single Element Baffle and Chamber Wall Representation.

For both chamber diameters, two variations of the same element were evaluated. In the first variation, some of the oxygen is introduced axially, while the remainder is introduced tangentially. The second element is similar except all the oxygen is introduced axially. All of the fuel is introduced tangentially in both variations. Full-scale propellant conditions were used while the flow rates were scaled from the full-scale power balance. Propellants in both cases were modeled as ideal gases. In all cases, the wall temperature was fixed to enable heat flux calculations. The chamber was modeled in such a way that the distance from the injector to the throat is the same as in the full-scale main chamber. Grid independent solutions were obtained for all cases.

In Figure 11, the effect of oxygen swirl is shown for the baffle simulation. The heat flux for the case where a portion of the oxygen is swirled is higher than for the case where all

of the oxygen is introduced axially. The effect of swirling a portion of the oxygen is to enhance mixing with the fuel, thus leaving less of the cool fuel to cool the wall.

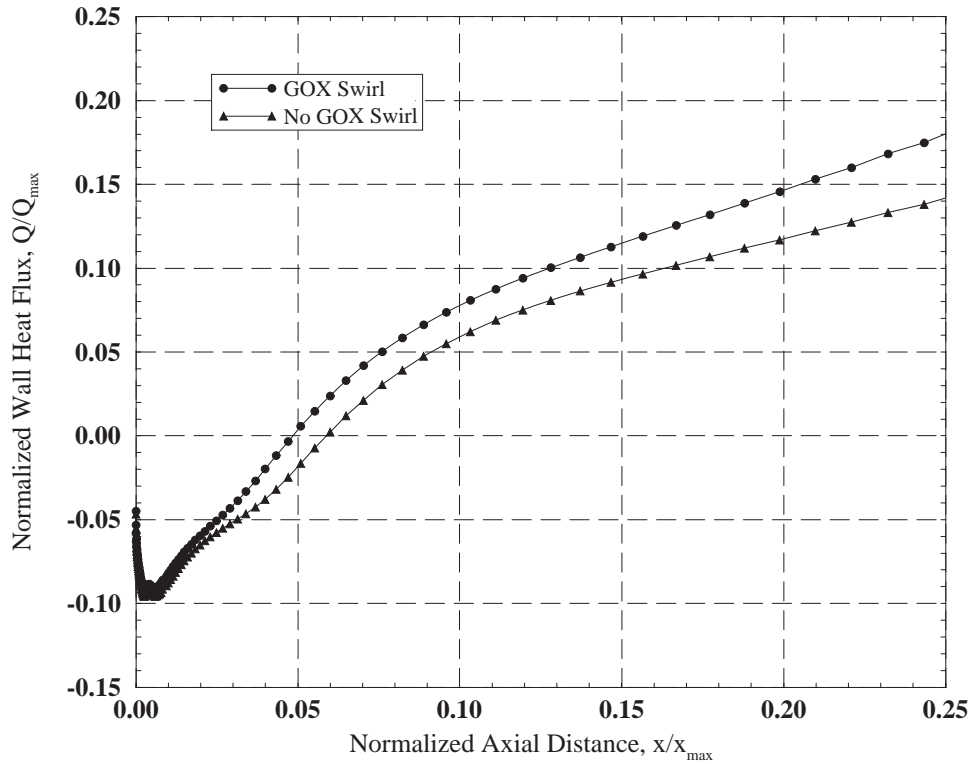

Figure 11. Effect of GOX Swirl on RS-84 Near-Injector Wall Heat Flux

Figure 12 shows the comparison between heat fluxes for the baffle (smaller chamber) case versus the chamber wall (larger chamber) case where all the oxygen is introduced axially. Here, the heat flux for the baffle case is negative at the injector face ($x/x_{max}=0.0$) due to the wall being warmer than the fuel. It rises steadily from just near the injector to the end of the domain of interest. The heat flux for the chamber wall case is essentially flat for the first third of the domain shown. This is primarily due to the recirculation zone near the injector in the larger chamber that is almost nonexistent in the smaller chamber. The gases in the recirculation zone are essentially constant temperature, thus accounting for the flat heat flux profile. After reattachment, the heat flux begins to rise at a rate similar to that in the small chamber. The heat flux for the baffle wall case is higher throughout most of the domain because of higher near wall velocities and temperatures.

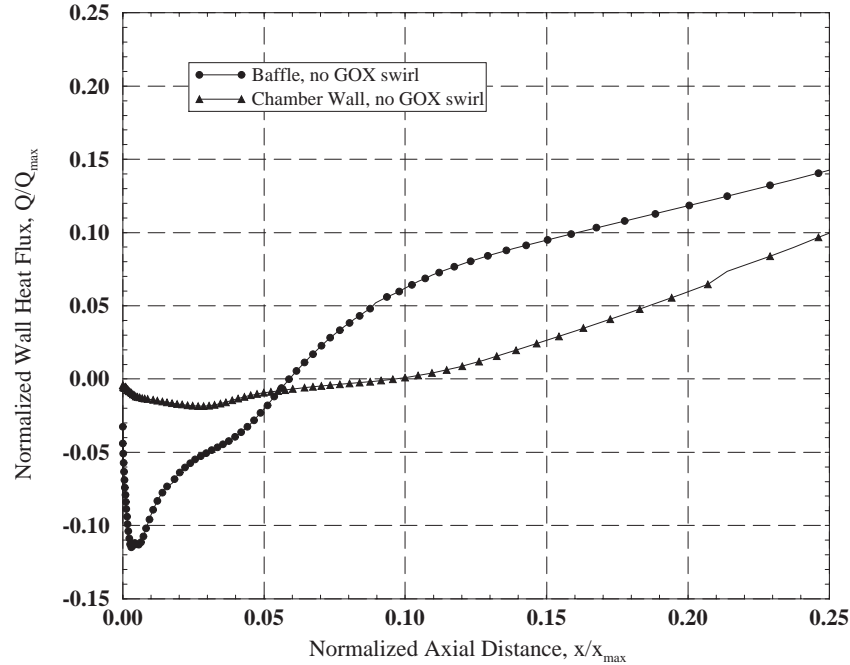

Figure 12. Baffle versus Chamber Wall Heat Flux Comparison for RS-84.

There are several issues with these calculations that will be highlighted in terms of the SRL notion discussed earlier. In terms of fidelity, these simulations are essentially at the 0 level since the geometric and physical representations are extremely simple. Geometrically, the tangential propellants cause the element to be three-dimensional instead of the two-dimensional representation used in these simulations. In terms of physics, the ideal gas representation of the RP-1 at the RS-84 operating conditions results in a fluid density that is 20-30% high relative to the real fluid. The robustness level of the simulations is approximately at level 3. Numerous solutions have been generated with proven convergence from a residual standpoint along with temperature probes inserted at key points in the flow field. Both overall mass and plane-by-plane species balance have been achieved. Also, grid independence has been demonstrated. There have been no validations of the code with similar problems. The accuracy level is therefore essentially at the zero level. Thus, significant improvements must be made for these calculations to be useful for design.

Figure 13 highlights the accuracy issue. The baffle case is used to show the difference in heat fluxes due to a physical aspect of the problem, the effect of swirling a portion of the oxygen, versus those differences resulting from choice of turbulence models. Figure 13 shows that the heat flux difference caused by swirling a portion of the oxygen versus introducing it all axially is on the same order as the difference resulting from using the standard $k\epsilon$ versus an extended $k\epsilon$ turbulence model. Without good quality validation data to give guidance on turbulence model selection, it is thus impossible to quantify the effect of oxygen swirl on the heat flux for this problem. At this point, the only meaningful conclusion is that swirling a portion of the oxygen produces a slightly higher heat flux than with no oxygen swirl.

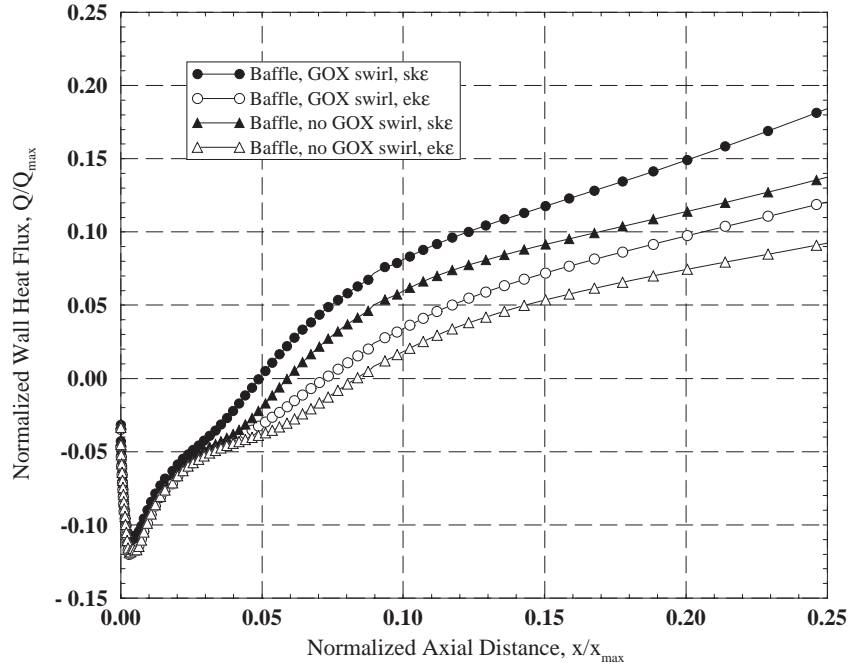

Figure 13. Effect of Turbulence Model Selection on Heat Flux Prediction.

COMBUSTION DEVICES CFD SIMULATION CAPABILITY ROADMAP

The examples of program support for injector design and analysis are evidence that significant progress has been made at MSFC in the last two years. It is also apparent that much work remains to be done before CFD can be relied on as the primary injector tool.

At MSFC the recent work on injector design fits into a larger effort embodied in a long-term goal for CFD in the context of combustion devices design. Although stated earlier, that goal bears restating here. It is to enable the use of CFD for simulation of preburners, thrust chamber assemblies, and supporting ducting and infrastructure in terms of performance, life and stability so as to affect hardware design in a timely manner. The scope of simulation capability required to meet this goal is extremely broad and deep. Flow regimes ranging from low subsonic to supersonic and from single phase to multi-phase must be modeled. Physical processes that must be modeled include turbulence, finite rate chemical reactions, heat transfer to solid surfaces, evaporation, etc. Some propellants flow through the injector axially, some swirl while others impinge into each other. There is a range of fuels and oxidizers in use, each combination of which has its own set of reactions and in some cases other issues, to be modeled. The high pressures and temperatures in the chamber sometimes negate the assumption of the ideal gas equation of state and require other more complex treatments.

This daunting array of issues has been one of the things that has stymied logical, consistent development of CFD in the general area of combustion devices design and especially for injectors. The first step to making progress is understanding what needs to

be done. Secondly, priorities must be established in terms of technical issues, budgets, manpower requirements and schedule. Finally, there must be an implementation plan in place that generates and manages technology tasks. This plan must also anticipate the newly developed technology so that the work continues with minimal disruption.

MSFC is in the process of developing a Combustion Devices CFD Simulation Capability Roadmap to facilitate an orderly technology development process that meets the above-noted goal. The function of the Roadmap is made clear by looking at its users. First the Roadmap is useful at a high level to programs and projects since it can be used at a high level to provide a vision of technology development strategy-both short and long term. It conveys to them a realistic view of current capability and the resources required to advance that capability to higher SRL's. Secondly, the Roadmap provides the line organization management with the necessary tools for capability evaluation and resource planning. Thirdly, it allows the engineer in the line organization to identify critical weaknesses in capability and to specify detailed technology tasks that will bridge the gaps. Finally, the Roadmap will provide the research community with detailed requirements in terms of new technology including required physical models and tool improvements and experimental designs required for simulation certification.

The aforementioned depth and breadth of the entire problem requires some linearization to break it up into something more tractable. MSFC has chosen the Model Problem approach. The notional cutaway of the Space Shuttle Main Engine (SSME) shown in Figure 14 is presented to facilitate the discussion. Eighteen model problems are identified

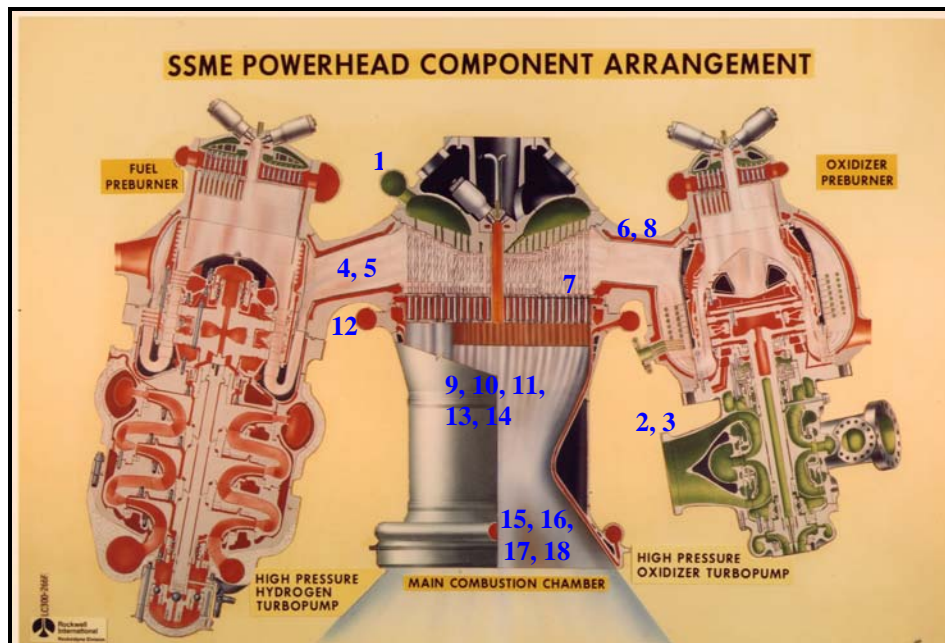

Figure 14. Model Problems Located Notionally on SSME Cutaway.

in the combustion devices area. The first six have to do with propellant flowing through hardware that feeds the injector. They are identified and organized logically in Figure 15. Next, model problems 7-12 cover the flow into and through the injector. They are also

shown in Figure 15. Finally, model problems 13, 14, 15, 16, and 18 are the environmental problems of interest to NGLT. They are also grouped in Figure 15. These Model Problems are associated with the thermal, and in some cases structural, loads on the hardware. It should be noted that Model Problem 14, combustion stability, is a very long-term goal.

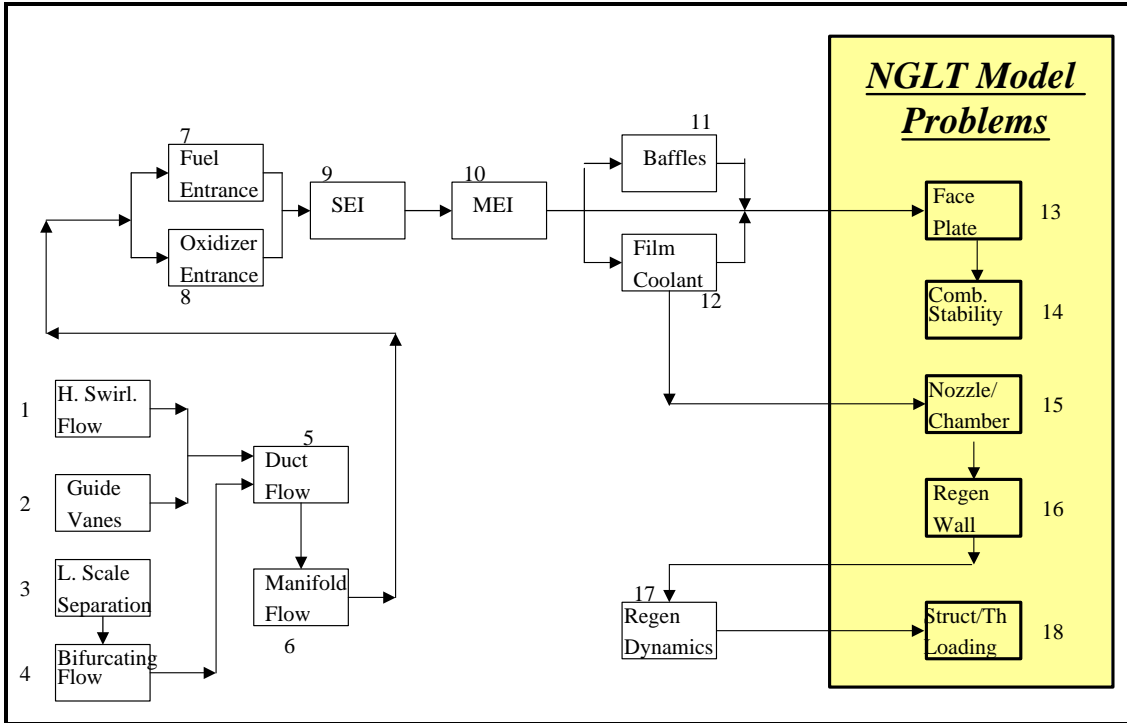

Figure 15. Model Problem Identification and Grouping.

Figure 15 supports the notion that the heart of the overall Roadmap should be the injector problem. Advances in grid generation techniques and increases in computing power have made the non-reacting duct flow problems embodied by Model Problems 1-6 considerably more tractable. The characteristics of the flow issuing from the injector are what govern Model Problems 13-18 (with the exception of problem 17). In addition to performance, these are the real problems of interest to NGLT in its effort to create designs that extend hardware life. The ability to evaluate the life of combustion devices components depends on the ability to accurately predict the environments imposed on them during operation. These environments are primarily a function of injector design. Thus, meeting the MSFC long-term goal requires the initial focus to be on the injector.

The initial focus on the injector portion of the model problem group also addresses the most difficult of the model problems. There are several viable fuels and oxidizers and even more combinations. Depending on the flow conditions, the propellants can be either thermodynamically subcritical or supercritical. The injector geometry may be shear coaxial, swirl coaxial or impinging or any hybrid combination. All of these issues have important ramifications on how, or even whether, the injector can be modeled. Somehow, the Roadmap must address this complexity. After setting the injector problem as the

initial Roadmap focus, it is divided into two Model Problems, the single element injector (SEI) and the multi-element injector (MEI) to make it more approachable. Further division of the injector problem is required to make the technology development problem tractable. The route chosen is based on the notion of degeneracies or subdivisions. Each model problem is further classified based on propellant selection, propellant state, injector geometry and whether the simulation is steady, unsteady, or transient. The requirement to quantitatively establish current and desired simulation levels also demands such subdivisions. Figure 16 shows the degeneracies for Model Problem 9 - the Single Element Injector. The red stars indicate areas of current work at MSFC.

<p>9.1 Steady</p> <p><u>9.1.1 Supercritical reactants</u></p> <p> 9.1.1.1 H2/O2</p> <p> 9.1.1.1.1 Shear Coaxial *</p> <p> 9.1.1.1.2 Swirl Coaxial *</p> <p> 9.1.1.1.3 Impinger</p> <p> 9.1.1.2 RP-1/O2</p> <p> 9.1.1.2.1 Shear Coaxial *</p> <p> 9.1.1.2.2 Swirl Coaxial *</p> <p> 9.1.1.2.3 Impinger</p> <p> 9.1.1.2.4 Hybrid *</p> <p> 9.1.1.3 RP-1(cracked)/O2</p> <p> 9.1.1.3.1 Shear Coaxial</p> <p> 9.1.1.3.2 Swirl Coaxial</p> <p> 9.1.1.3.3 Impinger</p> <p> 9.1.1.4 JP-N/H2O2</p> <p> 9.1.1.4.1 Shear Coaxial</p> <p> 9.1.1.4.2 Swirl Coaxial</p> <p> 9.1.1.4.3 Impinger</p> <p><u>9.1.2 Subcritical reactants</u></p> <p>9.2 Unsteady</p> <p>9.3 Transient</p>
--

Figure 16. Model Problem 9 (Single Element) Degeneracies.

For each Model Problem of interest, the current SRL is quantified in terms of fidelity, robustness and accuracy. The current SRL is then contrasted with the minimum SRL level required to impact injector design, in this case for NGLT. This minimum level has been established at SRL = (3, 4, 3). At this level, the simulation must be based on reasonably precise physics, boundary conditions and geometry. The capability must exist to run simulations in the “hands off mode” to convergence 95% of the time with mass conservation and grid independence. The simulations must be based on qualitative validation of relevant measure for at least one relevant problem. The difference in current and minimum required SRL levels forms the basis by which technology tasks are defined.

Since it is not possible to address all of the degeneracies of even a single Model Problem simultaneously, general priorities are set by the requirement to support current programs. Sometimes these general priorities are modified to an extent by technical issues. For

instance, even though the TR-107 and RS-84 projects currently have very high priority, considerable effort is being expended on the IPD support-both in single element and multi-element injectors. The justification is that the GO_2/GH_2 propellant combination, with its relatively simple physics and well understood chemistry, make it an efficient and effective arena in which to validate certain fundamental aspects of injector flow, investigate many aspects of simulation requirements and to develop processes and procedures that are very useful for all other injector simulations.

Technology tasks identified to support current programs are then organized in terms of technical priority, schedule, budget and available manpower. The result is a local map for each degeneracy of each model problem. The local maps are then prioritized and collated into Model Problem maps. The overall Roadmap is comprised of the Model Problem maps.

A summary of the SRL levels of the simulations done thus far to support MSFC programs is shown in Table 2. Some immediate conclusions can be drawn from this data. First, with the exception of the IPD single element simulation, the fidelity level is at zero. The IPD single element fidelity is at level three because the element is axisymmetric (i.e., there are no significant geometry simplifications) and the ideal gas assumption is good for the GO_2 and GH_2 propellants.

Table 2. SRL's of Program Support Simulations

Simulation	f	r	a
IPD Single Element	3	5	1
IPD Multi-Element	1	1	0
TR-107 Single Element	0	3	0
RS-84 Single Element	0	3	0

The other single element analyses actually use axisymmetric geometry assumptions for three-dimensional elements and the ideal gas assumption for RP-1 is generally not very good. The fidelity level of the IPD multi-element simulation is at a low level mainly because of all the simplifying geometry assumptions. Having the capability to generate three-dimensional grids for complex element geometries will increase fidelity levels. Additional computer resources to run the resulting large jobs are also necessary. A robust real fluids model also increases the fidelity level, especially for the hydrocarbon models.

In general, the robustness level of the calculations is higher, especially for the single element simulations. The single element IPD calculations were started and run to successful completion without operator intervention. Thus far, the hydrocarbon simulations have to be run in the non-reacting mode for a time, stopped, examined for a suitable ignition location and restarted in the reacting mode. Currently, the IPD multi-element simulation requires significant operator attention to achieve a solution.

The current demonstrated accuracy level of all the simulations is very low-either zero or one. This problem cannot be addressed by simply having a more precise model or more computer power, although both of these would be helpful. The initial and most important issue here is lack of relevant validation data. The ability to obtain and use high quality validation data is currently the most significant roadblock to using CFD for designing rocket engine injectors. The next section will examine some of the issues and concerns about data for validation and the validation process itself.

CFD CODE VALIDATION

The fact that the designers' lack of confidence in the solutions is one of the primary obstacles to CFD being used as an injector design tool was noted earlier. This notion of lack of proven accuracy was confirmed via the SRL discussion in the last section. MSFC, along with others in the community, has produced CFD solutions for injectors that are grid independent and satisfy the conservation equations for mass, momentum, energy and other auxiliary equations along with balance of species. Achievement of good quality solutions, while currently somewhat of an accomplishment for these complex flows, is really only the beginning. The accuracy of a code for a given simulation must be demonstrated on relevant problems to overcome the designers' reluctance. This requires a validation process.

MSFC engineers view the validation process as four basic phases. The first phase is to use existing data for related problems from the literature to increase the demonstrated accuracy level from the current level of zero or one to two. This concept is shown in Table 1. To further increase the accuracy level, new experimental data must be acquired. So the second phase is experimental planning. The third phase is experimental execution. Finally, the newly acquired data is used for validation to increase the demonstrated accuracy level of the code.

Lack of relevant, high quality validation data is the major initial obstacle in the validation process. Today, this obstacle looms so large it is difficult to see beyond it to others that surely must be conquered en route to real code/model validation. This data is needed now to provide guidance to many remaining questions that relate directly to solution accuracy. Are the simplifying geometry assumptions appropriate? Is the appropriate equation of state being used? Are the physical sub-models appropriate? And so on.

Since MSFC engineers do not yet have experience in a complete cycle of validation process, at this point the discussion will focus on current issues relative to the first two phases of the process. In this context, there are two major concerns. First, careful design of the experiment is critical in obtaining the data necessary to advancing the simulation accuracy to the required level. Second, the accuracy of the data must be well characterized in order for it to be truly useful.

Prior efforts at MSFC have shown that the users of the data must be intimately involved in the design of the test in order for the data to be useful as originally intended. MSFC

engineers are currently heavily engaged in this area for three experimental efforts. This phase involves much more than mechanical design of a test article and establishing a test matrix. CFD simulation of test conditions must be an integral part of this up front planning. For instance, the object is to increase the confidence of the code for injector design, so the code must be capable of discerning the effect of changes in geometry details and flow conditions on performance and environments. Just comparing the CFD solution to data from one design or one set of conditions is not sufficient validation for a design tool. An experiment must then be designed that spans a relevant range of geometries and conditions. The CFD code must be exercised over this parametric range of independent variables in order to assess the effect on the dependent variables. This must be done before the dependent variables to be measured can be established. Also, the range of the dependent variable response across the experimental space must be broad enough to be measured confidently. All of this is necessary to establish requirements for the type of instrumentation required and its location.

The issue of confidence in the experimental data leads to the notion of uncertainty analyses. A formal uncertainty analysis of both the experimental facility and the test rig must be conducted prior to finalizing the rig design, instrumentation selection and placement, and test matrix. The confidence level of the variables to be measured must be known before testing to ensure that the data will be useful for validation.

Both of these issues place requirements on the validating organization. It is clear the up front work requires a consistently high level of coordination between the organization that needs the data and the organization that provides the data. Engineers from both organizations must work together in an iterative process between data requirements and experimental capability to arrive at a test article design, instrumentation selection and placement, and data uncertainty levels. If these pre-test tasks are not taken seriously, it is unlikely that even successful execution of the experiment will yield the required data.

The validation process consumes significant amounts of valuable resources if it is done correctly. Manpower requirements to consistently achieve the above-noted coordination level are high. Many CFD simulations must be run before the experimental design is completed. Also, the high-pressure hot-fire experiments require large amounts of funding. Successful validation requires a long-term commitment from all of the involved organizations

The remainder of this section will provide brief overviews of three MSFC-sponsored validation experiments and MSFC involvement in each to date.

GO₂/GH₂ EXPERIMENT AT PENN STATE UNIVERSITY

The single element validation experiment to be performed at Penn State University will address Model Problem 9.1.1.1.1, which is the GO₂/GH₂ single element coaxial injector. This effort not only supports the IPD simulations noted earlier, but also a more general effort to validate CFD codes for injector design. The flow conditions are shown in Table 3. The test rig with the main chamber and both preburners is shown in Figure 17. Note that both propellants are fed to the scaled main injector as hot gases after having passed through preburners.

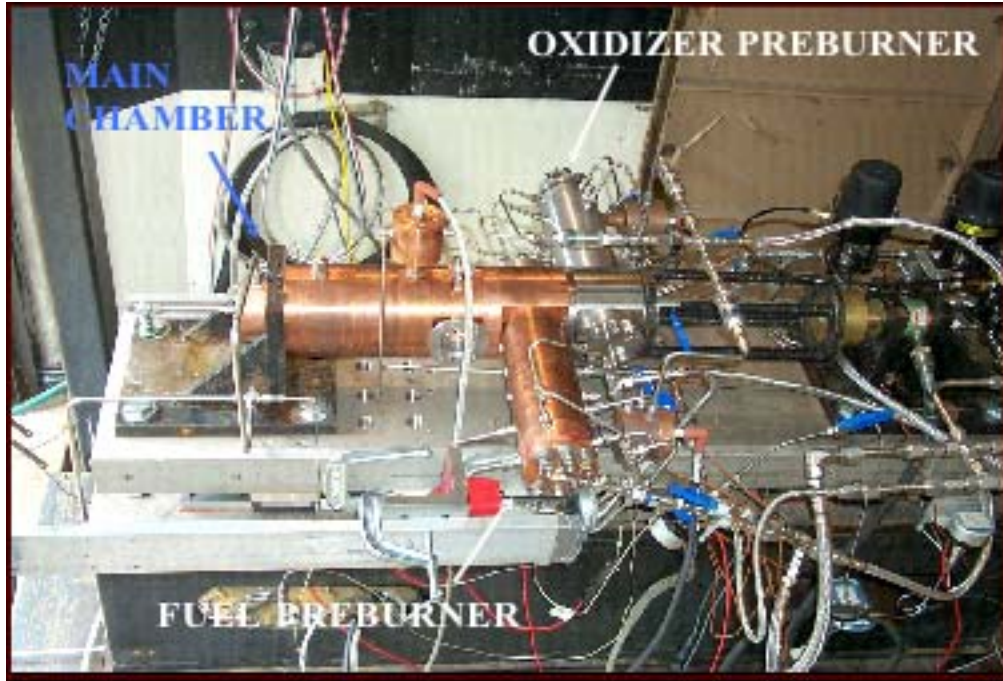

Figure 17. GO₂/GH₂ Test Rig at Penn State University.

The objective of the current task is three-fold. First, data will be taken for two injectors to validate the CFD codes. Second, the validated codes will then be used to design an optimum injector in terms of performance and environments. Finally, this optimized injector will be built and tested to verify the design optimization process. The pre-test CFD work to date has highlighted two issues. The first relates to the type and location of instrumentation required to validate the code for design in this effort. The second has to do with uncertainty in the test rig.

The initial work done to optimize a GO₂/GH₂ element (discussed earlier) required that a fairly large parametric design space be evaluated with CFD. Evaluation of the mixing data (radial species profiles at various axial stations) and environmental data (temperatures on the injector and chamber wall) led to a change in the data to be taken in the upcoming test. Originally, Raman spectroscopy was to be used to measure radial species profiles at two or three axial stations to validate mixing. The mixing of the propellant streams governs the performance and environments. Careful evaluation of the CFD data showed that the near-injector wall temperature profile, an indirect measure of

mixing, showed a much broader response range than the species profiles. Accordingly, a decision was made to measure the wall temperatures and heat fluxes down the length of the chamber. Calculated adiabatic wall temperatures for the two extreme cases are shown in Figure 18. An attempt was made to use this data to aid in placement of the instrumentation in the main chamber. However, uncertainty in the current model predictions and space constraints led to a decision to equally space the thermocouples and heat flux gauges along the chamber as shown in Figure 19.

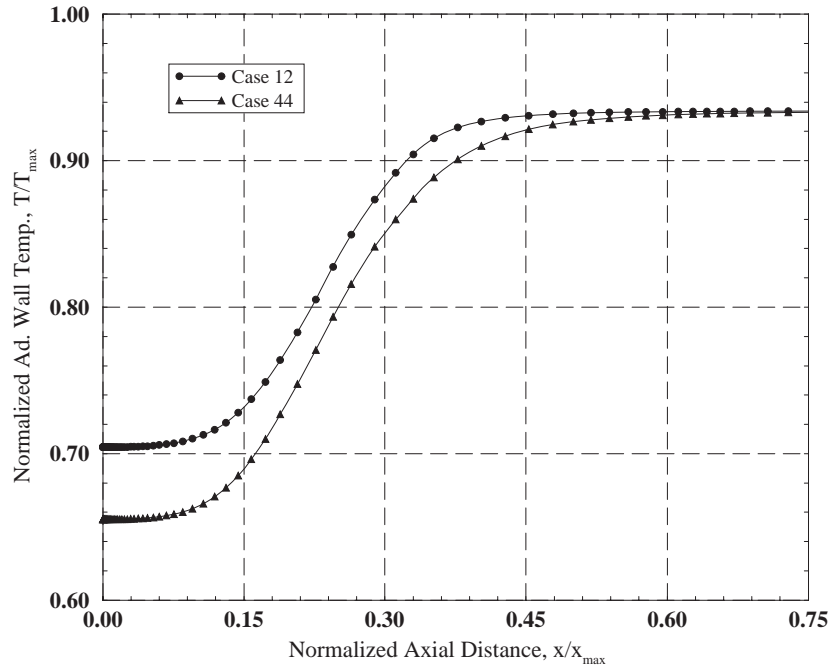

Figure 18. Adiabatic Wall Temperature Comparison for Two Extreme GO_2/GH_2 Cases.

The second issue where pre-test CFD has played a role concerns uncertainty relative to the injector design itself. A diagram of the injector end section of one of the elements to be tested is shown in Figure 20. This diagram depicts the “as built” condition. Since the hot gases from the preburner flow along both walls of the GO_2 tube, the tube heats up and grows in length. This growth is calculated to be $0.22 D_{gp}$, where D_{gp} is the inside diameter of the GO_2 post. Accordingly, the tube is built $0.22 D_{gp}$ short so when tested it should grow to be flush with the injector face. Figure 21 shows the temperature field for five cases of injector tip locations ranging from $0.22 D_{gp}$ upstream of the face to $0.22 D_{gp}$ downstream of the face. The adiabatic wall temperatures from these calculations are plotted in Figure 22. This parametric analysis of the injector indicates the tip location must be well known. It can be seen that the wall temperature spread from high to low is on the order of the extreme cases shown in Figure 18 that were due to intentional design changes.

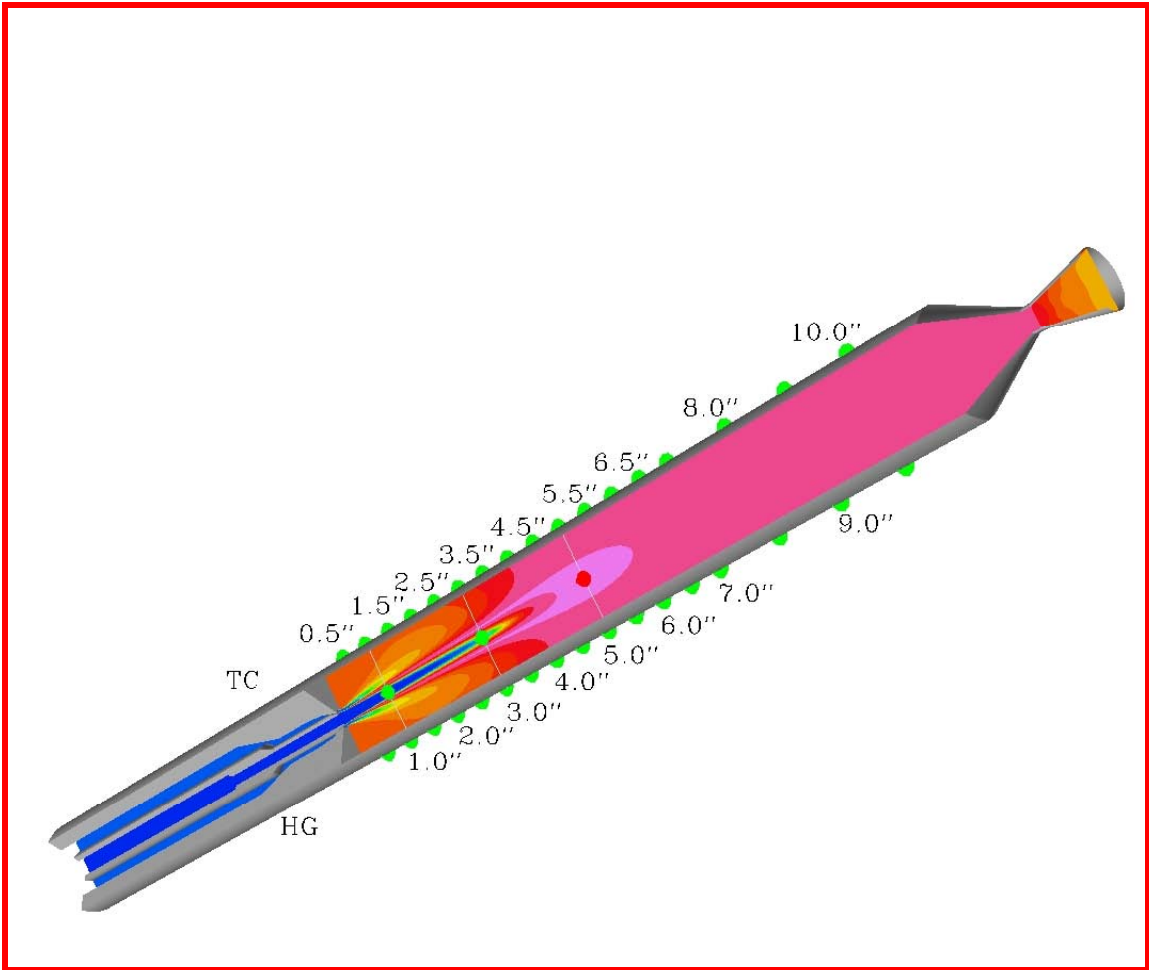

Figure 19. Instrumentation Layout for the GO_2/GH_2 Validation Test.

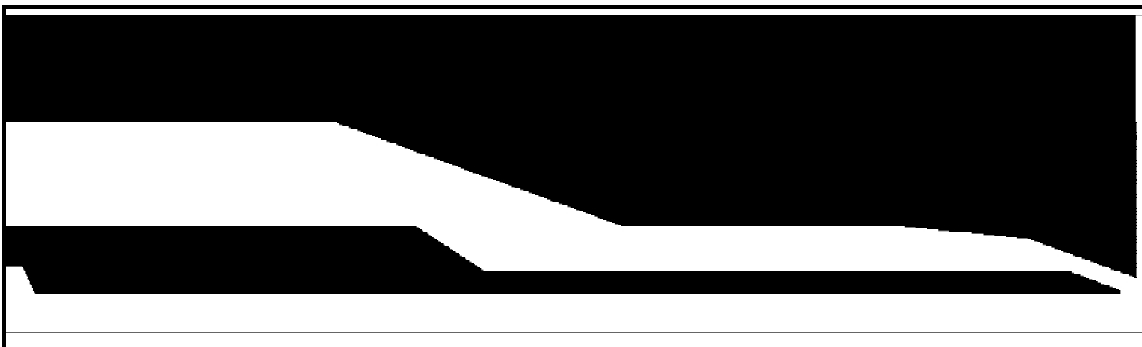

Figure 20. Injector Assembly with GO_2 Post in the As-Built Condition.

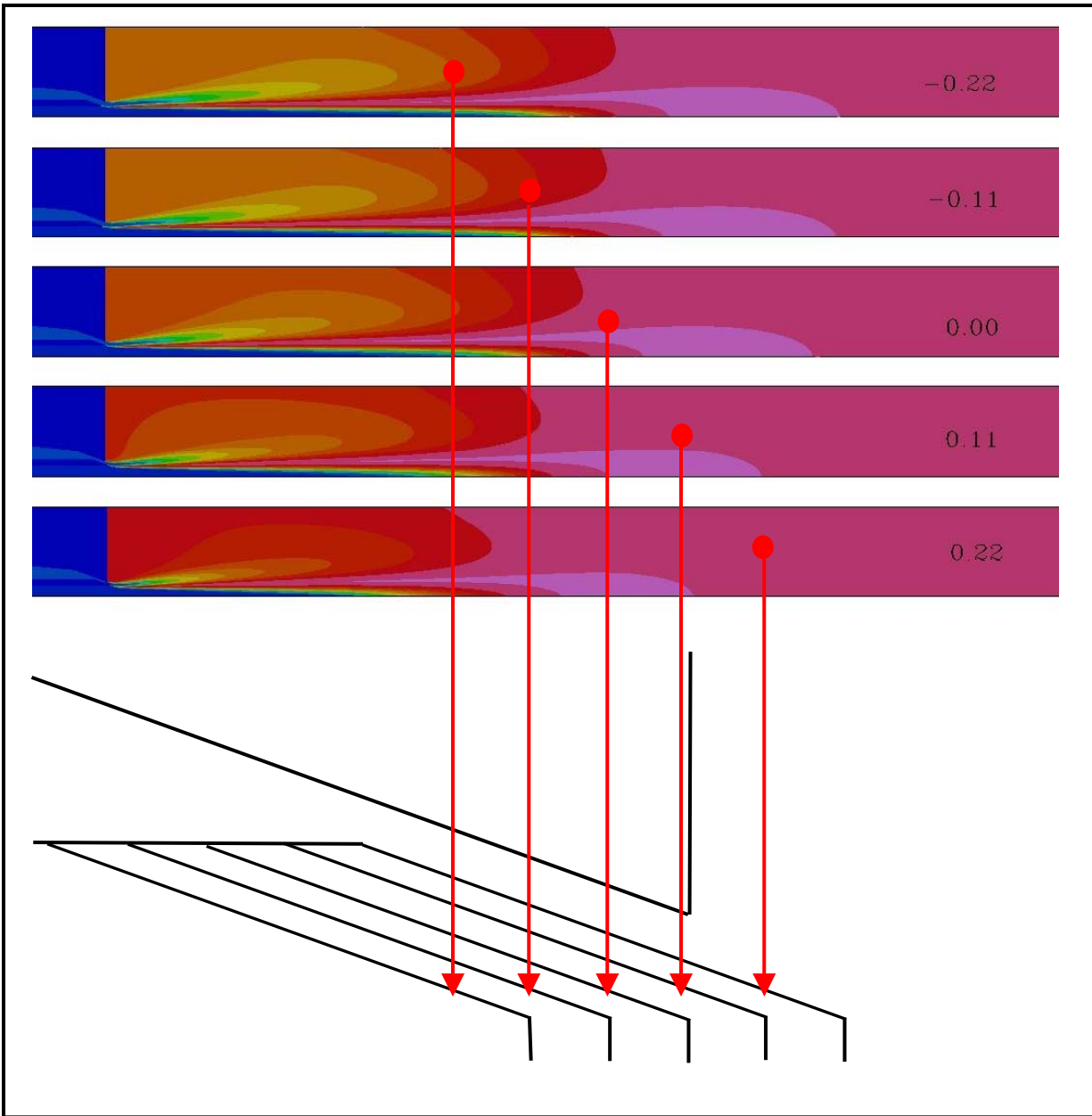

Figure 21. Temperature Fields Resulting from Various GO_2 Post Positions.

There are other potential issues with the experiment. The wall temperature rise shown in Figure 18 needs to be well characterized by the experiment. It is not certain equal spacing of the instrumentation will adequately capture the rise rate. The thermocouples and heat flux gauges have not been used in this rig before and so there is some concern about their ability to survive what are known to be relatively harsh start transients.

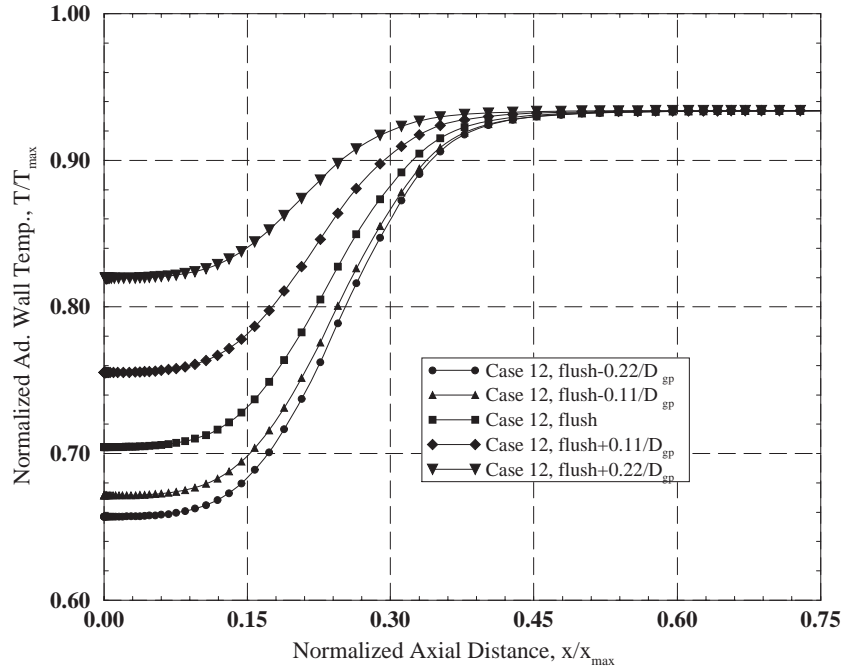

Figure 22. Wall Temperature Comparisons Resulting from Various GO_2 Post Tip Positions.

LO_2/LH_2 EXPERIMENT AT MSFC

The multi-element validation experiment to be performed at MSFC Test Stand 115 will address Model Problem 10.1.1.1.1, which is the LO_2/LH_2 multi-element shear coaxial injector. The objectives of the experiment are to evaluate the mixing accomplished by the injector and to collect data to validate chamber wall heat flux calculations at preburner-type conditions.

This effort is actually a carry over from the RS-83 program. The RS-83 engine design included a preburner that used liquid propellants. This task was already well under way when the RS-83 program was cancelled. Despite the fact that with the cancellation this task does not fit in the near-term roadmap, a decision was made to continue the work. The task was fairly far along (much of the hardware had been designed and fabricated) and it was felt the experience testing multi-element hardware would be beneficial in the long term. Also, just working through doing the CFD analysis to support the test at least peripherally supports the IPD CFD effort. If the test effort is successful, the data will likely be useful for other programs.

A picture of the injector that will be tested in the Modular Combustor Test Article (MCTA) is shown in Figure 23. The injector has seven elements; one at the center surrounded by six on the outside arranged in a circular pattern. Figure 24 shows the injector during water flow check out testing at TS 115. The test matrix, encompassing about 40 tests, is based on four sets of conditions—two chamber pressures, both



Figure 23. LO₂/LH₂ Multi-Element Injector.

supercritical, and two propellant mixture ratios - 0.66 and 0.78. Since the mixture ratios are low, the bulk temperature will also be fairly low. A series of thermocouple spool sections will be employed to evaluate the mixing by making spatially resolved gas temperature measurements. An example of one of the several thermocouple ring configurations to be tested is shown in Figure 25. The rings can be rearranged from test to test to give the desired axial resolution. Within each ring the thermocouples can be moved in or out to provide spatial resolution in the radial direction. The chamber will also be fitted with a window section to enable shadowgraph visualization of the near-injector combustion process. A calorimeter section will be installed for some tests to obtain wall heat flux measurements.

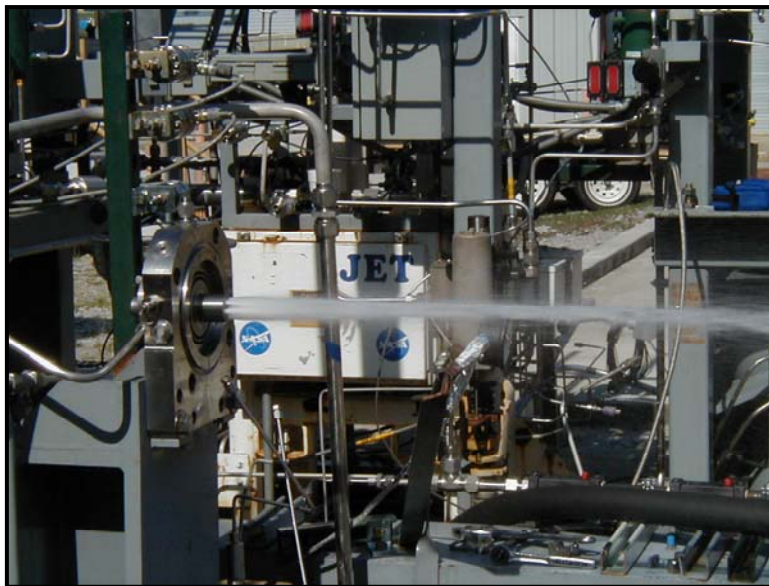

Figure 24. Water Flow Checkout Testing of the LO₂/LH₂ Multi-Element Injector Test 115.

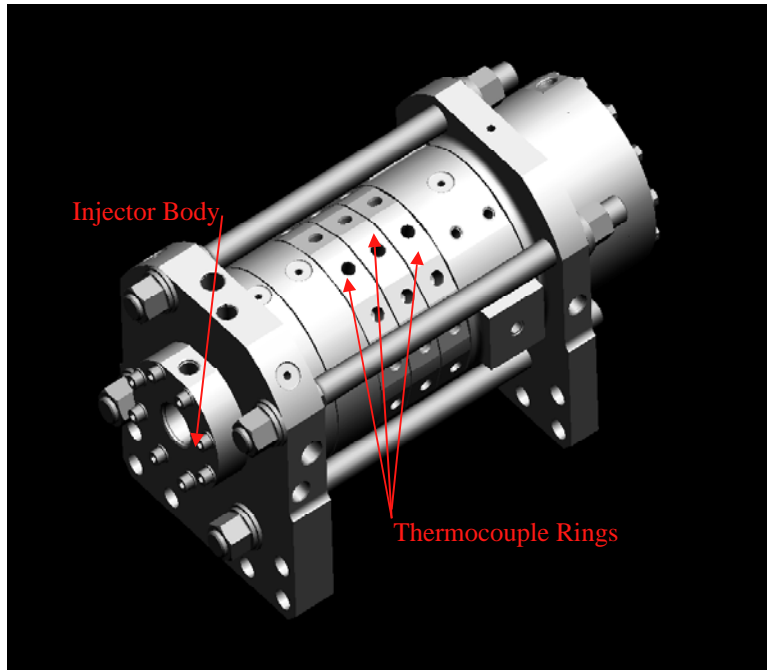

Figure 25. CAD Model of MCTA Showing One Thermocouple Ring Configuration

Pre-test calculations have been made to simulate the three-dimensional flow field in the chamber. A sample calculation of the temperature field is shown in Figure 26. The center element, because it is surrounded by the other elements is probably most representative of an actual preburner element.

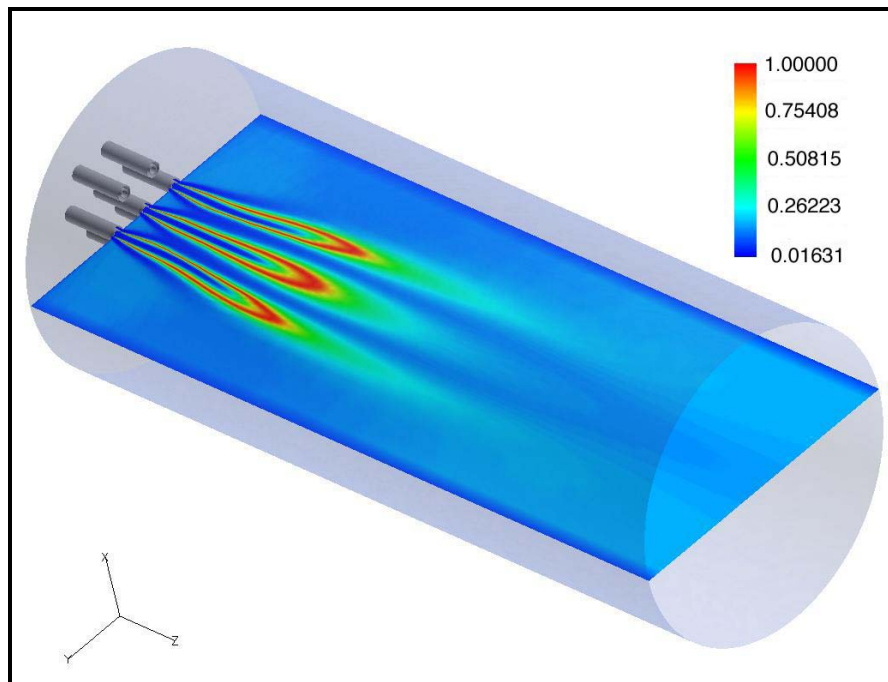

Figure 26. Normalized Temperature Field from Pre-Test MCTA Solution

The most significant potential shortcoming of this experiment is that MSFC has never attempted a test like this for code validation. Since the CFD codes are absolutely unproven for these flows, use of the pre-test analyses to place the instrumentation is risky at best. It is most prudent to start flow field temperature measurements in the far field and work upstream to minimize loss of instrumentation.

GO₂/RP-1 EXPERIMENT AT PURDUE UNIVERSITY

The single element validation experiment to be performed at Purdue University will address Model problem 9.1.1.2.2, which is the GO₂/RP-1 swirl coaxial single element. The objectives of the experiment are to provide a better understanding of several issues related to the ORSC cycle. A portion of the data taken will be used at MSFC for code validation. The validation effort following this data acquisition will support the work being done for both the TR-107 and RS-84 programs.

Two to three elements will be designed and tested at Purdue. A cross section of the baseline line element is shown in Figure 27. The oxidizer stream exits a preburner and enters the element axially. The RP-1 fuel enters tangentially behind a collar just above the cup. The two streams mix and begin to combust in the cup. The nominal chamber pressure is 2266 psia and the nominal mixture ratio is 2.87.

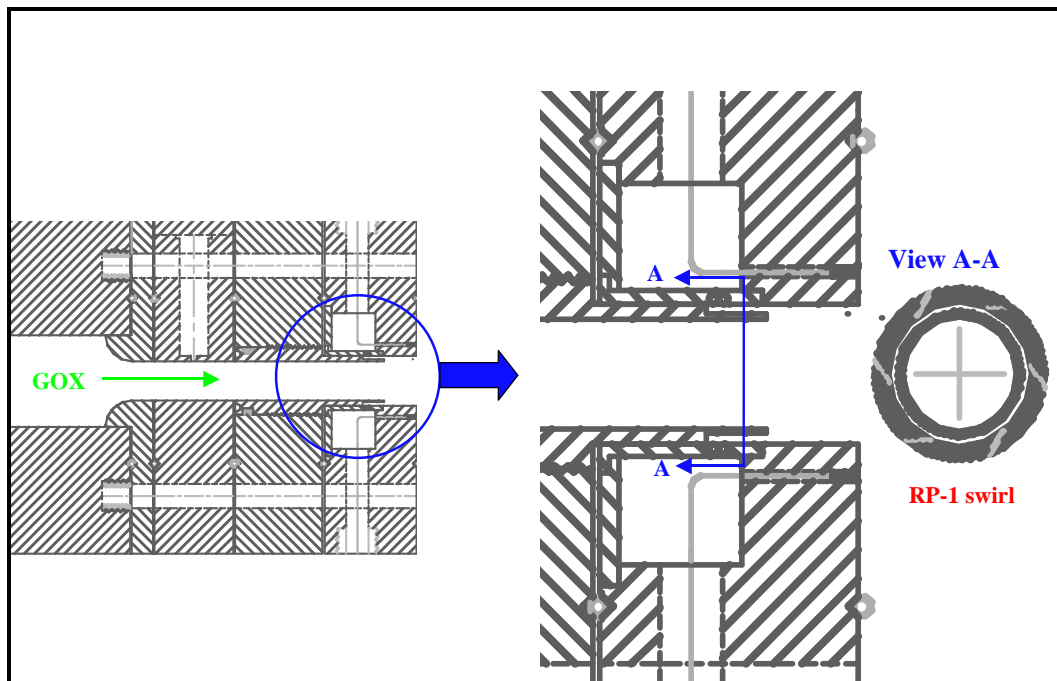

Figure 27. Cross Section of Purdue University ORSC Baseline Element.

A CAD model of the chamber is shown in Figure 28. Calorimeter sections allow wall heat flux measurements. Delta pressure gauges will be installed along the chamber axis to measure the energy release profile. Also, plans are in place to measure overall performance and film cooling efficiency.

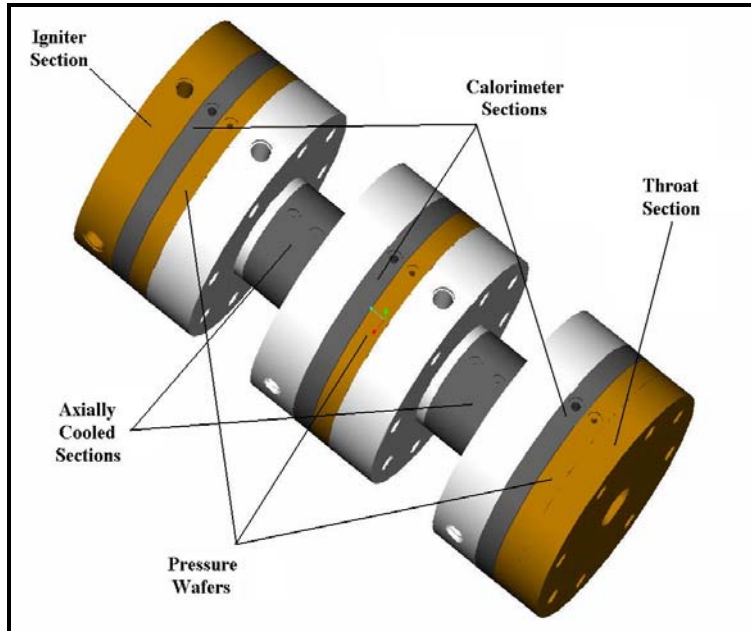

Figure 28. CAD Rendering of Purdue University Single Element Test Chamber

The pre-test CFD effort at MSFC has just begun. Figure 29 shows the three-dimensional grid that will be used for the baseline element and chamber calculations. Figure 30 shows a close-up of the grid focusing on the tangential fuel inlets. MSFC will participate with Purdue in designing the other elements to be tested when the baseline element testing is complete.

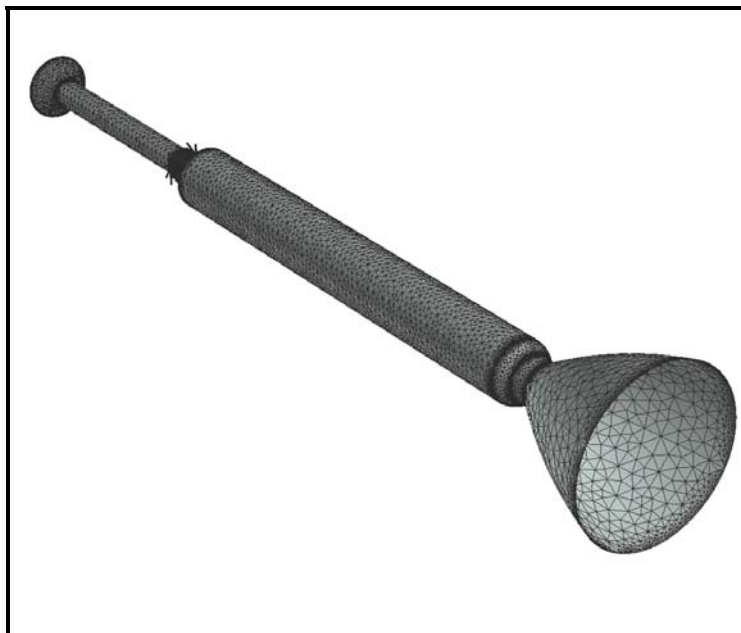

Figure 29. Grid for Purdue University ORSC Baseline Element and Chamber

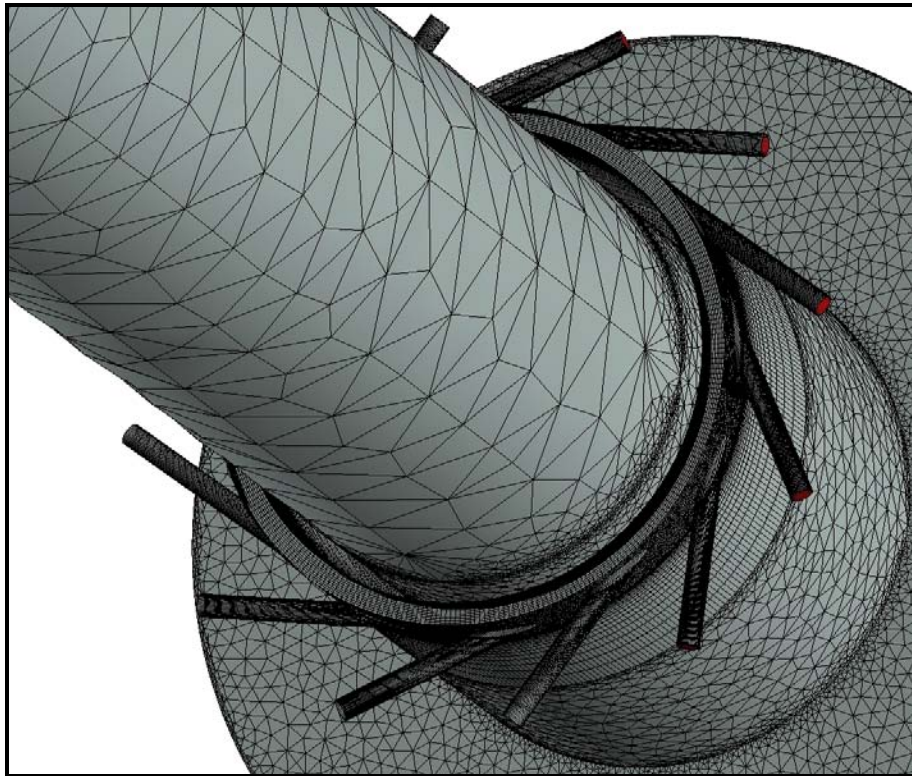

Figure 30. Close-up of the Grid Showing the Tangential Fuel Inlets.

SUMMARY

New programs are forcing American propulsion system designers into unfamiliar territory. For instance, industry's answer to the cost and reliability goals set out by the Next Generation Launch Technology Program are engine concepts based on the Oxygen-Rich Staged Combustion Cycle. Historical injector design tools are not well suited for this new task. The empirical correlations do not apply directly to the injector concepts associated with the ORSC cycle. These legacy tools focus primarily on performance with environment evaluation a secondary objective. Additionally, the environmental capability of these tools is usually one-dimensional while the actual environments are at least two- and often three-dimensional.

CFD has the potential to calculate performance and multi-dimensional environments but its use in the injector design process has been retarded by long solution turnaround times and insufficient demonstrated accuracy. This paper has documented the parallel paths of program support and technology development currently employed at Marshall Space Flight Center in an effort to move CFD to the forefront of injector design. MSFC has established a long-term goal for use of CFD for combustion devices design. The work on injector design is the heart of that vision and the Combustion Devices CFD Simulation Capability Roadmap that focuses the vision.

The SRL concept, combining solution fidelity, robustness and accuracy, has been established as a quantitative gauge of current and desired capability. Three examples of current injector analysis for program support have been presented and discussed. These examples are used to establish the current capability at MSFC for these problems. Shortcomings identified from this experience are being used as inputs to the Roadmap process.

The SRL evaluation identified lack of demonstrated solution accuracy as a major issue. Accordingly, the MSFC view of code validation and current MSFC-funded validation efforts were discussed in some detail. The objectives of each effort were noted. Issues relative to code validation for injector design were discussed in some detail. The requirement for CFD support during the design of the experiment was noted and discussed in terms of instrumentation placement and experimental rig uncertainty.

In conclusion, MSFC has made significant progress in the last two years in advancing CFD toward the goal of application to injector design. A parallel effort focused on program support and technology development via the SCIT Task have enabled the progress.