

# Planetary Airplane Extraction System Development and Subscale Testing

John E. Teter Jr.\*

## Abstract

The Aerial Regional-scale Environmental Survey (ARES) project will employ an airplane as the science platform from which to collect science data in the previously inaccessible, thin atmosphere of Mars. In order for the airplane to arrive safely in the Martian atmosphere, a number of sequences must occur. A critical element in the entry sequence at Mars is an extraction maneuver to separate the airplane quickly (in less than a second) from its protective backshell to reduce the possibility of re-contact, potentially leading to mission failure. This paper describes the development, testing, and lessons learned from building a 1/3 scale model of this airplane extraction system. This design, based on the successful Mars Exploration Rover (MER) extraction mechanism, employs a series of trucks rolling along tracks located on the surface of the central parachute can. Numerous tests using high speed video were conducted at the Langley Research Center to validate this concept. One area of concern was that although the airplane released cleanly, a pitching moment could be introduced. While targeted for a Mars mission, this concept will enable environmental surveys by aircraft in other planetary bodies with a sensible atmosphere such as Venus or Saturn's moon, Titan.

## Introduction

The ARES project will employ an airplane as the science platform to closely survey the surface, identify the constituents of the atmosphere, and assess the residual magnetism of Mars. In order for the airplane to arrive safely in the Martian atmosphere, a number of sequences must occur, starting with Earth launch and ending with deployment. The airplane will be launched from Earth inside a protective aeroshell attached to a spacecraft. It will cruise for almost a year from Earth to Mars. Then, arriving at Mars it will begin the Entry, Descent, and Deployment (EDD) sequence. Figure 1 shows the stages of EDD. Many sequences must occur quickly to allow the plane to fly in the Martian atmosphere. Upon arrival at Mars, the protective forward aeroshell will separate from the spacecraft and coast into the atmosphere of Mars. After atmospheric drag has slowed the assembly to approximately Mach 2, a supersonic parachute will deploy to slow the craft further allowing the forward heatshield to separate. At this point, the airplane will be safely tucked in the swinging and turning backshell, which is suspended from the parachute. Now the final deployment sequence of the airplane begins. The backshell must ascend 0.7 meter relative to the airplane extraction system to expose the airplane. The extraction system will then release the airplane. In less than two minutes, the airplane will fall under the restraint of a drogue chute, unfold, pull up, and fly above the surface of Mars.

This paper concentrates on the mechanical extraction system developed to separate the airplane from its protective backshell. Since the folded tail of the airplane is not sufficient to support the airplane launch loads, a secondary structure is required to extend past the folded wings and tail to attach to the main body of the airplane. This multi-legged, tripod structure which connects the airplane to the backshell has been dubbed the Airplane Extraction System (AES).

---

\* NASA Langley Research Center, Hampton, VA

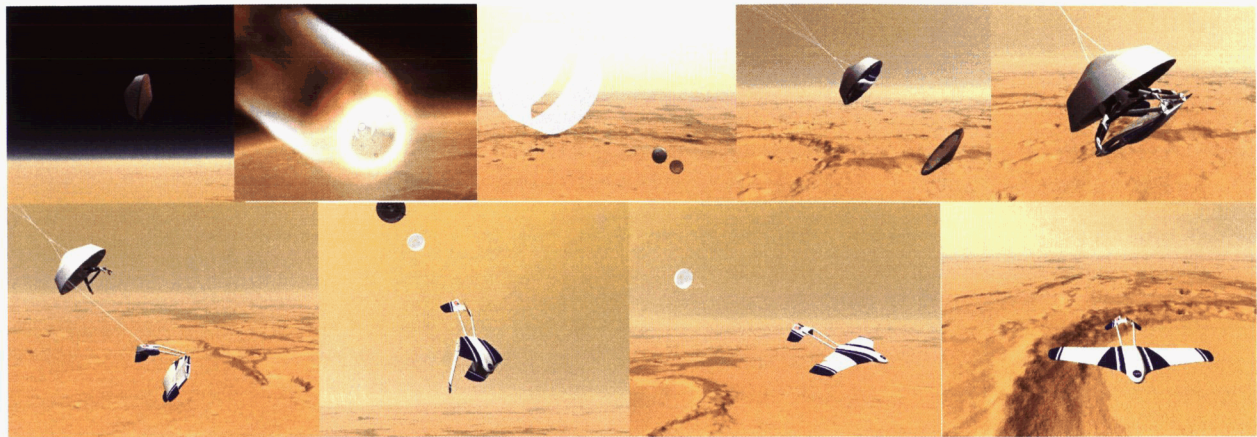

**Figure 1. ARES Entry, Descent, and Deployment sequence**

### Concept Description

The primary functions of the AES are to support the airplane through launch, interplanetary cruise, and entry; and then to guide the airplane safely out of the backshell during extraction. During launch, cruise, and entry, the airplane is held by three kinematic mechanisms to prevent stresses from building up in the airplane structure by allowing the aeroshell and airplane to deform independently. During the extraction phase, six pyrotechnic separation nuts will fire releasing the AES and airplane assembly. The backshell will be free to roll up the AES guided by rollers on the AES's central ring and tracks on the backshell's parachute can. The forces of differential aerodynamic drag between the backshell's high drag supersonic parachute and the low drag free falling AES/airplane assembly will cause the separation. As the parachute can reaches the end of the AES, a second set of pyrotechnic separation nuts will release the airplane from the AES. The folded airplane is then in free fall in the atmosphere until the drogue chute is deployed (Figure 2). The following tests verify the extraction function of the airplane extraction system.



**Figure 2. Extraction concept. Left illustration shows stowed airplane stowed inside the backshell just after heatshield release. Right illustration shows the extracted airplane prior to release from the AES.**

### AES Requirements

#### Key AES Requirements:

- Hold 175-kg airplane securely through Earth launch, interplanetary cruise, and Mars entry
- Guide the airplane out of the backshell and release it in the Martian atmosphere
- Reduce stresses on the airplane due to thermal expansion and contraction
- Low mass
- Fit within the volume of a bi-conic, 2.65-meter-diameter aeroshell
- Airplane/AES minimum natural frequencies, 15-Hz lateral, 35-Hz axial
- Withstand 15-g launch loads

### AES Description

The AES shown in Figure 3 is approximately 2.4-meters wide, 0.9-meter tall, with a mass of 56 kg. It is composed primarily of titanium tubes. Hard stops on the top of the central ring prevent the AES from coming off the parachute can.

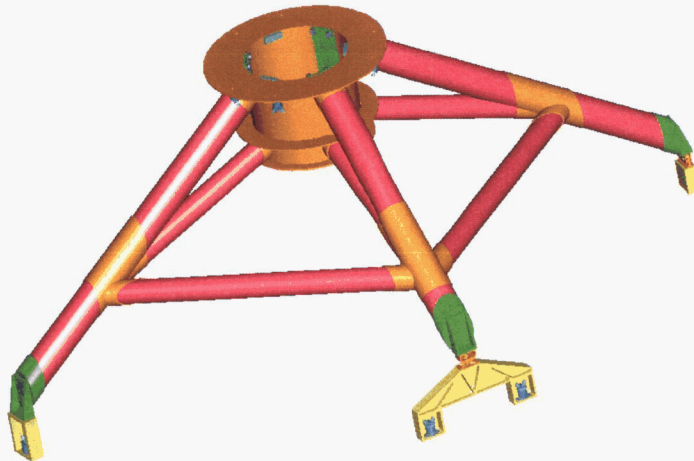

**Figure 3. Airplane Extraction System**

### AES Roller Configuration

Central to the success of the AES is the roller configuration. The configuration is based on the successful MER extraction hardware modified to work with an airplane. Like MER, three tracks are equally spaced on the central parachute can. However, the vertical spacing of the rollers along the track is much greater. The nominal clearance between each pair of rollers and the track is  $\pm 0.25$  mm. The clearance in the system ensures there is no binding as the backshell is pulled away. Yet, the tolerances are close enough to guide the backshell without damaging the plane. The clearances are needed to compensate for machining tolerance stack-ups and thermal growth. Theoretically, this system will still work even if the rollers do not turn, although sliding friction would result. Figure 4 through Figure 8 show the various movements allowed. In each figure, the illustration on the left shows a schematic top view. The red ring and rollers represent the AES. The blue cylinder with three protuberances represent the parachute can and tracks. The right illustration shows a schematic side view for each figure. The four red circles represent one vertical set of AES rollers. The blue rectangle represents one parachute can track. Table 1 summarizes the movements.

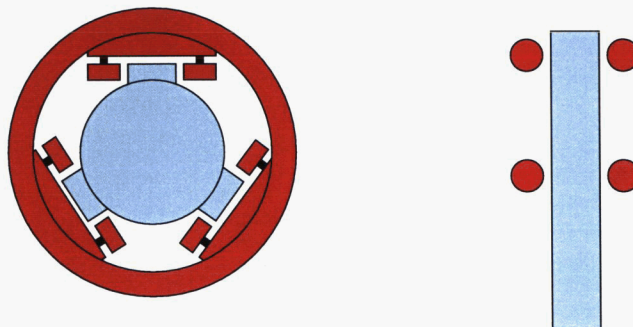

**Figure 4. AES roller configuration, nominal clearance**

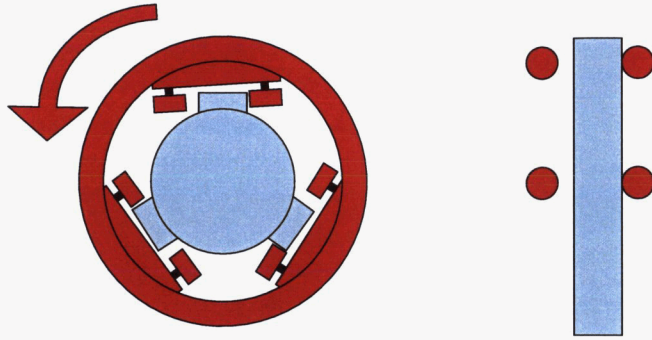

Figure 5. AES roller configuration, axial rotation

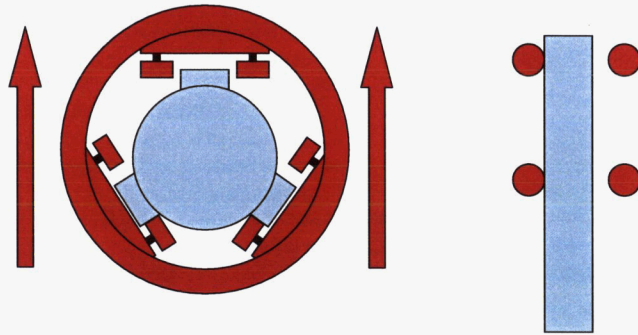

Figure 6. AES roller configuration, radial thrust

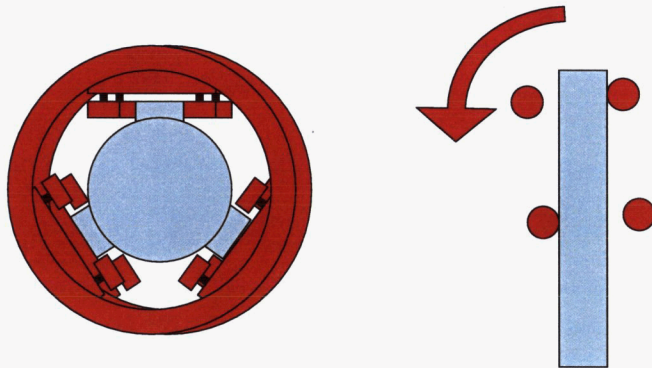
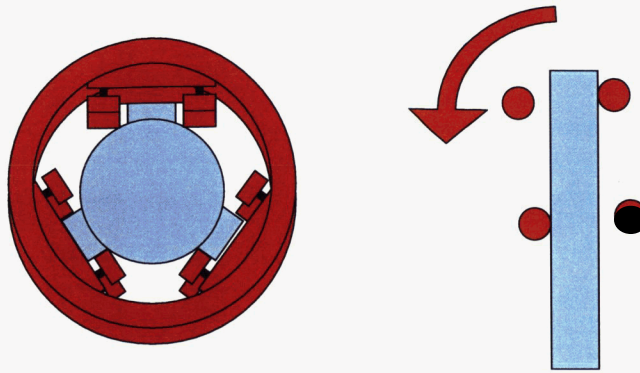

Figure 7. AES roller configuration, X tilt



**Figure 8. AES roller configuration, Y tilt**

**Table 1. AES Clearances and Maximum Movements**

Nominal	$\pm 0.25$ mm clearance between rollers and track
Radial Thrust	$\pm 0.28$ mm side to side thrust
Rotate	$\pm 0.1$ deg axial rotation
X Tilt	$\pm 0.1$ deg tilt from vertical axis
Y Tilt	$\pm 0.09$ deg tilt from vertical axis

### Test Description

In order to demonstrate the extraction design approach and operation of the AES, a functional 1/3 scale model of the backshell, AES, and airplane was created. To simulate the potential orientations in which separation would occur, the model was statically held at various angles and rotations on an A-frame in the high bay of building 1250 at NASA Langley Research Center. Figure 9 shows the test apparatus. Earth gravity was used to simulate the differential drag between the backshell and AES/airplane assembly. Although in actuality the backshell, AES, and airplane are in freefall together, practical considerations for testing dictated that the backshell be held statically for this set of tests. The relative motion is still the same and most of the dynamics are captured. A scale of 1/3 was chosen for ease of manufacturing and handling while testing. High-speed video was used to determine proper extraction. Figure 10 shows a multi-exposure sequence of a typical test.

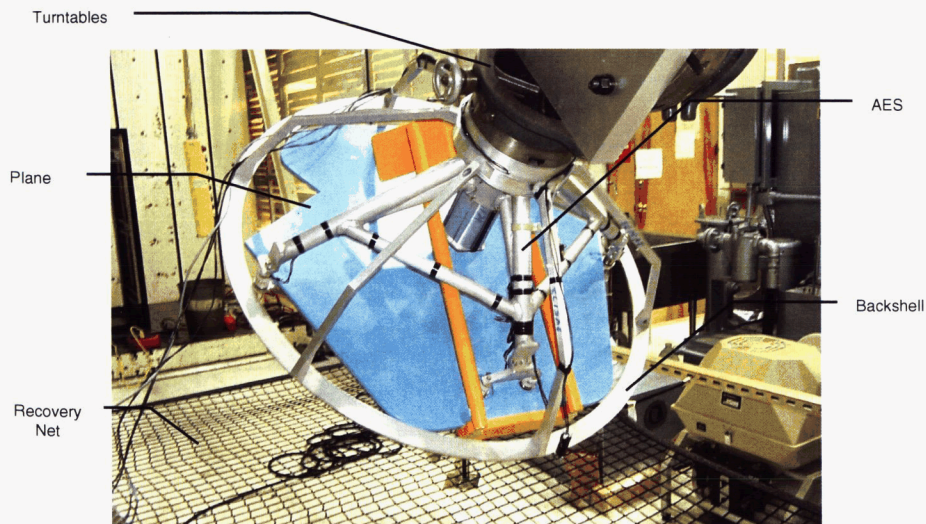

**Figure 9. AES test apparatus**

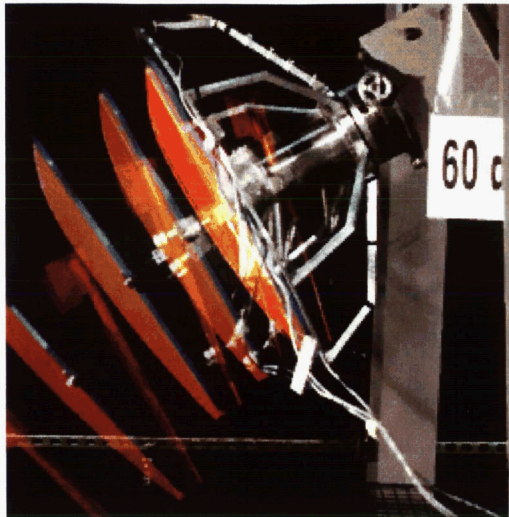

**Figure 10. Multiple exposure picture of a typical extraction test**

#### Key Test Objectives

Key test objectives were:

- Demonstrate proof-of-concept for an airplane extraction system from a backshell under various axial and lateral loading conditions.
- Demonstrate no binding as the airplane extraction system/airplane assembly rolls down the parachute can.
- Demonstrate dynamic clearance between the backshell, the airplane extraction system and the airplane.
- Determine the timing sequence for airplane release.
- Determine effects of the kinematic mounts on release of the airplane.
- Determine electrical cable clearances.
- Determine airplane attitude after release.

#### **Test Hardware**

The 1/3 scale model of the backshell, AES, and airplane were not miniature replicas of the full scale concept. Because of cost, schedule, and practical considerations, some compromises were made. Figure 11 shows a CAD model of the test backshell, AES, and airplane. The following sections give a brief description of the major components.



**Figure 11. 1/3 scale model of the backshell, AES, and airplane**

### Backshell

The scale-model backshell is an aluminum skeleton structure that represents the interior volume of the full-scale backshell. Its mass properties are not represented because it is a form only, static structure. The backshell skin has been eliminated in order to have a clear view of the extraction sequence.

### AES

The scale-model AES is made of welded aluminum for ease of construction. It has approximately equivalent mass, cg, inertia and leg stiffness as the full scale titanium structure. The central cylinder is missing some stiffening rings for ease of manufacture, but they were needed only for high launch loads (15g) and not lightly loaded (2g) extraction loads.

### Airplane

The scale-model plane is a foam, fiberglass, and wood structure. The airplane represents the correct mass properties and roughly the correct volume. However, the stiffness of the airplane has not been matched. The mass, cg, and inertias are scaled from the full-scale airplane. The plan form of the airplane is correct as well as the positioning of the tail booms.

### Kinematic Mounts

The kinematic mounts duplicate the correct function but are greater mass because miniature spherical bearings were not readily available. The fixed point, hinge point, and swivel points of attachment between the AES and airplane functionally match the full-scale model.

### Release Mechanism

The full-scale AES and airplane are released with pyrotechnic separation nuts (Figure 12). To reduce cost and safety concerns, electromagnets were used on the scale model. While electromagnets do not release as cleanly (residual magnetism, longer response time) as pyrotechnics, these devices allow for multiple tests without replacing hardware. The electromagnets also increase the mass of the AES.

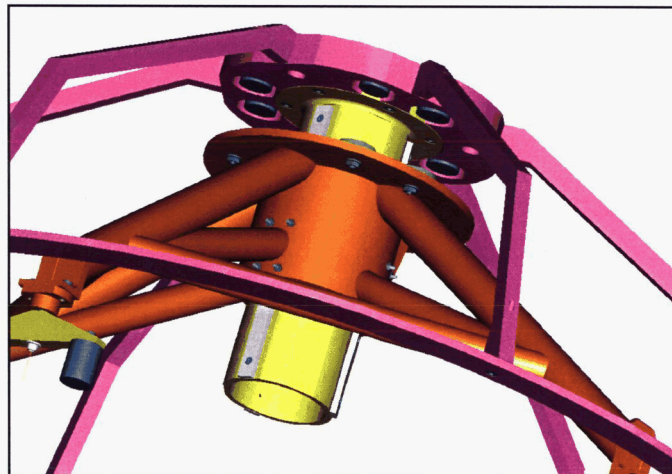

**Figure 12. 1/3 scale model release mechanism**

### Parachute Can

The parachute can is made of thick aluminum for ease of manufacturing as opposed to the thin titanium on the full-scale hardware. Also, a steel track instead of an aluminum track was used because of its durability.

### Rollers

The rollers for the scale model are mounted on three independent rings for ease of construction and the ability to move their locations easily (Figure 13). The full-scale AES has three axial trucks instead of three rings. The important parameter is the location of the rollers in relation to the tracks and not the structure that holds them.

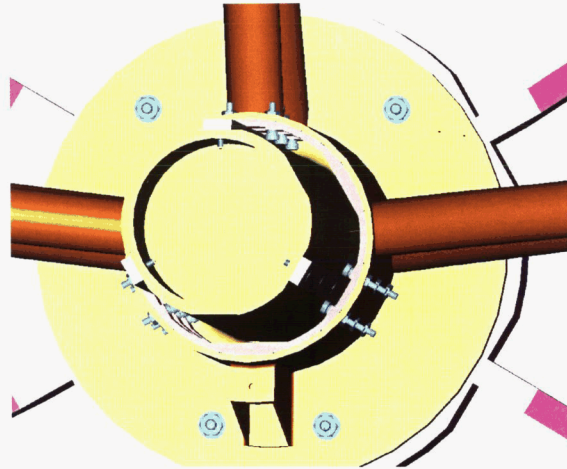

**Figure 13. 1/3 scale model rollers**

Scaling

The apparatus is dynamically scaled to 1/3 with the proper mass, center of gravity, and inertia properties. The scaling factors are summarized in Table 2.

**Table 2. Scaling Factors**

Property	Units	1/3 Scaling Factor Fraction	1/3 Scaling Factor Decimal
Length	m	1/3	.333
Mass	kg	$(1/3)^3 = 1/27$	.037
Time	sec	$(1/3)^{0.5}$	.577
Density	kg/m <sup>3</sup>	$(1/3)^3 / (1/3)^3$	1
Velocity	m/sec	$(1/3) / (1/3^{0.5})$	.192
Acceleration	m/sec <sup>2</sup>	$(1/3) / (1/3^{0.5})^2 = 1$	1
Force	kg*m/sec <sup>2</sup>	$(1/3)^3 * 1 = 1/27$	.037
Pressure	N/m <sup>2</sup>	$(1/27) / (1/3)^2 = 1/3$	.333
Rotation	deg/sec	$1 / (1/3^{.5})$	1.732
Inertia	kg* m <sup>2</sup>	$(1/3)^3 * (1/3)^2 = 1/27 * 1/9 = 1/243$	.0041

Mass Properties

The mass properties of the apparatus are summarized in Table 3. The full scale information was extracted from a ProEngineer CAD model of the ARES concept. The actual scale model information was extracted from an as built ProEngineer CAD model with selected information verified by measurement. The actual hardware corresponds well to the calculated properties. The mass of the airplane increased from configuration 1 to 2 to better reflect the calculated mass. The mass of the AES was greater because the electromagnets holding the airplane are heavier than an equivalent pyrotechnic device would be. The full-scale airplane has a slight x cg offset, however, the x cg of airplane2 is essentially zero for ease of



manufacturing but the error is negligible. The airplane inertias about the center of gravity are higher than prescribed but still within reason.

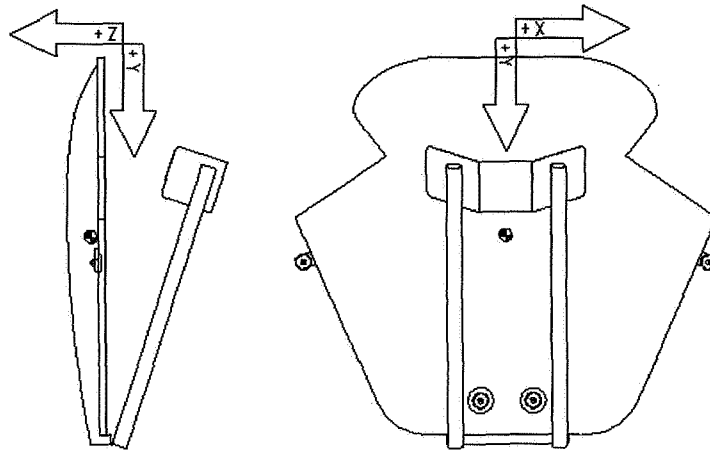

Figure 14. Airplane coordinate system

Table 3. Mass Properties

Item	Unit	Full Scale	1/3 Scale Factor	1/3 Scale Model Calculated	1/3 Scale Model Actual	Percent of Calculated
Mass	$(1/3)^3 = 1/27$					
Airplane configuration 1	kg	170	0.037	6.296	5.176	82.2%
Airplane configuration 2	kg	170	0.037	6.296	6.17	98.0%
AES	kg	56	0.037	2.074	2.81	135.5%
Backshell	kg	149.2	0.037	5.526	5.5	99.5%
cg	1/3					
from airplane coordinate system						
Airplane1 x cg	mm	13.47	0.333	4.49	0.003	0.1%
Airplane1 y cg	mm	1222.00	0.333	406.93	410	100.8%
Airplane1 z cg	mm	193.80	0.333	64.54	69.9	108.3%
from airplane coordinate system						
Airplane2 x cg	mm	13.47	0.333	4.49	0.002	0.0%
Airplane2 y cg	mm	1222.00	0.333	406.93	414	101.7%
Airplane2 z cg	mm	193.80	0.333	64.54	71.9	111.4%
from separation airplane						
Backshell y cg (axial)	mm	529.00	0.333	176.16	138	78.3%
Inertia	$(1/3)^3 * (1/3)^2 = 1/27 * 1/9 = 1/243$					
from airplane coordinate system						

Item	Unit	Full Scale	1/3 Scale Factor	1/3 Scale Model Calculated	1/3 Scale Model Actual	Percent of Calculated
Airplane1 lxx	g-mm <sup>2</sup>	2.99E+11	0.0041	1.23E+09	1.06E+09	86.1%
Airplane1 lyy	g-mm <sup>2</sup>	2.12E+10	0.0041	8.72E+07	9.76E+07	111.9%
Airplane1 lzz	g-mm <sup>2</sup>	3.01E+11	0.0041	1.24E+09	1.09E+09	88.0%
from airplane cg						
Airplane1 lxx	g-mm <sup>2</sup>	3.83E+10	0.0041	1.58E+08	1.79E+08	113.6%
Airplane1 lyy	g-mm <sup>2</sup>	1.49E+10	0.0041	6.13E+07	7.27E+07	118.6%
Airplane1 lzz	g-mm <sup>2</sup>	4.61E+10	0.0041	1.9E+08	2.32E+08	122.3%
from airplane coordinate system						
Airplane2 lxx	g-mm <sup>2</sup>	2.99E+11	0.0041	1.23E+09	1.29E+09	104.8%
Airplane2 lyy	g-mm <sup>2</sup>	2.12E+10	0.0041	8.72E+07	1.10E+08	126.1%
Airplane2 lzz	g-mm <sup>2</sup>	3.01E+11	0.0041	1.24E+09	1.31E+09	105.8%
from airplane cg						
Airplane2 lxx	g-mm <sup>2</sup>	3.83E+10	0.0041	1.58E+08	2.18E+08	138.3%
Airplane2 lyy	g-mm <sup>2</sup>	1.49E+10	0.0041	6.13E+07	7.86E+07	128.2%
Airplane2 lzz	g-mm <sup>2</sup>	4.61E+10	0.0041	1.9E+08	2.76E+08	145.5%
from backshell cg:						
Backshell lxx	g-mm <sup>2</sup>	7.45E+10	0.0041	3.07E+08	3.59E+08	117.1%
Backshell lyy	g-mm <sup>2</sup>	1.21E+11	0.0041	4.98E+08	4.90E+08	98.3%
Backshell lzz	g-mm <sup>2</sup>	7.20E+10	0.0041	2.96E+08	3.59E+08	121.2%

### Results

There were no major surprises in testing. The airplane released cleanly in all cases. The kinematic mounts did not interfere with the release of the airplane. Yet several improvements can be made. Figure 15 shows pictures of the first four tests.

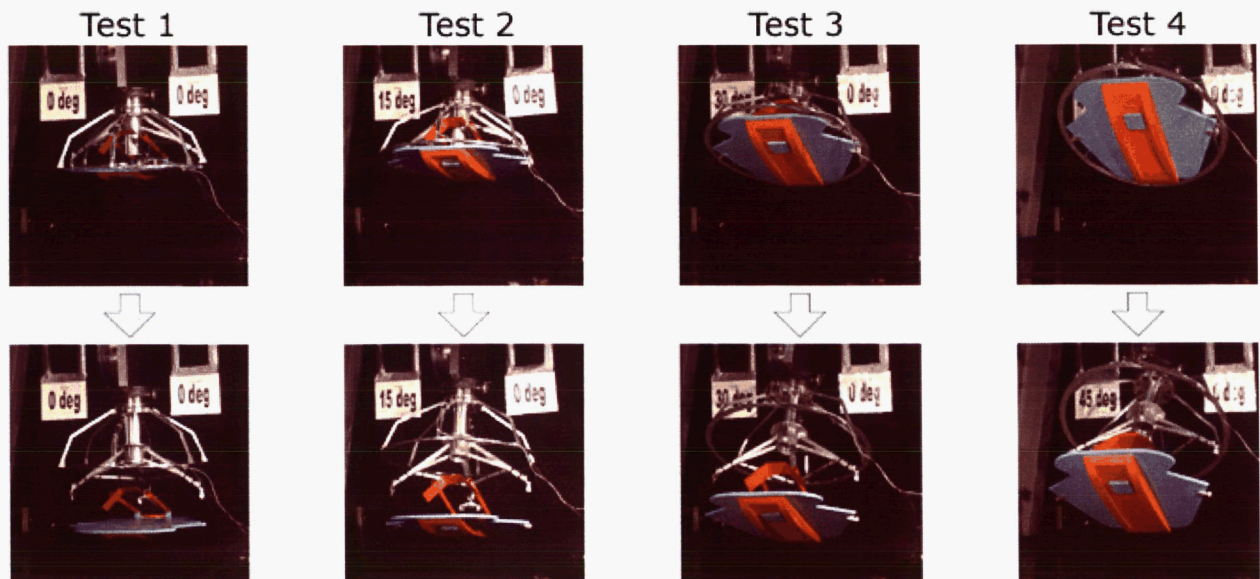

Figure 15. Setup and release of test 1 - 4

Table 4 shows the test matrix. The azimuth refers to the position of the airplane about the release axis. Zenith refers to the position of the apparatus in reference to the vertical. Zero degree is vertical. The roller configuration column refers to the placement of the rings of rollers vertically along the central canister. The first group of tests positioned rollers in all three possible location, top, middle, and bottom. The second group of tests positioned roller sets only on the top and bottom ring. The release trigger point refers to the point at which the airplane is released relative to the top of the parachute can. The airplane was tested in two configurations. The first one had a smaller mass than the second. The video number refers to the video file name. The frame rate was reduced from 500 to 250 frames/sec for some of the high zenith angle tests in order for the video data for each test to fit on one compact disc.

Tests 1 – 39 were conducted with the video camera isometric to the test apparatus to capture movement in all three axes. For tests 40 – 47 several improvements were made. The video camera was moved perpendicular to the motion of the airplane and targets were added. These improvements allowed specific points on the airplane to be tracked without compensating for the angle of the video camera. LED indicator lights showing power to the AES and airplane electromagnets were placed in the camera's field of view. This gave precise information as to when the AES and airplane were released.

**Table 4. Airplane Extraction System Test Matrix**

<b>Test #</b>	<b>Azimuth</b>	<b>Zenith</b>	<b>Roller Configuration</b>	<b>Release Trigger Point</b>	<b>Airplane Configuration</b>	<b>Video #</b>	<b>Frame Rate</b>
	(deg)	(deg)					(frame/ sec)
1	0	0	top, mid, bottom	bottom	1	test1a	500
2	0	15	top, mid, bottom	bottom	1	test2	500
3	0	30	top, mid, bottom	bottom	1	test3	500
4	0	45	top, mid, bottom	bottom	1	test4a	500
7	45	30	top, mid, bottom	bottom	1	test7	500
10	90	15	top, mid, bottom	bottom	1	test10	500
11	90	30	top, mid, bottom	bottom	1	test11	500
12	90	45	top, mid, bottom	bottom	1	test12	500
15	135	30	top, mid, bottom	bottom	1	test15	500
18	180	15	top, mid, bottom	bottom	1	test18	500
19	180	30	top, mid, bottom	bottom	1	test19	500
20	180	45	top, mid, bottom	bottom	1	test20	500
21	0	60	top, mid, bottom	bottom	1	test21	250
23	90	60	top, mid, bottom	bottom	1	test23	250
25	180	60	top, mid, bottom	bottom	1	test25	250
26	0	75	top, mid, bottom	bottom	1	test26a	250
28	90	75	top, mid, bottom	bottom	1	test28	250
30	180	75	top, mid, bottom	bottom	1	test30	250
32	0	60	top, mid, bottom	bottom	2	test32	250
33	0	75	top, mid, bottom	bottom	2	test33a	250
36	0	60	top, mid, bottom	50%	2	test36	250
37	0	75	top, mid, bottom	50%	2	test37	250
38	180	75	top, mid, bottom	bottom	2	test38	250
39	90	75	top, mid, bottom	bottom	2	test39	250
40	0	30	top, bottom	bottom	2	test40	500
41	180	30	top, bottom	bottom	2	test41	500
42	90	30	top, bottom	bottom	2	test42	500

Test #	Azimuth	Zenith	Roller Configuration	Release Trigger Point	Airplane Configuration	Video #	Frame Rate
43	0	45	top, bottom	bottom	2	test43	500
44	180	45	top, bottom	bottom	2	test44	500
45	180	60	top, bottom	bottom	2	test45	500
46	0	60	top, bottom	bottom	2	test46	500
47	35	0	top, bottom	bottom	2	test47	500

### Objectives Met

**Table 5. Objectives Met**

Objective	Met	Comments
Demonstrate proof-of-concept for an airplane extraction system from an aeroshell under various axial and lateral loading conditions	Yes	Concept works
Demonstrate no binding as the AES/plane assembly rolls down the parachute can	Yes	AES/airplane assembly does not bind, even with damaged rollers
Demonstrate dynamic clearance between the aeroshell, the AES and the airplane	Yes	No clearance problems
Determine timing sequence for airplane release	Yes	Airplane release at bottom of the stroke is fine
Determine effects of kinematic mounts on release of the airplane	Yes	Kinematic mounts do not effect release negatively
Determine electrical cable clearances	Yes	No cable hang-ups
Determine airplane attitude after release	Yes	Determined from video

### Problems Discovered

One point of interest was that the bottom rollers were damaged after many tests because the airplane extraction system would rebound after airplane release. This is not a problem for the actual flight since the AES must only work once and is then discarded, but it may be a problem if ground testing is required on flight hardware. A wedge or positive stop at the end of travel is being considered to eliminate this motion.

High-speed video revealed a pitching motion in the airplane after it was released for some extreme orientations. This is a problem in two ways. First, the pitch may cause the airplane to hit the backshell or AES under certain circumstances, although it was not observed in this set of tests. Second, the airplane now is starting to tumble. This motion must be counteracted by the drogue chute to avoid problems while unfolding the tail and wings. The ideal case would be to have the airplane to separate without a pitching moment.

There are several possible causes for this pitching. Since the AES and airplane are not symmetric about the vertical parachute can axis, there is a cg offset. This offset can cause the airplane to pitch after separation. Second, after the next to the last set of rollers leaves the track, the AES is free to pitch slightly under the influence of gravity and aeroloads. Third, the electromagnets used to release the airplane and the airplane extraction system contains residual magnetism after they are turned off. Sometimes this causes the aft end of the airplane to release after the wing points have separated. This influence appears small, and will be eliminated with pyrotechnics for the flight hardware. Design modifications are being considered to address the other issues.

### **Future Work**

The next series of subscale tests should have the entire backshell, AES, and airplane assembly free fall in order to capture the effects of dynamics as the backshell rotates and swings during entry. This complex interaction should reveal new insights.

A full-scale high-altitude balloon drop test is scheduled for 2006. This test will include a form, fit and function backshell, AES, and airplane called the High Altitude Drop Demonstrator 2. The goal of the test is to verify all aspects of the EDD at simulated Mars conditions from 30,000 meters in Earth's atmosphere.

### **Conclusions**

Extraction is a critical event in the entry, descent, and deployment sequence for the Mars airplane. This development and subscale testing proves the viability of the concept. Subscale testing demonstrated a clean release of the airplane in every instance. Yet testing also showed that pitching of the airplane needs to be addressed.

### **References**

Wright, Henry S. et al., *ARES Mission Overview – Capabilities and Requirements of the Robotic Aerial Platform*, AIAA 2003-6577

Levine, Joel S. et al., *Science from a Mars Airplane: The Aerial Regional-Scale Environmental Survey (ARES) of Mars*, AIAA 2003-6576

MER Aeroshell Critical Design Review presentations, May 30-31, 2001

### **Acknowledgements**

I would like to acknowledge the contributions of the many people who made this development a success:

- Henry Wright for funding and guidance
- Charles Bailey and Joseph Hickman for assembling and modifying hardware
- Tom Lash and Norman McRae for development of the electromagnetic release system
- Paul Bagby for capturing high-speed video
- Gary Qualls for photogrammetry