

The Precision Formation Flying Integrated Analysis Tool (PFFIAT)

Eric Stoneking, Richard G. Lyon
NASA Goddard Space Flight Center

Dr. Edie Sears
Global Science and Technology, Inc.

Victor Lu
Emergent Space Technologies, Inc.

Several space missions presently in the concept phase (e.g. Stellar Imager, Sub-millimeter Probe of Evolutionary Cosmic Structure, Terrestrial Planet Finder) plan to use multiple spacecraft flying in precise formation to synthesize unprecedentedly large aperture optical systems. These architectures present challenges to the attitude and position determination and control system; optical performance is directly coupled to spacecraft pointing with typical control requirements being on the scale of milliarcseconds and nanometers. To investigate control strategies, rejection of environmental disturbances, and sensor and actuator requirements, a capability is needed to model both the dynamical and optical behavior of such a distributed telescope system. This paper describes work ongoing at NASA Goddard Space Flight Center toward the integration of a set of optical analysis tools (Optical System Characterization and Analysis Research software, or OSCAR) with the Formation Flying Test Bed (FFTB). The resulting system is called the Precision Formation Flying Integrated Analysis Tool (PFFIAT), and it provides the capability to simulate closed-loop control of optical systems composed of elements mounted on multiple spacecraft. The attitude and translation spacecraft dynamics are simulated in the FFTB, including effects of the space environment (e.g. solar radiation pressure, differential orbital motion). The resulting optical configuration is then processed by OSCAR to determine an optical image. From this image, wavefront sensing (e.g. phase retrieval) techniques are being developed to derive attitude and position errors. These error signals will be fed back to the spacecraft control systems, completing the control loop. A simple case study is presented to demonstrate the present capabilities of the tool.

I. Introduction

It is a fact of optical astronomy that a telescope's resolving power is limited by the size of its aperture. Up to the present, space-based observatories have employed monolithic optical systems, whose size is constrained by the dimensions of the launch vehicle. The quest for greater resolution and light-gathering ability is leading to a new generation of telescope concepts that overcome this constraint through use of segmented optics (e.g. the James Webb Space Telescope) or, even more dramatically, by distributing the telescope elements among two or more co-orbiting spacecraft (e.g. MAXIM, Stellar Imager, Terrestrial Planet Finder).

These architectures present new challenges to the determination and control of both the attitude and relative positions of the spacecraft in the formation. To form optical images in visible wavelengths requires orientation knowledge and control of the telescope elements to the order of milliarcseconds, and relative position knowledge and control to the order of nanometers. A natural way to approach this challenging control problem is to use the science image data itself as a sensor input, deriving from it error signals which may be fed back into the spacecraft attitude and translation control laws.

Many questions need to be addressed in the course of finding a practical engineering solution to this combined optics and dynamics problem. This paper describes ongoing efforts at NASA Goddard Space Flight Center to develop an integrated simulation tool for the study and validation of the associated algorithms and models. The simulation is dubbed the Precision Formation Flying Integrated Analysis Tool (PFFIAT). It incorporates two distinct sets of software functions, "42" and OSCAR, which will be further described below. First, we briefly describe the Formation Flying Test Bed (FFTB) facility, which hosts PFFIAT.

II. The Formation Flying Test Bed

The FFTB is a research and development facility within the NASA Goddard Space Flight Center (GSFC) Mission Engineering and Systems Analysis Division (Code 590). It was conceived in 1999 in response to the need to research, develop, test and validate navigation, control, and communications technologies for spacecraft formations. In general, formations are used to achieve coordinated observations from multiple instruments, or to provide virtual platforms that combine to form a single instrument, and thus typically have relative positioning and attitude requirements more stringent than those associated with constellations or sensor webs. The FFTB is evolving to be capable of supporting end-to-end simulations of distributed space system (DSS) concepts, including formations, constellations, and sensor webs.

At present, the FFTB hardware suite is composed of a GPS simulator, GPS receivers, flight computers, crosslink transceivers, the Crosslink Channel Simulator (CCS), and computers for providing environment models and visualization. The FFTB supports up to four GPS receivers, flight computers, and crosslinks, in order to host hardware-in-the-loop simulations of a formation of four spacecraft. Additional spacecraft may be modelled in software, and the FFTB architecture allows for future expansion with added hardware. The FFTB hardware suite and its interfaces are shown in Figure 1.

The GPS simulator is composed of two Spirent STR4760 GPS signal generators and the Spirent Interface Computer. The Spirent Interface Computer is either a Windows XP computer or a Compaq computer running VMS. The STR4760 GPS signal generators produce the RF signals according to the GPS ICD-200 specification. The FFTB currently supports the Navigator [Wennersten], Orion [Montenbruck], and Ashtech [Haas] GPS receivers, and can readily be modified to support any GPS receiver. The GPS receivers are connected to the flight computers by a serial RS-232 interface.

The flight computers host the navigation, guidance and control algorithms, which use the measurement data provided by the GPS receivers and provide maneuver commands to control the spacecraft and the formation. The flight computers also receive data from other spacecraft flight computers via the crosslink transceivers. The Crosslink Channel Simulator is used to model inter-spacecraft RF communication, which not only serves as a communication link between spacecraft in a formation, but may be used to sense inter-spacecraft distance. In environments beyond the reach of GPS, this will be a crucial source of relative position data.

The Environment Computer provides the truth model of the spacecraft state and environment models for the simulation. These data is provided via ethernet local area network (LAN) connections to the GPS simulator and CSS in order to drive the simulation. The Environment Computer also receives spacecraft maneuver information from the flight computers.

The Visualization Computer is used to provide feedback to the user in near realtime. Various data can be plotted using the PlotFFTB tool. The formation and individual spacecraft trajectories and attitude can be visualized using STK/VO. The Visualization Computer may receive data from any computer connected to the LAN.

The primary software that coordinates all the elements of the FFTB into a formation simulation is the Spacecraft Trajectory and Attitude Real-time Simulator (STARS) Suite. STARS is an adjustable object-oriented framework for coordinating composite timer and vehicle dynamics software modules. It runs on

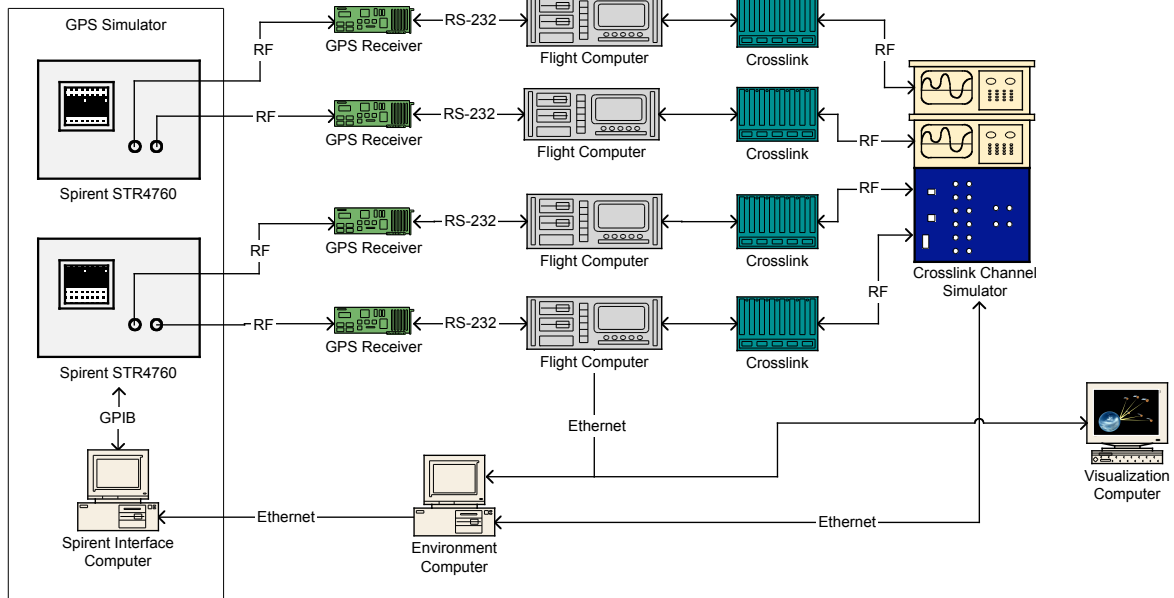

Figure 1. FFTB Hardware Systems Diagram

the Environment Computer, and provides the true spacecraft states to the simulation. STARS is configurable in its nature; for example, different orbit propagators can be swapped for usage in STARS' vehicle dynamics engine.

For the nominal configuration of the STARS, the main components are the core Environment Simulation module, the Hardware Timer module, and the Vehicle Dynamics Engine, which includes the Maneuver, Orbit Model, and Formation modules. The core Environment Simulation module is the initializing module that reads in user-defined parameters and initiates the Timer and Vehicle Dynamics Engine threads. When the Timer receives a 10 Hz pulse from the Spirent device, the Vehicle Dynamics Engine runs through a single cycle in which it determines if a Maneuver is to be performed, propagates the spacecraft states using the Dynamics Model's selected propagator, and updates the spacecraft states stored in the Formation module. Figure 2 shows the program flow for the nominal STARS configuration. The Dynamics Model in the nominal STARS configuration relies on GEONS, the GPS Enhanced Onboard Navigation System [GEONS] as the propagator element that predicts the new spacecraft states for each member of the formation.

For PFFIAT, STARS needed to be reconfigured to incorporate the different processing logic resulting from the addition of the optics computation modules. As shown in Figure 3, the PFFIAT configuration of STARS differs in several ways. First, the Hardware Timer was replaced with an Event Timer. While the Hardware Timer waited for the 10 Hz pulses from the Spirent device, the Event Timer suspends the simulation until it receives notification that the Optics computation modules have completed their processing.

The other significant change to the STARS configuration for PFFIAT is the use of the "42" propagator software instead of the GEONS propagator software. The "42" propagator module provides attitude dynamics computations in addition to orbital mechanics, and has higher precision more suitable for the PFFIAT application. After the propagator step, additional steps in STARS were added to run the optics software, which consists of the OSCAR Raytrace, Phase Retrieval, and Optical Feedback software modules.

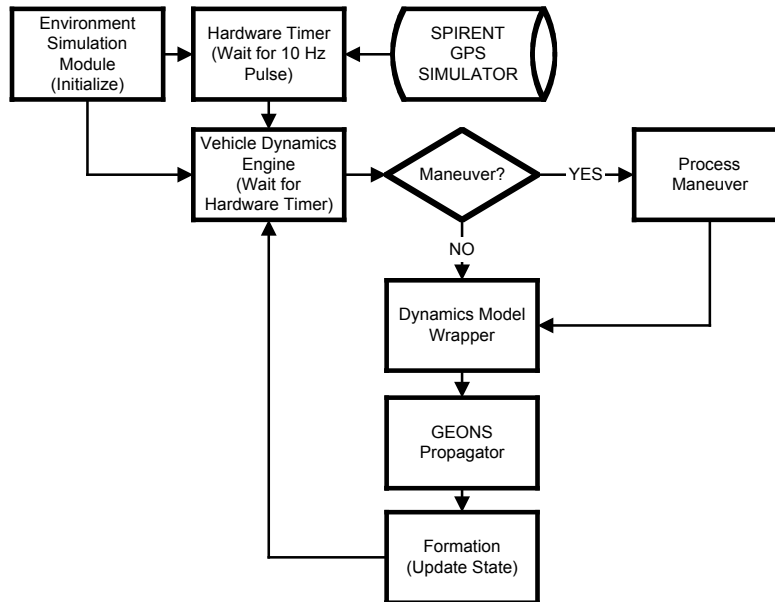

Figure 2. Nominal STARS Configuration

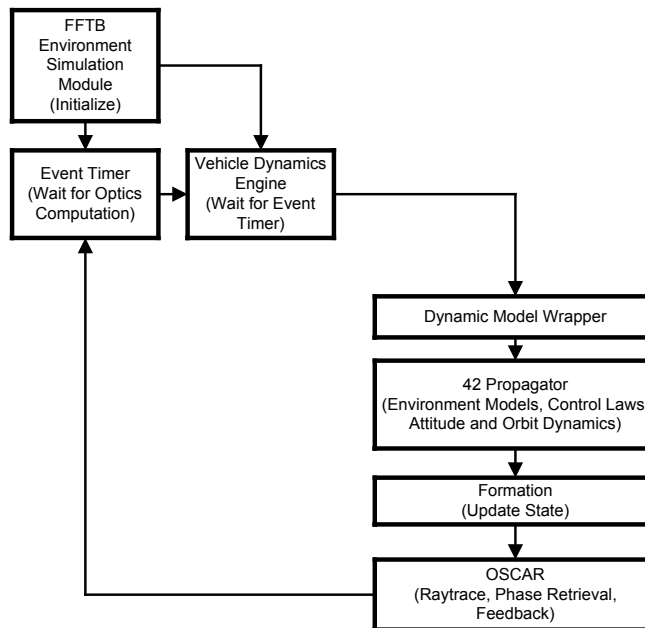

Figure 3. STARS Configured for PFFIAT

III. “42”: A Multi-spacecraft Dynamics Simulation

“42” is a simulation, written in ANSI C, of the attitude and translation dynamics of multiple spacecraft anywhere in the solar system. Spacecraft description data and initial conditions are read in from ASCII input files. The local space environment is determined for each spacecraft, including environmental forces and torques. Sensor models, control laws, and actuator models are provided by the user as C functions. Control forces and torques, along with the environmental forces and torques, are applied as inputs to the

spacecraft dynamical equations. The attitude and orbit of the spacecraft are then propagated forward to the next time step.

Publicly available sources provide algorithms and model coefficients supporting several key simulation elements. Positions of the planets and the Moon are computed using algorithms and coefficients from [Meeus]. For low-Earth orbit, the atmospheric density model is a modified Jacchia model [Jacchia]. The geomagnetic field is modeled using a Legendre polynomial expansion of spherical harmonics [Wertz], with the coefficients taken from the International Geomagnetic Reference Field model [IGRF]. A similar Legendre expansion is used for gravity perturbations due to the non-sphericity of the Earth, using the EGM96 model coefficients up to order and degree 18 [EGM96]. Gravitational perturbations due to other bodies (e.g. the Sun and Moon for a geosynchronous satellite) are computed using the relative positions of the bodies, and assuming them to be point masses.

The spacecraft dynamical models support up to three rigid bodies connected by rotary joints, and up to four internally mounted momentum wheels. Aerodynamic and solar pressure forces and torques are found using spacecraft geometric models, and assuming total absorption of incident momentum. (For solar pressure, a refinement would be to account for specular and diffuse reflection, given the properties for each surface. See, for example, [Agrawal].) Gravity-gradient torque models are widely accessible; we found [Hughes] especially helpful in formulating gravity-gradient forces for multibody spacecraft.

The typical spacecraft control subsystem consists of sensors, control laws, and actuators. For the PFFIAT case study, we assume some idealized sensors and actuators; eventually, evaluating sensors, control laws, and actuators will be a key function of the PFFIAT tool. For the present effort, the objective is to close the control loop with optical image feedback. Thus we assume perfect sensing of attitude, attitude rate, and position. The actuator model is a set of thrusters, force-limited but continuously thrusting and with continuously variable thrust level. The control law is also simple; a proportional-derivative (PD) loop for each attitude and translation degree of freedom, with a pseudo-inverse thruster distribution law.

One of the key challenges for PFFIAT is preservation of precision over large distance scales. Consider a multi-spacecraft optical system deployed at the Sun-Earth L2 point. The image will be sensitive to spacecraft motion within a fraction of a wavelength, on the order of $1\text{E-}9$ meters. On the other hand, the orbit dynamics use distances on astronomical scales; L2 is about $1.5\text{E}+11$ meters from the Sun. This dynamic range of 20 orders of magnitude is greater than the 16 orders of magnitude supported by use of double precision. The remedy is to divide the problem according to scale, ensuring that the dynamics are insensitive to any approximations committed.

To divide the problem according to distance scale, “42” uses an intermediate coordinate system: the formation frame. The origin of the formation frame lies on a reference trajectory which is propagated deterministically (e.g. with fixed Keplerian elements). The relative positions of the centers of mass of the spacecraft with respect to the formation frame origin are propagated in time according to the differential equations of motion. These equations of motion include “external” forces and the differential acceleration due to displacement from the reference trajectory. (This is Encke’s method. See, for example, [Roy] or [Battin].) Assuming the positions of the spacecraft in the formation frame are on the order of $1\text{E}+6$ meters or less, motions of $1\text{E-}9$ meter lie within the dynamic range of a double-precision computer variable. All interaction of spacecraft must use the relative (not heliocentric or geocentric) positions to preserve precision.

Computation of some environmental quantities requires the absolute (helio- or geocentric) position of a spacecraft. For example, the atmospheric density is a function of spacecraft position with respect to the Earth’s center. Adding the spacecraft’s relative position with respect to the formation origin together with the absolute position of the formation origin yields the absolute position of the spacecraft. In this addition, the nanometer-level information is lost due to roundoff. It is assumed, however, that the environmental quantities of interest (geomagnetic field, atmospheric density, solar pressure magnitude, etc.) do not vary appreciably on the sub-millimeter scale, so the roundoff error is acceptable.

Having examined the dynamic range of position, we may ask about the limits of accuracy in representing

attitude. For the kinematic equations of motion, we parameterize attitude as a quaternion. Double precision's accuracy limit of $1E-16$ yields an attitude accuracy limit of about $4E-11$ arcsec. This accuracy is assumed adequate for present purposes.

Another consideration is that of time scale. Spacecraft jitter may be expected to lie in the frequency range above 10 Hz. Orbital motion at L2 operates on the time scale of months. Typical spacecraft control law sample rates are in the 1-10 Hz range, although specialized elements may operate at higher sampling rates if the problem dictates. For the problem of closing the loop around image feedback, the time scale of interest lies in the range of hours or less. For the initial PFFIAT case study we neglect jitter, so the highest frequency of interest is the control law sample rate. Some questions for the future are: What sample rates are required to perform optical feedback? What computational resources are required to perform optical feedback computations in real time? For the present, the simulation "42" performs no sophisticated management of time step. The equations of motion are integrated using a fixed-step fourth-order Runge-Kutta algorithm, with 2-10 integration steps per controller sample.

Attitude and translation equations of motion are decoupled by computing the "external" force resultant and the "internal" resultant torque. The external resultant acts at the mass center of the spacecraft, and affects only the translation degrees of freedom. The internal resultant torque affects only the rotational degrees of freedom.

In addition to solving the distance scale problem, the introduction of the formation frame also greatly simplifies definition of the initial conditions. Each spacecraft's position and attitude are defined with respect to the formation frame, making small perturbations simple to introduce in an intuitive manner. The formation frame may also be re-defined as desired to point at another target, or orbit another planet.

IV. The Optical System Characterization and Analysis Research Software

The Optical Systems Characterization and Analysis Research (OSCAR) Project at NASA Goddard's Earth and Space Data Computing Division (Code 930) applies massively parallel computers, computational techniques and data visualization to solve complex optical, imaging, and data analysis problems. This current, state-of-the-art, system involves a synthesis of Computer Science, Optics, Image Processing, Applied Mathematics, Astronomy, and Earth Science. OSCAR is a comprehensive optical modeling package for modeling optical surfaces, light propagation, and sensor performance. OSCAR has seen use on the Hubble Space Telescope [LYO97], the James Webb Space Telescope [LYO98], the Stellar Imager [CAR04], and the Terrestrial Planet Finder [LYO02]. Specifically, it simulates an optical system with radiometry, diffraction, optical aberrations, scattering, detector sampling, quantization, and noise.

For the purposes of the PFFIAT tool, we make use of OSCAR's scalar raytrace, diffraction, interferometric modeling, and phase retrieval components. OSCAR scalar raytrace coordinates are all global (i.e. expressed in an "optical prescription" frame, which we relate to the formation frame described above) with the exception of specific local coordinate parameters used for decentering and masking the individual optical elements. These optical elements are mounted onto spacecraft which may move about with respect to the formation frame, so it is necessary to define their positions with respect to their host spacecraft. The raytrace produces a FITS graphic file containing the image intensity over the image plane. OSCAR's phase retrieval component uses the Misell algorithm to calculate the phase, or wavefront error, from the image. The wavefront error is then used to derive control feedback signals. In the future, PFFIAT scenarios will include deformation of optical surfaces on a spacecraft as well as the optical effects of spacecraft rigid-body motion. For the present, rigid-body motion is sufficient to serve PFFIAT's purpose.

V. The PFFIAT Loop

PFFIAT's objective is to integrate multi-spacecraft dynamics and control along with optical raytrace analysis in a single simulation, for use as a research and validation tool by a wide range of missions. We have described the building blocks. Now we describe the interaction between them.

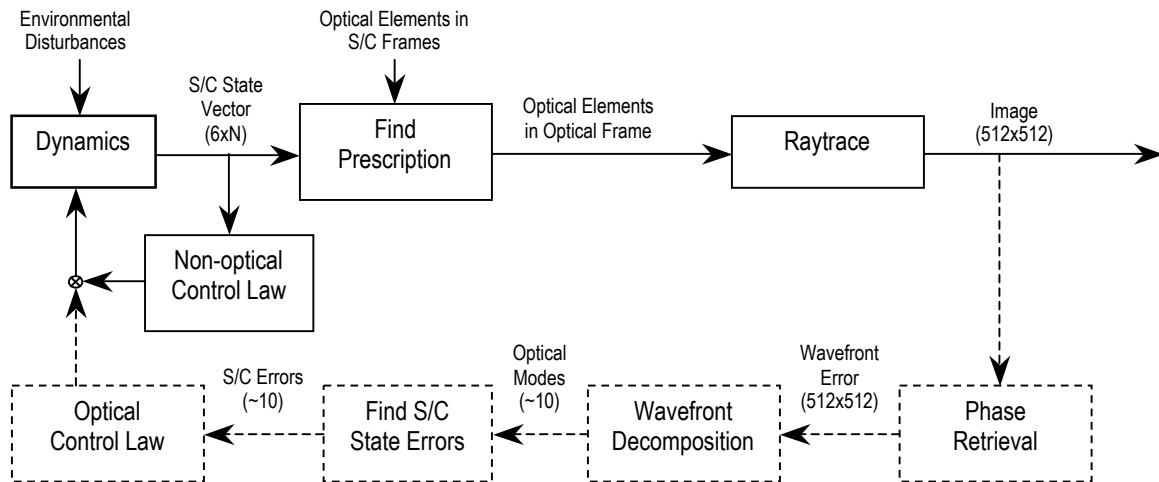

Figure 4. The PFFIAT Loop Block Diagram

The PFFIAT loop is shown in figure 4. Solid boxes show the current architecture. Dashed boxes show the planned optical feedback loop.

The “forward” leg of the loop is simple enough in concept: given the dynamic state of the spacecraft in formation, and the relationships between the spacecraft and the elements of the optical system, solve for the image. Implementation of this leg has been primarily a software development effort: defining the spacecraft formation in a convenient fashion, associating optical elements with spacecraft bodies, and translating spacecraft dynamic states into forms expected by OSCAR.

The “reverse” leg of the loop is equally simple to state: given the image, solve for the errors in the spacecraft dynamic states. This leg requires more algorithmic development, however, and is currently a work in progress. Here is an outline of the planned steps:

The raytrace portion of OSCAR gives the image, expressed as an array (512x512 for PFFIAT) of intensities. This is what a CCD detector array would yield. The first step is to reconstruct the wavefront error from the intensities. For the PFFIAT case study, we use the Misell algorithm, which uses several defocused images to resolve phase ambiguities. The result of this phase retrieval step is an array (512x512) of wavefront error.

The second step is wavefront decomposition onto basis functions, yielding amplitudes of the optical modes present in the wavefront. For PFFIAT, we use Zernike polynomials [NOL76] as our basis functions. This step reduces the 512x512 array to a manageable (say, 10) set of signals for spacecraft state feedback.

The third step is to map the optical mode amplitudes onto spacecraft state errors. This is done by least-squares projection, using the pseudo-inverse of the measurement matrix. The measurement matrix is the Jacobian matrix, found *a priori* by perturbing each spacecraft state in isolation and solving for the sensitivity of each optical mode to that perturbation. The projection of optical modes onto spacecraft states is then a straightforward matrix multiplication, yielding spacecraft state error vectors.

Some dynamical modes of the formation will not be observable in the optical image. In general, at least four of the six “rigid body” modes of the formation (i.e. the three translations of the entire formation as if it were a rigid body, and the rotation of the formation about its boresight axis) will be unobservable in the image. In the PFFIAT case study configuration, we note that symmetrically increasing the transverse separation between the mirrorsats will also be unobservable in the image; this is due to the optical design which does not relay a scaled version of the pupil to beam combiner spacecraft. Note that optical designs which preserve the pupil geometry are possible. We expect that the process of finding the measurement

matrix will determine which dynamical modes are observable. The unobservable modes will then be controlled by other means, such as star trackers and inter-spacecraft ranging sensors. Since these modes are unobservable in the image, the accuracy requirements on those degrees of freedom are expected to be significantly less stringent.

VI. Case Study: A Fizeau Interferometer Composed of Three Spacecraft

To develop and demonstrate the PFFIAT software, we consider a notional multi-spacecraft optical system. The formation consists of three spacecraft: two mirrorsats whose aperture centers are spaced 10 m apart, and which redirect and compress the incoming light from 1-m diameter beams to 10-cm diameter beams. These beams then travel to the collector spacecraft, where they are focused onto an image plane, forming an interference pattern.

Figure 5 presents a screenshot from a PFFIAT simulation, showing the interferometer formation near the Sun-Earth L2 libration point. For illustration, the mirrorsats in this view have been placed with a 20-m baseline between their entrance apertures. For the optical analysis to follow, a 10-m baseline is used.

Figure 6 shows the optical train; light from the source is incident from the top on two separate spacecraft, each consisting of a flat and an afocal telescopic beam compressor. The first fold mirror and the two parabolic mirrors are fixed with respect to each other in a given mirrorsat. The beam combiner spacecraft consists of a fold flat, one per beam, a single parabolic focussing mirror and a focal plane detector where the beams are mixed. These optics are also mounted and fixed within the beam combiner spacecraft.

Figures 7-10 show several representative images modeled using the OSCAR software. Figure 7 shows the nominal image, with no errors in spacecraft attitude or translation. The central (Airy) disk, due to the primary beam from each collector spacecraft, and surrounding rings are the well-known diffraction pattern formed by imaging a point source. The fine vertical striations are interference patterns due to the sparse aperture mixing of the beams. The spacing of the Airy rings is inversely proportional to the size of a single aperture (1 meter), and the spacing of the fine structure is inversely proportional to the baseline between the apertures (10 meters). The “plaid” background is a computational artifact caused by a sparsity of rays in the raytrace. The raytrace software generates a mesh of rays over the entrance aperture of the optical system. This system, however, is unusually sparse; consequently, only a small fraction of the generated rays traverse the entire system to generate the image. Ongoing work will improve on this behavior by referencing the raytrace to the image plane rather than to the entrance aperture. Thus, all the generated rays will contribute to the image.

Perturbing the attitude of one mirrorsat produces primary coma due to the parabolas seeing an off-axis beam, as seen in figure 8. A translation of one mirrorsat produces an oval image, as seen in figure 9, due to beam walk creating partial vignetting.

Figures 10(a)-10(d) demonstrate the effect of spacecraft dynamics on the optical image. A simulation is begun with an initial attitude error in one mirrorsat. All spacecraft, under idealized non-optical control, generate control forces and torques to correct the initial errors and attain the commanded position and attitude with respect to the formation. As the simulation progresses, the optical raytrace is executed to find the image. We see here the image, taken at one-minute intervals, approach the nominal image (see figure 7) from its initial perturbed state.

VII. Conclusion

PFFIAT combines high-precision simulation of spacecraft attitude and translational dynamics with sophisticated optical analysis tools. This combined capability enables study of the interaction of the optical and control systems for large-aperture telescope systems composed of a formation of spacecraft. This simulation tool will enable the development and validation of image-based closed-loop control architectures. It will be instrumental in deriving computational requirements, sensor and actuator

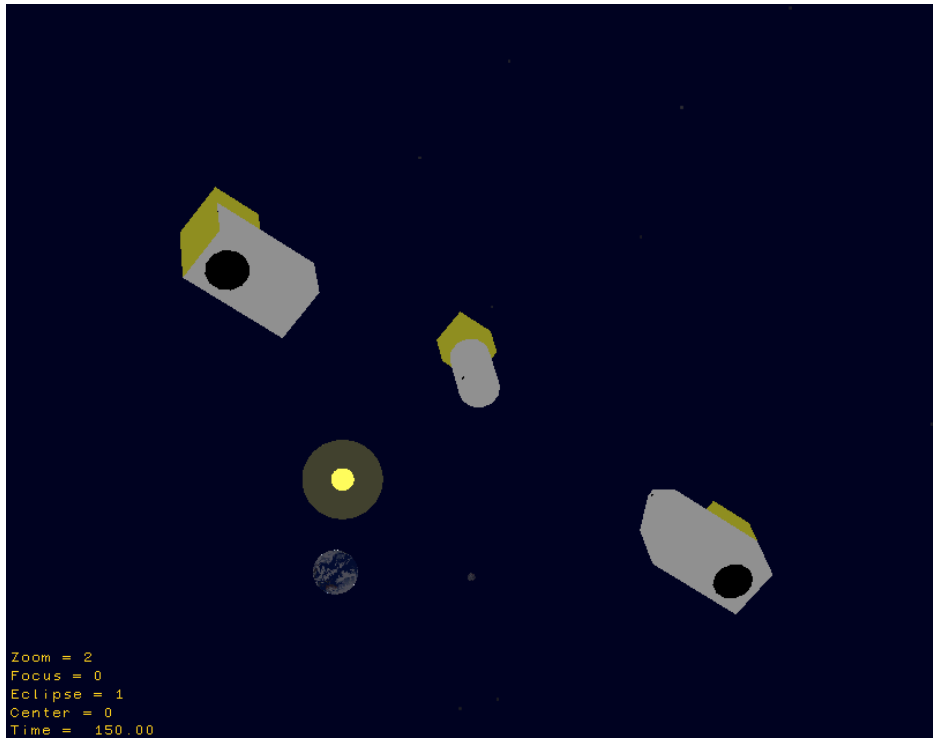

Figure 5. PFFIAT Formation Screenshot

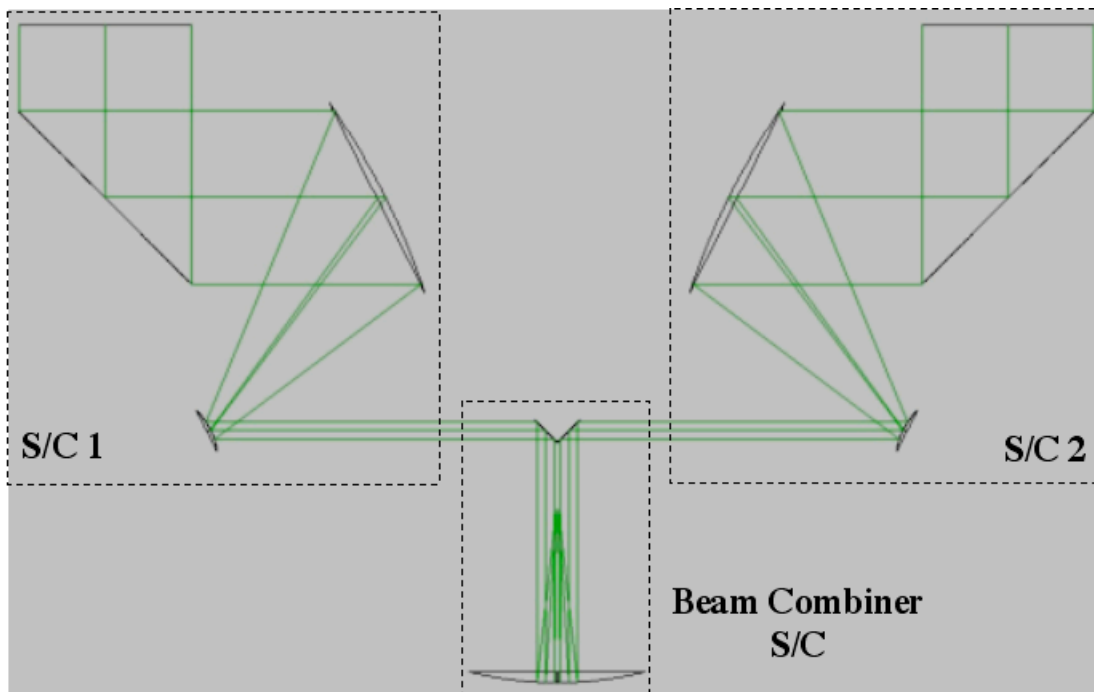

Figure 6. PFFIAT Nominal Optical Layout

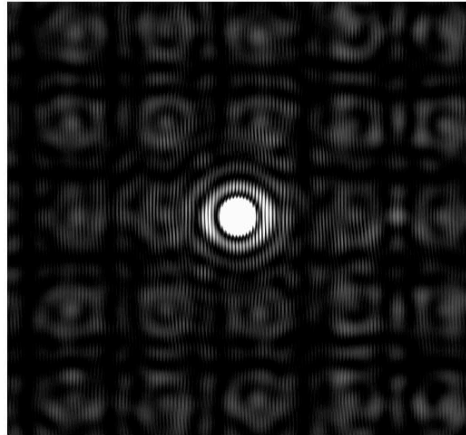

Figure 7. Nominal Image, No Spacecraft Attitude or Translation Errors

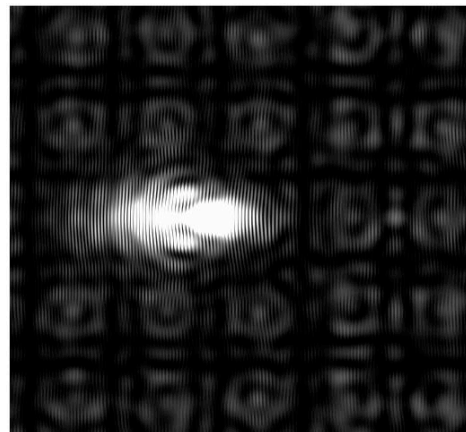

Figure 8. Perturbed Image, One Mirrorsat Tilted 0.25 deg

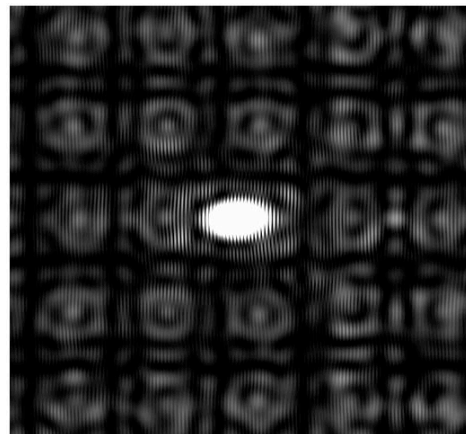

Figure 9. Perturbed Image, One Mirrorsat Displaced 0.05 m

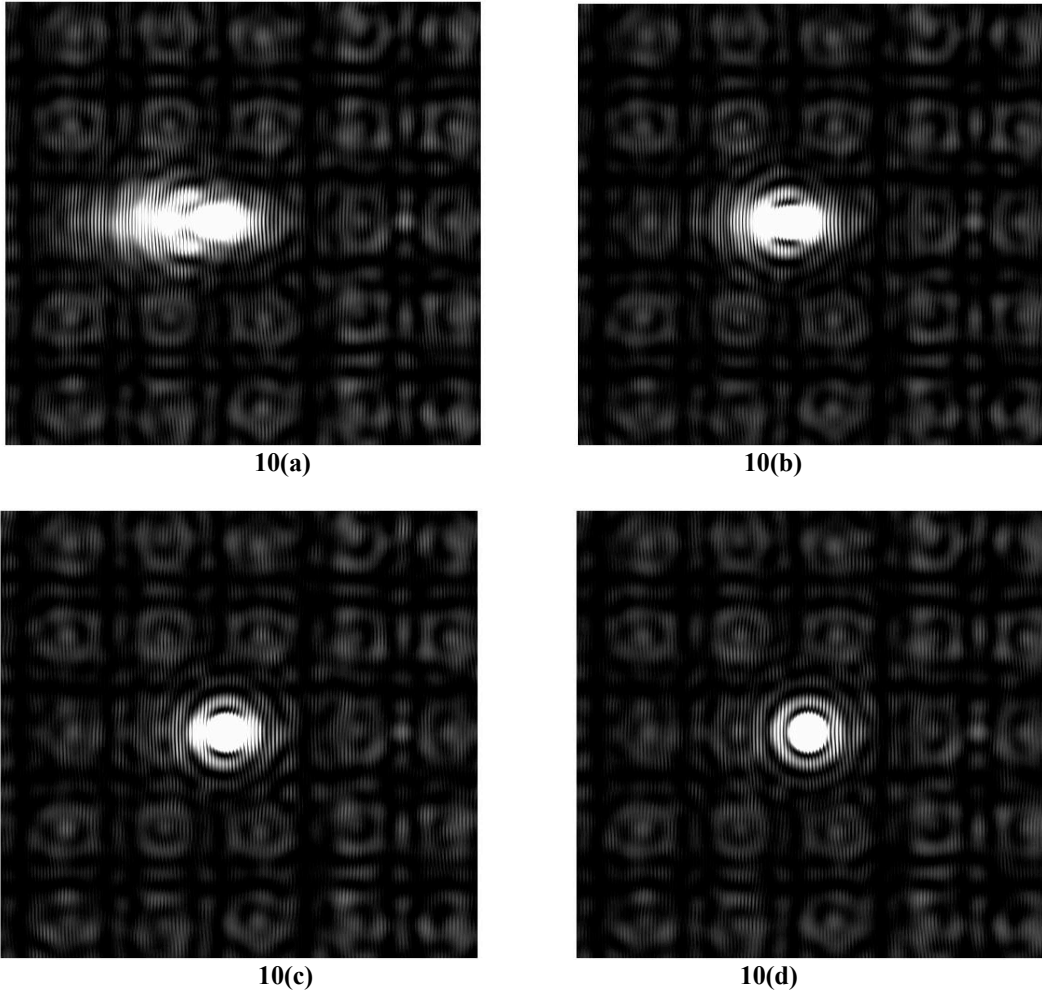

Figure 10. Sequence of Images as Initial Errors are Corrected

requirements, and in performance evaluation.

Use of the image for control feedback is motivated by the very stringent attitude and translation requirements expected for a multi-spacecraft telescope system. Image feedback, however, cannot provide control signals for all of the dynamical degrees of freedom, as some dynamical modes are unobservable in the image. Other (“coarse”) sensors, such as star trackers and relative position sensors, will be needed to control these modes of the formation. Since these modes are, to first order, unobservable in the image, the corresponding attitude and translation requirements should be less stringent. They may still be a challenge for existing sensor technology. In addition to this technology challenge, there are also the algorithms needed to operate a formation of spacecraft from a “lost in space” initial condition to handoff to the optical control system. PFFIAT will enable study of these problems as well.

This paper has presented the status of PFFIAT, including demonstration of optical response to spacecraft motion in a simple multi-spacecraft optical system. We have also discussed ongoing work to close the spacecraft control loop around feedback of the optical image. The tool is useful now for study of some questions, such as coarse acquisition algorithm and sensor definition. It will reach its full capability upon demonstration of closed-loop control through optical feedback. At that point, PFFIAT will be ready to be adapted as needed for a broad range of mission studies, from initial concept studies to the detailed simulations typical of a flight project.

VIII. References

- [Agrawal] Agrawal, Brij N. Design of Geosynchronous Spacecraft. Prentice-Hall, 1986.
- [Battin] Battin, Richard H. An Introduction to the Mathematics and Methods of Astrodynamics. AIAA Education Series, 1987.
- [CAR04] K. Carpenter, W. Danchi, J. Leitner, A. Liu, R. G. Lyon, L. Mazzuca, R. Moe, D. Chenette, K. Schrijver, S. Kilston, M. Karovska, R. Allen, A. Brown, J. Marzouk, N. Murphy, F. Walter, The Stellar Imager (SI) Vision Mission, The American Astronomical Society 204th Meeting, Denver Colorado, May 30 – June 3, 2004.
- [EGM96] <http://cddisa.gsfc.nasa.gov/926/egm96/egm96.html>
- [GEONS] <http://geons.gsfc.nasa.gov/>
- [Haas] Haas L, et al, "The Ashtech G12-HDMA: A Low Cost, High Performance GPS Space Receiver," ION GPS 200 Conference, 2000.
- [Hughes] Hughes, Peter C. Spacecraft Attitude Dynamics. Wiley & Sons, 1986.
- [IGRF] <http://nssdc.gsfc.nasa.gov/space/model/magnetos/igrf.html>
- [Jacchia] "Models of Earth's Atmosphere", NASA SP-8021, May 1969.
- [LYO97] Lyon, R. G., Dorband, J. E., Hollis, J. M., Hubble Space Telescope Faint Object Camera Calculated Point Spread Functions, Applied Optics, 36, No. 8, 1997.
- [LYO98] R. Lyon, J. M. Hollis, J. Dorband, J., T. Murphy, Extrapolating HST Lessons to NGST, Optics and Photonics News, Vol. 9, No. 7, 1998.
- [LYO02] R. G. Lyon, J. M. Hollis, J. E. Dorband, Comparative Optical Analysis of Extra-Solar Planetary Imaging Techniques, SPIE Astronomical Telescopes and Instrumentation, 22-28 August 2002, Waikoloa, Hawaii, USA
- [Meeus] Meeus, Jean. Astronomical Algorithms. Willman-Bell, Richmond, VA, 1998.
- [Montenbruck] Montenbruck O, et al. "A Real-Time Kinematic GPS Sensor for Spacecraft Relative Navigation," Aerospace Science and Technology, Vol. 6, 435-449, 2002.
- [NOL76] Noll, R. J., Zernike Polynomials and Atmospheric Turbulance, J. Opt. Soc. Am.. Vol. 66, No. 3, March 1976.
- [Roy] Roy, A. E. Orbital Motion. Adam Hilger, Ltd, Bristol, 1982.
- [Wennersten] Wennersten M, et al, "PiVoT GPS Receiver," ION GPS 2001 Conference, 2001.
- [Wertz] Wertz, James R., Ed. Spacecraft Attitude Determination and Control. Microcosm Inc., Torrance, CA, 1978.