

**HIGH TEMPERATURE METALLIC SEAL DEVELOPMENT FOR AERO  
PROPULSION AND GAS TURBINE APPLICATIONS**

Greg More  
Parker Hannifin  
North Haven, Connecticut

Amit Datta  
Advanced Components & Materials  
East Greenwich, Rhode Island

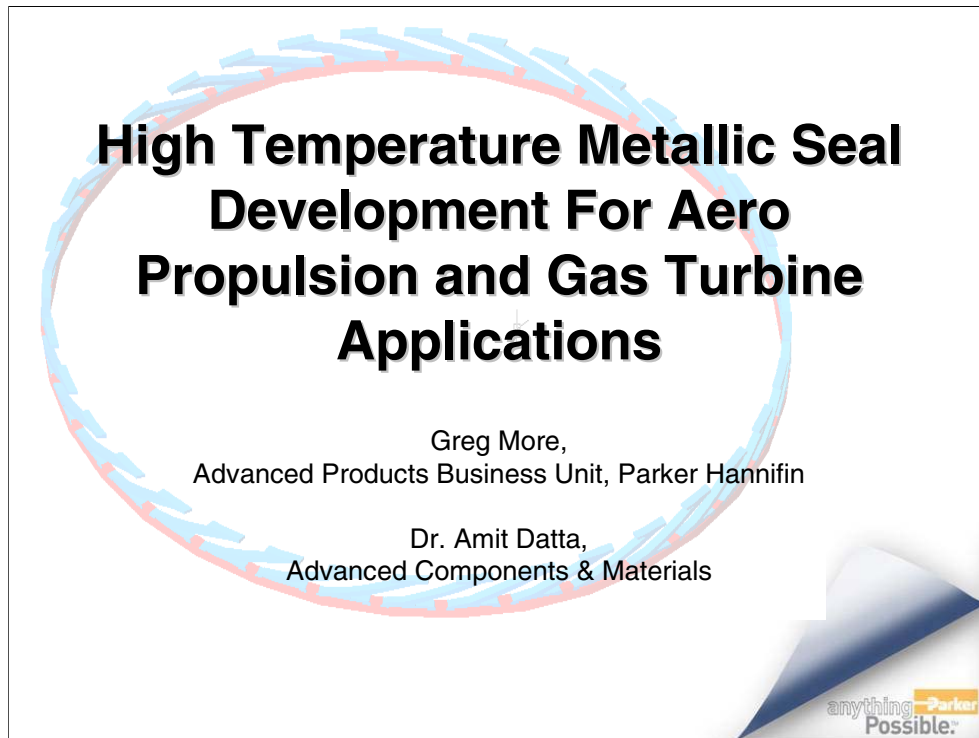

# High Temperature Static Seal Development

- Industry Requirements – Industry is requiring seals to operate at higher and higher temperatures.
  - Greater efficiency
  - Reduced cooling air requirements
- Seal Problem – Traditional seal designs and materials experience stress relaxation. Over time seals loose their ability to maintain contact with moving flanges.
- Solution – High temperature seal development program
  - Multiphase program with incremental increases in seal operating temperatures

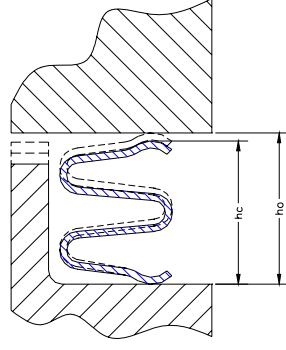

Seal gap is created resulting from stress relaxation at elevated temperatures. The original seal height  $h_0$  is reduced to  $h_c$  creating a gap when the flange moves away from the compressed condition.



# Program Review

High temperature seal development program review

Phase I : Improved traditional sheet metal seal design and analysis

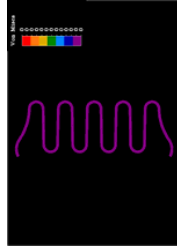

Phase III :Thermally insulated seals

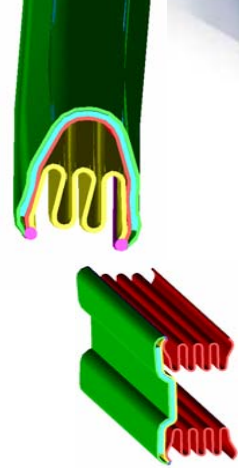

Phase II : Higher temperature sheet metal materials and improved thermal processing

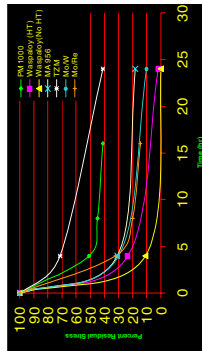

Phase IV : High temperature single crystal material spring element



anything **Parker** Possible.™



# Phase IV : Innovative Seal with Blade Alloy Spring

- In order to achieve next temperature range a different, non-traditional sealing, methodology is utilized
- Utilize a high temperature spring material that is currently used, well known, and has good operating experience in the Gas Turbine industry
- Outer jacket performs sealing function
  - Thin cold formable alloy jacket provides a continuous sealing surface
- Inner spring provides high temperature load and elastic recovery
  - Cast blade alloy spring energizer for operation up to 1800 °F
- Patent pending spring assembly design

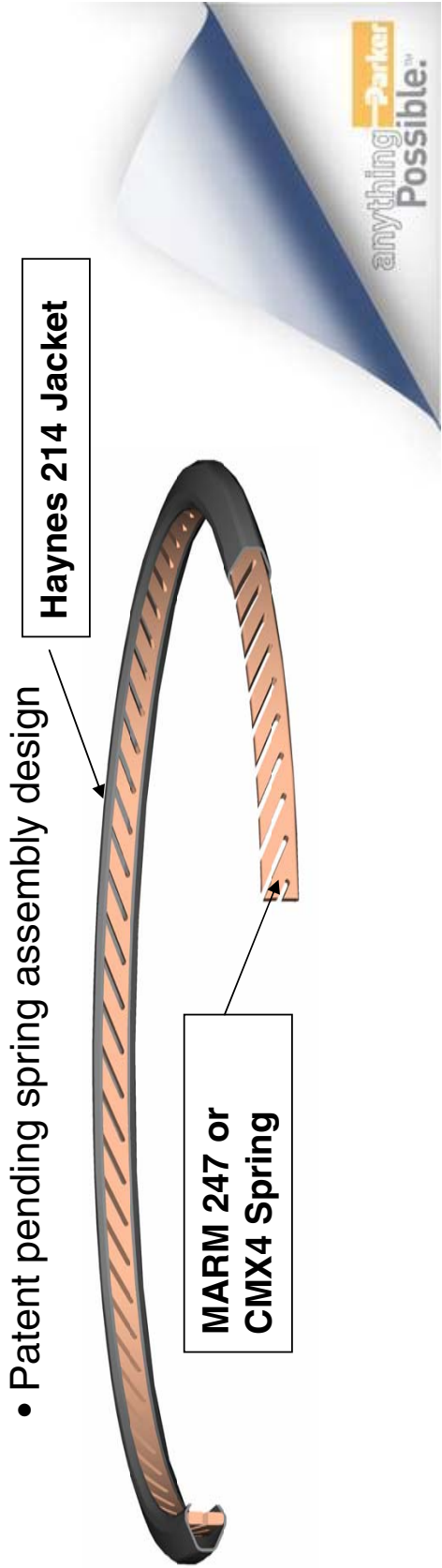

# Phase IV : Innovative Seal with Blade Alloy Spring

Cast Blade alloys have extremely high strength

Alloy	Temperature,° F	Yield Strength,ksi	Elongation,%
MARM 247, poly crystal	1400	130	12
CMX4, Single crystal	1600	114	18
INCO 718,poly crystal	1472	100	10
Waspaloy,poly crystal	1600	75	35

- Blade alloys also have superior creep and stress rupture strength compared to cold formable superalloys. Hence, blade alloys have higher resistance to stress relaxation.
- Manufacturing Challenge - Blade alloys are only available in the cast condition ( poly or single crystal )



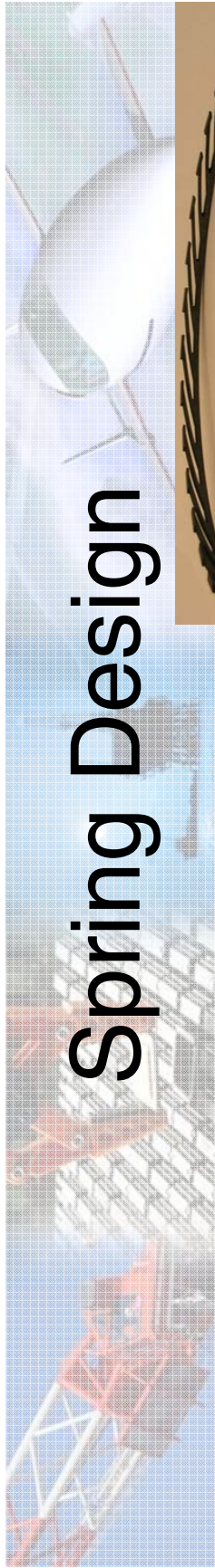

# Spring Design



- **Prototype I**
  - Solid ring machined from a single casting
  - Basic finger design, not optimized with FEA
  - Opportunities for design and manufacturability enhancements
- **Prototype II**
  - Independent finger and support ring configuration
    - Improved DFM and lower manufacturing cost
    - Fine tune spring load and seal load
      - Adjust number of the number of fingers
  - FEA optimized finger configuration
  - Significantly improved stress relaxation characteristics

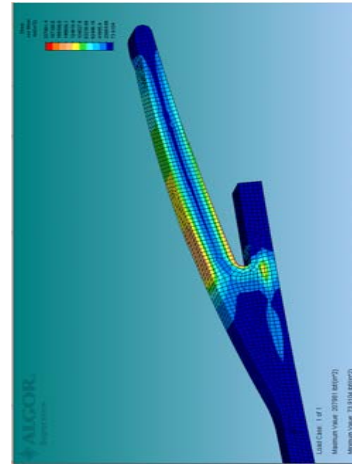
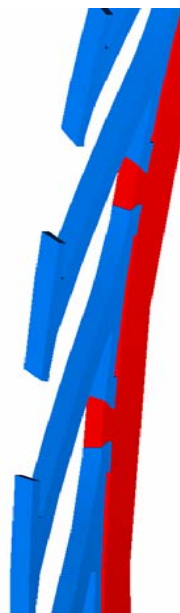
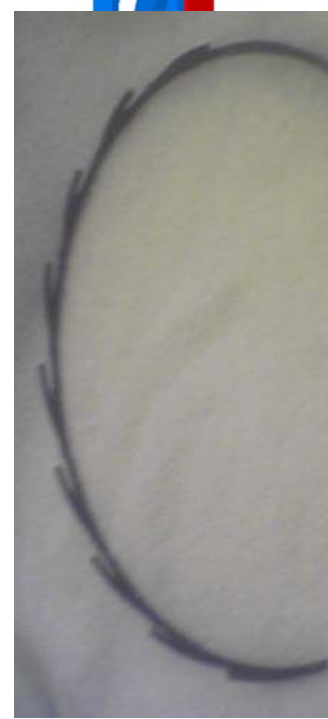

# Phase IV : Innovative Seal with Blade Alloy Spring

Cross Sectional comparison of high temperature sealing designs

## High temperature modular seal

- Standard E-Seal with blade alloy spring



Traditional E-Seal produced from high temperature Waspaloy alloy

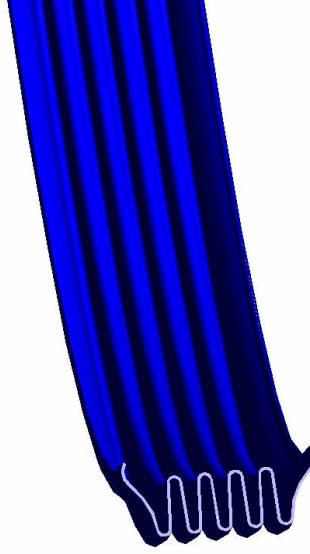



# Phase IV : Innovative Seal with Blade Alloy Spring



Performance testing experimental procedure:

- Stress relaxation
  1. Seals were compressed 12% between flanges and heated to 1600 °F for specified time periods
  2. After each exposure, seals were cooled to room temperature to measure change in seal free height
  3. Change in seal free height is then used to calculate usable seal springback
- Leakage testing
  - Identical to steps 1 – 3 above and seals were room temperature leakage tested as step 4

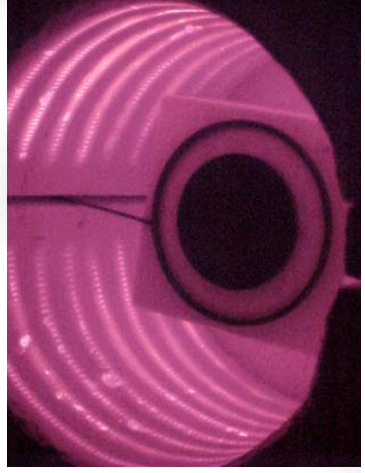
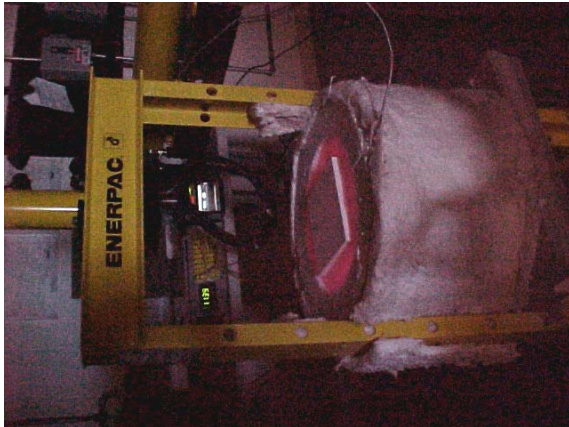



# Phase IV : Testing Results

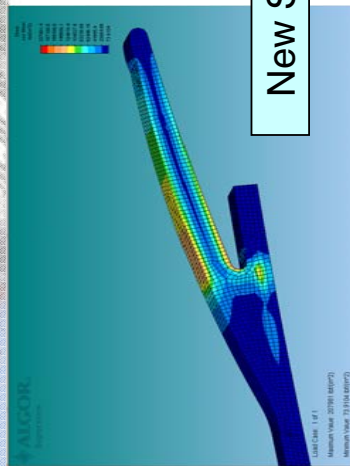

Percent Spring Back vs Hrs @ 1600 °F

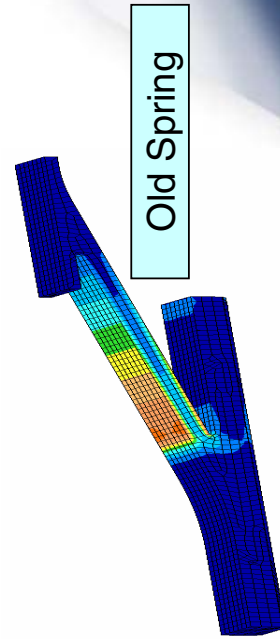
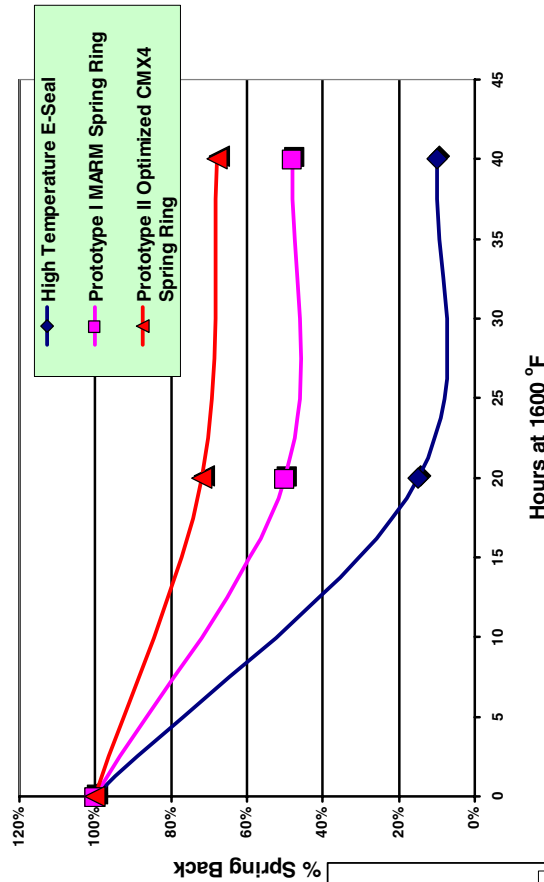

anything **Parker** Possible.™

Total Leakage vs Hours @ 1600 °F

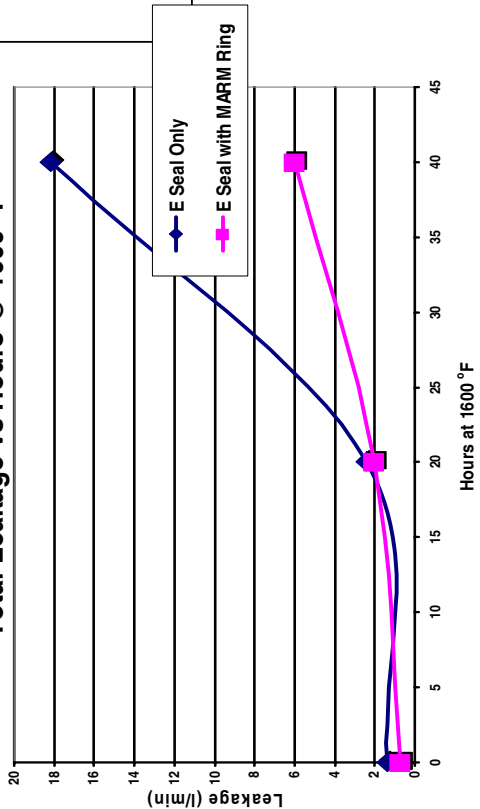

# Seal Seating Load

- An important design feature of the modular manufacturing process is seal seating load tune-ability
  - Seal seating load can be adjusted
  - This combination yield a seal seating load of 19 lb/inch of seal circumference
    - Comparable with a traditional E-Ring type seating load
  - Other loading levels could be selected based on hardware and desired leakage rate
- As can be seen from the load vs deflection curve, the FEA optimization worked well and resulted in a large elastic operating range

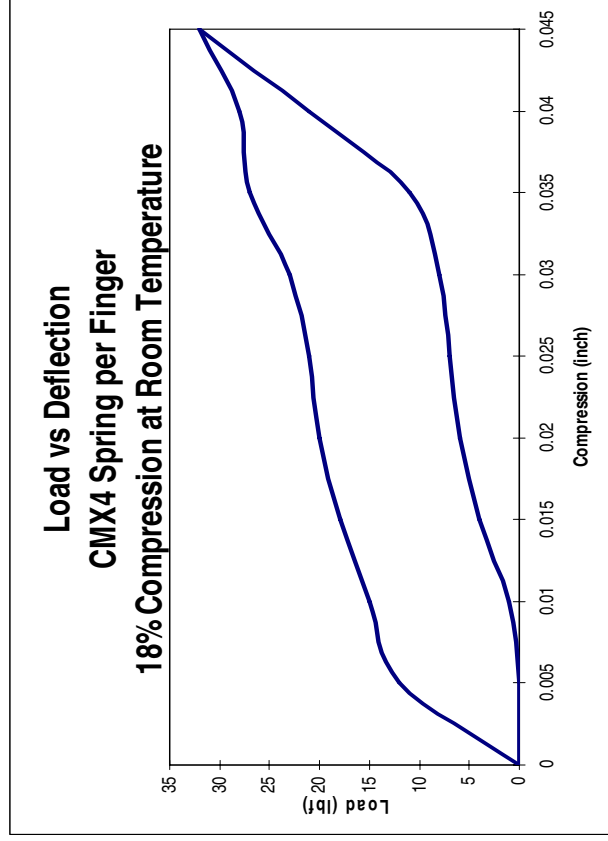

# Spring Seal Manufacturing

- Thought and effort has been applied to reduce manufacturing costs and lead times
- Modular manufacturing approach
- Seal outer sheet metal jacket
  - Standard E or U type seal cross section
  - No special tooling or processing are required
- Inner spring
  - Single crystal spring finger can be investment cast in near net shape
  - Spring finger geometry will be fixed independent of seal diameter
    - Spring fingers can be held in inventory for a fast seal manufacturing process
    - Retaining ring diameter will set spring assembly diameter
  - Spring material is readily available and is currently widely used and accepted
  - Retaining ring will be machined from a lower cost alloy
    - Stresses within retaining ring are comparably low, therefore commonly used superalloys such as Inconel 718 can be used
  - Spring fingers can be easily joined (welded or brazed) to the spring ring
  - Number of fingers will govern overall seal seating load
- Patent pending manufacturing and processing approach

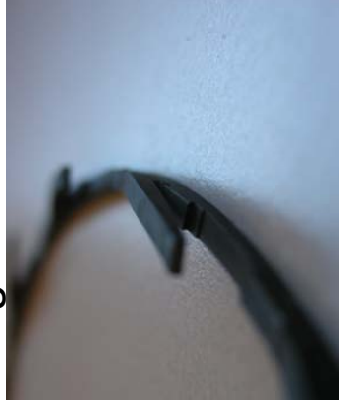



# Other Applications for High Temperature Spring Design

Transition fastener between metal and ceramic components with a large  $\alpha$ -mismatch

Combustor CMC liner— low load, large deflection spring at 1800F

High Temperature Annular Spring

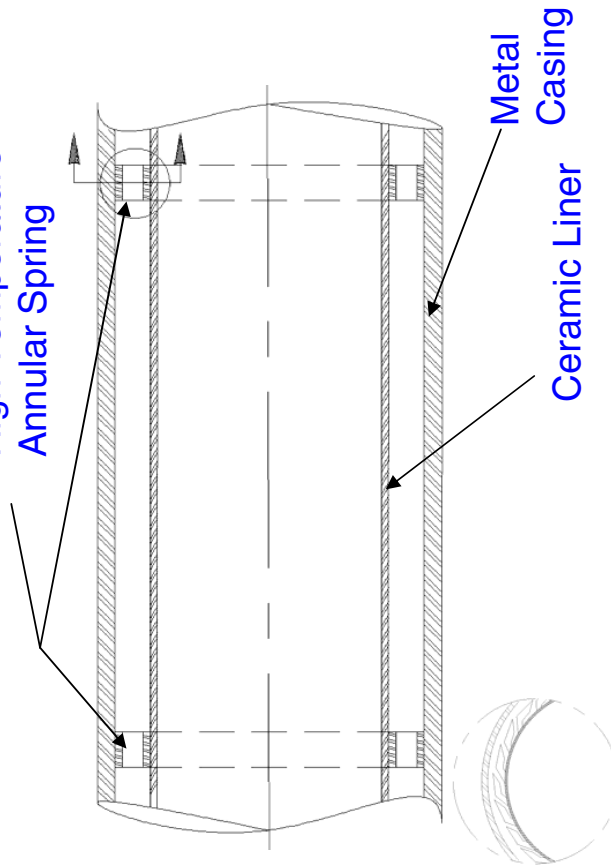

Low-load/ high deflection spring energizer for extremely high temperature (>2000F) ceramic sliding seal

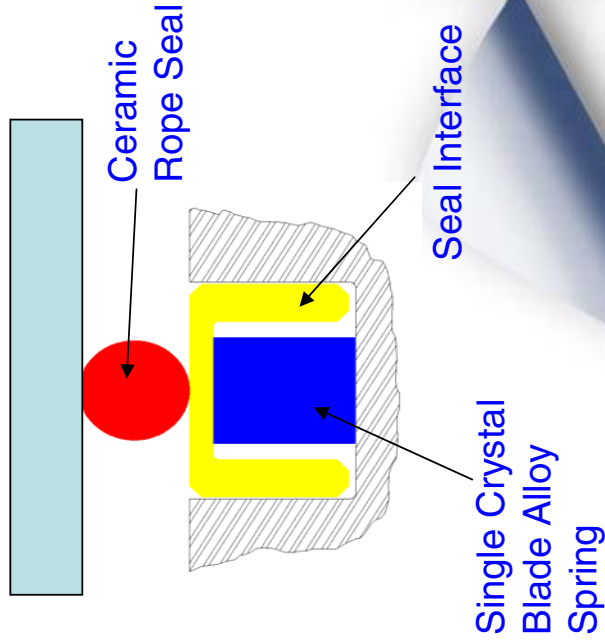

anything **Parker** Possible.™

# Conclusions

- The Ultra High Temperature seal program has successfully progressed and developed industry accepted high temperature static seal solutions
- The next phase of higher operating temperature seals is progressing well
  - First prototype showed very promising results
  - Second prototype proved further enhancements were possible
    - Modular design can be used to create a cost effective and rapid turn around solution
    - Seal seating load can be adjusted to match the desired application
    - Additional stress relaxation resistance was available through spring optimization
- Future activities
  - Stress relaxation testing at 1600 °F shows good usable performance, next phase will be to perform testing at 1700 °F and 1800 °F
  - Slight further optimization of the spring fingers and manufacturing of cast fingers preparing for full product launch

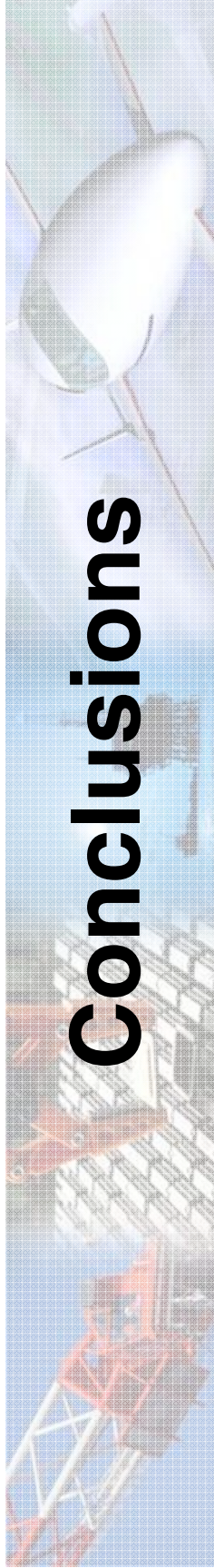



# Questions ?

